

# Welding processes handbook

# Welding processes handbook

Klas Weman



**CRC Press**  
**Boca Raton Boston New York Washington, DC**

**WOODHEAD PUBLISHING LIMITED**  
Cambridge, England

Published by Woodhead Publishing Ltd, Abington Hall, Abington  
Cambridge CB1 6AH, England  
[www.woodhead-publishing.com](http://www.woodhead-publishing.com)

Published in North America by CRC Press LLC, 2000 Corporate Blvd, NW  
Boca Raton FL 33431, USA

First published 2003, Woodhead Publishing Ltd and CRC Press LLC

© 2003, Woodhead Publishing Ltd  
The author has asserted his moral rights.

This book contains information obtained from authentic and highly regarded sources. Reprinted material is quoted with permission, and sources are indicated. Reasonable efforts have been made to publish reliable data and information, but the author and the publishers cannot assume responsibility for the validity of all materials. Neither the author nor the publishers, nor anyone else associated with this publication, shall be liable for any loss, damage or liability directly or indirectly caused or alleged to be caused by this book.

Neither this book nor any part may be reproduced or transmitted in any form or by any means, electronic or mechanical, including photocopying, microfilming and recording, or by any information storage or retrieval system, without permission in writing from the publishers.

The consent of Woodhead Publishing and CRC Press does not extend to copying for general distribution, for promotion, for creating new works, or for resale. Specific permission must be obtained in writing from Woodhead Publishing or CRC Press for such copying.

Trademark notice: Product or corporate names may be trademarks or registered trademarks, and are used only for identification and explanation, without intent to infringe.

British Library Cataloguing in Publication Data  
A catalogue record for this book is available from the British Library.

Library of Congress Cataloging in Publication Data  
A catalog record for this book is available from the Library of Congress.

Woodhead Publishing ISBN 1 85573 689 6  
CRC Press ISBN 0-8493-1773-8  
CRC Press order number: WP1773

Printed by TJ International, Padstow, Cornwall

# Contents

Preface .....	ix
<b>1 ARC WELDING _ AN OVERVIEW .....</b>	<b>1</b>
History of welding.....	1
Terminology .....	3
Distortion .....	7
The welding arc .....	8
Shielding gases .....	12
Power sources .....	13
<b>2 GAS WELDING .....</b>	<b>26</b>
Equipment .....	26
<b>3 TIG WELDING .....</b>	<b>31</b>
A description of the method .....	31
Equipment .....	31
Consumables .....	35
<b>4 PLASMA WELDING .....</b>	<b>37</b>
A description of the method .....	37
Equipment .....	39
Gases for plasma welding .....	40
The advantages of the plasma method .....	40
<b>5 MIGIMAG WELDING .....</b>	<b>41</b>
Equipment .....	41
Setting of welding parameters .....	44
Consumables .....	47
Weld quality .....	60
<b>6 METAL ARC WELDING WITH COATED ELECTRODES .....</b>	<b>63</b>
Description of the method .....	63
Equipment .....	63
Electrodes .....	64
Weld defects .....	67
<b>7 SUBMERGED ARC WELDING .....</b>	<b>68</b>
Description .....	68
Equipment .....	69
Filler material .....	71
The effect of the welding parameters .....	73
Productivity improvements .....	75
Joint preparation .....	77
Risks of weld defects .....	77



<b>8</b>	<b>PRESSURE WELDING METHODS .....</b>	<b>80</b>
	Resistance welding .....	80
	Friction welding .....	86
	High-frequency welding .....	89
	Ultrasonic welding .....	89
	Explosion welding .....	90
	Magnetic pulse welding .....	91
	Cold pressure welding .....	92
	Diffusion welding .....	92
<b>9</b>	<b>OTHER METHODS OF WELDING .....</b>	<b>93</b>
	Electroslag welding .....	93
	Electrogas welding .....	94
	Stud welding .....	94
	Laser welding .....	95
	Electron beam welding .....	99
	Thermite welding .....	101
<b>10</b>	<b>CUTTING METHODS .....</b>	<b>102</b>
	Thermal cutting .....	102
	Water jet cutting .....	105
	Thermal gouging .....	106
<b>11</b>	<b>SURFACE CLADDING METHODS .....</b>	<b>108</b>
	Cladding to provide a corrosion-resistant layer .....	108
	Hardfacing .....	108
	Thermal spraying .....	110
<b>12</b>	<b>MECHANISATION AND ROBOT WELDING .....</b>	<b>114</b>
	Narrow-gap welding .....	114
	Arc welding using robots .....	116
	Mechanised TIG welding .....	120
	Quality requirements for mechanised welding .....	122
<b>13</b>	<b>SOLDERING AND BRAZING .....</b>	<b>124</b>
	General .....	124
	Soft soldering .....	127
	Brazing .....	129
<b>14</b>	<b>THE WELDABILITY OF STEEL .....</b>	<b>132</b>
	Carbon steels .....	132
	High-strength and extra high-strength steels .....	136
	Austenitic steels .....	139
<b>15</b>	<b>DESIGN OF WELDED COMPONENTS .....</b>	<b>148</b>
	Introduction .....	148
	Symbolic representation of welds on drawings .....	148
	Welding classes .....	151
	Residual stresses in welds. weld distortions .....	152

	Design consideration.....	153
	Strength considerations of welded joints.....	163
	Analysis of statically loaded welded joints.....	163
	Welded structures subjected to fatigue loads.....	166
	References.....	170
<b>16</b>	<b>QUALITY ASSURANCE AND QUALITY MANAGEMENT .....</b>	<b>171</b>
	Quality requirements for welding (EN 729) .....	172
	Welding coordination (EN 719) .....	173
	Specification and approval of welding procedures (EN 288).....	175
	Approval testing of welders (EN 287) .....	180
	Non-destructive testing .....	182
<b>17</b>	<b>WELDING COSTS .....</b>	<b>184</b>
	Welding cost calculations.....	184
	Some welding cost concepts.....	184
	Cost calculation .....	186
	Mechanisation. automation. robot welding.....	189

# Preface

Production of this guide to welding was prompted originally by a wish for an up-to-date reference on applications in the field. The content has been chosen so that it can be used as a textbook for European welding courses in accordance with guidelines from the European Welding Federation. Over the last few years, an equivalent Swedish guide has been used for courses on welding processes and equipment. The author hopes that this guide will serve as a useful reference book for those involved in welding.

In writing the book, there has been a conscious effort to ensure that both text and illustrative material is clear, concentrating particularly on interesting and important aspects.

Although the book has been written in Sweden, with input from Swedish experts, it reflects technology and methods that are internationally accepted and used. My thanks are due to all those who have been involved in the work, with particular mention to:

*Claes Olsson*, HighTech Engineering, who wrote the chapter on design of welded components.

*Clues-Ove Pettersson*, Sandvik, who edited the section on stainless steel.

*Curt Johansson*, SAQ, who wrote the chapter on quality management.

*Gunnar Lindén*, Air Liquide, who edited the chapter on welding costs.

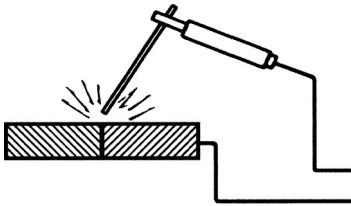
Klas Weman

# 1 Arc welding – an overview

## 1.1 History of welding

Methods for joining metals have been known for thousands of years, but for most of this period the only form of welding was forge welding by a blacksmith.

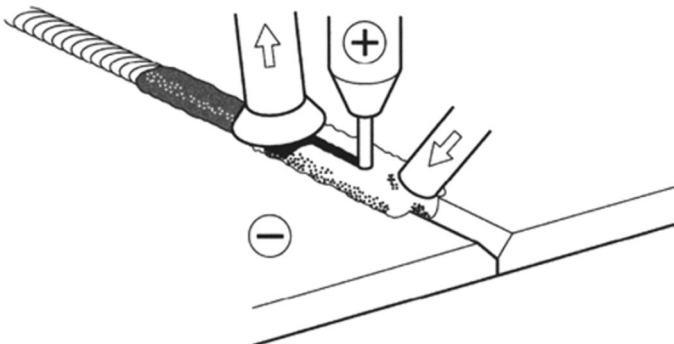
A number of totally new welding principles emerged at the end of 19th century; sufficient electrical current could then be generated for *resistance welding* and *arc welding*. Arc welding was initially carried out using carbon electrodes, developed by Bernados, and was shortly followed by the use of steel rods. The Swede Oskar **Kjellberg** made an important advance when he developed and patented the coated electrode. The welding result was amazing and formed the foundation of the ESAB welding company.



*Figure 1.1 Principle of Manual Metal Arc (MMA) welding.*

Another early method of welding which was also developed at that time was *gas welding*. The use of acetylene and oxygen made it possible to produce a comparatively high flame temperature,  $3100^{\circ}\text{C}$ , which is higher than that of other hydrocarbon based gas.

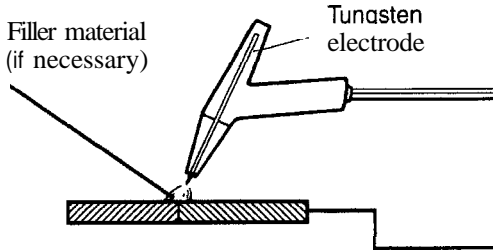
The intensity of all these heat sources enables heat to be generated in, or applied to, the workpiece quicker than it is conducted away into the surrounding metal. Consequently it is possible to generate a molten pool, which solidifies to form the unifying bond between the parts being joined.



*Figure 1.2 Submerged arc welding.*

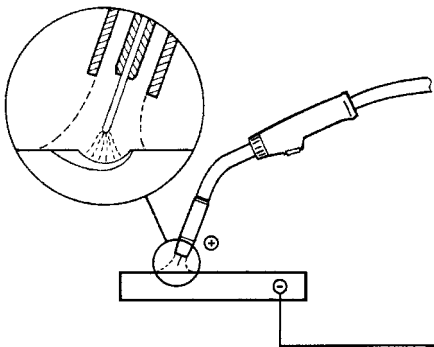
Later, in the 1930s, new methods were developed. Up until then, all metal-arc welding had been carried out manually. Attempts were made to automate the process using a continuous wire. The most successful process was *submerged arc welding* (SAW) where the arc is "submerged" in a blanket of granular fusible flux.

During the Second World War the aircraft industry required a new method for the welding of magnesium and aluminium. In 1940 experiments began in the USA with the shielding of the arc by inert gases. By using an electrode of tungsten, the arc could be struck without melting the electrode, which made it possible to weld with or without filler material. The method is called *TIG welding* (Tungsten Inert Gas).



*Figure 1.3 The TIG welding method.*

Some years later the *MIG welding process* (Metal Inert Gas) was also developed using a continuously fed metal wire as the electrode. Initially, the shielding gases were inert such as helium or argon. Zaruba and Potapevski tried to use  $\text{CO}_2$  as this was much easier to obtain and by using the "dip transfer" method they did manage to reduce some of the problems caused by the intense generation of spatter; however when using a relatively reactive gas such as  $\text{CO}_2$  or mixed gases such as argon/ $\text{CO}_2$ , the process is generally called MAG welding (Metal Active Gas).



*Figure 1.4 The MIG/MAG welding method.*

The power-beam processes *electron beam* (EB) *welding* and *laser welding* have the most intensive of heat sources. The breakthrough of EB-welding came in 1958. The aircraft and nuclear power industries were the first to utilise the method. The main characteristics of EB-welding are its deep and narrow penetration. Its one limitation is the need for a vacuum chamber to contain the electron beam gun and the workpiece.

In some respects, *Laser welding* (and cutting) have ideal characteristics. The laser beam is a concentrated heat source, which permits high speed and very low distortion of the workpiece, unfortunately, a high power laser is large and expensive. The beam must also be conducted to the joint in some way. The light from a CO<sub>2</sub> laser must be transmitted by mirrors, while that from a Nd:YAG-laser can be carried by a thin glass fibre, which makes it attractive for use with robotic welding.

In the future it should be possible to utilise lightweight diode lasers with sufficient power for welding. The diode laser has a higher efficiency in converting electrical energy into the light beam. Although it has not yet been possible to produce diode lasers with the same power output and beam quality as present welding laser sources; these are already being used for welding metal up to about 1 mm thick. The low weight and size make them an interesting power source for use with robotic welding.

## 1.2 Terminology

### Welding methods

Definitions of welding processes are given in ISO 857. Reference numbers for the processes are defined in ISO 4063. These numbers are then used on drawings (ISO 2553) or in welding procedure specifications (EN 288) as references.

TABLE 1.1 Reference numbers for some fusion welding methods (ISO 4063).

Welding method	Reference number
Metal-arc welding with coated electrode	111
Flux-cored wire metal-arc welding without gas shield	114
Submerged arc welding	12
MIG welding	131
MAG welding	135
MAG welding with flux-cored wire	136
TIG welding	141
Plasma arc welding	15
Oxy-fuel gas welding	31

### Basic terms

*Pressure welding.* Welding in which sufficient outer force is applied to cause more or less plastic deformation of both the facing surfaces, generally without the addition of filler metal. Usually, but not necessarily, the facing surfaces are heated in order to permit or to facilitate bonding.

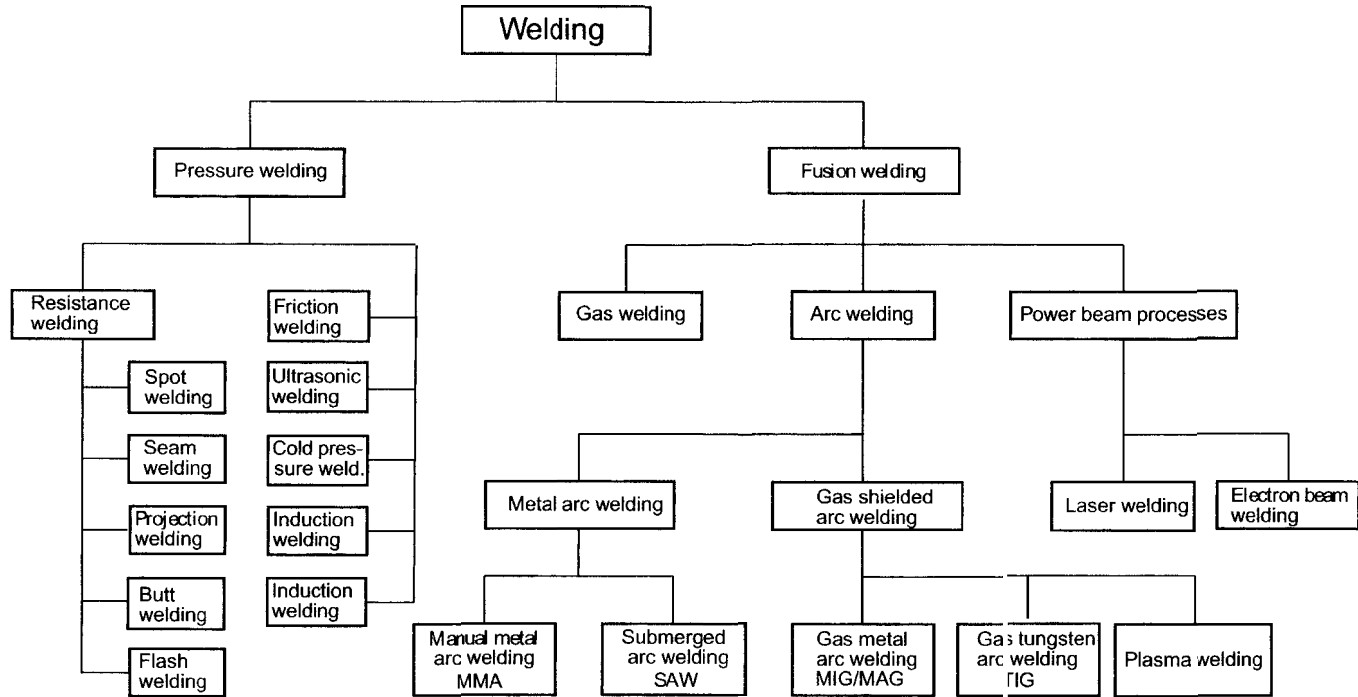
*Fusion welding.* Welding without application of outer force in which the facing surface(s) must be melted. Usually, but not necessarily, molten filler metal is added.

*Surfacing.* Producing a layer of different metal by welding, e.g. with higher corrosion, abrasion or heat resistance than the parent metal.

*Welding procedure specification (WPS).* A document specifying the details of the required variables for a specific application in order to assure repeatability (EN 288).

*Deposition rate.* Amount of metal supplied to the joint per unit time during welding.

Figure 1.5 Schematic presentation of the most common welding methods.



*Heat input.* The heat input has great importance for the rate of cooling of the weld. It can be calculated from the formula:

$$Q = \frac{U \cdot I \cdot 60}{V \cdot 1000} \cdot \text{Efficiency}$$

Efficiency\*:  
**MMA: 0.75**  
**MIG/MAG: 0.90**  
**SAW: 0.90**  
**TIG: 0.80**

where Q = heat input (kJ/mm)  
 U = voltage (V)  
 I = current (A)  
 V = welding speed (mm/min)

*\*) These efficiencies are close to physical measured values. Always check if other values are given in the regulations or standards used by your company.*

*Heat Affected Zone (HAZ).* The heat affected zone, (Figure 1.6), is that area of the base metal not melted during the welding operation but whose physical properties are altered by the heat induced from the weld joint.

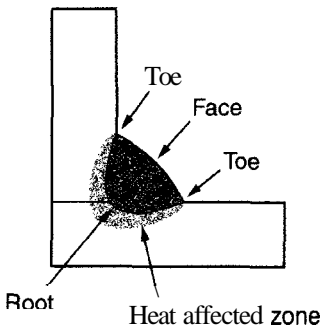


Figure 1.6 Fillet weld showing the location of weld toes, weld face, root and heat affected zone.

*Throat thickness.* Fillet welds are calculated by reference to the throat size. The size required is specified on drawings in terms of throat thickness, t, or the leg length, l, see Figure 1.7.

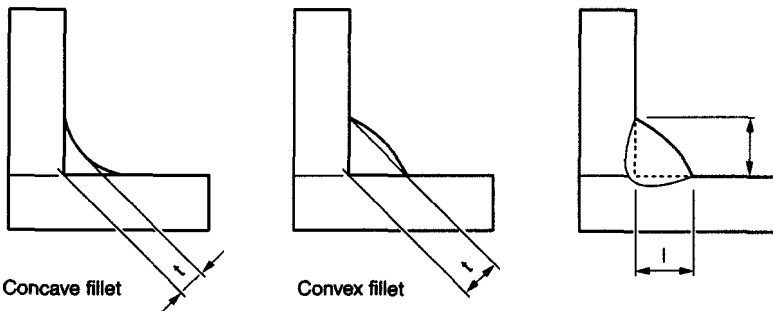


Figure 1.7 Throat thickness (t) and leg length l in a fillet weld



## Joint types

Joint types are chosen with regard to the welding method and plate thickness. The ideal joint provides the required structural strength and quality without an unnecessarily large joint volume. The weld cost increases with the size of the joint, and the higher heat input will cause problems with impact strength and distortion.

Joint preparation **can** also be expensive; therefore it is preferable to use joint types where the joint faces are parts of the workpiece. This means that fillet welds are probably the most commonly used joints.

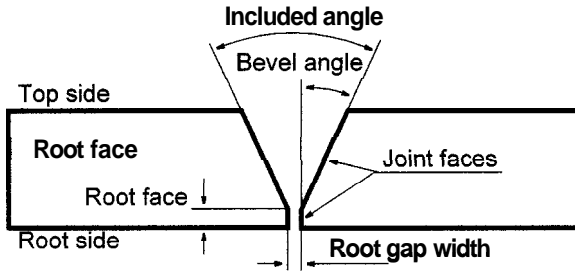


Figure 1.8 Joint terminology.

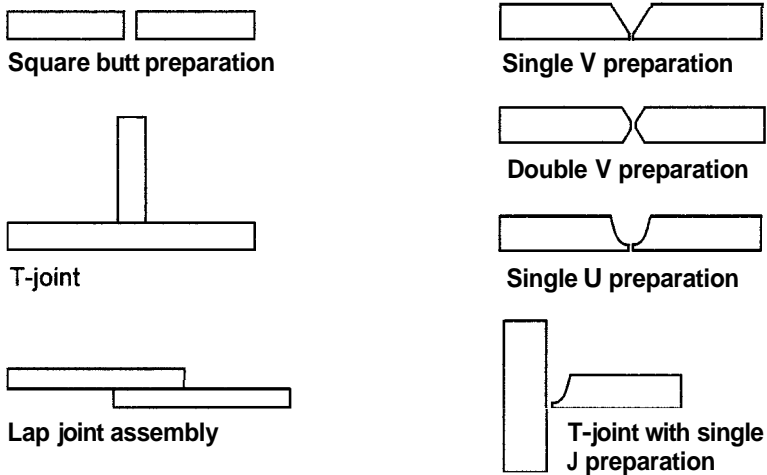


Figure 1.9 Examples of joint types.

## Welding positions

There are essentially four different fundamental welding positions, namely flat, horizontal-vertical, overhead and vertical position. Vertical position welding can be carried out as vertical upward or vertical downward welding. In addition, fillet welds can be made in the horizontal-vertical position or in the flat position, see Figure 1.10.

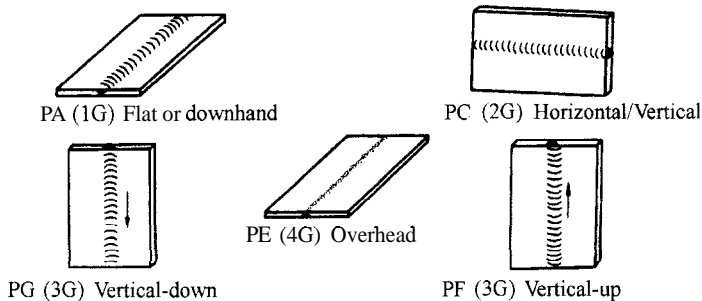


Figure 1.10 Definitions of welding positions for butt welds, as given in EN 287-1. AWS designation in parenthesis.

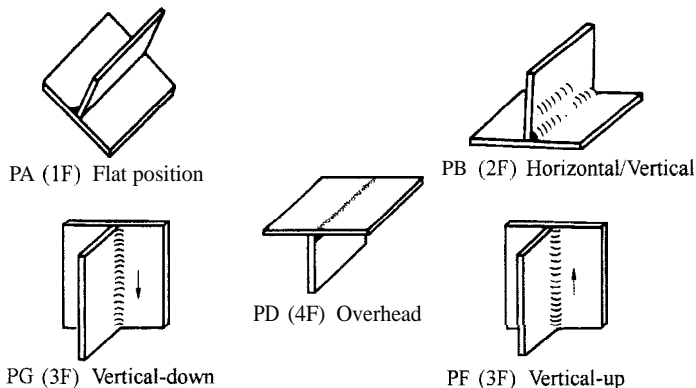


Figure 1.11 Definitions of welding positions for fillet welds, as given in EN 287-1. AWS designation in parenthesis.

## 1.3 Distortion

All fusion-welding methods produce the weld by moving a molten pool along the joint; when the heated metal cools, the shrinkage introduces residual stresses and distortion in the welded structure. The stresses produce longitudinal and rotational distortion.

*Longitudinal distortion.* "Shortens" the weld, but may in many cases not be a serious problem. An example of this type of distortion is a welded beam that can be bent if the weld is not located symmetrically (in the centre of gravity of the cross section). If more than one weld is used, they must be symmetrical.

*Rotational distortion.* The rotational distortion (see Figure 1.13) can be minimised by making the weld bead symmetrical about the neutral axis or by having a parallel-sided single pass weld, as with electron beam welding. A stiff section can also prevent this type of distortion from appearing.

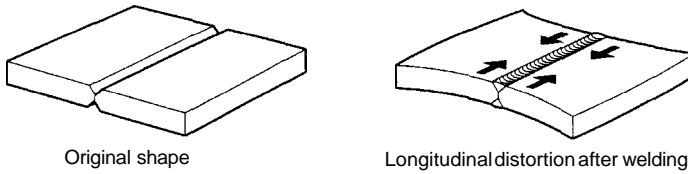


Figure 1.12 Longitudinal distortion.

Distortion is often minimised by offsetting the joints prior to welding, or by placing weld beads in a suitable sequence.

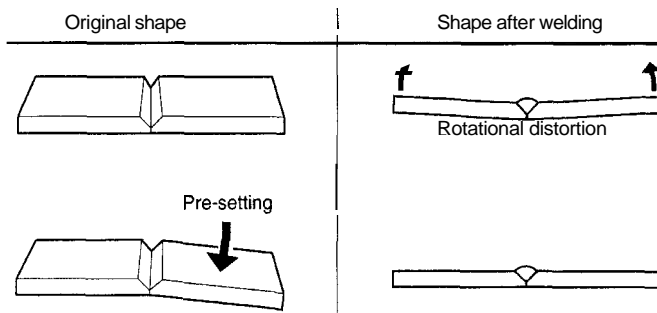


Figure 1.13 Rotational distortion **can** be prevented by pre-setting to compensate for distortion.

Limiting the heat input can also reduce distortion. A more intense heat source allows higher speed, lower heat input and less distortion. See Figure 1.14.

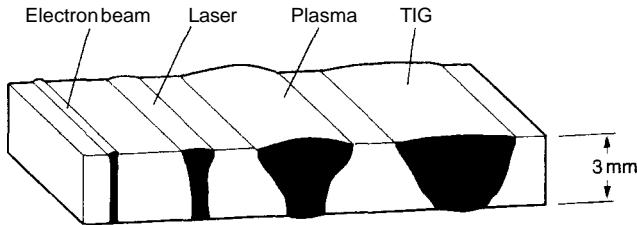


Figure 1.14 Penetration profile for some different welding methods.

## 1.4 The welding arc

A welding arc is an electric discharge between two electrodes. The welding current is conducted from the electrode to the workpiece through a heated and ionised gas, called plasma. The voltage drop and current in the arc give the amount of electric power that is released, the heat of which, melts the electrode and the joint faces.

The power must also be high enough to keep the temperature of the arc sufficient for the continued transport of the current. The temperature maintains ionisation of the gas, i.e. it creates electrically charged particles that carry the current.

Depending on the choice of shielding gas, different temperatures are needed to keep the plasma ionised. Argon, for example, is easier to ionise than helium. That means that welding in helium or helium-mixed gases produces a higher voltage drop and higher heat input to the weld pool.

When welding with a consumable electrode, such as MIG/MAG welding, the arc has two main functions. One is the above-mentioned supply of heat for melting the materials; the other is the transport of the molten electrode material down to the weld pool. This droplet transfer is very dependent on the electromagnetic forces and surface tension in the arc region. These forces have a great influence on the behaviour of the welding process, and enable one to distinguish between different arc types.

## Spray arc

At high current, the resulting magnetic forces are directed downwards which helps the droplet to be released from the surface tension at the electrode. The droplet transfer is characterised by a stream of small droplets.

## Short arc

At lower current it has the opposite effect. The magnetic forces are smaller and are also directed upwards. The droplet hanging at the tip of the electrode tends to increase in size and the process runs the risk of being unstable. A way to overcome this problem is to keep the arc length so short that the droplets will dip into the pool before they have grown too much. Surface tension will then start the transfer of the melted material and the tail of the droplet will be constricted by the magnetic forces, the so-called "pinch effect".

No metal is transferred in the form of free droplets across the arc gap. The stability of the short circuiting transfer is very sensitive to variations in the shielding gas, the chemical composition of the electrode and the properties of the power source and wire feed system.

## Magnetic arc blow

The force or 'arc blow' that arises when the magnetic field around the arc is not completely symmetrical, is a well-known problem with arc welding. In critical cases, it can result in a defective weld.

- The weld pool, and thus the weld bead, can be deflected towards one side, producing a defective weld.
- If the arc is deflected along the joint, the width of the bead and the penetration can be affected.
- The protection provided by molten slag or gas can be affected, resulting in the formation of pores.
- The problem becomes worse, and more noticeable, as the welding current increases, as this results in a corresponding rapid increase in all the electromagnetic forces in and around the arc.

**Possible causes**

*The return current connection is asymmetric*

Welding close to a return current connection, or with an asymmetrically connected connection, is a common cause of this problem.

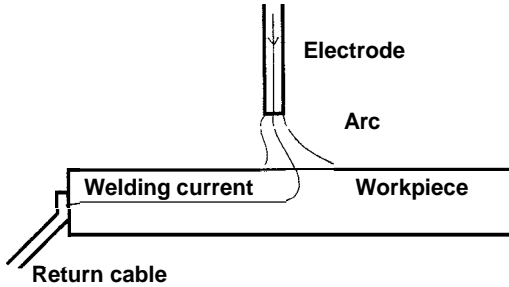


Figure 1.15 Rule of thumb no. 1: The magnetic forces from the welding current attempt to widen the current path.

*The workpiece is asymmetric*

The magnetic arc blow that arises when welding close to an edge or where the metal thickness increases.

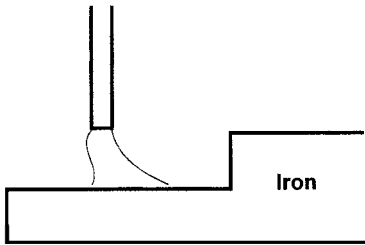


Figure 1.16 Rule of thumb no. 2: If magnetic material (iron) in the workpiece is asymmetrically distributed, the arc will move in the direction where there is the most metal.

*Electrodes close to each other when using multi-electrode welding*

Common in connection with, for example, submerged arc welding. Each current-carrying conductor is surrounded by its own magnetic field. The magnetic field from one electrode can interfere with the arc from an adjacent electrode.

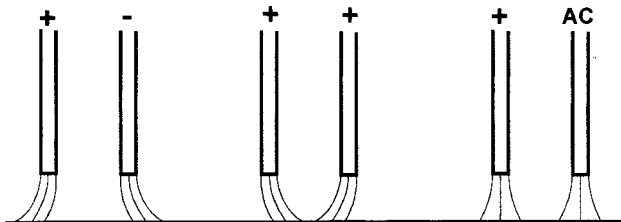


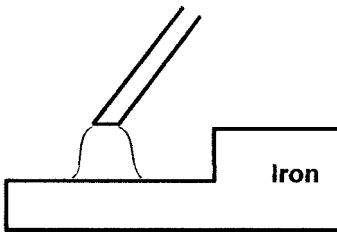
Figure 1.17 Effect from a nearby electrode.

### *Induced magnetic fields from the welding current*

When welding in steel, the workpiece can provide a path for the magnetic field. An example of this occurs in connection with internal longitudinal welding of a pipe or tube, where the welding current supply cable induces a magnetic flux in the tube. The joint produces a break (also known as an air gap) in the magnetic path, so that the magnetic flux spreads out and affects the arc.

### *Permanent magnetic fields*

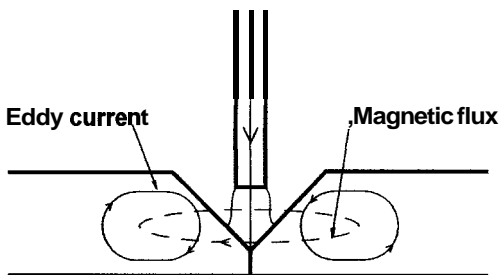
These are magnetic fields from magnetic clamping bedplates, or remanence (residual magnetisation) in the workpiece from, for example, lifting magnets, magnetic non-destructive testing or parts of jigs that have become magnetised by the welding current. Even the earth's magnetic field can be concentrated close to the ends of long steel items lying in a north-south direction, affecting the arc.



*Figure 1.18 Example: Holding the electrode at an angle (see rule of thumb no. 1) can compensate for the arc blow on asymmetric workpieces (rule of thumb no. 2).*

### **Recommended measures**

- Do not connect the return current connector close to the position of the weld. Welding towards the return current connection is often preferable. When welding long items, the current can be more evenly distributed by attaching equally long return current cables to each end of the object.
- The use of adequately sized starting and finishing discs can reduce problems at the beginning and the end of a joint.



*Figure 1.19 Eddy currents in the workpiece limit the magnetic flux when welding with AC.*

- AC welding is often better than DC welding: the interference from an external magnetic field is symmetrical, due to the constantly changing direction of the current, and there is less risk of interference resulting from induced fields. This is because the constantly reversing magnetic flux is opposed by eddy currents in the workpiece.

## 1.5 Shielding gases

The most important reason to use a shielding gas is to prevent the molten metal from the harmful effect of the air. Even small amounts of oxygen in the air will oxidise the alloying elements and create slag inclusions. Nitrogen is solved in the hot melted material but when it solidifies the solubility decreases and the evaporating gas will form pores. Nitrogen can also be a cause of brittleness. The shielding gas also influences the welding properties and has great importance for the penetration and weld bead geometry.

### Argon (Ar)

Argon is one of the most popular shielding gases thanks to its suitable properties. As an inert gas it has no chemical interaction with other materials. Therefore it is suitable for sensible materials such as aluminium and stainless steel. At MIG welding of mild steel an addition of CO<sub>2</sub> or a small amount of oxygen will increase the welding properties, especially for short arc welding. Contents of up to 20 % CO<sub>2</sub> improves the penetration (limits the risk of lack of fusion) while 5–8 % will give reduced spatter.

### Helium (He)

Helium like argon is an inert gas. It gives more heat input to the joint. Mixed with argon it increases welding speed and is advantageous for the penetration in thick-walled aluminium or copper where it compensates for the high heat conduction.

Drawbacks with helium is a high cost and the low density. At TIG welding, high contents of helium will reduce the ignition properties.

### Carbon dioxide (CO<sub>2</sub>)

Pure carbon dioxide (CO<sub>2</sub>) can be used for short arc welding. It is a cheap gas, it has good properties for welding of galvanised steel and gives better safety against lack of fusion than argon based gases. Drawbacks are a higher amount of spatter and the fact that the gas cannot be used for spray arc.

### Hydrogen (H<sub>2</sub>)

Small additions of hydrogen can be used to increase heat input and welding speed in the same manner as helium, but it is much cheaper. Because of the risk of cracks, hydrogen can only be used for welding of austenitic stainless steel. It actively reduces the oxides and is therefore also used in root gases.

### Oxygen (O<sub>2</sub>)

Oxygen is also used as a small addition to stabilise the arc at MIG welding.

### Nitrogen (N<sub>2</sub>)

Nitrogen can be used as an alloying element in ferritic-austenitic stainless steels. A small additive of nitrogen in the shielding gas compensates for the losses when welding.

## 1.6 Power sources

### The importance of the power source for the welding process

The main purpose of the power source is to supply the system with suitable electric power. Furthermore, the power source performance is of vital importance for the welding process; the ignition of the arc, the stability of the transfer of the melted electrode material and for the amount of spatter that will be generated. For this purpose it is important that the static and dynamic characteristics of the power source is optimised for the particular welding process.

#### Static characteristics

The static characteristics of a power unit can be plotted by loading the power unit with an adjustable resistive load. We speak of *drooping characteristics*, *constant-current characteristics* and *straight characteristics* (*constant-voltage characteristics*).

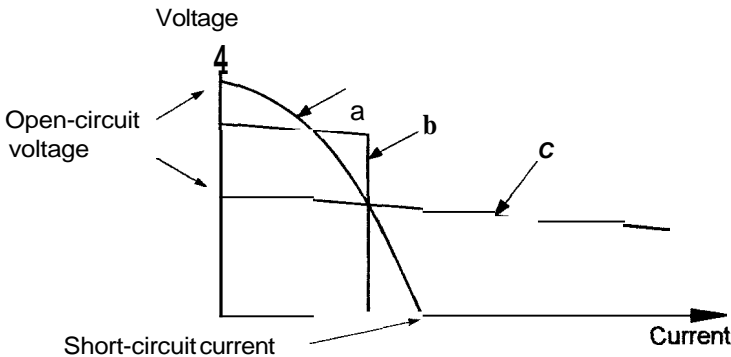


Figure 1.20 Examples of a) a drooping characteristic, b) a constant-current characteristic and c) a straight or slightly drooping characteristic.

A *constant-current characteristic* is used when the arc length is controlled by the welder, e.g. in TIG welding. If the arc length is unintentionally changed, the arc voltage changes to maintain a constant current.

A *drooping characteristic* is used for MMA welding, where it is an advantage if the short-circuit current is somewhat higher than the normal load current in order to prevent the electrode from 'freezing' to the workpiece when attempting to strike the arc. A drooping characteristic, as compared with a straight characteristic, also permits a higher no-load voltage, which is needed when welding with AC in order to prevent the arc from extinguishing too easily.

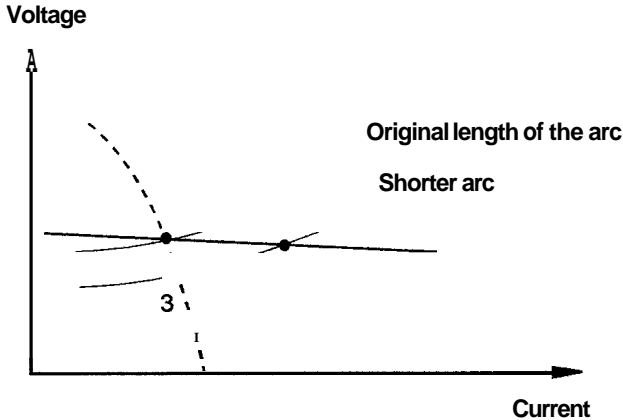
#### *Straight characteristic (constant-voltage characteristic)*

If the voltage remains almost constant when it is loaded it is known as a constant voltage or flat characteristic. Typically a voltage drop of 2–5 V/100 A is normal. A straight characteristic maintains good control of the arc length when welding with methods involving a continuously fed filler wire, such as MIG or perhaps submerged arc welding. In this case, the current is determined by the speed of the filler wire (i.e. the quantity of filler material being fed into the weld).



### Self-regulation of the arc

The point of intersection between the arc characteristic and the power unit load characteristic is referred to as the *working point*. The working point at any particular time represents the welding current and voltage at that time. If the arc length is to be stable, the power source characteristic must not slope too much.



*Figure 1.21 How the slope of the power unit characteristic affects the welding current if the arc length is altered.*

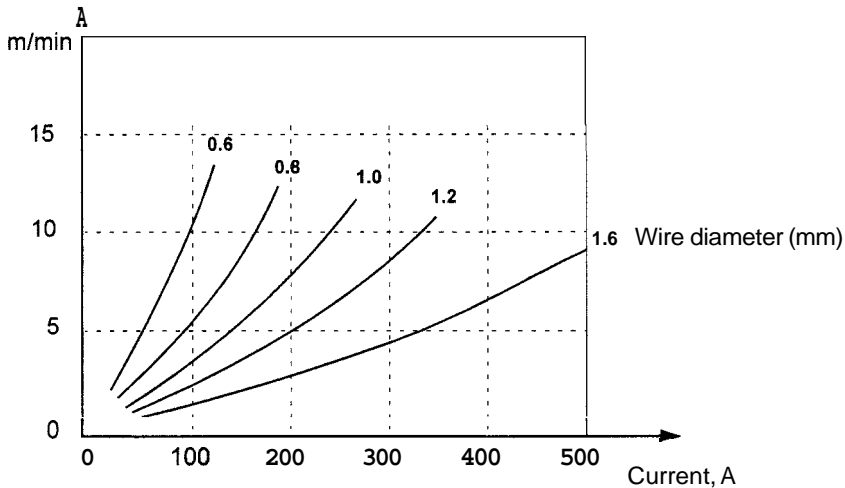
If, for example, something happens so that the length of the arc is reduced, the voltage drops and the current increases. It can be seen from Figure 1.21 that the current increases from working point 1 to working point 2 if the slope of the characteristic is slight, but only to working point 3 if the characteristic has a steep slope. The increase in current raises the rate of melting of the electrode, and the arc length is restored. This is known as the self-regulation characteristic of the arc length. MIG/MAG power units have a straight characteristic in order to provide good self-regulation performance.

### Setting the current and voltage

When *welding with coated electrodes*, or when performing TIG *welding*, it is the **current** that is set on the power unit, with the arc voltage then depending on the arc length that is used.

When *welding with a continuously supplied filler wire*, e.g. MIG/MAG welding, it is the **voltage** that is set on the power unit. The voltage then determines the length of the arc. This is a result of the arc's self-regulation characteristic: if the welder raises the welding torch, the arc length does not alter: instead, it is the wire *stickout* that alters. The current cannot be set directly: instead, it depends on the wire feed speed (and wire diameter) used.

The current, in other words, sets itself so that it is at just the value needed to melt the filler wire at the same rate as the wire is fed out. Changing the voltage, for example, does not greatly affect the current.



*Figure 1.22 The relationship between current and rate of melting for MIG/MAG welding with normal stickout. (Filler wire: ESAB Autrod 12.51).*

When performing submerged arc welding, and some other welding processes, with thicker electrodes, it can sometimes be preferable to use power units with drooping characteristics. The current then depends on the current setting in the power unit: as a result, the setting procedure is the reverse of what is normally the case. As self-regulation does not work very well with a drooping characteristic, an arc voltage regulator is used to control the wire feed speed. As a result, the arc and the arc length are kept constant.

### Dynamic characteristic

With relatively slow changes in the arc, one can assume that the working point follows the power unit static characteristic. However, in the case of more rapid changes, the dynamic characteristics of the power unit (mainly its inductance) increasingly determine how quickly the current can change to suit. This is important, particularly when welding with short-circuiting drop transfer.

Power units for short arc welding usually incorporate an inductor in their output. The action of the inductor can be likened to the effect of a flywheel in a mechanical system; if the voltage changes instantaneously, as when a droplet of molten metal short-circuits the arc, the current will rise much slower. Therefore it is important that there should not be a current surge during the short circuit, as this would result in high electromagnetic forces that would cause spatter and oscillations on the surface of the weld pool.

The aim is to achieve a high, steady short-circuiting frequency, with finely distributed droplets. The arc should strike quickly and cleanly. It is essential that the power unit has the correct dynamic performance.

## Current

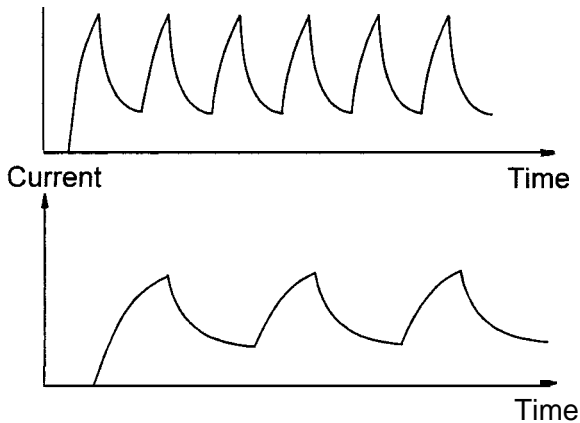


Figure 1.23 Welding current in short arc welding with low inductance (top) and with high inductance.

### Welding with alternating current

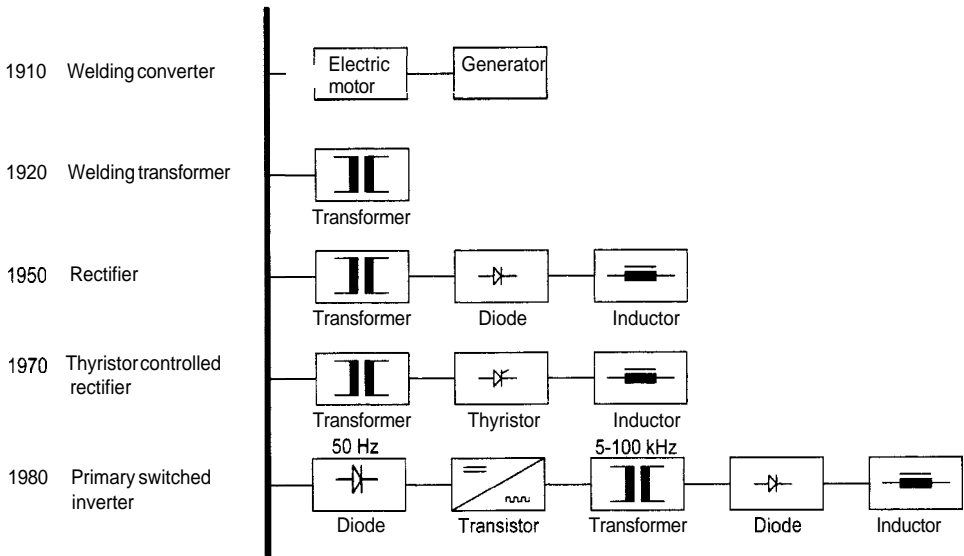
AC is a popular choice for welding due to the fact that it uses a simple and inexpensive power unit. Introducing alternating current does however lead to complications because unless special steps are taken, the arc will extinguish on each zero crossing. The need to re-ignite the arc also restricts the choice of coated electrodes and requires a sufficiently high open-circuit voltage, of at least 50 V, or more. However, electrical safety requirements currently restrict the open-circuit voltage to 80 V. (Special regulations apply in confined or damp areas: see Electrical safety requirements on page 24).

The advantages of alternating current are reduced risk of magnetic arc blow effect and good oxide-breaking performance when TIG-welding aluminium. AC welding can be a good alternative with certain coated electrodes, as it provides a higher melting rate and reduced smoke generation.

Special power units for AC welding, with a square wave pattern, have been developed. They are electronically controlled, and can have such rapid zero crossing transitions that they can be used for processes that would otherwise require a DC power source, e.g. TIG or MIG welding. An additional function on these power units is that it is possible to control the relative proportions of the power supply during the positive and negative parts of the cycle, known as balance control.

### Different types of welding power units

The welding power unit converts the high voltage of the mains supply to a non-hazardous level, i.e. it provides a means of controlling the current or voltage and produces the necessary static and dynamic characteristics as required by the welding process. Figure 1.24 shows the historical development of welding power units.



*Figure 1.24 Historical development of welding power units.*

### Motor-generator sets

Motor-generator sets were popular for many years, and are still sometimes used, although no longer manufactured. High cost and poor efficiency made it difficult for them to compete with modern welding power units. However, their welding characteristics can be excellent. They consist of a (3-phase) motor, directly coupled to a DC generator; as the motor speed depends mainly on the mains frequency, these units are relatively insensitive to variations in the supply voltage. They can be remotely controlled by varying the excitation current.

Welding generator power units driven by petrol or diesel engines are still made, and fill a need: they are used at sites without a supply of mains electricity.

### The welding transformer

Welding transformers provide alternating current, and are the cheapest and perhaps the simplest type of power unit. They are used primarily for welding with coated electrodes, although they can also be used with other welding methods when the use of alternating current is required. As opposed to other transformers, welding transformers generally have a drooping characteristic. A common way of effecting this is to separate the primary and secondary windings so that there is a certain leakage of magnetic flux. Adjusting the required welding current is then carried out by moving an additional section of core in or out of the windings by means of a handwheel. More advanced power units, for use with TIG, submerged arc and occasionally MIG welding, can be controlled by thyristors or transistors using square-wave switching technology. In such cases, it is common for them to be able to switch between AC and DC, producing what is known as AC/DC-units.

## Welding rectifier

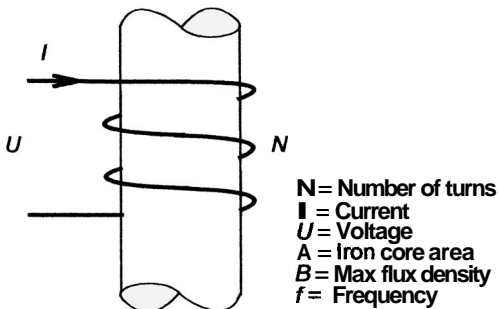
A traditional welding rectifier power source produces DC, and usually consists of a large 3-phase transformer with some form of rectifier on the secondary side. Power sources having a straight characteristic, for use with MIG/MAG welding, **generally** arrange for voltage control by means of a tap-changer on the transformer. An alternative is to use a thyristor-controlled rectifier bridge. Unfortunately, this **has** the disadvantage of chopping the output voltage, which makes it also necessary to fit a smoothing inductor. This is because the smoothness of the current **has** a considerable effect on the welding characteristics. Thyristor control also provides a means of **stepless** remote control and insensitivity to variations in the mains supply voltage. Overall efficiency is **70–80 %**.

The response speed of the thyristors is limited by the mains frequency, but is nevertheless **sufficiently** fast to allow the static characteristics of the power unit to be controlled. This means that the characteristic can be given varying slopes, from straight to drooping, so that the unit can be used with several different welding methods.

## Welding inverters

Inverter units appeared on the market during the second half of the 1970s. In a primary-switched inverter unit, the 50 Hz mains supply is first rectified and then, using power semiconductors, is turned back into AC at a higher frequency, usually in the range 5–100 **kHz**. This reduces the weight of the transformer and inductor to a fraction of what is needed for a 50 Hz unit, making the power unit small and portable. Low losses result in high efficiency, to the order of 80–90 %. The high working frequency also allows the unit to be controlled at a speed that is comparable with the rapid processes occurring in connection with droplet transfer in the **arc**. Such units can therefore have excellent performance. In comparison with traditional power sources, inverter units offer the following advantages:

- Low weight and small size
- Good welding performance
- Several welding methods can be used with the same power source
- High efficiency



*Figure 1.25 The size of the transformer and inductor depend on the number of turns and the cross-sectional core area, both of which can be reduced as the frequency is increased.*

$$N \cdot A = \frac{U}{4.44 \cdot f \cdot B}$$

A primary-switched inverter power source therefore combines low weight with good control arrangements. Its drawbacks are: that it is more complicated and difficult to make adjustable for different mains supply voltages.

For stationary applications, where weight is unimportant, a secondary-switched inverter power source can provide a useful alternative. These units use a conventional transformer, followed by a rectifier and a switching section that controls the current with the same precision as in a primary-switched inverter power source.

## Development trends

Modern electronics and computer technology have had a considerable effect on the development of arc welding equipment. This applies not only to the power circuits, but also to the control electronics in the power unit and in other parts of the electrical equipment used for welding. This rapid rate of development may seem confusing, providing many new potential setting instruments and controls. The following pages provide a review of the new opportunities and concepts that are available.

### Inverter control

Where welding characteristics were previously determined by the design and limitations of the heavy current circuits, control can now be provided by electronics and/or computers. Effectively, the high-speed power circuit operates as an amplifier, providing new opportunities not only for control of the welding parameters, but also for control of the process itself.

### Electric and welding characteristics

Different types of welding methods require different static characteristics. Electronic control increases the flexibility of the power source, and it is relatively simple to incorporate features enabling it to be used with several different welding methods. In addition to MIG/MAG, a power source may perhaps also be suitable for use with coated electrodes and TIG welding, without necessarily involving any significant extra cost. Many of the more advanced units are therefore suitable for use with several different types of welding.

However, it is not sufficient to simply modify the static characteristic in order to suit a power source to different welding methods. Appropriate dynamic characteristics are needed in order to achieve smooth, stable welding without spatter, particularly when using filler wire processes where the arc is short-circuited by molten droplets.

Conventionally designed welding power sources could only be used for one particular type of welding method. They were generally optimised for a particular range of electrodes, materials and shielding gases. Electronically controlled power sources, on the other hand, with fast reactions, make it possible to adjust the characteristics of the power source to suit the particular process.

### Controllable welding characteristics

The welding characteristics of the power source dictate how well the power source performs when welding, e.g. that starting is immediate and without problems, that the arc is stable with a smooth transfer of droplets and that any spatter formation is limited and finely distributed. As a rapidly controllable power source does not essentially have any characteristics of its own, they have to be produced by the electronic or computer control.

Good characteristics are particularly important when using short-arc welding, especially when considering the stream of molten droplets to be transferred to the weld pool. Detachment of each droplet is critical, bearing in mind possible spatter formation and the forces that can cause surging of the molten metal in the weld pool. Correct control can maintain a high, consistent short-circuit frequency, resulting in stable transfer of fine droplets with a minimum of large spatter droplets. These characteristics are particularly important when using CO<sub>2</sub> as the shielding gas.

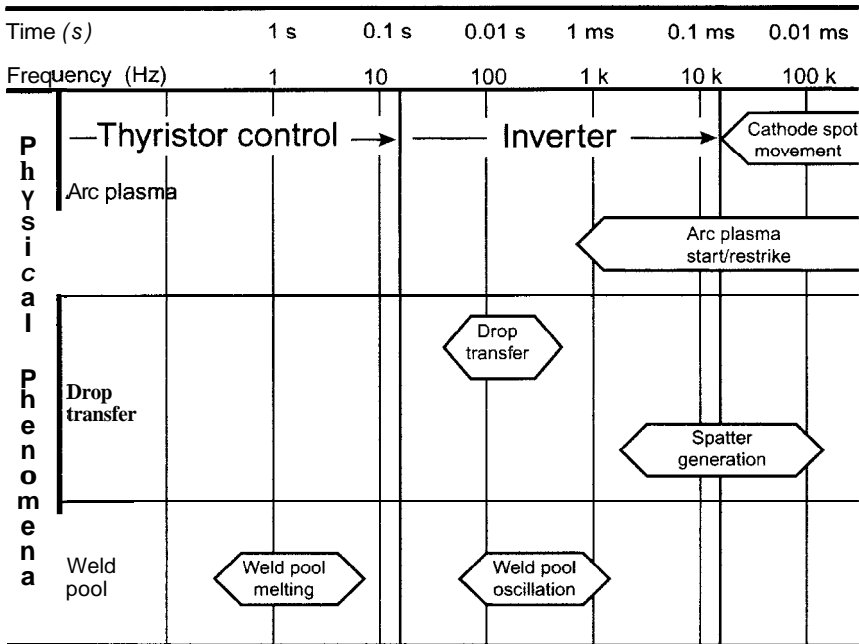


Figure 1.26 The speed of response of the power source is decisive in determining and controlling various processes in the arc.

### Computer control

The most advanced power sources generally incorporate some form of computer control. The computer can be used for communication with the user selecting the welding method and making the necessary parameter adjustments. A memory provides a means of saving and reusing previously used settings. Computer control allows maximum utilisation of the flexibility provided by modern power sources.

- Software control of current output and the welding process
- Multi-process possibilities - MIG, TIG and MMA welding with the same equipment
- Synergy line characteristics, providing optimised settings/performance for each situation
- Pulsed arc MIG welding
- Feedback control of welding parameters, guaranteeing improved accuracy and reproduction

- Improved welding start and stop functions
- Man/machine communication with the user through the control panel

The ability to achieve the intended welding quality is improved by the availability and/or use of various functions, examples of which are shown in Table 1.2 below.

**TABLE 1.2 Examples on functions available on advanced power sources.**

	Function	Process
<b>Start of welding</b>	<b>Creep start</b>	MIG
	<b>Gas pre-flow</b>	MIG, TIG
	<b>Hot start</b>	MIG, MMA
	<b>HF-start</b>	TIG
	<b>Lift arc</b>	TIG
	<b>Slope up</b>	TIG
<b>Continuous welding</b>	<b>Pulsed MIG welding</b>	MIG
	<b>Arc length control</b>	MIG
	<b>Step-less inductance setting</b>	MIG
	<b>Synergy lines</b>	MIG, MMA
	<b>Pulsed TIG</b>	TIG
	<b>Slope up</b>	TIG
	<b>Arc force</b>	MMA
<b>Feedback controlled parameter settings</b>	MIG, TIG, MMA	
<b>Finishing a weld</b>	<b>Crater filling</b>	MIG
	<b>Slope down</b>	TIG
	<b>Bum back time setting</b>	MIG
	<b>Shake off pulse</b>	MIG
	<b>Gas post flow</b>	MIG, TIG

MIG/MAG and other welding processes require several welding parameters to be optimised in order to achieve the best results. A popular way of doing this is the use of single-knob control, known as synergic setting of the welding parameters. This represents combinations of parameters that have originally been established by skilled welders, e.g. combinations of wire feed speed, current, voltage etc., with the results being stored in the memory of the power source. Users start by selecting the required welding method, followed by the type of material, wire diameter and shielding gas. Any subsequent change in the wire feed speed is then compensated by the power source which, at all times, adjusts the other parameters as necessary. Nevertheless, the welder can also override the settings and make manual adjustments from these default characteristics if required.



## Rating data for power sources

The power source rating plate lists the design ratings of the power source, with the most important being the related values of rated current, rated voltage and duty cycle. Other interesting information shown on the rating plate includes efficiency and power factor, open-circuit voltage, and insulation class etc. IEC 974-1 gives details of how power sources are to be tested and of what information is to be shown on the rating plate.







<b>ESAB Welding Equipment AB</b> <b>S-69581 Laxå Sweden</b> <b>Made in Sweden</b>																				
<b>AristoArc 400</b>																				
			<b>IEC/EN 60974-1</b> <b>EN 50199</b>																	
<b>16 A / 21 V - 400 A / 36 V</b>																				
		<table border="1"> <tr> <td>---</td> <td>X</td> <td>35%</td> <td>60%</td> <td>100%</td> </tr> <tr> <td>U<sub>0</sub> =</td> <td>I<sub>2</sub></td> <td>400 A</td> <td>320 A</td> <td>250 A</td> </tr> <tr> <td>78-90V</td> <td>U<sub>2</sub></td> <td>36 V</td> <td>33 V</td> <td>30 V</td> </tr> </table>				---	X	35%	60%	100%	U <sub>0</sub> =	I <sub>2</sub>	400 A	320 A	250 A	78-90V	U <sub>2</sub>	36 V	33 V	30 V
---	X	35%	60%	100%																
U <sub>0</sub> =	I <sub>2</sub>	400 A	320 A	250 A																
78-90V	U <sub>2</sub>	36 V	33 V	30 V																
		U <sub>1</sub> 400V 50-60Hz		I <sub>1max</sub> 38 A    I <sub>1eff</sub> 22 A																
AF		IP 23																		

Figure 1.27 Rating plate.

### Standard for welding power sources

The International and European Standard IEC/EN 60974-1 specifies demands on power sources regarding electrical safety. It defines important design principles, rating and testing of the equipment to ensure a safe operation.

### Application class

This symbol shows that the power unit is designed for use in areas of elevated electrical risk, i.e. where conditions are cramped (with electrically conducting walls or equipment etc.), or where it is damp.

### Enclosure class

The IP code indicates the enclosure class, with the first figure indicating the degree of protection against penetration of solid objects, and the second figure indicating the degree of protection against water. IP 23 is suitable for use indoors and outdoors.

### Class of insulation

The transformer and inductor insulation material limits the maximum temperature on the windings. If a power source uses class H insulation material it means that it is made for 180°C (20 000 hours). At a heating test of the power source with this class of insulation it is controlled that the rise of temperature in windings not exceeds 125 degrees above ambient temperature.

## Rated current

The rated current is the current for which the power source is designed. In some cases, a number in the name of the unit may give the impression that it can supply a higher current: always check the technical data or the rating plate to make sure what the actual value of rated current is.

## Rated voltage

IEC 974 specifies a standard load line which, for each value of rated current, shows the voltage at which the power source must be tested and with which it must be marked. This means that it is easier to compare the rated data for power sources from different manufacturers. The relationships specified by IEC 974 differ from one welding method to another: for currents up to 600 A, the voltages are as follows:

MMA and SAW:	$U = 20 + 0.04 \cdot I$	For currents above 600 A:	$U = 44 \text{ V}$
TIG:	$U = 10 + 0.04 \cdot I$	For currents above 600 A:	$U = 34 \text{ V}$
MIG/MAG:	$U = 14 + 0.05 \cdot I$	For currents above 600 A:	$U = 44 \text{ V}$

## Duty cycle

The power source rating is also determined by its duty cycle, which indicates for what proportion of a period of ten minutes that the power source can be operated at the specified load. 400 A at 35 % duty factor, for example, means that the power source can supply 400 A for 3.5 minutes in every ten minutes indefinitely without overheating.

## Efficiency and power factor

The efficiency indicates what proportion of the input power finds its way through to the welding process. If the efficiency is 75 %, this means that 25 % of the input power is dissipated in the form of heat losses in the power source.

$$\text{Input power} = \frac{\text{Welding current} \cdot \text{Welding voltage}}{\text{Efficiency}}$$

The actual power demand can then be calculated if the efficiency is known. The active power supplied to the source is measured in kW, and determines the energy cost.

The current to be supplied by the mains, and thus passing through the supply fuses, increases if the efficiency is poor. However, in order to be able to work out the supply current, we also need to know the power factor. For a 3-phase supply, we have:

$$I_1 = \frac{P_1}{U_1 \cdot \sqrt{3} \cdot \lambda}$$

where:

$I_1$  = mains current [A]

$P_1$  = input power [W]

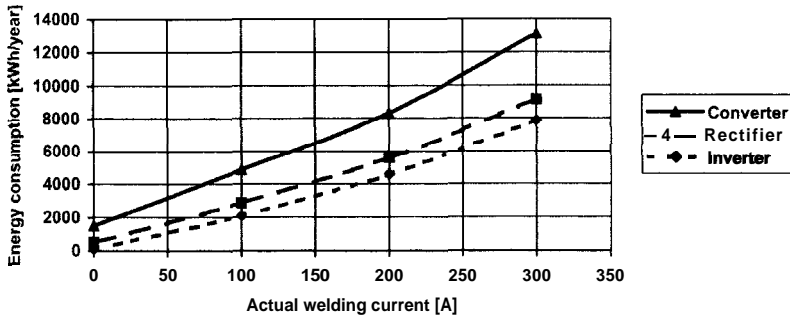
$U_1$  = supply voltage [V]

$\lambda$  = the power factor

The power factor depends partly on the phase displacement between the current and the voltage, and partly on the shape of the current waveform if this departs from a sine

wave. Multiplying the current and voltage gives the reactive power, which is measured in kVA and which is of importance when determining the capacity of the electrical supply system.

Typical values of power source efficiency are in the range 0.75–0.85. The power factor can be as high as **0.95**, e.g. for a semi-automatic power source with tap-changer control or for certain inverter units, although it is usually considerably lower for MMA power sources. The power factor of large welding transformers with drooping characteristics is often improved by the fitting of phase compensation capacitors, which can improve the power factor from for example **0.40** to **0.70**.



*Figure 1.28 Annual energy consumption for different types of manual (MMA) power sources. The differences are due to the different efficiencies and no-load losses of the power sources.*

## Electrical safety requirements

It is important from the point of view of electrical safety that the open-circuit voltage of the power unit is not too high. This is particularly important when using AC for welding, where a high open-circuit voltage is often required in order to ensure a stable arc. At the same time, health and safety requirements are particularly strict in connection with the use of AC. IEC 974 permits a maximum of **80 V AC**, as compared with **113 V DC**. Open-circuit AC voltage may not exceed **48 V** in wet areas or confined spaces, which are regarded as presenting a higher electrical safety risk. Special devices intended to reduce the open-circuit voltage are available to allow safe welding without affecting the welding characteristics.

A welding circuit is not protectively earthed: therefore it is particularly important that the power source is well insulated in order to ensure that the mains voltage cannot reach the secondary circuits.

Transformer winding insulation is exposed to high temperatures, so the material must be of a suitable insulation class to withstand the temperature. A rise of  $10^{\circ}\text{C}$  reduces the life of the material by half. Therefore it is particularly important to keep the interior of the power source clean in order to maintain adequate cooling performance.

Power sources used outdoors should be designed so that moisture and rain cannot degrade the insulation performance.

Despite all these measures, the welder should still take care: the use of gloves, together with undamaged dry clothing, is recommended.

## Fire risks

Welding or thermal cutting are common causes of fire. Experience shows that the risks are greatest in connection with temporary work in premises or areas not normally intended for welding. If such work has to be carried out, the person responsible for safety must decide on what protective measures need to be taken.

- Cleaning and removal of combustible materials in the risk zone.
- Any holes or gaps in combustible materials used in the building must be covered or sealed so that weld spatter or sparks, e.g. from gas cutting, cannot find their way in.
- Dampening surfaces with water.
- Screening off the work area.
- Ensuring that adequate extinguishing equipment is available.
- Supervision and subsequent checking after welding has been concluded.



*Figure 1.29 Risks are greatest in connection with temporary work in premises or areas not normally intended for welding*

## 2 Gas welding

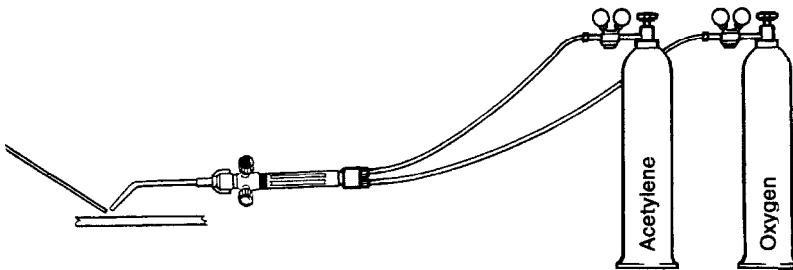
Gas welding is one of the oldest methods of welding and, for many years, was the most widely used method of metal-melting; however, its use is a lot less common today. Nevertheless, it is a versatile method, using simple and relatively cheap equipment. It is suitable for repair and erection work, for welding pipes/tubes and structures with a wall thickness of 0.5–6 mm in materials particularly prone to cracking, such as cast iron and non-ferrous metals. It is also widely used for cladding and hardfacing. The heat is generated by the combustion of acetylene in oxygen, which gives a flame temperature of about 3100 °C. This is lower than the temperature of an electric arc, and the heat is also less concentrated. The flame is directed onto the surfaces of the joint, which melt, after which filler material can be added as necessary. The melt pool is protected from air by the reducing zone and the outer zone of the flame. The flame should therefore be removed slowly when the weld is completed.

The less concentrated flame results in slower cooling, which is an advantage when welding steels that have a tendency to harden, although it does make the method relatively slow, with higher heat input and the added risk of thermal stresses and distortion.

In addition to welding, gas flames are also often used for cutting, and are very useful for heating and flame straightening.

### 2.1 Equipment

A set of equipment (Figure 2.1) consists essentially of gas bottles, pressure regulators, gas hoses, flashback arresters and welding torches.



*Figure 2.1 A gas welding set.*

### Welding gases and their storage

Gas bottles for combustible gases must be stored outdoors or in a well-ventilated area. Special warning signs must be displayed on the outside of the storage area. Acetylene and oxygen bottles must be kept well apart.

## Acetylene

Acetylene ( $C_2H_2$ ) is the fuel gas for gas welding. It consists of 92.3 % of carbon by weight, and 7.7 % of hydrogen. Its combustion in oxygen produces a higher combustion temperature than that of any other hydrocarbon gas. In addition, its flame is the most concentrated in comparison with other gases.

Acetylene ignites very easily, and produces an explosive mixture in air over a wide range of concentrations (2.3–82 %). Check carefully that there are no leaks.

Acetylene is chemically unstable under pressure, even without the presence of air and, under certain conditions, it can explosively decompose to its constituents (carbon and hydrogen). To enable the gas to be stored, the bottles are filled with a porous mass, saturated with acetone, which absorbs the gas when it is filled. The pressure in the bottles is 2 MPa. However, explosive decomposition can occur in the pipes from the bottle if the pressure exceeds 1.5 MPa.

TABLE 2.1 Important characteristics of fuel gases.

Gas	Density, kg/m <sup>3</sup>	Calorific value. MJ/kg	Flame temperature. °C	Combustion velocity, m/s
Acetylene	1.07	48.2	3 100	13.1
Propane	2.00	46.4	2 825	3.7
Hydrogen	0.08	120	2 525	8.9

## Oxygen

Oxygen is stored as a compressed gas or liquid. In bottles, it is usually stored at a pressure of 20 MPa. Large users usually receive the gas in liquid form.

Make sure that all connections are clean and tight, in order to avoid leakage. Never apply oil or grease to connections.

## Pressure regulators

The purpose of the pressure regulator is to reduce the high and variable pressure in the bottle to a suitable working pressure. It keeps the gas flow rate constant throughout the life of the bottle charge, despite any variations in back pressure caused by the heating of the welding torch.

## Gas hoses

Gas hoses are colour-coded: red for acetylene and blue for oxygen. In addition, in order to protect against mistakes, the acetylene connection has a left-hand thread, while the oxygen connection has a right-hand thread.

## Flashback arrester

A flashback means that the flame burns backwards into the torch with a popping sound. It occurs if the combustion speed of the flame exceeds the speed at which the gas is being supplied, so that the flame front moves backwards.

A flashback arrester fitted at the regulator prevents a flashback from going any further back.

The reason for a flashback occurring is that a mixture of oxygen and acetylene has occurred in the hoses, e.g. by oxygen having entered the acetylene hose and formed an

explosive mixture. The flashback arrester prevents the flame from reaching the acetylene bottle and triggering an explosive decomposition.

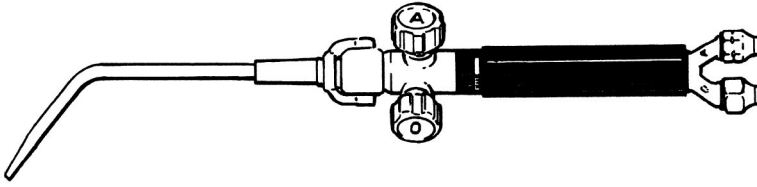


Figure 2.2 Gas welding torch.

## Welding torches

One can distinguish between two types of welding torches: *injector torches* for low pressure acetylene and *high pressure torches*.

In high pressure torches, the acetylene and oxygen flows are self-powered by the pressure in their storage bottles, and mix in the mixing chamber section of the torch.

In low-pressure torches, the oxygen flows into the torch through a central jet, producing an injection effect that draws in acetylene from the surrounding peripheral connection. From here, the gases continue to the mixing section prior to combustion.

## Gas flames

The basic requirement for a good weld is that the size and type of the flame should be suited to the type of work.

The size of the flame depends on the size of the torch nozzle and on the pressure of the gases flowing through it. This pressure should be maintained within certain limits. If it exceeds the normal pressure, there will be a considerable jet effect and the flame will become 'hard'. Below the correct pressure, the jet effect will be reduced and the flame will be 'soft'.

We distinguish between three different types of flames, depending on their chemical effect on the melt pool: carburising, neutral, and oxidising.

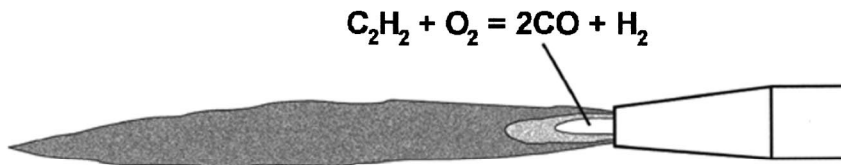
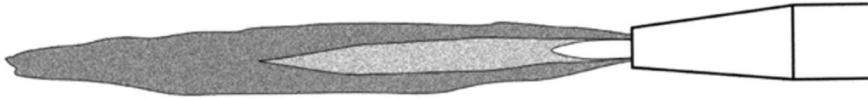


Figure 2.3 A normal welding flame. Carbon monoxide and hydrogen are formed in the innermost reaction zone. They produce a reducing zone (in the middle), with combustion continuing in the outer zone with oxygen from the surrounding air.

## Neutral flame

The normal flame is that which is used most. It (Figure 2.3) is easily recognised by the three clearly distinguished combustion zones. The innermost zone, the cone, is a mixing

zone and glows white. Acetylene is burning here, to form carbon monoxide and hydrogen which produce a **colourless** tongue around the cone. This second zone is chemically reducing, and so it reduces any metal oxides and keeps the melt pool clean. The outer, blue zone of the flame is where carbon monoxide and hydrogen are burning with oxygen from the air, forming the final combustion products of carbon dioxide and water vapour. It prevents oxygen in the air from coming into contact with the molten metal, and so acts as a shielding gas.



*Figure 2.4 Carburising flame.*

### The carburising flame

If the proportion of acetylene in a neutral flame is increased, there is **insufficient** oxygen to burn the surplus acetylene in the core zone. The acetylene therefore continues to the second zone, where it appears as a highly luminous yellow-white flame. To some extent, the length of second zone indicates the amount of excess acetylene.



*Figure 2.5 Oxidising flame.*

### The oxidising flame

If the quantity of oxygen in the weakly reducing flame is further increased, the flame changes to an oxidising flame. The core length is reduced, and the flame takes on a violet tinge with low luminosity.

## Forehand and backhand welding

Two different methods of welding are used when gas welding: forehand and backhand. The flame in forehand welding is directed away from the finished weld, while in backhand welding it is directed towards it ([Figure 2.6](#)).

Thin sheet metal (less than 3 mm) is normally carried out using forehand welding. This method is generally used for *non-ferrous metals*, although thicker materials can also be backhand welded.

*Steel* over 3 mm thick should be backhand welded, as the size of the melt pool is so large, when welding thick materials, that the gases and slag cannot escape **from** the pool without assistance. Backhand welding is faster than forehand welding, and so the **work-piece** is subjected to high temperature for a shorter time. As a result, backhand welding thick materials have a finer crystalline structure and retain their toughness better than would have been the case if they had been forehand welded.



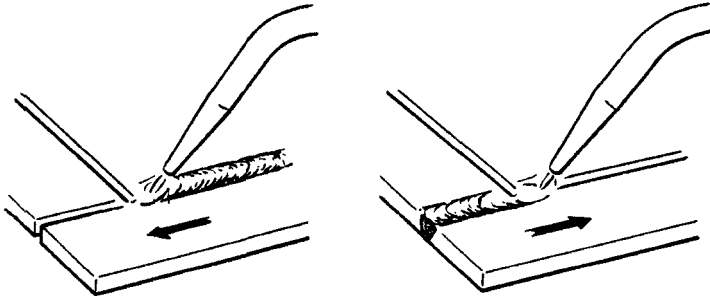


Figure 2.6 Forehand welding (left) and backhand welding (right).

Flux is used when welding easily oxidised materials, where the welding flame itself is insufficient to prevent oxides forming. This is likely to be the case when welding stainless steels and non-ferrous metals. The flux is brushed onto the joint surfaces before welding, and must be thoroughly removed after welding in order to prevent corrosion.

## The benefits of gas welding

Gas welding is very suitable for welding pipes and tubes, it is both effective and economic for applications such as HVAC systems, for the following reasons:

- The ability to even out the temperature in the weld at low temperatures. Slow heating and cooling can avoid the risk of hardening.
- Metal thicknesses up to about 6 mm can be welded with an I-joint.
- Speed, as only one pass is needed. Filler wires can be changed without having to pause for grinding.
- Good control of melting, as the welder can see at all times that he has the desired pear-shaped opening in the bottom of the melt pool.
- Root defects are avoided by taking care to ensure good **burn-through**.
- Pipes and tubes often have to be welded in very confined spaces. In such cases, gas welding is often preferable, bearing in mind the less bulky protective equipment required (goggles, as against a normal arc welding helmet or visor, and compact torch) to perform the work.
- The equipment is easy to transport and requires no electricity supply.
- It is possible to use the light from the flame to locate the joint before welding starts.
- The size of the HAZ can be reduced by surrounding the weld area with damp (fire-proof!) material.

Other applications for gas welding include welding of hot water pipes, gas bottles, nuclear heat exchangers and boilers.

**Warning:** Note the risk of fire when carrying out temporary welding or cutting work in the vicinity of flammable materials or parts of buildings.

# 3 TIG welding

## 3.1 A description of the method

TIG welding (also called Gas Tungsten Arc Welding, GTAW) involves striking an arc between a non-consumable tungsten electrode and the workpiece. The weld pool and the electrode are protected by an inert gas, usually argon, supplied through a gas cup at the end of the welding gun, in which the electrode is centrally positioned.

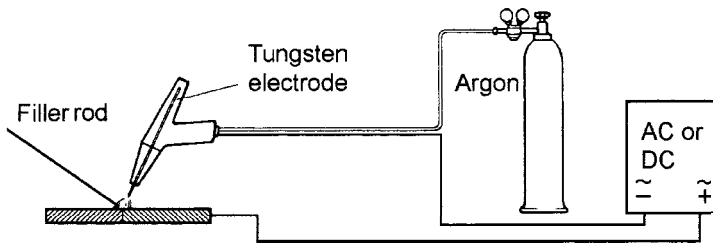


Figure 3.1 Schematic diagram of TIG welding equipment.

TIG welding can also be used for welding with filler material, which is applied in rod form by hand similar to gas welding. Tools for mechanised TIG welding are used for applications such as joining pipes and welding tubes into the end plates of heat exchangers. Such automatic welding tools can incorporate many advanced features, including mechanised supply of filler wire.

Characteristics of the method include:

- the stable arc
- excellent control of the welding result.

The main application for TIG welding is welding of stainless steel, welding of light metals, such as aluminium and magnesium alloys, and the welding of copper. It is also suitable for welding all weldable materials, apart from lead and zinc, with all types of joints and in all welding positions. However, TIG welding is best suited to thin materials, from about 0.5 mm up to about 3 mm thick. In terms of productivity, TIG welding cannot compete with methods such as short arc welding.

## 3.2 Equipment

The following equipment is required for TIG welding:

- welding gun
- HF (= high-frequency) generator for ignition of the arc
- a power source
- shielding gas
- control equipment

## The welding gun

The basic requirement applicable to the welding gun is that it must be easy to handle and well insulated. These requirements apply for manual welding, but are less important for mechanical welding. There are two main types of welding guns: water-cooled and air-cooled. Present-day welding guns of these two types can carry welding currents of:

- water-cooled: maximum about 400 A
- air-cooled: maximum about 200 A.



*Figure 3.2 Examples of TIG welding guns.*

## Striking the arc

A TIG welding arc is generally ignited with the help of a high-frequency generator, the purpose of which, is to produce a spark which provides the necessary initial conducting path through the air for the low-voltage welding current. The frequency of this initial ignition pulse can be up to several MHz, in combination with a voltage of several kV. However, this produces strong electrical interference, which is the main disadvantage of the method.

It is not good practice to strike the arc by scraping the electrode on the workpiece: this not only presents risk of tungsten inclusions in the weld, but also damages the electrode by contaminating it with the workpiece material.

Another method of striking the arc is the 'lift-arc' method, which requires the use of a controllable power source. The arc is struck by **touching** the electrode against the workpiece, but in this case the special power source controls the current to a **sufficiently** low level to prevent any adverse effects. Lifting the electrode away from the workpiece strikes the arc and raises the current to the pre-set level.

## The power source

TIG welding is normally carried out using DC, with the negative connected to the electrode, which means that most of the heat is evolved in the workpiece. However, when welding aluminium, the oxide layer is broken down only if the electrode is connected to the positive pole, this then results in excessive temperature of the electrode. As a compromise, aluminium and magnesium are therefore generally welded with AC.

TIG power sources **are** generally electronically controlled, **e.g.** in the form of an inverter or a thyristor-controlled rectifier. The open-circuit voltage should be about 80 V, with a constant-current characteristic.

When welding with AC (a sine wave), the HF generator is engaged all the time: if not, the arc would extinguish on the zero crossings.

## Square wave AC

A number of new designs of power sources appeared during the 1970s, based on new technology involving a square waveform. This means that the zero crossings are very fast, which has the effect of:

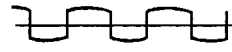
- generally not needing a continuous HF ignition voltage for AC TIG welding
- making it possible to vary the proportions of the positive and negative polarity currents, which means that it is possible to control the penetration and oxide breakdown, for example, when welding aluminium.



Balanced square wave



Increased penetration  
70% electrode negative



Increased oxide cleaning  
45% electrode negative

Figure 3.3 Use of a square wave and balance control in TIG welding.

Figure 3.3 shows the current waveform of a square wave supply. The balanced curve (left) has a very fast zero crossing, as opposed to that of a conventional sinusoidal waveform. The ability to shift the balance point of the two polarities means that, in certain cases, the welding speed can be increased by 50–75%. The normal setting of the balanced waveform has 50% negative polarity on the electrode. The two curves to the right show 70% negative/30% positive polarity (for greater penetration or speed) and 45% negative/55% positive (for improved oxide breakdown).

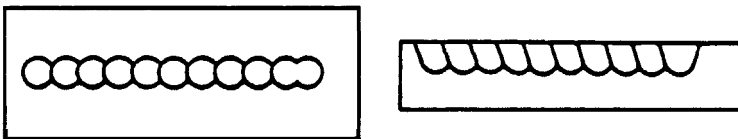


Figure 3.4 The principle for pulsed TIG requires the weld pool to partly solidify between the pulses.

## Thermal pulsing

This is used to provide better control of the melt pool and the solidification process. The pulse frequency is set sufficiently low to allow the melt pool to partially solidify between each pulse. Supplying the heat in pulses has several benefits:

- Less sensitivity to gap width variations
- Better control of the weld pool in positional welding
- Better control of penetration and the penetration profile
- Reduced sensitivity to uneven heat conduction and removal.

## Control equipment

The necessary control equipment depends on to what extent the welding process is mechanised. However, it is usual for the pre-flow and post-flow of the shielding gas, and the HF generator, to be automatically controlled. Crater filling by slope-down of the current, and the ability to pulse the current, are also often employed. Gas pre-flow and post-flow protect the electrode and the weld pool against oxidation.

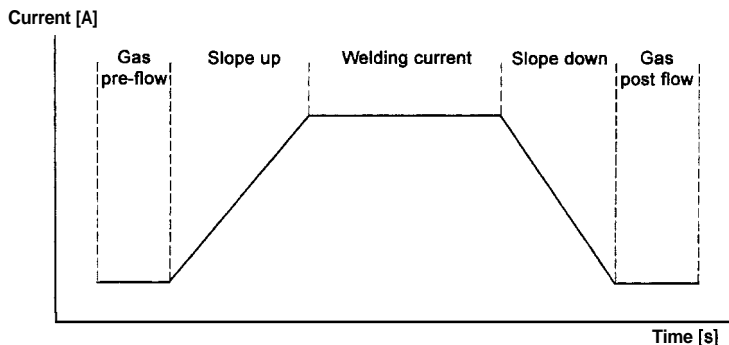


Figure 3.5 Example of a welding sequence.

## The electrode

The electrode material should provide a combination of the following characteristics:

- Low electrical resistance
- High melting point
- Good emission of electrons
- Good thermal conductivity.

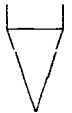
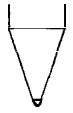


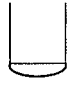
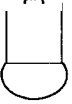
The material that best meets these requirements is tungsten.

TABLE 3.1 Examples of ISO 6848 TIG welding electrodes.

Additive	Proportion, %	Colour coding	Type	Current
	0	green	WP	AC
thorium	2	red	WT20	DC
zirconium	0.8	brown	WZ8	AC
lanthanum	1	black	WL10	AC, DC
cerium	2	grey	WC20	AC, DC

Pure tungsten electrodes are used when welding light metals with AC: for other welding applications, the electrodes often incorporate an admixture of 2 % thorium oxide, which improves the stability of the arc and makes it easier to strike. Thorium is radioactive, but is not so dangerous that special precautions are required, apart from taking care when grinding to avoid inhaling the grinding dust. Alternative non-radioactive oxide additives that can be used are those of zirconium, cerium or lanthanum, as shown in Table 3.1.

The electrode diameter is an important variable. The best arc stability is obtained with a high current load, which means that the diameter should be chosen so that the electrode tip is neither too hot nor too cold: see Figure 3.6.

Current type	Tungsten electrode	Current		
		Too low	Right	Too high
==	Thorium			
~	Pure tungsten			

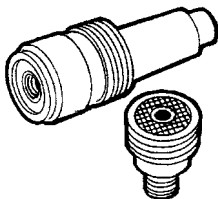
**Figure 3.6** TIG electrode tips, showing the effects of too high or too low welding current in relation to the electrode diameter.

For DC welding, the tip of the electrode is ground to an approximate  $45^\circ$  angle. The use of a special electrode grinding machine guarantees this angle is always the same, as this would otherwise affect the arc and its penetration into the workpiece material. Electrodes intended for use with AC welding are not ground: instead, the current is increased until it melts the tip of the electrode into a soft, rounded shape.



**Figure 3.7** Normally the tip of the electrode is ground to a length  $L = 1.5-2$  times the diameter ( $D$ ).

If the electrode has too long a stickout, i.e. if the distance between the gas cup and the tip of the electrode is too great, the protection provided by the shielding gas will be less effective. A 'gas lens' is a wire mesh inside the gas cup which reduces eddies in the gas flow, thus extending the length of the laminar flow of the gas without mixing it with air.



**Figure 3.8** Examples on gas lenses.

### 3.3 Consumables

Fillers for TIG welding are used in the form of a wire, which is fed into the joint either by hand or mechanically. Welding performance can be improved by using the hot wire

system, to feed the wire at an elevated temperature. Thin materials (up to 3–4 mm) can be butt-welded from one side, with the weld metal consisting entirely of molten work-piece material. Higher workpiece thicknesses require some form of joint preparation, with a filler being added in order to fill the joint. The use of fillers is always recommended when welding mild steel in order to reduce the risk of pores.

## Shielding gases for different workpiece materials

### *Steel*

Argon is generally used for TIG welding of unalloyed steels, low-alloyed steels and stainless steels. For mechanical welding of all these metals, the shielding gas may be argon, with an admixture of hydrogen or helium.

A small addition of nitrogen may be used when welding duplex stainless steels in order to ensure the correct ferritic/austenitic balance.

When making quality welds with TIG, it is also very common to use a **root** gas in order to protect the root side of the weld against oxidation. This is particularly important in the case of stainless steels or when welding easily-oxidised materials. The root gas is often a mixture of nitrogen/hydrogen, or pure argon.

### *Aluminium and its alloys*

The shielding gas for aluminium and aluminium alloys is usually argon, possibly with the addition of helium. Helium improves the heat transfer, and is used when welding thicker sections. The welding current is normally **AC** or, at low current levels, it may be **DC** with the electrode connected to the positive.

Under certain conditions, horizontal and horizontal-vertical welds can be welded with **DC** if pure helium is used as the shielding gas and the electrode is connected to the negative. The higher arc voltage that results from the use of helium supplies more heat to the base material and thus increases the rate of welding. This higher heat input also means that butt joints can be made in thicker sections. The open-circuit voltage of the power source should be sufficiently high to prevent the arc from being extinguished as a result of the higher voltage drop in pure helium.

The use of argon as the shielding gas improves oxide breakdown performance, arc stability and weld quality.

### *Copper and its alloys*

Argon is suitable for welding copper in all positions, and gives excellent results when welding metal thicknesses up to about 6 mm. The high thermal conductivity of the metal generally requires preheating.

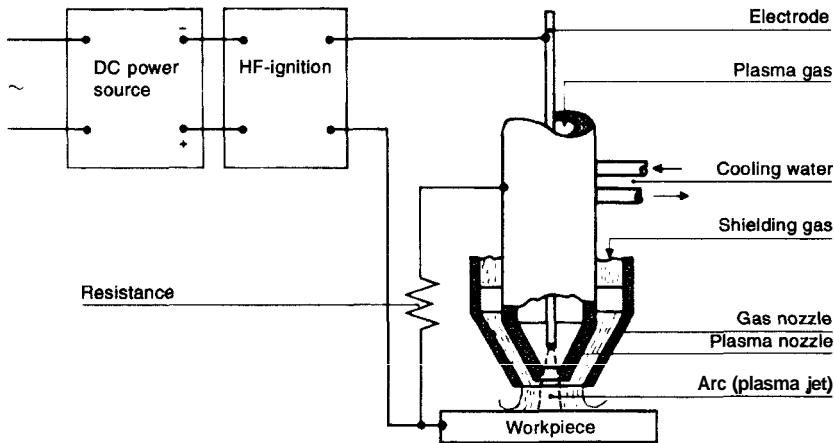
The best shielding gas for use when welding workpieces more than 6 mm thick is helium, or helium containing 35 % argon.

### *Titanium*

Successful titanium welding requires an extremely high purity of shielding gas, not less than **99.99%**. In addition, extra shielding gas is generally required. Either helium or argon can be used, although argon is generally preferred for metal thicknesses up to about 3 mm due to its higher density and good shielding performance. The use of pure helium is recommended when welding thick sections, due to the resulting higher heat content of the arc.

# 4 Plasma welding

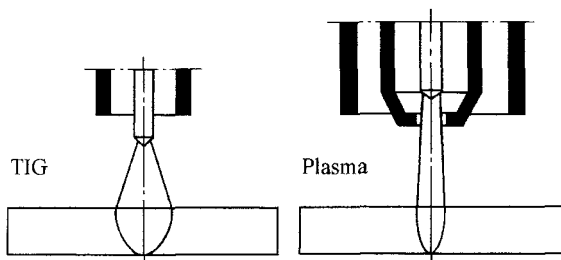
## 4.1 A description of the method



*Figure 4.1 Schematic diagram of plasma welding. Resistor R limits the current in the pilot arc which can be ignited also when the torch is apart from the workpiece.*

The plasma welding method employs an inner plasma gas and outer shielding gas, as shown in Figure 4.1. The plasma gas flows around a retracted centred electrode, which is usually made of tungsten. The shielding gas flows through the outer jet, serving the same purpose as in TIG welding.

A plasma arc is considerably straighter and more concentrated than, for example, a TIG arc, which means that the method is less sensitive to arc length variations: see Figure 4.2.



*Figure 4.2 The plasma arc is not as conical as the TIG arc, which means that it is much less sensitive to arc length variations.*

The plasma welding process can accept variations of 2–3 mm in the arc length without significantly altering the heat input to the workpiece. This is approximately ten times better than the corresponding value for TIG welding. However, because the arc



is narrower, more accurate transverse control is important, which means that the method is normally used in mechanised welding.

Characteristic features of the method include:

- the concentrated stable arc
- high welding speed
- insignificant deformation of the workpiece
- reliable arc ignition.

With the exception of magnesium, the method is suitable for welding the same materials as those that can be welded by TIG welding. Automated welding of stainless steel pipes is a major application area.

## Classification of plasma welding methods

There are three different classes of plasma welding, depending on the current range:

- *Micro plasma* (0.1–15 A). The concentrated arc enables it to remain stable down to a current of about 0.1 A, which means that the process can be used for welding metal thicknesses down to about 0.1 mm. This makes the process attractive to, for example, the space industry.
- *Medium plasma welding* (15–100 A). In this range, the method competes more directly with TIG welding. It is suitable for manual or mechanised welding and is used in applications such as the automotive industry for welding thin sheet materials without introducing distortion or unacceptable welded joints, as are produced by MIG welding, or for the welding of pipes in breweries or dairies.
- *Keyhole plasma welding* (>100 A). The third type of plasma welding is referred to as keyhole plasma welding, taking its name from the 'keyhole' that is produced when the joint edges in a butt weld are melted as the plasma jet cuts through them. As the jet is moved forward, the molten metal is pressed backwards, filling up the joint behind the jet.

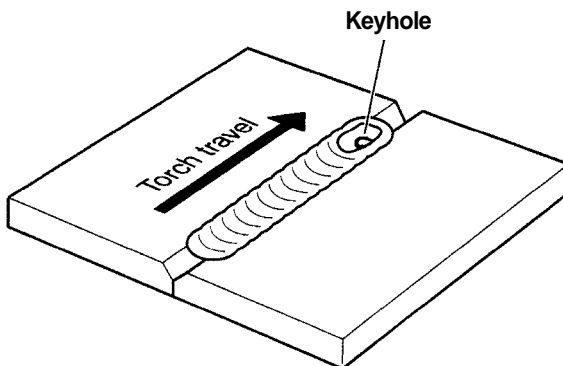


Figure 4.3 Keyhole welding.

The main benefits of plasma welding are to be found in the fact that the keyhole welding method can be used for butt welds from about 3 mm up to 7–8 mm. The keyhole

provides a guarantee of full penetration; by comparison the TIG method is only suitable for butt welds up to about 3-4mm thick. Joints with thicker materials have to be prepared with a V or U joint and then filled with filler material.

Keyhole welding is not suitable for thinner materials below 3 mm: in these circumstances, the process becomes much more like TIG welding. Reducing the plasma gas flow to a low level can make the plasma torch work in the same way as a conventional TIG torch, which can be useful when making tack welds or cladding welds. The main advantage over conventional TIG welding is primarily the excellent arc stability.

There are two types of working systems employed: with transferred and non-transferred arcs, as shown in Figure 4.4.

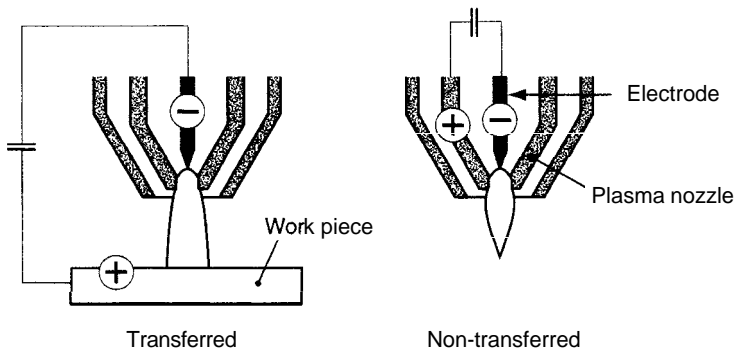


Figure 4.4 Transferred and non-transferred plasma welding arcs.

## 4.2 Equipment

The following equipment is required for plasma welding:

### *Welding torch*

The same basic requirements apply here as for TIG welding. Plasma welding torches are generally water-cooled.

### *Power source*

Plasma welding employs DC, with a drooping characteristic, as for TIG welding. Open circuit voltage should be at least 80 V.

### *HF generator*

In principle, the purpose of the HF generator is the same as in TIG welding. However, when used in plasma welding, the HF generator does not normally strike the main arc: instead, it strikes a pilot arc as a non-transferred arc, with the current flowing between the electrode and the inner gas nozzle. The pilot arc, in other words, can be maintained in air: as the torch approaches the work piece, the main arc strikes and the pilot arc is extinguished.

### *Control equipment*

The necessary control equipment depends on to what extent the welding process is mechanised. However, it is usual for the pre-flow and post-flow of the shielding gas, the

HF generator and the pilot arc, to be automatically controlled. There is often automatic control to ensure that the arc is struck in pure argon, after which the gas supply changes over to the particular gas that is being used.

### 4.3 Gases for plasma welding

Normally, the same gas is used for both the plasma and the shielding gas. This avoids variations in the plasma jet, which would otherwise be the case if two different gases or gas mixtures were being used.

An argon/hydrogen mixture is generally used as the plasma and shielding gas. However, hydrogen cannot be used as a constituent when welding mild steel or reactive metals such as zirconium or titanium.

Mixtures of argon/helium/nitrogen are used when welding duplex stainless steels, as these contain nitrogen in their alloying. Pure helium is not suitable, as the resulting high heat losses in the plasma gas will substantially reduce the life of the plasma torch.

Argon/helium mixtures result in a higher energy in the plasma jet at constant current. However, the mixture must contain at least 50 % helium if any significant difference is to be noted. On the other hand, mixtures containing more than 75 % helium have the same characteristics as pure helium. Pure argon, or argon/helium mixtures, are well suited to the welding of mild steel and reactive metals (titanium, aluminium, zirconium etc.), for which hydrogen or nitrogen cannot be used.

### 4.4 The advantages of the plasma method

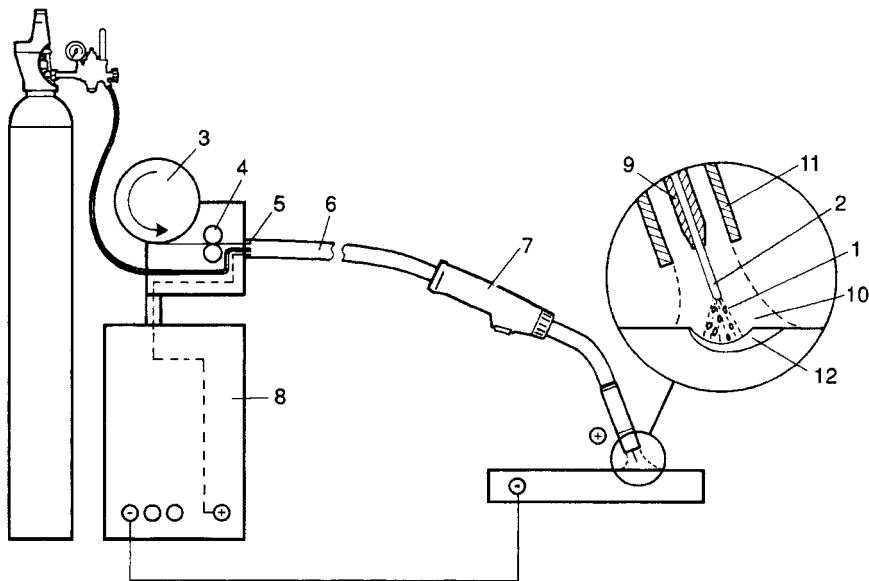
Plasma welding has the following advantages, relative to those of other methods:

1. Reliable penetration with the keyhole method.
2. Very high speed: often 400 % higher than that of conventional TIG welding.
3. Butt welds possible in thick materials (8 mm) without the use of fillers.
4. Fusion welding possible even in very thin materials (0.03 mm).
5. Low weld convexity and root bead. This is particularly beneficial when welding structures that will be subjected to fatigue loading, in addition to reducing the work required in other welds where the weld convexity and root bead would otherwise have to be ground away. Plasma welding of 5 mm austenitic stainless steel produces a weld convexity of about 0.3 mm and a root bead of about 0.2 mm. Increasing the steel thickness to 8 mm results in corresponding respective thicknesses of 0.7 mm and 0.6 mm.
6. Low heat-affected zone and little distortion.
7. High arc stability at low arc currents.
8. Little sensitivity to arc length variations as a result of the concentrated arc.
9. Assessment of the weld quality possible while welding is in progress.
10. High metallurgical quality in comparison with that of conventional TIG welded materials.
11. Flexibility, due to the ability to perform keyhole welding and melt-in welds using the same equipment.

# 5 MIG/MAG welding

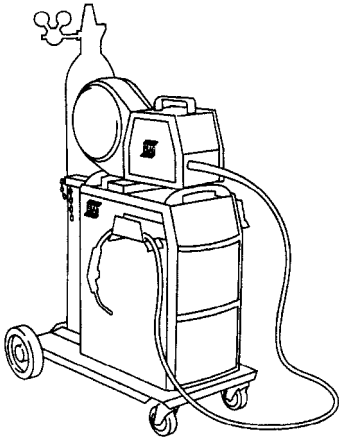
Until the 1970s, manual metal arc was the most dominant method of welding. Today MIG/MAG is the obvious leading contender in most industrial countries. Gas metal arc welding (GMAW) can also be referred to as MIG (metal inert gas) if the shielding gas is inert as for example argon or MAG (metal active gas) if the gas has a content of an active gas such as CO<sub>2</sub>.

## 5.1 Equipment



*Figure 5.1 The principle of MIG/MAG welding.*

Figure 5.1 shows the principle of MIG/MAG welding. The arc (1) is struck between the workpiece and a metal wire electrode (2) that is continually fed forward into the arc. The wire is supplied on a reel (3), and is fed to the welding gun by the drive rollers (4), which push the wire through a flexible conduit (5) in the hose package (6) to the gun (7). Electrical energy for the arc is passed to the electrode through the contact tube (9) in the welding gun. This contact tube is normally connected to the positive pole of the power source, and the workpiece to the negative pole. Striking the arc completes the circuit. The gas nozzle (11) that surrounds the contact tube (9) supplies shielding gas (10) for protection of the arc and the weld pool (12).

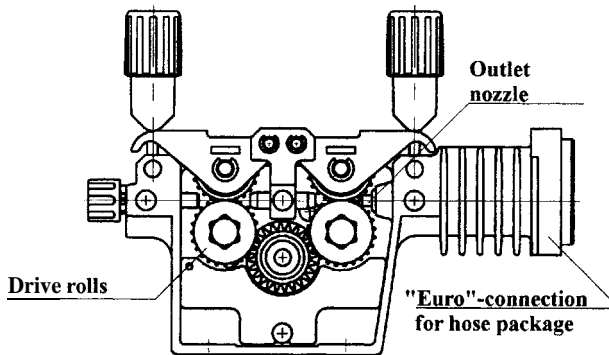


*Figure 5.2 Equipment for MIG/MAG welding (ESAB).*

## Wire feed unit

The wire reel is placed on a brake hub with adjustable friction. The intention is to stop rotation when the feeding has stopped in order to keep the wire in place.

The electrode is passed to the drive rolls, which then push the wire through the hose package. Even in normal use it is common for the friction to vary, e.g. when the curvature of the hose is changed or when particles or dirt fill up the wire conduit. The wire speed must not vary too much, otherwise this could result in unwanted variations in the welding data. Superior control of the wire feed speed can be achieved if the motor is equipped with a pulse-generator and feed back system.



*Figure 5.3 Heavy duty 4 drive roll assembly.*

The drive rolls have a trace that fits to the wire. Therefore it may be necessary to change the rolls when the wire is changed. The number of driven rolls influence the feeding force that can be achieved.

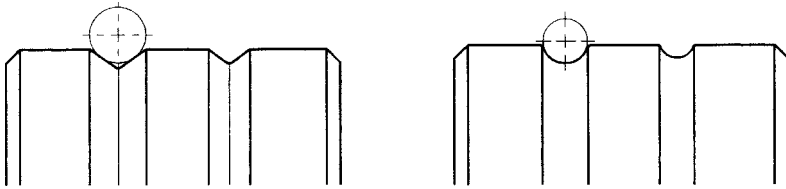


Figure 5.4 Drive rolls with different types of traces are used. For soft electrode material as aluminium, U-type traces are recommended.

## Welding gun and feeding properties

The welding gun with hose package, see Figure 5.5, is an essential part of the welding equipment. It brings the shielding gas, electrode and welding current to the arc. It is difficult to design a robust welding gun for this tough environment but at the same time make it small and light enough to be acceptable for working in narrow spaces.

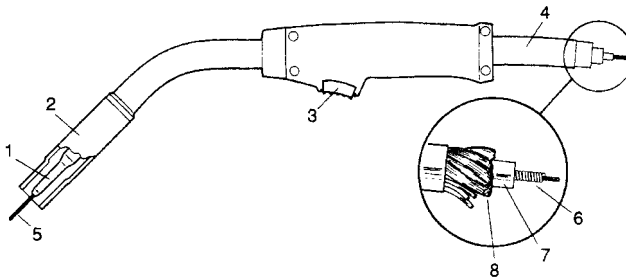


Figure 5.5 Welding gun with hose package. 1. Contact tube. 2. Shielding gas nozzle. 3. Trigger switch. 4. Hose package. 5. Electrode. 6. Flexible conduit. 7. Shielding gas hose. 8. Power cable.

Experience shows that careful maintenance is necessary to avoid disturbances that could occur from constant hot and heavy operation.

- At higher welding data the heat from the arc increases. It is important to choose the proper size of gun to avoid temperature overload.
- Keep the gun free from spatter. Spatter will catch easier to a hot surface.
- Use a water-cooled gun when necessary.
- Choose a proper wire extension. Too short distance will increase the risk for burn-back of the arc. That will also increase the heat take up from the arc.
- Carefully choose the clearance between wire and the diameter of conduit. Small clearance increases the risk for stoppage and too big will give irregular feeding.
- When feeding problems occur, the reason could be that metal particles from the wire have increased the friction in the conduit. Just to stretch the pressure between the feeder rolls is not always the best action. To avoid future problems it is recommended to blow it clean now and then.
- For the most critical usage, such as extra long hose package or the use of soft aluminium wires, a push-pull wire feeder is recommended, see Figure 5.6.

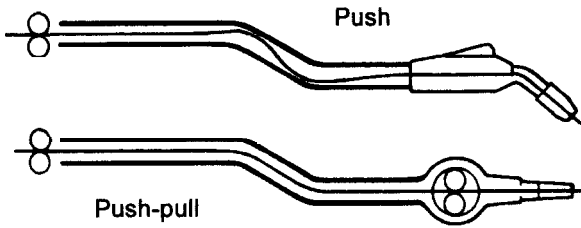


Figure 5.6 The difference between a push and push-pull wire feed system. In a push or pull wire system, friction is built up and increased in every curve of the conduit. This is avoided by the use of a push-pull system.

### Power source

DC power sources, with relatively straight characteristics, are used for MIG/MAG welding. See also the section about power sources: page 13.

*Controlled by a stepping switch.* Tap-changer rectifier units have been traditionally used, and are the most common type.

*Thyristor-controlled rectifier units* are larger and somewhat more advanced: the most advanced types are inverter power sources.

*Inverter power sources* have the most advanced design. In addition to their generally good characteristics and control facilities, inverters are often used for welding aluminium and stainless steel, which benefit from the use of pulsed MIG welding.

### Cooling units

Water-cooled welding torches are often used in the higher current range (300-500 A). Cooling water is circulated from a cooling unit, which may be separate or be incorporated in the power source. The water cools the copper conductor in the hose and cable bundle, the gas nozzle and the contact tip. Cooling units normally include a water container, a pump and a fan-cooled radiator.

## 5.2 Setting of welding parameters

The MIG/MAG welding process is dependent on a number of welding parameters:

- Electrode diameter
- Voltage
- Wire feed speed and current
- Welding speed
- Inductance
- Electrode stick-out
- Choice of shielding gas and gas flow rate
- Torch and joint position

Most of these parameters must be matched to each other for optimum welding performance. The *working point* must be within the working range or *tolerance box* for the particular welding situation.

## Electrode diameter

The size of electrode is chosen according to welding current, but in opposition to covered electrodes each electrode has a large and overlapping range of current. As a rule, the material transfer is smoother with a thinner electrode. When welding with soft aluminium wire, the risk of feeding problem can be reduced with a thicker electrode.

## Voltage

Increased voltage increases the arc length and gives a wider weld bead. Undercut is a sign of too high a voltage. If short arc welding is used a higher voltage reduces the short circuit frequency, which will give larger drops and more spatter.

Too low voltage, on the other hand, will increase the risk for stubbing and bad start performance.

On thin plates short arc welding gives the possibility of high welding speed without burn through. Normally the voltage here is adjusted to a low setting but only where the short circuit frequency is still high and the arc stability good.

## Wire feed speed and current

Current is set indirectly by the wire feed speed and diameter. Current is the main parameter for welding and has to be chosen to plate thickness and welding speed with respect to the weld quality.

## Welding speed

Welding speed has also a considerable effect on shape and penetration of the weld, see [Figure 7.6](#) on page 74.

## Inductance

It is often possible to adjust the inductance of the power source to fit the wire size and to give the right welding properties. The most sensitive is short arc welding. A low value gives a distinct and concentrated arc but the spatter will increase. A higher value gives a softer behaviour, a somewhat wider bead and a softer sound. Too high inductance gives bad stability with a tendency for stubbing.

## Electrode extension

Easiest to measure is the contact tip distance from the joint surface, (see [Figure 5.7](#)). A rule of thumb says that a normal distance is 10–15 x diameter of the electrode. Too small stick-out increases the risk of burn-back, where the arc will weld the electrode together with the contact tip. Too long a distance to the workpiece will increase the risk for stubbing, especially at the start.

The contact tip-to-work distance also has an influence on the current and penetration profile. If the electrode extension is increased the current and heat input decreases while the amount of deposited metal remains. This reduces the penetration, and if it was unintentional a risk for lack of fusion appears. A good rule is therefore to keep the wire stick-out constant during the welding operation.



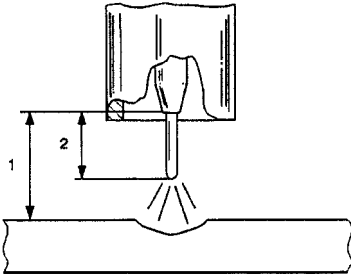


Figure 5.7 Definitions of contact tip-to-work distance (1) and electrode extension (2).

## Choice of shielding gas

Mixtures of argon with 5–20 % carbon dioxide ( $\text{CO}_2$ ) are most popular for the welding of *mild and low alloyed steels*. For spray and pulsed arc welding, a low content of  $\text{CO}_2$  can be an advantage. Pure  $\text{CO}_2$  is an alternative for short arc welding that gives good penetration and safety against lack of fusion but increases the amount of spatter.

For *stainless steels* argon is also used but with only small additions of  $\text{CO}_2$  or oxygen ( $\text{O}_2$ ).

For welding of *aluminium, copper and copper alloys* normally pure argon or argon helium mixtures are used. Helium increases the heat input, which will compensate for the large heat conduction in thick walled aluminium or copper.

## Gas flow rate

The gas flow must be adapted to the arc. At low current it can be enough with 10 litres per minute while at higher welding data up to 20 litres may be required. Welding in aluminium needs more gas than steel does.

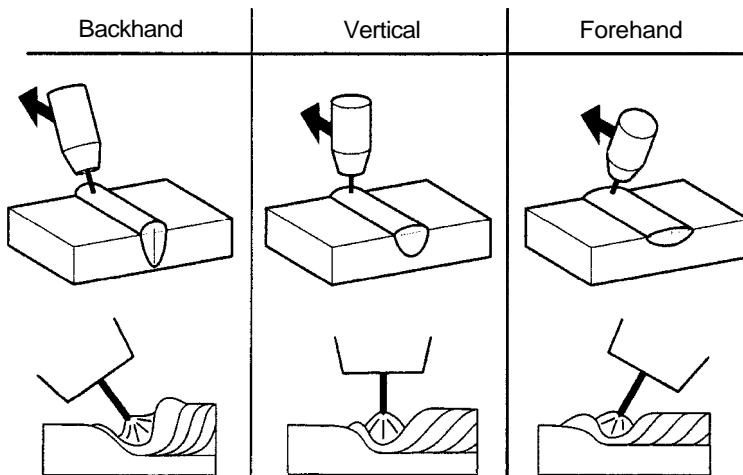


Figure 5.8 Effect of electrode position and welding technique.

## Torch and joint position

Angles of the torch relative to the joint are also an important welding parameter. If it's directed away from the finished part of the weld (*forehand technique*), it will make the penetration profile more shallow and the width of the seam wider, see Figure 5.8. On the other hand, if it's directed towards the finished part of the weld (*backhand technique*), the penetration will be deeper and the seam width narrower.

The angle of the torch in the section across the welding direction has a direct influence on the risk for lack of fusion. See Figure 5.9.

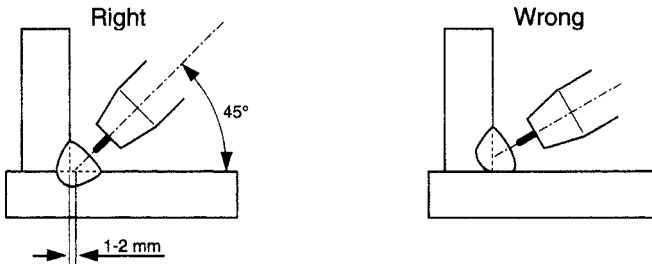


Figure 5.9 Gun angle and position across the welding direction at fillet welding. The electrode is on such thick plates often positioned 1–2 mm offset on the base plate. That will compensate for the higher heat dissipation in the base plate and gives a symmetrical penetration profile.

If the plate to be welded is not totally horizontal but has an inclined joint, it will affect the weld contour and penetration profile. By welding downhill, the weld reinforcement can be lower and the welding speed will usually increase. At the same time, the penetration is lower and weld bead wider. This is beneficial for welding sheet metal. Uphill welding causes the weld pool to flow back and form a high and narrow weld.

To reduce the risk of lack of fusion it is essential to prevent the melted metal from flowing too much before the arc. This can be the case when welding with high heat input, a large pool and welding with too much forehand or in downhill position.

Contact tip-to-work distance, (see Figure 5.7), should be kept constant when welding.

## 5.3 Consumables

MIG/MAG welding is used for mild steel, low alloyed and stainless steel, for aluminium, copper and copper alloys, and nickel and nickel alloys etc. Plate thicknesses down to 0.7 mm can be welded. There is no technical limitation upward, but the risk for cold laps at low heat input or oversized pool will increase. The filler material has often a chemical composition that is similar to that of the base material.

### Filler wires

The electrodes for MIG/MAG welding are available in the 0.6–2.4 mm range for use with many different types of materials. Wires are normally supplied on reels and wound to ensure that the wire does not snag when being withdrawn. Important factors are that it must be clean with a smooth finish to feed easily and free from metal flaws. Best feeding

performance have wires coated with a thin layer of copper. One important condition is that the copper is well fixed to the wire, if not, it will clog up the wire conduit and prevent smooth feeding of the wire.

To get the most effective performance from the arc, it is essential that the current will be transferred to the electrode close to the opening of the contact tip. To improve the contact force and to define the contact point the electrode is somewhat curved, i.e. it has a radius of 400–1200 mm, see Figure 5.10. The helix size should not exceed 25 mm, if problems with arc wandering are to be avoided.

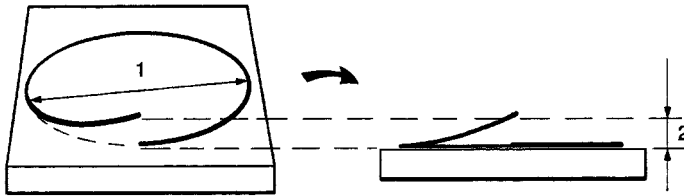


Figure 5.10 Checking cast diameter (1) and helix size (2).

The electrode is normally delivered on 10–15 kg coils (steel) but for large consumption a container of about 200 kg can be ordered.

### **Solid or cored wires?**

One can distinguish between solid wires and cored wires. The latter type consists of a metallic outer sheath, filled with flux or metal powder, as shown in Figure 5.11. The flux cored wires can have either a rutile or basic filling. They can also be self-shielded for use without shielding gas.

The cost per unit of cored wire is considerably higher than that of solid wires, but they are in some respects superior to solid wire. Cored wires are mainly used for somewhat thicker plates. High deposition rate and good side wall penetration characterise cored wire. Basic flux cored wires have similar performance to that of basic manual stick electrodes giving a tough and crack resistant weld metal.

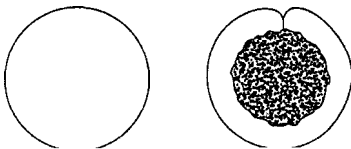


Figure 5.11 Cross section of solid and cored wire.

## **Welding technology**

The stability of a DC arc with a consumable electrode (i.e. a filler wire) depends largely on how the molten metal is transferred in the arc. One can distinguish essentially between two different types of arcs, depending on the material transport: the spray arc and the short arc (short-circuiting arc).

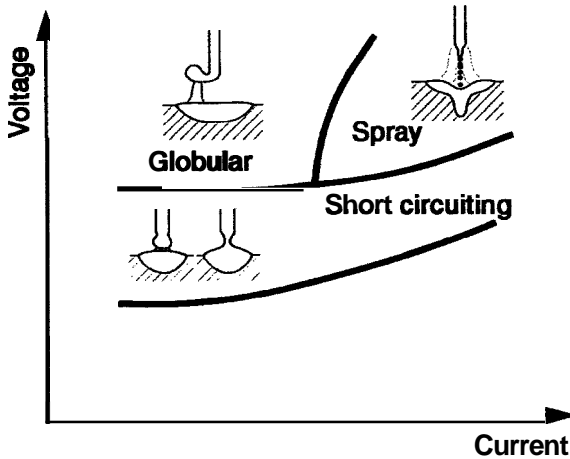


Figure 5.12 Arc types for different current and voltage conditions.

### Spray arc welding

Spray arcs are characterised by the transfer of molten material in the form of many small droplets, the diameter of which is less than that of the filler wire. As there are no short circuits, the arc is stable and spatter-free. A prerequisite for successful spray arc welding is that the values of current and voltage should be over certain limits. This, in turn, means that more heat is supplied to the workpiece than with short arc welding, and so only materials of 5 mm thick or more are suitable for spray arc welding. The high heat input means that the weld pool is also large, so welding has to be performed in the horizontal position. It should be noted that a pure spray arc cannot be obtained when using  $\text{CO}_2$  as the shielding gas: the shielding gas must be pure argon or (preferably) with a small proportion of  $\text{CO}_2$  (not more than 25 %) or  $\text{O}_2$ . Spray arc welding is particularly suitable for MIG welding of aluminium and stainless steel, for which the shielding gas is mainly argon.

With a thin filler wire, it is possible to perform successful spray arc welding at lower currents than with a thicker filler wire.

The arc voltage should be set at such a value that it is just sufficiently high to maintain a short-circuit-free arc. The filler wire is normally connected to the positive pole.

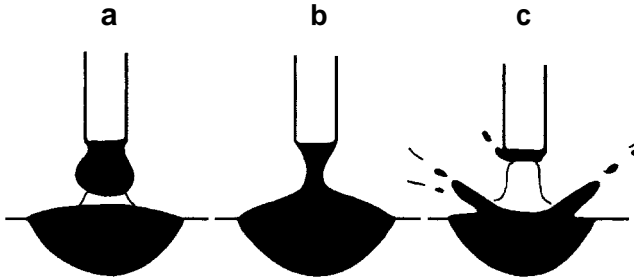
### Short arc welding

The heat input from short arc welding is low, which makes the process suitable for welding in thinner materials. The drops from the electrode dip into the weld pool. The arc is therefore periodically replaced by a short-circuiting bridge of molten metal.

This can be repeated up to 200 times per second. If the short-circuit current is too high, it has a considerable effect on the pinch-off forces, causing weld spatter. Some means of limiting the short-circuit current must therefore be provided in the power unit, e.g. through the use of an inductor coil.

It is not easy, with short-arc welding, to achieve a completely stable arc. The best way to judge if the welding is going well is by the noise of the arc. The objective is to

achieve a consistent, high short-circuiting frequency, resulting in small droplets being transferred to the workpiece and spatter droplets being so fine that they do not adhere to the workpiece. Good welding characteristics in the power source are necessary, although wire feed speed, current transfer in the contact tip and the welder's skills are also important.



*Figure 5.13 Droplet short-circuiting with a low inductance in the power unit. a) Arc period. b) Drop transfer. c) Low inductance setting gives high short circuit current and spatter is developed when the short circuit breaks..*

Ignition of the arc can also be sensitive, and therefore it is important that all parts of the equipment should be in good condition in order to avoid irritating chattering when striking the arc.

### **Globular transfer**

At currents lower than needed for spray transfer and with voltage above pure short arc welding there is a mixed region characterised with droplets larger than the electrode diameter and often with an irregular shape. The molten drop grows until it detaches by short-circuiting or by gravity. The globular transfer mode is most often avoided.

### **Pulsed MIG welding**

Pulsed arc welding is used mainly for welding aluminium and stainless steel, although it can also be used for welding ordinary carbon steel. The method of controlling the transfer of the droplets by current pulses (30–300 Hz) from the power source makes it possible to extend the spray arc range down to low welding data. The process provides a stable and spatter-free arc as a welcome alternative to short arc welding.

The pulses serve two purposes: supplying heat to melt the filler wire, and also to pinch off just one molten droplet for each pulse. This means that, as the wire feed speed increases, the pulse frequency must also increase. This will result in keeping the droplet volume constant at all times. A low background current contains the arc between the pulses. Although the current amplitude in each pulse is high, the average current – and thus the heat input to the joint – can be kept low.

Pulses from the power source pinch off the drops from the electrode at the same speed as the electrode is fed. Therefore it is possible to avoid short circuits and spatter generation. Whilst short arc welding is normally the most suitable method for thin sheet carbon steels, pulsed arc is often the best choice for stainless steels or aluminium. Modern electronic inverter power sources are able to calculate the pulse shape needed for the actual choice of electrode size, material and shielding gas and the pulse frequency needed to keep the arc length constant.

The stable and controlled drop transfer with pulsed arc allows the use of an increased electrode diameter. This is utilised in aluminium welding where the electrode is difficult to feed because of its softness.

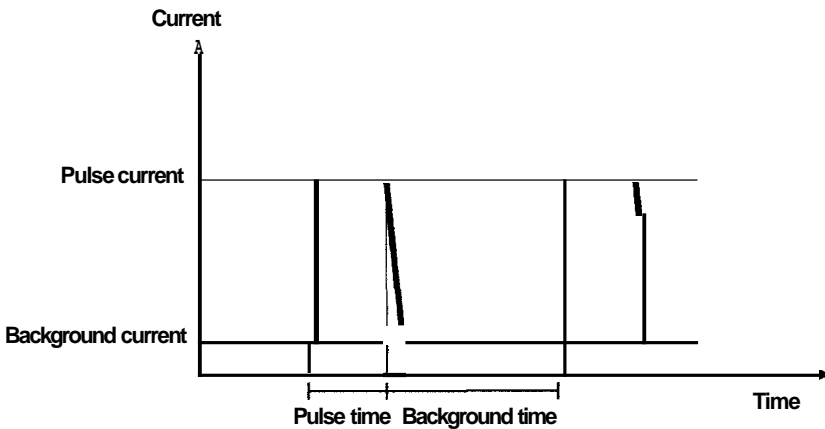


Figure 5.14 Naming of the pulse parameters.

### Advantages

- The process is fully controlled and spatter-free.
- The ability to extend spray arc welding down to lower welding data is particularly suitable when welding materials such as stainless steel or aluminium. It becomes possible to weld thin materials, or to perform positional welding, with better results than would be obtained with short arc welding.
- Pulsed arc welding is sometimes used within the normal spray arc range in order to provide better penetration into the material.
- Stable welding performance can also be achieved with a somewhat thicker filler wire. This is useful when welding aluminium, as it is difficult to feed thin filler wires due to their softness.
- Recent work indicates that the efficient droplet pinch-off reduces overheating of the droplets, resulting in less fume production.

### Disadvantages

- Production speed is generally lower than with short arc welding. The greater heat input, relative to that of short arc welding, reduces the maximum usable wire feed speed.
- Pulsed arc welding restricts the choice of shielding gases. As with spray arc welding, the CO<sub>2</sub> concentration of an argon/CO<sub>2</sub> mixture must not be too high: the usual 80/20 % gas mixture, as used for short arc welding, represents the limiting value.

Pulsed welding restricts the choice of shielding gases. As for spray arc welding, the CO<sub>2</sub> concentration in an Ar/CO<sub>2</sub> mixture must not be too high. Common 80/20 mixed gas, as used for short arc welding, represents a limit value.

## Cored wire welding

The use of flux cored arc welding (FCAW) appeared as early as the 1920s, although at that time it was only in connection with the application of wear-resistant cladding. It was easy to produce high-alloy filler materials by mixing the alloying constituents in powder form inside a cored unalloyed steel electrode.

There are today two main types of cored wires:

- Wires that require the use of shielding gas, usually CO<sub>2</sub> or Ar/CO<sub>2</sub> mixture.
- Wires that do not require additional shielding gas, known as self-shielded flux cored wires.

### Equipment

Essentially the same equipment is used for cored wire welding with shielding gas as for ordinary MIG/MAG welding. However, the welding torch, the wire feed unit and the power source all need to be more powerful due to the higher current density and the thicker wire. Welding is usually carried out using DC, with the filler wire connected to the positive pole. The power source characteristic is generally slightly drooping, which gives a self-regulating arc.

When carrying out cored wire welding without a shielding gas (self-shielding), the same power source and wire feed unit are usually used as would be used for welding with shielding gas. However, the welding torch can be simpler, as there is no need for a gas supply.

Fume is a problem when welding with high current, not least when using self-shielded **flux** cored wires. One solution to this problem is to use a welding torch with an integral extraction connection.

### Structure and characteristics of cored wires

A cored filler wire consists of an outer tube of unalloyed steel, filled with powder. The composition of this powder differs for different types of wires. The proportion of filler powder can also vary, depending on differences in the wall thickness.

We distinguish between *metal-cored arc welding* (MCAW) and *flux-cored arc welding* (FCAW) wires.

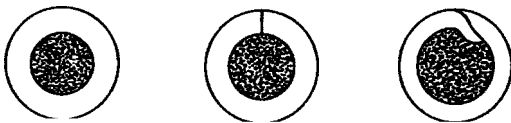


Figure 5.15 A section through different types of cored filler wires.

### The function of the powder fill

The powder fill affects the welding characteristics and the metallurgical analysis of the weld material. Wires can be optimised for a range of characteristics by varying the composition of the powder.

- Refining of the weld metal is achieved through the addition of anti-oxidising elements such as manganese or silicon.

- Slag-forming elements are added in order to protect the weld while it is solidifying, to control the shape of the weld metal and to improve positional welding performance.
- Arc-stabilising additives produce a stable, spatter-free arc.
- Alloying elements such as nickel, chromium, molybdenum and manganese can be incorporated in the powder in order to modify the mechanical and metallurgical properties of the weld.
- Adding metal powder alone produces a slag-free cored wire that has a higher productivity than a flux-cored wire.

The two slag systems used for cored wires are *basic* and *rutile*. The rutile type produces a spray arc, the best welding characteristics and the best positional welding performance. Today, rutile cored wires produce equally good mechanical properties as do basic cored wires, while at the same time producing little hydrogen entrapment in the weld metal. Typical hydrogen concentrations lie between 3 and 10 ml/100 g of weld metal.

The *metal powder-filled cored wires* contain a powder that consists mainly of iron and alloying elements. The only slag formed is in the form of small islands of silicon oxide. These wires have a high productivity in the horizontal position.

*Flux-cored wires* are best suited for positional welding, as the slag provides better control of the weld pool. In comparison with solid wires, cored wires are also regarded as producing somewhat less risk of poor fusion.

*Self-shielded flux cored wires* are filled with a powder that develops gases to protect the weld pool. This is done by means of appropriate additives which are gasified in the arc. The resulting substantial expansion excludes the surrounding air from the arc and weld pool.

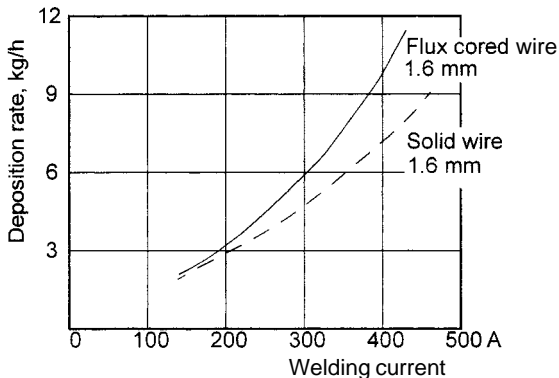


Figure 5.16 Deposition rate when welding carbon steel.

Cored wires are manufactured from 0.8 mm upwards in diameter, with the commonest sizes being 1.2, 1.4 and 1.6 mm. The range of weld metal grades is wide, and is constantly increasing. In particular, the range of cored filler wires for use with stainless steel has increased.

Welding speed is higher with cored wires than when using coated electrodes (MMA). As the current flows through the outer wall of the wire, current density is higher, with a correspondingly higher rate of melting of the metal.



## Applications

The use of cored wire electrodes is increasing in parallel with the introduction of new types of wire. They are used, for example, for:

- sheet thicknesses from 4 mm and upwards.
- both butt and fillet welds.
- manual welding in all positions.
- robot welding in the horizontal position.

*The benefits of cored filler wires are:*

- high deposition rate as a result of the high current density.
- ease of varying the alloying constituents.
- stabilising substances in the powder extend the range of usable welding data.
- basic electrodes are tolerant of contamination in the material, producing a tough, crack-resistant weld.
- better transverse penetration than with solid filler wires.

*The drawbacks of cored filler wires are:*

- Self-shielded wires produce relatively large quantities of fume.
- A higher price than for solid wires (does not necessarily mean a higher total cost).
- Troublesome thermal radiation at higher welding currents.
- Finishing work required when using slag-forming wires.

## High productivity gas metal arc welding with solid wires

### Single-wire methods

The productivity of mechanised MIG/MAG welding, using conventional solid filler wires, has constantly improved in recent years. One of the leaders in this development was Canadian John Church, who launched the TIME method (Transferred Ionized Molten Energy). Compared to conventional MAG welding, this method intentionally uses a long, high-current filler wire stickout. Resistive heating means that the wire is preheated, thus permitting a higher rate of feed without a corresponding increase in the current.

The TIME method includes a special patented 4-component shielding gas. The AGA and Linde welding companies have investigated the method, and further developed it for use with other gas mixtures, calling the resulting processes Rapid Processing™ and Linfast® respectively.

The higher feed speed results in a higher productivity: in some cases, at a rate of up to 20 kg/h of deposited weld metal. Linear welding speed can be twice that of conventional MIG welding, while producing the same appearance of the weld bead and penetration profile. Different types of arc are used: perhaps the commonest is a type of forced short arc that is within the range covered by conventional welding equipment.

Under certain conditions, a rotating arc is produced when welding at higher welding data. The high productivity, in combination with a higher current and larger weld pool, mean that welding must be carried out in the most favourable horizontal position.

Arc voltage  
50 V

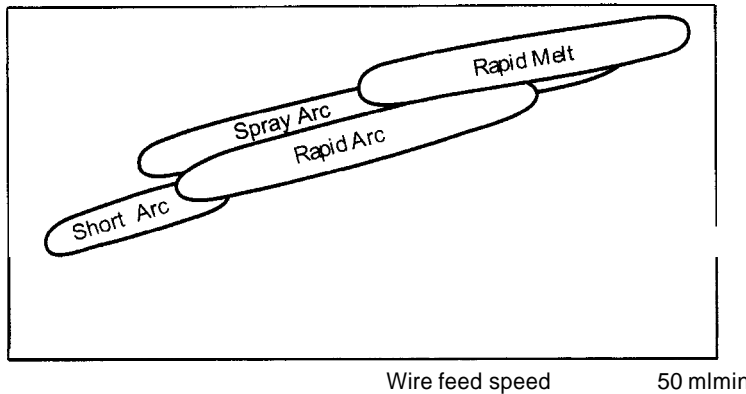


Figure 5.17 *Rapid Arc and Rapid Melt can be used with considerably higher welding data than with conventional short arc or spray arc welding. (Royal Institute of Technology, Department of Welding, Stockholm, Sweden.)*

### Tandem and twin wire welding

Another way of improving productivity and raising the welding speed is to use double filler wires. Both wires can be connected to the same power unit, which means that they share a common arc. This method goes under the name of Twin Arc. Alternatively, if two power units are used, the method is referred to as Tandem Welding. Nevertheless, the two wires are so close to each other they weld into a common weld pool.

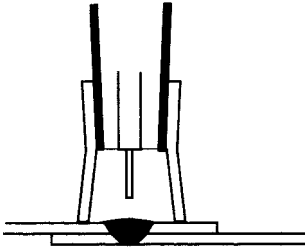
Welding with two wires can increase the speed to at least twice the normal value or, when welding thin sheet, even higher. In some applications, linear welding speed can be up to 6 m/min.

Setting the welding current and voltage can be much more complicated when two wires are used, particularly with tandem welding as it is necessary to set the welding data separately for each wire. Because the two arcs are close to each other, they can sometimes interfere through magnetic arc blow effect. Therefore this process often uses pulsed welding, with the pulses on each wire displaced out of phase with each other.

### Arc spot welding

This is a MIG/MAG method intended to produce spot welds. The welding torch has a gas nozzle with support legs, and the welding time is controlled by a timer. The resulting welds are often overlap joints, as produced by conventional resistance spot welding. However, in this case, the workpiece does not need to be accessible from both sides. The support legs provide the correct wire stickout, and also serve to some extent in pressing the two pieces of metal into contact with each other.

Welding data (voltage and wire feed) are considerably higher than what is usual for the particular metal thickness concerned. The welding time is controlled to produce a through-weld within a relatively short time, generally less than one second. This produces a low convexity with good coverage, without burning a hole in the upper piece of metal.



*Figure 5.18 Arc spot welding.*

In comparison with continuous welding, the process has the following advantages:

- Less heating and distortion.
- Very simple to operate: simply position and press.
- Lower, better-shaped convexity, particularly when welding thin sheet.

As the welding process is short but intensive, the method is less sensitive to welding position, imbalance in the metal thicknesses, gap width variations etc., and can therefore be used when such effects would otherwise make it difficult to produce successful continuous welds.

## The welding environment

As with other arc welding processes, the welder is exposed to various health risks. These include fumes and gases, as well as ultraviolet radiation from the arc. Spatter is not a particularly serious problem, as long as it is in the form of very small particles. Perhaps the commonest problem is that of minor burns from the radiation, or from some errant drop of molten metal. It can be difficult to work with high welding data during the summer, as welders need to wear full protective clothing. For manual welding, the maximum usable current, as determined by the amount of heat generated, is about 400–500 A.

MIG/MAG welding seldom gives rise to health problems, although it is important to be aware of the risks.

### Fumes and gases

On average, the fume produced by MIG/MAG welding is less than that produced by the use of coated electrodes. The fume consists of solid airborne particles, often metal oxides from the electrode or from any surface coating on the workpiece. Oil fume is also formed if the workpiece is oily or greasy.

The normal protective measures consist of good ventilation, preferably in the form of local extraction immediately above the weld, and attempting to avoid breathing in direct fume from the weld. Particular care should be taken in certain cases:

- If unusually large amounts of fume are produced. Cored wire containing flux, and being welded with high welding data, can produce substantial quantities of fume.

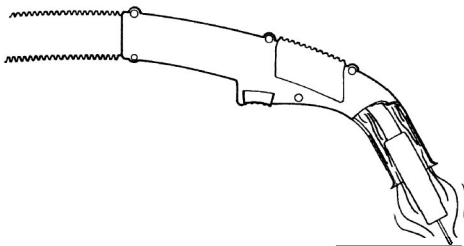
- Ozone is formed for example when MIG welding aluminium at high currents and with a high-radiancy arc. Note, however, that shielding gases are available that actively help to break down the ozone. Avoid welding in the presence of chlorinated hydrocarbon solvents (e.g. trichlorethylene): a chemical reaction can produce phosgene, which is poisonous and damages the lungs.
- The fume from aluminium can cause damage to the nervous system.
- The fume produced when welding **stainless** steel contains chromium or nickel. A low hygienic limit is set for this fume, as it is a cancer risk.
- The use of CO<sub>2</sub> as the shielding gas can produce carbon monoxide which, under unfavourable circumstances, can reach health-hazardous levels.
- Welding galvanised steel produces substantial quantities of fume due to the low boiling point of the zinc. Inhalation of this fume can cause an ague-like response.

In these situations, and also when welding in **confined spaces** where there is **insufficient** ventilation, it can be appropriate to use a fresh air breathing mask.



**Figure 5.19** When welding in confined spaces where there is a risk that the concentration of fumes and gases could be too high, the welder must use breathing protection with a supply of clean air.

Welding torches with integral extraction can remove most of the fume before it reaches the surrounding air. The position of the extraction nozzle should be adjustable, in order to avoid interfering with the shielding gas.



**Figure 5.20** Welding torch with integral fume extraction.

**Noise**

Short arc welding is relatively noisy, producing noise levels up to 80 dB. Welding is often also accompanied by noisy grinding work in the vicinity. By using a suitable welding process, shielding gas and welding technique that minimises grinding and slag removal, the noise problem can be reduced.

**Arc radiation**

The arc is a strong source of radiation in the infrared, visible and ultraviolet ranges of the spectrum. Special protective glasses must be used for the eyes, and all skin should be protected by fully-covered clothing.

*Arc eye (Flash)* is a strongly irritating inflammation of the cornea of the eye, caused by ultraviolet radiation.

As an alternative to ordinary protective goggles, there are welding helmets with liquid crystal screens that sense ultraviolet radiation and switch extremely rapidly between clear and opaque.

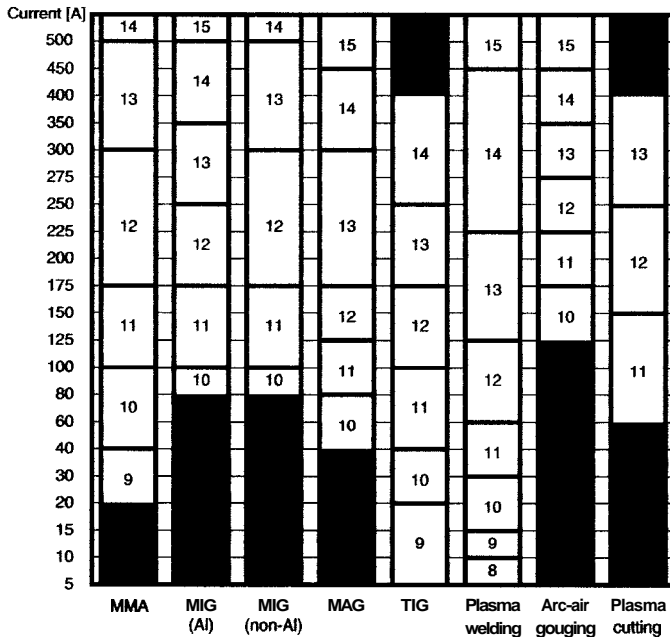


Figure 5.21 Recommended filter shade levels for protective glass filters. More detailed information is given in the standard EN 169.

**Ergonomics**

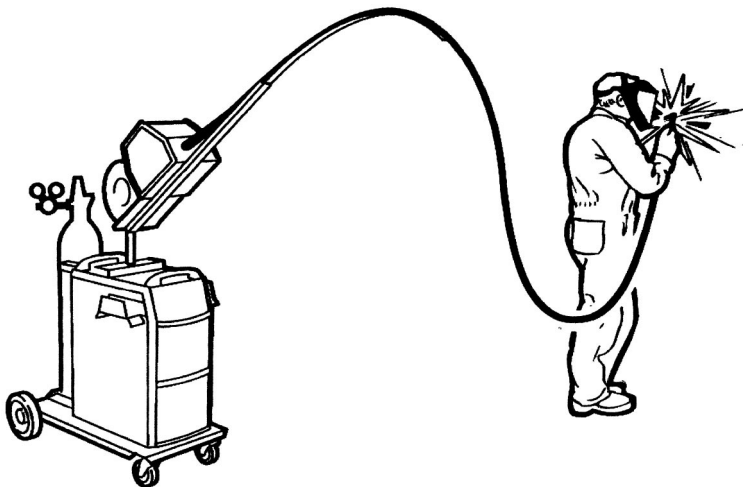
Welding thicker, heavier and/or larger parts manually and during assembly welding involves more static loading on the welder. The welding times are longer and the weight of the equipment is greater. In addition, the working position in this case is dependent on the position of the weld joint. Working with the hands in a high position at or above shoulder level should be avoided whenever possible. Overhead welding is unsuitable from an ergonomic angle.

Welding small items in fixtures is **often** characterised by many short welds, with monotonous, unchanging movements between them. When planning a workplace, the working height plays an important part in creating the correct **working** position. In this context, positioners and lifting tables can be very useful. The **working** position is partly determined by the welder's need to have **his/her** eyes close to the workpiece to be able to see the molten pool clearly while welding. If the working height is too low, the welder has to bend to see properly. A chair or stool might then be very useful. It is also a good thing if the workpiece is placed in a positioner and is positioned to ensure the best accessibility and height (Figure 5.22). A more comfortable working position can be created and, at the same time, welding can be facilitated **as** the joint is in the best welding position.



*Figure 5.22 A positioner for the workpiece.*

In conjunction with heavier welding, the gun and hoses are also heavier. A counterbalance support can provide valuable help in this situation. **Lifting** the hoses off the floor also protects them **from** wear and tear, as well **as** facilitating wire feed.



*Figure 5.23 A counterbalance arm reduces the weight of the hose bundle over the entire working area.*

## Spatter

In some cases, the spatter produced by welding can cause discomfort and even burns. The risks increase in connection with overhead welding or if the welding is performed in confined spaces. Spatter can be reduced by using the correct welding parameters and an appropriate shielding gas with a high argon content. Fine spatter is normally fairly harmless. To avoid these problems, it is important to use fully-fitting clothing and clothing made of suitable heat-resistant material.

## 5.4 Weld quality

Welded constructions may be vehicles, pressure vessels, cranes, bridges and others. It is an important task to ensure the welding quality. Quality systems are specified in standards. They include tasks and responsibilities for the welding coordination (EN 719), approval testing of welders (EN 287) and specification and approval of welding procedures (EN 288).

The reader will be introduced shortly to the work that has to be done before and after welding to ensure overall quality. The most common imperfections in welds are also described together with the most common causes on why they occur.

### Joint preparation

Before commencement of welding, the joint surfaces and area around the weld should be cleaned. Moisture, dirt, oxides, rust and other impurities can cause defective welds. Stainless steels and aluminium needs special care.

Aluminium joints have to be cleaned by degreasing with alcohol or acetone. The oxide must be removed by a stainless steel brush or other ways. Welding must to be carried out in conjunction with cleaning before new oxide builds up.

High quality stainless steel joints need to be cleaned in a similar way. Tools and brushes must be made of stainless steel.

### Striking the arc

The normal procedure for striking the MIG/MAG welding arc is for the gas supply, the wire feed unit and the power unit all to be started before the welder presses the trigger switch on the welding torch. This is also the method that is generally preferred in most cases, as it results in the quickest start. However, problems can arise: for example, the wire may hit the joint, or there may be one or more false starts before a weld pool is created and the welding stabilises.

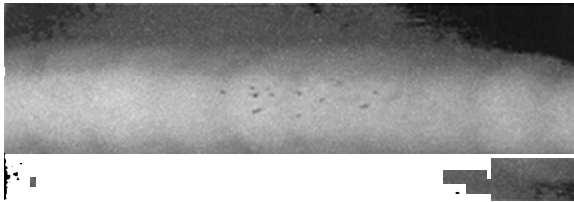
*Creep starting* provides a gentler start. The wire is fed forward at reduced wire feed speed until electrical contact is established with the workpiece, after which the wire feed speed increases to the set value.

Sputtering during starting is a problem that can occur from a number of causes. The tendency to sputter increases if the inductance is high and the voltage is low. Welding data that may operate satisfactorily once welding has started is perhaps less suitable when starting to weld.

*Gas pre-flow* is used when welding sensitive materials, such as aluminium or stainless steel. The gas flow starts a short (and adjustable) time before the arc is struck. The function ensures that there is proper gas protection of the workpiece before welding starts. Note, however, that if the gas hose between the gas bottle and the wire feeder is

long, it can act as a 'store' for compressed gas, which is then released as an uncontrolled puff of gas when the gas valve opens, involving a risk of creating turbulence around the weld, with reduced protection from the gas. However, a gas-saving valve is available as an accessory, reducing the pressure from the gas bottle and thus eliminating the risk of a puff of gas. The gas pre-flow function will also eliminate this problem because the puff is rather short.

The **hot start** facility increases the wire feed speed and arc voltage for a controllable time during the start of welding. It reduces the risk of poor fusion at the **start**, before full heat inflow has become established.



*Figure 5.24 X-ray picture of an aluminium weld containing pores.*

## Pores

Pores in the weld metal **are often** caused by some disturbance in the gas shield, but there are also different reasons.

- Wrong setting of gas flow. The flow must be enough; it should be adjusted according to the welding current. Too high amount of gas will cause problems with turbulence in the gas nozzle.
- Draught in the place of welding. **Air speed** above 0.5 m/s can interfere with the gas stream from the gun (somewhat depending on the setting of the gas flow).
- Defect equipment. Clogged channels or leakage can prevent the gas from flowing. Control if possible by measuring direct on the opening of the gas nozzle. Clean the inside of the nozzle regularly **from** spatter.
- The joint surfaces **are** contaminated with oil, **rust** or painting.

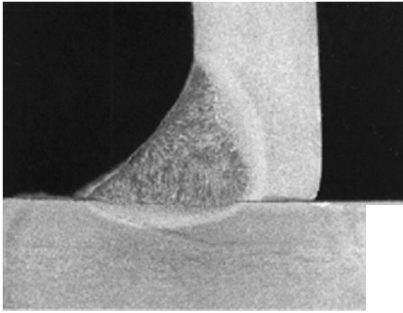
## Lack of fusion

Problems with lack of fusion between weld and parent metal have different reasons.

- Incorrect setting. Low voltage or long electrode stick-out will result in welding where the added heat is not in proportion to the amount of filler material.
- If the melted metal in the pool tends to flow before the arc. This can be caused if the weld is sloping, and if the welding torch is not properly aligned with the direction of the weld. The problem will also be worse if there is a large weld pool as a result of high heat input and slow travel speed of the welding torch.
- The large thermal dissipation at thick workpieces.
- **Unfavourable** geometry or too narrow joint angle.



- The **arc** is directed in the wrong way (misalignment) and one edge of the joint is heated **insufficiently**.

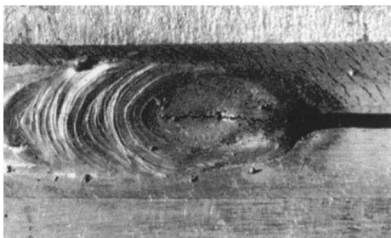


*Figure 5.25 Example of a fillet weld with lack of fusion against the base plate.*

## End craters

End craters arise as a result of direct interruption in welding. This allows a crack or crater to form in the final part of the metal to **solidify**, as a result of shrinkage forces during solidification. When grains from opposite sides grow together, low melting-point constituents and impurities can be swept ahead of the solidification front to form a line of weakness in the centre of the weld.

The **crater filling** function available in advanced power sources can be used to avoid the creation of craters when welds are finished. The arc continues to provide a reduced heat input while the weld pool solidifies. This has the effect of modifying the solidification process so that the final part of the weld pool solidifies at the top, thus avoiding the formation of a crater.



*Figure 5.26 A crack may appear as an effect of direct interruption of the welding.*

## Post weld treatment

The corrosion resistance of stainless steels is degraded if oxides from welding remain. Special root gas is used to avoid oxidation and chemical and mechanical post weld treatment has to be done.

# 6 Metal arc welding with coated electrodes

## 6.1 Description of the method

Manual Metal Arc welding (MMA) is often referred to as Shielded Metal Arc Welding (SMAW) or stick electrode welding. It was the predominant form of fusion welding until the beginning of the 1980s. Electrode rods consist of a wire core with an external coating. They are made in a range of core diameters, with each diameter being intended for a particular current range. Welding involves striking an arc between the electrode and the workpiece, with the heat of the arc melting the electrode (i.e. the filler material), and with the coating melting to form a protective slag.

The equipment required is simple, as shown in Figure 6.1, which means that the method is straightforward to use. It is particularly suitable for jobs such as the erection of structures. It can also be used outdoors, as opposed to other methods requiring shielding gas, which are unsuitable in wind. However, its arc time factor is relatively low, due to the time required for chipping away slag after welding and changing the electrodes.

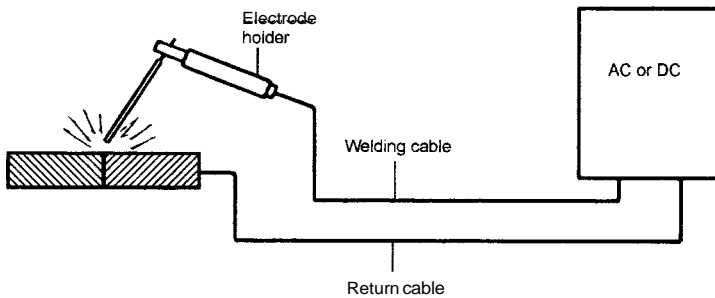


Figure 6.1 Schematic diagram of manual metal arc welding.

## 6.2 Equipment

### Power sources

When welding with coated electrodes, the required current is set at the power source. The welding current must be kept within certain limits even though the arc length may vary. The short-circuit current should not be more than about 60 % higher than the current setting, in order to avoid spatter from the short-circuiting of the arc caused by the droplets of molten metal in it. On the other hand, too low a rise in current can result in the electrode 'freezing' to the work. These requirements mean that the power source should have a drooping load characteristic.

Power sources for MMA welding do not need to have as high an intermittence factor as those for more mechanised methods: a normal value is 35 %.

MMA welding can be performed using either DC or AC, which means that all types of power sources can be used. The advantages of using AC are that the power source is simple, and there is reduced magnetic arc blow effect on the arc. However, AC-welding

restricts the choice of type of electrode and necessitates the power source providing a sufficiently high open-circuit voltage, of at least 50 V or preferably more.

## Potential for mechanisation

Mechanisation is possible using what is known as *gravity arc welding*, which involves securing the electrode and feeding it along the joint by a mechanical electrode feeder frame (Figure 6.2). In this way, a single welder can keep 3–5 arcs burning at the same time. With correctly set welding parameters, the use of this cheap and simple equipment enables one welder to make 280–400 m of fillet welds in an 8-hour working day. Such a productivity level is difficult to achieve with any other types of welding equipment in a similar price class.

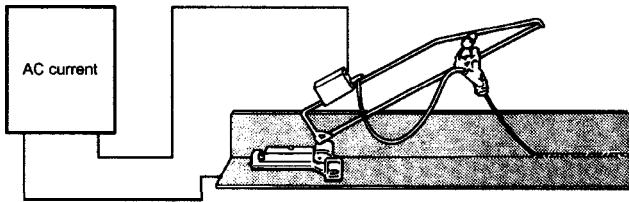


Figure 6.2 Gravity arc welding equipment for 700 mm long electrodes.

## 6.3 Electrodes

A wide selection of electrodes is available, to meet most requirements. The coatings consist of various mixtures of finely powdered chemicals and minerals, held together by a suitable binder.

The coating performs a number of important functions, including:

- *protecting* the metal droplets and the weld pool against reactions with the air, provided by the molten slag and the gases developed from the coating.
- improving the *stability of the arc*. Without arc-stabilising substances in the coating, the arc would be difficult to control and would produce excessive spatter. It would also extinguish easily, particularly when welding with AC. Arc-stabilising or ionising substances include titanium, zirconium and magnesium.
- *shaping* the upper surface of the weld and facilitating *removal of the hardened slag*. The use of coated electrodes produces a layer of slag on top of the joint that has to be removed after welding. This requires the use of a chipping hammer or wire brush, and can be easier or harder, depending on the type of electrode coating.
- *applying alloying and/or anti-oxidising substances* to the weld pool. The coating may also contain iron powder in order to improve the yield.
- providing sufficient *penetration* into the base material while welding. Penetration is determined by materials that can release a significant quantity of hot gas, such as carbonates or cellulose compounds.

Electrodes are divided into three groups, depending on the chemical composition of the slag: **acid**, **basic** and **rutile**.

## Acid electrodes

The coating of acid electrodes includes iron and manganese oxides. Acid electrodes produce smooth, shiny weld beads, with the slag solidifying slowly, being porous and easy to remove. The weld metal has a lower yield strength and ultimate tensile strength than that produced by rutile and basic electrodes, but a higher rupture strain. Although electrodes of this type were previously the most commonly used, nowadays they have only a small market share.

## Rutile electrodes

The coating of rutile electrodes contains large quantities (about 25-45 %) of the mineral rutile ( $\text{TiO}_2$ ). Electrodes of this type produce an arc that is easy to strike and re-strike. They are very easy to use and produce neat welds with an easily removable slag. Unfortunately, they also produce a higher hydrogen content in the weld metal, which introduces the risk of hydrogen embrittlement and cracking and restricts their use to welding carbon steel having a minimum ultimate tensile strength less than 300 MPa.

There are two categories of rutile electrodes. The first has a lower proportion of cellulose constituents and a somewhat thicker coating, which produces a greater quantity of slag. These electrodes are intended primarily for horizontal welding, producing an almost spatter-free arc. The surface of the weld is smooth, and somewhat concave, but with good symmetry and uniformity.

The second category has a thinner coating, which produces a more rapid solidifying slag, with a more intensive arc due to the inclusion of a larger quantity of gas-forming substances. Electrodes of this type can be used for horizontal, vertical or overhead welding. Penetration is somewhat deeper, and the quantity of slag is less. Horizontal welds are flat to slightly convex, while downward vertical welds are concave.

## Basic electrodes

Basic electrodes contain calcium fluoride (fluorspar –  $\text{CaF}_2$ ) in the coating. The slag reacts as a base, thus leaving low sulphur and oxygen contents in the weld metal. The strength and toughness of the weld are therefore the strongest of those welds produced by any type of electrode, and the resistance to hot cracking is also higher. Basic electrodes produce a slag having a lower melting point than that from rutile and acid electrodes, which means that the risk of slag inclusions is slight, even if the slag has not been completely removed between passes. They are well suited for positional welding in all positions.

Due to the very high temperatures involved (up to  $500^\circ\text{C}$ ) in the manufacture of electrodes, the moisture content of the coating is low when the electrodes are supplied. As a result, the hydrogen content in basic weld metals is low, thus providing good cold cracking performance.

Basic electrodes are, however, hygroscopic, which means that they must be stored in dry conditions. When delivered, they are normally packed in special diffusion-proof wrappings. Every welder should have access to a pouch, in which the electrodes can be kept at a temperature of  $50\text{--}80^\circ\text{C}$  throughout the working period. At the end of the day, the pouch can be emptied, and unused electrodes stored in an oven at a temperature of about  $150^\circ\text{C}$ .

The disadvantage of basic electrodes is that they produce a somewhat coarser and rougher weld surface, generally of a convex shape.

## Cellulose electrodes

The coating of cellulose electrodes contains a relatively high proportion of cellulose substances, intended to produce excellent penetration by providing a high hydrogen content in the arc when welding in any position. These electrodes are used exclusively for welding oil or natural gas pipes. The coatings have a high moisture content and because the resulting weld metal contains a high dissolved hydrogen content, it is necessary to employ special methods of welding and to operate at elevated temperatures of 100–250°C even when welding relatively thin materials (>8–10 mm).

## Penetration electrodes

Penetration electrodes are coated with a thick mixed rutile/acid coating, containing a high proportion of cellulose substances. They produce substantial gas emissions, that increase the arc penetration in the underlying base material. These electrodes are used only in the horizontal position and for welding I-joints (square butt joints).

TABLE 3.2 *Factors influencing the choice of welding electrode.*

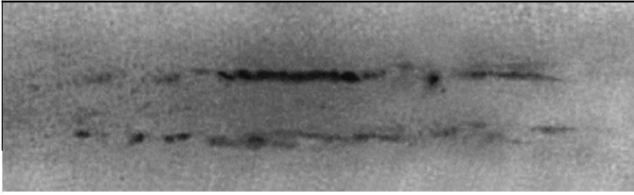
Factor	Rutile electrode	Acid electrode	Basic electrode
Arc stability	++	+	
Appearance of the weld bead	+	++	
Striking the arc	++	+	
Strength of the weld			++
Different welding positions	+	--	++
Risk of slag inclusions			++
Resistance to corrosion	+	+	
Fume formation	++	+	
Slag removal	+	++	
Hydrogen inclusion in the weld			++

## High-yield electrodes

The productivity (the yield) of an electrode can be substantially improved by mixing iron powder with the coating. The resulting weld metal is produced both by the core electrode wire and the iron powder.

One can distinguish between normal-yield electrodes, having a yield of up to about 130 %, and high-yield electrodes, which have a yield in excess of 130 %, often up to 150–250 %.

## 6.4 Weld defects

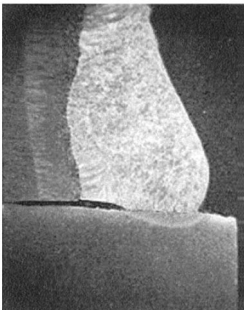


*Figure 6.3 X-ray film showing slag inclusions.*

### Slag inclusions

The most common cause of slag inclusions is failure completely to remove the slag from one weld pass before making another. The inclusions may be in the form of individual particles or longer lines. Good working methods can reduce the risks.

- Slag should be **carefully** and thoroughly removed. Slag particles tend to be caught in hollows and sharp angles.
- Use the correct welding method. Avoid the use of excessively thick electrodes in confined joints. Try to weld in such a way as to avoid undercutting.



*Figure 6.4 Poor penetration gives a root defect.*

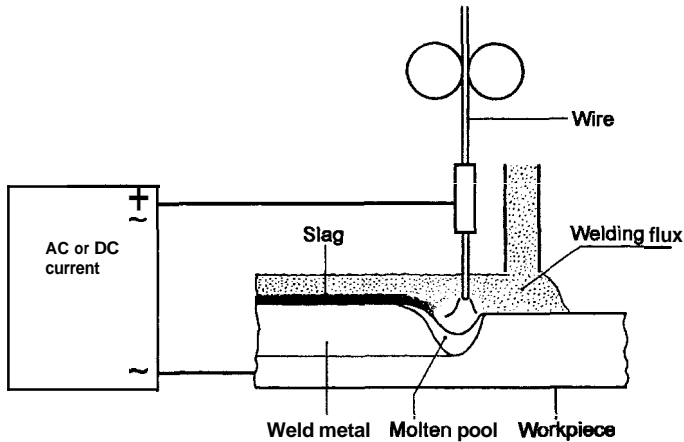
### Poor penetration

A common form of root defect or poor penetration is that caused by insufficient penetration or the presence of slag residues in the root. It can be particularly difficult to achieve full penetration when restarting after replacing an electrode, and conditions are made more difficult by an uneven gap or joint shape. In such cases, it is often necessary to grind or chip the root side of the weld and to re-weld.

# 7 Submerged arc welding

## 7.1 Description

Submerged arc welding, SAW, (Figure 7.1) is a high-productivity method of welding, generally carried out using mechanical welding methods and suitable for use with 1–3 continuous wire electrodes.



*Figure 7.1 Schematic diagram of submerged arc welding.*

The arc or arcs are struck and burn beneath a layer of flux, which is supplied to the welding head whilst the welding is in progress. The flux closest to the arc melts and forms slag on the surface of the weld, thus protecting the molten metal from reacting with the oxygen and nitrogen in the air. Residual powder is sucked up, returned to the flux hopper and re-used.

Welding can be carried out with DC or AC.

If the welding parameters are properly set, the appearance of the weld is often very uniform and bright, merging smoothly into the workpiece material. The slag also usually comes away by itself.

The flux masks the light from the arc and there is no smoke or spatter from the weld. This improves working conditions as compared to that of gas metal-arc welding. On the other hand, there is still the need to handle the flux: although its supply to the weld and subsequent recovery are mechanised, it is still a complicating factor.

The advantages of the submerged arc welding method are

- A high deposition rate  
Deep penetration, which allows the quantity of filler material to be reduced
- The ability to achieve a high arc time factor (i.e. effective welding time)
- High weld quality
- Improved working environment compared to other arc welding methods.

Submerged arc welding is used mainly for large items, such as plates in shipyards, longitudinal welding of large tubes or beams, or large cylindrical vessels. The method is used for both butt welds and fillet welds. Another application area is that of cladding, e.g. stainless steel onto ordinary carbon steel, or when applying a coating of some hard wear-resistant material. These processes often use strip electrodes.

## 7.2 Equipment

The welding equipment consists of a wire feed unit, in the form of a drive motor, reduction gear and feed rollers, which feeds the wire from the wire spool to a contact device, preferably with spring-loaded contact pads. The flux is supplied to the weld from a flux container, and is often recovered after the weld by a suction unit which sucks up the surplus flux and returns it to the flux container.

Travel is normally **mechanised**, although there are welding torches intended for semi automatic submerged arc welding. The power source, **wire** feed speed and linear travel speed are all automatically controlled.

### Power sources

Power sources for submerged arc welding may have either straight or drooping characteristics. A straight characteristic provides good self-regulation of the arc length. The wire feed speed is sometimes also controlled, which is done by sensing the arc voltage and adjusting the wire feed speed to maintain a constant arc length. This method can be suitable for use with thick wires and in combination with power units having a drooping characteristic, in order to reduce current variations.

Power sources for submerged arc welding are designed for high current and duty cycles, e.g. 800–1600 A, 44 V and 100 % duty cycle. Both AC and DC welding may be used.

One type of AC welding current power source uses thyristors to produce a square wave. This is a relatively simple and satisfactory way of controlling single-phase AC without interrupting the welding current and extinguishing the arc. If the welding cables are long, it is a good idea to run the supply and return cables close together. This reduces the inductive voltage drop, assists the fast zero transitions and avoids the unnecessary creation of magnetic fields around the cables.

### Arc striking methods

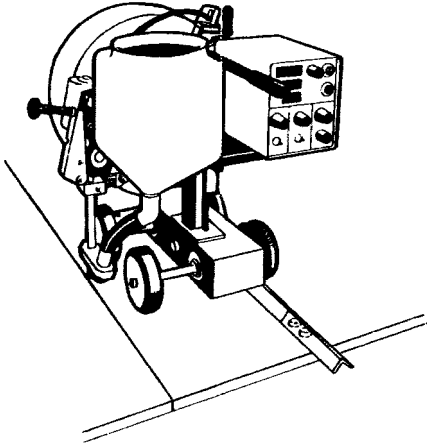
It can sometimes be difficult to strike the arc if the power source has a low short-circuit current (drooping characteristic). Other causes can be slag on the electrode wire, or flux between the wire and the workpiece. There are many ways of assisting striking, of which the most common is to cut the wire, preferably to produce a sharp point.

### Mechanisation aids

Equipment used for the longitudinal travel motion includes

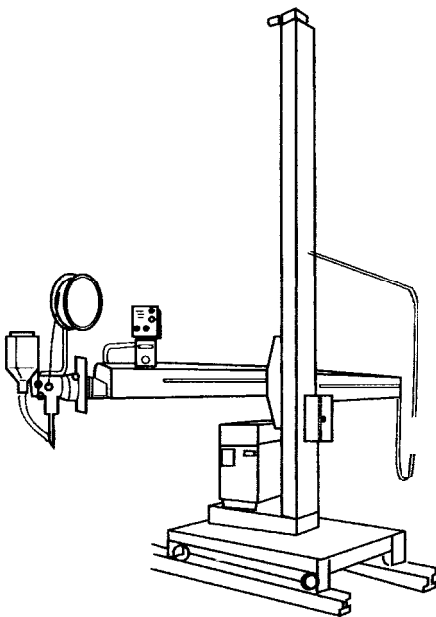
- Welding tractor that run directly on the sheet to be welded (Figure 7.2);
- A welding head that can be mounted on a column and boom unit (Figure 7.3);
- Powered rollers for rotating cylindrical workpieces (Figure 7.4).



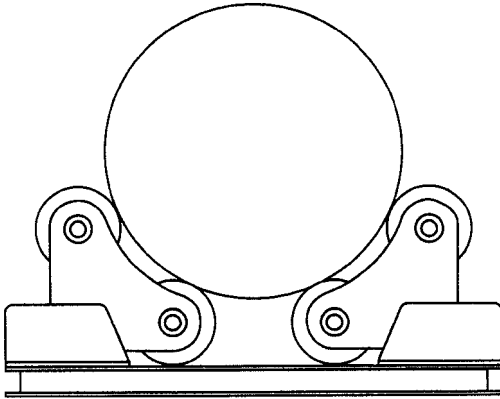


*Figure 7.2 A welding tractor for mechanised welding.*

It may also be necessary to have some kind of equipment to guide travel along the joint. One simple method is to project a spot of light in front of the welding point, and for the operator to keep this centred on the line of the joint. Another method involves purely mechanical control, using support rollers etc. In the case of larger workpieces, it may be appropriate to have some type of automatic joint tracking control. A common principle is to have a sensor finger that rides in the joint ahead of the arc, to provide servo control of a crosshead that carries the welding head.



*Figure 7.3 Welding head fitted to a column and boom unit.*



*Figure 7.4 Roller beds that automatically adapt to the workpiece diameter. They are often used together with a column and boom unit. The rotational speed is controlled by the built-in motor.*

### 7.3 Filler material

The proper choices of filler wire and flux composition are important for the finished weld. The aim is generally to achieve a composition and strength of the weld metal similar to that of the base material. The weld metal analysis depends on the materials used in the filler wire, with allowance for such factors as possible loss of alloying elements by bum-off in the arc, melting of the base metal and alloying from the flux.

When using a strongly alloying flux in a joint with many passes, there is a risk of build-up of alloying material through uptake of material from previous passes.

#### Filler wires

The wire grade and its content of alloying metals primarily affect the mechanical properties and chemical analysis of the weld metal. When deciding on an appropriate choice of wire, it is very important to allow for the following factors:

- The strength of the weld metal can be increased by alloying with manganese and silicon.
- The use of molybdenum and nickel as alloying elements improves the toughness of the weld metal at low temperatures.

The filler wire may be copper-plated in order to improve electrical contact and to protect against corrosion. Common wire diameters are 1.6, 2.0, 2.5, 3, 4, 5 and 6 mm.

Filler material in the form of strip (e.g. 0.5 x 100 mm) is often used when applying stainless steel cladding, e.g. to pressure vessel steel. As a result of the rectangular cross-section, penetration is exceptionally low, producing a smooth and wide weld. The favourable low dilution from parent metal does not affect the corrosion resistance of the surface layer. The method is also used for repair of worn parts.

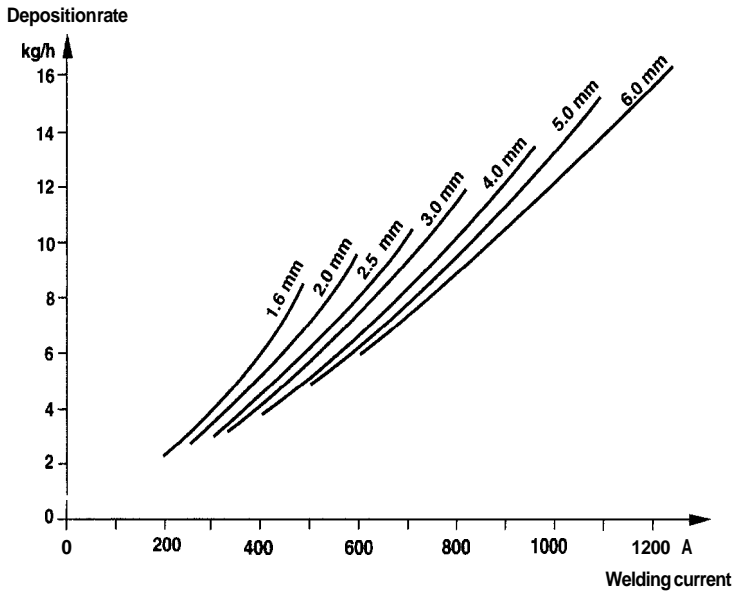


Figure 7.5 Deposition rates for different wire diameters. 30 mm stickout length, DC+ polarity. The higher melting rate for thinner diameters depends on the higher resistive pre-heating in the stickout.

## Flux

The most important purposes of the flux are:

- To form a slag and protect the molten weld metal against the harmful effects of the air.
- To supply alloying constituents to the weld metal and control its composition.
- To improve the stability of the arc and to assist ignition.
- To form the weld's surface convexity and give a good surface finish to the weld metal.
- To control the flow characteristics of the molten weld metal.

TABLE 7.1 The melting point of the flux has a considerable effect on the quantity of micro-slugs in the weld metal. In this respect, the oxygen content is a measure of the quantity of these slag inclusions.

Type of flux	Basicity	Melt interval, °C	Oxygen content by weight, ppm
Acid	< 0.9	1100–1300	> 750
Neutral	0.9–1.1	1300–1500	550–750
Basic	1.2–2.0	> 1500	300–550
High basic	> 2.0	> 1500	< 300

As with coated electrodes, the flux may be acidic, rutile or basic. Acid and rutile fluxes have excellent welding characteristics and produce a good weld appearance, although the mechanical properties of the weld are more modest. A high proportion of oxides in the form of microsags have an unfavourable effect on the impact toughness of the weld, see Table 7.1. Increasing basicity improves the mechanical properties, but at the expense of somewhat lower welding performance.

The best results are obtained if the depth of the flux when welding is controlled so that the arc is just hidden by the flux bed.

## Flux manufacture

*Fused flux.* Its preparation involves melting minerals at high temperature to produce a glass-like mass. This is allowed to cool, and is then crushed and screened to appropriate grain sizes. Chemical homogeneity of the molten flux is important. It is also important that the flux should not be hygroscopic: damp flux is difficult to handle. However, reactions can occur between the alloying substances when the flux melts, which imposes some limits on the chemical composition of the material.

*Agglomerated flux.* This is made by adding a suitable binder, such as water-glass, to the dry powder constituents of the flux. It is then dried in rotary kiln at a temperature of 600–900 °C, after which the material is screened to produce the required grain size. A characteristic of agglomerated flux is that it is easy to vary the chemical composition by adding various alloying elements, and that it is very hygroscopic. Agglomerated flux may also be more tolerant of rust and mill scale. Its popularity has increased, so that today it is the most commonly used type of flux.

**TABLE 7.2 Properties of fused and agglomerated flux.**

Flux type	Benefits	Drawbacks
Fused	Non-hygroscopic High grain strength	Alloying elements such as Cr and Ni cannot be incorporated in the flux High density (approx. 1.6 kg/l)
Agglomerated	Alloying elements such as Cr and Ni can be included in the flux Low density (approx. 0.8 kg/l)	Hygroscopic Relatively low grain strength

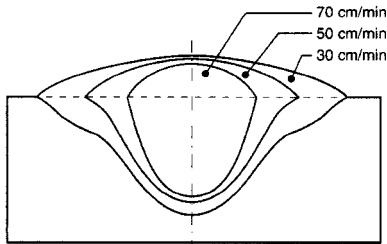
## 7.4 The effect of the welding parameters

As with other arc welding methods, the welding parameters have a considerable effect on the characteristics of the welded joint. The variables in submerged arc welding are:

- welding speed
- polarity
- arc voltage
- arc current
- the size and shape of the welding wire
- the filler wire angle
- the number of welding wires
- wire stickout length

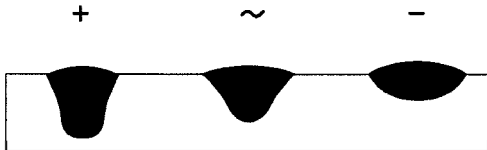
- the use of additional filler wire or metal powder additive
- the type of flux (acid / neutral / basic).

**The welding speed** affects the penetration and the width of the weld (the cross-sectional area of the weld). A high speed produces a narrow weld with little penetration. An excessively high speed produces a risk of undercutting, pores, root defects, poor fusion and magnetic blow effect. Too low a speed results in an uneven surface, while extremely low speed produces a mushroom-shaped penetration, and can result in thermal cracking. In addition, it produces a large weld pool, which flows round the arc and results in an uneven surface and slag inclusions.



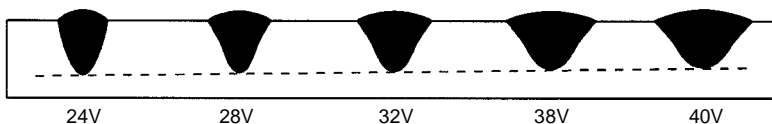
**Figure 7.6** The effect of welding speed on weld appearance, with constant values of current and voltage.

**Polarity** also affects the penetration. If the filler wire is positive, penetration is deeper than if the filler wire is negative. This means that it is better to use negative polarity when performing cladding, in order to avoid mixing the cladding material into the base material. Melting rate is increased by about 30 % percent when negative polarity is used.



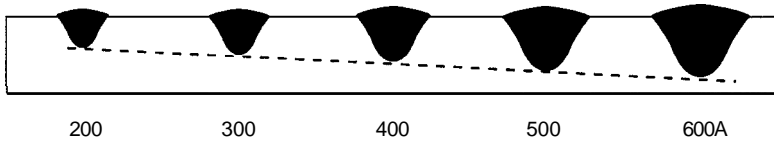
**Figure 7.7** The effect of wire polarity on penetration.

A high **arc voltage** produces a broad weld with little penetration. This means that it is suitable for welding wide gaps, and for increasing the admixture of alloying elements from the flux. It also increases flux consumption, and makes removal of the cold slag more difficult. A high arc voltage also increases the risk of undercutting, particularly when making fillet welds. A low arc voltage, on the other hand, produces a high weld convexity and a difficult contact angle with the workpiece material.



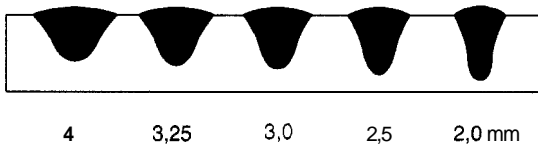
**Figure 7.8** The effect of arc voltage on the appearance of the weld.

The **welding current** affects penetration and deposition rate. A high current results in a higher and narrower weld, with a greater penetration depth. However, too high a welding current can result in undercuts, an uneven weld convexity, burn-through, thermal cracking, an inappropriate merging angle with the body material and undercutting.



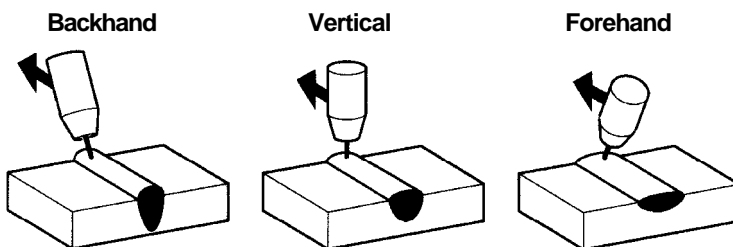
*Figure 7.9 The effect of welding current on weld appearance.*

**Wire size.** A smaller wire diameter results in greater penetration than a thicker wire. For a given current, **arc** stability is better with a thinner wire, due to higher current density. On the other hand, a thicker filler wire with a low welding current can more easily bridge a wide joint.



*Figure 7.10 The effect of wire diameter on weld appearance.*

**Wire angle.** The angle of the filler wire to the joint has a considerable effect on the shape and penetration of the weld. In certain cases, **forehand** welding (see Figure 7.11) gives a wider bead that can counteract the tendency to produce a high, narrow weld convexity, and thus allow a higher welding speed to be used.



*Figure 7.11 The effect of filler wire angle.*

## 7.5 Productivity improvements

**Tandem welding.** This arrangement employs two or more electrodes, one behind the other, feeding into the same weld pool. The first electrode is connected to a DC positive supply, and the second is connected to an AC supply. This means that the first electrode produces the desired penetration, while the other(s) fill(s) the weld and produce(s) the required shape. The use of AC on the second and subsequent wires also reduces the

problem of magnetic blow effect between the wires. This arrangement can achieve a very high productivity.

**Twin arc welding.** This involves feeding two wires in parallel through the same contact tip. It differs from tandem welding in using only one power unit and one wire feeder. Depending on the desired result, the wires may be arranged side by side or one behind the other. In comparison with the use of a single wire, twin arc welding results in a higher rate of melt production and improved stability.

A twin-arc welding machine can be easily produced by fitting a single-wire machine with feed rollers and contact tips for two wires. Without very much higher capital costs, it is possible to increase the deposition rate by 30–40 % in comparison with that of a single-wire machine. Wire sizes normally used for butt welding are 2.0, 2.5 and 3.0 mm, with wire separations of about 8 mm.

**Long stickout.** Increasing the distance between the point where the current enters the wire (the contact tip in the wire feeder unit) and the arc has the effect of resistance-heating the wire, giving a 20–50 % higher deposition rate, which means that the welding speed can be increased. However, the wire must be carefully guided: there is a risk of root defects if it is not properly aligned in the weld. A wire straightener can be the answer.

**Cold wire.** Two wires are used, but only one carries current: the other is fed into the arc from the side. This increases yield by 35–70 %.

**Hot wire.** This involves the use of an additional wire, resistively heated by the welding current. It can increase the quantity of melted material by 50–100 %.

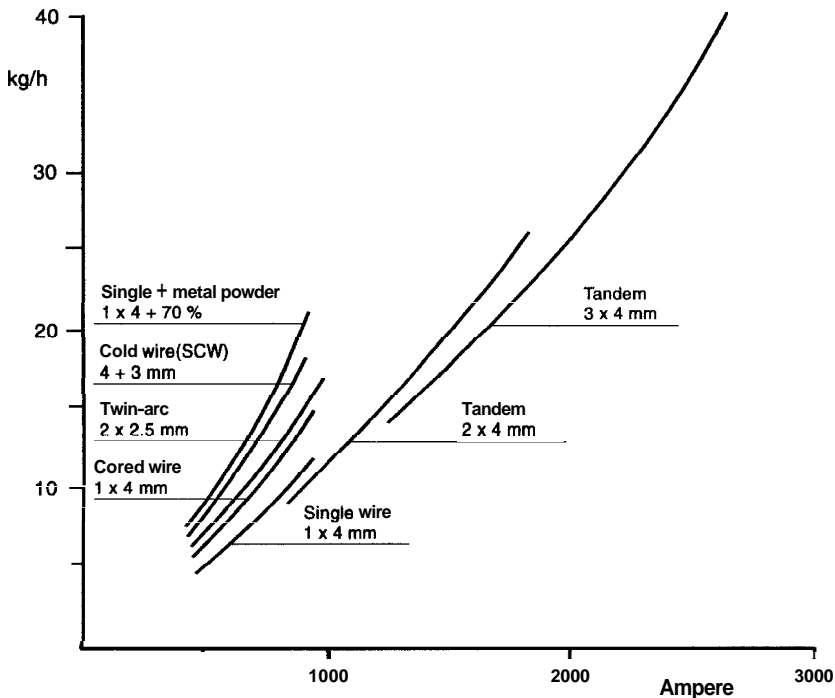


Figure 7.12 Illustration of different possibilities to increase the deposition rate.

**Metal powder additive.** Metal powder or small pieces of cut filler wire are fed into the weld, and melted by the heat of the arc. This can increase yield by up to 100 %.

The benefits of these methods are:

- Lower heat input (30–45 %) for the same melt volume – less welding distortion.
- Control of the arc pool composition through the use of extra materials and less melting of the workpiece material.
- A narrower HAZ, finer structure of the weld metal and improved impact toughness as a result of the yield energy being lower for a given volume of weld metal.

## 7.6 Joint preparation

Submerged arc welding is suitable for welding sheet metal from about 1.5 mm thick and upwards, although it is mostly used for somewhat thicker materials.

As the process is a mechanised method, the quality of joint preparation prior to welding is important. Insufficient attention to tolerances or cleaning will result in a defective weld. A clean, properly prepared joint also allows higher welding speeds to be used, with reduced cost of making good, which more than compensates for the more expensive preparation.

Single-sided welding is often convenient, which usually involves some form of root support:

- A backing tongue of steel, which is allowed to remain after welding.
- A backing support in the form of a water-cooled copper bar.
- A flux bed in a grooved copper bar.
- A special ceramic backing support.

**Double-sided welding** means that there is no need to provide root support. The good penetration of submerged arc welding means that butt welds can be made in plate up to 15 mm thick without requiring a gap or joint preparation. Thicker materials require joint preparation in the form of V-shaped or X-shaped joint faces, perhaps also in conjunction with multiple weld passes.

Asymmetrical X-joint faces are used in order to even out distortion. The first pass is made in the smaller of the two gaps. As the weld metal cools and contracts, it pulls the plate slightly upwards along the line of the joint.

Other types of joint include fillet joints, which are very common. Narrow gap welding is preferable for welding very thick materials.

## 7.7 Risks of weld defects

**Hydrogen embrittlement.** This is also referred to as hydrogen cracking, hardening cracking or cold cracking. The cracks occur in the HAZ, close to the melt boundary as the material cools, sometimes several hours after welding. The effect is caused by a combination of shrinkage stresses, hydrogen diffusing in from the weld metal and the formation of the hard martensite phase structure in the metal.

A drawback of all welding processes involving protection by flux is the risk of moisture absorption and the resulting increased risk of cold cracking. The flux should be properly stored in order to keep it *dry*. Materials having high carbon equivalents and



thicknesses must be welded at elevated temperatures, in accordance with the relevant rules.

Hydrogen is introduced from the molten pool through moisture or hydrogen containing elements on the surface of the parent metal. The hydrogen diffuses from the weld bead to the adjacent regions of the heat affected zone. Fast cooling in combination with steels with higher strength can give hardening effect. If hydrogen is present there is a great risk for hydrogen cracking. Thick plates and low heat input gives high cooling rate and this increases the risk for hydrogen cracking. An increased operating temperature of the workpiece and carefully dried consumables is an important way to assure the quality.

*Pores* can be caused by several factors, such as:

- Moisture in the flux.
- Dirt on the workpiece, such as rust or paint.

Problems with pores have a tendency to increase if the molten metal cools rapidly.

*Pinholes* are due to the release of gas (mainly hydrogen) during solidification of the metal, i.e. during primary crystallisation. The gas is unable to escape sufficiently easily from the weld metal, but is retained in the metal and acts as nuclei around which the metal solidifies. Pinholes form in the middle of the weld, running along it like a string of beads.

Pinhole formation can be reduced by reducing the speed of welding, carefully cleaning the surface of the weld joint prior to welding.

*Poor impact strength* due to grain growth occurs in connection with slow cooling. The high performance and good penetration of submerged arc welding means that it is best to weld even somewhat thicker materials with as few passes as possible. However, this results in high yield energy, so it may be better to make several passes when welding difficult materials.

*Solidification cracks*, also called hot cracks arise as the material cools, if certain combinations of unfavourable conditions occur.

- Low width/depth ratio of the weld penetration.
- High carbon and sulphur contents in the metal.
- Shrinkage stresses occurring as the material cools.

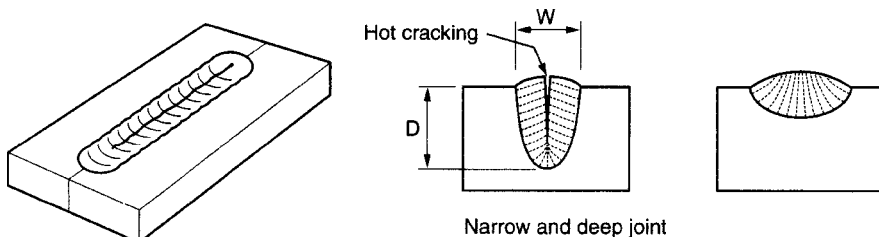


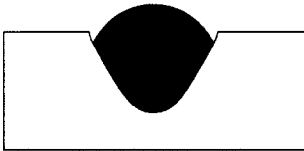
Figure 7.13 *Solidification cracks may appear when the weld is deep and narrow.*

Submerged arc welding produces a risk of solidification cracking as a result of deep penetration and considerable melting of the workpiece material causing substances from the workpiece material to end up in the weld metal. Simplistically, these cracks can be explained by the solidification front pushing a molten zone in front of it that contains higher concentrations of easily melted substances (or substances that lower the melting point) than in the rest of the weld metal. In a deep, narrow joint, the weld metal solidifies in such a way as to leave a weakened stretch trapped in the middle of the weld, which then breaks to produce a longitudinal crack under the influence of shrinkage stresses.

Hot cracking can be eliminated by forcing the weld to cool from the bottom towards the surface, so that the primary crystals are forced to grow diagonally upwards towards the surface of the weld, e.g. by welding against a heat-removing base.

Welding defects associated with starting and stopping welding can be avoided through the use of starting and stopping tabs that are later removed.

Many highly alloyed steels have a wider range of temperature over which solidification takes place. This increases the susceptibility to solidification cracking. It is also strongly influenced by the solidification direction.



*Figure 7.14 Too high voltage or welding speed may result in undercuts.*

**Undercutting** is a defect that indicates that the appropriate voltage range for the process has been exceeded. Too low a voltage results in a narrow, high weld convexity. Increasing the voltage makes the weld wider, but too high a voltage can easily cause undercutting at the edge of the convexity. Too high a linear speed along the weld can cause both a high convexity and undercutting together.

The undercut will appear when the weld metal doesn't fill up the cavity that is cut by the arc. It is most often troublesome in connection with welding of upright fillet joints, where it occurs in the web.

**Slag inclusions** are uncommon in automatic welds. If they do occur, it is usually between the passes in multi-pass welds. When making such welds in thick plate, care must be taken to remove all traces of slag.

**Uneven weld bead** will be the result if welding current is high in comparison to the wire diameter – about 1100 A or more. This is caused by the high arc pressure on the weld pool. The result of this effect is that the penetration is excessive for the wire size in use, causing the molten metal to be ejected over the edge of the joint and sometimes also causing lack of fusion.

If the current for a wire is in excess of the recommended value, it is necessary to change up to the next wire size.

# 8 Pressure welding methods

Pressure welding can be carried out by several welding methods, having in common the fact that the surfaces of the joint are pressed or worked together. Smiths in traditional forges used forge welding, which involved heating the metal in a fire until it was plastic, then it could be forged together. This means that forge welding could be classified among methods of pressure welding. In some cases (e.g. spot welding), the surfaces to be joined are heated to melting point, while in other methods the weld can be made without significant heating.

## 8.1 Resistance welding

Resistance welding is one of the oldest types of welding. Heat is generated by the passage of an electric current through the resistance formed by the contact between two metal surfaces. The current density is so high that a local pool of molten metal is formed, joining the two parts. The current is often in the range 1 000–100 000 A, and the voltage in the range 1–30 V.

We usually distinguish between five different types of resistance welding:

- spot welding
- seam welding
- projection welding
- resistance butt welding
- flash welding

Resistance welding methods are generally fast, efficient and low-polluting. No filler materials are required. The drawbacks can be high capital cost and a somewhat limited range of applications. In principle, each machine can be used for only one type of welding.

### Spot welding

Spot welding is the best-known resistance welding method. It is used for joining thin sheet materials (up to 3 + 3 mm) by overlap joints, and is widely used, e.g. in the automotive industry. An ordinary private car can have up to 5 000 spot-welded joints.

The high current, in combination with a rapid heating time, means that the thermal energy input is efficiently used: very little is conducted away to the surrounding metal. Spot welding therefore has several advantages over other methods of welding sheet metal, such as:

- Little deformation of the workpiece, as the thermal energy is more or less restricted to the immediate vicinity of the weld.
- Very high rate of production for mechanised processes.
- Easy to automate, with high consistency, which is therefore suitable for mass production.
- Low energy requirement and little pollution.

- Fast: resistance welding of 1 + 1 mm sheet, for example, takes 0.20 s.
- No filler materials required.
- Little special training required.
- Less environmental impact than when welding with an arc.

Two electrodes clamp the two sheets of metal together with a considerable force, while passing a high current through the metal. Thermal energy is produced as the current passes the electrical contact resistance between the two sheets, as given by:

$$Q = I^2 \cdot R \cdot t$$

where  $Q$  = quantity of thermal energy (Ws)

$I$  = current (A)

$R$  = the resistance across the weld ( $\Omega$ )

$t$  = welding time duration (s)

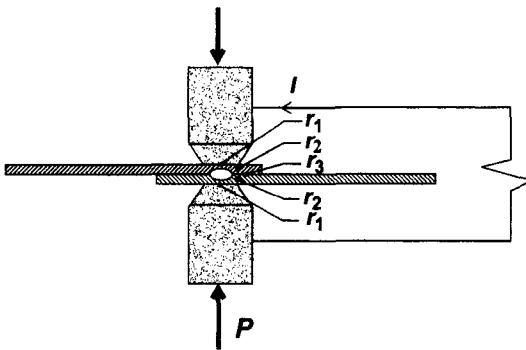


Figure 8.1 The principle of spot welding.

The total resistance between the electrodes (see Figure 8.1) is made up of:

$$2 r_1 + 2 r_2 + r_3$$

where  $r_1$  = contact resistance between each electrode and the workpiece

$r_2$  = the resistance through the metal of each of the pieces to be joined

$r_3$  = the contact resistance between the two pieces of metal.

The contact resistance between the electrodes and the workpiece, and particularly the contact resistance between the two pieces of metal to be joined, is considerably higher than the resistance of the conducting path through the metal. Minor **unevennesses** in the surface of the metal means that the current is concentrated to a few contact points, with the result that the heating is greatest at these points. Changing the clamping force can modify the contact resistance and thus also the heating.

As welding starts, the contact resistances are very high. The initial passage of current breaks through the surface layers, so that the contact resistances drop rapidly. Most of the heat formed at the contact between the electrodes and the workpiece is conducted away through the water-cooled electrodes. However, this is not the case with the heat developed in the contact resistance between the two workpiece sheets, so the temperature here rises until the melting temperature of the metal is reached, while the surfaces continue to be pressed together by the clamping force, so that a weld nugget forms in the contact area.

The electrodes need to be of a material with a high hardness, low electrical resistance and high thermal conductivity. Cooling is decisive for their life. Wear and tear, together with deformation, increase the effective contact size of the electrodes, which reduces the current density and, in due course, the strength of the welds produced. An electrode normally has a life of about 5 000–10 000 welds: when welding galvanised steel, this life is reduced to about 500–2 000 welds.

Tip dressing, using a special tool, restores the shape of the electrode tip.

### Important parameters of spot welding

The spot welding process includes a number of variables that can be adjusted in order to achieve optimum welding performance. Tables of optimum values have been produced, but it is also necessary to optimise the process by trial and error.

*The welding current* is the current that flows through the workpiece. Of all the parameters, it is this that has the greatest effect on strength and quality of the weld, as the amount of heat produced is proportional to the square of the welding current. The welding current must therefore be carefully adjusted: too high a current results in a weld with poor strength, with too great a crater depression, spatter and some distortion. It also means that the electrodes are worn unnecessarily. Too low a current, on the other hand, also produces a weld of limited strength, but this time with too small a weld area.

*Squeeze time* is the time needed to build up the clamping force. It varies with the thickness of the metal and with the closeness of the fit, and is also affected by the design of the electrode jaws.

*The clamping force* is the force with which the electrodes press the sheets together (kN). It is important that this should be carefully controlled, as too low a clamping force results in a high contact resistance, accompanied by spatter and resulting in a poor weld strength, while too high a force results in too small a weld, again with poor strength, but accompanied by unnecessary wear on the electrodes and too great a crater depression.

*Welding time* is the time for which current flows through the workpiece, and is measured in cycles, i.e. during which alternating current passes through one cycle. In Europe, the mains frequency is 50 Hz, which means that one cycle takes  $1/50 = 0.02$  s.

*Hold time* is the time from when the current is interrupted until the clamping force can be released. The plates must be held together until the weld pool has solidified, so that the joint can be moved or the electrodes moved to the next welding position.

*The electrode area* determines the size of the area through which the welding current passes, i.e. the current density. The electrode diameter ( $d$ ) is determined in relation to the thickness of the metal ( $t$ ) from the following formula:

$$d = 5 \cdot \sqrt{t}$$

When welding high-strength steels, a factor of 5 in the formula can suitably be increased to about 6–8.

### Tolerance box

The area in the diagram within which an acceptable spot weld can be produced is referred to as the tolerance box or weldability lobe. Too high a current results in spatter, while too low a current, or too short a welding time, results in an inadequate, or even no, weld nugget.

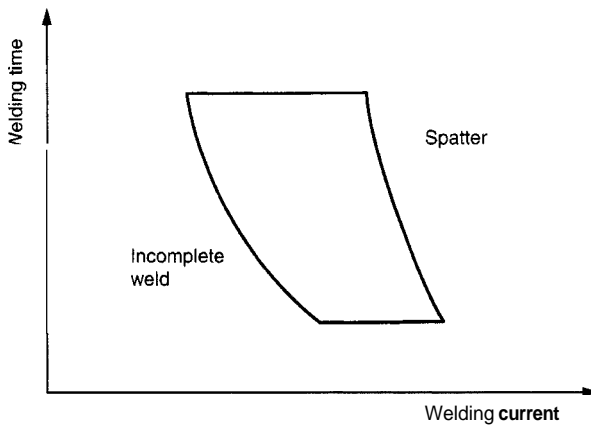


Figure 8.2 Weldability lobe where acceptable spot welding can be obtained.

### Seam welding

Seam welding is used in the same way as spot welding, and operates on essentially the same principle. The difference is that two wheel-shaped electrodes are used, rolling along (and usually feeding) the workpiece.

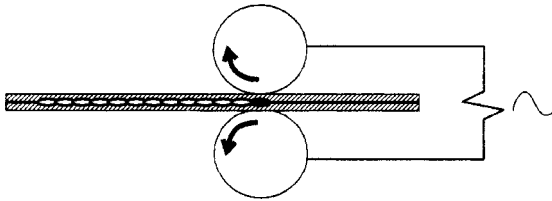


Figure 8.3 Principle of seam welding.

The two wheels should be of the same size, in order to prevent the part from being deflected towards one of them. The actual contact profile can be designed in a number of ways, in order to suit the shape of the part to be welded. The current may flow continuously while welding is being carried out, or intermittently to produce a series of spots, so closely positioned as to produce a single, continuous weld. An unavoidable problem of seam welding is that some of the current 'leaks' through the completed weld.

As the electrode rollers rotate, they do not need to be lifted between each spot, as with spot welding. If the weld does not have to be continuous, seam welding can be used therefore to position spots some regular distance from each other, which can be carried out quicker than ordinary spot welding.

### Projection welding

As with seam welding and spot welding, projection welding is used to join two overlapping sheets of relatively thin metal. The process involves pressing a number of 'dimples' in one of the plates, welding the two plates together at the same time.

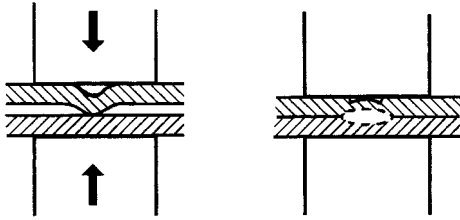


Figure 8.4 Principle of projection welding.

The method can also be used for welding metal sheet to the ends of bars, rods or pipes, or for welding nuts to sheets. Wire grids (i.e. the crossing points of the wires) are also particularly suitable for projection welding.

An advantage of the process, relative to spot welding, is that there is less wear and tear on the electrodes due to the greater contact area.

## Resistance butt welding

Resistance butt welding is used for end-to-end welding of rods or wires, e.g. when welding wire baskets, shopping trolleys or wire racks for use in ovens. The ends of the material are pressed together and a current is passed through them: the temperature across the contact resistance becomes so high that the metal softens to a plastic state and the two parts can be joined together.

Butt welding can be used for welding steel, copper, aluminium and its alloys, as well as for gold, silver and zinc. The maximum contact area is usually stated to be about 150 mm<sup>2</sup>: the upward limit is determined by the ability of the welding machine to ensure even distribution of the heat across all parts of the joint. The lower limit is determined by the purely practical ability of handling the material: for steel wire, the smallest size is generally regarded as being about 0.2 mm diameter.

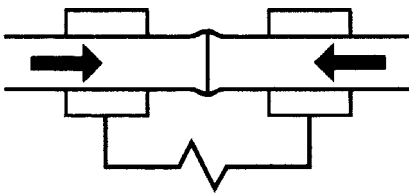


Figure 8.5 Resistance butt welding.

## Flash welding

As with butt welding, flash welding is a method in which the ends of the workpiece are pressed together and welded. It is used for welding thicker workpieces such as heavy anchor chain, rails and pipes.

The process starts by preheating the components, by moving the parts forwards and backwards, into and out of contact with each other a number of times, while current is passing, so that the contact points heat up and heat the body of the metal behind them. When the temperature is sufficiently high, this is followed by the next stage, of *flashing*.

The parts are slowly brought together and pressed firmly in contact, which causes rapid melting and gasification, with spectacular ejection of molten material in a rain of sparks. The molten metal of the two surfaces joins, and the process continues with application of forging pressure so that molten material and any trapped oxides or contamination are pressed out of the joint into a surrounding collar or upset.

**TABLE 8.1 Examples of applications for a number of resistance welding methods.**

Item	Welding method			
	Spot	Projec- tion	Seam	Flash
Stainless steel sinks	•			
Wire meshes. storage trays etc.		•		
Furniture parts, chairs. tables		•		
Pipes, sleeves, nipples		•		
Tools, drills				•
Lockers	•			
Tops and bottoms of tanks			•	
Vehicle bodies	•			
Differential casings				•
Silencers	•		•	
Pipes and sections to be joined perpendicularly				•
Rails				•
Chain				•
Substantial girders				

## Equipment

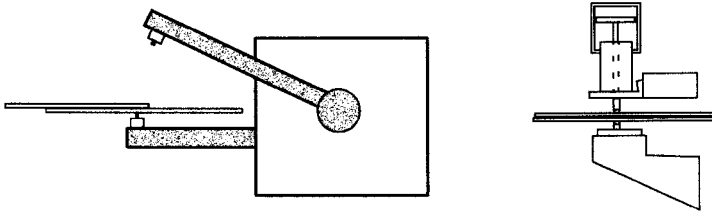
Machines used for resistance welding must perform the three stages of the process:

1. Clamping or pressing together the workpieces with a certain mechanical force and holding them in the correct position.
2. Passing the necessary current through the workpiece.
3. Controlling the welding time as required.

Resistance welding equipment is also relatively expensive, and specialised for a particular type of use. As a result, the proportion of total cost accounted in relation to equipment cost is much higher than with arc welding.

There are two different types of machines, depending on the arrangement of the electrode arms: *swinging arm machines*, in which the upper arm is carried by a bearing in the frame, and *guide rail* machines, in which the upper electrode is controlled linearly by a pneumatic cylinder, as shown in [Figure 8.6](#).





*Figure 8.6 Swing arm and guide rail resistance welding machines.*

It is important that the electrode arms are capable of moving quickly to accommodate the movement as the workpiece softens in the heat and moves together: if not, there is a risk of spatter from the weld. A mechanical or pneumatic spring can maintain a pressure on the electrode as the material 'collapses', thus reducing the risk of spatter.

The size of a machine depends primarily on the size and shape of the items to be welded. This means that, although the length of the projecting arms depends on the size of the item to be welded, the arms should not be longer than necessary, bearing in mind the electrical reactance of the loop enclosed by the arms, i.e. the area enclosed by the arms and the frame. (This applies, of course, only when welding with alternating current.) A large window area makes it possible to weld larger items, but also increases the reactive impedance. For this reason, the arms on most resistance welding machines are adjustable, although this does not apply for projection welding.

A tap-changer on the welding transformer provides coarse control of the voltage and current. Fine control is then provided by the thyristor contactor which controls the switching of the welding current.

### DC welding

DC welding machines, with a rectifier on the secondary side of the transformer, are more expensive but are immune to inductive voltage drop. They are also suitable for **three-phase** supplies, which provides a more balanced load on the mains and allows higher powers to be taken. It is nowadays also common to provide a DC supply using a medium-frequency inverter. The principle for this is the same as that for inverters used for arc welding: see Page 18. Resistance welding uses a **medium/high** frequency of about 1–4 kHz. This reduces the size of the transformer and provides more rapid control of the current and so better control of the welding process. Electrode wear is also somewhat reduced.

As a DC welding **machine** does not suffer from reactive voltage drop, the total power demand from the mains is reduced.

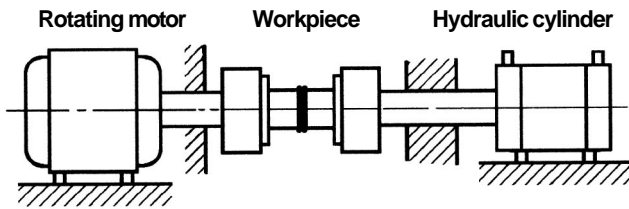
## 8.2 Friction welding

Friction welding does not involve complete melting of the joint surfaces. The surfaces are heated up and affected in various ways by pressure and friction, with the welding process itself being somewhat similar to that of forge welding. The method has been used for more than 30 years. It is very suitable for certain applications, particularly where at least one of the parts is rotationally symmetrical. Traditionally, the necessary friction has been generated by relative movement between the workpiece parts, although

in recent years the technology has been further developed so that the necessary **friction-generating** motion can be applied by an external tool.

### Friction welding by rotation of one part of the workpiece

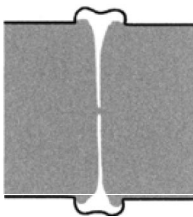
This is the type of friction welding that has hitherto been the most widely used. One part is rotated and pressed against the other, producing a weld through simultaneous heat generation and plastic deformation, as shown in Figure 8.7. In other words, the energy input is purely mechanical. Parameters of importance are the speed of rotation, the pressure and the time for which the part is rotated.



*Figure 8.7 Friction welding, with the motor driving one part of the workpiece at a controlled speed while the two parts are pressed together. After a preset time, when the necessary amount of frictional heat has been developed, the drive is disengaged and rotation stops.*

The method is usually used for two rotationally symmetrical bodies, e.g. bar to bar, pipe to pipe, flanges or endpieces. However, there is nothing to prevent one of the surfaces **from** being flat.

The welding process produces a collar of material that is pressed out of the joint, removing any surface contamination so that the joint is homogenous and defect-free.



*Figure 8.8 Section through a friction-welded bar.*

### Friction surfacing

Surfaces can be cladded using the friction welding principle. This involves a round bar of consumable materials that is rotated while being pressed against, and moved over, the workpiece surface. The process is very suitable for welding different combinations of materials: **austenitic** stainless steel can, for example, be applied to ordinary carbon steel.

Trials of this method have also been used for making welded joints. One method involves applying filler material into a continuous joint between two sheets of not too thick material. If the material is thicker, holes can be drilled in it which can then be filled by a rotating filler bar.

## Friction stir welding

Friction stir welding is an interesting development of earlier friction welding methods. The two parts of the workpiece are clamped in a butt joint against a solid support. Welding is carried out with a tool similar to a milling cutter, but with the difference that no metal is actually cut: instead, the friction of the rotating tool against the workpiece is sufficient to soften the metal without actually melting it. A collar on the tool prevents the softened metal from being displaced upwards, with the result that both the underside and top of the joint are very smooth.

A disadvantage is that a hole is left in the position in which tool travel stops. Welding speed is comparable with that of other methods.

Friction stir welding is particularly suitable for welding aluminium, e.g. for making longitudinal welds along aluminium extrusions. It is also possible to use with certain other materials, such as copper, titanium, lead, zinc and magnesium. Trials of welding plastics have also been carried out.

The process uses a rotating tool, with a pin that penetrates almost completely through the workpiece. The joint is a gap-free butt joint, and requires no special joint preparation. The workpiece must, however, be firmly clamped, as high pressure is generated as the tool passes. This also applies to the root face if full weld penetration is required. The method is similar to that of milling, except that no material is cut: instead, it is pressed past the rotating pin and fills the gap completely behind it. Friction and the 'stirring' effect raise the temperature sufficiently to soften the metal without melting it. The shape of the rotating tool is designed so that it presses down the weld convexity so that it remains level with the original surface.

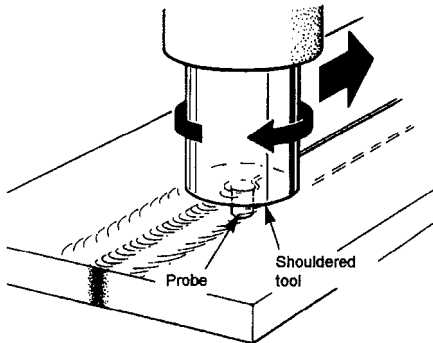


Figure 8.9 Friction stir welding,

Materials thicker than about 25 mm are most often welded from both sides.

The welding speed depends on the thickness and type of material: 15 mm aluminium, for example, can be welded at a longitudinal speed of about 180 mm/min, while 5 mm thick material can be welded at a linear speed of up to 3000 mm/min (Al 6082).

Special features of the method are as follows:

- The quality of the joint is good and reproducible. The root face can be so good that the weld is almost invisible, while the top is essentially smooth, but with a puddled surface effect left by the tool.
- With a low heat input, there is very little thermal stress or distortion.

- Mechanical properties are better preserved compared to arc welding. A hardness drop of just 10–20 % has been measured.
- FSW may be used also for alloys that are crack sensitive when they are welded with normal fusion welding processes.
- No visible radiation, noise or smoke generation.
- No filler materials required.
- Production rate is comparable with that of other methods.
- Good profitability due to very little need for preparation or subsequent processing. No consumption of filler materials.
- Welding can be carried out in the same milling machine or multi-operation machine, using the same clamping as for other operations.
- The formation of a hole from the tool where it stops can be a disadvantage. The problem of producing an invisible termination has not been solved.
- Heavy and powerful fixtures are needed to keep the parts of the workpiece together and pressed to the backing plate.

### 8.3 High-frequency welding

This method of welding could be regarded as a form of resistance welding, as the heat is created by resistive heating of a current induced in the workpiece. The use of a very high frequency, e.g. 400 kHz, concentrates the current close to the surface of the material, known as skin effect, or in parts of the workpiece close to a current-carrying conductor, known as proximity effect. This provides a means by which heating can be restricted to, or concentrated in, those parts of the surfaces to be welded together, with the final weld being made by pressing the parts together.

Current can be supplied to the workpiece by contact blocks or sliding shoes. The fast, concentrated heating provides a high rate of welding, with low heat input and little conduction of heat to other parts. An interesting application is that of longitudinal seam welding of pipes, for which welding rates of 30–100 m/min can be achieved, depending on the thickness of the material and the power input.

#### Induction welding

Induction welding is a form of high-frequency welding in which the current is induced in the workpiece by a coil, through which the high-frequency current flows, positioned close to or around the workpiece.

### 8.4 Ultrasonic welding

Ultrasonic welding bonds the workpiece parts together by vibrating them against each other at high frequency under pressure. To some extent, the equipment used for this is similar to that used for resistance welding, except that it is vibration, rather than electric current, that provides the energy input to the workpiece.

Ultrasonic welding is suitable for thin sheet, films or wires. Parts to be joined should preferably be fairly small: at least one of them – the one that will be made to vibrate – should not be more than a few millimetres in size. An example of the use of this method is that of making electrical connections in aluminium or copper. Very thin conductors

can also be welded in this way. The particular advantage of this method when using it to weld items in sensitive electronic equipment is that it produces very little heat.

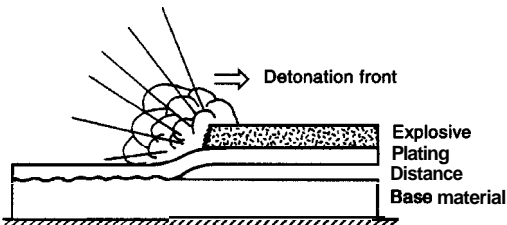
A layer of oxide, or even of insulation, need not prevent a good connection. However, the surfaces should be thoroughly degreased, as grease acts as a lubricant and degrades the quality.

### Equipment

Supported against a solid base, the parts to be welded are pressed together by the tool that transfers the vibration. An electromechanical ultrasonic head operates at a frequency in the range 20–50 kHz, with an amplitude of only a few hundredths of a millimetre.

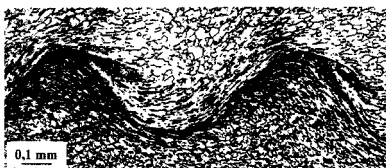
## 8.5 Explosion welding

Explosion welding develops an extremely high pressure for a short time. The surfaces to be joined are brought together at very high speed, such that the impact energy plasticise them and produces a good welded bond. The amount of heat developed is modest. As opposed to other processes, such as those involving melting of the materials, there is no (or only an insignificant) melt zone in which materials from the two pieces can be mixed or can chemically react with each other. The method is often used for a combination of materials that are difficult to join using other methods. An example of such an application is the bonding of aluminium sections to steel, on which it is then possible to use ordinary welding methods to build further in aluminium, e.g. the superstructure of a vessel, made of aluminium, on a steel hull. Another suitable application is for the manufacture of compound plate, in which a base plate is plated with a sheet or plate of another metal, as shown in Figure 8.10.



*Figure 8.10 Applying plating to a billet by explosion welding. (Nitro Metall AB)*

Explosion welding of larger pieces must be performed at specially designated sites. The method is used primarily for preparing blanks or billets, although it can also be used for such applications as joining pipes or securing tubes in tubeplates.



*Figure 8.11 Micro photograph of an explosive-welded joint in unalloyed steel. (Nitro Metall AB)*

## 8.6 Magnetic pulse welding

Magnetic pulse welding (MPW) has made its appearance in recent years. Its closest relative is explosion welding but, instead of an explosive, an extremely powerful magnetic pulse is used. In comparison with explosion welding, important advantages include a low noise level and an ability to make further welds with little time for preparation or setting up between them.

The principle involves discharging a high-capacitance capacitor through a coil surrounding the parts to be welded. Two pipes, for example, can be inserted into each other to form an overlap joint, see Figure 8.12. The high current generates a brief (<0.1 ms) but extremely powerful magnetic field, which creates a repulsive force, pressing the outer part towards the inner one.

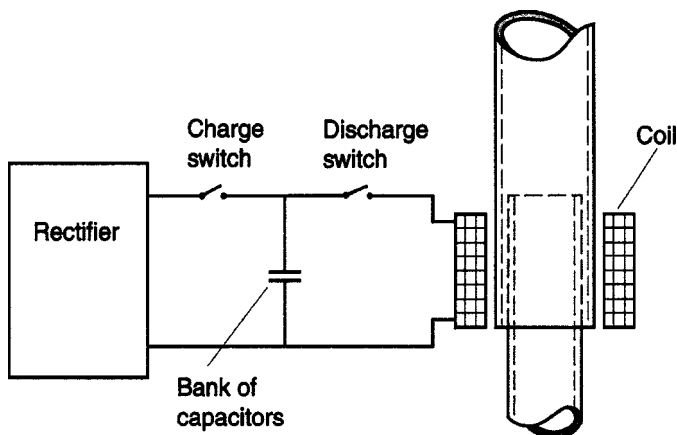


Figure 8.12 The principle of magnetic pulse welding.

The discharge current can amount to several million ampere, from capacitors that can at present be charged to potentials up to 10 kV. The coil is unique for each part, while the size of the power source depends on the energy required for each joint and the number of joints per unit time. The electrical conductivity of the material, the size of the workpiece and the overlap of the joint are all decisive for determining the energy requirement. Copper and aluminium require less energy than steel. The parts do not need to be circular: other shapes can be joined. In addition to welding, the method can be used for:

- Forming
- Calibration
- Crimping
- Punching

It is perfectly possible to weld different materials, e.g. copper to aluminium, aluminium to steel etc. The method has the following benefits:

- A cold process
- Contactless
- High precision

- Extremely fast
- Cost-efficient

Although magnetic pulse welding has some similarities with explosion welding, the bonds are made with a low noise level. The magnetic field outside the coil is not regarded as dangerous, as exposure is very short and the field strength declines with the square of the distance; in other words, very rapidly with increasing distance.

The process is best suited for volume production, as the coils need to be custom-made to suit the parts to be welded, and therefore represent a relatively high cost. The process is at present being evaluated with considerable interest by industries such as the automotive and white goods industries. The electrical industry, too, with its need to make many electrical contacts, will probably become a major user of the process.

## 8.7 Cold pressure welding

Most welding methods involve the use either of heat alone (fusion welding) or a combination of heat and pressure. Cold pressure welding is an example of a welding method that is carried out entirely without heating. The principle involves pressing the parts of the workpiece together with such force that plastic deformation causes any residual oxide layers to be pressed out and a metallic bond to be made. The method is very suitable for use with copper and aluminium, and is often used for electrical connections. An example is the connection terminal of copper which can be cold pressure-welded to aluminium conductors. This is an application for which fusion welding is definitely not suitable, as it forms a brittle intermetallic compound with unacceptably low strength.

Grease and oxides must be removed from the surfaces immediately before welding, e.g. by wire brushing. The thin layer of grease applied by touching with the fingers is sufficient to prevent the necessarily intimate contact between the workpieces. However, aluminium can be successfully welded with its oxide layer on the surface: as it is brittle, the substantial plastic deformation breaks it apart.

Welds can be made as butt welds or as overlap joints.

## 8.8 Diffusion welding

Diffusion welding is a method of joining surfaces to each other without melting and without deformation. The process is carried out under vacuum or in a protective gas atmosphere, with the application of high pressure and temperature over a relatively long period of time. Provided that the surfaces are clean, flat and accurately machined, large areas can be bonded in this way. A disc of tool steel, for example, with integral cooling passages, can be produced by welding a cover disc to another disc in which the necessary channels have been machined.

Diffusion welding can be used for many materials, including the joining of different types of metals and also the bonding of metals to non-metals. However, results are often improved by incorporating an intermediate layer between the two outer different layers.

# 9 Other methods of welding

## 9.1 Electroslag welding

### Description

Electroslag welding is a mechanised method of making vertical and near-vertical welds, with a maximum slope of  $15^\circ$  from the vertical. It is intended for welding very thick materials (40 mm and up), although it can also be used for thinner materials.

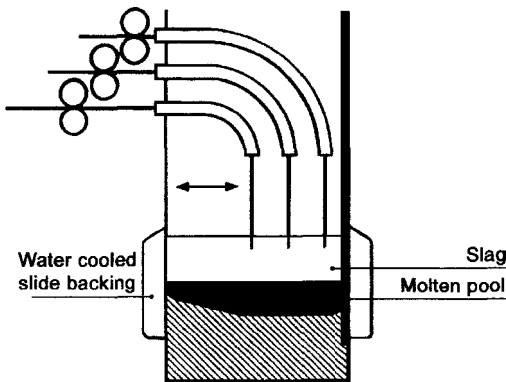


Figure 9.1 Electroslag welding.

The process is started by striking an arc between the electrode and the workpiece. Flux is fed into the joint, and melts to form a bath of slag that increases in depth as more flux is added. When the temperature of the slag, and thus also its electrical conductivity, has increased sufficiently, the arc is short-circuited and the current is carried by the molten slag, maintaining its temperature by resistive heating.

The molten metal is prevented from escaping from the joint by water-cooled copper shoes, which may be fixed or arranged to travel with the welding head. The weld is formed between them and the surfaces of the joint. The welding head moves up the joint as welding progresses. One or more filler wires may be used, depending on the thickness of the plate. If the material is very thick, the welding head may weave.

The benefits of the method include:

- High productivity
- Low cost for joint preparation
- Single pass, regardless of the plate thickness
- No angular deformation when making butt joints
- Little transverse shrinkage
- Little risk of hydrogen embrittlement.



A drawback of the method is that the high heat input means that the weld and HAZ cool only slowly, thus allowing time for substantial grain growth in the HAZ. The basic material has insufficient toughness in the HAZ to meet the requirements on welded structures in respect of impact strength.

### **Electroslag welding with consumable guide**

The filler wire in this version of electroslag welding is guided into the weld pool through a tube that melts and contributes to the filler material as welding proceeds. The tube may be coated, to provide slag to keep the depth of the slag pool constant. The advantage of this method is the welding head can be fixed, with the length (height) of the weld being determined by the length of the tube, which can be up to a metre long.

## **9.2 Electro gas welding**

Electro gas welding is a development of electroslag welding, to which it is similar in terms of arrangement and use. However, shielding gas (as in MIG/MAG welding) is used instead of a pool of slag to protect the weld, and arc heat is used to melt the filler wire, rather than resistance heat. It is used for plate thicknesses in the range 12–100 mm, with a weaving motion for the greater thicknesses. Joint preparation is generally in the form of a simple I-joint and gap, although V-joints are also used. Overall process costs are considerably cheaper than manual MIG/MAG welding for making vertical joints in items such as large tanks.

As with other gas metal arc processes, both solid and hollow wire electrodes can be used. The same types of shielding gases are also used. In comparison with electroslag welding, electro gas welding produces a smaller heat-affected zone and somewhat better toughness. A long filler wire stickout can be beneficial, as it allows a higher welding speed, melts less of the workpiece material and results in less overall heating.

## **9.3 Stud welding**

Stud welding is the common name of several different methods of securing bolts, studs etc. to a workpiece. Compared with processes such as drilling and tapping, it is fast and simple. The commonest method is briefly but intensively to heat the parts by means of an arc, melting the surfaces to be joined, and then pressing the bolt or stud into position with a special welding gun. Steel bolts or studs up to about 25 mm diameter can be welded in this way. The process can also be used for stainless steel, copper and brass items: aluminium can be welded using the capacitor discharge method.

### **Equipment**

In addition to the stud welding gun, the process requires a suitable power unit and control equipment for striking the arc and controlling the various operations. The power unit can be of conventional type, or consist of a group of capacitors which, after charging, provide a very fast discharge. Stud welding is straightforward for use as a manual process, and can also be easily mechanised, e.g. for robot welding.

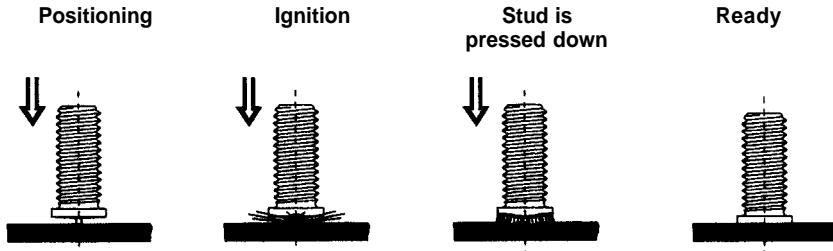


Figure 9.2 Stud welding by the capacitor method

Capacitor Discharge welding (CD) welds studs with a small 'pip' on the head, which burns away and ignites the arc. Arc duration is very short, of the order of only a few milliseconds. The method is very suitable for welding on to thin metal, as there is little spread of heat to the surrounding metal, which means that the surface finish or treatment on the reverse side is not destroyed. The welding time is 2–5 ms, and studs up to 8 mm diameter can be welded.

Conventional power units are suitable for bigger studs. The arc method strikes the arc by touching the stud against the workpiece and then lifting it. When the surfaces have been sufficiently melted, the stud is pressed against the metal. A ceramic ring is positioned around the stud, serving the dual purpose of containing the melt and protecting the process. Shielding gas can also be used. The minimum plate thickness is  $\frac{1}{4}$  of the stud diameter, and welding time is about 0.1–2.0 seconds. The surface of the metal does not need to be clean.

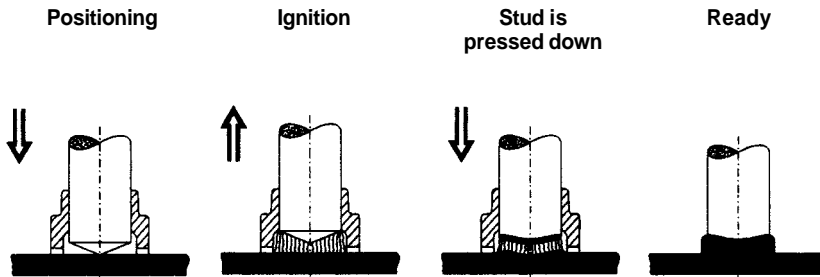


Figure 9.3 The arc method.

A variant of the arc method is the short cycle method. The welding time is shorter, generally less than 0.1 second, and the method can be used both with and without a ceramic ring and/or shielding gas. The sheet can be thinner in proportion to the diameter of the stud (down to 1:8), and the process is not sensitive to the surface coating on the sheet, e.g. galvanizing, grease or mill scale.

## 9.4 Laser welding

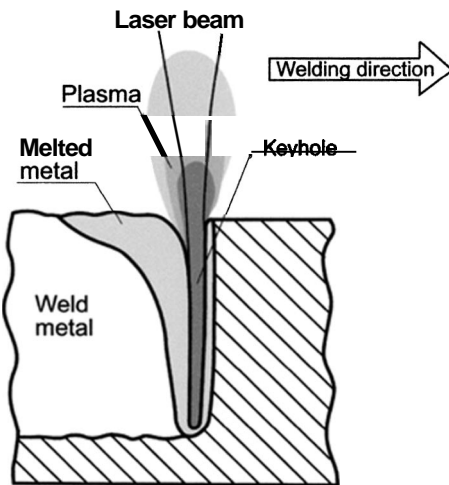
Laser light possesses several unique properties, among which are the fact that it is parallel and highly concentrated. It can therefore be conducted, by mirrors or glass fibres, to a welding position that is remote from the power unit. It is also monochromatic, i.e. at a single definite wavelength, which depends on the type of laser used.

## Description

The laser beam is focused by a lens or mirrors into a point only a few tenths of a mm in diameter in order to provide a high energy density. The focus point is arranged to fall on, or slightly below, the surface of the workpiece. The material immediately melts, with some even being vaporised. The vaporised metal in the hole forms a plasma which, being a good absorber of the incident light, **further** improves energy absorption and so efficiency of the process. See Figure 9.4. **Shielding** gas is used, to prevent air **from** reacting with the material and to protect the lens from spatter and vapour.

As soon as the beam has moved on, and the heat input has been interrupted, the metal solidifies fast, as the heated zone is small. As a result, the size of the heat-affected zone is also small, and distortion is negligible. The penetration of the weld depends on the laser output power. No filler materials are used, except for hybrid welding (see below).

One of the main application areas for laser welding is the automotive industry, which welds relatively thin sheet. More powerful lasers increase the penetration, and trials of laser welding **are** being carried out in shipyards.



*Figure 9.4 Penetration of a laser welding beam.*

The laser produces deep, **narrow** penetration. This is achieved by keyhole welding methods (see also Page 38), which ensure complete penetration. Welding speed depends on the laser power, and can be high when **thin** materials are being welded: up to 10–50 **m/min**, and even 100 **m/min** when welding foils. Laser welding is, in other words, fast: about twice as fast as plasma welding and eight times faster than TIG welding. Pore-free high-strength welds, excellent dimensional tolerances and high productivity make the method superior to most others in many applications. In addition, laser welding is clean and quiet.

A drawback of laser welding is that the low **width/depth** ratio of the weld geometry can result in thermal cracking. In addition, hardening steels can be locally hardened by the rapid rate of cooling. As the laser beam is only a few tenths of a **millimetre** in diameter, it means that the method is tolerance-sensitive, and therefore requires highly accurate jigs and fixtures. However, thinner materials can often be overlap-welded,

which reduces the accuracy requirements. Investment costs are high, but prices are coming down and laser welding can be expected to be much more widely used in the future.

Laser welding is often used for welding materials that can accept only a low heat input, e.g. certain stainless steels and hardened materials, or for welding components in the electronics industry. The method also used where complicated parts require high precision, e.g. in the automotive, general engineering and aerospace industries.

## Equipment

The commonest types of welding lasers are the CO<sub>2</sub> laser and the Nd:YAG laser, with the latter tending to be used for thinner materials and the former for thicker. The laser beam may be either pulsed or continuous.

### The CO<sub>2</sub> laser

The CO<sub>2</sub> laser generates its light in a tube through which a mixture of gases (including CO<sub>2</sub>) flows, producing a wavelength of 10.6 μm. The energy input is by means of an electric discharge through the gas. It can produce a high power output, and so is popular for welding and cutting applications. The light is usually conveyed to the welding head and focused by mirrors. A shielding gas (often helium or an argon/helium mixture) is used to protect the lens and the weld: it helps to limit the amount of energy-absorbing plasma formed above the surface of the joint. In this respect, helium is to be preferred, due to its high ionisation energy.

CO<sub>2</sub> lasers available today have much higher powers than Nd:YAG lasers. As welding speed is proportional to output power, CO<sub>2</sub> lasers can weld more quickly. Alternatively, the higher power means that CO<sub>2</sub> lasers can weld plate up to 26 mm thick. However, one problem is that a considerable portion of the beam energy is reflected by certain materials: different wavelengths are absorbed to different extents, which means that the light from CO<sub>2</sub> lasers is reflected more readily than that from YAG lasers. This is particularly noticeable when welding materials such as aluminium or magnesium alloys. Gold, silver and copper are also difficult to weld with CO<sub>2</sub> lasers.

### The Nd:YAG laser

The active substance in this laser is neodymium, in the form of a dopant in a transparent rod of yttrium aluminium garnet. Energy is supplied by a flash tube, of the same principal as used in cameras. The light output wavelength is 1.06 μm, i.e. considerably shorter than that of the CO<sub>2</sub> laser, but still within the invisible infra-red section of the spectrum. An important difference is that the shorter wavelength enables the light to be carried by fibre optics and focused with ordinary lenses. This gives substantial practical benefits and makes it possible to use the laser for robot welding.

Problems due to the presence of absorbing plasma are less when welding with Nd:YAG lasers, and so argon and argon/CO<sub>2</sub> gas mixtures can be used. Acceptable results can even be obtained without shielding gas when welding spot welds or at low powers.

This type of laser is particularly suitable for welding otherwise difficult materials such as tantalum, titanium, zirconium, Inconel etc. Its drawback is that it is not available with such high power outputs as is the CO<sub>2</sub> laser, and so tends to be limited to metal

thicknesses up to 6 mm. However, development is increasing the outputs available: in combination with the ability to use fibre optic light conductors, this makes this type of laser potentially very attractive.

### **Diode lasers**

High-power lasers are bulky, very expensive and often have very poor efficiency. Laser diodes offer an interesting alternative to them. These are, in principle, the same as those fitted in every CD player. By grouping a large number of them, it is possible to produce sufficient laser light power to weld thin metal. However, they are still expensive, with poor beam quality, i.e. it is difficult to concentrate the beam sufficiently.

### **Protection**

A pair of ordinary glasses is sufficient to absorb the radiation from a CO<sub>2</sub> laser and to protect the cornea from being damaged by the beam. However, the light from a Nd:YAG laser requires special protective goggles, as even the reflected light from the workpiece can damage both the cornea and the retina, as well as cause cataracts in the eye's vitreous body. This is because the lens of the eye focuses the light on the retina. Even with protective goggles, it is therefore dangerous to look hard (i.e. other than fleetingly) at anything in the vicinity of a Nd:YAG laser beam while welding is in progress.

### **Cladding**

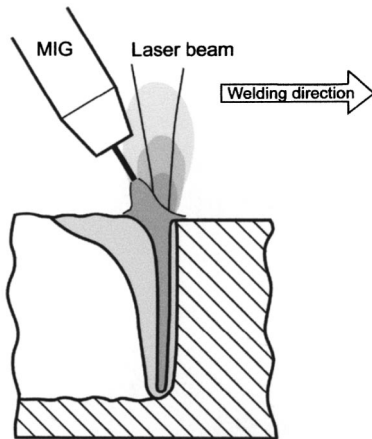
The wear resistance and corrosion resistance of surfaces can be improved by applying a suitable cladding layer to them, either in small local areas or over the entire part. The method can be used both for new manufacture and for repairs, wherever an appropriate surface cladding is required. It produces a thin layer of pore-free weld metal, with a good surface finish and little mixing with the substrate material.

Less energy is required than for other cladding methods, which means that there is less thermal distortion and a more finely grained structure. The cladding material is usually in the form of a flux bed, but it can theoretically be applied in the form of wire, foil, chips etc. Welding is carried out under a shielding gas to prevent the formation of oxides.

### **Hybrid welding**

Hybrid welding refers to a combination of two welding methods, usually laser welding and an arc welding method such as MIG or plasma welding. Combining a laser with MIG/MAG welding, which wire provides molten material that fills the joint and thus reduces the requirements for exact positioning of the two parts that would otherwise be required for laser welding alone. In addition, when welding fillet joints, this combination provides reinforcement of the joint.

This also reduces the risk of undercutting, which can easily occur with laser welding, and which unfortunately seriously reduces fatigue strength. However, in comparison with ordinary MIG/MAG welding, the welding speed is considerably higher, due to use of the laser.



*Figure 9.5 Principle of laser/MIG hybrid welding.*

The method is suitable for making both butt and fillet joints, and is most used for welding plate of 10 mm and thicker. Instead of filler wire, powder can be used, producing excellent joints. This involves the use of an electromagnetic jig that produces a magnetic field to ensure that the powder reaches right down into the joint.

## 9.5 Electron beam welding

### Description

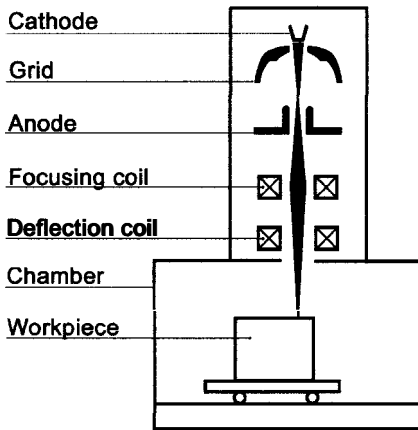
Electron beam welding uses a very high-energy electron beam to produce deep, narrow penetration. The electron beam has a higher energy content than a laser beam, and is also smaller. Penetration is also deeper for a given power, and the overall efficiency of the energy conversion process from input electricity to output beam power is also much higher. Important characteristics include the high energy density, which makes it possible to melt the gap between two parts without problems of distortion.

Welding has to be performed in a vacuum, as the electron beam is absorbed by air. This complicates the process when changing the workpiece. On the other hand, the absence of air is good for the welding process, as there can be no reactions between air and the metal of the weld or workpiece.

Electron beam welding is used for advanced materials and complicated, critical parts such as, for example, turbine rotors, but can also be suitable and economic for many simpler processes involving large production runs. It is very suitable for butt welding materials of different thicknesses, but is particularly competitive for welding thick materials, up to 250 mm.

### Equipment

The electron gun (see Figure 9.6), is supplied from a high-voltage power source (30–175 kV), but at a low current (less than 1 A). The electrons are accelerated from the anode and are focused and deflected by magnetic coils in a manner similar to that used for television or computer screens.



*Figure 9.6 The electron gun.*

The electron beam requires a vacuum, and so welding is carried out in a vacuum chamber. This normally requires the chamber to be opened to load or change a workpiece, after which it must be evacuated by a high-vacuum pump. However, various designs that use forms of air locks for the loading and unloading of materials have been developed to deal with smaller items or (for example) strip materials.

When the electron beam meets the workpiece, it produces a secondary emission of x-rays, and so the vacuum chamber also provides protection against this radiation.

Welding is normally performed by traversing or rotating the workpiece by programmable control, with the electron beam stationary. Particular attention must be paid to maintaining appropriate accuracy, bearing in mind the sizes of the narrow beam and of the joint. However, the beam can be deflected to make it sweep back and forth across the joint (which affects penetration) or for joint tracking.

Although the electron gun itself requires high vacuum, the vacuum in the rest of the chamber does not need to be quite so high. The electron beam can even travel a short distance in air, but is quickly absorbed and scattered, which limits penetration. In addition, if welding is performed outside the vacuum chamber, protection must be provided against x-rays in some other manner.

## The welding method

As with laser welding, electron beam welding is a method involving high energy density, which produces the following characteristics:

- Welds are normally made as butt welds. Very deep penetration can be achieved by the electron beam.
- Welds are narrow, with a high penetration/depth ratio.
- Joint preparation must be carefully performed, ensuring accurate positioning.
- Careful control of the beam track along the joint is essential.
- Productivity can be high in relation to conventional methods.

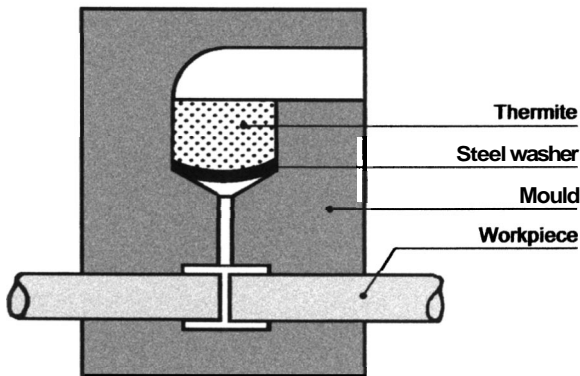
- Heat input is low in absolute terms, resulting in low residual stresses and little distortion of the workpiece. Reproducibility and tolerances **are** also good, as the method is mechanised.
- Many otherwise **difficult** materials and material combinations can be welded.
- The method is perfect for sealing vacuum chambers.

It may be necessary to demagnetise magnetic materials before welding them, as the magnetic field could otherwise deflect the electron beam.

## 9.6 Thermite welding

The energy source of this method is the heat released by chemical reduction of a metallic oxide. This means that welding is performed by a chemical reaction, without any input of external energy (apart from that required to start the reaction).

The parts to be welded are positioned in a mould, as shown in Figure 9.7, specifically intended and shaped for them. The **welding** powder, known as thermite, and consisting of a metal oxide, such as iron oxide, mixed with aluminium powder, is loaded into a compartment above the workpiece.



*Figure 9.7 A mould set up for thermite welding.*

As aluminium has a much higher **affinity** for oxygen than does iron, an exothermic reaction occurs:



The powder is ignited by a spark, resulting in the oxide being reduced, a large amount of heat being released and the iron melting. The very high-temperature melt, consisting of molten iron at about 2 500 °C, runs down into the mould, melts the joint surfaces and forms a welded joint with the workpiece.

The process is commonly used for joining rails, using a thermite mix consisting of iron oxide and aluminium. Another application is for the joining and connecting of copper conductors, using a powder consisting of **cuprous** oxide, aluminium and tin. This mixture can also be used to joint copper conductors to steel. A powder for welding aluminium is also available.



# 10 Cutting methods

In the literature, thermal cutting processes by gas, plasma or laser are often covered in conjunction with the corresponding welding methods. This is because almost the same equipment is used for both processes, and because the methods are often also utilised together. It is then also appropriate to take the opportunity to cover competing methods, such as water jet cutting.

This chapter also describes air carbon arc gouging and oxy-fuel gas flame gouging; methods which are often closely associated with corresponding welding processes.

## 10.1 Thermal cutting

Thermal cutting is used considerably in connection with the preparation of parts for welding. In addition to cutting plates etc., it may also be necessary to prepare the joints by bevel-edging them. The quality and smoothness of the resulting cut surface are generally satisfactory for the purpose, and the methods are easy to mechanise.

### Oxy-fuel cutting

Oxy-fuel cutting uses a flammable gas, generally acetylene or propane. Burning the gas in oxygen, rather than just air, produces a flame with a high temperature. The flame first preheats the workpiece: when a sufficiently high temperature has been reached, a jet of oxygen produces the cut by actually burning the metal. This produces a metal oxide in the form of liquid slag, which is blown out of the joint by the jet of gas.

The flame also helps to maintain the upper surface of the plate above the ignition temperature of the metal while cutting is in progress, although most of the necessary heat required for the cutting comes from combustion of the actual material being cut. For example, when cutting 25 mm steel, about 85 % of the heat comes from combustion of the iron. In thinner materials, however, a greater proportion of the heat is applied by the flame.

### Equipment

Oxy-fuel cutting can be carried out either manually, using a cutting torch, or by machine, with a numerically-controlled cutter head. In the same way as for gas welding, there are two main types of torch: high-pressure torches and injector torches. The difference between welding torches and cutting torches is that the latter have a nozzle for the oxygen cutting jet, generally in the centre of the flame nozzle.

### Materials

For successful gas cutting, the material to be cut must fulfil certain conditions.

- The oxide must have a melting point that is lower than the melting point of the metal itself. In the case of iron, the oxides melt at about 1400 °C, which is lower than the 1530 °C melting point of low-carbon iron. It is the melting temperature of the oxides that explains why stainless steel and aluminium are not suitable for gas cutting.

- The ignition temperature of the metal must be lower than its melting point. In the case of low-carbon steel, the ignition temperature is about 1050 °C.
- Combustion of the metal must create sufficient heat to maintain combustion.

From this, it follows that it is only low-alloy steels with a carbon content of up to about 0.3 %, that can be cut in the usual way by oxygen burners. In such steel, thicknesses up to about 300 mm can be cut by oxy-fuel cutting. Where quality requirements in respect of the finished cut are less stringent, very considerable thicknesses can be cut, up to about 3000 mm. At the other end of the scale, below 25 mm, oxy-fuel cutting is in competition with plasma cutting, which gives a higher rate of cutting, as shown in [Figure 10.1](#).

Other methods of cutting are recommended for cutting stainless steel and cast iron. However, oxy-fuel cutting can be used to cut these materials, with the use of appropriate additives.

## Gases

As described in the chapter on gas welding, *acetylene* has special characteristics, burning with an intense flame and a high combustion velocity. This high combustion velocity can be a disadvantage or even a danger, in that the combustion front can migrate backwards, into the burner nozzle. On the other hand, the hot core of the flame makes the gas suitable for cutting thinner materials, which can be done with good productivity.

*Propane* burns with a flame with lower heat concentration. This therefore spreads the heat more evenly along the cut, which can be an advantage when cutting thicker materials.

*Hydrogen* is not commonly used as a fuel gas, although interest in it has been aroused in recent years through the ability to produce oxygen and hydrogen by hydrolysis of water. This involves the use of electrical energy to dissociate water into its elemental constituents, at a rate as needed for cutting. In terms of their thermal characteristics, hydrogen flames are similar to propane flames.

*Oxygen* performs three duties in connection with gas cutting. It produces the heating flame with the fuel gas; it burns (oxidises) the material to be cut and it blows the resulting slag out of the cut. The purity of the oxygen is very important for cutting speed: 99.3–99.7 % purity is common. A reduction of 0.5 percentage points reduces the cutting speed by about 10 %.

## Plasma cutting

The hot concentrated jet produced by the plasma method, which has previously been described in connection with welding, is very suitable for cutting. However, as opposed to gas cutting, which works primarily by burning the material using the oxygen in the cutting jet, plasma cutting works by melting the material and then blowing the molten material out of the cut by the pressure of the plasma jet. When used for cutting, the pressure of the plasma gas is higher than as used for welding, and both smoke and noise are generated, at least when cutting thicker plate. However, this can be considerably reduced by cutting the metal on a cutting table, with the metal itself under water.

The range of applications is wide, although materials of particular interest for this process are such as stainless steel, aluminium and copper, which cannot be cut by ordinary oxy-fuel gas cutting.

## Equipment

A hand torch can be used for simpler jobs, although industrial production generally uses numerically controlled cutting tables, with one or more cutting heads, approximately as for gas cutting. Noise, visual radiation/arc glare and smoke can be quite intensive, but can be considerably reduced if the metal to be cut and the plasma nozzle are under water. The arc electrode is normally tungsten or tungsten with thorium oxide. However, the development of electrodes containing hafnium or zirconium has made it possible also to use oxidising cutting gases, even to the extent of using ordinary air.

The power unit has a constant current characteristic, as for TIG and plasma welding, but must be designed for a much higher voltage. The operating voltage exceeds 100 V, and the open-circuit voltage can exceed 200 V. Special measures must be taken to prevent the operator from coming into contact with these dangerous voltages.

## Plasma gases

Pure argon is sometimes used as the pilot gas, in order to ensure reliable ignition of the pilot arc. (The pilot arc is struck before the cutting operation starts, but is not transferred to the workpiece, i.e. it strikes between the central electrode and the plasma nozzle.)

The cutting gas needs to have good heat transfer properties: pure nitrogen, mixtures of argon/hydrogen, nitrogen/hydrogen or just compressed air are used.

One way of increasing the cutting speed in low-alloy steels is to use an oxidising gas that provides an active contribution by burning the metal, in the same way as with oxy-fuel gas cutting. The simplest and cheapest gas, of course, is ordinary compressed air. However, this imposes special requirements in respect of the electrode. As a tungsten electrode is attacked by oxygen, a well-cooled hafnium or zirconium electrode must be used. It must also be accepted that there will be somewhat higher costs for replacing the electrodes.

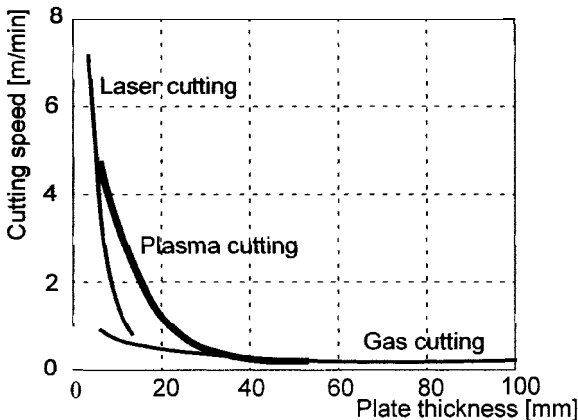


Figure 10.1 Typical cutting speeds for plasma cutting, oxy-fuel gas cutting and laser cutting.

## Properties

Plasma cutting can be the best alternative, even for ordinary low-alloy steel. For thicknesses up to about 25 mm, the rate of cutting can be considerably faster than that of oxy-fuel gas cutting, which also means that the size of the heat-affected zone is reduced. On

the other hand, the kerf width is about 1.5–2 times wider than that produced by gas cutting. In addition, the surfaces are not completely parallel: the cut is slightly wider at the top.

New designs of plasma cutters have been developed in order to cure this problem. A method known as high-tolerance plasma (High-Tolerance Plasma Arc Cutting, HTPAC, in American literature) has been developed. Its features include a smaller gas nozzle opening and a narrower cutting jet, with a higher current density. Pure oxygen is used when cutting low-alloy steel. The resulting characteristics of high-tolerance plasma cutting are somewhat similar to those of laser cutting. Greater accuracy of control of the cutting nozzle is required when cutting thin metal, in order to meet the reduced tolerance requirements. This also includes careful height maintenance above the surface of the workpiece.

## Laser cutting

A laser beam has excellent characteristics for cutting: in particular, the precision of the cut is very good, and there is very little thermal effect. The method is best suited for relatively thin materials, where very high productivity is required. Many non-metallic materials can also be cut by laser.

### Equipment

The laser light is generated by CO<sub>2</sub> or Nd:YAG lasers, and has characteristics as described in the section on laser welding. The laser itself is stationary, and the beam of light is carried to the cutting head where it is focused by a lens. The cutting motion may be two-dimensional or three-dimensional: the Nd:YAG laser is preferable for three-dimensional control, as it can provide higher output powers and the light can be conducted through glass fibres, with the cutting head controlled by an industrial robot.

### Cutting gas

A cutting gas is supplied to the cutting head together with the focused laser beam, in order to:

- assist in blowing molten and vaporised material out of the cut
- protect the lens from spatter
- (depending on the material being cut), *either* protect the surfaces from oxidation, through the use of an inert gas, *or*
- through the use of an oxidising gas, provide an input from combustion heat, thus improving cutting performance.

When cutting ordinary low-alloy steel, the use of oxygen can increase the cutting speed by 25–40 %, as compared with the cutting speed using compressed air. High-purity oxygen (better than 99.7 %) gives the highest cutting speed.

## 10.2 Water jet cutting

Water jets alone (i.e. without any additive materials in the water) can be used for cutting soft or porous materials. When cutting metals or hard materials, such as glass or stone, *abrasive water jet cutting* is used, with sand being an additive in the jet.

The unique feature of water jet cutting is that there is no thermal effect on the material, thus eliminating any thermal or mechanical stresses that could affect the results. This means that, although the cutting speed may be lower than that of certain competing methods, time can be saved overall through elimination of the need for any subsequent treatment. The quality of the cut is good, when compared with the results produced by thermal methods. The method is also suitable for cutting materials that can be difficult to cut in any other way.

### Equipment

An electrically driven hydraulic oil pump produces an oil pressure of 150–200 bar. The oil then drives a high-pressure pump that produces a water pressure of up to 4000 bar. This pressure is converted in the jet to a very high velocity, of up to about 1000 m/s. The water jet nozzle is subjected to very high wear, and so therefore includes an insert which is generally made from industrial sapphire, to provide an operating life of perhaps about 100 h. The hole through the sapphire is usually about 0.1–0.3 mm, producing a hair-thin jet and a cut which is almost equally narrow. The cut produced by abrasive cutting is somewhat wider, up to about 1.5 mm.

A cutting table is generally used, with a numerically controlled cutting head, as for thermal cutting processes. Industrial robots can also be used for three-dimensional cutting.

### Materials

Most materials can be cut by water jets. Using water alone, materials such as wood, paper, felt, foamed plastic etc. can be cut. Abrasive water jet cutting can deal with metals such as stainless steel, copper, aluminium and titanium, or with composites such as glass fibre-reinforced plastics or hard materials such as glass, ceramics and natural stone.

### Properties

Water jet cutting has generally been employed where other methods are unsuitable. The cutting speed when cutting steel less than 20 mm thick, for example, is only about one-tenth of the speed that can be achieved by plasma cutting. Metals can be cut at a rate of about 10–30 cm<sup>2</sup>/min, or somewhat more for soft metals. Thicknesses can be up to about 100 mm. Materials such as glass, plastic, rubber, stone etc. can be cut at rates of about 100–300 cm<sup>2</sup>/min.

## 10.3 Thermal gouging

Welding is often accompanied by a need to cut away surplus material: in such cases, gouging can be more efficient than grinding when repairing defects in welds or when cutting a groove to avoid weld defects when the workpiece is to be turned over and the weld completed from the root side.

Several of the methods, and particularly those that use an electric arc, create considerable quantities of smoke, so that special ventilation should be provided when using them indoors. In addition, as gouging involves melting the material and blowing it away, the operator should protect himself and the surroundings.

## Oxy-fuel gas flame gouging

This method is based on the same technology as used for gas cutting. It uses a special nozzle, which facilitates working along the workpiece surface. It is suitable for use with carbon steel and low-alloy steels, in the same way as is gas cutting.

## Air carbon arc gouging

This method has also gone under the name of *arc air gouging* or *carbon arc gouging*. It uses approximately the same equipment as for welding with coated electrodes. The gouging electrode is a copper-plated carbon electrode, used in an electrode holder that has an outlet for compressed air. The best power unit is one that can provide a high current and, if possible, also a high short-circuit current, in order to maintain the correct arc force. The electrode is held at an angle to the workpiece and, together with a jet of compressed air, can remove metal at a high rate.

The carbon electrode should be connected to the positive pole of the power unit: special electrodes are available for use with AC. Electrode diameters from 3 mm to 19 mm are used, depending on the current available and the desired rate of metal removal.

## Manual metal arc gouging

This does not require any equipment other than that as used for welding with coated electrodes. The electrode, however, is a special gouging electrode, with a thick coating, which produces a considerable quantity of gas. The arc is struck in the usual manner, and the electrode is then inclined at a considerable angle to the work, with the tip pointing in the direction of travel. It produces a smooth groove, with a high rate of metal removal. Best performance is obtained by connecting the electrode to the negative pole or by using AC.

## Plasma arc gouging

Plasma arc gouging uses the same equipment and gases as for plasma cutting. The nozzle, however, may incorporate a nozzle for shielding gas. It is held about 20 mm from the workpiece, at an angle of about 45° to it, and pointing in the direction of travel. The angle can be changed to vary the width/depth relationship in the groove.

Compared to air carbon arc there are benefits

- Less generation of fumes and gases and reduced noise level
- Higher productivity and groove quality
- No risk of carbon pick-up
- Suitable also for non-ferrous metals

# 11 Surface cladding methods

## 11.1 Cladding to provide a corrosion-resistant layer

The application of stainless material to a lower alloy steel is an economic method of producing reactor pressure vessels or pressure vessels for such applications as the chemical industry, where a thick-walled vessel is needed with internal corrosion protection. There are several different welding methods that can be used:

- Submerged arc welding using a solid wire electrode, often Twin Arc double wire, or using a flux cored wire.
- Submerged arc welding using a broad but thin strip electrode.
- Strip electrode welding with a flux that enables the process to be carried out using the electroslag principle, i.e. without an arc, but with the heat being generated by resistance heating in the molten slag. See "Electroslag welding" on page 93
- Plasma cladding.
- Thermal spraying: see Page 110.

The aim is to achieve a sound weld, but with little melting of the underlying material. In this respect, the electroslag method is preferable to ordinary submerged arc welding, as it penetrates less into the substrate material and so results in less mixing of the weld metal. Several of the ordinary submerged arc welding methods can of course be used, but it may be necessary to apply two or more layers until a sufficiently pure layer of weld metal is produced.

Cladding is often performed by mechanised methods, as there are often larger areas to be covered.

## 11.2 Hardfacing

Application of high-abrasion-resistance alloys by welding is a method of repairing machine parts or other metallic items that are subject to abrasive wear. Examples include rails, turbine blades, excavator bucket teeth and conveyors in the mining industry. It is often cheaper to repair such parts than to replace them by new ones, as it is quicker and there is no need to hold stocks of spare parts.

It can also happen that a surface must be hard, while the underlying material must have higher toughness. In such cases, it is common to apply the hard surface layer by welding, which can be done either by automatic welding equipment or manually, depending on the circumstances and the amount of welding to be done.

### Types of wear

The type of cladding material to be used depends entirely on the type of wear to be protected against. There are many different wear mechanisms, although they can be divided roughly into the following four classes for simplicity:

### **Friction and adhesion**

This class is that in which two metallic surfaces roll or rub against each other, e.g. a shaft and bearing or a cable and sheave. Even the most highly polished surfaces have microscopic unevennesses, which result in wear. Particles from both surfaces are pressed together and broken off, causing growing wear. The most important factors in this respect are the finish of the surface, contact pressure and material structure.

In general, it can be said that wear particles from two surfaces having the same hardness and analysis can 'combine' more easily, which results in greater wear. It is therefore desirable to avoid allowing two surfaces of the same material to contact each other.

### **Abrasion**

When small, hard mineral particles rub across a metal surface, the surface of the metal will be cut away. The harder the mineral and the sharper the edges of the particles, the greater the amount of wear. This sort of wear mechanism occurs, for example, in dredging and the transport of minerals.

In order to counter abrasive wear, it is important that the material is as hard as possible, although its microstructure and surface are also important factors. The recommendation here is therefore usually for alloy steels containing chromium or tungsten, which are hard.

### **Impact and shocks**

This type of wear occurs in, for example, crushers and excavator buckets. If this is the main wear mechanism, it is important to use a steel that combines toughness and ductility, so that it can absorb the shocks by deforming instead of by cracking. However, such wear often occurs in combination with abrasive wear, which requires a hard surface. Chromium and tungsten alloys, mentioned above, are relatively brittle which, although unimportant when abrasive wear is the only mechanism, would result in cracking if they were exposed to impact. For applications such as crushers and hammers, an alloy containing 14 % manganese is therefore widely used, as it produces a hard surface with a ductile interior.

### **Heat, oxidation and corrosion**

Tools used for hot working processes and for casting are exposed to cyclic thermal loads, which eventually result in fatigue failures. Working in an oxidising environment produces a layer of oxide on the surface, which can then crack due to thermal expansion, exposing new metal for oxidation and allowing the process to continue until the part is entirely worn away. This particular form of wear is resisted by the use of nickel and cobalt alloys, which have high resistance to abrasive wear, corrosion and thermal fatigue.

### **Cladding materials and welding methods**

Appropriate cladding materials and welding methods have been developed for each of the four main classes of wear described above. However, a common feature is that hard alloys should not be applied in more than 2–3 layers, as their poor coefficients of thermal conductivity can result in the cladding cracking or separating from the underlying material. A further common requirement is that there should be as little mixing with the body material as possible, in order to avoid degradation of the properties of the cladding. For



this reason, a foundation layer of less hard alloys is often applied, with the fully hard surface layer applied on top of it.

TABLE 11.1 *Cladding materials.*

Type of steel	Properties	Application/ resists
Low alloy, low carbon	Tough	Building up / friction resistance
14 % manganese	Tough, work hardens	Shocks and impact
Martensitic	Tough and hard	Shocks and abrasion
Chromium carbide, tungsten carbide	Hard, brittle	Abrasion
Cobalt and nickel alloys	Hard at high temperatures	Tool steel/ Corrosion, high temperatures

## 11.3 Thermal spraying

Thermal spraying is used for applying metallic or ceramic layers to metals, for such purposes as producing a corrosion-resistant or wear-resistant layer on low-alloy steel, for making good material lost by wear and tear or a machining error, or for applying electrical or thermal insulation. Layer thicknesses vary from about 10  $\mu\text{m}$  up to a few mm – sometimes even tens of mm, depending on the application.

The method is particularly important for various types of repairs. Large, expensive shafts, blocks, rolls etc., that have been worn down to sizes outside their permitted tolerances, can be restored to a usable condition by a modest work input. Thermal spraying is also very suitable for use as a method of construction, where there is a need to apply various types of corrosion-resistant or wear-resistant layers to metal surfaces.

The most important methods of thermal spraying are *flame spraying*, *high-velocity flame spraying*, *arc spraying*, *plasma spraying* and *detonation spraying*. Each has somewhat different application areas, depending on the type of material, cost and performance. All can be used for spraying metallic materials, but not all are suitable for spraying non-metallic materials.

### Principle

The principle of thermal spraying is that an appropriate cladding material, in the form of wire or powder, is heated to its melting point by the thermal energy in a flame or arc, with the molten particles then being carried by a jet of gas on to the workpiece. The particle sizes are of the order of 50–200  $\mu\text{m}$ .

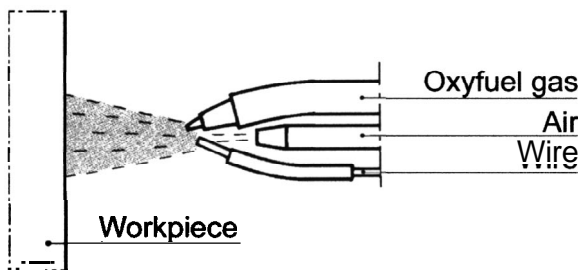
Cladding layers applied by flame or arc contain about 5–15 % by volume of pores, and up to 5–15 % of oxides. Porosity and oxide contents of layers applied by high-velocity flame spraying and (in particular) plasma spraying are lower. The strength of the cladding depends on its material analysis, pretreatment of the workpiece and the spraying method used. When spraying steel, the strength is low in the spray direction (20–80 N/mm<sup>2</sup>), but better in the longitudinal direction (80–150 N/mm<sup>2</sup>).

Spraying is carried out using a flame spraying gun, which is of a size that can be handled manually. Nevertheless, it is often mounted on a support, with the workpiece arranged to rotate or travel in front of it. This is essential when thin, uniform layers are to be applied. Pretreatment of the workpiece can involve degreasing and roughening of the surface by blasting, rough turning or grinding. The aim is to achieve a matt surface with an appropriate key. Turning creates a corrugated surface, thus increasing the surface area and improving the adhesion of correctly applied cladding.

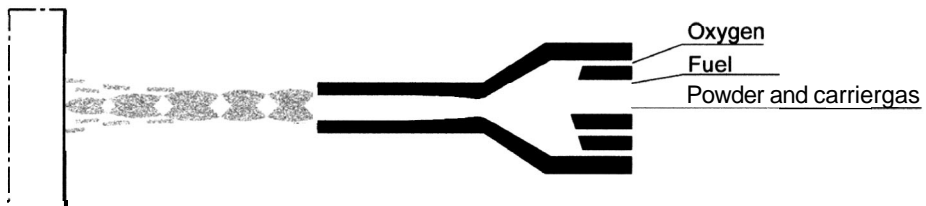
It is common first to apply a bonding layer of special material before applying the final top layer. The bonding layer should be thin and even, but with good coverage.

## Flame spraying

The heat source for flame spraying is a flame, produced (as for gas welding) by combustion of acetylene or propane in oxygen. The cladding material, in wire or powder form, is fed continuously into the flame, where it melts, and the molten particles are then blown on to the workpiece by a jet of compressed air.



*Figure 11.1 Schematic diagram of flame spraying with wire.*



*Figure 11.2 Schematic diagram of high-velocity flame spraying.*

## High-velocity flame spraying

High velocity flame spraying is often also referred to as HVOF spraying (high velocity oxy-fuel spraying). The method, which has developed rapidly in recent years, produces

a high velocity of the molten particles, giving a very strong, dense layer, with less than 1 % porosity and low oxide inclusion.

Fuel gases may be paraffin, LPG or hydrogen, burnt with oxygen at high pressure in a combustion chamber. Temperatures of 2700–3100 °C are reached, depending on the fuel gas. The gas leaving the combustion chamber is accelerated to supersonic velocity (1500–2000 m/s) in an appropriately shaped nozzle. The high velocity produces characteristic shock waves in the flame, which are visible as a diamond pattern (see Figure 11.2). The gun is often water-cooled. The cladding material is generally applied in powder form, fed into the nozzle by an inert gas.

## Arc spraying

This method uses an electric arc as the heat source, struck between the tips of two sacrificial electrodes made of the cladding material. The electrodes are fed continuously into the arc, where they melt, and from which the molten particles are blown onto the workpiece by a jet of compressed air or gas. The cladding material is always a metal, as it must be electrically conductive. Different materials can be used in the two electrodes, to produce a cladding that is a mixture of both of them.

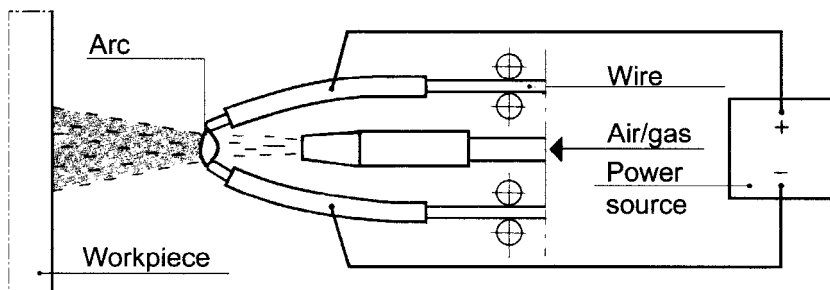


Figure 11.3 Schematic diagram of arc spraying.

Arc spraying generally produces the best adhesion to the workpiece, and also the lowest production costs apart from spraying zinc-rich materials. However, some alloying constituents – and particularly carbon – can be vaporised, which complicates spraying of high-carbon cladding materials.

## Plasma spraying

Plasma spraying often uses an arc as the heat source, struck between two non-sacrificial electrodes. A flow of gas past the arc blows the arc plasma out through a nozzle: at 10 000–20 000 °C, the plasma temperatures are higher than the temperatures used in other spray methods. Gases commonly used are H<sub>2</sub>, N<sub>2</sub>, Ar or He.

The cladding material is supplied in the form of wire, bare or powder, and fed into the arc, where it melts and is conveyed to the workpiece by the plasma jet. Powder is the most commonly used form. The high temperature of the plasma enables ceramics and metal oxides with high melting temperatures to be sprayed.

The equipment is more expensive to buy and run than that for the other methods described above, and so plasma spraying is less often used for spraying simpler materials with less oxidation sensitivity. Its main application area is for spraying non-metallic materials for cladding metallic materials with electrically insulating layers.

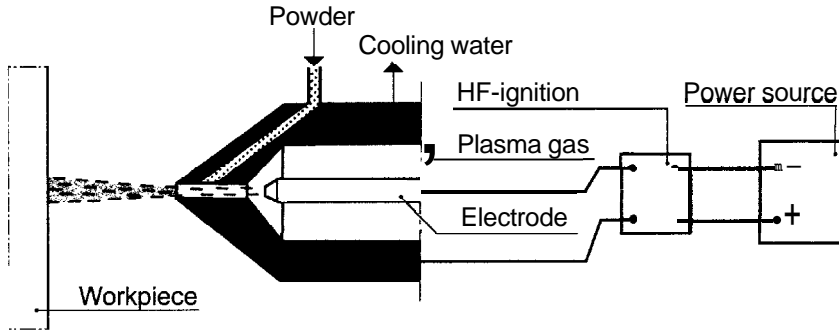


Figure 11.4 Schematic diagram of plasma spraying.

For optimum process control, plasma spraying can also be carried out in a vacuum chamber or a chamber with some suitable controlled atmosphere.

## Detonation spraying

Detonation spraying involves the use of something akin to a large water-cooled rifle barrel, loaded with a mixture of acetylene and oxygen, with the cladding material in powder form. A spark plug ignites the mixture, and the flame front melts the powder and drives it at the workpiece at a velocity that is even higher than that of HVOF. This is repeated at a cycle rate of about 5 Hz, producing a very dense layer with good adhesion.

## Thermal spraying and the work environment

Arc spraying, high-velocity flame spraying and plasma spraying all produce very high noise levels, which means that operators must wear hearing protection, and that the use of acoustically insulated working areas is recommended. Further, a spray booth with extraction ventilation to deal with smoke, gases and surplus powder is also advisable.

# 12 Mechanisation and robot welding

Mechanisation of arc welding can be applied in a number of levels, from the very simplest to the highly sophisticated. Welding equipment was originally divided into manual (e.g. when using coated electrodes), semi-automatic (for MIG/MAG welding, with the filler wire feed being mechanised) and automated (e.g. for submerged arc welding, with both the filler wire feed and movement of the welding head being mechanised).

The introduction of the welding robot provided a further level in that, in addition to starting and stopping, the **program-controlled** movements of the robot could also include moving between welding positions. Fully automatic welding arrived with pallet-controlled loading and unloading of workpieces, as used in Flexible Manufacturing Systems (FMS). These systems are generally used for smaller and medium-sized items, with the welds being made under shielding gas.

Mechanised welding can improve productivity, the quality of the welds and working conditions. In many situations, mechanisation can be used to perform welding that is not possible with manual processes: an example of this is narrow-gap welding.

## 12.1 Narrow-gap welding

Narrow-gap welding has the following advantages:

- lower energy requirements
- reduced consumption of filler materials
- reduced end-to-end working time
- reduced distortion of the workpiece.

Narrow-gap welding is suitable for joining sheet and plate in the 25–300 mm range. Joints to be welded are prepared with parallel sides or slightly U-shaped, as shown in Figure 12.1. Joints with parallel sides are cheap to prepare, although difficulties can arise as a result of contraction during welding, which has the effect of narrowing the remaining (unwelded) gap.

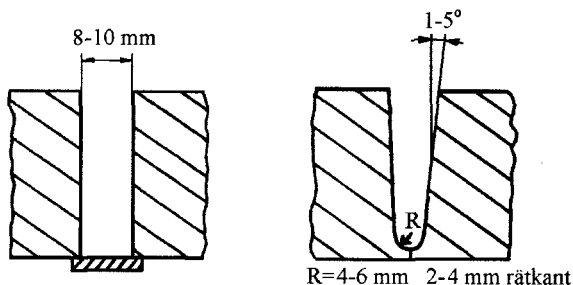


Figure 12.1 Joint types for narrow-gap welding.

The U-shaped joint is to be recommended, as no additional backing is required, it is easier to melt the walls of the joint at the bottom edge and the shrinkage caused as the weld metal contracts on cooling is less troublesome.

The cost benefits of narrow-gap welding result from its low energy and filler material costs, together with the shorter time required to fill the considerably smaller weld volume. Other factors include less complicated joint preparation, reduced time at elevated working temperatures and less distortion due to the smaller volume of weld metal. A prerequisite for a successful result is properly managed process control, in order to avoid weld defects. The welding heads are of special design, with precision mechanical control. Narrow-gap welding is used primarily for MIG/MAG, TIG and submerged arc welding.

### Narrow-gap MIG

To ensure proper melting of the sides of the joint, the arc should alternately welded to the left and right side of the joint. The arc can also be controlled by winding two filler wires around each other, which causes the arc to move constantly between them, angled outwards and rotating as the filler wire is melted.

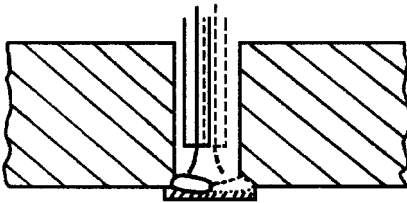


Figure 12.2 MIG welding of two beads beside each other, one at a time, with a rotatable welding head.

### Narrow-gap TIG

TIG produces a high quality weld metal in all welding positions. It is particularly suitable for use in narrow joints, bearing in mind its normally otherwise low productivity. The most important elements for successful welding are good gas protection and ensuring that the arc reaches the edges of the joint. This method is used primarily for stainless and low-alloy steels.

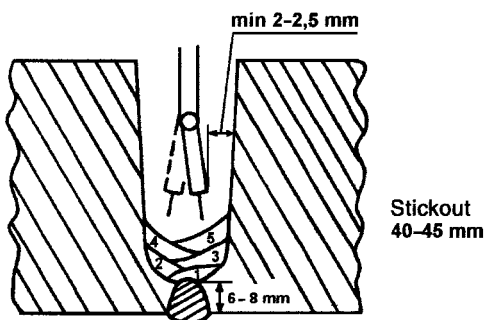


Figure 12.3 A narrow-gap U-joint, suitable for submerged arc welding.

### Narrow-gap submerged arc welding

A submerged arc welding head for narrow-gap welding must itself be narrow.

The best method of this mode of welding is to lay down beads, alternately to the left and to the right. The electrode should be angled towards the wall of the joint, and be carefully positioned. With the correct welding positions, the slag will loosen by itself. This means that, when welding cylindrical rotating workpieces, the slag falls off by itself.

## 12.2 Arc welding using robots

### The welding robot station

An arc welding robot cell normally consists of a robot with its control equipment, a manipulator for the workpiece, a welding power unit and other welding equipment. Robots now often have six axes of motion, and there may also be one or more axes on the manipulator that positions the workpiece. The manipulator may be a two-station interchange type, so that the operator can load and unload jigs while the robot is welding, as shown in Figure 12.4.

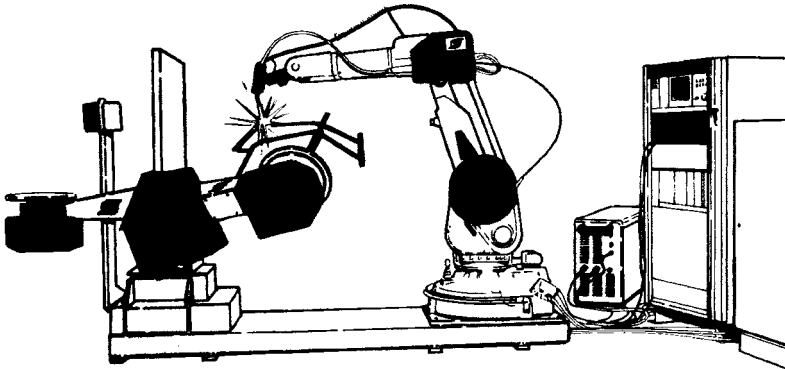


Figure 12.4 A robot cell for arc welding with an interchange type manipulator.

### Programming the robot

The robot is programmed to weld from one point to the next on the workpiece. The operator controls the robot with a joystick and identifies the various positions at which an 'event' occurs, e.g. where the robot changes direction, the welding parameters change or the robot starts or stops welding. The coordinates of the positions are saved in the robot's memory, together with the associated instructions. For arc welding, it is not only the position of the electrode that is important, but also the angle of the welding gun relative to the joint. Other welding data such as wire feed speed, voltage and travel speed are included in the programming. If necessary, a weaving action can also be applied to the main travel motion.

A welding robot station normally also includes a manipulator to position the workpiece, not only to ensure that the robot can reach all the joints, but also to ensure that welds can be carried out in the best position. The workpiece itself may make all or some of the necessary movements.

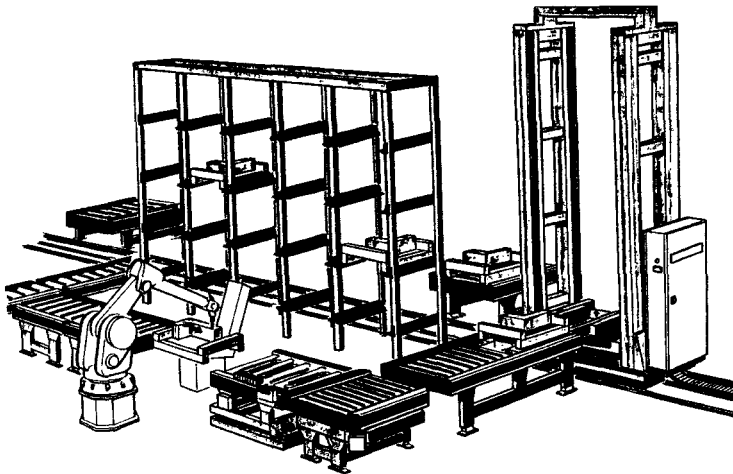
Programming is usually carried out on-line at the workpiece, although it is also possible to use special software that allows a considerable part of the work to be carried out on a separate computer. This is referred to as off-line programming (OLP). Off-line programming avoids expensive standstill time for the robot cell, i.e. when it is being used for programming, rather than for revenue-generating work. A large workpiece may require over an hour's welding, and each minute of welding time can take an hour to program.

In its most advanced form, off-line programming uses sophisticated 3D graphics programs into which information on the robot system, jigs and workpiece are loaded, so that the necessary weld motions can be programmed and controlled directly on the screen. In such cases, information on the workpiece design is provided directly from the CAD system. Although it may be necessary to perform final fine-tuning on the robot itself, this procedure greatly reduces the standstill time.

Other types of off-line programming can be used to convert stored coordinates for a particular model (typical) case: this requires some degree of similarity between the various items to be welded.

### **Welding in flexible manufacturing systems**

Flexible manufacturing systems (FMS) include handling of the workpiece, and can have several positions for loading and unloading the workpiece-carrying pallets. Systems may use one or more robots, and several different types of workpieces can be welded one after the other, with only short changeover times. The use of buffer stocks enables production to continue completely unattended for some time. The entire facility is monitored and controlled by a supervisory computer system.



*Figure 12.5 A flexible manufacturing system (FMS) station for robot welding.*

### **Extending the working area**

Several alternatives are available to increase the range that robots can cover when dealing with large workpieces, e.g. by mounting the robot on rails or supporting it from a hanging post or a gantry. This means that, in addition to the robot's own six motion axes, with perhaps two on the workpiece manipulator, there can be up to a further three axes



for moving the robot. Modern robot control systems can provide full coordination of motion on all the axes, i.e. the robot's own axes and the external axes.

An extended working range can also be used to transfer the robot between welding stations so that it can be used with several workpieces.

### Safety

Robot installations are fenced in order to prevent injuries to persons. Unauthorised persons must not be within the working area of the robot while it is in operation. The normal form of protection is a high fence, with access points protected by light beams that automatically stop the manipulator or robot if anyone attempts to enter the enclosure. Only specially trained programmers or service technicians are allowed to work within the robot's working area, and then only with special protective equipment and procedures. In addition, there are emergency stop buttons, which should preferably be straightforward to reset after operation.

### Tools and tool maintenance

The welding gun can be spatter-cleaned at appropriate intervals, under control of the robot program. The robot moves to a special position, where the welding nozzle is mechanically or pneumatically cleaned.

There are also tool change systems, e.g. for replacing the welding gun for maintenance, for changing the welding process or even for changing to a completely different task, such as grinding.

### Tolerances

Spot welding by robots is an established method, that has been successfully used since the early 1970s. This is because the required accuracy of positioning spot welds is often  $\pm 1$  mm, which was therefore within the accuracy of repeatability of the first generation of robots. The welding clamp is positioned, and then closed to close the gap between the two pieces of metal to be joined and force them into position. Relatively large tolerances can be accepted in respect of the positions of the sheets to be joined.

Arc welding, on the other hand, requires considerably closer tolerances: nevertheless, it is often possible to weld smaller and medium-sized workpieces without the use of joint tracking equipment. The variation in the position of the arc between corresponding workpiece positions must not normally exceed  $\pm 0.5$  mm, and achieving this accuracy requires very high accuracy of the workpieces, jigs, manipulators and welding equipment.

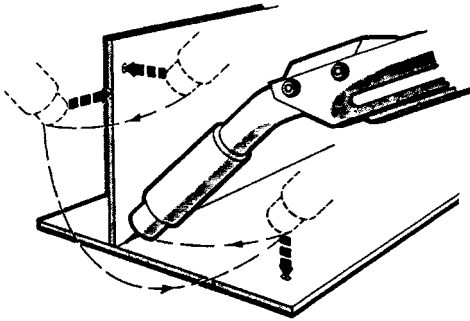
The filler wire electrode is the last link in the chain. The wire is seldom completely straight and centred when it emerges from the contact tip. Instead, it is often slightly bent and, if the contact tip is worn, there is a risk of the necessary tolerance requirements not being met. The slight pre-bending of the filler wire is intended to ensure sufficient contact pressure against the contact tip. However, when carrying out robot welding, it is important that this pre-bending is not excessive, and that the contact tips are replaced sufficiently often.

The difference between a human welder and a robot welding several essentially identical items is that the human welder can see if the joint to be welded is too wide or too narrow, and can then adjust the current, weave the welding head, reduce the travel speed,

bend the workpiece or take some other steps to ensure a good end result. The robot, on the other hand, might produce a poor welded joint under these conditions.

## Joint location and joint tracking

In most cases, it is possible to find ways of meeting the tolerances in robot welding without having to use joint location or joint tracking equipment. However, when welding large workpieces, it may be impossible to maintain the tolerances required for a successful weld.

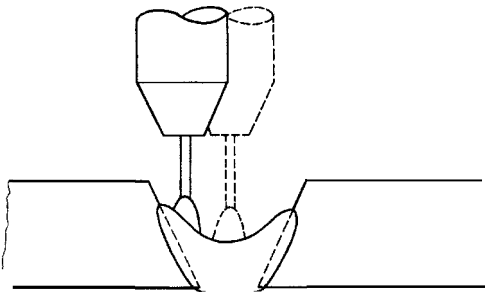


*Figure 12.6 The workpiece position is located in order to correct the programmed track so that it coincides with the actual physical position of the joint.*

## Joint location

In the simplest case, it may suffice with one joint location operation. This is done by the robot before welding starts, by locating the position of the workpiece or of the surfaces of the joint, e.g. by establishing electrical contact between some part of the welding gun and the joint.

A location search can be carried out, for example, for three surfaces in mutually perpendicular directions. This is followed by appropriate parallel displacement of the robot's programmed motions, in order to locate the starting point of the weld and eliminate position error, at least in the area where joint location was carried out.



*Figure 12.7 If the arc length or the exposed filler wire length changes when the electrode weaves across the joint, a corresponding change occurs in the welding current and can be used for joint tracking.*

### Joint tracking

A joint tracking system can be used when making long welds in order to provide real-time correction for any deviations between the programmed position and the actual position of the weld. The commonest system for use with robot welding is to use the arc itself as the sensor. The arc is made to weave across the joint from side to side, and the control system compares the arc voltage or current at the end positions with the expected values at those positions. Arc sensing has become popular because it does not require any extra space-demanding equipment, and because it tracks the joint at the position of the arc.

Optical joint tracking devices are also used, e.g. using a laser scanner to determine the positions of the joint surfaces in front of the arc.

### Advantages and drawbacks

In cost terms, a welding robot cell for MIG/MAG welding is economic for a throughput of a welded structure or some welded item of between 1000 and 60 000 units per year. For numbers less than this, the cost of programming the robot and manufacturing jigs would be unlikely to be repaid, while for greater numbers it would be better to invest in a larger or more sophisticated installation that would weld several joints at the same time. However, in some cases, even small production numbers can be worthwhile, if FMS equipment or off-line programming can be used.

The benefits of an arc welding robot cell are:

- Higher productivity - the arc time factor rises from 30–40 % to 60–80 %, and the welding speed can also generally be increased. One robot plus operator can normally replace 2–4 manual welders.
- Weld quality becomes more consistent, and generally higher.
- Working conditions are improved, as the operator does not need to stand in the vicinity of the struck arc.
- The necessary organisation and improved control of peripheral activities associated with the introduction of a robot have a beneficial effect on general efficiency.

The drawbacks are:

- A substantial need for training, both for programming and for servicing.
- Closer tolerances on parts to be welded and on jigs.
- A probable need for redesign of parts to make them suitable for robot welding.

## 12.3 Mechanised TIG welding

Mechanised TIG welding produces excellent, smooth welded joints of very high quality. The process is used for applications such as welding stainless steel, nickel alloys and aluminium. Special tools are often used for erection welding of parts such as stainless steel tubes (see Figure 12.9), when welding heat exchanger or condenser tubes into tube plates or for narrow-gap welding (see Narrow-gap TIG on page 115).

## Process parameters

### Filler wire

Filler wire is required to fill joint gaps, and is supplied from a wire feed unit. The wire is fed directly into the weld pool, usually in front of the arc and without having first been melted by the heat of the arc.

A variant of this is the hot wire system, in which the filler wire is preheated by a separate power supply, as shown in Figure 12.8. The heating current should preferably be adjusted to suit the wire feed speed. The weld speed can be increased, as less of the energy in the arc is needed in order to melt the filler wire material, which results in important benefits when compared with the use of cold filler wire.

- There is less risk of pore formation, as preheating the wire assists the release of gases trapped in the weld pool.
- A high melting rate, up to 8 kg/h of molten material for steel.
- Reduced heat input and less risk of distortion.

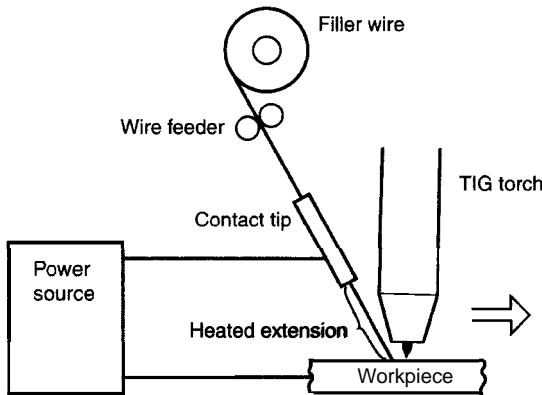


Figure 12.8 TIG welding using the hot wire system. Note that the wire is fed directly into the weld pool without having first been melted by the heat of the arc.

This arrangement requires the welding equipment to be complemented by an additional wire feed unit, together with a special welding gun for the filler wire. The wire is fed into the weld pool at an angle of about 40°, and is heated by AC in order to reduce magnetic arc wind effect on the arc.

### Arc length control

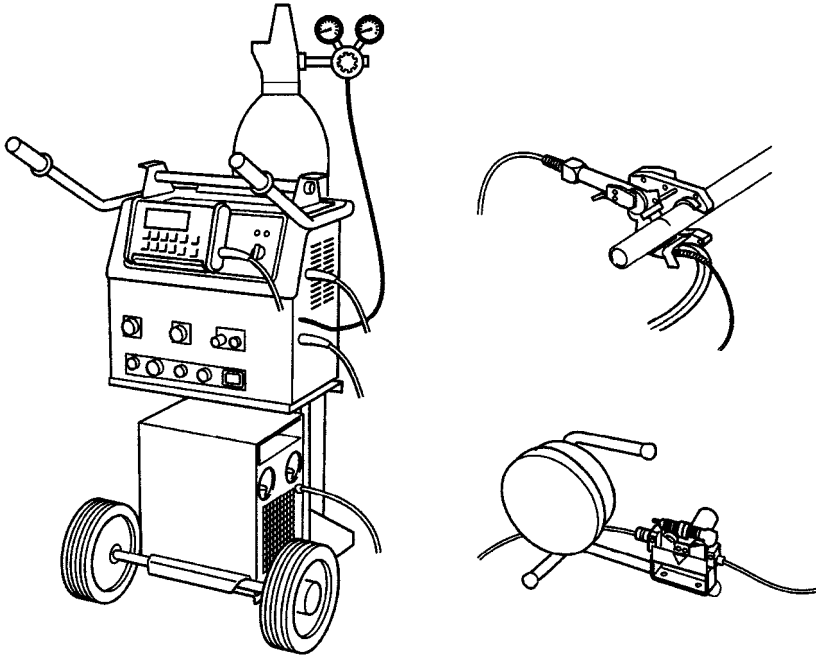
In order to keep the arc length constant, the equipment often includes a facility (Arc Voltage Control, AVC) that raises or lowers the electrode in response to a signal from the arc voltage, so that the electrode follows the profile of the workpiece and maintains a constant arc length.

### Other adjustments

Equipment for mechanised TIG welding often incorporates advanced control facilities, such as programmable welding parameter 'groups' to suit particular types of joints or

materials. Parameters that are usually controlled in this way can include the welding current, pulsing, weaving, wire feed etc.

Tube welding equipment uses special tools as shown in Figure 12.9. When welding horizontal tubes, the welding head must travel round the periphery of the tube, which means that its angle must constantly change to suit the position. It is therefore possible to program different welding parameters for different sections of the weld.



*Figure 12.9 Welding equipment for mechanised TIG welding, with the power unit and cooling unit mounted on a trolley together with the necessary gas bottle, tube welding tool and filler wire feed unit.*

## 12.4 Quality requirements for mechanised welding

### General measures

When an experienced manual welder makes a weld, he will notice whether any part of the equipment or process is not operating as it should. He monitors the process, and makes sure that the end result is good. If necessary, he can apply corrections. **Mechanised** welding, on the other hand, faithfully and accurately repeats programmed motions. It is therefore important to ensure that all other factors are kept sufficiently constant to ensure a successful result. The basic principle is that the tolerances that the welding process can accept should be greater than any departures or deviations that are likely to occur. Unfortunately, the acceptable tolerances tend to decrease as pressure to raise productivity increases. It can therefore be relevant to use (additional) equipment for monitoring the welding process in order to ensure the necessary quality.

Typical examples of factors that can adversely affect the process are:

- Gap width variations in the welded joint
- The position of the electrode tip relative to the joint
- Problems with wire feed.

The following factors can be important in order to ensure that the necessary quality is maintained:

- Appropriate design and choice of joint type
- Use, wherever possible, of the most favourable welding position
- Preventive maintenance of the equipment
- The use of welding equipment that can control and maintain set values
- The use of monitoring equipment.

Special methods can be used for dealing with difficult situations:

- Weaving, or slow thermal pulsing, can make the process less vulnerable to variations such as gap width changes
- Joint tracking.

## Monitoring

Quality standards require welding procedures to be described in a Welding Procedure Specification (WPS). Some form of monitoring should then be employed to ensure that the specified welding parameters are being maintained.

## Recording

The simplest form of monitoring is recording of the relevant parameters, possibly accompanied by visual display. Typical parameters for such monitoring include current, voltage, wire feed speed, gas flow rate and possibly the linear welding speed. The equipment should preferably be suitable for connection to a PC for presentation and documentation of the information.

## Supervision with alarm limits

By setting appropriate tolerance limits, the equipment can generate alarms if any of the monitored parameters moves outside the permitted range. The alarms may be generated instantly when a passage occurs, or be made to respond only to an average signal so that brief excursions are ignored. Double limits can also be used, so that traversing the first limit provides a warning, while traversing the second limit stops the equipment.

# 13 Soldering and brazing

## 13.1 General

Soldering and brazing are important industrial methods of bonding metals, and are especially widely used in connection with mass production. They have their given applications in connection with particular materials and components, for which welding is unsuitable due to the considerably higher temperatures and limited abilities to bond different metals. Soldering and brazing are simple and suitable bonding processes for joining ferrous metals to non-ferrous metals, and for bonding metals having very different melting temperatures. They are the main methods of bonding used in the manufacture of products made of copper or copper alloys. Although the main applications differ from those of welding, they can in many cases be fully acceptable alternatives to welding.

The processes are economic due to the lower working temperatures and to the fact that there is generally no need for any substantial chipping, grinding or cleaning of the joint as a finishing process.

The following section gives an introduction to soldering and brazing methods by describing the fundamental principles, with brief descriptions of the various methods.

### Description

Soldering or brazing involves heating the area to be joined to the working temperature of the filler metal, or to a somewhat higher temperature. As the working temperature is always lower than the melting temperature of the base material, and generally very much lower, the base material will remain solid throughout the process. This is the main difference in principle between soldering/brazing and welding. A flux is generally used in order chemically to remove oxides from the surfaces and to prevent new oxide layers forming during the heating process. If the surfaces are sufficiently clean, the molten filler metal can wet them and diffuse into the base metal. This produces an alloy of the metal and the base material in a thin layer in the bond zones (see Figure 13.1), thus producing an uninterrupted metallic bond in the form of the soldered or brazed joint. Thermodynamic processes result in both materials diffusing into each other: the elevated temperature of the process causes elements from the added metal to diffuse into the base material and vice versa (erosion).

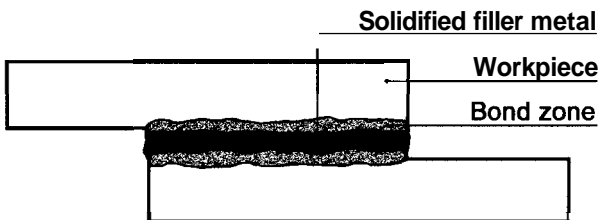


Figure 13.1 Schematic diagram of a brazed joint.

The composition and structure of the bonding layer can be decisive for the strength of the joint, and so it is important to choose a filler metal that is compatible with the base material.

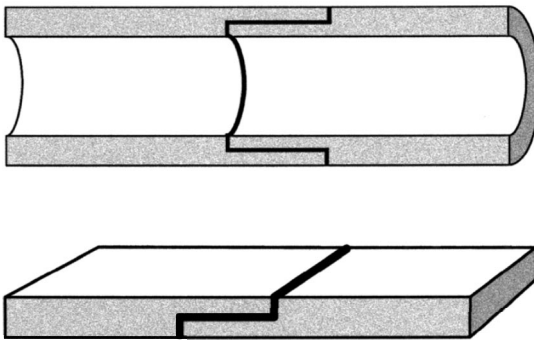
The solidified layer of filler metal in the joint must be thin if the best strength and fill properties are to be achieved, which means that only in exceptional cases may the gap between the two pieces to be joined exceed 0.5 mm. Narrow gaps draw the molten metal into them by capillary attraction, with the best fill being obtained when the gap is between 0.05 mm and 0.25 mm. A brazing alloy with a narrow working temperature range normally penetrates better than one with a wider working temperature range.

### Types of joints

Brazing uses the same types of joints as does welding, i.e. the ordinary butt and overlap joints: See "Joint types" on page 6, as well as a **combination** of them, in the form of the butt overlap joint, as shown in Figure 13.2.

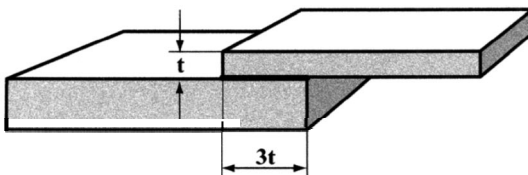
The strength of a brazed joint depends on various factors, including the area of the joint. The greater the area, the greater the forces that the joint can withstand.

As it is not necessary, when preparing a brazed joint, for the joint to be manually accessible throughout its length, a geometry such as that of the butt overlap joint or similar can often be used.



*Figure 13.2 Butt overlap joints.*

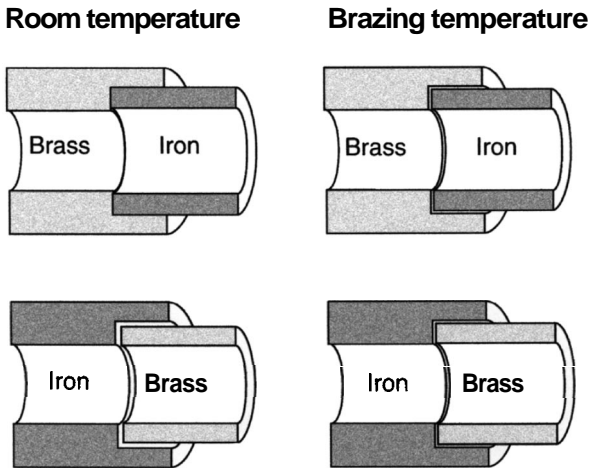
An overlap width equal to about three times the thickness of the thinner part should be aimed at, in order to provide sufficient strength of the joint: see Figure 13.3.



*Figure 13.3 Three times the thickness of the thinner part is a suitable lap length.*



A particular problem when making brazed joints is that of the previously mentioned gap width. When joining dissimilar metals **and/or** different thicknesses, the width of the gap changes (either increasing or decreasing) as a result of different rates of expansion of the metal as it is heated to the working temperature: see Figure 13.4. A suitable gap width is normally obtained by placing the parts in contact with each other, without any additional pressure.



**Figure 13.4** Different combinations of materials can result in the gap increasing or decreasing as the parts are raised to working temperature.

## Definitions

**Soldering, Brazing.** Bonding metal parts by means of a molten bonding material (*solder, brazing filler metal*) that has a lower melting point than the base **material(s)**, and which wets the surfaces of the joint.

**Solder, Brazing filler metal.** The metallic material used to make the soldered or brazed joint.

**Flux.** A meltable or gaseous material, intended to dissolve oxides and to prevent the further formation of oxides.

**Wetting.** The ability of the solder or brazing metal, when molten, to spread over and connect the joint surfaces (the substrate).

**Diffusion.** The alloying process, with one of the components remaining in the solid state throughout.

**Working temperature.** The temperature to which the joint must be raised for the solder or brazing alloy to melt and wet the joint surfaces.

**Melting interval, Solidifying interval.** The range between the lower and the upper melting temperature (**solidus** and **liquidus** temperatures).

## Different types of methods

Both soldering (which can also be called soft soldering) and brazing are processes that rely on the penetration of a capillary gap by a molten filler material, at a temperature which is below the melting point of the materials to be joined. The distinction between

the two processes depends on the working temperature: if it is below 450°C, the process is referred to as soldering; if it is above 450°C, it is referred to as brazing.

Brazing may also sometimes be referred to as hard soldering.

Depending on the design of the joint, we distinguish between:

- *Capillary joint*, where the solder is drawn into the joint – which must be less than 0.5 mm wide – by capillary attraction.
- *Braze welding*, where the gap exceeds 0.5 mm, or is a V or X joint.

*Braze welding* is a type of brazing, but is carried out with a procedure, and for types of joints, that is/are similar to gas welding. Soft soldering and brazing are normally carried out as gap-brazing, while braze welding is a method where filler metal is not distributed by capillary action.

Both soft soldering and brazing can be divided into a number of working methods, depending on such factors as how the heating is applied.

- *Manual soldering*, using a soldering iron, which is usually electrically heated. This method is used only for soft soldering.
- *Flame heating*, using an open flame.
- *Solder baths*, containing molten solder and in which the parts may be completely or partially immersed. (Parts may also be immersed in molten flux.)
- *Furnace soldering*, in which the workpiece, with preplaced solder (known as solder preforms) and flux, is heated in a furnace, generally on a conveyor. Parts may be protected by an inert atmosphere.
- *Induction heating*, with the heat being generated by high-frequency induction.
- *Resistance heating*, by passing an electric current through the workpiece to produce resistive heating. As with furnace soldering, solder and flux can be preplaced.
- *Arc brazing*, using an electric arc and brazing metal. This method is similar to MIG (*MIG brazing*) or stud welding.
- *Infrared soldering*, using infra-red radiation from high-power halogen lamps and reflectors.
- *Laser soldering* is another example on radiant heating.

The choice of soldering method depends on the design of the workpiece, the quantities to be soldered and similar factors.

## 13.2 Soft soldering

The most commonly used solders for soft soldering are alloys of tin and lead, although a wide range of other alloys are used to a lesser extent, often for special purposes. [Table 13.1](#) lists the compositions of normal types of solder.

Solder is often supplied in the form of wire or bars, generally with flux cores.

Fluxes are often weak acids or salts. As they are corrosive, their residues must be removed from the joint after soldering. An alternative, which does not normally result in corrosion if traces are left, is the use of resins dissolved in an organic solvent. There are also liquid and paste fluxes.

Copper and its alloys are the materials that are most commonly joined using soft soldering. The solder is normally a tin-lead alloy, and the flux is a non-corrosive or only mildly corrosive flux. Similar fluxes are also used for soldering mild steel.

Strongly active fluxes must be used for soft soldering of materials with chemically stable oxide films, such as aluminium or stainless steel, in order to remove the oxide and allow the solder to come into contact with a sufficiently clean metal surface. To produce a satisfactory joint, stainless steel should be pickled immediately before soldering. Examples of solders used for aluminium include alloys of zinc and cadmium, or zinc and aluminium.

TABLE 13.1 Composition of common solders.

Sn	Pb	Cd	Bi	Ag	Sb	Zn	Cu	Melting range, °C	Application
99.9	Trace							232	Tinning, (food tins)
63	37							183	Cu, steel etc. (the commonest solder)
60	40							183-188	
50	50							183-226	Brass, solder baths
50	32	18						145	Heat-sensitive parts
42			58					138	
		44.5	55.5					124	
60	38						2	183-188	Electronic assemblies, corrosion-resistant
22	28		50					95-107	
12.5	25	12.5	50					70-74	
96.5				3.5				220	Cu pipes (HVAC work)
95.5				3.8			0.7	217	Electronic items (lead-free)
	97.5			2.5				305	Electrical work at high operating temperatures
95					5			233-240	Food industry (not copper)
		70				30		300-350	Al and Al alloys

Although much soft soldering is carried out manually, the process is also very suitable for mechanisation. In the latter case, the gap between surfaces to be joined should be narrow, not more than 0.2 mm, in order to ensure that the molten solder can reach all parts by capillary attraction. The commonest joints for such processes are various types of overlap joints.

Mechanised processes are used for such applications as the manufacture of circuit boards for electronic products.

## 13.3 Brazing

The key factors in determining the quality of a brazed joint are the method of brazing, the composition of the brazing filler metal and the flux. For use as a filler material, a metal or alloy must have a lower melting point than the workpiece material, and must be able to wet the workpiece material. In addition, when molten, it must flow sufficiently easily to enable it properly to fill the joint. The resulting alloy must provide the necessary mechanical and physical properties, while the filler metal must not be vaporised to any significant extent during the heating process, as this could result in poor fusion. Metals in the following groups are those most commonly used as brazing filler metals: see also [Table 13.2](#).

Silver brazing alloys consist of alloys of silver, copper, zinc and sometimes also cadmium. They flow easily, with low working temperatures of 600–800°C. They can be used with all heating methods, and for almost all materials except aluminium and magnesium alloys. However, due to the toxicity of cadmium, filler metals containing it must not be used unless full evacuation of the brazing fumes is provided.

Copper phosphorus filler metals are based on alloys of copper and phosphorus, and may also contain silver. They are used almost exclusively for brazing copper and copper alloys. As phosphorus reduces copper oxide, the metal is self-fluxing, and so no additional flux is normally needed.

These filler metals are not suitable for brazing steel or nickel, as phosphides can be formed and embrittle the joint zone.

Copper and brass. Oxygen-free electrolytic copper is used for furnace brazing. Brass (from which the process name 'brazing' is derived), when used as a brazing filler metal, consists mainly of copper (40–80%) and zinc, and may often include smaller quantities of tin and silicon. It is used for brazing materials such as mild steel.

High-temperature brazing materials consist of nickel-based alloys and silver-manganese alloys. They are used for brazing components intended to operate at temperatures well above normal ambient temperatures, such as parts of gas turbines or steam turbines.

Aluminium brazing metals. Aluminium and its alloys are brazed with filler metals consisting of aluminium-silicon alloys or aluminium-silicon-copper alloys.

Filler metals are available in various physical forms, such as wire, bar, strip, foil or granules: some bar forms include flux cores or flux coatings. They can, of course, also be supplied in preform shapes, such as rings, washers etc.

Joint surfaces must be carefully cleaned if the best bond quality is to be obtained. Oxides must also be reduced, and/or oxide formation during heating must be prevented. One way of doing this is to make the joint in an air-free environment, e.g. in a furnace with a suitable inert gas atmosphere, or under vacuum. However, brazing is generally carried out in air, which means that self-fluxing filler metals (see copper-phosphorus, above) or a separate flux must be used.

The flux consists of a mixture of various metallic salts, and is applied to the joint surfaces as a high-viscosity liquid, as a paste or as a powder. Heating drives off the carrier (often water), before the salts melt and react with the oxides on the joint surfaces. The choice of flux depends on the type of workpiece material and the brazing temperature of the filler metal.

Brazed joints are generally some form of overlap joint. To a lesser extent, joints may be of butt type, but should be chamfered to improve the joint strength. The gap width should be in the range 0.05–0.5 mm, and preferably 0.1–0.2 mm.

Brazing can be performed manually, mechanised or automated.

TABLE 13.2 Composition of common brazing filler metals.

Type of alloy	Ag %	Cu %	Zn %	Sn %	Cd %	P %	Mn %	Ni %	Al %	Si %	Fe %	Melting range, °C	Working temperature, °C
Silver and cadmium-free	55	21	22	2								630-660	650
	45	27	25	3								640-680	670
	49	16	23				7.5	4.5				625-705	690
	49	27.5	20.5				2.5	0.5				670-690	690
	34	36	27	3								630-730	710
	44	30	26									680-740	730
	20	44.9	35					0.1				690-810	810
Silver and cadmium alloys	40	19	21		20							595-630	610
Copper-phosphorus alloys	5	89				6						650-810	715
	2	91.8				6.2						650-810	710
	15	80				5						650-800	705
		92				8						710-740	850
		93				7						710-820	
	94				6						710-850	850	
High-temperature materials	85						15					960-970	960
Bronze / brass		48	41.8					10		0.2		880-910	900
		60	39.7	0.1						0.2		885-900	900
		58	40	0.8			0.3	0.4		0.1	0.4	875-890	890
		47.5	41.5	0.1			0.3	10		0.3	0.3	890-900	900
Aluminium alloys	4								86	10		520-586	550
									87	13		575-582	580

## Braze welding

When used to make V or X butt joints, or for fillet joints, brazing is referred to as braze welding, and is generally performed manually with gas flame heating. The filler metal must be relatively viscous, in order to provide the best fill of the joint.

Various types of brass alloys and appropriate fluxes are generally used: see Table 13.2. This is nowadays a less commonly used process, but is employed to some extent for making joints in copper and copper alloy pipes, as well as for brazing bronze and cast iron.

## Arc brazing

Arc brazing is the name given to brazing methods based on arc welding methods. The most interesting field of applications here seems to be automotive body components manufactured of zinc coated steel sheet. The reason for this is that conventional fusion welding often is subjected to different problems due to the burn-off of the zinc coating and process instabilities such as pores and spatter. Brazing speed can often reach the double value compared to welding.

In arc brazing heat input is reduced and there is less vaporisation of zinc. The advantages of changing brazing filler metal with the low melting temperature is:

- Minimal amount of spatter
- Less post-treatment of the brazed seam
- Low heat input
- Low burn-off of the zinc coating

Filler material can be low-alloy copper-based (e.g. CuSi3Mn1), aluminium-bronze or tin-bronze based.

*MIG brazing* involves replacing the electrode in an MIG welding torch with an electrode made of a copper based brazing filler metal. The power ratings are set so that the filler metal melts, but the edges of the joint are only heated, and not melted, by the arc. The shielding gas used is pure argon or argon with a small amount of active gas that improves the arc stability. It is common to use argon with up to 2 % CO<sub>2</sub> as shielding gas. Pulsed MIG arc can be used to improve arc stability. MIG brazing allows a high joining rate. Brazing speeds up to 3 m/min can be achieved.

*TIG brazing* uses a mechanised feeding of the brazing filler wire. Pure argon is used as shielding gas.

*Plasma arc brazing* uses a plasma torch combined with a wire feed of brazing metal. The plasma arc is more stable and gives better brazing properties compared to MIG brazing. Generally argon is used both as plasma and shielding gas but small additions of other gases (He, H<sub>2</sub>) could be used to improve the brazing speed.

## Laser beam brazing

When joining thin sheets of steel laser beam brazing is an excellent alternative to the arc brazing technique. Both CO<sub>2</sub> and Nd:YAG lasers are used but also high power diode lasers are becoming available. For brazing the focus of the beam does not need to be as precise as for welding. The ability to increase the laser beam spot size by defocusing is an advantage. Filler wire is supplied by a wire feeder but can also be pre-placed.

Laser beam brazing cause very small heat-affected zones. The seam becomes very smooth and allows a minimum of after-treatment before painting.

# 14 The weldability of steel

The following section briefly describes the metallurgical **aspects/processes** and the suitability of various steels for thermal welding. Weldability means that the welding process is intended to produce as homogenous properties as possible in the weld, **i.e.** that the materials affected by the weld must have at least the same strength, corrosion resistance, oxidation resistance etc. as the base material. The properties of the weld metal **are** determined largely by the choice of filler material, the type of base material, the welding method and the welding methodology, while the properties of the HAZ are determined primarily by the composition of the base material and the amount of thermal energy delivered during welding.

Figure 14.1 shows the names of the various parts of the materials affected by the weld.

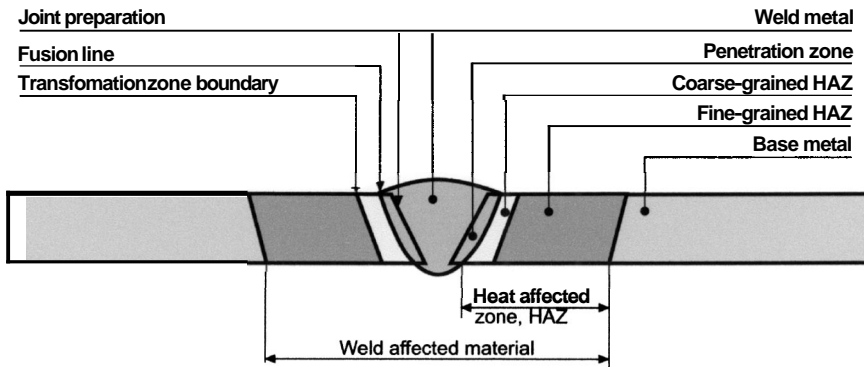


Figure 14.1 Nomenclature of zones and boundaries in heat affected zone.

## 14.1 Carbon steels

As used here, the term 'carbon steels' refers to plain carbon steel, carbon-manganese steel and micro-alloyed steel. Plain carbon steels **are** characterised by the alloying with up to **0.20–0.25 %** of carbon as the strength-determining element. Carbon-manganese steels contain, in addition, up to about **1.5 %** of manganese, with a maximum carbon content of **0.25 %**. Examples of such steels include **SS 13 12** and **SS 14 12** structural steels and **SS 13 30** and **SS 14 30** pressure vessels steels.

TABLE 14.1 Quality classes for plain carbon steels. (Source: IIW.)

Quality class	A	B	C	D	E
Degree of killing	Unkilled Semi-killed Killed	Semi-killed Killed	Semi-killed Killed	Semi-killed Killed	Killed
Impact toughness requirement, min. 27 J at:	–	–	0 °C	-20 °C	-40 °C

Microalloyed steel consists of a plain carbon steel or a carbon-manganese steel as the basic material, to which a small quantity (0.001–0.1%) of one or more alloying substances has been added in order to reduce the grain size of the material and thus improve the yield strength and give better impact toughness. Examples of such grain-size-reducing elements include aluminium, niobium, titanium, zirconium and vanadium.

Plain carbon steels have largely been specially developed as structural materials for welded structures.

The International Institute of Welding (IIW) divides steels up into five quality classes, A, B, C, D and E, depending on the method of manufacture and the requirements in respect of impact strength: see Table 14.1. The new European standard for general-purpose structural steel, EN 10 025-1993, gives a different classification for the steels, depending on their impact strength at various (low) temperatures.

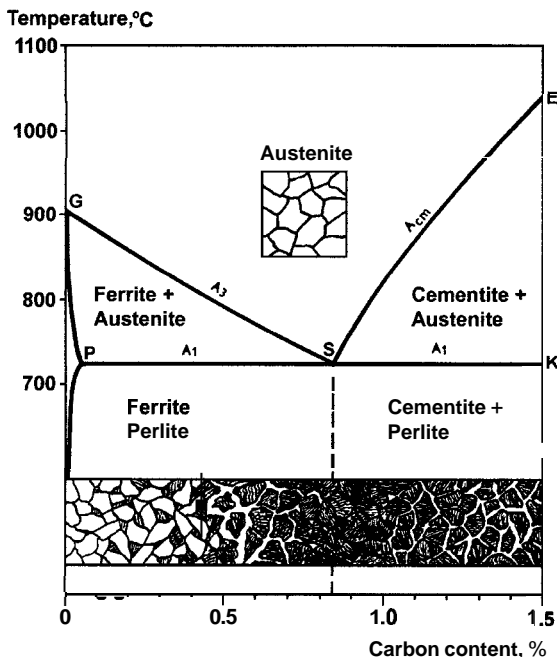


Figure 14.2 Part of the iron-carbon diagram, with a schematic representation of the structure.

### Changes in the grain structure resulting from welding

The iron-carbon diagram (Figure 14.2) can be used to explain the origins of the various zones in those parts of the base material affected by welding. It can be seen from this that steels with low carbon contents are predominantly ferritic, while pearlite (an eutectic mixture of ferrite and cementite) increases with increasing carbon content and cementite starts to appear in the grain boundaries at carbon contents over about 0.8%. Bearing in mind what was said above concerning the composition of plain carbon steels, it can be seen that they will generally have a ferritic-pearlitic structure. In the diagram, the PSK line represents the A<sub>1</sub> conversion temperature, the GS line represents the A<sub>3</sub> conversion temperature and the SE line represents the A<sub>cm</sub> conversion temperature.



Figure 14.3 shows the primary structure of a single-pass weld. Heat flows quickly from the weld to the base material via the surface represented by the line **abc**, while the surface **adc**, exposed to the atmosphere on the top of the weld, loses heat less quickly. As the metal solidifies, the primary grains grow perpendicularly **from** the surface that is losing heat the most quickly, **i.e.** the melt face.

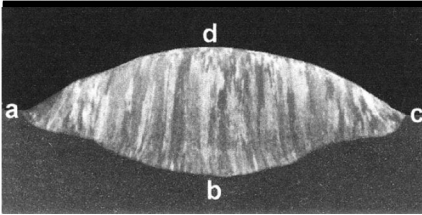


Figure 14.3 The primary structure can be seen in a section through the weld,  $\times 4$ .

Figure 14.4 shows schematically how the heat of the weld affects the base material closest to the weld. The structure of the rolled, unaffected base material is shown at the right, adjacent to the structural change zone, which has been heated to temperatures between  $A_1$  and  $A_3$ .

The transition zone – often also referred to as the Heat Affected Zone (HAZ) – can be clearly seen adjacent to the weld. It can be divided into the normalised zone, which has been heated to somewhat over  $A_3$ , and the overheated zone, where temperatures have been considerably over  $A_3$ , up to the melting point of the material. The structure of the overheated zone exhibits a substantial amount of grain enlargement, and is partly Widmanstätten-orientated.

The weld metal can be seen on the left of the diagram, in this case with a Widmanstätten structure, which is a characteristic of single-pass welds (see also Figure 14.5). Schematic diagram of the structure of the heat-affected zone and of the base material.

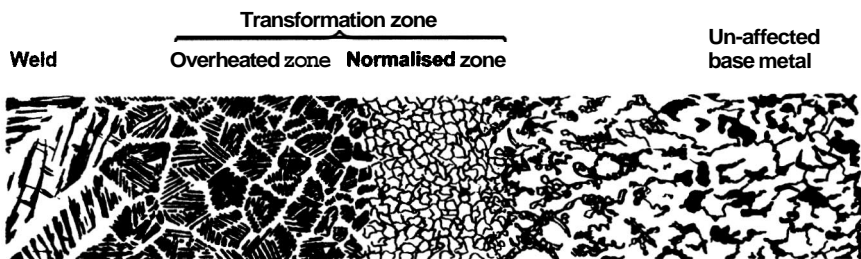
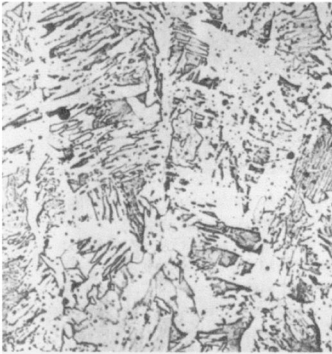


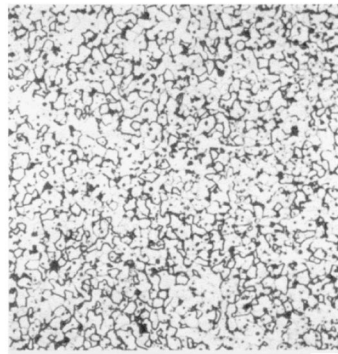
Figure 14.4 Schematic illustration of how the weld heat affects the base metal.

In a multi-pass weld, each weld bead will be heat-treated by the subsequent bead. This means that, with the exception of the top pass, which retains its Widmanstätten

structure, a multi-layer weld has what is known as a normalised weld structure, as shown in Figure 14.6.



**Figure 14.5** The Widmanstätten structure in a single-pass weld. Manual metal arc welding, 200x magnification.



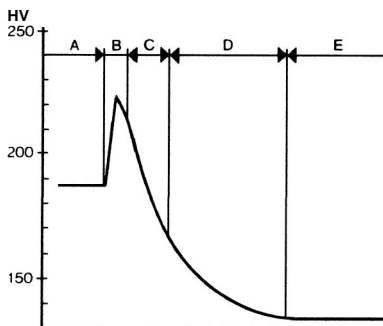
**Figure 14.6** Normalised weld structure of a multi-pass weld. Manual metal arc welding, 200x magnification.

When using a filler material, the properties of the weld metal are determined largely by the composition of the filler material. In the case of deep penetration into the base material, this also affects the properties of the weld metal. When welding without a filler, it is of course the suitability of the base material for welding that determines the properties and quality of the weld.

Together with the heat input, it is also the composition of the base material that determines the changes in the properties of the base material in the HAZ. This applies in particular to the overheated zone which, in several respects, is the most critical area.

## Risks of cracking

If the heat input is low in comparison with the thickness of the surrounding metal, cooling will be rapid and martensite may be formed. This means that hardness will increase and, in **difficult** cases, that there will be a risk of hydrogen cracking and **embrittlement**. It is generally accepted that the hardness should not exceed 350 HV, or somewhat more for micro-alloyed steels. Figure 14.7 shows characteristic hardness **contours** around a weld.



**A = Weld**  
**B = Overheated zone**  
**C = Normalised zone**  
**D = Coarse grained zone**  
**E = Base metal**

**Figure 14.7** Typical hardnesses of various parts of the heat-affected zone in plain carbon steel.

To some extent, the risk of complications can be determined by calculation of the equivalent carbon content,  $E_c$ , of the material:

$$E_c = C + \frac{Mn}{6} + \frac{Cr + Mo + V}{5} + \frac{Cu + Ni}{15}$$

A steel is regarded as fully weldable if  $E_c$  does not exceed 0.41. At higher values, it is regarded as being weldable to a limited extent, which in general means that welding must be accompanied by heating of the workpiece in order to reduce the rate of cooling.

Even if  $E_c$  does not exceed these values, heating of the workpiece may still sometimes be necessary. For steels in the minimum strength group, this means that heating is needed for metal thicknesses over about 50 mm, while for those in the highest strength groups it is needed for thicknesses over about 30 mm. In the case of plain carbon steels, temperatures over 200 °C are unlikely to be needed.

As the plain carbon steels have been developed for use in welded structures, there are not normally any problems if welding is carried out correctly. However, for 'non-standard' steels, and particularly for unkilld steels, there is a risk of thermal cracking if the material contains higher levels of contaminating elements. In addition, if a material not having a guaranteed impact toughness is used where such toughness is required, there is a risk of fractures due to brittleness in the HAZ.

Welded plain carbon steel structures can be stress-relieved at 550/600 °C when this is regarded as necessary.

## 14.2 High-strength and extra high-strength steels

Steels having yield strengths from 450 MPa to 740 MPa, but meeting the  $E_c < 0.41$  weldability criterion, can be rolled in thicknesses from 2 mm to 14 mm. Most of these steels can also be cold formed, due to their low sulphur content, a result of modern steel-making processes.

**TABLE 14.2** *Steel grades from Domnarvet.*

Grade	Swedish Standard	Yield strength $R_{eH}$ MPa min	Ultimate tensile strength, $R_m$ MPa min.	Micro-alloying elements
Domex 220		220	320	Al
Domex 240		240	360	Al
Domex 280	2632-00	280	350	Al
Domex 310		310	380	Al + Nb
Domex 350	2642-00	350	420	Al + Nb
Domex 390		390	460	Al + Nb
Domex 420	2652-00	420	480	Al + Nb
Domex 490	2662-00	490	550	Al + Nb
Domex 590		590	650	Al + Nb + V(Ti)
Domex 640		640	700	Al + Nb + V(Ti)
Domex 690		690	750	Al + Nb + Ti(V)
Domex 740		740	790	Al + Nb + Ti(V)

Cold forming allows parts to be produced that can then be joined to produce more complex structures, thus reducing the total amount of welding needed. Table 14.3 shows typical weldable cold-finished steels of this type.

Similar steels are also used for pressure vessels and welded tubes and pipes, e.g. for bulk gas or oil mains, or for district heating distribution pipes. It can be seen from the table that there are many strength classes of Domex steels. Hot-rolled steel of this type is also used for RHS sections.

Extra high yield strengths, in combination with good weldability, can also be obtained by hardening and tempering or by accelerated cooling after rolling. In Sweden, hardened and tempered steel with acceptable weldability is manufactured by SSAB under the name of Weldox. However, with yield strengths above 650 MPa, the  $E_c$  value will exceed 0.41.

The geometry of a weld also affects the dissipation of heat. In the case of, for example, a fillet weld, where three plates meet, it is necessary to consider the combined metal thickness. Current rules for welding temperatures (BS 5135) express the working temperature as a function of the combined thickness of the materials, the tensile energy, the hydrogen content of the weld metal and the  $E_c$  value. Only filler materials with **guaranteed low hydrogen content** should be used.

TABLE 14.3 Steel grades from Oxelösund.

Grade	Thick- ness (mm)	Yield strength, $R_{eH}$ MPa min.	Ultimate tensile strength, $R_m$ (MPa)	Corresponding standards		Heat treatment
				EN	ASTM	
Weldox 355	8-16	355	450-610	10113-3	-	Acc
	(16)-25	345	450-610			"-"
Weldox 420	6-16	420	500-660	10113-3	A 678 B	"-"
	(16)-40	400	500-660			"-"
Weldox 460	6-16	460	530-720	10113-3 10137-2	A 852	"-"
	(16)-40	440	530-720			"-"
Weldox 500	8-16	500	570-720	10137-2	A 678 C, A 678 D	"-"
	(16)-40	480	570-720			QT
Weldox 700	4-50	700	780-930	10137-2	A 514 S	"-"
Weldox 900	4-50	900	940-1100	10137-2		"-"
Weldox 960	4-50	960	980-1150	10137-2		"-"
Weldox 1100	5-40	1100	1200-1500			"-"

Hardened and tempered Weldox steel is available with yield strengths up to 1100 MPa, as shown in the above table. Steels corresponding to the micro-alloyed hot-rolled Domex steels and the hardened and tempered Weldox steels are also manufactured

in Germany, the UK and France. However, the Swedish weldable high-strength steels have long been the European market and performance leaders.

European standards for high-strength hot-rolled steels are being drafted in yield strength steps of 500 MPa. Work on an EN standard covering such aspects as lowest recommended working temperatures is also in progress.

### Stainless steels

This group of steels consists of those that include chromium as an alloying element in concentrations of about 12 % or more. At these concentrations, the surface of the metal forms a thin, tough film of oxide, protecting the material from attack when exposed to corrosive gaseous or liquid phase environments. The same mechanism increases the scaling temperature of the material, as compared with that of plain carbon steel. Other alloying elements are added in order further to improve corrosion resistance to various solutions: the most important of these elements are nickel and molybdenum.

### The effect of alloying constituents

Alloying elements can be divided into two main groups, depending on their effect in the temperature ranges where ferrite or austenite are stable phases. They are referred to as austenite or ferrite forming elements. Austenite forming elements include nickel, manganese, carbon and nitrogen, while ferrite forming elements include chromium, molybdenum, silicon and niobium. The austenite forming elements extend the steel's austenite zone as concentrations increase, while ferrite forming elements reduce the zone as their concentrations increase.

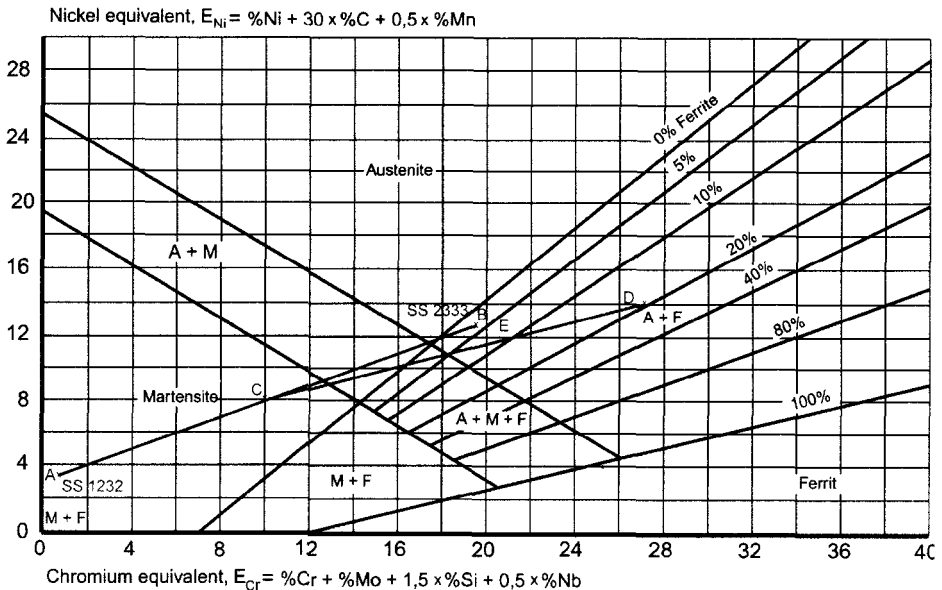


Figure 14.8 A Schaeffler diagram of the worked example described on Page 147.

The Schaeffler diagram shows how the structure of the material is affected by varying concentrations of austenite and ferrite forming elements. A variation of this is the DeLong diagram (Figure 14.9), which also shows the nitrogen content of the material. By calculating the equivalent chromium and nickel concentrations of the material from the diagrams, it is possible to estimate the structure of the weld metal. The diagrams do not apply for welds that have been heat-treated, and nor for the base material affected by the weld.

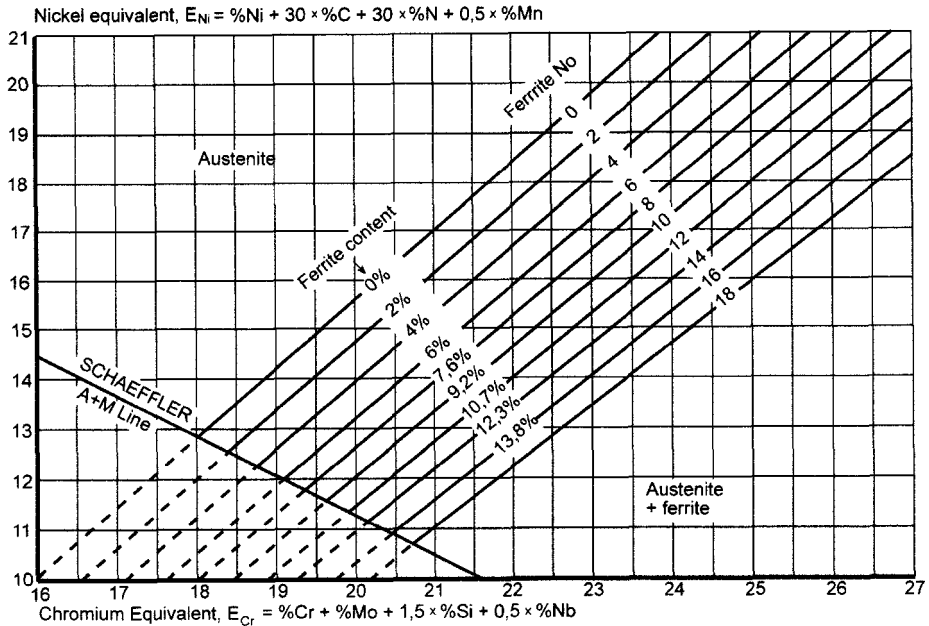


Figure 14.9 A DeLong diagram.

As, depending on the type and quantities of alloying elements, the structures of the materials in the group differ, giving them differing physical and mechanical properties, corrosion resistances and weldabilities, they have been divided up into the following groups for continued discussion:

- austenitic steels
- ferritic steels
- martensitic steels
- ferritic-austenitic steels
- martensitic-austenitic steels

### 14.3 Austenitic steels

The main applications for these steels are for domestic items, such as sinks and saucepans, and for pipes and pressure vessels requiring good corrosion resistance in the chemical, cellulose, building and food industries.

## Alloying elements

Austenitic steels contain about 12–27 % chromium and 7–30 % nickel. They are non-magnetic, and cannot be hardened by heat treatment. They are normally delivered in the austenite state, which has required rapid cooling from a temperature of about 1050–1100 °C. Depending on the intended application, they often include about 2–3 % molybdenum as an alloying element, which increases the corrosion resistance.

TABLE 14.4 *The main types of stainless steels (from MNC Handbook no. 4).*

Group	Composition limits as given in Swedish Standards for steels within the group <sup>1)</sup>				Hardenability	Ferro-magnetic
	C %	Cr %	Ni %	Mo %		
Ferritic	0.08 0.08 0.20	12-13.5 16-19 24-28	- - -	- 2.5	Cannot be hardened	Magnetic
Martensitic	0.09-0.35 0.14-0.23	11-14 15.5-17.5	- 2.5	1.2 -	Hardenable	Magnetic
Martensitic-austenitic	0.10 0.05	12-14 15-17	5-6 4-6	- 0.8-1.5	Hardenable	Magnetic
Ferritic-austenitic	0.030 0.10	18-26 24-27	4-8 4.5-7	0.1-5.0 1.3-1.8	Cannot be hardened	Magnetic
Austenitic – Not including Mo as alloying constituent	0.12 0.07 0.05 0.030	16-19 17-19 17-19 17-19	6.5-9.5 8-11 8-11 8-11 9-12 8-12	- - - - - -	Cannot be hardened	Non-magnetic
Austenitic – With Mo as alloying constituent	0.10 0.05 stab. <sup>3)</sup> 0.030 0.025 0.020	16-19 16.5-18.5 16.5-18.5 16.5-18.5 19-28 19.5-20.5	8-10 10.5-14 10.5-14 11-17 24-34 17.5-18.5	1.3-1.8 2.0-3.0 2.0-2.5 2.0-4.0 3.0-5.0 6.0-6.5		
Austenitic, heat-resistant	0.08 0.04-0.06	24.0-26.0 18.0-19.0	19.0-22.0 9.0-10.0	- -		

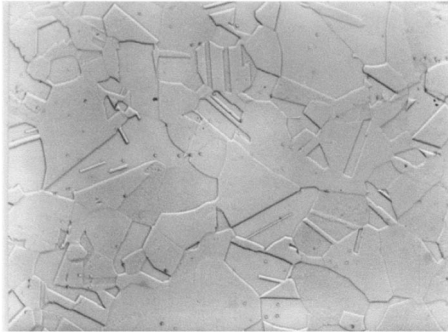
1) May include other deliberately added alloying elements, e.g. N, Cu, Al or Ce

2) Stabilised with Ti or Nb

3) Stabilised with Ti

Carbon concentrations are normally below 0.05 %, or below 0.03 % for ELC steels (Extra Low Carbon). Certain materials have higher carbon concentrations, of about 0.08 %. In order to prevent chromium carbides from forming during welding, alloying elements in such steels must have a higher affinity for carbon than does chromium: suitable elements are titanium and niobium. Steels with this composition are referred to

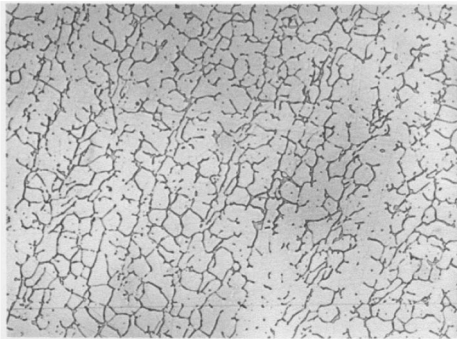
as **stabilised** steels. The figure below shows the microstructure of an austenitic steel after **austenizing**.



*Figure 14.10 The microstructure of an austenitic steel containing 18 % chromium and 8 % nickel. Magnification: 500 x.*

### **Ferrite formation**

Although the heating and cooling caused by welding does not produce any significant structural changes in austenitic material, secondary phases can be formed under certain conditions in the weld metal and HAZ. The most important of these phases is ferrite, which has both beneficial and adverse effects on the properties of the weld. The figure shows an austenitic weld with about 8 % ferrite.



*Figure 14.11 Section through an austenitic weld containing about 8 % ferrite: magnification, 500 x.*

The beneficial effect of ferrite is that it largely prevents the formation of hot cracks in the weld, partly because it dissolves elements such as sulphur and phosphorus, which would otherwise segregate and substantially increase the risk of cracking as the stresses in the weld increase. Modern methods of steelmaking have made it possible to produce filler materials that give **ferrite-free** welds with good hot cracking resistance. They contain relatively high proportions of manganese and low levels of sulphur and phosphorus.

The adverse effect of ferrite in the weld metal is that it can be selectively attacked by certain corrosive media. As the grain boundary ferrite is contiguous at concentrations of about 10 % and above, failures caused by corrosion can occur in such cases. This means



that it is necessary to use a filler material giving considerably lower ferrite concentrations for structures likely to encounter such corrosion conditions.

At operating temperatures in the **550–900 °C** range, ferrite is converted to what is known as the sigma phase, which reduces the ductility of the material. However, this is generally of little practical importance, if the ferrite content of the weld metal is less than about 5 %.

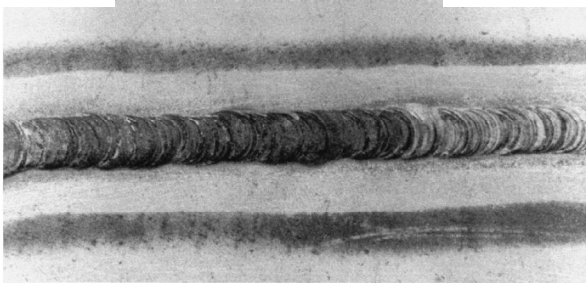
A radical way of avoiding adverse effects of ferrite in the weld metal is, of course, to anneal the material at about **1100 °C**, thus dissolving the ferrite and **stabilising** the austenite. However, this is often not feasible for practical reasons.

### Intercrystalline corrosion

A major problem when welding austenitic steels was previously the need to avoid carbide precipitations at the grain boundaries. These carbides **are** chromium-rich, and therefore reduce the chromium concentration in the austenite adjacent to the grain boundaries, thus creating the conditions for intercrystalline corrosion, as shown in Figure 14.12 and 14.13.

Chromium carbides are formed more rapidly in steels with higher carbon concentrations, as can be seen in Figure 14.14. If the heating time at a certain temperature is longer than indicated by the respective curve, carbide will be precipitated, a process known as **sensitising**. Austenitic steel with a low carbon concentration can generally withstand the effects of this unfavourable temperature range for a sufficiently long time to allow welding to be carried out without risk of carbide precipitation. A material containing **0.056 %** carbon, for example, can be held at **700 °C** for up to about seven minutes without intercrystalline corrosion occurring during subsequent testing.

Nevertheless, when working in thick metals, welding should be carried out with a controlled heat input. ELC steel is therefore chosen for certain applications, as it can be heated for about ten hours without carbide precipitation: an alternative is the use of stabilised material.



*Figure 14.12 Intercrystalline corrosion at a weld in austenitic steel.*

### Stress corrosion

Under certain circumstances, austenitic steels are sensitive to stress corrosion, e.g. caused by residual welding stress in materials in contact with chlorides or strongly **alkaline** media. Other materials should be used if it is felt that there could be a risk of stress corrosion: examples include ferritic-austenitic steels or austenitic steels with high nickel contents.

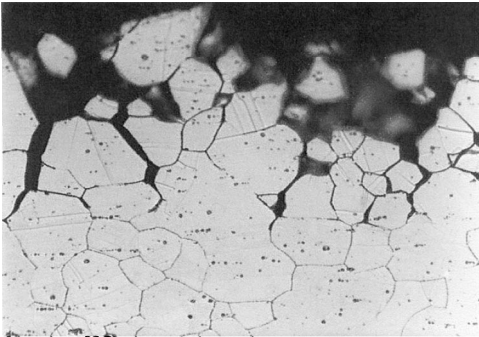


Figure 14.13 Section through an area of intercrystalline corrosion: magnification, 300 x.

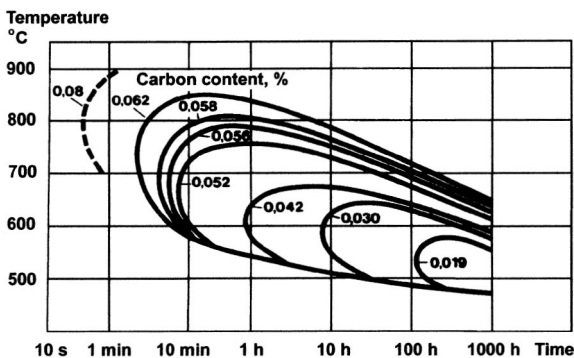


Figure 14.14 TTS diagram for austenitic steel with 18 % chromium, 8 % nickel and varying carbon concentrations. (TTS = Time-Temperature Sensitisation).

### Tool steels

Austenitic tool steel, i.e. steel intended particularly for chip-cutting machining, is regarded as having poor weldability, as its high sulphur content of about 0.2 % introduces a risk of thermal cracking in the weld. However, tool steels containing a maximum of 0.05 % carbon, 0.20 % sulphur and more than about 1.5 % of manganese have relatively good weldability. As the manganese **combines** with the sulphur to form manganese sulphide, precipitation is avoided, which reduces the risk of cracking. This can be further guarded against by using fillers such as 18 8 manganese or 23 12 L. This latter filler metal has a ferrite concentration of about 15–20 %.

### Welding stresses

In comparison with those of plain carbon steels, the coefficient of thermal expansion of austenitic steels is about 50 % greater, while the coefficient of thermal conductivity is about 40 % less. This means that there will be more contraction in a welded joint, so that welding must be carried out with particular consideration of possible distortion. It is generally sufficient to weld with a low heat input, with **careful** planning of the work and of the order in which welds are to be made, and to apply the welds symmetrically.

Stress relieving of the stresses introduced in the structure by welding is carried out at 850–950 °C or 400–500 °C. It is important that temperature ranges at which carbide can form are avoided in all heat treatment.

## Ferritic steels

Ferritic steels are used in many of the same applications as austenitic steels, i.e. in the food, chemical and cellulose industries. However, there are some applications in which their performance is superior, i.e. for use in sulphurous atmospheres, in which the presence of nickel reduces the resistance to corrosion, and in environments with modest chloride concentrations, where ferritic steels have better resistance to stress corrosion.

The main alloying element in ferritic steel is chromium, in proportions between 12 % and 30 %. Carbon content is generally less than 0.1 %. There are also Extra Low Interstitial (ELI) steels, with very low carbon and nitrogen concentrations, of less than 0.03 %, having better corrosion performance than normal ferritic steels and better weldability. Ferritic steels are magnetic and non-hardenable.

In comparison with austenitic steels, ferritic steels are not as easily welded. There is significant grain enlargement in the HAZ, with carbides being precipitated at the ferrite grain boundaries, resulting in embrittlement of the weld and reduction of its corrosion resistance. This embrittlement introduces a certain risk of brittle cracking occurring as the weld cools to the brittle transition temperature of the material at about 100–200 °C. In addition, there is a risk of transverse shrinkage cracks in the weld metal as it cools and stresses rise. These potential problems are countered by heating the area to about 200–400 °C, which reduces the temperature and stress gradients.

Materials must be stress-relieved at 750–850 °C for 30–60 minutes in order to give optimum strength and corrosion resistance of a weld. This relieves the stresses introduced by welding and spheroidises the precipitated carbides. If the steel has been stabilised by the inclusion of titanium as an alloying element, stress relief to improve corrosion resistance can sometimes be omitted, as carbide precipitation that degrades corrosion resistance does not always occur when welding such metals; at any rate, not if the metal thickness is less than about 2 mm.

Steels containing more than about 20 % chromium form significant sigma phase ferrite at temperatures between 550 °C and 800 °C: if the steel contains molybdenum, this sigma phase formation extends to higher temperatures. This phase is brittle, and so substantially reduces the ductility of the metal and increases its ultimate tensile strength. Annealing in this temperature range is therefore inappropriate for these steels. The time needed to separate the sigma phase at any given temperature is very dependent on the composition of the steel, but sigma phase ferrite can form in weld zones when welding thick workpieces.

Another type of embrittlement, known as 475 °C embrittlement, can occur if the material is heat-treated in the temperature range of 400–550 °C.

Welding can be carried out, using a filler of the same material or of austenitic steel. The latter, with a nickel content of about 20 %, produces the best ductility of the weld.

## Martensitic steels

Martensitic steels have chromium concentrations between about 12 % and 18 %. They contain more carbon than ferritic steels (about 0.1–0.3 %), which means that they can be

hardened. This is done from about 1000 °C by quenching in oil or air, followed by annealing at 300–750 °C. These steels are magnetic.

Typical applications for them are where there is a need to combine hardness with corrosion resistance: examples include turbine blades, cutting tools, knives, razor blades, scissors, cleavers etc. Table knives and surgical instruments are other examples.

As these steels are air-hardening, there is always a hard and often brittle zone in the base material close to the fusion line, which means that these steels have poor weldability in comparison with that of other stainless steels. In order to reduce, to some extent, the hardness peak in this zone, these steels must always be welded at a prescribed preheating temperature. A suitable temperature depends on the material dimensions and type of joint/structure, but is generally in the range of 200–400 °C. In addition, welding must be followed by heat treatment at 650–750 °C for 30–60 minutes. If stress conditions in the structure are complicated, this heat treatment should be carried out immediately after welding, i.e. without allowing the workpiece to cool to room temperature between welding and heat treatment. However, in order to ensure complete metallurgical structure conversion of the metal, the temperature of the workpiece must not exceed about 150 °C when heat treatment starts.

If the workpiece is welded in the hot state and then heat-treated, there is a risk of hardening cracks in the transformation zone. There is also a risk of brittle cracking, as the material has a relatively high brittle transition temperature, and welding-induced stresses in and around the weld zone are significant. In addition, there is a risk of hydrogen embrittlement in the HAZ, particularly if damp electrodes have been used. Further, if using a filler material of the same metal as the base material, there is a risk of transverse cracks in the weld metal, and so austenitic fillers are often used to reduce this risk. This also reduces the risk of brittle failure.

Particularly with complicated structures, it is usual to butter the joint faces with an austenitic filler metal. Each part of the workpiece is treated separately and heat-treated. The austenitic layer is built up to a sufficient thickness to ensure that no metallurgical change occurs in the base material when the final weld is made.

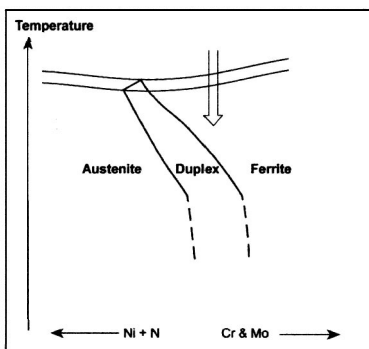
## Ferritic-austenitic steels

Ferritic-austenitic steels, which have attracted increasing interest since the 1970s, are often known as duplex steels. A characteristic of them is that they combine excellent corrosion resistance with high mechanical strength.

These steels find their main application area in the offshore industry, where their properties are particularly suitable for use in a high-chloride environment. Their high strength, in comparison with that of austenitic steels, also brings dividends in the form of lighter structures. The cellulose, chemical and petrochemical industries are other areas in which they are being increasingly widely used.

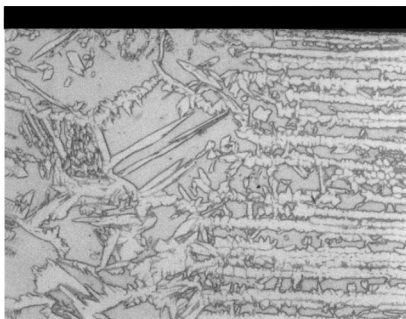
Steels in this group are characterised by chromium contents of up to 29 %, nickel contents of the order of 5–8 % and molybdenum contents around 1–4 %. The carbon content is usually low, at less than 0.03 %.

Another element that has shown itself to be very important in determining the weldability of ferritic-austenitic steels is nitrogen, which may be present in concentrations up to 0.4 %. When welding, the weld pool solidifies primarily with a fully ferritic structure, with the austenite forming at a later stage as the temperature falls. [See Figure 14.15.](#)



*Figure 14.15 Pseudo-binary phase diagram for ferritic-austenitic steel.*

The formation of austenite starts at the **ferrite/ferrite** grain boundaries, and grows inwards in the ferrite grains to produce a structure as shown in Figure 14.16.



*Figure 14.16 Microstructure of the weld metal and the HAZ in ferritic-austenitic steel.*

The presence of nitrogen as an effective austenite forming element accelerates this process, to produce the correct metallurgical structure of the weld without requiring hot welding or subsequent heat treatment. Older types of ferritic-austenitic steel, such as **AISI 329**, with no nitrogen and a high proportion of ferrite, become almost entirely ferritic in a zone close to the fusion line, which degrades both the mechanical properties and corrosion resistance. It is necessary to provide heat treatment at about 100-200 °C to correct this. Ferritic-austenitic steels should not be welded at either too low or too high a heat input. A low heat input can result in too rapid a rate of cooling, which forms chromium nitrides that can adversely **affect** corrosion resistance. Too high a heat input, on the other hand, in combination with high temperature between passes, produces sigma phase (among other effects), which degrades both corrosion resistance and mechanical properties.

Welding should be performed using a filler of similar material, but with about 2-3 % higher nickel concentration in order **further** to assist austenite formation and to produce a ferrite concentration in the weld metal similar to that of the base metal. This ensures optimum characteristics of the weld metal in respect of corrosion resistance and mechanical strength.

## Martensitic-austenitic steels

Applications for this steel group include water turbines, propellers, machine parts and structural steel in general.

These steels are magnetic, and have an approximate analysis of 0.04–0.08 % carbon, 13–16 % chromium, 5–6 % nickel and 1–2 % molybdenum. They can be hardened by quenching in oil or air from about 1000 °C, which produces a martensitic structure, possibly containing some residual austenite. Subsequent tempering at about 600 °C forms austenite, which is so stable that it is not converted to martensite as the material cools to room temperature. As a result, the final structure contains about 65–80 % of tempered martensite, with the rest being austenite, which means that the material has considerably better ductility than fully martensitic steel. These steels therefore have good weldability when tempered.

It is not generally necessary to preheat the workpiece, and nor is there any greater risk of cracking in the HAZ. That part of the HAZ that is heated to such a high temperature (over about 900 °C) that it is converted completely to austenite will be converted mainly to martensite by the subsequent cooling to room temperature. Tempering restores the martensitic/austenitic ratio of the base material in this zone.

The weldability of these steels is relatively good. Austenitic fillers are generally used, although this sometimes results in the strength of the weld metal being lower than that of the base material.

## Welding of dissimilar materials

There is often a need, when fabricating stainless steel structures and/or when incorporating them in other plant, to weld stainless steel to plain carbon or low-alloy steels. In addition, different types of stainless steels often have to be welded to each other. In order to obtain the best performance of such joints, particular attention must be paid to the metallurgy of the weld metal. For this purpose, the Schaeffler diagram is a good help. In general, the following methods of working can be employed when deciding on the appropriate choice of filler material.

The position of the material in the Schaeffler diagram is determined from its chromium and nickel equivalents, and a straight line is then drawn between the points. Similarly, the position of the proposed filler material is plotted. When welding symmetrical joints, it can be assumed that the joint surfaces of the base material will be more or less equally melted. A straight line can therefore be drawn between the position of the filler material and the centre of the line between the base materials. In general, about 20–40 % of the filler material will be 'diluted' by the molten base material, with the result that the structure of the weld metal will be as indicated by a point about 20–40 % of the way along the line from the position of the filler material. If this structure is suitable, then the proposed filler material can be used. If it is not suitable, repeat the above procedure for a filler having a different composition.

The Schaeffler diagram in [Figure 14.8](#) shows an example of the above for the case of a low-alloy steel (A) being welded to stainless steel (B), using 23 12 2 L filler (D). This gives a weld metal structure as shown at point E, i.e. austenite with about 10 % ferrite.

The filler material to be used for joining the two materials must also be selected as described above when welding compound materials consisting of plain carbon and high-alloy materials. The same applies for selection of the filler material for the first layer of stainless material to plain carbon or low-alloy steel.

# 15 Design of welded components

## 15.1 Introduction

Determining the required design parameters of a welded joint can be relatively time-consuming, and sometimes complicated. This chapter is aimed at the design/production unit, with the objective of explaining how the designer thinks when designing a welded joint. Only exceptionally are absolute design rules referred to: instead, the presentation concentrates on practical advice and suggestions, aimed at producing an optimised design in terms of strength, weight, performance, ease of manufacture and overall cost. Those who are interested in more detailed design requirements should turn to [references \[1\], \[2\], \[3\], \[6\] or \[7\]](#): see Page 170.

## 15.2 Symbolic representation of welds on drawings

A welding symbol on a drawing consists of:

- An arrow line (1)
- One or two reference lines (2)
- An elementary symbol (3)
- Possible supplementary symbols
- Dimensions of the weld

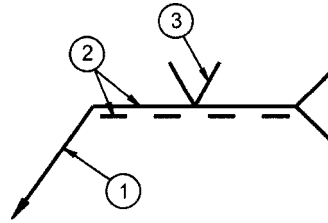


Figure 15.1 Symbols used on welding drawings.

Symbolic presentation of welds on drawings are given in ISO 2553, [reference \[4\]](#).

No	Designation	Weld	Symbol
1	Weld in plates with raised edges		
2	Square butt weld		
3	Single V-butt weld		
	Single-bevel butt weld		
5	Single-V butt weld with broad root face		
6	Single-bevel butt weld with broad root face		
7	Single-U butt weld (parallel or sloping sides)		
8	Single-J butt weld		
9	Backing run		
10	Fillet weld		
11	Plug weld		
12	Spot weld		
13	Seam weld		

Figure 15.2 Examples of elementary symbols.

### Elementary symbols and supplementary symbols

In general, the elementary symbol is similar in shape to that of the welded joint (i.e. before welding, indicating how the metal sheets are to be prepared for welding). Examples of elementary symbols are shown in Figure 15.2. If the unbevelled edge exceeds 2 mm, the joint is a single-V butt joint with broad root faces (Y). If not, it is a single-V butt joint.

Supplementary symbols may be used, in combination with the elementary symbols: see Figure 15.3. Absence of supplementary symbols means that there are no specific requirements in respect of the shape of the weld surface.

Shape of weld surface	Symbol	Designation	Illustration	Symbol
a) Flat (finishedRush)		Flat single-V butt weld		
b) Convex		Convex double-V weld		
c) Concave		Concave fillet weld		
d) Toes shall be blended smoothly		Flat single-V butt weld with flat backing run		
e) Permanent backing strip		Single-V butt weld with broad root face and backing run		
f) Removable backing strip		Flush finished single-V butt weld		
		Fillet weld with smooth blended face		

1) Symbol in accordance with ISO 1302, instead of this symbol the main symbol 'v' can be used

Figure 15.3 Supplementary symbols.

### The importance of the reference lines

The position of the elementary symbol on the reference lines indicates on which side of the arrow line that the weld is to be placed. The upper, solid line (which is recommended to be terminated by a tail showing that the representation refers to ISO 2553) indicates a weld on the arrow side. In this case, the elementary symbol is placed on the solid line. The lower, interrupted line indicates a weld on the other side. In this case, the symbol 'hangs' below the interrupted line. See Figure 15.4 and Figure 15.5.

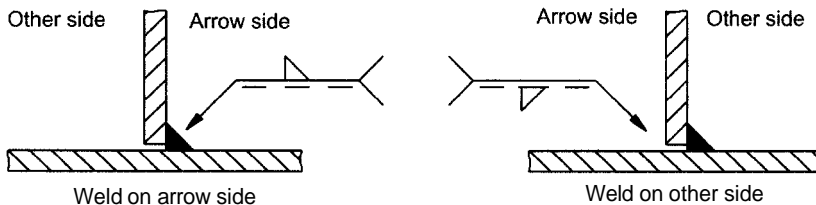


Figure 15.4 A T-joint with one fillet weld.



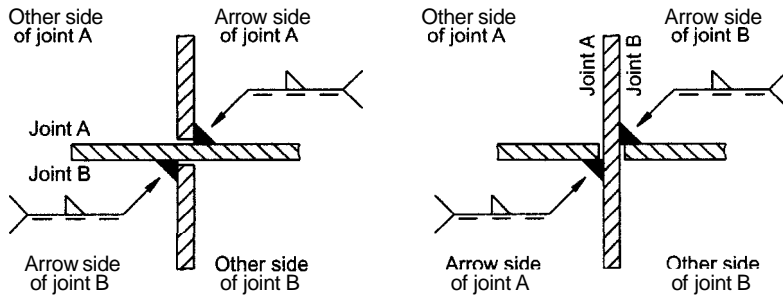


Figure 15.5 A cruciform joint with two fillet welds.

The interrupted reference line is not used for fully symmetrical welds: examples are shown in Figure 15.6.

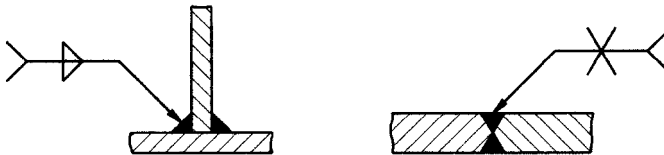
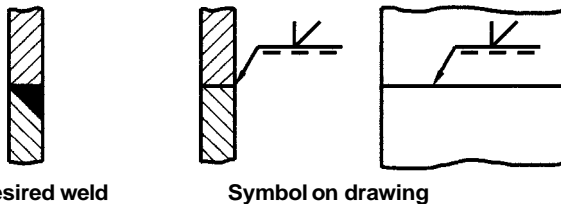


Figure 15.6 Examples of symmetrical welds.

### The position of the arrow line

In general, there is no significance in the position of the arrow line in relation to the weld, except in the case of single bevel butt welds and single-J butt welds where the arrow of the arrow line must point towards the plate that is prepared. See Figure 15.7.



Desired weld

Symbol on drawing

Figure 15.7 Position of the arrow line.

### Dimensioning of welds

The dimensions of the cross-section of the weld are shown to the left of (before) the elementary symbol (e.g. penetration for butt welds, leg length or throat thickness of fillet welds). Write the length of the weld to the right of (after) the basic symbol.

E.g.: 511300 indicates a square butt weld, with 5 mm penetration and a length of 300 mm.

z10 $\nabla$  indicates a continuous fillet weld with a leg length of 10 mm.

z8 $\nabla$  5x200 (100) indicates an intermittent fillet weld with a leg length of 8 mm, divided up into five 200-mm-long welds, spaced 100 mm (end to end) apart.

## Complementary symbols

When a weld is to be applied all the way round a part, the symbol is a circle as shown in Figure 15.8a. Field or site welds are shown by means of a flag, as shown in Figure 15.8b.

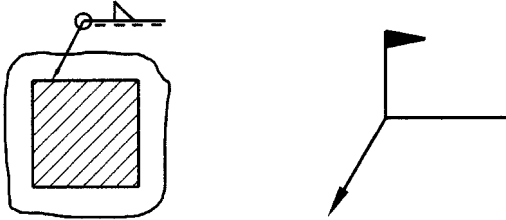


Figure 15.8 a) *Peripheral weld.*

b) *Field or site weld.*

Further information can be given after the tail, in the following order:

- process (e.g. in accordance with ISO 4063);
- acceptance level (e.g. in accordance with ISO 5817 and ISO 10042);
- working position (e.g. in accordance with ISO 6947);
- filler metal (e.g. in accordance with ISO 544, ISO 2560, ISO 3581).

The various items should be separated by slashes (/).

In addition, reference can be made to specific instructions (e.g. a procedure sheet) using a symbol in a closed tail, as shown in Figure 15.9.

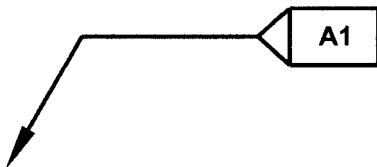


Figure 15.9 *Reference information.*

## 15.3 Welding classes

The welding classes are given in ISO 5817, [reference \[5\]](#).

If the designer has specified a welding class on a drawing, this has been done in order to ensure that the production unit is aware of the quality requirements applicable to the joint. ISO 5817 specifies three different quality levels: B, C and D, with Class B being the strictest. The standard includes tables that specify different types of defects, and how large they are permitted to be in the various quality levels.

Class D is usually used for non-load-carrying parts or in structures subjected to only low static loads.

Parts subjected to high static loads are normally welded according to Class C.

Parts subjected to fatigue loading are normally welded in Class C or Class B, with the additional requirement that the transition between the weld and the workpiece materials must be smooth. In extreme cases of fatigue loading, there may be a requirement

that the edges of the weld must be ground or TIG-treated to produce a rounded shape (e.g. with a radius of at least 4 mm).

## 15.4 Residual stresses in welds, weld distortions

Residual stresses always arise in welded structures, due to the fact that the molten weld metal contracts as it cools. If the adjacent parts cannot withstand this shrinkage, distortion will result. If this is not the case, then residual stresses will arise in the weld, or a combination of distortion and residual stresses.

Residual stresses in the weld in the longitudinal direction of the weld often amount to the yield strength of the material, or to just below it. In the transverse direction, the stresses in the weld are more dependent on the clamping condition of the parts. The transverse residual weld stresses are often relatively small, although transverse distortion is substantial. See reference [6] for further information.

Some simple guidelines:

- Higher heat input means that the zone in which residual weld stresses are high will be larger. In addition, compressive stresses a little way away from the weld will increase, as shown in Figure 15.10.
- Thermal cutting produces residual stresses similar to those caused by welding.
- If the parts are not restrained for deformations, preheating the parts can reduce the residual stresses. If, however, the parts are clamped, then the residual stresses will increase if the parts are preheated.

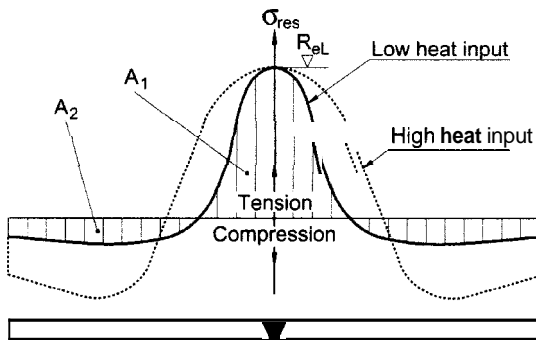


Figure 15.10 Longitudinal residual stresses in a butt weld. Area  $A_1 = A_2$ .

- In the case of thin-walled components, exposed to a risk of buckling, considerations must be taken to the reduction in buckling resistance as a result of the area containing residual compression stresses, as shown in Figure 15.10.
- When designing to resist fatigue and brittle failure, considerations must be taken to the longitudinal residual tensile stresses around the weld.
- Residual stresses can be partly reduced by stress-relieving the component while allowing it to expand.
- Producing the welds in such a sequence that the parts of the workpiece can move during the welding operation can reduce the residual weld stresses.

Table 15.1 shows some material data that affects the residual weld stresses/distortions. High thermal conductivity means that a larger area will be heated up by welding, thus increasing distortions. If the material has a high thermal capacity, more heat can be stored into it, thus also increasing the distortions. The greater the coefficient of thermal expansion of the material, the greater will be the distortions. Figure 15.11 shows welding distortions for different materials.

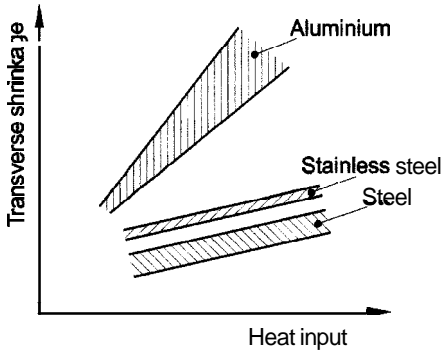


Figure 15.11 Schematic weld distortions

TABLE 15.1 Some material data that affects the residual stresses/distortions of welds.

Property	Steel	Stainless steel	Aluminium
Coefficient of thermal conductivity (W/m°C)	approx. 50	approx. 25	235
Thermal capacity (J/kg°C)	approx. 450	approx. 500	920
Coefficient of thermal expansion (°C-1)	$11 \cdot 10^{-6}$	$17 \cdot 10^{-6}$	$24 \cdot 10^{-6}$

## 15.5 Design consideration

### Load and stress distribution

When subjected to a load, a stress flow spread through, and acts on, the various parts of the structure. Changes in the geometry interfere with this stress flow, giving rise to stress concentrations, as shown in Figure 15.12 a–d.

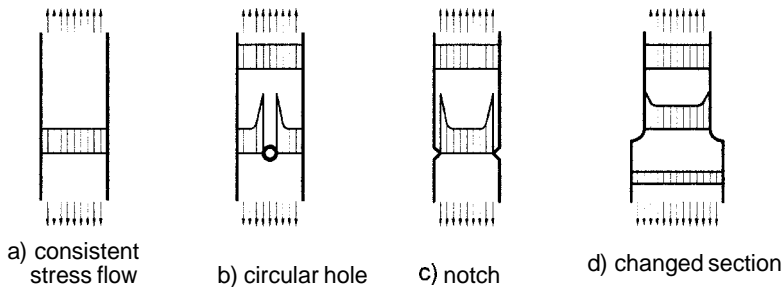


Figure 15.12 Examples of changes in stress flow.

These stress concentrations are of less importance in statically loaded structures. Although, strictly, some parts of the material may be stressed to beyond their yield strength limit, this does not actually involve any safety risk, as parts of the material will simply yield and redistribute the stresses.

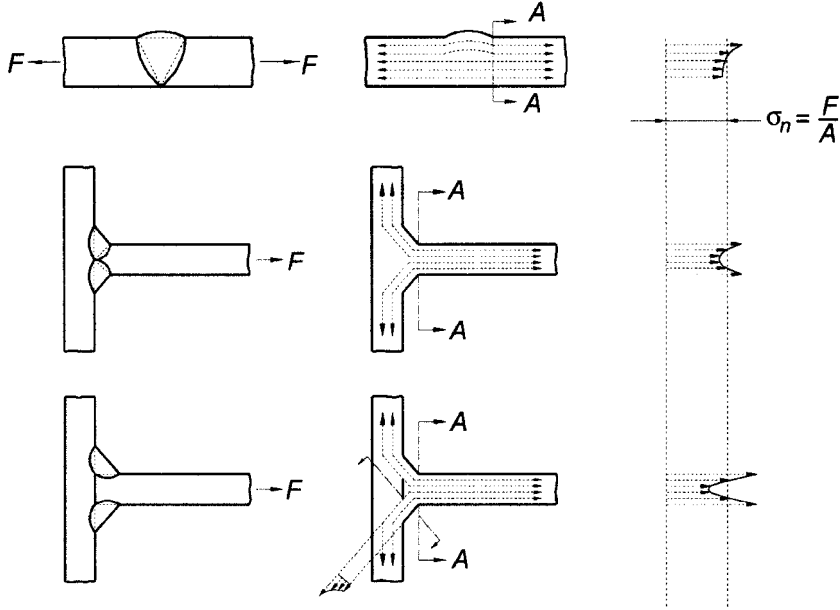


Figure 15.13 Schematic stress flow in various types of welded joints.

The situation is different, however, in structures subjected to fatigue loads. In such cases, the stress concentrations are vital in determining the overall strength of the structure, so that care must be taken in the design to avoid stress concentrations. As far as welded joints are concerned, the welds themselves constitute a stress concentration, as shown in Figure 15.13.

### Design to transfer local forces

A main rule of design is that parts should be arranged so that forces are transferred in the plane of the material, and not perpendicular to it. If an applied force acts in the plane of the material, then the material is used to its maximum (resulting in tensional, compressive or shearing stresses).

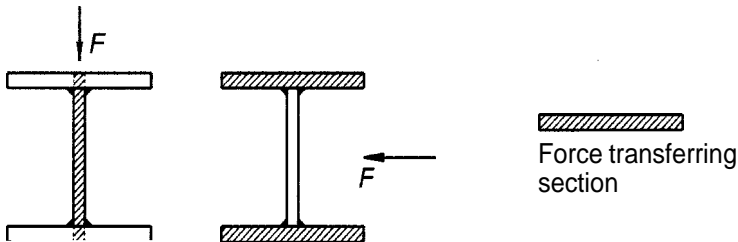


Figure 15.14 Marked surfaces act like shells.

If, instead, the load is applied perpendicularly to the plane of the sheet, it will act like a plate and be subjected to bending, which in turn means that all of the material cannot be used to its maximum. Figure 15.14 shows the parts transferring the forces in an I-beam.

It follows from this, that if a hanger eye is to be attached to a beam, it should be designed as shown in Figure 15.15.

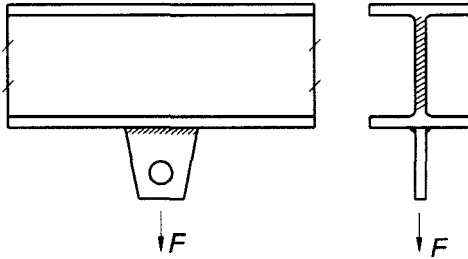


Figure 15.15 Beam with a hanger eye.

Figure 15.16 is an example of how not to design. If the hanger eye must be arranged perpendicular to the web of the beam, reinforcements could be applied as shown in Figure 15.17, which will transfer the load to the web of the beam. This will then replace the undesirable load on the bottom flange by a more favourable application of the force in the plane of the reinforcements.

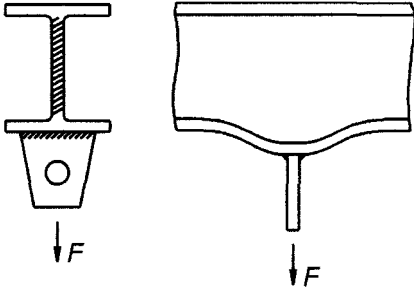


Figure 15.16 A hanger eye welded to the flange of a beam - poor design.

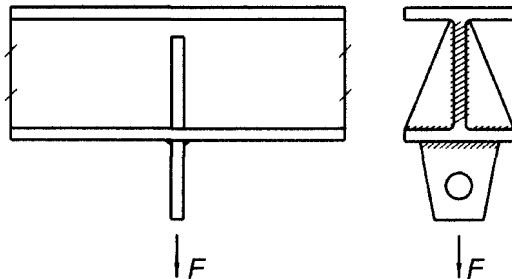


Figure 15.17 Reinforcements transfer the load to the web of the beam.

Figure 15.18a shows a completely wrong position for positioning a hanger eye, giving rise to high bending stresses in the web. Figure b shows a better way in which the forces can be transferred into the plane of the flanges.

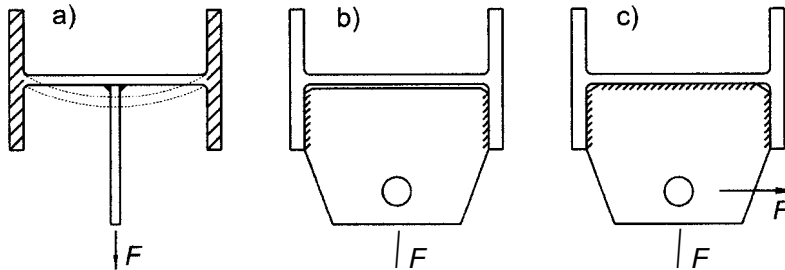


Figure 15.18 a) shows a poor design, which has been improved as shown in Figure b). If the beam is subjected to horizontal forces, the attachment should be arranged as shown in Figure c).

### Design as determined by the type of load

The following order of priorities can be recommended for dealing with the various types of load encountered in a structure:

- |                      |                    |
|----------------------|--------------------|
| 1. Tensile loads     | 4. Bending loads   |
| 2. Compressive loads | 5. Torsional loads |
| 3. Shear loads       |                    |

### Tensile loads

An excellent result will be achieved if it is possible to design the various elements of the structure such that they are subjected mainly to tensile stresses. The entire cross-section of the material then plays its part in carrying the load, thus utilising the material in the optimum manner to produce light, cheap designs.

### Compressive loads

Arranging for the loads in the structure to be carried as compressive loads also makes good use of the material. However, the strength of a slender structure can be reduced by the risk of buckling or other instability phenomena. The critical buckling load is independent of the strength of the material. This means that, when designing slender structures in which the risk of buckling determines the load-carrying capacity, it does not help to choose an alternative material having higher structural strength.

On the other hand, the modulus of elasticity of the material plays a decisive part in determining the load-carrying capacity of slender structures.

All structural steels have the same modulus of elasticity,  $E = 2,1 \cdot 10^5 \text{ N/mm}^2$ , while that of aluminium is much lower at  $E = 0,7 \cdot 10^5 \text{ N/mm}^2$ .

In the case of slender structures that are welded and subjected to compressive loads, the longitudinal residual compressive stresses acting on each side of the weld, also have a negative effect on the load-carrying capacity. In the case of cistern-like structures in particular, the true buckling stress is considerably lower compared to theoretically calculated buckling stress.

**Shear loads**

When part of a structure transfers the load by shearing, it acts as a shell, which is favourable: see section on page 156. However, there is a risk of shear buckling in the case of thin walled shells. The load-carrying capacity will then be reduced in a similar way as for buckling under compressive loading.

**Bending loads**

If it is not possible to avoid having to transfer the loads by bending the structural parts, the first step is to attempt to place the material as far away from the centre of gravity of the cross section as possible. Figure 15.19 shows two cross sections having the same cross-sectional areas. If exposed to equal bending moments ( $M_b$ ), the stresses in section b) will be many times higher compared to those in section a).

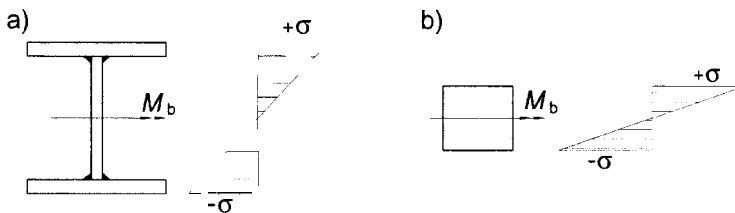


Figure 15.19 Bending stresses

**Torsional loads**

It is particularly unfavourable to attempt to transfer torsional loads in open, thin-walled sections. Welded structures are often of this type. If, instead, the opening can be closed, torsional resistance will be substantially increased, as shown in Figure 15.20.

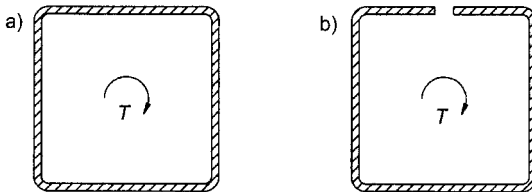


Figure 15.20 a) Torsion-resistant, closed b) low torsion-resistance, open.

Every cross section has a point - centre of torsion - to which an external force can be applied *without* imposing torsional loads upon the section. Figure 15.21 shows examples of the position of the centre of torsion in a number of common sections.

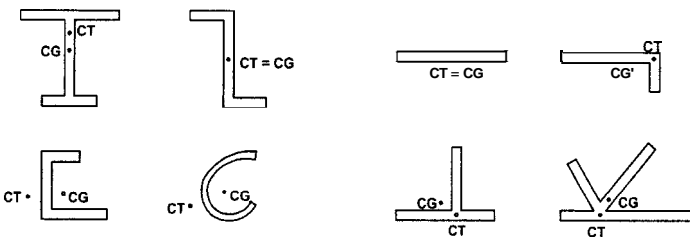


Figure 15.21 Centre of Torsion (CT) for a number of sections. CG = Centre of Gravity.



## Design to resist corrosion

Considerations can be made for corrosion at the design stage as follows:

- Design the structure to avoid corrosion.
- Design the structure so that it is easy to apply corrosion protection, and so that the corrosion protection can easily be maintained.
- Design the structure with an allowance for corrosion (rust allowance), i.e. so that some corrosion can occur without risk of failure or leakage.

It is important to avoid pockets and crannies in which dirt and water can collect, as shown in Figure 15.22.

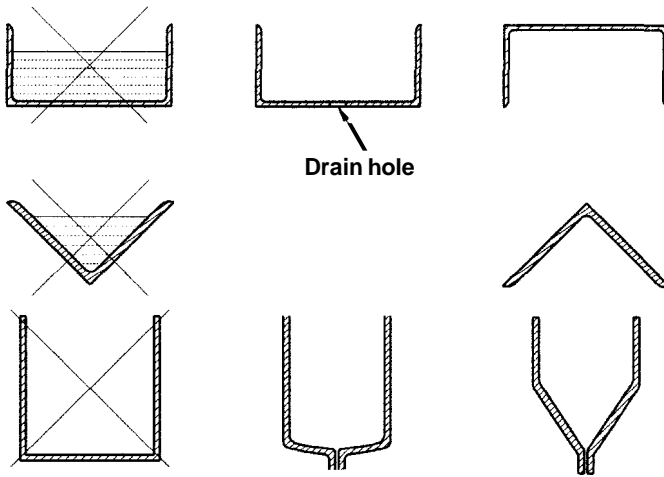


Figure 15.22 Designing to avoid corrosion.

If it is not possible to avoid areas where water can gather, drain holes of at least 20 mm diameter should be provided in appropriate positions.

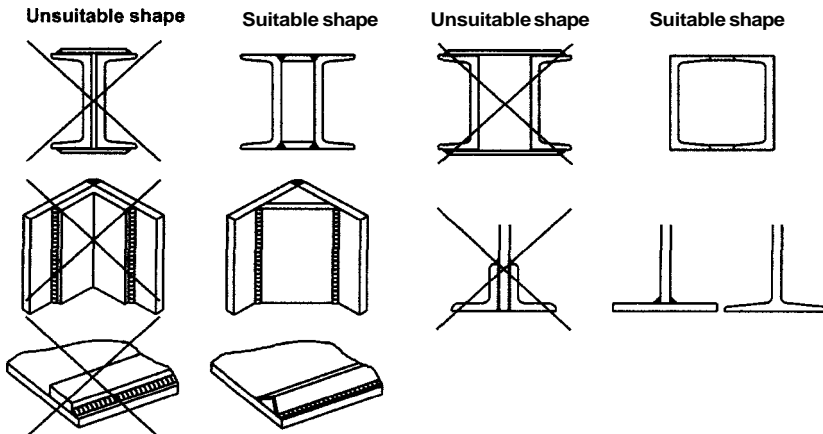


Figure 15.23 Avoiding corrosion around welds

The structure should be designed so that narrow gaps are avoided, as shown in Figure 15.23. Use butt welds instead of overlap welds. If overlap welds cannot be avoided, they must be applied all the way round the material, taking particular care to avoid pores.

Rust protection can be applied by hot zinc-coating. Enclosed volumes, as shown in Figure 15.24, must have openings in order to prevent bursting effect when immersed in the solution of zinc.

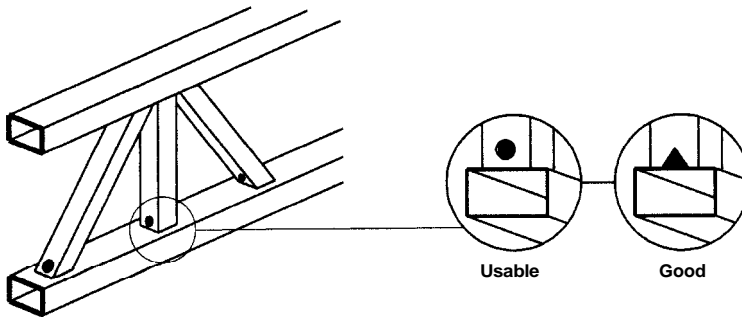


Figure 15.24 Designing for zinc-coating.

## Design for production

Product costs can be kept down, unnecessary work on the shop floor can be reduced and overall quality can be improved if, right at the initial sketch stage, the designer carefully thinks through the production aspects of the design, and understands how the particular production process operates. Some general points are as follows:

- Use standard rolled or extruded profiles, or steel castings, as far as possible, which will minimise the amount of welding required.
- Welding can be reduced, and the number of parts kept down, by bending sheet materials.

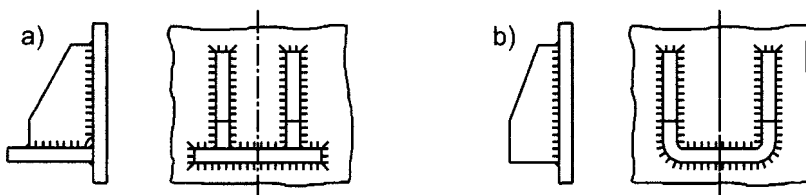


Figure 15.25 Welded and bent parts. Alternative b) is generally preferable.

- Use rational welding methods, such as spot welding, arc welding, friction welding etc.
- Consider the accessibility of parts to be welded (and accessibility for inspection and maintenance).
- Try to position joints so that the required welding position is comfortable. Horizontal welding is preferable to overhead welding.
- Choose a suitable groove, having the minimum filler metal needed to meet the necessary requirements in respect of quality, penetration requirements etc.

- Optimise the throat thickness of fillet welds. Doubling the throat thickness requires four times as much filler metal: welding distortions also increase with increasing throat thickness. In general, some degree of penetration can be expected for fillet welds, which means that the actual throat will be somewhat thicker than as shown on the drawing.
- Use intermittent welding wherever possible.
- Select materials familiar to the manufacturer. High-strength materials can be difficult to handle and work.
- Try to avoid using too many different material qualities, sheet thicknesses or types of profiles, in order to avoid any risk of mix-ups.
- Specify the geometry, quality classes, inspection requirements etc. of welds unambiguously and in an optimum manner, in order to keep down manufacturing costs.
- Special consideration may be required if production is automated. The weld, for example, must be positioned accurately, and it may be necessary to provide greater space for the robot to reach the weld. Butt welds can be difficult if backing is not provided. Permissible tolerance levels are reduced.
- Using symmetrical welds can reduce welding distortions.
- Welding is made easier if the parts are self-locating and self-fixing.

## Detail design

A good design for a welded structure is one in which it is easy to see how loads and forces are transferred and flow throughout the structure. In general, an item is well-designed if it is easy to calculate its strength. The following are a number of tips and views on appropriate design solutions.

- Avoid welding thin materials to thick materials (see Figure 15.26). This is undesirable in strength terms because of the resulting stress concentrations for fatigue loads, and in manufacturing terms due to the fact that the rapid cooling caused by the thick material can cause cracks and poor fusion in the welds.

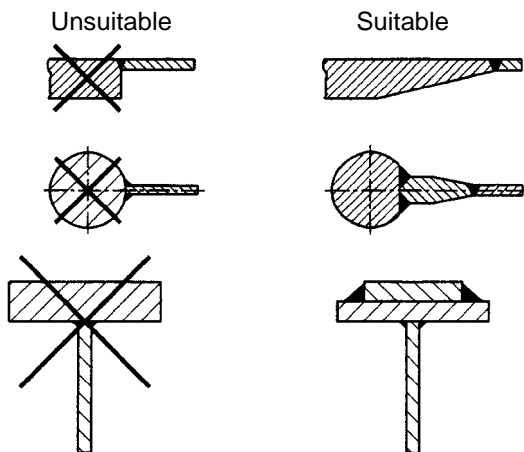


Figure 15.26 Avoid welding thin materials to thick materials.

- If the structure will be subject to fatigue loads, changes in sections must be designed so that there is as little stress concentration as possible, as shown in Figure 15.27.
- If possible, position welds in low-stress areas. Avoid positioning welds too closely to each other. Avoid also restraining welds (see Figure 15.28).
- Remember that it must be possible actually to produce the welds (Figure 15.29).
- Design joints as welded joints, and not as riveted joints with reinforcements (Figure 15.30).

Corners can be reinforced as shown in Figure 15.31. Figure 15.32 shows other examples of welded corners and corner reinforcements.

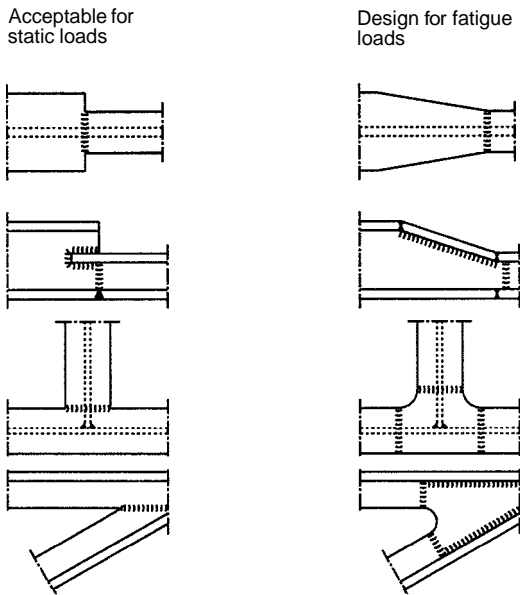


Figure 15.27 Design of changes in section.

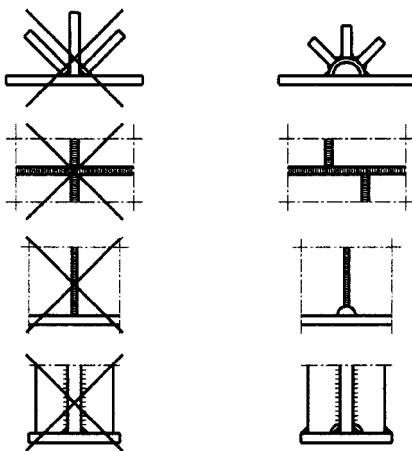


Figure 15.28 Avoid placing too many welds too close to each other.

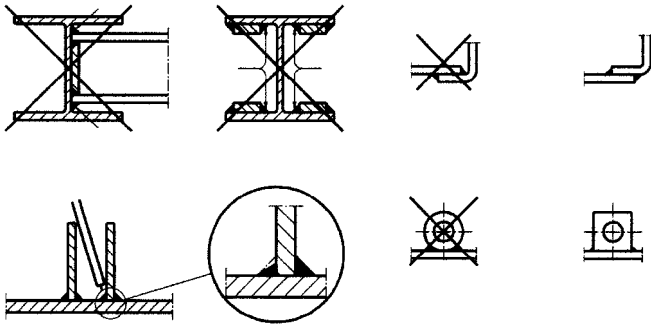


Figure 15.29 Remember to allow for access for welding

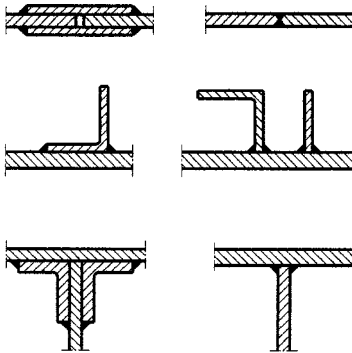


Figure 15.30 Riveted joint/welded joint. Choose a design as shown in the right-hand figures.

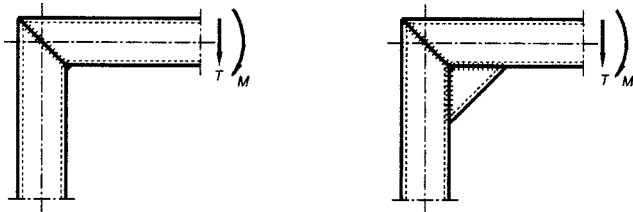


Figure 15.31 Reinforcing a corner consisting of rectangular hollow sections.

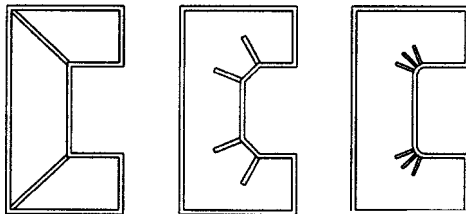


Figure 15.32 Corner reinforcements.

## 15.6 Strength considerations of welded joints

Section 15.6–15.8 is intended merely for guidance: see references [1], [2], [3], [7] and [8] for more detailed information on actual welded joints. If the component has to comply with any design code, then that code has to be followed fully out.

Additional consideration to residual stresses in welded joints is necessary only in connection with designing to resist buckling, lateral instability or other instability phenomena.

### Butt welds

If the filler metal has a higher ultimate tensile strength than that of the parent metal, and if the weld is fully penetrating, then the welded joint will be stronger than the parent metal.

### Fillet welds

The sections for analysis of fillet welds are through the throat thickness of the weld and through the section adjacent to the weld, as shown in Figure 15.33.

In general, stresses can be assumed to be uniformly distributed along the analysed sections. Some of the penetration might be included in the throat thickness [1].

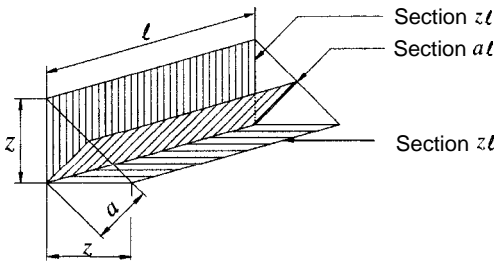


Figure 15.33 Sections for analysis of fillet welds.

## 15.7 Analysis of statically loaded welded joints

### Acceptable stress

The following acceptable stresses (= capacity through the analysed sections) can be assumed for the strength of welded joints:

$$f_{wd} = \frac{\varphi \cdot f_{wuk}}{1.2 \cdot \gamma_n} \quad (\text{equation 1})$$

$\varphi$  is a reduction factor that depends on the welding class:

$\varphi = 1.0$  for welding class B

$\varphi = 0.9$  for welding class C

$\gamma_n$  = safety factor that depends on the potential consequences of failure.

$f_{pk} = f_{pk}$  = ultimate tensile strength of the parent metal

$f_{euk}$  = ultimate tensile strength of the filler metal

TABLE 15.2 The following values can be assumed to be valid for an ultimate tensile strength of weld,  $f_{wuk}$

	Undermatching filler metal	Overmatching filler metal
Section through weld	$f_{wuk} = f_{euk}$	$f_{wuk} = \sqrt{f_{uk} \cdot f_{euk}}$
Section adjacent to weld	$f_{wuk} = f_{euk}$	$f_{wuk} = f_{uk}$

**Ultimate strength capacity**

Welded joints might be designed to resist the following loads:

$F_{\parallel}$  = Shear force parallel to the weld

$F_{\alpha}$  = Normal force at an angle  $\alpha$  to the section of analysis ( $0^{\circ} < \alpha < 90^{\circ}$ )

Determine the capacity of the welded joint in a section through the weld and also through a sections adjacent to weld in accordance with Equations 2 and 3, using the symbols as shown in Figure 15.34.

$$F_{R\parallel} = 0.6 \cdot d \cdot \ell \cdot f_{wd} \tag{equation 2}$$

$$F_{R\alpha} = \frac{d \cdot \ell \cdot f_{wd}}{\sqrt{2 + \cos 2\alpha}} \tag{equation 3}$$

where

$d$  = the height of the analysed sections (= the throat thickness ( $a$ ) or the leg length ( $z$ ) for a fillet weld)

$\ell$  = effective weld length (= actual weld length - deduction for end craters)

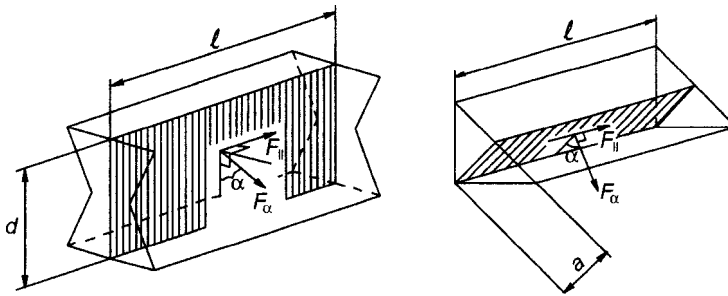


Figure 15.33 Symbols as used in the analysis section through the weld.

Use equation 4 when loads are acting both parallel and perpendicular to the weld.

$$\left(\frac{F_{\parallel}}{F_{R\parallel}}\right)^2 + \left(\frac{F_{\alpha}}{F_{R\alpha}}\right)^2 \leq 1.0 \tag{equation 4}$$

Note that  $F_{\parallel}$  indicates shear loads only. When dimensioning (for example) the welds between the flanges and the web in an I-beam, do not take into consideration the longitudinal normal stress  $\sigma_{\parallel}$  in the welds.

## Example of calculations for a statically loaded joint

Calculate the capacity perpendicular to the weld in Figure 15.35.

Effective length of the weld,  $\ell = 200$  mm.

Material: EN 10025: S275JR ( $f_{uk} = 410$  N/mm<sup>2</sup>)

Electrode class ISO E51 4 B ( $f_{euk} = 510$  N/mm<sup>2</sup>)

Safety against failure  $\gamma_n = 1.1$

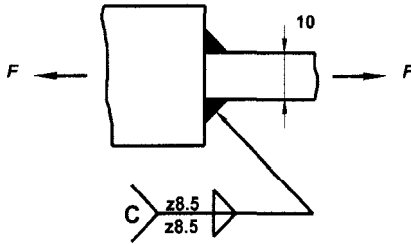


Figure 15.35 Double fillet weld.

### Solution:

Check Sections I, II and III as shown in Figure 15.36.

Welding class C, in accordance with the weld symbol shown in Figure 15.35, which means that  $\phi = 0.9$ .

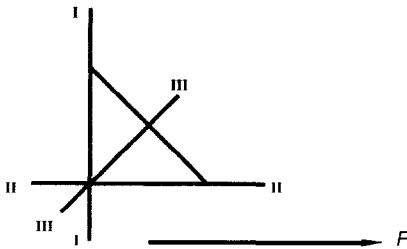


Figure 15.36 Sections to be checked in a fillet weld.

For Sections I and II, we have  $f_{wuk} = f_{uk} = 410$  N/mm<sup>2</sup>.

For Section III:  $f_{wnk} = \sqrt{f_{uk} \cdot f_{euk}} = \sqrt{410 \cdot 510} = 457$  N/mm<sup>2</sup>

Only normal forces perpendicular to the weld ( $F_{\alpha}$ ) act.

### Section I (adjacent to the weld):

$\alpha = 90^{\circ}$   $d = z = 8.5$  mm (for each weld).

From Equations 1 and 3, we obtain:

$$F_{R\alpha} = \frac{d \cdot \ell \cdot f_{wd}}{\sqrt{2 + \cos 2\alpha}} = \frac{d \cdot \ell \cdot \phi \cdot f_{wuk}}{1.2 \cdot \gamma_n \cdot \sqrt{2 + \cos 2\alpha}} = \frac{8.5 \cdot 200 \cdot 0.9 \cdot 410}{1.2 \cdot 1.1 \cdot \sqrt{2 + \cos 180}} = 475 \cdot 10^3$$

N = 475 kN (for each weld)



**Section II (adjacent to the weld):**

$$a = 0'' \quad d = z = 8,5 \text{ mm (for each weld).}$$

From Equations 1 and 3, we obtain:

$$F_{R\alpha} = \frac{d \cdot \ell \cdot \varphi \cdot f_{wuk}}{1.2 \cdot \gamma_n \cdot \sqrt{2 + \cos 2\alpha}} = \frac{8.5 \cdot 200 \cdot 0.9 \cdot 410}{1.2 \cdot 1.1 \cdot \sqrt{2 + \cos 0}} = 274 \cdot 10^3$$

$$N = \underline{274 \text{ kN (for each weld)}}$$

**Section III (through the throat thickness of the weld):**

$$a = 45^\circ \quad d = z / (\sqrt{2}) = 6 \text{ mm (for each weld).}$$

$$F_{R\alpha} = \frac{6 \cdot 200 \cdot 0.9 \cdot 457}{1.2 \cdot 1.1 \cdot \sqrt{2 + \cos 90}} = 264 \cdot 10^3 \quad N = \underline{264 \text{ kN (for each weld)}}$$

Answer: The load capacity is  $2 \times 264 = 528 \text{ kN}$ . The most critical section is Section III, through the weld throat.

Comments: The load capacity in the 10 mm steel is

$$F_{PL} = 10 \cdot 200 \cdot \frac{410}{1.2 \cdot 1.1} = 621 \text{ kN} > 528 \text{ kN} \quad \text{O.K.}$$

In other words, the weld will fail before the 10 mm steel does. A simple rule of thumb for double fillet welds is that the leg length should be about  $1.0 \times t$  (where  $t$  = the thickness of the parent metal), if the weld is to be equally strong as the parent metal.

## 15.8 Welded structures subjected to fatigue loads

### Some general notes on fatigue of welded joints

With steadily increasing demands for low weight and reduced manufacturing costs, it has become essential to solve the problem of welded structures subjected to fatigue loads. The notes on the following pages are based almost entirely on **full-scale** tests of structures, and the resulting experience of their performance. In order to understand the phenomenon of fatigue, it is essential to be aware of the following.

- *The geometry of the weld determines its fatigue strength.*

Examination of a welded joint under a microscope shows that there are always discontinuities, particularly in the transition between the parent metal and the weld. Defects can be such as undercutting, overlaps, overrunning welds, micro-cracks, excessive convexity etc. Together with these 'micro-geometric' potential stress concentrations, the 'macro-geometric' stress concentrations for example in the form of such features as sudden changes in the cross sections, determine the fatigue strength of the welded joint. With a little experience and some imagination, it is soon quite easy to see where fatigue cracks might be likely to occur in welded joints. Some examples are shown in [Figure 15.37](#).

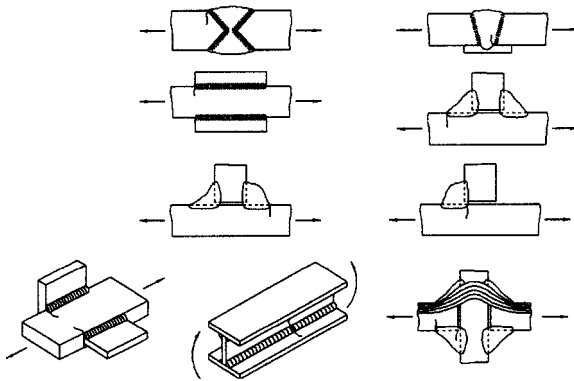


Figure 15.37 Critical points in a welded joint. Possible areas where cracks can be expected are marked.

Smoother transitions between welds and the parent metal can be obtained by grinding the weld or by TIG dressing it. In general, grinding is preferable for butt welds, while TIG dressing is often preferable for fillet welds.

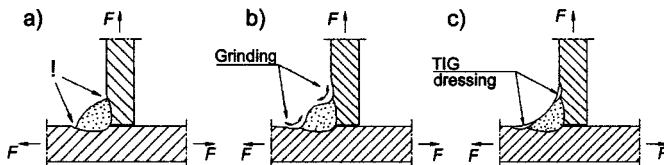


Figure 15.38 Grinding or TIG dressing reduces potential stress concentrations. a) Before treatment. b) After grinding. The direction of grinding has been marked. c) After TIG dressing.

It is particularly important to grind away any potential stress concentration effects in the transition area between the weld and the parent metal. To be on the safe side, this involves also grinding slightly into the parent metal. The reduction in stress concentration effects normally by far compensates the effect of the reduced thickness of the parent metal.

- The static strength of the parent metal (and of the filler metal) is of less importance in determining the fatigue strength of a welded joint.

This phenomenon can be explained by the theory of fracture mechanics. We normally distinguish between three different phases in the growth of a fatigue crack through the material:

- Phase 1: Crack initiation = the number of load cycles required before the discontinuities form a real crack (of the order of hundredths of a millimetre in size).
- Phase 2: Crack propagation = after formation, the crack grows by a given particular length for each new load cycle.
- Phase 3: Final failure = when the crack has grown so much that the remaining material is unable to carry the applied static load, and so a final failure occurs.

The differences in the fatigue strengths of different materials depend on the length of the initiation phase: the better the material, the longer the initiation phase.

However, once a fatigue crack has started, it will grow at the same speed in practically all grades of steel. Welding (or gas cutting) of a material destroys the microstructure and introduces so many discontinuities that the entire initiation phase can be regarded as having been passed. All that remains is the propagation phase, followed by the final failure.

As the propagation phase is the same for all types of steel, and as the final failure phase has only marginal importance, it can be shown that the lifetime of the structure is independent of the fatigue strength of the material – that is, in areas affected by the weld.

- *The absolute stress level is of lesser importance.*

In general, the residual stresses in the area around a weld are of the same order as the yield tensile strength of the material, as shown in [Figure 15.10](#). It can be shown that, regardless of what the maximum/minimum external stress ( $\sigma_{\max}/\sigma_{\min}$ ) is, the weld will be subjected to a stress that varies from the yield tensile strength value down to the yield limit minus ( $\sigma_{\max} - \sigma_{\min}$ ), [see reference \[3\]](#).

A decisive factor in determining the fatigue strength of a weld is thus the stress range  $\sigma_r = \sigma_{\max} - \sigma_{\min}$ . Note, however, that a welded joint that has been stress-relieved, or material that is not affected by the weld, is dependent on the absolute level of stress, as there are then lower residual stresses due to welding to add to the external stresses.

### Some general advice in respect of fatigue

- If the number of load cycles expected during the life of the structure exceeds 1000, a fatigue analysis should be carried out.
- Be wary of designs where natural frequency oscillation phenomena can occur. In such cases, the number of load cycles will rapidly become very large.
- If the material is not affected by the weld, then the fatigue strength will be approximately proportional to the ultimate tensile strength of the material.
- If the metal has been thermally cut, it must be regarded in the same way as a welded element as far as fatigue assessment is concerned.
- If the structure is exposed to a corrosive environment, fatigue strength will be drastically reduced: in the worst case, by up to 40 %.
- Although high-strength material may be used, a higher fatigue strength cannot be assumed if:
  - the material is affected by the weld
  - the material has been thermally cut
  - the environment is strongly corrosive.

In all these cases, fatigue strength higher than what would be the case for normal mild steel should not be expected. Nevertheless, high-strength steels can still be used if welds and thermally cut surfaces can be positioned in low-stressed areas (e.g. along the neutral axis of a beam subject to a bending moment), or if other special measures can be taken.

Hot zinc-coating reduces the fatigue strength of high-strength steels. However, this effect is negligible if the ultimate tensile strength of the basic material is less than 500 N/mm<sup>2</sup>. For a UTS of 800 N/mm<sup>2</sup>, there can be a reduction of up to 30 % in relation to the strength of an untreated rolled surface. Nevertheless, in a strongly corrosive environment, hot zinc-coating is still preferable to the use of untreated material.

### Joint classes

Over the years, considerable knowledge and experience of fatigue testing of parts and materials has been built up. One way of bringing together such material is to create a 'reference library' of tested parts. Most standards and regulations put welded joints into various categories or classes (FAT). See, for example, references [1], [2], [3] and [7]. The joint class specify the characteristic fatigue strength of the weld in  $N/mm^2$  for  $2 \times 10^6$  load cycles.

No Joint configuration		FAT	Remarks
01	Parent material, grounded surface	215	
02	Parent material, rolled surface	175 156 140	Good quality Moderate quality Exposed surface of slow rusting steel
03	Parent material, sand blasted surface		See Nos 02 and 04 -07
04	Parent material, hot dip zinc coated surface	156	
05	Parent material, sawn surface	156 175	Workmanship Class GB Workmanship Class GA Chamfered edges
06	Parent material, sheared surface		See No 05
07	Thermally cut surface	90 112	Surface roughness $\leq 0.3$ mm Corners machined to 2 mm chamfer. Surface roughness $\leq 0.2$ mm

	FAT <sub>  </sub>	FAT <sub>⊥</sub>	Remarks
10 Butt weld in double V joint	100	90	
11 Butt weld in single V joint	100	90	With root with a sealing run, alternatively welded against a backing strip which is removed
12 Butt weld in single V joint	90	71	No sealing run on root, but the quality requirement for the specified weld quality level shall apply for the root side also
13 Butt weld in single V joint with backing strip left in position	90	56	
14 Butt weld with incomplete penetration	90	-	

Figure 15.39 Examples of joint classes. Quality as per welding class B according to ISO 5817.

A reference library of joint classes can be very valuable, even without performing any fatigue analyses or any other calculations at all. Figure 15.39 is taken partly from reference [3].

**Example A:** Study joint 10 (Double-V butt weld).  $FAT_{\parallel} = 100$  and  $FAT_{\perp} = 90 \text{ N/mm}^2$ .

This weld is therefore about 10 % stronger in respect of loads parallel to its longitudinal direction compared to loads perpendicular to the weld.

**Example B:** Then compare joint 13 (butt weld with backing strip left in position):

$FAT_{\parallel} = 90$  and  $FAT_{\perp} = 56 \text{ N/mm}^2$ .

If the applied stress is parallel to the weld, we lose only about 10 % ( $FAT_{\parallel}$  being reduced from 100 to 90) when changing from a double-V butt weld to a single-V butt weld, welded only from one side.

If, instead, the stress is perpendicular to the weld, we lose almost 40 % of its strength ( $FAT_{\perp}$  falling from 90 to 56). This result feels right, as the backing strip must have a greater stress concentration effect perpendicular to the weld compared to if the stresses were acting parallel to the weld.

## 15.9 References

The following material can be particularly recommended for those wishing to learn more about dimensioning and design of welded products.

- [1] ENV1993-1-1 Eurocode 3: Design of steel structures. Part 1-1: General rules and rules for buildings. European Committee for Standardisation. Brussels 1992. (Examples of dimensioning, manufacture and inspection of steel structures. Gives simple and effective instructions on designing for fatigue strength of welded joints).
- [2] Fatigue design of welded joints and components. The international Institute of welding. A Hobbacher, Abington Publishing, Cambridge, 1996. ISBN 1 85573 315 3. (Tips, advice and instructions for constructive design and dimensioning of welded components not covered by specific sector standards and submitted to fatigue loads).
- [3] The Steel Sheet Handbook, SSAB Tunnpålar AB. Edition 3, 1996. (A general handbook for design and dimensioning of thin sheet structures in high-strength materials).
- [4] ISO 2553. Welded, brazed and soldered joints. Symbolic representation on drawings. Edition 1, 1994-09-16.
- [5] ISO 5817. Arc-welded joints in steel. Guidance on quality levels for imperfections. Edition 1, 1993-02-26.
- [6] Analysis of Welded Structures, Koichi Masubuchi, Pergamon Press Ltd, London, 1980. ISBN 0-08-022714-7. (A guide to estimating the magnitude of distortions and residual stresses).
- [7] BS 7608:1993 Code of practice for Fatigue design and assessment of steel structures. British Standards Institution, London 1993. ISBN 0 580 21281 5.
- [8] EN 13445-3 Unified pressure vessels - Part 3: Design. ICS 23.020.30. European Committee for Standardisation, Brussels 2002. (Comprehensive handbook for design and analysis of pressure vessels).

*Author: Claes Olsson*

# 16 Quality assurance and quality management

Quality requirements in respect of welded structures are set out in directives, regulations, standards or customer specifications. The company performing the work needs to analyse these requirements at the tendering stage, to decide whether or not they can be fulfilled. This is assisted by a systematic method of working. Companies with ISO 9001:2002 certification have documented procedures for this. ISO 9001:2002 are system standards concerned with quality systems. They define welding as a special process that must be properly controlled in order to ensure that the necessary quality requirements are fulfilled.

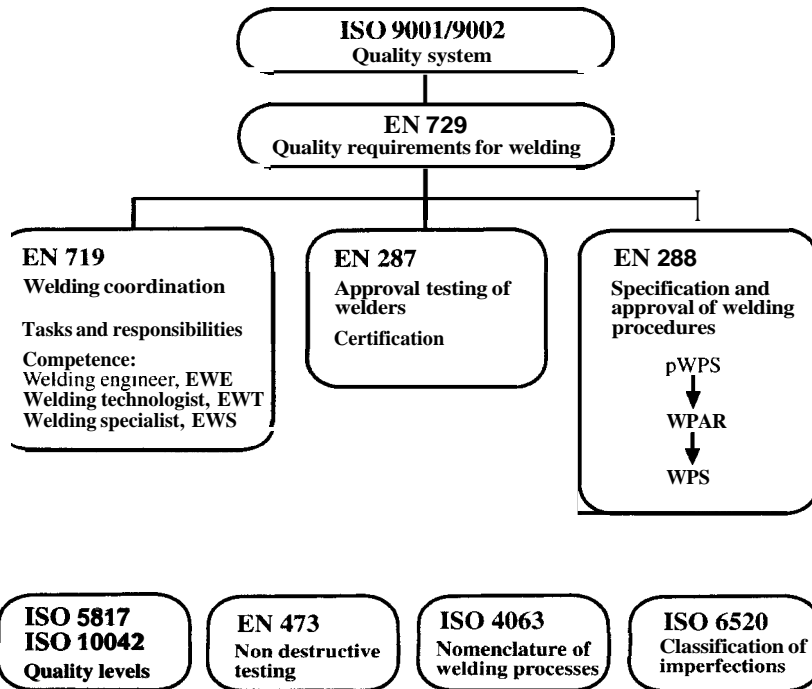


Figure 16.1 Standards that regulate quality requirements for welded structures.

Figure 16.1 shows standards that are of interest in this context. The following are further described below:

- EN 729, Quality requirements for welding
- EN 719, Welding coordination: tasks and responsibilities
- EN 287, Approval testing of welders
- EN 288, Specification and approval of welding procedures

## 16.1 Quality requirements for welding (EN 729)

EN 729 is a process standard for welding, and describes how quality assurance of welding work can be ensured. It consists of four different parts. EN 729-1, which is a guideline part, sets out the following application areas:

- a) as guidance for specification and establishment of that part of ISO 9001:2002 concerned with the management of special processes.
- b) as guidance for determination of welding quality requirements in those cases where the quality system standards are not applicable.
- c) in connection with auditing/assessment of welding quality in accordance with a) and b) above.

The standard has three different quality requirement levels, relating to *comprehensive requirements*, *standard requirements* and *elementary requirements*, so that the supplier/customer/requirements specifier can choose the requirement level that is suitable for the welding work to be performed.

EN 729-2 is used for all three quality requirement levels when ISO 9001 or 9002 requirements apply. This is because the requirements in EN 729-2 can be set at a suitable level for the particular structure concerned, depending on the effect of welding on the product safety and function. However, if ISO 9001:2002 requirements are not involved, then EN 729 is applied, as follows:

- EN 729-2 Comprehensive quality requirements
- EN 729-3 Standard quality requirements
- EN 729-4 Elementary quality requirements

The next stage in the process is to select the particular elements from EN 729-2, -3 or -4 that are applicable to the particular working area. The standard includes an appendix that provides assistance on this.

EN 729-4 specifies a minimum acceptable quality requirement level, from which no elements may be exempted. If there are requirements in respect of general quality management systems, EN 729-2 must be chosen. [Table 16.1](#) shows the requirements included in EN 729-2.

The requirement elements that are important for ensuring the welding process are numbers 6 and 7, together with parts of 9, 10, 11 and 12. Among the points specified by them are:

- that welders must have been tested and approved in accordance with EN 287 ([Section 6.2](#)), EN 1418, EN-ISO 9606-3; -4; -5.
- that NDT personnel must be qualified and approved in accordance with EN 473 ([Section 7.2](#))
- that welding must be carried out in accordance with a welding procedure specification (WPS) ([Section 9.2](#))
- that consumables must be stored and handled in such a way as to prevent absorption of moisture ([Section 10.3](#))
- that the base materials must be handled so that they cannot be confused with other materials ([Section 11](#))
- that the need for heat treatment must be considered ([Section 12](#))

TABLE 16.1 Requirement elements in EN 729-2

Requirement element	Heading number in the standard
Contract and design review	4
Subcontracting	5
Welders and other welding-related personnel	6
Inspection/testing personnel	7
Equipment	8
Activities associated with welding	9
Consumables	10
Storage of parent materials	11
Post-weld heat treatment	12
Welding inspection/testing	13
Non-conforming and corrective actions	14
Calibration	15
Identification and traceability	16
Quality records	17

The differences between EN 729-2 and EN 729-3 are slight, and relate primarily to requirements in respect of equipment maintenance, calibration, approval of WPS and batch inspections of electrodes. EN 729-1 includes an appendix that provides an overall description of the differences between the three levels of the standard.

Table 16.2 shows the relationship between requirement elements in ISO 9001 and the corresponding requirements in EN 729-2, -3 and -4. EN 729 specifies requirements in respect of a welding coordinator, and refers to EN 719, Welding Coordination - Tasks and Responsibilities (see Section 16.2).

The quality requirements specified in respect of welded products can be verified as follows:

- Specification and approval of welding procedures, which verifies the mechanical properties of the welded joint (EN 288, see Section 16.3).
- Approval testing of welders, which verifies the competence of the welder/welding operator (EN 287, see Section 16.4, EN 1418, EN-ISO 9606-3, -4, -5).
- Non-destructive testing, which verifies that the welded joint does not contain impermissible imperfections (ISO 5817, see Section 16.5).

## 16.2 Welding coordination (EN 719)

Welding is a process that requires management and coordination in order to ensure that the specified quality requirements can be fulfilled. EN 719 describes the duties and responsibilities associated with such coordination and management of welding, briefly summarised below.

The extent of the coordination required depends on the company's own requirements, requirements in applicable standards and requirements in the contract. The duties in connection with this coordination and management can be shared by a number of



persons. However, it must be defined, e.g. by documents describing the duties of the persons concerned.

TABLE 16.2 Requirement elements in ISO 9001 in comparison with EN 729 -2, -3 and -4. The figures refer to the heading numbers in the standards.

ISO 9001		EN 729-2	EN 729-3	EN 729-4
4.1.2	Organisation	6.1	6.1	
4.1.2.2	Personnel and equipment for verification	7.1/2	7.1/2	-
4.3	Contract review	4.2	4.2	(4)
4.4.5	Design review	4.3	4.3	(4)
4.6	Purchasing	5	5	(5)
4.8	Product identification and traceability	16	(15)	-
4.9	Process control – planning	9.1	(9.1)	-
	–“– instructions	9.2/4	(9.3)	(8)
	–“– welding procedure approval	9.3	9.2	-
	–“– workshop capacity	8.1/2	(8.1/2)	-
	–“– equipment	8.3/4	(8.3)	-
	–“– maintenance	8.5	(8.3)	-
	–“– heat treatment	12	(12)	-
4.10.2	Process control and testing	13.2/3	13.2/3	
4.10.3	Final inspection and testing	13.4	13.4	
4.10.4	Inspection and test reports	9.5	-	-
4.11	Calibration	15	-	-
4.12	Inspection and test status	13.5	13.5	-
4.13	Non conformance products	14	(14)	(11)
4.14	Corrective actions	14	(14)	(11)
4.15.2	Handling	10.3	10.2	-
4.15.3	Storage	11	11	-
4.16	Quality documents	17	16	(12)
4.18	Training	6.2/3	6.2/3	6

( ) = Less extensive requirements

- = No requirements

Examples of such duties include:

- specification
- control/coordinate
- inspect/witness

Somebody must be appointed as the company's authorised *welding coordinator*, authorised to issue/approve the necessary welding documents on behalf of the company.

Of the activities listed in EN 729, the following can be linked to quality-related duties in accordance with EN 719:

- Contract review
- Design review (in respect of feasibility of manufacture)
- Purchasing of base materials
- Selection of consumables
- Selection of subcontractors
- Production planning
- Selection of equipment
- Approval of welders
- Personnel for inspection/testing
- Performing the welding
- Inspection and testing
- Documentation

A suitable way of meeting the above requirements in connection with the manufacture of welded products is to use checklists for the preparation of tenders and for production planning.

### **Qualifications**

Welding coordinators must possess the necessary qualifications for their duties, in the form of general and special technical knowledge, coupled with experience from the welding industry. Under EN 719, technical knowledge can be divided into three levels: comprehensive, standard and elementary.

Examples of training and qualifications that are regarded as fulfilling the requirements in respect of technical knowledge are the following, as approved by the European Welding Federation (EWF):

- European Welding Engineer, EWE
- European Welding Technologist, EWT
- European Welding Specialist, EWS

## **16.3 Specification and approval of welding procedures (EN 288)**

EN 288, with Annexe A1:1997, describes the specifications for, and approval of, welding procedures for welding metallic materials. It consists of the following parts:

1. General rules for fusion welding
2. Welding procedure specifications for arc welding
3. Welding procedure tests for arc welding of steels
4. Welding procedure test for arc welding of aluminium and its alloys
5. Approval by using approved welding consumables for arc welding
6. Approval related to previous experience
7. Approval by a standard welding procedure
8. Approval by a pre-production weld test
9. Welding procedure test for pipeline welding

## General rules (EN 288-1)

### Application

This section of the standard defines general rules for description and qualification of welding procedures. It assumes that welding will be carried out using conventional welding methods, controlled by a welder or welding operator working in accordance with a welding procedure specification or welding data sheet. The standard applies when qualification of welding procedures is called for, e.g. in contracts, product standards, regulations or directives.

### Specification of welding procedures

All welding operations must be sufficiently planned before production starts. This includes producing welding procedure specifications for all welded joints, in accordance with the requirements of EN 288-2, and providing as much detail as required by the qualification method. All important variables that could affect the properties of the welded joint must be included. Any permissible variations must be specified.

Until the welding procedure specification has been approved in accordance with EN 288, it is classified as *preliminary*, pWPS.

### Approval

A welding procedure can be approved by one of the following alternatives:

- previous experience of such welding
- approved welding consumables
- welding procedure test
- standard welding procedure
- pre-production test welding

Annexe A of EN 288-1 sets out guidelines for application and selection of approval methods.

## Welding procedure specification (EN 288-2)

EN 288-2 specifies the technical contents of the welding procedure specification (WPS) for arc welding methods. Subject to agreement between the contracting parties, the standard may also be applied to other fusion welding methods.

A WPS must specify, in detail, how welding is to be performed. It must contain all important information relating to the welding work, with indication of whether such factors can affect the metallurgy, mechanical properties or geometry of the welded joint.

The nomenclature of welding and allied processes is specified and numbered in ISO 4063. Numbers designating the most common welding methods are shown in the table below. Model forms for WPS are given in the standard in the form of an appendix.

## Welding procedure tests for arc welding of steel (EN 288-3)

EN 288-3 sets out the conditions for welding approval procedures for the arc welding of steel, and includes the welding methods in [Table 16.3](#).

**TABLE 16.3** Numerical reference numbers of common fusion welding methods as given in ISO 4063.

Welding method	ISO 4063 designation
Metal arc welding with covered electrode	111
Flux cored metal-arc welding without gas shield	114
Submerged arc welding	12
MIG-welding	131
MAG-welding	135
MAG-welding with flux cored wire	136
TIG-welding	141
Plasma arc welding	15
Oxy-acetylene welding	311

Other fusion welding methods can be included, subject to agreement between the parties.

### Test pieces

The standard specifies the shape and minimum dimensions of standardised testpieces to be used in connection with the welding procedure. The test pieces must be sufficiently large to ensure that there is sufficient material to conduct away the heat. When impact testing of the heat-affected zone is required, the test pieces must be marked with the rolling direction.

All welding of test pieces must be carried out in accordance with the preliminary WPS, and under the same conditions as can be expected in production. Working positions and angles of slope and rotation must be as specified in ISO 6947. Tack welding must be included in the test welds if it is to be used in production. Welding and testing must be supervised by an examiner or examining body.

### Examination and testing

Testing consists of both non-destructive and destructive testing, as appropriate, and as follows:

- visual inspection
- radiographic or ultrasonic testing
- crack detection
- transverse tensile test
- transverse bend test
- impact testing
- hardness test
- macro and micro examination

The standard specifies how the test pieces shall be positioned.

### Retesting

If the welding procedure test pieces do not meet all the test requirements, the results cannot be approved. It is permissible to perform a further procedure test.

If any single test piece fails to meet the requirements due to geometrical defects, two new test pieces may be selected for retesting. If either of them fails, then the entire WPS also fails.

### **Range of approval**

A WPS that has been qualified by a manufacturer is valid for welding in workshops and at sites under the same technical management.

Welding procedure tests form the basis for qualification of a WPS, of which the important variables lie within the approval range of the procedure test. Essential variables are:

- base material
- material thicknesses
- welding method
- welding position
- type of joint
- consumables
- type of welding current
- heat input
- preheat temperature
- intermediate pass temperature
- post heat treatment

### **Documents of approved welding procedure tests (WPAR)**

Records from welding and testing shall include all the information needed for approval. Welding Procedure Approval Records (WPAR) must be signed by the examiner. Model forms of WPAR are included in the standard.

### **Older welding procedure tests**

Older welding procedure tests, carried out in accordance with national standards or specifications, can be approved provided that the technical requirements in EN 288 are fulfilled and that the test conditions correspond to the production conditions that will be encountered. Use of these older welding procedure tests shall be agreed between the contracting parties.

### **Welding procedure test for arc welding of aluminium and its alloys (EN 288-4)**

In a similar manner to EN 288-3, EN 288-4 describes the conditions applicable to approval of welding procedures to be used for arc welding of aluminium and its weldable alloys in accordance with ISO 2092 and 2107. These welding methods are MIG welding, TIG welding and plasma welding.

The standard, which follows the same principles as in EN 288-3, specifies how welding is to be performed and what tests that are to be carried out. Important variables for the procedure test are the same as for steel, but with lesser differences in the validity area. Note that welding position is an essential variable.

Tensile testing employs a correction factor linked to the type of alloy of the base material and its as-delivered conditions. Bend testing is carried out using a larger former diameter for the high-strength alloys than for untreated aluminium.

## **Use of approved welding consumables (EN 288-5)**

EN 288-1 allows welding procedures to be approved on the basis of their use of approved consumables. This method is described in EN 288-5, which applies for repetitive welding operations and for workpiece materials of which the structures and properties in the heat-affected zone do not degrade during operation.

For steel, applicable welding methods are metal-arc welding, MIG/MAG welding and TIG welding, while MIG welding and TIG welding are approved for aluminium. The standard applies to carbon manganese steels and chrome nickel steels, as well as for pure aluminium and non-heat-treatable aluminium alloys. Base material thicknesses are 3–40 mm.

Approval is given by an examiner or examining organisation, based on the workpiece material specification in accordance with an EN standard, and description of approved consumables in accordance with the relevant EN standards and a specific pWPS in accordance with EN 288-2. Approval is valid as long as the approved consumables continue to be used, and is documented by means of the examiner's initials and dating on the pWPS concerned.

## **Approval related to previous experience (EN 288-6)**

Many workshops have considerable experience of the manufacture of welded structures involving third-party inspection, with good operating experience of the finished products. In such cases, the welding procedure can be approved on the basis of reference to previous experience. EN 288-6 describes the conditions for this procedure, and covers metal arc, submerged arc, MIG/MAG, TIG and plasma welding.

It must be possible to document an EN 288-2 pWPS based on previous experience by authentic tests or investigations that show that the technical specification requirements for the product are fulfilled. Two methods of documentation are specified:

- I. Documentation of testing (e.g. non-destructive or destructive testing, leak testing), together with a summary of welding production over a period of at least one year.
2. The performance records of welds in operation over a suitable period (five years can be suitable).

Range of approval is in accordance with EN 288-3 and 288-4, and continue to apply as long as manufacturing is carried out in the prescribed manner. Approval is documented by the examiner initialling and dating the preliminary WPS, which is then kept by the manufacturer.

## **Approval by a standard welding procedure (EN 288-7)**

EN 288-7 describes the conditions for approval and use of a standard welding procedure. These procedures are restricted to the material groups and workpiece thicknesses specified in EN 288-7.

A standard WPS must comply with the requirements in EN 288-2, and be approved by an examiner or examining body who/that verifies that welding and testing are carried

out in accordance with the requirements of the standard. Organisations that have prepared approved standard welding procedures can then supply them as bases for other companies various welding data sheets. The use of standard welding procedures, as of approved consumables or previous experience, can be limited by standards applicable to particular products or by requirements in contracts.

The use of standard welding procedures requires the involvement of a welding coordinator in accordance with EN 719, coupled with a requirement that the company's quality management system must fulfil the requirements of the applicable part of EN 729.

Standard welding procedures are valid as long as the above requirements are fulfilled.

### **Approval by a pre-production weld test (EN 288-8)**

Welding procedures may be approved by pre-production weld tests if the shape and sizes of test pieces in accordance with the standard do not represent the particular types of welded joints to be made. The conditions associated with this method of approval are set out in EN 288-8.

The test pieces must comply with the applicable product standard, or be as agreed between the contracting parties. A pWPS must be prepared before welding the test pieces, which must be carried out under conditions representative of the planned production.

As far as possible, testing shall include the various requirements given in the standard. In general, the following tests must be carried out:

- visual inspection
- crack detection: [see Section 16.5](#)
- macro examination
- hardness test (depending on the material requirements).

In general, the validity range of approval is as set out in the applicable parts of EN 288, but restricted to the type of joint used for the testing. Approval of the procedure remains valid as long as production conditions are the same as those used during testing.

As far as possible, WPAR must comply with EN 288-3 or 288-4.

## **16.4 Approval testing of welders (EN 287)**

In general, directives and regulations relating to welded products require the competence of the welder to be stated. This can most easily be done by testing the knowledge and capabilities of the welders. EN 287, with Annexe A1:1997, sets out important requirements for approval and certification of persons welding steel or aluminium. Welding operators are tested in accordance with EN 1418: those welding copper, nickel or titanium are tested in accordance with EN-ISO 9606-3, -4 and -5.

Welder certificates issued by an examination body in one country must be acceptable to examining bodies in other European countries. There are, however, certain exceptions: e.g. national regulations may require that only certification bodies in the country concerned may issue welder certificates for particular types of work. This restriction will disappear when all EU directives for welded products are implemented.

## Essential parameters for welder testing

### Welding methods

EN 287 covers metal arc welding with covered electrodes, submerged arc welding, MIG/MAG welding, TIG welding, plasma and gas welding. Other fusion welding methods may be included, if specifically agreed.

### Types of welds

Butt welds and fillet welds in sheet, plate and pipe (hollow sections are regarded as being pipes).

### Material groups

- W01 CMn steel,  $R_{eH} < 360$  MPa
- W02 CrMo/CrMoV, steel
- W03 Fine-grained steel, normalized, quenched and tempered steel,  $R_{eH} > 360$  MPa
- W04 Ferritic stainless steel, Cr = 12–20%
- W11 Stainless ferritic-austenitic and austenitic CrNi-steel
- W21 Pure aluminium
- W22 Non-heat-treatable alloys
- W23 Heat treatable alloys

Information on other important aspects of welder testing, such as consumables, metal thicknesses, pipe diameters and welding positions, is given in the standard.

## Performing welder testing

Approval testing of welders in accordance with EN 287, 1418 and 9606 means that the company must review its activities and decide what material qualities, metal thicknesses and pipe diameters the company needs to weld. Welding positions for the various welding methods must also be defined.

When deciding on the type of product (plate/sheet or pipe), the company must consider the requirements in the standard concerned with renewal of welder testing: with reasonable continuity, welders must have carried out welding work covered by their approval.

In general, approval of a welder's capabilities also includes approval of all welds made by the welder and regarded as easier than the test weld. The validity of approvals of welders is set out in tables in the standard.

Welder tests must be conducted in accordance with a welding procedure specification or welding data sheet. This may be preliminary (pWPS), based on the company's aggregated welding abilities, or qualified, depending on the particular product requirements.

Welder testing must be supervised by an examiner or an examining test body that is accepted by the contracting parties. The examiners may be employed by the manufacturer or purchaser, or by a third party, as determined by the contract requirements. The highest approval level is given if examining is carried out by an accredited certification body for certification of personnel.

Although not obligatory, the welder's theoretical knowledge may also be tested. This will require the welder to have knowledge of:



- The important parts of the welding equipment
- Identification of base materials
- Methods for preheating and checking preheat temperatures
- Handling of consumables
- Welding procedure specifications, selection of welding parameters
- The causes of welding defects and measures to avoid defects
- Safety requirements
- Validity of the welder's certificate.

The test methods used for assessment are:

- Visual inspection
- Radiography
- Bend test
- Fracture test
- Macro examination.

The method to be used depends on the welding method, the shape of the product and the type of joint.

Acceptance criteria for test welds shall be determined in accordance with ISO 5817, Level B, for steel, and ISO 10 042 for aluminium. ISO 6520 describes imperfections. Reference should also be made to corresponding acceptance criteria for non-destructive testing.

### **Duration of validity**

Welder certificates are issued under the full and sole responsibility of the examiner or examining body. They remain valid for two years, provided that the welder continues to work within the validity area and does not take a break of longer than six months. This must be certified by the employer/foreman every sixth month.

Certificates can be extended for further periods of two years, provided that the welder's work continues to fulfil specified quality requirements, which must be confirmed by documentation of tests of the welding work. The examiner or examining body who/that issued the certificate can extend the validity of the certificate if the above conditions are fulfilled.

## **16.5 Non-destructive testing**

Quality levels must be clearly specified if the quality of welds is to be determined by non-destructive testing. This is done in accordance with ISO 5817 and ISO 10 042, Arc-welded Joints in Steel and Aluminium - Guidelines for Quality Levels for Discontinuities and Geometric Imperfections. These two standards have three different quality levels:

<b>Quality level</b>	<b>Symbol</b>
Moderate	<b>D</b>
Average	<b>C</b>
High	<b>B</b>

These quality levels are used in application standards or by the designer. The most widely used methods of non-destructive testing are:

Radiography	RT
Ultrasonic testing	UT
Magnetic particle testing	MT
Liquid penetrant testing	PT
Eddy current testing	ET

**Radiography** is used to reveal primarily internal volumetric discontinuities. The films are evaluated against the required quality level. Use of this method is limited by the thickness of the weld, which should not exceed 50 mm.

**Ultrasonic testing** is most suitable for detecting internal plane discontinuities. It requires a good test surface. The material should not be less than 8 mm thick for reliable evaluation.

**Magnetic particle testing** is a surface testing method, used to reveal discontinuities in or immediately below the surface of ferromagnetic materials.

**Liquid penetrant testing** is also a surface testing method, and is used to reveal discontinuities in the surface of non-porous materials.

**Eddy current testing**, or inductive testing, is used to reveal discontinuities on or immediately below the surface of electrically conducting materials.

A common feature of all these test methods is that the test personnel must hold certificates in accordance with EN 473. Testing must also be carried out in accordance with approved test procedures.

*Author: Curt Johansson*

# 17 Welding costs

## 17.1 Welding cost calculations

The choice of a particular welding process is usually made on cost as well as technical terms. Technical limitations can be such as the type of material, its thickness, the type of joint required and/or welding position, i.e. factors that are directly linked to the capabilities of the particular welding method. In addition, there are limitations that may be imposed by special quality requirements, production resources in the factory, the work environment and so on. Despite potential benefits, a company may not have been able to invest in new welding equipment or a new welding method, with all that is involved in terms of equipment cost, training of personnel and bringing the new facilities into production.

As a result, the general determining factor in deciding on a particular welding process is usually cost – that is, to choose a process that produces the required quality at the lowest possible cost. This is assisted by a method of making welding cost calculations by means of a refined internal cost analysis procedure that calculates the costs that are specific to the welding element of the work. Traditionally, these costs are regarded as consisting of those for labour, consumables (which include shielding gas and backing materials), equipment and energy. There are, of course, many other costs, such as those for joint preparation, inspection, painting etc., all of which must be considered. The following material considers only the costs connected to job made by the welder.

Internal cost calculation can be used to arrive at the cost of welding a product, and also for comparisons between different procedures or for investment in new equipment, e.g. for the introduction of automation. It can also be used when evaluating various ways of reducing welding costs.

The model described here is best suited to ordinary fusion welding methods using filler materials. The calculations can be performed manually, or there are also more or less comprehensive computer programs that assist the work and so make it easier to compare a larger number of alternatives. Some programs include data bases for materials, filler materials, hourly rates, guide values for welding parameters and so on, which further assists the work.

It is important to realise that the accuracy of the calculations can never be better than the quality of the input data. Experience from earlier calculations, for which true costs have been obtained by post-production costing, is therefore important in ensuring that cost estimates are reliable.

## 17.2 Some welding cost concepts

Welding costing uses a number of concepts, as discussed below.

The **deposition rate** is the mass of weld metal melted into the joint per unit of time (while the arc is struck), and is usually expressed in kg/h.

In the case of welding with coated electrodes, the data sheets from the electrode manufacturers give the deposition rate at 90 % of the specified maximum current for the electrode diameter concerned. As the deposition rate depends on the current, it can be expressed in a simplified form for a particular value of current as

$$\text{Actual deposition rate} = \frac{\text{Maximum deposition rate} \times \text{Welding current}}{\text{Welding current at maximum deposition rate}}$$

The current depends on the welding position, whether the pass is for a root pass or a filler pass etc.

For MIG welding with solid wires diagrams and/or tables of deposition rates for different wire diameters and currents are available: alternatively, they can be calculated from the wire feed speed. In the case of steel, with a normal stickout, the wire feed speed is approximately:

$$\text{Wire feed speed (m/min)} = \left( \frac{\text{Welding current} + 22}{52 \times \text{Wire}} \right)^{1.43}$$

The *deposition efficiency* indicates the proportion of the gross weight of filler material actually used that is converted to useful weld metal. Coated electrodes and **flux**-cored electrodes form slag, and so the deposition efficiency for such material is considerably less than 1. The stump length of coated electrodes is normally assumed to be 50 mm, except for stainless electrodes, for which it is taken as 35 mm. In the case of filler wire, there is some loss in the form of spatter. Typical values of deposition efficiency are given in Table 17.1.

If the deposition rate is calculated from the wire feed speed, it is necessary to multiply the result by the deposition efficiency in order to compensate for slag or spatter losses.

TABLE 17.1 Typical values for comparative cost calculations.

	Operator factor	Deposition efficiency
Manual metal arc welding	0.30	0.60
MIG/MAG, solid wire	0.45	0.95
MAG, flux cored wire	0.40	0.85
Submerged arc welding	0.80	0.98

The number of electrodes needed in order to deposit 1 kg of weld metal is of interest only for coated electrodes. If the weight of weld metal is known, the number of changes of electrode that will be required can be calculated and also the associated time for slag removal after each electrode.

The *weight of weld metal* is calculated from the details of the joint as shown on the welding drawings, which gives the volume of weld metal, multiplied by the density of the material which, for steel, is 7.8 kg/dm<sup>3</sup>. The cross-sectional area of the weld, and its length, give the theoretical volume of weld metal. A fillet weld with a throat thickness of 4 mm and a length of 1 m has a weld metal volume of 16 cm<sup>3</sup>. In practice, this value may need to be compensated for excess deposition, gaps etc., which increase the volume, and/or shrinkage, which decreases the volume. Tables are available that give the weld metal volumes for various types of joints. The previously mentioned computer programs automatically calculate the volume from the given joint data.

The *job time* is the time that it takes to carry out a particular welding job, and includes the **setting-up** time and the operation time. The *setting-up time* is the time

required to set up and start the new work. In the case of mass production processes, this time will be incurred only in connection with the first workpiece to be produced. The *operation time* is the time taken for welding each workpiece, and includes:

- The *arc time*, i.e. the time for which the arc is actually struck.
- The *additional time* directly connected to the arc time, i.e. the time taken by replacement of the filler wire / electrode, slag chipping, cleaning gas nozzles etc., and directly related to the welding.
- the *handling time*, i.e. the time for handling workpieces, preparation prior to welding, such as tack welding etc. This time is very dependent of working practices and procedures.
- the *contingency allowance*, i.e. time that cannot be directly related to the welding, and which is often allowed for by a percentage addition.

The relative proportions of the total made up by the above times will vary, depending on the types of items produced, the way in which the work is carried out, the availability of ancillary equipment, the amount of mechanisation and so on.

The *operator factor* is the time for which the arc is actually burning, and can be arrived at in various ways. Tables and diagrams from the literature and from suppliers give guide values that can be used in cases where a company does not have experience of its own to draw on. Own values, of course, have the advantage of applying exactly for the company's own particular situation and circumstances. In those cases where filler material is used, the *arc time* can also be calculated from the weight of weld metal divided by the deposition rate.

The *operator factor* expresses the relationship between the time for which the arc is struck and the total welding working time. It has sometimes been incorrectly used as a measure of productivity – i.e. assuming that a high operator factor indicates a high productivity. However, using a welding method having a higher welding speed will reduce the arc time. If other times are unchanged, this will mean that the operator factor is reduced, despite the fact that the work has actually been performed more quickly. If the company has experience-based values of operator factors for some particular type of welding, the total job time can be calculated by dividing by the operator factor. Typical operator factors are shown in [Table 17.1](#).

## 17.3 Cost calculation

The *labour cost* is obtained by multiplying the *operation time* by the hourly cost. Companies know their own hourly costs, which are made up of hourly direct wages costs, employers' social insurance charges, holiday pay etc. The hourly cost often includes a share of common costs in the form of a percentage addition.

The cost of consumables needed for welding is referred to here simply by the umbrella name of *cost of filler materials*.

- Electrode (or wire in TIG welding) consumption can be calculated from the weight of weld metal divided by the deposition efficiency. Kilogram cost of electrodes is company-specific.
- Flux consumption is linked to weld metal weight by a specific flux consumption factor, stated by the flux manufacturer.

- Consumption of shielding gas can be calculated from the arc time (or corresponding time during which gas is flowing, e.g. as back shielding gas, multiplied by the gas flow rate in l/min. The gas cost (euro/l) depends on factors such as the method of supply/delivery (gas bottles, bulk tanks), and is specific for the company.

*Machine cost* can include costs for welding equipment, **mechanisation** equipment, special handling equipment and so on, and can be considerable if it includes automation and/or robot equipment. The hourly cost of the equipment can be calculated from the costs for depreciation, interest and maintenance, together with an estimate of the annual use time. The details of this calculation, and of the elements to be included, vary from company to company. The machine costs for a particular welding job can be calculated from the hourly machine cost and the operation time.

The *energy cost* can be calculated from the arc time and power demand during welding, possibly with the addition of an allowance for no-load operation. It is not normally necessary to allow for the uncertainties that have to be considered for the other costs. Energy costs usually amount to about 1–2 % of the total costs.

<b>Labour cost</b>	
Wages:	$\frac{\text{Weld metal (kg)} \times \text{hourly cost (euro/h)}}{\text{Deposition rate (kg/h)} \times \text{Operator factor}}$
<b>Cost of filler materials</b>	
Electrode:	$\frac{\text{Weld metal (kg)} \times \text{Electrode cost (euro/kg)}}{\text{Nyttotal}}$
Gas:	$\frac{\text{Weld metal (kg)} \times 0.06 \times \text{Gas consumption (l/min)} \times \text{Gas cost (euro/m}^3\text{)}}{\text{Deposition rate (kg/h)}}$
Flux:	Rel. flux consumption (kg/kg) x Weld metal (kg) x Flux cost (euro/kg)
Backing:	Weld length (m) x Backing cost (euro/m)
<b>Machine cost</b>	
Equipment:	$\frac{\text{Weld metal (kg)} \times \text{Machine cost (euro/h)}}{\text{Deposition rate (kg/h)} \times \text{Operator factor}}$
<b>Energy cost</b>	
Electricity:	Energy consumption (kWh) x energy cost (euro/kWh)

Figure 17.1 Formulae for calculating welding cost.

The cost of backing support is a function of weld length.

Comparison of all the above costs shows that it is the labour cost that is by far the highest for manual welding. A typical example from welding plain carbon steel can be 80–90 % for labour cost, 5–15 % in cost of filler materials and 3–5 % for machine costs. The cost of filler materials becomes more significant when welding expensive materials

such as stainless steel. Machine costs become significant only when automated and robot welding come into the picture. Measures to reduce costs are therefore concentrated on reducing the operation time.

Figure 17.1 shows a cost calculation based on theoretical calculations of the weld metal weight.

Anderdahl Svetskunskap AB BGT Components AB 268 33 SVALÖV		Cost Calculation						pWPS no: p013:00 Page 1 of 1 Date: 12/23/2002				
Customer: Arjo		Made by: Arne Anderdahl, EWE						Project: Fästplatta I-23949D		Place:		
Reparation												
		Time (h)	Cost									
Gouging:		0.00	0.00									
Backing:		0.00	0.00									
Grinding:		0.00	0.00									
Tacking:		0.00	0.00									
Run	Electrode	Flux, Gas	T <sub>j</sub> consumption (h)		Cost Calculation							
	kg	Cost	kg	Cost	Arc	Process	Welding	Equipme	Welding	Per kg	Total	
1	0.08		0.00	0.02	0.04		0.04	0.07	1.41	10.95	160.68	12.38
Total				0.02					1.41	10.95		12.38
Total costs (Rep. + welding)											12.38	

Figure 17.2 An example of a welding cost calculation, using the *Weldplan* program.

## Computer programs for welding cost calculations

Various types of computer programs for calculating welding costs are available. The simpler ones lack data bases of filler materials, additional times etc., but are cheap and user-friendly. At the other end of the scale is the *Weldplan* program (developed by the FORCE Institute, Denmark). It can be used to produce a complete specification of the work, which then forms the starting point for the cost calculations. Figure 17.2 illustrates a calculation using the program. The program can also produce an operations list, itemising operations to produce a total manufacturing cost.

## Methods of reducing welding costs

One of the most important reasons for making cost calculations is to identify ways in which manufacturing costs can be reduced. Costs are influenced right from the design stage, with further input factors all the way through to production. Some examples are given below.

The biggest cost in manual welding is the *labour cost*. One way of reducing it is to introduce mechanisation and automation, described below. The various parts of the total

job time can be affected: a welding method with a higher deposition rate reduces the arc time, while changing the method completely might also make it possible to reduce the time needed for changing electrodes, slag chipping and spatter removal, thus reducing the total time. Equipment to hold or manipulate the workpiece to provide a good welding position assists welding. Planning of the work, too, is important, as perhaps only 30 % of the total time is productive arc time. It can sometimes be possible to avoid making unnecessary welds, and/or to use other production processes such as bending.

Some of the work time is the arc *time*. Even with a given welding method, it may still be possible to improve this by optimum choice of welding parameters and electrodes, and/or by avoiding depositing more weld metal than necessary. The design stage, for example, specifies the joint design and throat thickness of fillet welds. The joint design can be such as to minimise the amount of weld metal required, naturally subject to the necessary performance requirements. Too large a throat thickness always results in more weld metal than is needed: a throat thickness of 5 mm uses 56 % more weld metal than does a throat thickness of 4 mm. It is also important to plan joint preparations, bringing together and holding the parts and welding so that no more weld metal than necessary is deposited: this will also have the additional benefit of reducing welding deformation. If, in addition, the penetration of the fillet weld can be utilised to reduce the nominal throat thickness, there will be a further reduction in the quantity of weld metal.

The use of *filler* materials can also be influenced, although this cost needs to be related to the labour cost. If the labour cost can be reduced by more efficient welding, reduction of preparation and finishing, such as spatter removal, avoidance of two-sided welding, improved quality etc., additional cost for filler materials can be justified.

Bear in mind, too, the overall production process. The correct quality of materials, fillers, careful joint preparation and bringing together of parts all assist welding, reducing the overall time and having the least possible effects on other processes. A properly made weld generates fewer problems of inspection and possible corrections.

## 17.4 Mechanisation, automation, robot welding

Welding efficiency can be improved by the use of varying degrees of mechanisation. A certain level of mass production, or repeated production, is usually necessary, although various types of mechanisation equipment can be justified even with small batches. The introduction of mechanisation will alter the proportions between the various cost elements that make up the whole.

Setting up times are likely to be longer, particularly with more advanced automation. If manufacturing cost is to be viable, the cost of the setting-up times must be spread over a number of workpieces. The total savings emanate from lower operation time per item. Each welder can also produce more through use of the equipment, although the machine cost will be higher, reflecting the use of the advanced equipment.

Quality control costs are likely to be reduced, as production is more carefully managed when the equipment has been correctly set up. However, training and running-in will be needed, which introduces extra costs. Maintenance costs will probably also increase, in connection with the use of more complicated equipment.

Properly installed and used mechanisation / automation / robot processes improve working conditions in both physical and work content terms. Better utilisation of capital bound in products in stock is another positive factor, resulting from the ability to tailor manufacture to suit actual needs.