

UNIVERSITY OF TORONTO

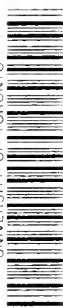

3 1761 01531028 7

Digitized by the Internet Archive
in 2007 with funding from
Microsoft Corporation

TO THE GRADUATES
OF THE
YALE SCHOOL OF FORESTRY

PREFACE

THE need of a handbook on seeding and planting in forest practice applicable to conditions in the United States is apparent. With the exception of a few pamphlets widely scattered through the publications of the National Forest Service and the forestry departments of several states and recent articles in the Forestry Quarterly and in the Proceedings of the Society of American Foresters, but little of trustworthy character dealing with this important subject has yet appeared in this country. The forestry literature of Europe, however, is particularly rich in this field. Although European methods cannot be blindly followed in forestry practice in the United States, cultural principles apply alike in this country and Europe. For this reason foreign literature, particularly that of Germany and France, has been freely drawn upon for the principles underlying the practice.

An effort has been made to explain the *why* as well as the *how*. For this reason the fundamental principles that control success and failure in the economic production of nursery stock and the artificial regeneration of forests are emphasized as well as the details of practice. The practitioner must have a clear appreciation of underlying principles or he cannot safely be trusted to direct the details of nursery practice, seeding and planting. *He must have a broad knowledge of methods and tools in order that he may attain successful regeneration at the least cost.*

The manual is necessarily incomplete because the experience in the United States in this field is very limited; furthermore, the country presents such varied conditions of climate and soil that the details of nursery practice, seeding and planting, must necessarily differ in one locality as compared with another. Although the author appreciates that criticism is invited by the description of many methods and tools not used in the United States, he believes that they should be known where experience has fully demonstrated their usefulness elsewhere and there is a possibility that they may be used advantageously under special conditions in this country. *No method should be blindly followed. The practitioner should have a broad knowledge of many methods.* He should

be able to select or even modify the one best adapted for the particular conditions that he must meet.

Almost without exception the cultural methods described and the tools and machines figured have been used by the author or the results of the work observed by him in this country or abroad.

The methods employed in nursery work and artificial regeneration on the National Forests and the state forests and by private owners of forest property have been accepted as a safe guide for future work, provided success has been attained with due regard for economy.

Some years ago the author organized the work in seeding and planting for the U. S. Forest Service and through his later connection with that Service has had the opportunity to examine critically and report upon most of the nurseries and forest plantations established in the National Forests prior to 1908. He has also examined the more important state nurseries and plantations and the larger private nurseries where forest stock is grown for commercial purposes. A study and personal inspection has been made of forest nurseries and artificial regeneration in Europe with special reference to the application of methods and the introduction of tools that might be useful in this country. More recently he has been identified with the organization of one of the largest commercial forest nurseries in the United States. The experience gained in the actual operations of this nursery has been freely used in the preparation of the chapters dealing with nursery practice.

The introduction is devoted to a discussion of the present condition of the forests of the United States, their economic importance, and the need for artificial regeneration. Part I deals with the silvical basis for seeding and planting, more particularly the principles which underlie the choice of species, the closeness of spacing, and the composition of the stand. Part II is descriptive of the various operations in artificial regeneration and the results that may be expected from the best practice.

The writer is indebted to Prof. S. J. Record and Miss S. H. Webb for assistance in reading the proof sheets, and to the U. S. Forest Service for some of the photographs used in illustrating the text.

JAMES W. TOUMEY.

NEW HAVEN, CONN.
May 1, 1916.

CONTENTS

| | PAGE |
|---|--------|
| PREFACE | v |
| INTRODUCTION | xxiii |
| ARTICLE | |
| 1. The Forest Area of the United States | xxiii |
| 2. The Amount of Standing Timber | xxiv |
| 3. The Ownership of Merchantable Timber | xxiv |
| 4. The Necessity for Forest Management | xxv |
| 5. What Has Been Done | xxv |
| 6. What Should Be Done | xxviii |
| 7. Governmental Responsibility | xxix |
| 8. The Outlook for the Future | xxx |
| 9. Seeding and Planting | xxxi |
| 10. Reforestation by Private Individuals and Corporations | xxxiii |
| 11. Reforestation by the State | xxxiv |
| 12. Reforestation by the National Government | xxxv |

PART I. SILVICAL BASIS FOR SEEDING AND PLANTING

CHAPTER 1

DEFINITIONS AND GENERALITIES

| | |
|--|----|
| 1. The Primary Objects of Silviculture | 3 |
| 2. Chief Aim in Reproduction | 3 |
| 3. Chief Aim in Improvement | 4 |
| 4. Natural Reproduction in the Virgin Forest | 4 |
| 5. Natural Reproduction after Lumbering, Fire and Windfall | 5 |
| 6. Origin of the Crop | 6 |
| 7. Methods of Reproduction | 7 |
| 8. Natural Reproduction | 8 |
| 9. Irregularities in Natural Reproduction | 8 |
| 10. Methods of Natural Reproduction from Seed | 9 |
| 11. The Selection Method | 10 |
| 12. The Shelterwood Method | 10 |
| 13. Clear-cutting Methods | 12 |
| 14. The Strip Method | 12 |
| 15. The Group Method | 12 |
| 16. The Scattered Seed Tree Method | 13 |
| 17. Artificial Restocking Necessary | 14 |

CHAPTER II

THE CHOICE OF SPECIES IN ARTIFICIAL REGENERATION

| ARTICLE | PAGE |
|---|------|
| 1. Experimental Seeding and Planting..... | 16 |
| 2. Seeding and Planting to Realize the Object in View..... | 17 |
| 3. The Use of Exotics and Species from Remote Regions..... | 17 |
| 4. Factors upon which the Choice of Species Depends..... | 19 |
| 5. Correlation between Site Factors and Silvical Requirements..... | 20 |
| 6. The Site Factors..... | 21 |
| 7. The Effect of Atmospheric Factors on the Choice of Species..... | 21 |
| 8. Variation in Heat Requirements within the Species..... | 22 |
| 9. Light in its Relation to the Choice of Species..... | 23 |
| 10. Conditions under which Light Influences the Choice of Species..... | 24 |
| 11. The Indirect Influence of Light on the Choice of Species..... | 24 |
| 12. Humidity in its Relation to the Choice of Species..... | 25 |
| 13. Precipitation in its Relation to the Choice of Species..... | 26 |
| 14. The Mechanical Effect of Snow in its Relation to the Choice of Species..... | 28 |
| 15. Wind in its Relation to the Choice of Species..... | 29 |
| 16. Minor Atmospheric Factors in their Relation to the Choice of Species..... | 30 |
| 17. The Effect of Soil Factors on the Choice of Species..... | 31 |
| 18. Water Content in its Relation to the Choice of Species... .. | 32 |
| 19. Sites with Non-available Moisture..... | 32 |
| 20. Optimum Development and Available Moisture..... | 33 |
| 21. Judging the Amount of Soil Moisture..... | 34 |
| 22. Available Moisture in the Surface Soil..... | 34 |
| 23. The Composition of the Soil in Relation to the Choice of Species..... | 35 |
| 24. Humus in its Effect upon the Choice of Species..... | 35 |
| 25. The Physical Condition of the Soil in Relation to the Choice of Species..... | 36 |
| 26. Species Selected with Reference to their Demands upon Soil Fertility..... | 36 |
| 27. Other Factors of the Site which Influence the Choice of Species..... | 37 |
| 28. Fire..... | 37 |
| 29. Insects..... | 37 |
| 30. Fungi..... | 38 |
| 31. Grazing..... | 38 |
| 32. Lands Subject to Overflow..... | 38 |

CHAPTER III

THE CHOICE OF SPECIES IN ARTIFICIAL REGENERATION
(Continued)

| ARTICLE | PAGE |
|---|------|
| 1. The Evaluation of the Site Factors | 40 |
| 2. The Evaluation of the Site Factors by the Direct Method | 40 |
| 3. The Evaluation of the Site Factors by the Indirect Method | 41 |
| 4. The Choice of Species in Reference to their Suitability for the Particular Object in View | 43 |
| 5. Species Selected Primarily for the Production of Wood or other Useful Products | 44 |
| 6. Species Selected Primarily for the Protection which They Afford | 45 |
| 7. Species Selected for their Esthetic Qualities | 46 |
| 8. The Species Selected should be Suitable for Management under the Required Silvicultural System | 46 |
| 9. The Choice of Species in Reference to their Effect on the Site | 48 |
| 10. The Effect of Forest Vegetation on the Climatic Factors | 48 |
| 11. The Effect of Forest Vegetation on the Soil Factors | 48 |
| 12. The Character of the Forest in Reference to its Beneficial Effect on the Site | 49 |
| 13. The Age of the Stand in Reference to the Improvement of the Site | 50 |
| 14. Other Considerations which Affect the Choice of Species | 50 |

CHAPTER IV

THE PRINCIPLES WHICH DETERMINE SPACING

| | |
|--|----|
| 1. The Density of the Stand from Direct Seeding | 52 |
| 2. The Species as a Determining Factor in the Closeness of the Stand from Direct Seeding | 53 |
| 3. The Quality of the Site as a Determining Factor in the Closeness of the Stand from Direct Seeding | 53 |
| 4. Density of the Stand from Direct Seeding in the United States | 54 |
| 5. The Density of the Stand from Planting | 55 |
| 6. Close Spacing and Early Thinnings | 56 |
| 7. Wide Spacing and Delayed Thinnings | 57 |
| 8. Spacing in Forest Plantations in the United States | 58 |
| 9. Spacing in European Practice | 59 |

CHAPTER V

THE PRINCIPLES WHICH GOVERN THE COMPOSITION OF THE STAND

| | |
|--|----|
| 1. Pure Woods Compared with Mixed | 61 |
| 2. Pure Crops in Artificial Reproduction | 62 |
| 3. Dependent Species in Pure Stands | 63 |

| ARTICLE | PAGE |
|---|------|
| 4. The Disadvantages of Pure Stands..... | 63 |
| 5. The Advantages of Pure Stands..... | 64 |
| 6. Mixed Crops in Artificial Reproduction..... | 64 |
| 7. Rules for the Formation of Mixed Crops..... | 65 |
| 8. Advantages from Mixed Regeneration when Correctly Made... .. | 66 |
| 9. Even-aged Mixtures..... | 67 |
| 10. Uneven-aged Mixtures..... | 68 |
| 11. Special Considerations which may Determine the Species in the Mixture..... | 69 |
| 12. Temporary Mixtures..... | 70 |
| 13. The Use of Fillers..... | 70 |
| 14. The Use of Nurse Trees..... | 70 |

PART II. THE ARTIFICIAL FORMATION OF WOODS

CHAPTER VI

GENERAL CONSIDERATIONS

| | |
|--|----|
| 1. The Choice between Natural and Artificial Regeneration..... | 77 |
| 2. The Cost of Natural Regeneration as Compared with Artificial..... | 78 |
| 3. The Time Required for Natural as Compared with Artificial Regeneration..... | 80 |
| 4. Variation in the Character of the Stand Arising from Natural as Compared with Artificial Regeneration..... | 80 |
| 5. Advantages and Disadvantages in Artificial Regeneration..... | 81 |
| 6. Choice between Direct Seeding and Planting..... | 82 |
| 7. The Difference in Cost..... | 83 |
| 8. The Difference in Time Required for the Stand to Close..... | 86 |
| 9. The Difference in the Quality of the Stand..... | 86 |
| 10. Mixed Regeneration..... | 87 |

CHAPTER VII

FOREST TREE SEED AND SEED COLLECTING

| | |
|--|-----|
| 1. Demand for Forest Seed..... | 90 |
| 2. Sources from which Seed may be Obtained..... | 91 |
| 3. Ordering Seed from Collector or Dealer..... | 91 |
| 4. The Quality of Forest Seed..... | 91 |
| 5. The Origin of the Seed in Relation to Quality..... | 92 |
| 6. The Size and Weight of Seed in Relation to Quality..... | 95 |
| 7. Variations in Seed Filling..... | 96 |
| 8. The Average Number of Seeds per Pound..... | 96 |
| 9. The Number of Pounds of Seed per Bushel of Fruit and Cost per Pound..... | 100 |

| ARTICLE | PAGE |
|---|------|
| 10. The Degree of Ripeness and the Age of the Seed in Relation to Quality | 101 |
| 11. The Loss through Storage | 103 |
| 12. Variation in the Keeping Qualities in Different Species | 105 |
| 13. The Testing of Tree Seed | 106 |
| 14. The Determination of Purity | 106 |
| 15. The Average Percentage of Purity in Tree Seed | 107 |
| 16. The Determination of Genuineness | 109 |
| 17. The Determination of Viability | 109 |
| 18. The Determination of Viability by Direct Inspection | 110 |
| 19. Evidences of Viability from the External Appearance of the Seed | 110 |
| 20. Evidences of Viability from the Internal Appearance of the Seed | 110 |
| 21. The Determination of Viability by Physical Tests | 111 |
| 22. The Determination of Viability by Germination Tests | 112 |
| 23. Kinds of Germinating Apparatus | 113 |
| 24. Germination Tests in Soil | 114 |
| 25. Germination Tests in Media other than Soil | 115 |
| 26. The Blotter Test | 115 |
| 27. Germination Tests on Plates of Porous Clay or Plaster of Paris | 116 |
| 28. Germination Tests between Strips of Cotton Cloth or Flannel | 117 |
| 29. The Germinating Oven | 119 |
| 30. Germination Temperatures | 120 |
| 31. Special Treatment to Hasten Germination | 120 |
| 32. The Average Viability of Commercial Seed | 122 |
| 33. Germinative Capacity, Germination Number, and Germination Per Cent | 124 |
| 34. Variation in the Germinative Capacity of Fresh Seed | 125 |
| 35. Germinative Force, Germinative Energy | 127 |
| 36. The Utilization Value of Tree Seed | 130 |
| 37. Germination Values as Compared with Tree Per Cent | 132 |

CHAPTER VIII

FOREST TREE SEED AND SEED COLLECTING (*Continued*)

| | |
|---|-----|
| 1. Seed Production | 134 |
| 2. The Location of Seed Areas | 137 |
| 3. Judging the Maturity of Tree Seed | 138 |
| 4. Time for Collecting Tree Seed | 138 |
| 5. Methods of Collecting Tree Seed | 139 |
| 6. Collecting from the Ground or from a Water Surface | 140 |
| 7. Collecting Direct from the Tree | 140 |
| 8. Collecting from Squirrel Hoards | 143 |

| ARTICLE | PAGE |
|--|------|
| 9. Comparative Cost of Collecting Cones and Other Fruits of Forest Trees | 145 |
| 10. Treatment of the Fruit and Seed of Forest Trees after Collecting. . . | 146 |
| 11. Treatment of Fleshy Fruit | 147 |
| 12. Treatment of Dry Fruit | 147 |
| 13. Drying Cones by Solar Heat | 149 |
| 14. Drying Cones by Artificial Heat | 151 |
| 15. Curing the Cones before Kiln Drying | 151 |
| 16. Preliminary Drying Room | 152 |
| 17. The Maintenance of Uniform Temperature | 153 |
| 18. The Necessity for Adequate Ventilation | 154 |
| 19. Drying Cones in Improvised Rooms | 155 |
| 20. Drying Cones in Small Kilns | 155 |
| 21. Utilizing Kilns Constructed for Other Purposes | 155 |
| 22. Separating the Seed from Dry Cones | 156 |
| 23. Detaching the Wings | 159 |
| 24. The Dry Method | 159 |
| 25. The Wet Method | 159 |
| 26. Cleaning the Seed | 160 |
| 27. Species that Require Special Treatment | 160 |
| 28. Seed-extracting Plants | 160 |
| 29. The Older Type of Plant for Seed Extraction | 161 |
| 30. The Newer Type of Plant for Seed Extraction | 163 |
| 31. The Storage of Tree Seed | 166 |
| 32. Dry Storage | 168 |
| 33. Storage under Fluctuating Temperature and Humidity | 169 |
| 34. Cold Storage | 169 |
| 35. Storage in Sealed Cans, Carboys and Boxes | 170 |
| 36. Wet or Moist Storage | 171 |
| 37. Storage on or in the Ground | 172 |
| 38. Storage in Running Water | 174 |
| 39. The Treatment of Insect Infested Seed | 174 |
| 40. The Transportation of Seed | 174 |

CHAPTER IX

THE PROTECTION OF SEEDING AND PLANTING SITES

| | |
|---|-----|
| 1. Protecting the Site from Seed-eating Animals | 176 |
| 2. Destroying Rodents by Poisoning | 177 |
| 3. Protecting the Site from Plant-eating Animals | 181 |
| 4. Protection from Fire | 183 |
| 5. Methods of Protection | 184 |
| 6. Reducing the Fire Hazard by Eliminating the Cause | 184 |
| 7. Reducing the Fire Hazard by the Use of Fire Lines | 184 |
| 8. Reducing the Fire Hazard by Facilities for Fighting Fire | 186 |

CHAPTER X

PRELIMINARY TREATMENT OF SEEDING AND PLANTING SITES

| ARTICLE | PAGE |
|---|------|
| 1. Treatment of the Soil | 188 |
| 2. The Reclamation of the Soil | 188 |
| 3. Excess of Soil Moisture | 189 |
| 4. Aridity | 189 |
| 5. Impervious Subsoil | 190 |
| 6. Excess of Organic Matter | 191 |
| 7. Soil Instability | 191 |
| 8. Overcoming Soil Instability on Slopes | 192 |
| 9. Overcoming Soil Instability of Dunes | 193 |
| 10. Wandering Dunes | 194 |
| 11. Fixed Dunes | 194 |
| 12. Artificial Regeneration in Dune Regions | 195 |
| 13. Cutting off the Supply of Sand and Temporarily Holding the Soil in Place | 195 |
| 14. Establishing the Forest | 198 |
| 15. The Tillage of the Soil | 198 |
| 16. Deep Tillage | 200 |
| 17. Shallow Tillage | 202 |
| 18. Treatment of the Vegetation | 203 |
| 19. Treatment of Recently Cut Areas | 203 |
| 20. Treatment of Areas Covered with Herbaceous Vegetation | 204 |
| 21. Treatment of Areas Covered with Shrubby Vegetation | 205 |
| 22. Treatment of Areas Covered with an Overwood | 206 |

CHAPTER XI

ESTABLISHING FORESTS BY DIRECT SEEDING

| | |
|--|-----|
| 1. General Considerations | 207 |
| 2. Methods of Direct Seeding | 210 |
| 3. Full Seeding | 210 |
| 4. Amount of Seed Required | 211 |
| 5. Irregularity in Field Germination | 213 |
| 6. The Cost in Full Seeding | 213 |
| 7. Scattering the Seed | 213 |
| 8. Partial Seeding | 216 |
| 9. Methods of Partial Seeding | 217 |
| 10. Seeding in Strips | 218 |
| 11. Seeding in Lines | 218 |
| 12. The Cost of Strip and Line Seeding | 219 |
| 13. Seeding in Spots | 220 |
| 14. Large Seed Spots | 221 |
| 15. Small Seed Spots | 222 |
| 16. The Cost of Seeding in Spots | 227 |
| 17. Dibbling or Seeding in Holes | 228 |
| 18. Sowing in Pits and on Mounds | 229 |

CHAPTER XII

THE FOREST NURSERY

| ARTICLE | PAGE |
|--|------|
| 1. General Considerations | 230 |
| 2. Temporary Nurseries | 231 |
| 3. Permanent Nurseries | 232 |
| 4. Factors which Determine Success in the Production of Nursery Stock | 233 |
| 5. Administration and Supervision | 233 |
| 6. The Execution of Nursery Operations in Reference to Order and Time | 234 |
| 7. The Selection of the Nursery Site | 236 |
| 8. Soil Considerations | 236 |
| 9. Slope, Aspect and Surroundings | 237 |
| 10. Development of the Nursery Site | 238 |
| 11. The Ground Plan | 238 |
| 12. The Area | 240 |
| 13. Nursery Buildings | 241 |
| 14. Hedges and Fences | 241 |
| 15. Soil Management | 244 |
| 16. Drainage and Irrigation | 245 |
| 17. Distribution of Water | 246 |
| 18. Sprinkling | 246 |
| 19. Flooding | 248 |
| 20. Percolation from Furrows | 248 |
| 21. Sub-irrigation | 249 |
| 22. The Amount of Water Required | 249 |
| 23. The Fertility of Nursery Soil; Manuring | 250 |
| 24. Classification of Fertilizers used in Nursery Practice | 251 |
| 25. The Use and Application of Fertilizers of Vegetable Origin | 252 |
| 26. Soiling Plants in Nursery Practice | 253 |
| 27. The Use and Application of Fertilizers of Animal Origin | 255 |
| 28. Farm Manures | 255 |
| 29. The Use and Application of Fertilizers of Mineral Origin | 256 |
| 30. The Quantity of Fertilizer Required | 258 |

CHAPTER XIII

THE FOREST NURSERY (*Continued*)

| | |
|---|-----|
| 1. Cultural Operations: Technique and Methods | 262 |
| 2. Seedbeds | 262 |
| 3. Rolling the Seedbeds | 264 |
| 4. Curbing the Seedbeds | 265 |
| 5. Time of Seeding | 265 |
| 6. Methods of Seeding | 267 |

| ARTICLE | PAGE |
|---|------|
| 7. Seeding in Drills..... | 267 |
| 8. Formation of the Drills..... | 270 |
| 9. Marking Boards..... | 270 |
| 10. Drill Rollers..... | 272 |
| 11. Distribution of the Seed in Drill Seeding..... | 273 |
| 12. The Seeding Trough..... | 273 |
| 13. The Seeding Lath..... | 274 |
| 14. Covering the Seed in the Drills..... | 276 |
| 15. Drill Machines..... | 276 |
| 16. Broadcast Seeding..... | 277 |
| 17. Covering the Seed..... | 278 |
| 18. Quantity of Seed per Given Area of Seedbed..... | 280 |
| 19. Quantity of Seed per Unit of Area in Drill Seeding.... | 281 |
| 20. Quantity of Seed per Unit of Area in Broadcast Seeding | 282 |
| 21. Formula for Seed Quantity..... | 283 |
| 22. The Management of Seedbeds after Seeding and Prior to Germination..... | 285 |
| 23. Covering with Brush or Muleh..... | 286 |
| 24. Covering with Scrim, Cheese-cloth or Burlap..... | 287 |
| 25. Covering with Lath Screens or with Seedbed Boxes... | 288 |
| 26. The Management of Seedbeds after Germination Begins.. | 290 |
| 27. Shading Seedlings with Natural Covers..... | 292 |
| 28. Shading Seedlings with Artificial Covers..... | 293 |
| 29. High Covers..... | 293 |
| 30. Low Covers..... | 295 |
| 31. Brush Screens..... | 295 |
| 32. Lath or Slat Screens..... | 296 |
| 33. Scrim, Cheese-cloth and Burlap Screens..... | 298 |
| 34. Weeding and Cultivation..... | 299 |
| 35. Autumn Treatment of Seedbeds..... | 300 |
| 36. Approximate Size of 1-year Seedlings..... | 301 |
| 37. The Management of the Seedbeds after the First Year... | 302 |
| 38. Wreching or Root Pruning the Stock in the Seedbeds. | 304 |
| 39. Sowing Seed in Pots and Flats..... | 305 |
| 40. Transplant Beds..... | 307 |
| 41. The Size and Form of Transplant Beds..... | 309 |
| 42. Season for Transplanting..... | 309 |
| 43. The Transplanting Distance..... | 310 |
| 44. Transplanting Methods..... | 312 |
| 45. Hole or Pit Transplanting..... | 312 |
| 46. Trench or Furrow Transplanting..... | 314 |
| 47. Trenching with the Spade..... | 314 |
| 48. Trenching with the Hand Trencher..... | 315 |
| 49. Setting the Plants in the Trench by Hand..... | 316 |
| 50. Setting the Plants in the Trench with the Transplant- ing Board..... | 316 |
| 51. Types of Transplanting Boards..... | 317 |

| ARTICLE | PAGE |
|---|------|
| 52. Hacker's Apparatus and Machine for Transplanting 1- and 2-year Coniferous Seedlings..... | 321 |
| 53. The Cultivation of Transplant Beds..... | 324 |
| 54. Pot Transplanting..... | 325 |

CHAPTER XIV

THE FOREST NURSERY (*Continued*)

| | |
|---|-----|
| 1. The Lifting and Later Treatment of Nursery Stock..... | 326 |
| 2. Lifting Nursery Stock from Seedbeds and Transplant Beds.. | 328 |
| 3. Lifting Nursery Stock from Broadcasted Seedbeds and from Seedbeds with Closely Spaced Rows..... | 329 |
| 4. Mechanical Devices for Lifting Seedlings and Transplants | 331 |
| 5. Sorting, Counting and Bundling Nursery Stock..... | 333 |
| 6. Methods of Storing Nursery Stock..... | 335 |
| 7. The Transport of Nursery Stock..... | 338 |
| 8. Packing in Bales and Bundles..... | 339 |
| 9. Packing in Boxes..... | 340 |
| 10. Packing in Hampers or Baskets..... | 341 |
| 11. Packing in Wire Crates..... | 342 |
| 12. The Weight of Nursery Stock Used in Forest Planting..... | 344 |
| 13. Treatment of Nursery Stock on Its Receipt from the Shipper | 344 |

CHAPTER XV

THE FOREST NURSERY (*Continued*)

| | |
|--|-----|
| 1. The Overcoming of Stock Losses from Preventable Causes..... | 346 |
| 2. The Loss of Germinable Seed..... | 346 |
| 3. The Loss of Plants..... | 348 |
| 4. Protecting the Nursery from Injury caused by Adverse Weather Conditions..... | 348 |
| 5. Protecting the Nursery from Injury by Birds..... | 350 |
| 6. Protecting the Nursery from Injury by Insects..... | 353 |
| 7. Protecting the Nursery from Injury by Parasitic Fungi.. | 356 |
| 8. Damping off..... | 357 |
| 9. Blister Rust..... | 360 |

CHAPTER XVI

ESTABLISHING FORESTS BY PLANTING

| | |
|--|-----|
| 1. Historical..... | 362 |
| 2. The Planting Material..... | 363 |
| 3. The Origin of the Planting Material..... | 363 |
| 4. The Size and Age of the Planting Material..... | 364 |
| 5. The Source from which the Planting Material is Obtained.... | 366 |
| 6. The Advantages of Home Nurseries..... | 366 |
| 7. The Use of Wild Stock..... | 367 |
| 8. The Purchase of Nursery and Wild Stock..... | 368 |
| 9. Imported Forest Stock..... | 369 |

CONTENTS

xvii

| ARTICLE | PAGE |
|---|------|
| 10. The Handling of the Planting Material | 369 |
| 11. The Pruning of the Planting Material | 369 |
| 12. Conditions under which Pruning Is Desirable | 370 |
| 13. Injuries from Pruning | 370 |
| 14. Other Factors which Influence the Quality of the Planting Material | 371 |
| 15. The Planting Season | 372 |
| 16. Winter Planting | 373 |
| 17. Summer Planting | 373 |
| 18. Autumn Planting | 373 |
| 19. Spring Planting | 375 |
| 20. Spacing Methods | 376 |
| 21. Irregular Spacing | 376 |
| 22. Regular and Semi-regular Spacing | 377 |
| 23. Advantages of Regular Spacing | 377 |
| 24. Methods of Regular Spacing | 378 |
| 25. Methods of Semi-regular Spacing | 379 |
| 26. The Number of Plants per Acre | 381 |
| 27. Planting Rules of General Application | 383 |
| 28. Depth of Setting the Roots and the Downward Desiccation of the Surface Soil | 384 |
| 29. Bad Effects of Planting with the Collar of the Tree too deep in the Soil | 385 |
| 30. Bad Effects from Bending or Crowding the Roots in Planting . . | 387 |
| 31. The Advantages of Mound or Ridge Planting on Overwet Sites and under Certain Other Adverse Soil Conditions | 389 |
| 32. The Advantages of Pit or Trench Planting on Overdry Sites . . | 390 |
| 33. Bad Effects of Poor Soil about the Roots of Newly Set Plants . | 390 |
| 34. The Advantages of Planting in Deep Notches on Steep Slopes . | 391 |
| 35. Conditions under which More Than One Plant May Be Set in a Planting Hole | 392 |
| 36. Erect Planting and the Necessity for Firming the Soil about the Roots | 392 |
| 37. Advantages in Using Small Planting Material | 393 |
| 38. The Necessity for Pruning Young Trees before Planting | 393 |
| 39. The Use of Layers | 394 |
| 40. Planting Root Suckers | 395 |
| 41. Planting Root Cuttings | 396 |
| 42. Planting Shoot Cuttings | 396 |

CHAPTER XVII

ESTABLISHING FORESTS BY PLANTING *(Continued)*

| | |
|--|-----|
| 1. Planting Operations: Technique and Methods | 400 |
| 2. Classification of Planting Methods | 400 |
| 3. Planting with the Roots Enclosed in a Ball of Earth | 401 |
| 4. Lifting Balled Stock | 402 |

| ARTICLE | PAGE |
|--|------|
| 5. Transporting Balled Stock. | 402 |
| 6. Planting Balled Stock. | 404 |
| 7. Lifting and Planting Balled Stock with Special Tools. | 404 |
| 8. Planting Naked-rooted Plants. | 406 |
| 9. Planting Operations where the Opening is Made by Compression of the Soil. | 407 |
| 10. Planting with Tools which Make the Opening in the Soil in the Form of an Inverted Cone or Pyramid. | 408 |
| 11. Planting with Tools which Make the Opening in the Soil in the Form of a Notch or Slit. | 414 |
| 12. Planting Operations in which the Opening Is Made by Removing the Soil — Hole Planting. | 421 |
| 13. Hole Planting with the Grub-hoe and Mattock. | 422 |
| 14. Hole Planting with the Cylindrical Spade. | 428 |
| 15. Hole Planting with the Ordinary Spade. | 428 |
| 16. Hole Planting with the Planting Hammer and Similar Tools. | 429 |
| 17. Receptacles for Carrying Plants in Field Planting. | 431 |
| 18. Special Planting Methods. | 432 |
| 19. Biermann's Planting Method. | 433 |
| 20. Grohmann's Planting Method. | 434 |
| 21. Alemann's Planting Method. | 435 |
| 22. Manteuffel's Planting Method. | 435 |
| 23. Cone Planting Method. | 438 |
| 24. Kozesnik's Planting Method. | 439 |
| 25. Spletstosser's Planting Method. | 440 |
| 26. Oblique Planting. | 442 |
| The Botanical Names of Species Appearing in the Text. | 445 |
| Index. | 449 |

ILLUSTRATIONS

| FIG. | PAGE |
|--|------|
| 1. The forest regions of the United States..... | viii |
| 2. The location and relative size of the National Forests..... | xi |
| 3. Natural reproduction in an open space in a virgin forest..... | 5 |
| 4. Incomplete natural reproduction after lumbering and fire..... | 6 |
| 5. A pure stand of white pine after a reproduction cutting..... | 11 |
| 6. Excellent natural reproduction of white pine attained under a shelterwood..... | 11 |
| 7. Natural reproduction in groups..... | 13 |
| 8. Scattered seed trees left to provide seed for the natural regeneration of beech and to supplement the artificial regeneration of spruce..... | 14 |
| 9. Plantation of blue gum (<i>Eucalyptus globulus</i>), 28 years old..... | 19 |
| 10. Poor form and growth in a plantation of Scotch pine due to acid soil..... | 33 |
| 11. A mixed, uneven-aged stand of hardwoods and conifers..... | 47 |
| 12. A 40-year old plantation of Norway spruce spaced 4 by 4 feet, in which about two-thirds of the trees have been removed in the thinnings..... | 57 |
| 13. An unthinned white pine plantation 44 years old and spaced 8 by 8 feet..... | 58 |
| 14. An overwood of oak with an underwood of beech..... | 69 |
| 15. Reforestation by direct seeding in spots after a clear-cutting..... | 84 |
| 16. A large opening caused by windfall which made planting necessary in a forest otherwise reproduced by natural regeneration..... | 88 |
| 17. A plantation of Norway spruce 17 years old from Austrian seed.. | 93 |
| 18. Greenhouse benches arranged for germination tests..... | 115 |
| 19. An improvised germinating apparatus..... | 116 |
| 20. Cross section of Stainer's germinating apparatus..... | 117 |
| 21. Germinating flask..... | 118 |
| 22. The Geneva seed-tester..... | 118 |
| 23. Standard seed-germinating oven..... | 119 |
| 24. Tools useful in detaching the fruit of forest trees..... | 142 |
| 25. Gathering cones from a squirrel cache at the base of a tree..... | 144 |
| 26. Drying yellow pine cones by solar heat near Golden, Colorado.... | 149 |
| 27. Storage building for pine and spruce cones..... | 151 |
| 28. Removing the seed from dried Douglas fir cones..... | 158 |
| 29. Seed-extracting plant at Wyeth, Oregon..... | 162 |
| 30. Cross section of the Annaburg seed-extracting plant..... | 164 |
| 31. A broad fire line adjacent to a public highway protecting a white pine plantation..... | 185 |

| Fig. | PAGE |
|---|------|
| 32. The operation of the hand-pump in fighting a surface fire..... | 186 |
| 33. A plantation of beach grass on shifting sand..... | 197 |
| 34. Planting white pine on a recently felled area. The tops and other litter on the ground..... | 203 |
| 35. A plantation of white pine established under an overwood of oak and chestnut..... | 206 |
| 36. Sowing yellow pine seed with the cyclone seeder..... | 214 |
| 37. A pure stand of white pine established by broadcast seeding on plowed land. Thirty years old..... | 215 |
| 38. The same stand shown in Fig. 37 after a thinning which removed 13 cords of wood per acre..... | 216 |
| 39. Diagram showing the arrangement of the seeded places in partial seeding..... | 217 |
| 40. Sowing Douglas fir seed in small, prepared seed spots..... | 223 |
| 41. Tools useful for making small seed spots..... | 225 |
| 42. The Eckbo seed planter..... | 226 |
| 43. Torsion rake..... | 227 |
| 44. Spiral borers..... | 227 |
| 45. Acorn planter..... | 228 |
| 46. Direct seeding with the corn planter..... | 229 |
| 47. A forest nursery protected by high forest..... | 238 |
| 48. Nursery plan..... | 239 |
| 49. Plan of the sorting, storage and packing rooms at the North- Eastern Forestry Company's nursery, Cheshire, Conn..... | 242 |
| 50. Interior hedges in a forest nursery..... | 243 |
| 51. The Skinner overhead system of irrigation in operation..... | 247 |
| 52. Diagram of the arrangement of the seedbeds in the compartment..... | 263 |
| 53. Types of rollers used in forming seedbeds..... | 264 |
| 54. Types of marking boards..... | 271 |
| 55. The Sauer type of drill roller..... | 272 |
| 56. The Spitzenberg drill former..... | 272 |
| 57. Using the V-shaped seeding trough..... | 274 |
| 58. The double-V seeding trough..... | 274 |
| 59. Eszlinger's seeding lath..... | 275 |
| 60. Spitzenberg seed coverer..... | 276 |
| 61. The Planet Jr. seed drill..... | 277 |
| 62. Special rakes for breaking the surface soil of seedbeds..... | 278 |
| 63. Circular sieve..... | 279 |
| 64. Rectangular sieve..... | 279 |
| 65. Seedbeds covered with a mulch of leaves held in place with lath screens..... | 286 |
| 66. Seedbeds covered with burlap after broadcast seeding..... | 287 |
| 67. Standard seedbed boxes completely enclosed during the period of germination..... | 289 |
| 68. Tool for breaking the surface crust of seedbeds prior to germination | 292 |
| 69. High cover formed of brush on a framework of posts and poles... | 294 |
| 70. High cover formed of posts and scantlings covered with mats woven from narrow slats and wire..... | 295 |

ILLUSTRATIONS

XXI

| FIG. | | PAGE |
|------|--|------|
| 71. | Low cover formed of 4 by 6-foot lath screens supported on stakes 1 foot above the seedbed..... | 297 |
| 72. | Low cover of lath mats supported 1½ feet above the seedbeds.... | 297 |
| 73. | The Planet Jr. 2-wheel cultivator..... | 299 |
| 74. | The Spitzenberg wheel hoe..... | 299 |
| 75. | One-year coniferous seedlings in winter condition covered with burlap..... | 301 |
| 76. | White pine seedbeds; stock 2 years old..... | 303 |
| 77. | White pine seedbeds; stock 3 years old..... | 303 |
| 78. | Blue gum growing under cover in flats or shallow boxes..... | 306 |
| 79. | Transplanting Douglas fir seedlings by the hole or pit method.... | 313 |
| 80. | The planting hammer..... | 313 |
| 81. | Cross sections of planting trench..... | 314 |
| 82. | The hand trencher..... | 315 |
| 83. | Stringing rack and transplanting board in which the plants are held in place with a string..... | 318 |
| 84. | The combined trenching and transplanting board..... | 319 |
| 85. | Operating the combined trenching and transplanting board..... | 319 |
| 86. | The Yale transplanting board..... | 321 |
| 87. | Operating the Yale transplanting board..... | 322 |
| 88. | Hacker's pricking-out apparatus..... | 323 |
| 89. | Pricking out plants into paraffined paper pots..... | 325 |
| 90. | Lifting white pine (2-1) with the short-handled spade..... | 329 |
| 91. | The lifting fork..... | 330 |
| 92. | The Feigley tree digger..... | 332 |
| 93. | The Smith tree lifter in operation..... | 332 |
| 94. | Bundle of 50 white pine seedlings (2-0)..... | 333 |
| 95. | Sorting and bundling white pine nursery stock (2-1)..... | 334 |
| 96. | About 400,000 coniferous seedlings and transplants heeled-in on the floor of the packing shed awaiting shipment..... | 336 |
| 97. | Snow pit for storing nursery stock..... | 337 |
| 98. | Standard shipping box for coniferous seedlings and small transplants..... | 340 |
| 99. | Shipping baskets for coniferous stock..... | 342 |
| 100. | Unpacking and heeling-in coniferous nursery stock on its receipt in wire shipping crates..... | 343 |
| 101. | Standard seedbed boxes with wire tops and sides which effectively protect the beds from birds..... | 351 |
| 102. | Types of nesting boxes useful for placing in and about the forest nursery..... | 352 |
| 103. | Methods of regular spacing..... | 379 |
| 104. | Diagram of the position of the men in a planting crew of 11 workmen..... | 380 |
| 105. | Diagram showing the effect of deep planting..... | 386 |
| 106. | Yellow pine planted in shallow holes..... | 388 |
| 107. | A. Plant set in a step-like niche on a steep slope. B. Plant protected by stones on a steep slope..... | 391 |
| 108. | A. Layer from a bent-over branch. B. Aerial layer..... | 395 |

| FIG. | | PAGE |
|------|--|------|
| 109. | Tread dibble for setting unrooted cuttings..... | 398 |
| 110. | A. Balled plant with the root system incompletely retained. B. Balled plant with the root system completely retained..... | 402 |
| 111. | A. Balled plant properly planted. B. Balled plant improperly planted..... | 403 |
| 112. | The cylindrical spade..... | 404 |
| 113. | The semi-conical spade..... | 405 |
| 114. | Types of dibbles..... | 408 |
| 115. | Types of planting daggers..... | 409 |
| 116. | Planting with the dibble..... | 410 |
| 117. | Planting Norway spruce with the dibble under an overwood of oak and chestnut..... | 410 |
| 118. | Buttlar's planting iron..... | 411 |
| 119. | A plantation of 1-year Scotch pine planted at 18-inch intervals in rows 4 feet apart..... | 412 |
| 120. | The Wartenberg planting staff..... | 413 |
| 121. | Jensen's tree planter..... | 413 |
| 122. | The planting ax..... | 415 |
| 123. | T-notching with the ordinary spade..... | 416 |
| 124. | The notching spade..... | 417 |
| 125. | Planting iron with 3-edged blade..... | 418 |
| 126. | Planting yellow pine by the trencher method..... | 419 |
| 127. | Grub-hoe and mattocks..... | 423 |
| 128. | Planting white pine on a lumbered and burned area in the Adiron- dack Mountains..... | 424 |
| 129. | Arrangement of the men in a planting crew of twelve men..... | 427 |
| 130. | Types of spades used in hole planting..... | 428 |
| 131. | Planting hammer for planting small coniferous trees in the field.. | 429 |
| 132. | Short-handled grub-hoe..... | 430 |
| 133. | Receptacles for plants in field planting..... | 431 |
| 134. | Biermann's planting method..... | 434 |
| 135. | Alemann's planting method..... | 435 |
| 136. | Manteuffel's planting method..... | 436 |
| 137. | Cone planting method..... | 438 |
| 138. | Kozesnik's planting method..... | 439 |
| 139. | Spletstosser's planting method..... | 440 |
| 140. | Oblique planting..... | 443 |

INTRODUCTION

THE real necessity for seeding and planting in forest practice is evident when we consider the rapidity with which the productive forest area in the United States is decreasing and the condition in which a large part of the cut-over land is left after lumbering. Heretofore, as the supply of timber from one region has become exhausted, new areas of virgin forest have been opened to supply the market. The rapid inroads in our virgin forests in recent years have turned public attention toward the cut-over and burned areas with the hope of later obtaining from them at least a part of the nation's requirements. On many of these areas a second crop can be assured only by artificial regeneration.

1. THE FOREST AREA OF THE UNITED STATES

At the time of the settlement of the country, the forests of the United States not only were extensive but embraced some of the finest stands of timber in the world. As to quantity and variety of commercial species they were far beyond those of any other country. They were embraced chiefly in five great forest regions, having a total area of approximately 850 million acres.¹ Scrub growth and brush covered about 100 million acres additional. The northern forest covered approximately 150 million acres; the southern, 220 million acres; the central, 280 million acres; the Rocky Mountain, 110 million acres; and the Pacific, 90 million acres (Fig. 1). These forests, which once covered about 46 per cent of the total area of the country, have been reduced by fire, lumbering, and clearing to but 29 per cent, or 550 million acres.²

¹ Kellogg, R. S.: The timber supply of the United States. (U. S. Forest Service, Cir. 166. 1909.)

² Price, O. W., Kellogg, R. S., and Cox, W. T.: The forests of the United States; their use. (U. S. Forest Service, Cir. 171. 1909.)

2. THE AMOUNT OF STANDING TIMBER

The amount of standing timber in the United States at the time of settlement, based upon our present standards of use, has been placed at not less than 5200 billion board feet. Clearing, fire, grazing, and lumbering have reduced this vast stand much

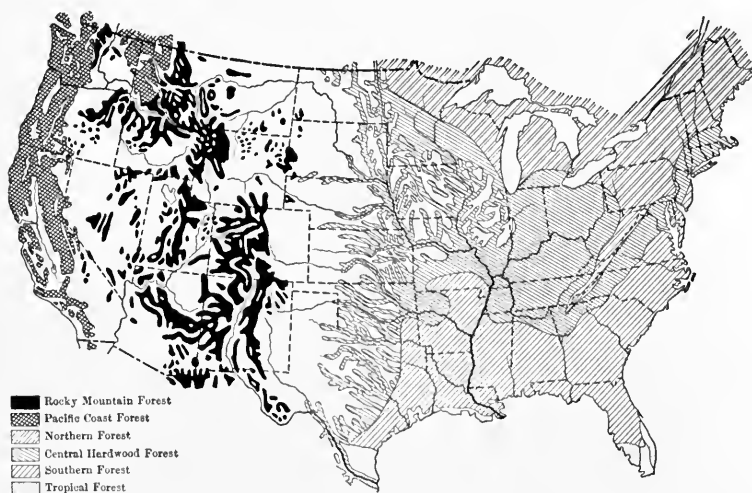

FIG. 1. — The forest regions of the United States. The unshaded areas are treeless.

faster than it has been replaced by growth. The present stand has been placed by the U. S. Forest Service at approximately 2500 billion board feet.¹

3. THE OWNERSHIP OF MERCHANTABLE TIMBER

The publicly owned forests of the United States contain more than 100 million acres of merchantable timber, the greater part of which is in the West. The estimated stand of merchantable timber in the public forests is placed at 484 billion board feet, or less than one-fifth of the total estimated stand for the entire country. Of this amount nearly 400 billion board feet are in the National Forests.

¹ The Department of Commerce and Labor estimates the present stand of timber to be 2800 billion board feet. (The lumber industry: U. S. Dept. of Commerce and Labor, Bur. of Corporations. Washington, 1913.)

The privately owned forests of the United States are either in small holdings or woodlots attached to farms, or in large holdings for the most part in non-agricultural regions. They contain approximately four-fifths of the merchantable standing timber. The woodlots of the country cover approximately 200 million acres and contain about 300 billion board feet of sawing timber, besides an enormous amount of inferior wood. The larger private holdings, chiefly in the possession of corporations, cover an area of approximately 235 million acres and contain 1700 billion board feet, or more than three-fifths of the total standing timber of merchantable quality in the entire country.

4. THE NECESSITY FOR FOREST MANAGEMENT

At the present time, every large source of timber supply in the United States is drawn upon in order to meet the demands of our timber markets. Recent years have experienced a notable shrinkage in the annual cut of some of our most valuable species. The cut of inferior hardwoods is rapidly increasing in order to meet the demand which better species cannot supply.

The necessity for forest management does not rest wholly upon our future requirements for timber. The destruction of our forests, if carried too far, will reduce the fiber and affect the general happiness of the entire nation. Our general health, both moral and physical, will suffer and our future prosperity will be jeopardized. Although we cannot measure the indirect value of the forest by money value, the history of China, Greece, Asia Minor, and many others of the older nations clearly shows its importance. The effect of the forest upon soil conservation and fertility and upon stream flow and erosion are beyond conservative estimate.

The social order in the United States is democratic. We are inclined to permit a condition in which the interests of all are made subordinate to the interests of the individual. As a result, the interests of the future, against present personal interests, are often not adequately safeguarded.

5. WHAT HAS BEEN DONE

The close of the 19th century saw but little accomplished in the United States in the organization and management of our forests. Private owners of timberlands had scarcely given a thought to

the management of their cuttings with an outlook for a second crop. But little systematic effort was made to prevent forest fires. Aside from the passage of a few fire laws, but few states had attempted any forestry legislation or acquired land for state forests.

The recent change in public sentiment is marked. The United States is now making progress in improving forest conditions. The individual, the state, and the nation are working together better than ever before in an effort to attain the greatest possible use of our forest resources for all time.

Since 1898, the National Forests have been established and, for the most part, placed under management. In March, 1915, they embraced a net area of more than 163 million acres exclusive of the purchases under the Weeks law. This vast acreage is included in 162 National Forests¹ (Fig. 2). Taking the country as a whole, these forests are very unequally distributed, being almost wholly in the western half of the country.

Within the past fifteen years state forestry has entered upon a period of progress hitherto unknown. Already fourteen states have 3,674,872 acres in state forests. Although the idea of acquiring land for state forests is comparatively new in American forestry, the time is not far distant when many, if not all, of the states east of the Great Plains will have state forests. Present economic conditions demand it. Large areas of pine barrens and other lands unfit for agriculture from which the timber has been cut must ultimately be taken over by the states.²

Serious attention has been given to communal forests in the United States only within the past five years. The ownership of forests by cities and villages has proved effective for many years in forest conservation in Europe. Although available data on the communal ownership of forests in this country is very fragmentary, recent investigations by the author show that from 200,000 to 300,000 acres are so owned in the states east of the Mississippi River. The great advantages of such ownership are beginning to be appreciated by the public and we can look forward with confidence to a rapid and constant increase in area. Heretofore communal forests have been acquired primarily for

¹ National Forest areas. (U. S. Forest Service. March 31, 1915.)

² Toumey, J. W.: Who should own the forests? (Yale Review, vol. III, pp. 145-156. 1913.)

the purpose of protecting the watersheds from which potable water is obtained, but the public need of such forests in the vicinity of cities and villages for the purpose of recreation and for timber supply is now being realized.

Many private owners of timberlands are organizing patrols for the protection of their holdings from fire. More and more attention is given yearly to closer utilization, elimination of unnecessary waste, and future growth.¹ Only a beginning, however, has yet been made in the conservation of private forests in this country.

6. WHAT SHOULD BE DONE

If the United States is to hold her present position among the timber-producing countries of the world, or even in a measure supply her future needs for forest products, persistent effort is required on the part of the nation, state, and individual.

The public forests must be managed so that they will ultimately attain their maximum production and retain it for all time. The conservation of these forests is well under way. The real needs are *the increase of the area of publicly owned forests, and the saner utilization and better care of the large areas of forest privately owned.* The 200 million acres of woodlots embraced in the farms of the country and the 235 million acres of forests owned privately, but in large holdings, must be managed so as to reduce the present waste and assure future crops. If this is not done, a larger percentage of the forests on non-agricultural lands must be taken over by the public.

The conservation of the forests depends largely upon the attitude of the public. Because of their value to the public as a whole, both the nation and the state should assist private holders of forest lands in maintaining them in the best condition as to quality and growth. This can be done by better tax laws, by better fire laws, and by the dissemination of fuller information as to how forests should be managed. A marked improvement over the present condition of private timberlands is essential. The public can well afford to make liberal appropriations for this purpose. Adequate protection can be attained only by means of an organized service during the fire season. The annual loss of

¹ Chapman, H. H., and Bryant, R. C.: Prolonging the cut of southern pine. (Yale School of Forestry, Bul. II. 1913.)

merchantable timber and young growth, and the injury to the soil does not permit of accurate estimate. Experience in the National Forests and elsewhere shows that when adequate precautionary measures are taken a very large percentage of this annual loss is preventable.

7. GOVERNMENTAL RESPONSIBILITY

The development of the human race is based upon community interests. The structure of society demands that restrictions be placed upon the individual. The fundamental conception of modern society carries with it the idea that the interests of the whole community are paramount and that those of the individual are subordinate whenever the interests of the whole and those of the individual are opposed. Through the machinery of government, the individual is deprived under due process of law of property, liberty, and even life, whenever the same is demanded for the public good. (The government, through its laws, prescribes the limits within which full liberty for individual development is given. These restrictions are removed whenever it is advantageous to the community as a whole. But if the free action of the individual runs counter to the interests of the whole, such action is restricted.

In general, that form of government is best which permits the freest possible action on the part of the individual consistent with social development. In all communities, however, there is much of general or public concern which is better guarded and which will better serve the interests of all if kept under governmental management and control.

Present industrial development, if it be based upon exhaustion of natural resources, means national retrogression instead of advancement. The conservation of these resources within reasonable limits cannot be left wholly to the individual but is often safest under governmental control. In all of these matters, there is great difference of opinion in determining just where community control shall begin and end. On the one hand, the greatest individual freedom should be permitted; while, on the other hand, the interests of the community must be safeguarded. There is no doubt that the conditions which arise by granting the individual the fullest possible freedom consistent with the social and economic development of the community are best because they

stimulate effort, but the limits between the freedom of individual action and governmental control are extremely difficult to draw so as to attain the best results. They must necessarily vary with individual development and the character and condition of the people.

It is now very generally recognized in all civilized countries that public welfare requires forest conservation. It is also recognized that forest conservation is not attainable when left wholly to individuals. Here, then, is a condition where the government must interfere in order to further the welfare of the community as a whole. In some countries, the government exercises no special control whatever over forest property. In others, as in the United States, it exercises control over national and state forests only. In still other countries, it extends its control over private forest property, but usually only when such property is primarily of protective value. To what extent governmental control over private forest property should be exercised in this country is uncertain.

It is the judgment of the author that *at least 50 per cent of the forests on non-agricultural lands should be publicly owned*. It makes little difference whether they are owned by the nation, the states, or by cities and other community organizations.

8. THE OUTLOOK FOR THE FUTURE

The ultimate scarcity of timber in this country and its resulting effect upon national prosperity will depend very much upon what we, as a nation, do during the next half century to improve forest conditions. If our forest resources are not conserved by the exercise of reasonable foresight, they will be used up. This has been the experience of other countries which are now taking care of what they have left and extending the area by seeding and planting.

The present drain upon our forests can be very materially lessened by more fully utilizing their products through the elimination of waste and by a more extensive practice of wood preservation. *There is no inherent reason why our present forest area should not continue to supply indefinitely the real needs of the nation for forest products.* In order to do this, however, millions of dollars must be spent in the next few years in acquiring additional areas as public forest, in fire protection, and in bringing the denuded forests of the country into better condition for later crops. For

years we have been rapidly reducing our area of virgin forests, so that a large part of that which remains has been partly cut or burned over. It is estimated by the U. S. Forest Service that of our total forest area, 200 million acres are as yet unlogged; 250 million acres have been partly logged or burned over but are restocking naturally with young growth; 100 million acres formerly in merchantable forest have no young growth, or else it is too scanty to develop into a merchantable stand of timber. This vast area, practically valueless for agricultural purposes and without young growth, can be restocked by seeding and planting.

9. SEEDING AND PLANTING

Extensive afforestation and reforestation must eventually become an important part of forestry in the United States. Afforestation, however, should be regarded as a business belonging to the nation and state rather than to the individual. In the prairie regions, however, and to a lesser extent in other parts of the West where agriculture is possible, afforestation has been in the past, and will continue to be in the future, a distinct field for individual effort. Up to the present time the most successful attempts at afforestation have been on the prairie farms of the West where catalpa, locust, mulberry, Osage orange, elm, ash, and cottonwood have been grown under short rotation for local purposes. In the more strictly arid regions of the Southwest, namely, in California and Arizona, successful afforestation has been attained over limited areas by planting various species of the exotic genus *Eucalyptus*.

The high cost and difficulties experienced in attaining successful afforestation make it imperative that the work be approached with conservatism and mature judgment. Over much of the non-agricultural region of the West the possibility of successful afforestation can be determined only by long and careful experiments. It does not necessarily follow that trees planted on forestal lines will succeed because single specimens of the same species thrive. Under adverse conditions for tree growth, nearly all species appear to do better when planted as single specimens than when grown in forest stands. The natural tree growth on the arid foothills and high *mesas* of the Southwest is always in very open stands. Each tree is sufficiently distant from its neighbors to give it practically the condition of growing alone.

The question of the amount of annual rainfall is often not so important a factor in determining the possibilities for tree growth as its distribution through the year. In afforestation in this country, the forester has to face the great differences between the wet summer and dry winter of the prairie regions and the exact reverse on the Pacific coast. He has to face the difference between the cold, short summer in the high mountains and the long, hot summer of the Southwest. The conditions are so varied and, on the whole, so adverse to successful tree growth for forestal purposes on areas long denuded that afforestation should not be attempted on a large scale by either nation or state, *until experimental plantings have fully demonstrated the possibilities in each locality*. If due attention is paid to the management of present woodlands and to reforestation where necessary, the problems of afforestation will be for many years of only minor importance in this country.

Reforestation seldom, if ever, presents the difficulties that confront the forester in successful afforestation. Where trees have recently grown in forest stands, they will grow again. Here the chief consideration is an economic one, namely, how a desirable young forest can be established at the least possible cost per acre. It is this field that presents large prospects in many parts of the country at the present time and which holds out assurances of reasonable profit. Even here, however, the chances for serious mistakes in both seeding and planting are very great. While business ability and a knowledge of the subject give reasonable assurance of success, the lack of these, as has been amply demonstrated in the past, usually results in failure. Although the fundamental principles underlying reforestation by seeding and planting are the same everywhere, local conditions so profoundly affect their application that the forester must work out their manner of use for each locality separately. In going into a new region, the complete round of the seasons should be observed before an attempt is made in either seeding or planting. The climate and soil should be carefully studied and the natural enemies of the forest considered and appreciated. The reading of books cannot take the place of personal observation and the correct interpretation of the varied influences which bear upon the production of forest crops by seeding and planting. *Success in this field requires local as well as general experience*. From the very

nature of the case, no manual can be blindly followed or can be made to apply in all parts of the country equally well. There is no field of forestry in which common sense and attention to detail are so essential to success.

10. REFORESTATION BY PRIVATE INDIVIDUALS AND CORPORATIONS

Although methods of natural regeneration must be depended upon in a large measure in future forest practice in this country, there are large areas, formerly in timber, which have been so badly burned both before and after lumbering that natural reproduction is no longer possible. As these lands are, for the most part, non-agricultural, they should be brought again under forest growth. We should not expect, however, that this will be brought about by private individuals. The returns from present investments are too far in the future, man is too selfish, and the span of life is too short. The reforestation of these lands can be accomplished in a satisfactory manner only through public ownership.

Private forestry has a more distinctive and encouraging field in the agricultural regions, where, in the aggregate, there is a vast area of idle land attached to the farms. Much of this can be made productive by the introduction of forest growth through seeding or planting.

When fields through successive cropping or grazing have become exhausted or unprofitable for agriculture, the custom in this country has been to leave them to grow up to a more or less scattered growth of timber through natural seeding. The character of the stand is determined almost entirely by the composition of the adjacent woodlots. In a few instances, as in the white pine region of New England and the loblolly pine region of the South, excellent stands of timber result from this practice. In the main, however, such stands are of little value. When fields under cultivation are once abandoned for the purpose of agriculture and when there is no assurance of a desirable stand of timber through natural seeding, it is, in general, sound economy to seed or plant them with forest trees.

The farmers' woodlots produce more than half of the total hardwood consumption of the country. Although, in the main, they have been recklessly managed and culled of the better

specimens of the more valuable species, because of the quality of the soil their potential power for the production of wood of high quality is very great. When due attention is paid to fellings and when judicious thinnings are practiced, they can often be kept at their maximum production without the necessity for seeding and planting. In the past, however, the best trees have usually been cut as the market has developed until nothing is left but forest weeds and culls. The stand is so open and composed of such inferior species that natural reproduction of desirable timber in full stand is no longer possible. Seeding and planting must be resorted to in order to change the character of the stand or to fill the blanks left from natural seeding.

In many agricultural regions there is already a dearth of wood for local use. In such regions agricultural soil can often be profitably taken for the growing of timber, particularly when it is grown under a short rotation for posts, poles, and other similar purposes. Not only is seeding and planting constantly increasing in the agricultural regions, but it is being accomplished with much better judgment. Many individuals and corporations have, in recent years, begun to plant on a large scale and the demand for seed and nursery stock has increased with marked rapidity.

11. REFORESTATION BY THE STATE

The National Forests were segregated from the unoccupied public lands, consequently they are nearly all in the western half of the country. The West is well provided with reserved forest property, and for that region the future forest resources are reasonably well assured. As much cannot be said for the East where practically all lands suitable for National Forests passed from the government to private control many years ago. Although originally a region of unsurpassed forest resources, as yet scarcely a beginning has been made in providing for the future. We cannot expect that the national government will appropriate the large sums of money required to purchase all of the reserved forests necessary in the East for our future requirements. Here the outlook for forest conservation must largely rest with the states and the lesser governmental units and with private owners.

The management of the forest lands of the East cannot be safely left to the private owner. The states must exercise foresight by employing every means in their power to conserve and

use in the best manner the forest lands within their respective borders.

Vast areas of privately owned lands, formerly in timber, are now non-productive. They are not suitable for agricultural purposes, and as a result of fire and lack of foresight there is no hope for a future crop by natural regeneration. The states, counties, cities, and villages should purchase large bodies of these lands for state and communal forests and re-establish forest growth upon them.

12. REFORESTATION BY THE NATIONAL GOVERNMENT

The present area in National Forests, although in the aggregate very large, can produce but a small fraction of our wood requirements. Large areas are without trees of commercial value, much of the remainder is of value primarily because of the protection afforded mountain streams, while only about 100 million acres are covered with timber of merchantable character.

The application of silvicultural methods in cutting operations, together with protection from fire and over-grazing, will do much to increase natural growth. Often, however, the conditions for natural regeneration are very unfavorable, so much so that a long term of years must intervene before anything like a complete stand of desirable species can be attained if left wholly to natural seeding. Here, then, is a large and distinct field for seeding and planting. Furthermore, with due attention to methods, reasonable success should be attained at moderate cost.

The work of reforestation on these areas by seeding and planting is now well under way. The policy of the Forest Service is to introduce seeding and planting wherever natural regeneration cannot be successfully attained within a reasonable time. In 1905 when the National Forests were transferred from the Department of the Interior to the Department of Agriculture and placed under the supervision and management of the Forest Service, but little seeding or planting had been attempted. A little experimental work had been done in southern California, but otherwise the entire field was untouched. Soon after the National Forests were placed under the Forest Service, extensive nurseries were established in several of the western states. Although the results of this pioneer work were not always successful, the information gained was of large value. The National Forests were divided into

districts in 1907, and an experienced forester placed in charge of the seeding and planting operations in each district. Since then there has been marked progress, and each year the results show a higher degree of success. Planting sites are selected with better discrimination; forest tree seeds are collected at a diminished cost; and nursery practice is being placed on a saner and more effective basis.

In 1914 there were planted on the National Forests 9731 acres at an average cost of \$10 per acre, and there were seeded 5876 acres at an average cost of \$4.39 per acre. In July, 1915, there were 34 million trees in the National Forest nurseries. The annual output was from 8 to 10 million. The average cost of transplants was \$4.25 per thousand and of seedlings 60 cents per thousand.

SEEDING AND PLANTING

PART I. SILVICAL BASIS

SILVICAL BASIS FOR SEEDING AND PLANTING

CHAPTER I

DEFINITIONS AND GENERALITIES

Silviculture is a branch of forestry that deals with the establishment, development, and reproduction of forests. It is an art which depends for its intelligent practice upon the principles of silvics. *Silvics* may be defined as the whole body of observed facts that relate to the life of single trees and of the forest as a whole, so arranged and classified as to serve as a basis for the practice of silviculture. Silvics is a science insofar as it establishes relationships and formulates deductions which are universally true regarding the life of the forest. It aims to interpret forest vegetation as acted upon by "locality," *i.e.*, by the factors of the site such as climate, soil, and animal life.

1. THE PRIMARY OBJECTS OF SILVICULTURE

In the practice of silviculture the forester aims to attain the following:

- a. Successful regeneration either by natural means or by seeding or planting.
- b. The improvement of the forest through the various operations which add to the quality and yield of the product.

2. Chief Aim in Reproduction

The chief aim in reproduction is the early succession of the new crop after the old has been removed, consistent with reasonable economy, and the securing of a full stand and the production of the species which most fully meet the object of management. The early succession of the new crop can always be attained by expensive methods such as planting large stock and by cultivating and irrigating dry sites, but such methods are seldom justified where reproduction, although somewhat delayed, can be brought

about by less expensive methods. Successful reproduction demands a full stand, because without it *the land will not be fully utilized and the product, if not less in quantity, will be of inferior quality.*

3. Chief Aim in Improvement

The operations which affect the improvement of the forest are chiefly concerned with thinning, pruning, and the protection of the crop. The aim is to attain a full stand of the most valuable species or crop trees of the best form and most rapid growth consistent with fullness of stand and quality of product.

Nearly always in natural regeneration, and even in seeding and planting in mixtures, the resulting reproduction is not wholly of the desired composition. It very often arises that during the progress of the growth of the stand the species of greatest market value are crowded out. Well-directed thinnings made at the proper time hold the inferior species in check and enable the superior ones to thrive and ultimately to become the crop trees. Thinnings also enable the forester to favor the trees which have the best form and those which will produce wood of the highest quality. Those with crooked boles or otherwise undesirable are removed in the thinnings. By starting with a full reproduction, the thinnings can be made to induce the most rapid growth in the crop trees and, at the same time, develop a product of high quality. The pruning of the crop trees aids chiefly in improving the quality of the product. The protection of the forest from external harmful agencies such as fire, insects, and fungous diseases, is an important part of forest improvement since they may seriously affect not only the composition of the stand but the rate of growth and the quality of the product.

4. NATURAL REPRODUCTION IN THE VIRGIN FOREST

In the virgin forest, as the trees mature, die and fall to the ground, their places are taken by younger trees. Reproduction takes place in more or less isolated patches where openings occur (Fig. 3). As a result, the typical virgin forest in its climax form contains trees of all ages. It is fully stocked at all times, unless disturbed by fire, insects, or other external agents which cause the destruction of all, or a large number, of the trees at one time. In such a forest natural reproduction is easily at-

tained. The small openings that result from the death of the trees are surrounded by many seed trees, and the soil, without grass or other herbage, is in the best possible condition for the germination of seed. Consequently, thousands of seedlings fill every opening and early begin an adjustment for space, light and moisture.

5. NATURAL REPRODUCTION AFTER LUMBERING, FIRE AND WINDFALL

When the forest is disturbed by man or by some other agent which causes the destruction at one time of a large number of trees, conditions often arise which make natural restocking very slow and difficult. In some cases the openings are so large that inadequate seed is brought to the open spaces from the surrounding trees.

The resulting reproduction is incomplete (Fig. 4). More and more seed



FIG. 3. — Natural reproduction in an open space in a virgin forest near Fish Camp, California.

is brought in with succeeding years, but inadequate seed and long exposure of the soil to sun and wind cause the natural reproduction to be so slow that fifty or even one hundred years are often necessary for the forest to return to a fully stocked condition. Under such circumstances the succeeding stand is inferior to the original in composition and density. Large openings are seeded chiefly by species best adapted for the dissemination of their seed by the wind. It is for this reason that large cut-over areas and burns in the spruce and pine regions of New England are

first occupied by aspen and birch, and that large burns in the Engelmann spruce region of Colorado are first overgrown with aspen. Later on the seed from the surrounding conifers is gradually brought into the stand of birch or aspen and in time



FIG. 4. Incomplete natural reproduction after lumbering and fire.
Ashford, Washington.

they again become the dominant trees. Wherever the natural forest is disturbed by the making of large openings, whether they be made by lumbering, fire, wind or other agencies, nature's method of restocking is very slow. Often the process is so retarded that it becomes necessary to restock by artificial means, *i.e.*, by seeding or planting. From the earliest practice in silviculture, the attention of foresters has been turned toward the development of methods whereby denuded lands and large openings made in the forest may be quickly restocked with desirable species.

6. ORIGIN OF THE CROP

The crop may arise from one or more of the following sources:

- | | |
|-------------------------|---------------------------|
| <i>a.</i> Seed. | <i>d.</i> Suckers. |
| <i>b.</i> Stool shoots. | <i>e.</i> Root cuttings. |
| <i>c.</i> Layers. | <i>f.</i> Shoot cuttings. |

In silvicultural operations, reproduction is chiefly from *seed*. In some instances, however, it arises vegetatively, *i.e.*, from stool shoots, layers, suckers, and cuttings. *Stool shoots* are outgrowths from the stump which arise from adventitious buds. *Layers* are produced from branches or stool shoots bent to the ground and partially covered with earth. When roots have developed at the buried portion the shoots are separated from the parent tree and become independent plants. *Suckers* arise from adventitious buds on surface roots at a greater or less distance from the base of the parent tree. *Root cuttings* are small sections of roots which, when properly handled, develop adventitious buds and grow into independent plants. *Shoot cuttings*, or slips, are small sections of the shoot or branch which, when properly handled, develop roots and form complete plants.

All species reproduce more or less freely from seed. Consequently it can always be relied upon in restocking. Conifers with few exceptions do not reproduce vegetatively. When reproduction arises vegetatively, it is chiefly from stool shoots which form a *coppice* forest, as illustrated in the typical mixed hardwood forests of southern New England. Thus, chestnut, oak and hickory reproduce freely as stool shoots. With these and some additional species it is often expedient and more profitable to grow them as coppice. In some instances, notably with black locust and beech, root suckers may be used in restocking. When handled with sufficient care, the slips from a large variety of species can be made to strike root and grow into independent plants. In silvicultural operations in the United States, however, this means of propagation is seldom practiced except with cottonwood, sycamore, and willow. Dogwood, basswood, mulberry and many of the elms can be reproduced from layers.

7. METHODS OF REPRODUCTION

Forest reproduction may arise as follows:

a. Naturally, *i.e.*, from self-sown seed or otherwise through natural agencies. In such cases the reproduction is distinguished as *natural*.

b. Artificially, *i.e.*, from seeds or plants brought to the site by man. In such cases the reproduction is distinguished as *artificial*.

c. Through a combination of natural and artificial means. In such cases the reproduction is distinguished as *mixed*.

8. Natural Reproduction

The popular conception of forestry in the United States centers in artificial regeneration through seeding or planting. Some authors erroneously maintain that even in our wooded regions this should be the chief method for establishing new stands. On the contrary, wherever forests now exist they should, as a rule, be so harvested that a new crop arises naturally as a result of the method of cutting. We have over-emphasized the necessity for artificial regeneration and minimized the more urgent need for greater attention to the method of cutting our present stands in order that they may be followed by a new crop through natural seeding.

In general, there are but three situations under which a new crop cannot be attained through natural regeneration.

a. On sites where seed trees are too remote or too few to produce adequate seed.

b. On sites where, through soil deterioration due to surface erosion or other causes, the seed brought to the site by natural agencies will not germinate or the young plants become established.

c. On sites where for one reason or another a change of species becomes necessary for cultural or economic reasons.

9. IRREGULARITIES IN NATURAL REPRODUCTION

In nearly all forests, even where the most acceptable methods for attaining natural regeneration are practiced in making the final cuttings, there is more or less irregularity in the regeneration attained. Thus the new stand will be very dense in some places and too open in others. This irregularity is due to many variable factors. The better and more uniform the site for the particular species, the denser and more uniform the new stand; the more adverse the site, the greater the difficulties experienced in handling the cuttings so as to attain a satisfactory new crop through natural seeding. Variations in soil moisture, particularly in the surface layers, variations in light intensity, and unevenness in the distribution of seed are all important factors in causing irregularities in the new stand. In every well-managed forest it is necessary to provide for more or less artificial regeneration in order that the new stand may be fully stocked.

Under the best conditions for natural reproduction, seeding or

planting will be necessary on but a small percentage of the total area, usually only where the time and method of the removal of the final cuttings have been upset by fire, windfall, or insect depredation.¹ Under more adverse conditions, and particularly with certain species,² it is often extremely difficult to attain satisfactory natural regeneration by any practical method of final cuttings. In cases of this sort, even when natural regeneration is attempted, open spaces may constitute 50 per cent or more of the total area of the new stand which must be filled later by seeding or planting. The difficulties often experienced in attaining natural regeneration under the silvicultural systems in practice sometimes lead to clear-cutting followed by artificial regeneration. This has been the more common practice in handling coniferous species in many parts of Europe, particularly in Germany. Through the efforts of the Gayer school of silviculture, *the pendulum is now swinging in the opposite direction and special attention is being given to the growing of nearly all species in mixtures and to the removal of the final cuttings by methods which will bring the forest closer to natural conditions and not only assure better growth but make the conditions better for natural regeneration.*

10. METHODS OF NATURAL REPRODUCTION FROM SEED

Whenever practicable in the practice of forestry, reproduction ought to be the result of the fellings themselves. The ease and quickness with which it can be attained is, however, largely dependent upon the silvicultural system under which the forest is managed. The methods of natural reproduction under all silvicultural systems fall into two classes:

a. Natural seeding from trees standing over the area to be regenerated.

b. Natural seeding from trees along the border or at one side of the area to be regenerated.

When the seed trees left standing over the area to be regenerated are of all ages, as in the virgin forest, the method of regen-

¹ In the well-managed spruce and fir forests of East Baden, Germany, artificial regeneration is confined chiefly to areas damaged by windfall. When this manner of damage makes clear-cutting necessary, the area is usually regenerated by planting.

² In Europe Scotch pine is nearly always regenerated by seeding or planting, except in the mountainous regions where it is grown in mixture and forms but a small part of the total stand.

eration is called *selection*. When the seed trees left standing are relatively even-aged and the timber is removed in two or more successive fellings at relatively short intervals during the process of reproduction, the method of regeneration is called *shelterwood*. In the *selection* method the period of regeneration extends over the entire rotation and the resulting stand is all-aged. In the *shelterwood* method the period of regeneration extends over a limited period of the rotation, usually from 10 to 15 years, or the time between the first and the last fellings in the removal of the crop; the resulting stand is relatively even-aged.

The selection and shelterwood methods are often combined in practice and the period of regeneration extended to 30, or even 50, years as is the present practice in the Black Forest in Baden.

11. The Selection Method. — Natural reproduction is most easily attained in forests managed by the selection method, although in such forests it is often difficult to regulate the composition. The selection method is applicable to stands represented by trees of all ages. In such stands, trees are taken out here and there as they mature while the younger trees remain standing. Only a small percentage of the entire stand is cut at one time. The openings made by the removal of single trees or small groups of trees are always small. Because of the abundance of nearby seed trees and the protection afforded the soil, the openings are quickly filled with young trees in vigorous growth. Reproduction in a selection forest most nearly approaches that of a virgin forest, the chief difference being that in the selection forest the small openings are made by the removal of mature trees, while in the virgin forest the openings are made through the death and decay of the overmature trees. When there is an abundance of reproduction, tolerant species will often crowd out or suppress the less tolerant ones.

12. The Shelterwood Method. — The shelterwood method is applicable to relatively even-aged stands. The mature crop is removed gradually by a series of cuttings. From 10 to 15 years usually intervene between the first cutting and the removal of the last of the crop (Fig. 5). During this interval reproduction takes place. From the standpoint of reproduction, this system has many advantages. The cuttings leave a large number of seed trees more or less uniformly distributed. The shelter of the overwood protects the soil and the young seedlings and retards the



FIG. 5. — A pure stand of white pine after a reproduction cutting.
Keene, New Hampshire.



FIG. 6. — Excellent natural reproduction of white pine attained under a
shelterwood. Keene, New Hampshire.

growth of weeds, grass, and brush. The seed is provided in abundance and is well distributed. As the new growth is established before the last of the overwood is removed, the soil is not exposed as is the case in clear-cutting (Fig. 6).

13. Clear-cutting Methods. — When the seed trees are wholly or for the most part in adjacent stands, the seed must have great carrying power and be distributed over the area for a considerable number of years. All methods of reproduction from seed trees not standing over the area to be regenerated are much more uncertain than either the selection or shelterwood method. When the area is clear-cut or denuded by fire or other causes, soil deterioration is likely to occur and the ground become covered with a more or less dense growth of herbage, making regeneration more and more difficult the longer it is delayed. *Clear-cutting methods are all more or less unreliable, and, when used, we should expect to supplement them by artificial regeneration.* When regeneration is wholly or in part from seed trees standing on areas adjacent to the tract where reproduction is to be effected, the methods are as follows:

a. The strip method, *i.e.*, when the woods to be regenerated are clear-cut in strips.

b. The group method, *i.e.*, when the woods to be regenerated are clear-cut in patches.

c. The scattered seed tree method, *i.e.*, when the woods to be regenerated are clear-cut with the exception of scattered seed trees.

14. THE STRIP METHOD. — In general, the effectiveness of the strip method depends upon the width of the strips, *i.e.*, the narrower the strips the more abundant and uniform the distribution of the seed and, under favorable soil conditions, the better the reproduction. The success of this method depends also upon the points of attack, *i.e.*, the direction of the strips in reference to the prevailing wind and the shade cast by the remaining stand.

15. THE GROUP METHOD. — When the area to be regenerated is clear-cut in patches, the openings should be small. The smaller they are the better and more uniform the reproduction and the closer the approach to the selection or the shelterwood method. In the practice of this method, advantage is usually taken of openings already existing in the stand due to wind or other causes, and their area is gradually increased with the progress of reproduction (Fig. 7). This method of reproduction is most acceptable for use in uneven-aged stands of wind-resistant species.

16. THE SCATTERED SEED TREE METHOD. — This method can seldom be depended upon to attain satisfactory reproduction. It

is the oldest method of natural regeneration and was largely used throughout Europe during the 15th and 16th centuries. It is now seldom used in Europe except to supplement artificial regeneration and natural seeding from adjacent woods. It has been



FIG. 7. — Natural reproduction in groups. Forbach, Baden.

largely used in the United States in recent years, but, in the author's opinion, can result only in disappointment. Except with the most resistant species, the seed trees left are liable to be felled by the wind. The species must produce seed having great carrying power, the soil must be receptive, and the reproduction must be attained quickly or a growth of herbage will prohibit later regeneration.

The scattered seed tree method has proved most useful abroad when used in connection with artificial regeneration (Fig. 8). After clear-cutting with scattered seed trees, the area is either planted or seeded with the species which is to become the dominant part of the crop. The scattered seed trees are of other species which through natural reproduction introduce age variety, as well as variety in species, into the otherwise even-aged artificial stand.

The above methods will be practiced more and more in the United States, because the initial cost is usually less than in seeding and planting. In working the forest with the expectation of natural restocking, no matter what silvicultural system is



FIG. 8. — Scattered seed trees left to provide seed for the natural regeneration of beech and to supplement the artificial regeneration of spruce. Tharandt, Saxony.

followed, the preliminary and final cuttings must result in the creation of a suitable environment for seed production and dissemination and for germination, growth, and development.

17. ARTIFICIAL RESTOCKING NECESSARY

Although the forester must depend upon natural reproduction in the great majority of cases, in every well-managed forest it must be supplemented by seeding or planting. Even under a shelterwood when the trees stand directly over the area to be stocked, natural reproduction is often incomplete; open spaces occur which must be filled by artificial means if the resulting stand is to be complete and of uniform density. The natural restocking of cleared areas from adjacent woods is nearly always more or less imperfect, particularly when the cleared areas are large. Its success depends also very largely upon the kind and

character of the adjacent woods and the quality of the site. Therefore, in most cases of clear-cutting with natural reproduction, blanks occur which ought to be filled by seeding or planting. Because of the difficulties and uncertainties in attaining natural reproduction after clear-cutting, artificial reproduction is often advantageous because it is more certain of success and the new stand is established at once. Only the species desired are reproduced.

Abandoned farms and woodlands that have been repeatedly lumbered and burned are often without sufficient seed trees, and consequently restocking is possible only through artificial means. On prairies and other lands naturally without trees, seeding or planting is the only recourse. Artificial restocking is always necessary when a change of species is desired. It is often the case that a forest cannot be brought to the desired composition except through artificial reproduction. This is particularly true of woodlands that have been culled of the better species and otherwise neglected.

Because of the aggregate area of idle farm lands that ought to be producing timber, the large areas laid waste by repeated fires on which there is no hope of natural reproduction, and the culled and otherwise neglected condition of much of our woodland, seeding and planting must become more and more an essential part of forestry in this country. It should be clearly kept in mind, however, that artificial reproduction, because of the initial expense involved, is seldom justifiable except when conditions make natural reproduction uncertain and incomplete.

CHAPTER II

THE CHOICE OF SPECIES IN ARTIFICIAL REGENERATION

BEFORE undertaking the necessary operations for artificial regeneration, careful consideration should be given to the following:

- a. The principles which determine the choice of species.
- b. The principles which determine the spacing.
- c. The principles which govern the composition of the stand.

No amount of attention given to the actual operations of seeding or planting or to the later care of the stand can entirely overcome mistakes made in the choice of species, in spacing and in the mixture of species used.

Artificial regeneration affords much greater latitude in the choice of species than is the case in natural reproduction. In the former case, the selection is made from among all species, both exotic and indigenous, that are considered suitable to meet the special conditions. The seed or plants may be, and often are, brought from long distances. In the latter case, the seed is from mother trees on the site or in the immediate vicinity. Since seeding and planting permit a much wider range of selection, the possibility of mistakes in the choice of the species used is much greater.

1. EXPERIMENTAL SEEDING AND PLANTING

A sharp distinction should be made between experimental seeding and planting and artificial restocking for economic results. In the former case, the forester has great latitude in the choice of species and is justified in trying a great variety, exotic as well as indigenous, so long as there is any hope of success. Many species will fail, but this is to be expected in experimental work. *Because of its uncertainty, experimental restocking should always be made on a limited scale in demonstrating the desirability of a species for a particular site.*

In the selection of species for experimental purposes we should be guided primarily by the closeness of the correlation between

the site factors of the region where the regeneration is undertaken and the silvical requirements of the species tried. Because of the expense and labor involved in measuring the site factors and our very imperfect knowledge of the habitat requirements of the different species, it is usually very difficult in practice to arrive at an accurate judgment.

2. SEEDING AND PLANTING TO REALIZE THE OBJECT IN VIEW

In the comparison of the qualities of various species for use on a particular site, it is comparatively easy to arrive at a reasonably accurate judgment of the relative value of the product, the cost of reproduction, and whether the species will meet market requirements and be capable of economic handling in logging operations. It is far more difficult to arrive at a safe judgment of the silvicultural value of the several species and to what extent their requirements for growth and development are fully met by the climate, soil, and other site factors. When we select species for seeding and planting with the expectation that the resulting stand will most fully realize the object in view, whether it be for the production of a particular product or for the protection and improvement of the soil, we must usually depend upon *the best species indigenous to the immediate vicinity*. Before attempting to make our choice, a careful examination should be made of all the species growing on the site and on similar sites in the vicinity. The evidence of growing timber is much more reliable than a judgment of correlation between the site factors and the silvical requirements of a particular species. When afforestation is necessary, as in semi-arid and prairie regions, it is often more difficult to arrive at a safe selection, because we are forced in our selection to depend chiefly upon our knowledge of the site factors and the silvical requirements of the various species.

3. THE USE OF EXOTICS AND SPECIES FROM REMOTE REGIONS

In artificial reproduction, exotics and species from widely different regions are not infrequently selected for use in both seeding and planting to the neglect of the more useful species of the locality. From the standpoint of economic results, this practice is usually very hazardous. We cannot hope to modify appreciably the requirements of a species by forcing it to grow under

a set of conditions different from that of its natural habitat. For practical purposes we cannot acclimatize a forest tree.¹ Very often a species, particularly if grown for decorative purposes, will thrive under conditions quite different from its natural habitat; but, when such is the case, it seldom does as well as within its natural range. If exotics and species from more or less remote regions do well when taken to a new region, it is usually because they find the site or the conditions for vegetation the same as in their own region and not because they have become acclimatized.

In ornamental planting, exotics and species from remote habitats have a wide field of usefulness. Each tree is protected and otherwise given special attention. *They should, however, be excluded from forest crops except in those cases where actual experimental seedings or plantings have proved the species suitable for the particular site or where it can be definitely shown that the site factors are similar to those of the region from which the species is introduced.* At the present time in this country there is a growing tendency to use exotics and species from remote regions in artificial reproduction. We are using European and West American species in eastern United States, and Asiatic and East American species on the Pacific coast. The great variety of our indigenous timber trees, their high technical value, and the wide range of habitat conditions to which the different species are adapted make it reasonably certain that success lies chiefly with these species.

There are certain restricted areas where exotics have already proved of value in this country. These are the exceptions, however, rather than the rule. On some of the semi-arid, non-forested lands of California and elsewhere along the southern border of the United States, several species of *Eucalyptus* have proved of value (Fig. 9). The extensive use of Scotch pine, Norway spruce, and other European species in restocking woodlands in eastern United States is, however, in the author's opinion, to be regretted. So also the use of eastern hardwoods in artificial reproduction on the Pacific coast. In none of these regions has any of these species been brought to maturity in forest stands, and the results from such restocking are largely problematical. Often the chief inducements are rapid juvenile growth and the low cost of seed and nursery stock. Experience, both in this country and abroad, shows that species when grown outside of their range often

¹ Mayr, Heinrich: *Waldbau auf naturgesetzlicher Grundlage*. Berlin, 1909.

do well during their early life but gradually fall off in growth or fail altogether after 20, 30 or more years, or before they reach merchantable size. This is particularly true of species not climatically adapted to the site, which is quite likely to be the case when exotics or trees from remote regions are used in restocking.

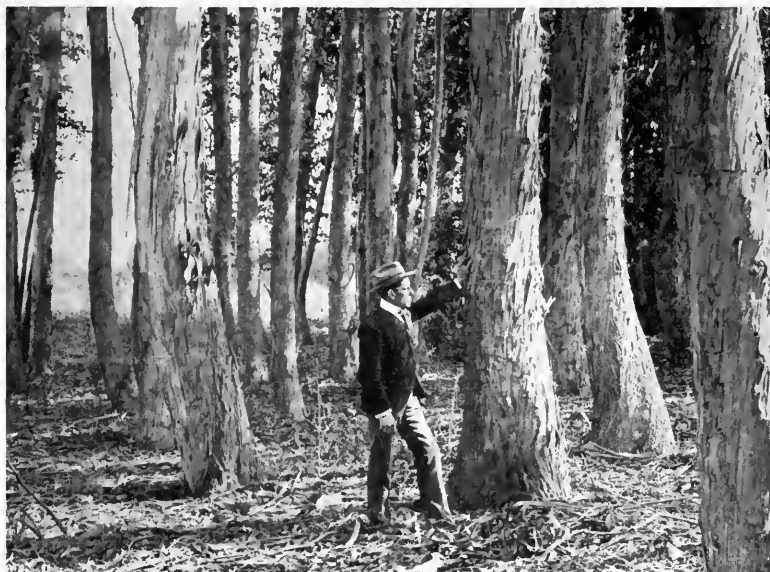

Photograph by U. S. Forest Service

FIG. 9. — Plantation of blue gum (*Eucalyptus globulus*) 28 years old. California.

4. FACTORS UPON WHICH THE CHOICE OF SPECIES DEPENDS

The desirability of a given species for use in seeding and planting depends upon a large number of variable factors, the most important of which are as follows:

- a. The closeness of the correlation between the site factors and the silvical requirements of the species.
- b. The suitability for the particular object in view.
- c. The adaptability for management under the required silvicultural system.
- d. The effect of the particular species upon the site.
- e. The cost of reproduction, rapidity of growth, and resistance to injury.

In the selection of species attention should also be given to market requirements and economic utilization. Because of the expense involved in artificial reproduction and the length of time required to discover serious mistakes, one cannot afford to indulge in speculation as to which untried species may or may not succeed. In artificial restocking from the point of view of financial results one should confine himself to those species which actual experience has proved beyond doubt are acceptable for the object in view.

5. Correlation Between Site Factors and Silvical Requirements

The comparison of the forest vegetation of one region with that of another shows that in each locality the forest has its particular mode of growth. Every kind of forest as to species and composition thrives best under a particular set of conditions. One set of soil and climatic conditions may induce an optimum growth in white pine or red pine, while it may be wholly unsuited for the growth of beech or tulip. One locality, because of its special characteristics, may cause a single species to form a vigorous and healthy wood. The tree may be absent from a nearby locality because the soil, moisture, and other site factors are different. Under one set of conditions a species may be the ruling one, while under another set of conditions it may become dependent. Some species are always dependent, being found only in mixture with others whose presence so influences local conditions that the growth and maturity of the dependent species are possible.

In New England, spruce, hemlock, beech, and chestnut are often ruling species, while white ash, white elm, tulip, and birch are usually dependent. In the southern states, loblolly pine, longleaf pine, bald cypress, and red maple are often ruling species, while chestnut, cherry, buckeye, and cottonwood are usually dependent. In the Ohio valley, beech, hard maple, and oak are usually ruling species, while basswood, butternut, coffee tree, black locust, sycamore, and mulberry are dependent. In the Rocky Mountain region, Engelmann spruce, lodgepole pine, and yellow pine are usually ruling species, while oak and other hardwoods are usually dependent. On the Pacific coast, Douglas fir, redwood, hemlock, and white fir are usually ruling species, while incense cedar, black oak, and live oak are usually dependent.

6. THE SITE FACTORS

The site factors which have a more or less direct bearing upon forest vegetation are so numerous and so intimately related and complex that precise methods of study are very difficult. In accordance with their nature they relate to the atmosphere, to the soil, and to plant and animal life.¹

The atmospheric factors which influence forest vegetation are temperature, light, humidity, precipitation, and, to lesser extent, wind, lightning, and atmospheric impurities. The soil factors are water content, soil composition, soil temperature, soil gases, and indirectly altitude, slope, exposure, and surface. The life factors refer to the plants and animals in every environment which react upon the forest vegetation. There is no habitat which escapes the influence of these life factors. The trees in every forest are influenced more or less by the various forms of animal life which come in contact with them and by various parasitic plants. The quality or yield capacity of any site is represented by the combined influence of all the site factors.

Since the results obtained from seeding and planting as expressed in vigor of growth and yield are largely dependent upon the combined effect of these factors, they are of fundamental importance in the selection of species. *No species should be selected for extensive use until the closeness of its correlation with these factors as exhibited in the particular locality is definitely settled by either direct or indirect means.*

7. THE EFFECT OF ATMOSPHERIC FACTORS ON THE CHOICE OF SPECIES

The heat relations of a tree cannot be determined by direct observation. Thus, plants from tropical regions may resemble in form and habit plants from arctic regions. Although we cannot explain the reason, we know from experience that every form of forest vegetation can live only at temperatures between two extremes which are at variable distances apart for each species. When seed is distributed beyond these points, it does not grow and develop so as to form a permanent part of the vegetation. For this reason each species has its northern and southern range

¹ Clements, F. E.: Research methods in ecology. p. 18. Lincoln, Neb., 1905.

with more or less fixed limits as to its extension in either direction.

Species exhibit great variation in their ability to withstand cold. Thus, many tropical species die at several degrees above the freezing point, while many arctic species can safely withstand -76° F.¹ The power of resisting heat also varies with the species. Thus, our arctic species disappear as we proceed southward, and our alpine species as we descend to lower elevations. However, there is no part of the earth's surface so hot that no species of tree will grow if other conditions are favorable.

As regards temperature requirements, it is known that a low temperature during a long growing season is not equivalent to a higher temperature for a shorter duration. The total amount of heat, therefore, during the growing season is not a safe guide to the heat requirements of a species. In general, however, if we know the temperature for the four hottest months of the year in any locality, we are able to form a judgment as to what species from other regions it is possible to introduce in forest practice, provided we have accurate knowledge of the heat requirements of the introduced species.

8. Variation in Heat Requirements within the Species.— There is not only a variation between species in their power to resist excessive heat or cold, but there is also a difference in the individuals of the same species.² Thus, stock grown from hickory and walnut seed collected in southern Missouri or farther south will not survive the climate of Minnesota and New York, while that from the same species collected farther north is perfectly hardy. Stock grown from the seed of Douglas fir collected in California is not hardy in New England, while that from the same species in Colorado is much hardier. Black oak grown from northern seed is perfectly hardy in Connecticut, but seed of this species collected in Oklahoma, when planted at New Haven, produces plants which will not survive the first winter.

It is probable that in these cases natural selection working

¹ Schimper, A. F. W.: *Plant-geography upon a physiological basis*. p. 38. Oxford, 1903. [Translated from the German by W. R. Fisher, and revised by Groom and Balfour.]

² Engler, Arnold: *Einfluss der Provenienz des Samens auf die Eigenschaften der forstlichen Holzgewächse*. (Mitteilungen der schweizerischen Centralanstalt f. d. forstliche Versuchswesen, VIII. Bd., S. 81-236, 1905; u. X. Bd., S. 189-214, 1913.)

through a long period of years has developed within the species a number of races of variable degrees of hardiness. In seeding and planting operations it is important that we recognize this difference of hardiness within the species. *When restocking is undertaken on exposed sites where the climate is severe, we should use seed collected over that portion of the range of the species having the most severe climate.*

As a rule, forest trees should not be seeded or planted in a locality much colder than the habitat where the seed is collected, even if the distribution of the species extends into much colder regions. Experience has demonstrated that transportation from a warmer to a colder habitat is almost always unfavorable. On the other hand, present evidence indicates that most trees thrive when transported to a habitat somewhat warmer than their native home.

Trees in the juvenile stage are much more subject to injury from temperature conditions than older ones. Serious injury is often escaped by underplanting, *i.e.*, by starting the young forest under an old stand. The effect of the larger growth is to render the temperature conditions under it more uniform and, thus, less harmful to the young growth.

Individuals of all species which occur on the outskirts of their geographical range are single or in isolated groups where local temperature conditions are suitable. In the extension of a species northward or to a higher elevation, it occurs only in warm local situations as expressed in southern aspects. In its extension southward or to lower elevations, it occurs only in cold local situations. When seeding or planting at the northern geographical range of a species, or when an exotic species is introduced from a warmer region, warm local situations should be selected as expressed in southern slopes with their drier soil, over which the air is warmer. When done at the southern geographical range or when an exotic species is introduced from a colder region, cold local situations should be selected as expressed in northern slopes with their moister soil, over which the air is cooler.

9. Light in Its Relation to the Choice of Species. — Light is necessary for the life, growth, and development of trees. It is necessary for photosynthesis, chlorophyll formation, and the metabolism of green plants. In general, other factors being equal, the greater the light intensity the more rapid the growth

and development because of the greater assimilation of carbon. With the majority of forest trees, the optimum light intensity at which the leaves function best and at which the production of flowers and fruit is most abundant lies much nearer the maximum amount of light available for the use of the tree than to the minimum light under which it can still exist.¹ The chief reason why the time between blossoming and fruiting in any given species becomes shorter as we proceed north or south from the equator is because of the increase of daylight during the growing season. Although light is essential for tree life, there is no site where light is too attenuated or too intense for the growth and development of trees in the open. *Light becomes an important factor chiefly from the standpoint of the shading influence of one tree upon another when they are grown in stands or because of its influence upon other factors of the site such as heat and moisture.*

10. CONDITIONS UNDER WHICH LIGHT INFLUENCES THE CHOICE OF SPECIES. — Light influences the choice of species for seeding and planting operations when:

a. The species are grown in mixtures.

b. The reproduction takes place under an overwood.

In planting or seeding with a single species, the result of shading is to suppress the weaker trees. The stand at all times remains complete but with fewer trees per acre as it becomes older. In mixed stands, unless good judgment is shown in the selection of the species which form the mixture, the result of shading is to suppress one or more of the species in the mixture to the advantage of the others. When the reproduction takes place under an overwood, careful attention must be given to the density of the overwood and the light requirements of the species used in the regeneration.

11. THE INDIRECT INFLUENCE OF LIGHT UPON THE CHOICE OF SPECIES. —When seeding and planting operations are conducted on open sites, light indirectly affects the regeneration because of the effect of direct sunlight upon the moisture conditions of the surface layers of the soil. Soil exposed to direct sunlight dries out quickly and subjects both seeds and plants to extremes of moisture during the critical period following seeding and planting. Species like oak and hickory having large seeds which in seeding

¹ Zon, R. and Graves, H. S.: Light in relation to tree growth. (U. S. Forest Service, Bul. 92, p. 11. 1911.)

are buried to considerable depth in the soil, usually reproduce well in the open. Birch and aspen, although small-seeded, germinate quickly, grow rapidly, and often reproduce well on open land. Small-seeded species like spruce, fir, and hemlock, which are more or less tardy in germination and grow slowly in the juvenile stage, seldom reproduce well in the open. In general, the greater the proportion of root to shoot surface and the more rapid the depth of root penetration, the more successful is artificial regeneration in the open. Species like white pine, red pine, and tulip often can be safely seeded on soils which retain an excess of moisture in the surface layers, while attempts to regenerate them by seeding in the open on loose, sandy, or shale soils are likely to result in failure due to the effect of direct sunlight in overdrying the surface layers of the soil. Red cedar reproduces remarkably well in the open and on dry, sandy soils. This appears to be due chiefly to the very long, deeply penetrating root which develops quickly after germination and to the small surface exposed to the sun and air.

One of the chief advantages of an overwood in artificial regeneration is the effect of the cover in rendering the surface soil more uniform in soil moisture. Therefore, slow-germinating and slow-growing species and those with a shallow juvenile root-system or a large proportion of shoot to root can usually be more successfully reproduced under an overwood. As soon as the trees are well established and their roots well below the superficial soil layers the overwood is no longer beneficial and, in most cases, is harmful because of its shading effect upon the young stand and the consequent decrease in carbon assimilation.

12. Humidity in Its Relation to the Choice of Species. — All trees require a certain amount of moisture both in the air and in the soil. The air moisture is *humidity*, while the soil moisture is *water content*. Trees are continually subject to the action of both. There is no other factor which is so thoroughly clear in its influence upon tree life as water. We can follow it step by step from its entrance through the root to its exit through the shoot. Although the stimulating effect of humidity is confined chiefly to the shoot and that of water content to the root, they work together in determining growth and, in reality, are two phases of the same stimulus. The various modifications in form and structure due to the degree of absorption cannot be directly referred to

either the moisture of the air or the moisture of the soil but to both. Thus, a dry atmosphere and a relatively abundant absorption may cause the same effect as a moist atmosphere and a relatively small absorption.

Woody species thrive on the western slopes of the coast mountains of southern California because of the frequent fogs and the relatively humid atmosphere. Farther inland, because of the less humid atmosphere, a similar vegetation is possible only when a much larger amount of soil water is available for absorption.

All sites undergo great fluctuations in the relative humidity of the air. Where soil moisture conditions are suitable, however, there is no known region where the air is too dry to sustain forest growth. Thus, in the most arid regions forest trees of one species or another thrive when the soil is supplied with water. But even if the soil is amply supplied with moisture, not all species have the same power for resisting the dry air. Thus, most species with a large transpiration surface, thin cutis, and other hygrophilous structures fail when planted in desert regions even under irrigation. *The roots are unable to supply a transpiration current of sufficient volume to overcome the loss through the foliage.*

We know from observation that different species exhibit a wide range in the humidity conditions under which they thrive. Thus, Douglas fir appears to thrive under a wide range of conditions while the redwood of California is limited in its distribution to the area subject to frequent fogs and consequently with a high relative humidity. Most species appear to do best in a humid or a moderately humid atmosphere.

In seeding and planting operations in arid and semi-arid regions or in regions having a relatively low degree of atmospheric humidity, species which have structures well developed to resist the loss of water through transpiration should be selected. In regions where the amount of soil moisture is very limited, many species can be successfully grown if fogs are frequent and the relative humidity high. On the other hand, an annual precipitation of 20 inches or more will not maintain a forest, except of xerophilous type, in the extremely dry air of Arizona.

13. Precipitation in Its Relation to the Choice of Species. —

The aqueous vapor of the atmosphere is deposited upon the surface of the earth as rain, snow, dew, rime or sleet, hail, and frost. All of these forms of precipitation add to the water con-

tent of the soil and the relative humidity of the air. The fluctuations in water content, in particular, are directly traceable to variations in precipitation. However, aside from the beneficial influences of precipitation in adding to the supply of water available for absorption by forest growth and through its effect on humidity checking the loss from transpiration, *it directly influences the phenomena of woodland growth through its mechanical action on the trees and the soil.*

Regions of scanty rainfall suffer most from the mechanical action of rain on both the vegetation and the soil, because a large part of the annual precipitation occurs during a few storms of large and rapid downpour. East of the Mississippi River the precipitation is fairly evenly distributed throughout the year, and violent storms are the exception rather than the rule. In most parts of the West, however, the opposite is the rule, and attention should be given to overcoming its harmful effects. So far as the direct effect upon the tree itself is concerned this can be done by selecting species having small, thick leaves better adapted for resisting mechanical injury. Emphasis should be placed upon the necessity of maintaining forest growth upon all unprotected soils liable to excessive erosion. Forest growth checks the velocity with which the rain strikes the soil and extends the period of time over which it falls. The wealth of lesser vegetation on the forest floor and the layer of litter, moss and humus hinder the speedy run-off of the water and consequently lessen erosion. In general, forest growth should be removed gradually from steep hillsides and the young growth started some years before all the old timber is taken away.

When forests are started by seeding or planting on naked slopes or on sites subject to excessive erosion, special means must be devised to keep the soil in place and prevent damage by the washing out of seeds and young plants. When seeding is done on unprotected slopes, the seed should be sown along contour lines, never in lines running up and down. When necessary to make seedbeds on sloping ground, the beds should be small and made level by terracing. When planting is done in furrows, they should follow contour lines. It is sometimes advisable to check erosion by a series of parallel ditches which follow contours and are more or less broken to prevent water from flowing in them. These ditches should be from 6 inches to 1 foot in

depth and at intervals of from 15 to 40 feet. They not only serve to check the flow of water but are of great additional use in dry regions because they retain the surface flow and permit it to sink gradually into the soil.

14. THE MECHANICAL EFFECT OF SNOW IN ITS RELATION TO THE CHOICE OF SPECIES. — In most mountain regions the mechanical effect of snow upon the tree itself is far greater than that of rain. The effect upon the soil, however, is much less and strikingly different in that it serves an important function as a soil cover, thus protecting the young growth from adverse climatic conditions and the soil from excessive freezing and drying by winter winds. Thus, on the Laramie plains in Wyoming and on other similar situations in the West, the chief obstacle to the establishment of forests by seeding or planting is the absence of a protective snow blanket in winter. As a result, the great cold and high winds dry the surface soil so completely that young trees are killed outright or more or less severely injured. In northern regions, all species come through the winter in much better condition when the ground is covered with snow than when it is unprotected. Both single trees and forest stands exhibit wide variation in the degree of resistance which they offer to the mechanical effect of snow. The degree of injury depends upon the species, the age of the trees, and the density and character of the canopy. In many regions, particularly if mountainous, this matter must be given careful consideration in the selection of species for seeding and planting.

Snowbreak results when the weight of the snow exceeds the resistance offered by the tree stems and branches. Evergreens offer a much larger surface for the accumulation of snow and are much more subject to injury from this cause than deciduous species, although the latter are by no means entirely immune. Pure forests and those of even age are much less resistant to snow injury than mixed and uneven stands are; consequently, most natural woodlands exhibit less injury than stands established by seeding and planting. The more irregular and varying the level of the canopy, the less the amount of snow held back, and consequently the less the damage. Engler¹ has shown that the damage from

¹ Engler, Arnold: Einfluss der Provenienz des Samens auf die Eigenschaften der forstlichen Holzgewächse. (Mitteilungen der schweizerischen Centralanstalt f. d. forstliche Versuchswesen, X. Bd., S. 189–214. 1913.)

snowbreak to Scotch pine growing at high elevations depends largely upon the origin of the seed. Trees grown from seed collected at low elevations are much more subject to injury than trees grown from seed collected at high elevations.

Sleet or rime, although occurring at infrequent and irregular intervals, often exerts greater mechanical effect upon forest vegetation than snow, although the manner of injury is the same. This injury is most prevalent on north and east slopes in mountainous regions. The degree of injury depends very largely upon the species. Those with slender boles, large crowns, numerous or brittle branches, or abundant winter foliage are most subject to damage. Box elder, gray birch, silver maple, chestnut, and poplar are particularly subject to this manner of injury in New England. Elm, hackberry, hemlock, and hickory are very resistant.

15. Wind in Its Relation to the Choice of Species. — The velocity of the wind in all habitats varies from a perfectly calm condition to that of more or less violent storms. The occasional high winds of all regions cause *windfall* and *windbreak*. This mechanical injury, however, is most common in regions which usually experience a calm atmosphere. Here the forest vegetation does not become adjusted to withstand great wind pressure, consequently occasional severe storms often cause great damage. In regions where the mean velocity of the wind is high, as on islands, along the coast or on exposed mountains, and in most prairie regions, the indigenous species develop special adaptations to resist it. Forest trees are affected much more than the lesser vegetation because of the marked increase in the velocity of the wind with the height above the ground.

The continuous stress occasioned by constant winds results in an increase in the mechanical tissue of the tree where the strains occur, and consequently it is better fitted to resist mechanical injury. Species indigenous to windy regions not only have taken on adaptations which better enable them to resist high winds but are better fitted to survive the marked deviations from the normal shape which they are forced to assume. In such regions, the branches and tree stems are more or less markedly bent away from the normal direction of growth and the twigs and leaves are injured by breaking.

Aside from its direct action, the wind exerts a very important indirect action on tree life, chiefly by increasing transpiration

and by rendering the air in contact with the foliage drier. Winter killing of foliage often results from the desiccating action of high winds during periods when the loss of water cannot be made up by a supply from the soil.

The nature of the deviation from normal growth caused by high winds and the degree of injury depend largely upon the species; therefore, special attention should be given to the wind-resisting qualities of species planted in prairie regions, along sea coasts, on high elevations, and in other exposed places.

On the whole, coniferous species are more resistant to injury by high winds than broadleaved species during the season when the latter are in full foliage because of the smaller surface exposed to the action of the wind. In winter, however, the opposite is true because the exposed surface of all deciduous trees is greatly lessened by the casting of the foliage. As the most violent winds usually occur between the late autumn and the following spring, conifers on an average for the entire year suffer more than broad-leaved species.

16. Minor Atmospheric Factors in Their Relation to the Choice of Species. — In the vicinity of volcanoes and hot sulphur springs, all vegetation suffers to a greater or less extent from the poisonous gases which escape from them. Sulphurous acid gas is the chief factor in causing this injury. Because of the very limited areas over the earth's surface where this manner of injury naturally occurs, it would scarcely warrant its discussion as an atmospheric factor were it not that the same kind of injury occurs where large quantities of coal are burned. Mason¹ states that smelter fumes cause serious damage on the Deerlodge National Forest. It has been estimated by chemists that at least 2500 tons of sulphur dioxide are annually thrown into the atmosphere from the smelters near this forest. Experiments have shown that as little as one part of sulphur dioxide in a million parts of air will kill pine seedlings after prolonged exposure, while 80 parts to a million parts of air are often present ten miles or more from the smelter. The sulphurous acid is absorbed in the gaseous form through the foliage and is oxidized into sulphuric acid and acts as a poison. As different species exhibit varying degrees of resistance to this gas, it should be taken into account when plantations are made

¹ Mason, D. T.: The life history of lodgepole pine in the Rocky Mountains. (U. S. Forest Service, Bul. 154, p. 22. 1915.)

near all kinds of industries that consume large quantities of coal. Coniferous species are most sensitive because of their persistent leaves. The degree of resistance is nearly proportional to the length of time that the leaves remain on the tree. Spruce and fir are very sensitive, pine less so, and larch the least of all conifers. Among broadleaved species oak and chestnut are the least sensitive; maple, ash, and elm more so; and beech, poplar, and cherry very sensitive. The relative humidity of the atmosphere when laden with the gas very materially influences the degree of injury, all species being much more sensitive in damp, foggy weather.

17. THE EFFECT OF SOIL FACTORS ON THE CHOICE OF SPECIES

The soil gives stability and physical support to the tree. It is also the medium through which adequate root expansion is attained and necessary moisture and soil nutrients reach the roots to supply the various vital processes. The more perfectly the soil meets the requirements of the tree for support and nutrients, the more completely will the tree perform its various life processes and the better will be its growth. All trees demand that the soil provide these essentials but in different degrees. A loose, shallow soil endangers the stability of trees. However, species such as oak and hickory with deeply penetrating roots are much more stable than shallow-rooted species like spruce which spread out their roots in the surface soil. Thinnings must be undertaken with due foresight, or the crop left standing will be thrown by the wind. A shallow soil on an impervious subsoil endangers the stability of trees in a similar manner and also restricts root expansion. A compact, heavy soil also restricts root expansion and is particularly harmful in the seedling stage of tree growth. Spring-fed swamps and northern slopes decrease soil temperature and consequently affect growth. Sandy soils and southern slopes usually mean increased soil temperature. Certain species like spruce and hemlock germinate at a much lower temperature than their hardwood associates and are able to start earlier in the spring. When such species grow in mixture with hardwoods, their germination at lower temperature may account for their occupying the cooler sites. It is obvious that if the soil is deficient in water and soil nutrients tree growth cannot exist at all. A coarse,

gravelly and shallow soil with little organic matter and with little or no litter suggests an insufficient supply of these materials.

The soil is the chief controlling factor not only in determining the distribution of trees within their natural range, but also in determining their growth and development. The soil provides both the water and nourishment and, consequently, controls nearly every important physiological process. It is to the quality of the soil that we look for rapidity of growth, length of life, form of bole and crown, and the relative abundance of reproduction. It also influences the quality of the wood and the yield and affects tolerance and the resistance to injury.

18. Water Content in Its Relation to the Choice of Species.

—The amount, distribution and variation of the available water in the soil is perhaps the most important consideration in the selection of species for any particular site. Gay¹ goes as far as to say that the quality of the site for the growth of timber depends solely upon the amount of available moisture. There is, however, great variation in species as to the amount of available water required. Distinction must be made between the physical water content of the soil and the available water, as it is only the latter that can be utilized by the tree. Thus, roots take up much more water from the soil when it is relatively pure than when it is charged with various salts and organic acids. Most species when seeded or planted on alkaline or peat soils, even when the physical water content is high, have difficulty in absorbing sufficient moisture for growth and development due to the effect of the saline or acid condition of the soil water upon osmotic processes (Fig. 10).

19. SITES WITH NON-AVAILABLE MOISTURE. — If we exclude sea beaches, alkaline soils, and peat soils, there are few sites where the soil water is so charged with materials in solution as seriously to interfere with the ready absorption of water by the roots. Coniferous species are particularly sensitive to soils highly charged with saline matter. Many species are more or less resistant to acid soils, as is the case with larch, most of the cedar tribe, and some spruces and pines. Many hardwoods are fairly resistant to saline soils, while, as a whole, they are less resistant to acid

¹ Gay¹, Karl: *Der Waldbau*. 4. Aufl. Berlin, 1898.

soils. The average moisture condition of the soil is not indicative of its capacity for supplying any particular species with moisture, as the requirements vary at different periods of the year. The available moisture at the driest period of the growing season is much more important.



FIG. 10. — Poor form and growth in a plantation of Scotch pine due to acid soil. Adirondack Mountains.

20. OPTIMUM DEVELOPMENT AND AVAILABLE MOISTURE. — Species vary greatly as to the amount of available water necessary for optimum development and in their resistance to a falling off from this amount. In general, a decrease in the amount required for optimum growth and development causes a very rapid falling off in height growth. Surface-rooted species are more sensitive to drought than deep-rooted ones owing to the greater variation in the moisture conditions of the surface soil. White ash, black walnut, tulip, beech, hard maple, and black cherry are very exacting and deteriorate rapidly when planted on sites where the available moisture falls much below that required for optimum growth. On the other hand, red pine, white pine, and hemlock are far less exacting and make acceptable growth when seeded or planted on soils much drier than those required for optimum growth.

21. JUDGING THE AMOUNT OF SOIL MOISTURE. — The best measure of water content is that expressed in the vegetation itself and in the depth of the soil and the fineness of its particles, considered with the amount and distribution of the precipitation. A deep and relatively fine soil contains much more water during periods of drought than shallower and coarser soils of the same locality.

As more or less extended intervals of time separate periods of precipitation, the power of a soil to retain water is of great importance. The rapidity with which the moisture escapes from the surface layers or, conversely stated, the power that a soil has for retaining water in its surface layers, very often determines the species to use in seeding and planting. Shallow-rooted trees like beech and hard maple are chiefly confined to clay and calcareous upland soils. Because of the much less variation in soil moisture in the deeper layers, upland trees that occur on gravelly or sandy soils are usually deep rooted, as is the case with chestnut, white oak, and shagbark hickory. Where shallow soils are underlaid with an open, porous subsoil or with vertically stratified or much fractured rocks, the available moisture often approaches that of deep soils. Oaks, hickories, chestnut, and many conifers thrive on such soils. On the other hand, where shallow soils are underlaid with an impervious subsoil or where the underlying rock is without fractures or in horizontal strata, but few trees make successful growth because the soil is too wet immediately following precipitation and too dry during periods of drought. Such soils, however, often sustain a good crop of spruce and occasionally other conifers in regions of abundant precipitation and high humidity.

22. AVAILABLE MOISTURE IN THE SURFACE SOIL. — The available water in the surface soil is of particular importance in reproduction. After germination starts the roots must be constantly in contact with sufficient moisture to meet the demands of the particular species for transpiration and growth. They must quickly penetrate the soil to a depth beyond that where it becomes dry during periods of drought. As trees vary greatly in the rapidity and depth of root penetration in their early life, the loss from seeding and planting due to the drying of the surface soil is largely dependent upon the species. Species like the oak, chestnut, and hickory, which immediately after germination send their roots to a depth of a foot or more, are easily established by

direct seeding on soils which quickly lose moisture from the surface layers. On the other hand, beech, maple, elm, and red gum are comparatively shallow rooted in early life and cannot be safely seeded on dry or leachy soils in the open. They can be reproduced much more readily under an overwood or on clay soils.

23. The Composition of the Soil in Relation to the Choice of Species. — Although no soil is wholly devoid of any one of the chemical nutrients necessary to support tree life, sometimes some of them are present in such limited quantities or in such large amounts that they do not sustain nutrition and growth. In regions of adequate precipitation, however, conditions which bring about a dearth in mineral nutrients available for tree life usually cause a deficiency in available soil moisture, and it is to the latter rather than to the former that poor growth is attributable.

The demand for mineral nutrients varies somewhat with the species. Hartig has shown that spruce produces much more timber than beech in proportion to the amount of the various mineral constituents absorbed from the soil. Many of our hardwood species, as illustrated in beech, maple, and yellow birch, are particularly rich in ash elements and require a larger amount of mineral nutrients in the soil than most conifers, particularly pine and spruce. The former species should usually be confined to soils rich in mineral nutrients, while most conifers will succeed on soils relatively poor in these materials. Many soils too poor to produce a profitable crop of oak, beech, maple, or other trees which demand a fertile soil can be made to yield a fair return when seeded or planted with less exacting species like white and red pine.

Lime is of great importance in improving the physical condition of most soils. Although not directly essential for the nutrition of the tree, it is endured in small quantities by most species. It is harmful to many species when it appears in considerable quantity in solution in the soil water. Beech and maple thrive on soils rich in lime, while chestnut and many pines, spruces, and firs are excluded or do poorly upon them.

24. HUMUS IN ITS EFFECT UPON THE CHOICE OF SPECIES. — As humus has both a direct and an indirect influence upon forest growth, the relative amount in the soil influences the selection of species. The rapidity of early growth in forests established by seeding or planting is very largely dependent upon the presence of a certain amount of humus. The vigorous growth of young

forests on newly cleared sites is due to the large amount of humus in the surface soil. On soils that have been free of vegetation for some time or that for other reasons are deficient in humus, the less exacting species should be used for the first crop. Later, as the soil increases in fertility, particularly in humus content, a change of species can be made. When humus is present in the surface soil in favorable amount, its stimulating effect upon early growth shortens the period of greatest hazard to which the young trees are subjected. Its presence in favorable amount is absolutely necessary in nursery practice in order to attain economic results.

After a forest has been established, most soils contain sufficient nutrients to grow a crop of trees provided the litter is not removed by fire or other agencies. Although fertile soils often produce good crops of timber even when a part of the litter is removed, its annual removal causes them to deteriorate and in time become too poor for the profitable production of timber.

25. The Physical Condition of the Soil in Relation to the Choice of Species. — Artificial regeneration may fail because of the unfavorable physical condition of the soil. Although all ordinary soils contain the mineral nutrients essential for tree life, growth is not determined by the relative abundance of these nutrients but rather by the amount that the vegetation is able to obtain. This depends very largely upon the structure of the soil from a physical standpoint. The fineness of the soil particles is directly correlated with water capacity, water retention, capillarity, and permeability, all of which are important factors in soil fertility.

**26. SPECIES SELECTED WITH REFERENCE TO THEIR DEMANDS
UPON SOIL FERTILITY**

All trees grow better on a soil that is fertile, deep, porous, fresh or moderately moist, warm, rich in humus and in mineral nutrients. The soil which most nearly meets these conditions is a sandy or a clay loam which contains from 20 to 33 per cent of clay, from 50 to 70 per cent of sand, from 3 to 10 per cent of lime, and from 2 to 5 per cent of organic matter. Within their climatic range nearly all species will do well upon soils of this character. These, however, are our most valuable agricultural soils, and it is usually the case that timber must be confined to poorer or less fertile soils. Although all species prefer a fertile soil, the different

species vary greatly in the minimum of soil fertility under which they can be profitably grown. Among indigenous species useful in artificial regeneration the least exacting are pitch pine, red pine, western yellow pine, jack pine, loblolly pine, paper and gray birch, poplar, and locust. Among the most exacting species are walnut, ash, cherry, tulip, and beech. Among intermediate species are Douglas fir, most spruces, and white pine.

In general, our useful broadleaved species are more exacting than the inferior hardwoods and the conifers. Deviation from the best forest soil toward a shallow, gravelly or sandy soil brings about a dearth in soil moisture and soil nutrients. Deviation toward stiff clays and other fine-textured soils brings about an excess of moisture and imperfect aeration. On the whole, sandy and gravelly soils are best suited to species which develop a deep root system, as illustrated in red cedar, pitch pine, white pine, and upland oaks. Fine-textured soils like heavy clay are best suited for shallow-rooted species such as beech, maple, and cherry.

27. OTHER FACTORS OF THE SITE WHICH INFLUENCE THE CHOICE OF SPECIES

Where the atmospheric and soil factors are favorable, other factors of the site may inhibit the successful growth of a given species. Species differ in their degree of resistance to injury from external causes such as fire, insects, fungi, grazing, and inundation.

28. Fire. — The fire hazard is one of the most important of these factors. At present in most parts of the country it is the greatest risk with which artificial regeneration is attended. Wherever seeding and planting is done every precaution must be taken to minimize this risk. When danger from fire is not under reasonable control seeding and planting should not be attempted. The choice of species is an important factor in reducing the risk. The greatest danger from fire is to be apprehended with coniferous species, particularly with the various species of pine. The least danger usually occurs with dense-foliaged deciduous species in which the bark is thick and the roots are deep in the soil.

29. Insects. — Some species are excluded from use in certain localities due to danger of their total destruction or severe injury by insects. Thus the planting of white pine in pure stand in portions of New England cannot be recommended because of

the danger of severe injury by the white pine weevil. The black locust can seldom be safely planted because of the damage to the wood by the locust borer. In some sections the hickories are so severely damaged by the hickory borer that they cannot be profitably grown for timber.

One species may be practically free from this source of injury in a given locality, while another otherwise well adapted to the site may be severely injured. In the selection of species for artificial regeneration due consideration must be given to the injury which they are likely to meet from this cause. Insect injury is much greater where a species is grown in pure stand; hence, when a species is grown in a region where it is likely to be infested with insects, it should ordinarily be grown in a mixture with other species not subject to this manner of injury. Thus, in New England, white pine can be mixed advantageously with red pine, as the latter species is not subject to injury by the weevil.

30. Fungi. — Severe injury to many species of important trees by parasitic fungi prevents their successful use in artificial regeneration in infested districts. The chestnut, which was the most important commercial hardwood in southern New England, cannot be safely planted at the present time owing to its liability to destruction by the chestnut blight.

31. Grazing. — Usually all grazing should be excluded from newly regenerated areas. Among domestic animals, goats and sheep are the most harmful, and horses the least harmful. Even wild animals do great harm to many species. Deer eat the buds and particularly the leaders of coniferous species during the winter. Squirrels do great damage in spruce plantations by destroying the buds. In general, grazing animals are more harmful to broadleaved species than they are to conifers; although severely injured, broadleaved species usually recover by sprouting while conifers do not. Conifers are usually not eaten by stock where other forage is available; while, on the other hand, most broadleaved species are. Where moderate grazing is continued during the period of regeneration, less damage is likely to occur if pines, spruces, and other coniferous species are used.

32. Lands Subject to Overflow. — Special attention must be given to the selection of species to seed or plant on lands subject to overflow. Upland species should never be planted on such sites, as they are severely injured or killed outright by

long periods of inundation. Even many of the most valuable bottomland species like walnut, catalpa, tulip, beech, and white ash are unable to resist prolonged inundation. Willow, red and black gum, red maple, and other swamp species are much more resistant.

CHAPTER III

THE CHOICE OF SPECIES IN ARTIFICIAL REGENERATION (*Continued*)

1. THE EVALUATION OF THE SITE FACTORS

It is the duty of the forester to determine the trees that are best adapted for growth in any particular locality. As the site factors measure the quality or yield capacity of the locality, methods must be developed by which they can be readily ascertained. The quality of the site must be known in order to avoid growing a species that has no chance of thriving upon it. The task is an extremely difficult one because the effects of some of the factors of the site on tree growth are as yet imperfectly understood. The climatic factors are of special importance; hence, careful consideration should be given to the effect of geographical position, altitude, aspect, gradient, and air currents upon temperature and atmospheric moisture. Special attention should also be given to the soil and subsoil. The soil should be examined in particular as to depth, porosity, moisture, and composition. The methods for determining site quality are as follows:

a. Direct method, *i.e.*, determining site quality or yield capacity by the measurement of the several factors of the site.

b. Indirect method:

1. Determining site quality or yield capacity from the crop of trees.

2. Determining site quality or yield capacity from the herbaceous or shrubby vegetation.

2. The Evaluation of the Site Factors by the Direct Method

In recent years foresters and botanists have given much attention to methods for measuring the site factors and relating the vegetation to them. Thus, Trauseau ¹ has attempted to correlate

¹ Trauseau, E. N.: Climatic factors and centers of plant distribution. (Mich. Acad. Sci., 7th report, pp. 73-75. 1905.)

vegetation with the ratio $\frac{\text{rainfall}}{\text{evaporation}}$. More recently Shreve¹

has used the ratio $\frac{\text{soil moisture}}{\text{evaporation}}$. Livingston² has made use of a

combination of temperature summations and evaporation data.

A detailed examination of all the factors of the site is a very complicated and difficult operation. Moreover, without a broad foundation in ecology the interpretation of the vegetation in terms of the site factors is often difficult, even after the factors are measured. Too much importance is often assigned to one factor and too little to another. Furthermore, the factors in their degree of influence are rarely the same over extensive areas, but often change more or less abruptly at short distances. Therefore, where the site factors have been carefully measured the data cannot safely be applied to other regions.

In the silvical investigations of the future, the direct method for determining the quality of the site is likely to be of far-reaching importance. However, the time and expense involved in the use of instruments and in laboratory analyses are so great and the difficulties experienced in relating the results to the growth and development of the forest are so pronounced that the use of the direct method will be left largely to experienced silviculturists and ecologists connected with experiment stations or other scientific institutions where original research is under way.

The practicing forester must, to a very large extent, depend upon the indirect method for determining the quality of the site for any particular species. *He must arrive at a judgment of site quality very largely from the growth and character of the vegetation upon or near it, the available data relating to the site factors serving as an aid in the application of the indirect method.*

3. The Evaluation of the Site Factors by the Indirect Method

A crop of trees growing under normal conditions upon a given site represents the result of all the site factors working together. Although we do not know to what extent each of the several

¹ Shreve, F.: Rainfall as a determinant of soil moisture. (Plant World, vol. VII, pp. 9-26. 1914.)

² Livingston, B. E.: Climatic areas of the United States as related to plant growth. (Proc. Am. Philos. Soc., vol. LII, pp. 257-275. 1913.)

factors is responsible for the crop, we do know that the crop is a result of their combined effect. When a given site has already produced a crop of trees, it is reasonably safe to assume that under normal conditions all of the site factors have found due expression in its development.¹ It is for this reason that the crop itself is the best indicator of what the site is capable of producing. It is the safest guide for the determination of the quality of the site or its yield capacity. For instance, if an acre of land has produced 30,000 board feet of white pine in 50 years, the annual yield capacity is 600 board feet. If, in another case, an acre of land under similar treatment produces but 20,000 board feet in 50 years, its annual yield capacity is but 400 board feet. The difference in the site factors which combine to form quality of site is expressed in the difference in yield.

In order to determine the quality of the site from the condition of the crop, the history of its development regarding the following should be known:

a. Whether the crop upon which our assessment is based has developed under normal conditions.

b. Whether there has been a change in the site factors during the development of the crop.

c. Whether the age of the crop is sufficient to indicate that the site factors have been fully expressed in its development.

Where the crop has grown under unusual or abnormal conditions that have affected its health or development, such as damage from fire, fungi, insects, grazing, removal of litter, or faulty treatment, it does not express the yield capacity of the site, and allowance must be made for the injuries to which it has been subjected. In some cases the site factors, particularly the soil factors, undergo rather marked changes toward either improvement or deterioration during the development of the crop upon which the assessment is based. Allowances must be made for the change in site factors because the stand itself is no longer indicative of yield capacity. Where the assessment is based upon immature stands, it is necessary to know that the site factors are already fully expressed in the crop. This is necessary because many species make good growth and appear thrifty in their juvenile stage, even on sites unsuited to them, but later fail or fall off in growth and become unsatisfactory. Therefore, in all

¹ Schlich, Wm.: Manual of forestry. vol. II, p. 51. London, 1910.

cases where the history of a stand is known, it is a relatively easy matter to determine the quality of the site. Unfortunately in this country the history of stands is usually imperfectly known, and it is often difficult to determine the extent of injury that they have suffered from fire and other external agencies.

It is often necessary to assess the quality of the site for a particular species without a stand of trees for guidance. This is the case in seeding and planting on abandoned farm lands, extensive areas long denuded of timber, and in prairie regions. The stands of timber on adjacent woodlands are a safe guide in judging the quality of the site of small denuded areas, provided the soil conditions are approximately the same. On extensive areas without timber, such as large burns, the types of vegetation that are present must be relied upon. The particular character of the herbage or shrubs present is indicative of both atmospheric and soil conditions. Thus, certain species of *Atriplex* are indicative of alkaline soils. Ericaceous shrubs indicate acid soils, and cacti and other succulents indicate an arid soil. Thus the lesser forms of vegetation enable us to interpret the site factors and judge the particular species of trees that are most likely to succeed.

In the indirect assessment of the site factors, the quality of the site or yield capacity is ascertained for the species upon which the assessment is based. When we try to relate this to another species, it should be remembered that the climatic and soil conditions which result in a maximum yield for one species may not result in a maximum yield for another. In seeding and planting operations, therefore, when we desire to use a different species from the one upon which our assessment is based *we must know how closely its silvical requirements correspond to those of the species used as a basis for the assessment.*

4. THE CHOICE OF SPECIES IN REFERENCE TO THEIR SUITABILITY FOR THE PARTICULAR OBJECT IN VIEW

Although the first requisite in the choice of species is that those selected are sufficiently correlated with the site factors to grow and develop into an acceptable stand, *they must also be suited to the particular object that the owner has in view when the selection is made.* The various objects that may be entertained in establishing a

forest by artificial regeneration are numerous. They may, however, be placed in the following classes:

- a. The production of wood or other forest products.
- b. The protection which the forest affords.
- c. The seeding or planting for esthetic purposes.

The owner often tries to combine two or more of these objects in the regeneration. This is particularly true on game preserves, the drainage areas from which potable water is obtained, and small forest holdings in densely populated regions. Thus, the owners of game preserves are interested not only in the character of the cover that the species selected for the regeneration is capable of producing but also in the quality and value of the wood or other useful products. Water companies, although chiefly interested in the protective feature of the forest, find it to their advantage to select species that command a high value when grown. Many forest parks and private holdings are managed primarily from the point of view of forest esthetics and only secondarily from that of the value of the product obtained. It is entirely practical, however, to combine wood production, protection and esthetic treatment in handling any forest property.

5. Species Selected Primarily for the Production of Wood or Other Useful Products

Where the highest financial return for wood and other forest products is the primary object, the four following points must be carefully considered in making the selection:

- a. The initial cost of the seeding or planting and the later cost for protection and management.
- b. The value of the thinnings made during the development of the stand.
- c. The time required for the production of the crop.
- d. The value of the crop when mature.

Because of the long time required for forest crops to mature, the initial cost of the regeneration is a matter of large importance. Thus, an increase of \$6 per acre in the cost of the regeneration of a crop that requires 75 years to mature means that with compound interest at 5 per cent it must yield \$232.99 more per acre. Initial cost is not so important a factor with forest crops under short rotation, because interest charges are a less prominent factor in the final result.

The initial cost of the successful artificial regeneration of oak in southern New England is more than twice that of white pine. The expectation value of oak under a 75-year rotation, therefore, must be far above that of white pine in order to justify the artificial regeneration of the former on soil suitable for both species. With species such as catalpa and locust, grown for posts or poles under a rotation of 20 years, an increase of \$6 per acre in the regeneration with compound interest at 5 per cent means that the crop when harvested must yield but \$15.92 more per acre.

Even where the longer rotation will give higher returns from the investment, the owner may desire species that will give the earliest possible returns, *i.e.*, those that can be grown profitably under a short rotation. In cases of this kind species must be selected that:

- a. Make rapid early growth.
- b. Command a good market in small sizes.

In the prairie regions of the Middle West, white willow, cottonwood, and box elder are grown under short rotation for fuel and other purposes, although the wood is soft and of inferior quality. The rapidity of growth and the consequent large volume of wood produced in a comparatively short period often justify the use of these species. Locust and catalpa not only make rapid juvenile growth but also produce wood of high technical quality and command a high price in small sizes.

6. Species Selected Primarily for the Protection which They Afford

Trees that are grown primarily for the protection which they afford should be effective in one or more of the following ways:

- a. In checking the velocity of the wind.
- b. In preventing land slipping on steep slopes.
- c. In preventing soil erosion by both wind and water.
- d. In regulating stream flow.
- e. In improving the soil.

Hemlocks, pines, spruces, and most other conifers are particularly desirable for windbreaks because of their persistent foliage. These are very effective during winter and spring, the seasons of highest wind velocity. Broadleaved species with dense, heavy foliage such as maple and beech are particularly effective in summer. Thin-foliaged species, on the other hand, such as

white ash, locust, and walnut are among those least useful. On steep slopes subject to land slipping, deep-rooted species such as hickories, oaks, and pines are most effective. Shallow-rooted species like spruce and birch should be excluded from such sites. On sites subject to wind or water erosion, species that form a dense cover under which there is a maximum depth of forest litter should be used. The tolerant species, like spruce, maple, and beech are among those most useful.

The principal effect of the forest in the regulation of water supply is due to its influence on the surface run-off. Forest vegetation renders the flow of streams more uniform by diminishing the extremes of high and low water. Its effectiveness depends primarily upon the height and density of the stand and the depth of litter on the forest floor.

7. Species Selected for Their Esthetic Qualities

When the object in establishing a forest by seeding or planting is its pleasing appearance in the landscape, the choice of species is less restricted. It depends upon the personal taste of the owner and the esthetic qualities of the species. The effect produced is governed primarily by the grouping of the species and how well they fit into the general landscape. For instance, the form and foliar effects of species that are effective along water courses are usually inappropriate on high ridges. In most instances, a mixed uneven-aged forest in which the stand is not too dense is more pleasing to the eye and affords greater variety in form, color, and foliage than an even-aged stand of a single species (Fig. 11). In the selection of species for esthetic purposes, therefore, special attention should be given to their form, color, foliage, and grouping. As a rule, the native species should be the basis of all planting for esthetic purposes, as they fit better into the general landscape. Exotic species and indigenous species from more or less remote regions, if adapted to the site, can be used in order to give variety or attain some particular effect.

8. THE SPECIES SELECTED SHOULD BE SUITABLE FOR MANAGEMENT UNDER THE REQUIRED SILVICULTURAL SYSTEM

The choice of species is dependent upon the way that the forest is to be managed silviculturally. All species can be managed as high forest, while only a limited number are useful as coppice

woods. Conifers seldom coppice at all. A few pines and cedars sprout from the stump but are worthless for coppice reproduction. The redwood is the only important indigenous conifer in which the stool shoots are an important factor in reproduction. Even many



FIG. 11.—A mixed uneven-aged stand of hardwoods and conifers. A forest of high esthetic value. Union, Connecticut.

of our more important broadleaved species, such as poplar, birch, tulip, maple, and ash do not yield satisfactory results as coppice. Chestnut and oak sprout freely and are often grown as coppice forests.

Species grown as high forest behave differently in reproduction under the same silvicultural treatment. White pine is well adapted for natural reproduction after clear-cutting, particularly when the openings are small. The same is true of birch and many other wind-disseminated species which grow rapidly in early life. Shade-bearing species like hemlock and maple are not desirable as standards in coppice. Intolerant species like oak, ash, and tulip are much more acceptable. Species which are tender in their juvenile stage should be reproduced under a shelter-wood.

9. THE CHOICE OF SPECIES IN REFERENCE TO THEIR EFFECT ON THE SITE

The effect of forest vegetation on the site is pronounced and far-reaching. Attention should be given to the effect that it has upon the site factors, particularly soil moisture and soil fertility. Species which tend to improve the soil should be selected. Where it is desirable to grow species under which the site deteriorates, they should be mixed with others which have a tendency to improve the site.

10. The Effect of Forest Vegetation on the Climatic Factors

Forest vegetation influences atmospheric temperature to a perceptible degree. The daily extremes are less, the air within the forest being cooler during the day and warmer during the night than in the open. The seasonal variations are also less within the forest, and the mean annual temperature is slightly lower. This effect of forest growth is of importance where tender species are used in artificial regeneration.

There is an increase in the relative humidity of the air within the forest of from 5 to 10 per cent as compared with that in the open. We have no conclusive evidence that forest growth materially influences the amount of precipitation. It is reasonable to suppose, however, that large bodies of timber increase rainfall to some extent because the air is generally cooler in and near the forest. Because of the higher relative humidity of the air within the forest the upper layers of the soil are moister and the loss through evaporation is correspondingly less.

11. The Effect of Forest Vegetation on the Soil Factors

The forest very materially affects the temperature of the soil. Forest soil is warmer in winter and cooler in summer than denuded soil. The cooling effect of the forest on the soil is most marked on hot, southern aspects.

The forest soil has a more uniform degree of moisture in the surface layers and is more open and porous than soil in the open. It permits the moisture to enter more freely and, consequently, a larger proportion of the precipitation is taken up and less escapes

over the surface as run-off. By shading the soil and providing a loose mulch of leaves and other litter, the forest also checks the loss of soil moisture through evaporation. The obstructions offered by the crown cover extend the time over which the precipitation reaches the soil, and the logs and other obstructions on the forest floor check the flow of water over the surface. The result is a larger proportion of the precipitation enters the soil.

Although forest vegetation causes the surface layers of the soil to have a higher and more uniform moisture content, this is not necessarily true of the lower layers. Where the total amount of precipitation falls below a certain minimum, the lower layers of the soil are rendered drier by forest growth because the trees draw the large amount of water used for transpiration and growth from several feet below the surface.

The forest prevents erosion by protecting the soil from the mechanical action of wind and water. This increases the volume of soil at high levels in hilly and mountainous regions and prevents the covering up of fertile land below by silt and other debris from above. The selection of species for use on sites subject to erosion should be restricted to those that are most effective in holding the soil, *i.e.*, to species which produce a dense and uniform crown cover and a maximum amount of forest litter.

12. The Character of the Forest in Reference to its Beneficial Effect on the Site

The degree of effect which forest vegetation has upon the site depends upon the form and structure of the stand and upon the species composing it. Thus, an even-aged stand in which the trees are approximately of the same size affords the greatest protection from the sun. A stand in which all age classes are represented affords maximum protection from the wind.

In order that forest vegetation may react upon the soil to its greatest benefit the stand must provide the following:

- a. A dense and uninterrupted leaf canopy.
- b. A large yield of litter for the production of humus.

Our different species of forest trees provide these two requisites in varying degrees. Most conifers, although sufficiently dense in foliage to provide ample protection, are deficient in yield of leaves. Thus, hemlock sheds but one-twelfth of its foliage yearly and spruce but one-seventh. On the other hand, a large number

of our economic broadleaved species are deficient in density of foliage and do not provide adequate protection from the sun and wind. Thin-foliaged, intolerant species such as poplar, locust and larch are among the least effective in this respect. Dense-foliaged, tolerant species such as beech and hard maple not only approach conifers in their protective features but annually return a large amount of leaves to the soil. Such species, therefore, lead in their capacity for preserving and improving the quality of the site.

13. The Age of the Stand in Reference to the Improvement of the Site

Soon after a stand closes, sufficient protection is afforded to prevent deterioration in the site factors. In time, however, all stands except those composed of dense-foliaged, tolerant species thin out to such an extent that the canopy becomes broken and open. Red spruce, hemlock, Douglas fir, white fir, beech, and hard maple preserve their leaf canopy practically unbroken. These and similar species can be brought to maturity in pure stand without deterioration of the site and usually to its decided improvement.

Thin-foliaged, intolerant species like locust, black cherry, and white ash retain a satisfactory leaf canopy for comparatively few years after the stand closes. Western larch, many species of pine, various hickories, chestnut, and the oaks open up to such an extent in middle life or with advanced age that they are unable to preserve the quality of the site. When grown under a long rotation they should be underplanted with tolerant, dense-foliaged species.

14. OTHER CONSIDERATIONS WHICH AFFECT THE CHOICE OF SPECIES

The selection of species on the basis of the foregoing considerations is further narrowed down by the market requirements for certain kinds and classes of wood and other forest products. A good local demand for a particular kind of wood should always have an important bearing upon the choice of species. Thus, in southern New England the large demand for white pine should favor the use of this species for planting purposes. In the agricultural regions of the Middle West, the large demand for fence

posts should favor the planting of catalpa because of its rapid juvenile growth and the durability of the wood. In the vicinity of towns and cities, where there is a large demand for wood for fuel, species can be profitably grown that would be out of place in inaccessible regions because of the cost of transportation. The question of economic utilization is an important one in its bearing upon the choice of species. Species seeded or planted in the vicinity of a good market or accessible to it at little cost for transportation should be such as permit of complete utilization. The cost of management, the value of the thinnings, and the resistance to decay may be cited as additional factors which may determine the choice of species.

CHAPTER IV

THE PRINCIPLES WHICH DETERMINE SPACING

THE stand resulting from seeding and planting should be sufficiently dense to form a closed canopy in from 6 to 12 years. The time required will vary somewhat, depending upon the species and the quality of the site. The earlier the closing of the canopy, the sooner soil protection is attained and the less the danger of its deterioration. If the stand is too dense, however, the amount of growing space for each tree is reduced, growth and development are retarded, progress in root expansion is checked, and crown development is not adequate for best results. *In arriving at proper spacing, a compromise must be made between early canopy and growing space.*

1. THE DENSITY OF THE STAND FROM DIRECT SEEDING

Regeneration by direct seeding should result in at least twice as many trees per acre two years after the seeding as are acceptable in planting. The chief reasons for this are as follows:

- a. The stand is from 2 to 5 years behind one obtained by planting and, when similarly spaced, the formation of a closed canopy is correspondingly delayed.
- b. Because of the smaller size of the plants, there is usually much greater loss before the trees become fully established.
- c. The stand is much more irregularly spaced; consequently, the average number of trees per acre should be sufficient for adequate density where it is the most open.
- d. The crop is more uneven in growth and development, hence competition among the trees is not so keen.

When market conditions will justify early and frequent thinnings, *the reproduction from direct seeding can scarcely be too dense.* The early closing of the canopy gives soil protection, and the taking out of the inferior and surplus trees at the proper time provides growing space for those that remain. The best results with beech and oak abroad are attained in direct seeding which

gives 50,000 seedlings or more per acre.¹ When Scotch pine is sown in prepared strips, Prussian practice requires a germination of 10,000 to 15,000 per acre. Tolerant species, as a rule, should develop in much closer stands than intolerant ones, hence they require more seedlings per acre at the start. Where early thinnings cannot be profitably made, as is usually the case in the United States, there is no material advantage in extremely close spacing. If the seedlings are of uniform size, there is very decided disadvantage because the competition tends to dwarf all alike. Although in the United States a more open spacing is usually acceptable in stands arising from direct seeding than in European practice, the author believes that *we are in grave danger from accepting too sparse stands arising in this manner as acceptable reproduction.*

2. The Species as a Determining Factor in the Closeness of the Stand from Direct Seeding

The mode of growth of a species is an important factor in determining how close the young trees should stand in the regeneration. Because of the length of time required to form a complete canopy, species of rapid juvenile growth can be much wider spaced than slow-growing ones. Spruce will develop in good form under a more open reproduction than most species of pine. Close spacing is needed with species that have a spreading crown form, as in oak, beech, and maple.

The young seedlings of forest trees are more or less subject to injury by animals, insects, fungi, and the effects of climate such as frost, drought and excessive moisture. The ability of a species to resist these various forms of injury is also a factor in determining the density of the stand.

3. The Quality of the Site as a Determining Factor in the Closeness of the Stand from Direct Seeding

As the quality of the site influences the growth and vigor of the young plants and the percentage of failures after germination, it is a determining factor in density. When the growth is likely to be slow and the percentage of loss large, the young seedlings should stand closer than when the same species are used for re-

¹ Hauch, L. A.: Buchen- und Eichenkulturen in Bregentved, Dänemark. (Centralblatt f. d. gesamte Forstwesen, S. 149-164 u. 205-222. 1913.)

stocking better sites. During early life the demands of the seedling on the soil are primarily for adequate moisture and heat. If these are present in suitable degree, any soil can nourish a full stand of seedlings.

It is not possible to state the exact number of seedlings that should result from direct seeding in order to attain the best results. All general rules must be modified by variations in climate, soil, species, and the purpose of regeneration. The more thorough the preparation of the soil, the more perfect its physical condition. The young seedlings suffer less loss and grow more rapidly, hence the required number is less than on unprepared sites. In broadcast seeding on unprepared sites the maximum number of seedlings per acre is required. On the other hand, in partial seeding where the strips or seed spots are thoroughly cultivated, success is often attained with a much lower germination per acre because the soil is free from competing vegetation and in better physical condition.

4. Density of the Stand from Direct Seeding in the United States

Germination counts made a few months after seeding are not indicative of success or failure in the regeneration. The sensitiveness of young seedlings to unfavorable weather conditions and to injury from animal and plant parasites is so great that a reasonably full germination may result in but few plants surviving the first few years. On the other hand, a comparatively sparse germination may be followed by favorable weather conditions and practically all of the plants may escape injury from adverse site conditions.

For the most part, attempts at artificial regeneration by direct seeding in the United States have resulted in failure or too sparse reproduction for acceptable stands. We have failed to appreciate the necessity in most species for the germination of a large number of seeds per acre. In pine, spruce and oak it should seldom fall below from 8000 to 12,000 for acceptable results. When a germination of from 1000 to 5000 plants has been accepted as successful so many have later disappeared due to adverse weather, unfavorable soil conditions, animal life, and plant parasites that the remaining stand has been too irregular and too open for successful reproduction. The sparseness of the reproduction attained under the methods prac-

ticed has led many foresters to consider a stand of from 300 to 600 plants per acre 2 or 3 years after seeding an acceptable stand. The author believes that disappointments will arise from this practice and that the employment of more intensive methods and more seed per acre will result in fewer failures and assure much denser stands than those attained under present practice.

5. THE DENSITY OF THE STAND FROM PLANTING

In general, the principle which applies to the most acceptable density of reproduction in direct seeding also applies to spacing in the formation of plantations, *i.e.*, the canopy should close within a period of from 6 to 12 years. This can be attained by planting with a much smaller number of plants per acre than it can by direct seeding.

Spacing varies from less than 4 square feet of growing space for each plant to 64 square feet or even more. Even in countries where forestry has been long established, there is still much controversy regarding the best spacing distance for different species on different sites. Mayr¹ states that the better the soil and the warmer the climate, the further apart the trees should be spaced. Failures result from wide spacing on poor soils and in cold regions. Close spacing is recommended on steep declivities and on dry sites where the trees tend to develop crooked stems. Moderately close spacing is recommended for such species as oak and larch that require crowding in order to develop straight stems. On the other hand, white pine, Douglas fir, and most species of spruce and fir form a good shaft under wide variations in spacing. Change in soil quality and in the character of the vegetation on the ground often necessitates a change in spacing.

The more important factors which have a direct bearing upon spacing in planting operations are:

- a. The size of the stock. Large plants should be wider spaced than small ones.
- b. The character of the stock. Transplants should be wider spaced than seedlings.
- c. The site. The plants should be wider spaced on good sites than on adverse sites.²

¹ Mayr, Heinrich: *Waldbau auf naturgesetzlicher Grundlage*. Berlin, 1909.

² Plantations in semiarid regions where the available soil moisture is only sufficient to sustain a wide-spaced stand are an exception to this rule.

d. The species. The spacing should vary with the degree of hardiness, tendency to branch, and rate of height growth. Tender species should be closely spaced, while species that grow rapidly in their juvenile stage, particularly in height growth, should be planted much farther apart than slow-growing species. The various species of *Eucalyptus* grow with remarkable rapidity in their juvenile stage, often making 10 feet in height in a single season, hence 64 square feet or more of growing space is usually given each tree. Oak, on the other hand, because of its slow height growth in the juvenile stage and its tendency to produce strong side branches, succeeds best when close planted, *i.e.*, with not more than from 9 to 16 square feet of growing space for each plant.

e. The absence or presence of vegetation. The greater the danger that the plantation will be overrun with weeds, the closer the planting should be. Wide spacing is permissible under an overwood because of its beneficial effect when not too dense.

f. The object of the plantation. The various objects for which a plantation is made affect the spacing, whether it is for the production of wood, for protection, or for other purposes.

g. Accessibility. Close spacing is usually justifiable on accessible sites. Earlier thinnings are possible because the cost of both harvesting and marketing the product is less than on inaccessible ones.

h. The condition of the market. Where small material can be marketed at a profit or at least at the cost of its removal, close planting usually has many advantages. Where there is no market for early thinnings or where they can be removed only at considerable expense, wide spacing is more profitable.

6. Close Spacing and Early Thinnings

Where thinnings are made as soon as the stand begins to suffer from overcrowding, *close planting is always the best so far as the development of the crop is concerned.* There are a greater number of trees on the ground from which the crop trees can be selected. The development of side branches is less and the trees grow straighter and taller in proportion to their diameter. As the side branches are smaller, self-pruning is earlier and better. Plantations in which from 4 to 9 square feet of growing space are given to each plant can be formed into ideal stands when no consideration is given to the expense involved in the formation of the

plantation and in making the necessary early thinnings (Fig. 12). Forest planting, however, is seldom justified unless a reasonable profit can be shown. In the United States where the value of



FIG. 12.— A 40-year-old plantation of Norway spruce spaced 4 by 4 feet in which about two-thirds of the trees have been removed in the thinnings. Near Tharandt, Saxony.

forest land is very low, the cost of labor high, and there is but little market for early thinnings, *spacing should be as wide as possible without seriously interfering with the development of the stand due to soil deterioration and excess of side light.*

7. Wide Spacing and Delayed Thinnings

When economic conditions prevent the making of early thinnings, close planting can be made only at large financial loss. The initial cost of establishing a plantation, at a spacing of 4 by 4 feet, is more than double that where the spacing is 6 by 6 feet. Competition is longer delayed in the wide-spaced plantation and the crop trees are not so seriously dwarfed or otherwise injured after the stand closes.

A white pine plantation near Keene, N. H., planted in 1871 (Fig. 13), was studied by the author in 1915. This plantation was spaced at 8-foot intervals and has never been thinned. The

trees are in excellent form and only about 10 per cent of them have become suppressed. The stand now measures approximately 30,000 board feet per acre and is superior to unthinned stands of the same age planted at closer intervals.



FIG. 13. — An unthinned white pine plantation 44 years old and spaced 8 by 8 feet. Near Keene, New Hampshire.

8. Spacing in Forest Plantations in the United States

Although much depends upon the species and the site, we are seldom justified in the United States in a closer spacing than 4 by 4 feet. Only with oak and other hardwoods that develop heavy side branches is as close spacing as this warranted. As a rule, when early thinnings cannot be made each tree should be given a growing space of from 36 to 64 square feet. A spacing of 6 by 6 feet is the most acceptable for most species and under most conditions. When large stock is used, when the species are of very rapid height growth, or when the stand is grown under a short rotation, a wider spacing is often justifiable. In most of the planting on the National Forests the spacing is from 6 to 9 feet in each direction. The contention is that where thinnings cannot be made even a wider spacing will give as much timber at the end of the rotation as would result from closer spacing unaided by early thinnings.

If the spacing does not exceed 10 by 10 feet, the stand will usually produce as much timber at maturity as a closely spaced unthinned stand. Close spacing causes the trees to clear more satisfactorily and permits the selection of the straightest and best for the final stand, as the poorer trees are taken out in the thinnings. Consequently the timber is of better quality.

In nearly all of the plantations made in New England and in the Central and Lake States in recent years the spacing has been approximately 6 by 6 feet. *As a rule, plantations set at closer intervals have suffered from stagnation or overcrowding due to the lack of early thinnings.* Wider spacing has seldom been practiced in eastern United States but is chiefly confined to the western forests where because of economic restrictions early thinnings cannot be made and where vast areas await artificial regeneration.

9. Spacing in European Practice

In European practice the closeness of spacing has been largely governed by the possibility of profitably utilizing early thinnings. Although much difference of opinion exists, until recent years there has been a marked tendency toward close spacing. The contention was made that wide spacing with the consequent delayed closing of the crown cover encouraged the growth of weeds and grass and caused a general impoverishment of the soil. It was generally believed that the yield per unit of area was greatest with close spacing. Thus many plantations were set with from 4800 to 7200 plants per acre or at intervals of from $2\frac{1}{2}$ to $3\frac{1}{2}$ feet. A spacing wider than 4 feet was seldom practiced except in the more inaccessible regions. In recent years the tendency throughout Europe has been toward much wider spacing. Thus in Saxony, which is a land of spruce experts, the spacing of spruce now calls for from 1800 to 2400 plants per acre. A long series of carefully conducted experiments with spruce at the Austrian forest experiment station at Mariabrunn, Austria, appears to show that under average conditions a spacing of 4.9 feet each way gives the best results with this species.

Nearly all recent investigations demonstrate that the expense involved in the greater cost of close planting, in the necessity for early thinnings, and in the decreased growth in the crop trees is not justified. It appears that a wider spacing gives a greater profit in the long run and that the resistance of the stand

to most external dangers is much greater. The strongest argument in favor of wide spacing is the lower cost and less necessity for early thinnings.

Recent researches by Guttenberg in Austria, Kunze in Saxony, and Jolyet in France have emphasized the advantages of much wider spacing than that formerly practiced. Thus Guttenberg recommends a spacing of approximately 6 feet for pine and spruce on the best soils, with a closer spacing on poorer soils or under adverse conditions. Jolyet considers a spacing closer than 6 feet undesirable. Although the present tendencies in Europe are toward wider spacing the best practice remains conservative, preferring to remedy possible crowding by early thinnings rather than run the risk of irreparable damage from soil deterioration.¹ Mayr² calls attention to the possible danger of the pendulum swinging too far in the other direction from the extremely close planting of the latter part of the last century. Most European planting is still well under a spacing of 6 feet. Although a wider spacing is occasionally seen in alpine regions, it is the exception rather than the rule.

¹ Reuss, Hermann: *Die forstliche Bestandesgründung*. S. 190. Berlin, 1907.

² Mayr, Heinrich: *Waldbau auf naturgesetzlicher Grundlage*. Berlin, 1909.

CHAPTER V

THE PRINCIPLES WHICH GOVERN THE COMPOSITION OF THE STAND

1. PURE WOODS COMPARED WITH MIXED

THE virgin forest is nearly always mixed in composition. Only tolerant species mature in pure stands. Pure stands are most frequent in alpine regions and in other localities where the climate is cold. Even the most tolerant species seldom grow in pure stands in tropical regions. Existing pure stands are largely the result of tolerant species driving out those that make greater demands on light, or else they are artificial stands produced primarily for financial reasons.¹

In artificial regeneration a decision must be made between the development of a pure or a mixed crop for each particular site. In making this decision, Mayr² emphasizes the importance of the following:

a. A knowledge of the climatic and soil factors of the site in order to judge whether all the species will grow equally well.

b. A knowledge of the habit and growth characteristics of the species in order to know whether they can be brought to economic maturity best in pure stands or in mixed stands.

Species differ greatly in their requirements for growth and development. They differ greatly in height, diameter, and volume growth. Some grow slowly, while others grow with great rapidity. They exhibit great variation in tolerance and longevity. Because of these and other differences some species can be brought to maturity in pure stands, while others form successful stands only when mixed with other species.

The tendency, both in the United States and abroad, is to re-

¹ Nisbet, John: On mixed forests and their advantages over pure forests. p. 4. London, 1893.

² Mayr, Heinrich: Waldbau auf naturgesetzlicher Grundlage. S. 431. Berlin, 1909.

place the original mixed stands with single species, when the regeneration is attained by direct seeding or planting. This is particularly true of white pine, red pine, western yellow pine, Engelmann spruce, and Douglas fir in the United States, and Scotch pine and Norway spruce in Europe. The ease with which pure stands can be artificially established, their uniform and rapid juvenile growth, and their early promise of yielding large financial returns on the investment are important reasons for their formation. One of the reasons why pure artificial stands are the rule rather than the exception is that mixed crops make higher demands on the forester, as it is much more difficult and troublesome to give proper attention and care to each of several species in a mixed crop than to look after one species only.¹

In recent years, following the leadership of Gayer, there has been a strong reaction in Europe against establishing pure forests by seeding and planting. Even such tolerant conifers as spruce are grown more and more with from 10 to 15 per cent of hardwoods.²

The present practice of wide spacing in the United States, the non-filling of blanks, and seeding and planting on unprepared sites naturally result in a large amount of volunteer growth in the regeneration. When not overabundant and of acceptable species, this growth should be encouraged as it may correct the disadvantages of a pure crop.

2. PURE CROPS IN ARTIFICIAL REPRODUCTION

In general, species that are dense-foliaged and that form and preserve a complete leaf canopy to an advanced age may be grown in pure stand because the density of the canopy is the chief factor in preserving the quality of the site. Beech, maple, spruce, fir, and similar dense-foliaged species are the best to grow in pure stands because of their shading effect on the forest floor. Oak, chestnut, and pine, although much less tolerant, are often grown in pure stand because of their high commercial value. Attempts should not be made to bring artificial stands of ash, cherry, walnut, tulip, and other dependent trees to maturity in pure stands.

¹ Gayer, Karl: Der Waldbau. 4. Aufl., S. 223. Berlin, 1898.

² Ibid.: Der gemischte Wald. S. 9. Berlin, 1886.

3. Dependent Species in Pure Stands

Although most tolerant species may be grown as pure crops, dependent species should be grown in pure stands only under the following conditions:¹

a. Under short rotation for special purposes, *i.e.*, when the intention is to harvest the crop before the leaf canopy has opened up excessively. This is illustrated in growing catalpa and black locust for fence posts under a rotation of from 12 to 25 years.

b. Where the rotation is for a long period with the expectation of underplanting when the canopy becomes too open properly to conserve the quality of the site. This is illustrated in larch, white oak, black cherry, walnut, and a great variety of other species which 20 to 35 years after planting open up too much to sustain an adequate layer of forest litter and humus.

c. On sites where the soil is sufficiently deep and fertile to maintain good growth, even with imperfect cover and want of humus. This is illustrated in successful pure stands of walnut on the deep, fertile bottomlands of eastern Nebraska and Kansas where the water level is but 8 or 10 feet below the surface.

d. In some instances, we may be justified in growing dependent species in pure stand where the particular site is suitable only for a dependent species or where it is the only species that finds a ready market or can be used for a special purpose.

4. The Disadvantages of Pure Stands

Although much depends upon the particular conditions of the site, the species and the economic considerations, the most important disadvantages that result from seeding or planting for pure crops are as follows:

a. As a rule, pure crops do not maintain or improve the fertility of the soil, this being particularly true of thin-foliaged species.

b. Pure crops, as a rule, increase the danger from fire, wind, insects, fungi and other external agents.

c. Pure crops do not occupy the site so completely as is the case with mixed crops and, consequently, the total wood product is usually less.

¹ Heyer, Carl: Der Waldbau oder die Forstproduktzucht. 5. Aufl. I. Bd., S. 87. Leipzig, 1906.

5. The Advantages of Pure Stands

Although, silviculturally considered, pure crops are usually undesirable, there are often economic advantages which overbalance silvicultural defects. The most important of these advantages are as follows:

a. The management is very much simplified, and the thinning operations require much less skill.

b. When properly spaced, natural pruning is more uniform than in mixed crops.

c. The crop can be harvested more economically and only the species grown which command the best market.

d. The restocking is simpler, usually less expensive, and the resulting stand is usually more complete.

Because of the advantages herein enumerated, particularly the much less experience required to bring pure crops to maturity, seeding and planting in pure stands is usually encouraged in the United States. Imperfect knowledge of the silvical characteristics of our native trees mitigates against seeding or planting in mixtures, because the advantages that result from suitable mixtures are so often unattainable. The wrong species for the mixtures are often selected and early thinnings cannot be made. Under present conditions, therefore, it is usually safer to seed and plant all but the dependent species in pure stands. Even with dependent species, only in exceptional instances should more than two species be used in the mixture. Furthermore, it is usually much safer to seed or plant dependent species like larch, oak, walnut, cherry, tulip, and ash in pure stands with the expectation of underplanting with a tolerant species when the soil begins to deteriorate than it is to run the danger of using wrong species in the mixture.

6. MIXED CROPS IN ARTIFICIAL REPRODUCTION

Under suitable management all species can be grown in mixed crops. Acceptable mixtures, however, should form and preserve a complete canopy and properly conserve the soil. Thin-foliaged trees should usually be mixed with dense-foliaged ones.

In the formation of mixed woods by seeding or planting, we may plan to have the mixture by single trees, by lines, or by groups. When the mixture is by single trees the trees of one spe-

cies alternate with the trees of other species. On the other hand, when the mixture is by groups, a number of trees of one species forming a group alternate with groups of the other species. In this case, each of the groups partake, to a greater or less extent, of the character of a pure wood. The groups may be of definite size and form or irregular in size and form to conform with irregularities in the site.

We may plan for the mixture to be permanent or only temporary in character. We may also plan for all the species to be sown or planted at the same time so as to result in an even-aged stand, or at different times so as to result in an uneven-aged stand.

7. Rules for the Formation of Mixed Crops

Gayer¹ has formulated the silvicultural principles involved in the formation of mixed crops as follows:

a. The particular conditions of soil and situation must be such as are favorable to the normal development of all species of trees intended to be grown in mixtures.

b. The mixture of species must not be such as ultimately endangers the productive capacity of the soil.

c. Each species must find the requisite amount of growing space. It must have the light, air, and warmth suited to its requirements throughout the entire period of rotation.

Heyer² gives the following rules for the formation of mixed stands:

a. The ruling species must be capable of improving the soil.

b. Tolerant species may be grown in mixture with each other when the rate of growth is approximately the same or when the slower-growing species is protected against the more rapidly growing ones by planting or seeding it earlier, by having it form a large percentage of the crop, or by lopping, topping, or otherwise holding back the more rapidly growing species.

c. Tolerant species may be intermixed with intolerant (thin-foliaged) species when the latter are of more rapid growth in height or when they are started earlier in the mixture. If, however, the tolerant species make more rapid height growth, they must be the ruling species numerically.

¹ Gayer, Karl: *Der Waldbau*. 4. Aufl., S. 223. Berlin, 1898.

² Heyer, Carl: *Der Waldbau oder die Forstproduktenzucht*. 5. Aufl. I. Bd., S. 37-54. Leipzig, 1906.

d. Intolerant species should not, as a rule, be seeded or planted in mixture. It is sometimes advisable, however, to grow intolerant trees in mixture on very good soil when there is no danger from soil deterioration.

e. Intolerant species should be introduced into tolerant species individually and not in patches or groups except under special conditions such as great variability in the soil, more rapid height growth in the tolerant species, and when standards are retained for the second rotation.

8. Advantages from Mixed Regeneration when Correctly Made

Although more difficult to attain, advantages result from mixed crops when composed of suitable species in the proper proportion. The more important of these advantages are as follows:

a. Where the mixture is suitably arranged the site is more completely utilized, which results in an increased production of wood.

b. Shallow-rooted species when mixed with deep-rooted ones produce stands which suffer less from high winds than is the case where a single shallow-rooted species is used.

c. Tender species suffer less from frost, snow, and excessive drought when grown in mixture with more hardy species.

d. Usually fungi and insects are less harmful in stands composed of two or more species because the damage is usually confined chiefly to but one of the species in the mixture.

e. The fire danger is usually much greater in a stand composed of a single species, particularly if it be a conifer. The danger is much less if the conifer is mixed with broadleaved species.

f. Mixed crops can be grown on sites too poor for pure stands, particularly where the species forming the pure stand is an exacting one. In the mixed stand, the different species draw upon different depths of soil and make different demands upon the site.

g. In cases where the early thinnings of a species in pure stand are of little value, more valuable thinnings may be realized by mixing with it one or more species which realize better prices in small sizes.

h. When serious mistakes have been made in artificial restocking through poor judgment in the selection of species, they

are more easily corrected where there is a mixture of species because the least suitable species can be removed in the earlier thinnings.

i. When the resulting stand must be considered from an esthetic point of view, mixed restocking is desirable because of its increased beauty.

9. Even-aged Mixtures

Even-aged mixtures are of great variety. In general, however, they may be reduced to three:

- a.* Sporadic, *i.e.*, by single trees.
- b.* Lines, *i.e.*, by alternate rows.
- c.* Groups, *i.e.*, by clusters of trees.

Mixing by single trees requires the greatest judgment in the selection of the species for the mixture. In general, the height growth and reciprocal pruning effect must be similar if all species are to do equally well. In practice, such mixtures are seldom successful due to the great difficulty in selecting species which behave in a similar manner in these two respects. *The use of an equal number of all the species uniformly distributed cannot be too strongly condemned for even-aged mixtures.* However, the introduction sporadically of a limited number of trees of a valuable species, such as tulip or ash, with the matrix species can often be done to advantage. The dependent trees should not be closer than at intervals of 20 or 30 feet. The species which forms the bulk of the crop as a rule must not exceed the dependent species in height growth, and, furthermore, it should be capable of pruning the dependent species. The greater value of the dependent species will usually more than compensate in money value for the less satisfactory growth of the ruling species. It should be clearly appreciated that the greater the number of species in the mixture, the greater is the uncertainty of the ultimate result on any particular site. The fact should also be emphasized that a mixture that may prove valuable for one site may be a failure on another. The forming of complex even-aged mixtures should be avoided.

Mixing by lines is usually but little better than mixing by single trees due to the same objections. The planting of mixtures by alternate rows, where it is expected that each will form a part of the ultimate stand, is condemned. It is far safer to plant each species in strips of three rows or more as each strip par-

takes more or less of the group character. In this manner of planting, where the principal crop tree is a tender species, it may be advisable to plant three or four rows of the tender species and then a row of the more hardy one, whose chief function is to protect and assist in the development of the former.

In most instances the formation of even-aged mixtures should be by groups, care being taken, however, that the groups are not sufficiently large to partake of the characteristics of small patches of pure woods. Mixing by groups is most closely related to the method of natural reproduction in mixed stands. In such stands, as a rule, as a tree dies or is removed a single species is dominant in seeding the open spot. In cases where several species start, one of them soon becomes dominant and crowds out the others, so that natural reproduction is usually more or less in the form of small patches of single species.

Seeding or planting in groups is the safest method of forming an even-aged mixture and the only one in which the varying character of the site can be utilized to the fullest extent. The size of the groups should vary with the site and the species. The larger the groups, however, the more nearly the mixture partakes of the characteristics of a pure wood. It is usually desirable that the groups be more or less variable in size and form as it makes possible a better utilization of the site.

The permanent preservation of an even-aged mixture in suitable proportion becomes more difficult as the species differ in tolerance, height growth, suitability for the site, and the shape of the trees. Mixtures of tolerant species, such as sugar maple and beech, sugar maple and spruce, beech and hemlock, maple and white pine, are usually acceptable. Mixtures of tolerant with intolerant species permit of great variety when suitable species are selected.

10. Uneven-aged Mixtures

When the maximum number of intolerant trees, such as larch, white oak, walnut, tulip, cherry, or ash, is desired they should be grown in uneven-aged mixtures, in the form of an overwood with tolerant species beneath. As a rule, but two age classes should be represented, the older being the intolerant species which should be seeded or planted some years in advance of the tolerant species. The time between the regeneration of the two

age classes depends largely upon the species and the site. Thus European larch and sugar maple form an excellent uneven-aged mixture in southern New England. The regeneration is started as pure larch, and the maple is brought in from 20 to 30 years later or when the stand becomes too broken to maintain an acceptable soil cover. Oak and hemlock, oak and sugar maple



FIG. 14. — An overwood of oak with an underwood of beech. Germany.

or beech, walnut and sugar maple, ash and beech are often found growing together under natural conditions and should form excellent uneven-aged mixed stands in artificial reproduction when the intolerant species are regenerated some years in advance of the tolerant ones. Oak and beech are frequently grown in uneven-aged mixtures in Europe (Fig. 14).

11. Special Considerations which may Determine the Species in the Mixture

In some instances market considerations and the relative freedom of certain species from external sources of injury may overbalance silvicultural considerations and determine the best species for the mixture. An even-aged mixture of white and red

pine is acceptable over most parts of the natural range of both species. These two species naturally grow together, and when planted in mixture the plantation suffers less from weevil damage than when white pine is planted pure.

12. Temporary Mixtures

In some instances it is more advantageous for the mixture to be temporary, all but one species being removed before the maturity of the crop. Such mixtures are useful in the following cases:

a. When the rapid growth and high value of one or more of the species make it economically advantageous to remove them as thinnings, letting the remaining species form the final crop.

b. When the original cost of the seeding or planting can be materially reduced by the use of so-called fillers, *i.e.*, inexpensive species which serve to occupy a portion of the area, but which are removed in the early thinnings.

c. Where a nurse must be provided to protect a tender species during its early life.

13. THE USE OF FILLERS

The only reason for the use of fillers in planting operations is the relative cheapness of the stock. In the use of fillers the expectation is that they will be suppressed and crowded out by the crop trees, taken out in the early thinnings, or form a second story under the crop trees. Even when the expense is somewhat reduced the use of fillers is seldom justifiable. Certainly the use of hardwoods as fillers in planting white pine should be discouraged.

14. THE USE OF NURSE TREES

Much discussion has been given to the use of nurse trees in seeding and planting in this country. In most instances where nurse trees have been used the resulting stand has not been improved, but in many cases, due to their rapid growth, shade-producing qualities, or their abundance in the stand, the crop trees have been dwarfed, suppressed or killed by them. Gray and paper birch, aspen and similar light-foliaged species, which make rapid juvenile growth but which do not attain large size, are the most acceptable as nurse trees.

Very often we can take advantage of a natural nurse in seeding and planting. *It is imperative, however, that it be not too dense, or the crop trees beneath it will go to pieces.* Tolerant species can withstand a denser nurse than intolerant.

The nurse, as a rule, should be established a number of years in advance of the tender species. It should be hardy, fast-growing, and with open foliage, and should be removed when the crop trees are no longer benefited by it.

SEEDING AND PLANTING

PART II. THE ARTIFICIAL FORMATION OF WOODS

THE ARTIFICIAL FORMATION OF WOODS

CHAPTER VI

GENERAL CONSIDERATIONS

THE previous chapters of this book deal chiefly with the silvical principles which govern field operations in seeding and planting. Part II is descriptive of the operations themselves and the results that may be expected from the best practice. These operations relate to:

- a. Forest tree seed and seed collecting.
- b. The protection of seeding and planting sites.
- c. Preliminary treatment of seeding and planting sites.
- d. Direct seeding.
- e. Nursery practice.
- f. Planting.

No single form of reproduction is adapted to all conditions. This is emphasized by Reuss¹ in his recent work on the methods of regenerating stands. Experience has already shown that the regeneration of western yellow pine by direct seeding is preferable to planting in portions of the Black Hills and the northern Rocky Mountain region, while regeneration by planting is more advantageous in the more western and southern portions of its range. The choice in the method of regeneration is very largely an economic one. *The sole criterion that should determine between natural and artificial regeneration and between seeding and planting is economy and simplicity in the reproduction of the crop without deterioration of the soil.* In one locality, a species can be regenerated most advantageously by direct seeding; in another, by planting. In some localities, a species can be regenerated in a simpler manner and at less cost by natural means than by either seeding or planting.

The factors which determine *economy and simplicity* in the re-

¹ Reuss, Hermann: Die forstliche Bestandesgründung. Berlin, 1907.

production are numerous and vary to a greater or less extent in each locality. Furthermore, the various operations by which both natural and artificial reproduction have been attained in the past cannot be followed blindly but must be modified and shaped to fit the conditions surrounding each particular case. *Because certain empirical operations have resulted in successful regeneration at one time and under a particular set of conditions, it does not follow that similarly conducted operations will be uniformly successful when carried out at other times and under other conditions.* No description of methods used in regeneration should be followed blindly. At most they are only suggestions. The forester must adapt the method of regeneration and conduct his operations to fit best his own particular needs and attain the object in view in the simplest manner and at the least cost.

Sieber¹ warns against the assumption that any one method of reproduction is the best method. The fact that many methods are recommended by foresters, all with good reason, argues the excellency of each under special conditions and when properly applied. Each practitioner must reserve the right of choice and of working out the one best suited to his particular conditions and that can be handled most successfully by him.

Regeneration attained at a low cost but resulting in a fragmentary or incomplete stand must be counted as a failure and is more to be avoided than regeneration attained at higher cost but which is successful. The tendency in the United States has been toward the employment of inexpensive methods; as a result, the percentage of failures has been excessive, so much so that the average cost of regeneration based upon the total area that has been seeded and planted is inordinately high. Foresters in this country must give up the idea of inexpensive methods of artificial regeneration on adverse sites. Greeley² states:

“The experience of the past ten years on the National Forests clearly shows that it would have been preferable to develop successful methods and learn their limitations on the most favorable sites before attacking lands where forests were never produced by nature.”

¹ Sieber, P.: Über Fichtenvorverjüngung mittels Unterpflanzung. (Forstw. Centralblatt, S. 631-640. 1909.)

² Greeley, W. B.: Reforestation on the national forests. (Proc. Soc. Am. For., vol. VIII, p. 261. 1913.)

1. THE CHOICE BETWEEN NATURAL AND ARTIFICIAL REGENERATION

In deciding between natural and artificial regeneration the practitioner must depend upon the circumstances surrounding each case. Only a careful consideration of all the local conditions will determine which method is preferable. On open sites where a change of species is necessary and where the soil conditions are unfavorable to natural regeneration, no choice can be made. On the other hand, where trees are already on or adjacent to the area to be regenerated a choice between the two methods can be made.

Throughout Europe natural restocking was the main method of reproduction until the beginning of the 19th century. Artificial methods were employed only to repair failed places or to seed or plant waste places.¹ Seeding and planting in the United States have been confined chiefly to the forestation of non-timbered areas such as idle farm lands, extensive burns, natural grass lands and other sites where there was no possibility of reproduction from natural seeding. We have as yet scarcely begun the filling in of failed places in natural regeneration by seeding and planting.

With the introduction of more intensive forestry methods in Europe during the last century artificial regeneration was resorted to more and more, and efforts to attain natural regeneration were often neglected. At first artificial regeneration was attained almost entirely by direct seeding, using large quantities of seed on unprepared soil. The uncertain results led to planting, at first wild stock from the woods and later stock grown in nurseries. Cotta, Heyer, and Hartig all used wild stock. Pfeil was the first advocate of growing coniferous stock in large forest nurseries, dispensing with natural reproduction and artificially reproducing the stand by planting.

It is interesting to note that during the past decade direct seeding on unprepared soil has been extensively practiced in the United States, much less seed per acre being sown, however, than in the former practice in Europe. The results have been equally disastrous. Greeley² states:

¹ Fernow, B. E.: History of forestry. p. 106. Toronto, 1911.

² Greeley, W. B.: Reforestation on the national forests. (Proc. Soc. Am. For., vol. VIII, p. 266. 1913.)

“The results of past work have been so conclusive that direct seeding without some form of rough cultivation is now practically abandoned on the National Forests.”

The unfavorable results from direct seeding on unprepared soil have led to a rapid increase in artificial regeneration by planting. Whether we shall ultimately come to clear-cutting mature stands followed by artificial regeneration, as is extensively practiced in Europe today,¹ remains for the future to determine. It is reasonably certain that large areas of culled hardwood stands will be changed ultimately to pine and other conifers by clear-cutting followed by seeding or planting.

Through the efforts of the Gayer² and Burckhardt³ school of silviculture, there is now in Europe a strong reaction from clear-cutting followed by artificial regeneration and the number of practitioners that advocate natural regeneration in mixed stands under a long rotation is constantly increasing. More attention is being given to the management of forests to make natural regeneration possible.

On sites that permit a choice between natural and artificial regeneration, the following three points should be carefully considered:

- a. The cost of each method of developing an acceptable stand.
- b. The time required to complete the stand by each method.
- c. The differences in the character of the stand attained by each method.

2. The Cost of Natural Regeneration as Compared with Artificial

The generally accepted idea that natural regeneration is far less expensive than either seeding or planting is not always borne out in practice. Natural regeneration requires that the final cuttings be so arranged that at least a portion of the trees remain on or adjacent to the area to be regenerated until the new crop is established. When the new crop is attained by seeding or planting, the old stand can be removed in a single cutting. In natural regeneration it may be necessary to remove the old stand

¹ Mayr, Heinrich: *Waldbau auf naturgesetzlicher Grundlage*. p. 361. Berlin, 1909.

² Gayer, Karl: *Der Waldbau*. Berlin, 1898.

³ Burckhardt, Albert: *Säen und Pflanzen*. Trier, 1893.

in not less than three cuttings at intervals of from 5 to 10 years. In other cases the old stand may be gradually opened up by selection cuttings. Again, the entire stand may be removed with the exception of certain isolated trees or groups of trees that are left to supply seed, or clear-cuttings may be made in narrow strips or in groups. All of these methods involve considerable expense in marking the timber for removal and for inspection. The cost of lumbering is greatly enhanced when the stand is removed in two or more cuttings separated by intervals of several years, also when the entire forest is gone over at frequent intervals and only a small number of trees removed in each cutting.

Economic lumbering in this country is based upon extensive operations where all the timber that can be taken out at a profit is removed at one time. As a rule, nothing is left that will pay the cost of removal. Without the organization of the forest and the construction of adequate and well-made roads, frequent cuttings over the same tract are usually impossible from an economic standpoint. We are attempting to meet this difficulty by cutting down to a fixed diameter limit or under a crude selection system that aims to take out from one-third to two-thirds of the total stand, leaving only the youngest and soundest trees. From 20 to 50 years later another cutting can be made. In the meantime, a new stand is established under that portion of the old stand left after the first cutting. This method of cutting has been practiced in some of the pine and spruce forests in New England and in some of the yellow pine forests in the West. It may be a very inexpensive or a very expensive method of regeneration, depending upon the value of the stand left after the first cutting and whether it will appreciate or depreciate in value. If its value rapidly increases through increase in the value of stumpage or through increased growth and improvement in quality, the regeneration may cost little or nothing. On the other hand, if there is a large loss through windfall, a falling off in growth, or a deterioration in quality due to the excessive opening up of the stand causing decay, insect depredations, or shakiness in the timber, the actual cost of the regeneration may be very high, far more than that necessary either to seed or to plant.

Even in cases where the area is clear-cut with the exception of isolated seed trees, the stumpage value of the trees left in some cases may exceed in value the cost of seeding or planting. This

is true of some of the virgin forests of Washington and Oregon where seed trees, when left, are practically a total loss, since they cannot be harvested economically after the regeneration has been attained and are not likely to remain sound until the end of the second rotation.

The cost of artificial regeneration varies between wide limits. Successful stands have been attained at a cost of \$4 per acre, while sometimes they have cost \$50 or even more. The average cost in the United States is between \$8 and \$15 per acre. In our overmature stands, the seed trees left standing may be worth more than the cost of artificial regeneration.

3. The Time Required for Natural as Compared with Artificial Regeneration

In artificial regeneration the new crop is started shortly before or immediately after the removal of the old stand. The trees are all started at the same time, and it is only in cases where blanks occur in the first seeding or planting that a second or third year is required to complete the regeneration. On the other hand, in natural regeneration it is seldom that a single year will suffice to attain a full stand. It is only under exceptional conditions that it is attained in less than 10 years, and sometimes it is 20 or even 40 years. When the period of natural regeneration is 20 years or less, the resulting stand is usually considered and handled as an even-aged stand.

4. Variation in the Character of the Stand Arising from Natural as Compared with Artificial Regeneration

In recent years, there has been much controversy in Europe regarding the effect of artificial regeneration, particularly planting, in reducing the vitality of the stand when handled under a long rotation. It is generally acknowledged that the artificial stand as compared with the natural is more quickly established and more uniform in distribution and in the size of the individual trees. The growth during early life is also more rapid. It appears, however, that it is more sensitive to external harmful influences and that the trees begin to fail or fall off in increment at an earlier age than in stands that have arisen from natural seeding. The contention is made that in the artificially established forest the trees are usually of the same age and in pure

stand and that, as a result, growth is not so well maintained as where the trees differ more or less in age and are not composed of a single species, as is the case in most forests that arise from natural seeding. It is also believed by many that a tree growing on the site where the seed germinates develops a better and more natural root system. Where natural regeneration is possible the trend of present-day forestry in Europe is away from pure stands and artificial regeneration toward mixed stands and natural seeding. Throughout Prussia beech is being brought back into Scotch pine stands. In Saxony where spruce has been planted in pure stands for successive generations, a change is now being made toward natural regeneration and mixed stands. It is believed by many that the repetition of the same species, rotation after rotation, ultimately exhausts the soil.

5. ADVANTAGES AND DISADVANTAGES IN ARTIFICIAL REGENERATION

The following are the most important advantages and disadvantages in artificial regeneration:

a. Artificial regeneration is independent of the local occurrence of seed years, since seed may be brought in from outside regions or stored from the excess crops of previous years. A previously determined area can be regenerated each year, while in natural regeneration this is not possible because of the intermittent nature of seed years. This is a decided advantage as it affects the equalization of the yield, the handling of labor, and the management of operations.

b. Artificial regeneration enables the forester to develop a simpler and more definite plan for the management of the forest.

c. Artificial regeneration, particularly on open land, exposes the young plants to greater danger from frost, drought, fire, weeds, and insects. This danger is so great with tender species that the regeneration must be made under a shelterwood.

d. The clear-cutting of large areas prior to artificial regeneration exposes the soil to adverse climatic conditions which may seriously affect its fertility.

e. In artificial regeneration, particularly planting, there is usually a smaller number of plants per acre than in natural seeding. As a consequence, the trees are likely to be more branchy except where the planting is very dense.

6. CHOICE BETWEEN DIRECT SEEDING AND PLANTING

Direct seeding is the formation of a wood by sowing seed directly on the area to be stocked. Planting is the formation of a wood by setting out wild or nursery-grown plants. Before attempting artificial regeneration, a choice must be made between the two methods.

The history of artificial regeneration shows that direct seeding is the rule and planting the exception in the early development of forestry in every country. Direct seeding finally gives way to planting. This, in turn, has often been carried to excess. At the present time, foresters generally concede that the particular circumstances of each case should determine the form of artificial reproduction to practice. Planting is generally conceded to be the quickest, safest and easiest known method of restocking.¹ Its economic application, however, must always be a determining factor in its employment. In favorable localities with excellent soil conditions and with acceptable species, direct seeding is usually less expensive. Under the following conditions, however, planting is much more certain and, on the whole, less expensive than direct seeding:

a. On swampy lands, unprotected areas, sites overgrown with weeds or grass, and open, heath-covered places.

b. Under an open stand of intolerant trees where the soil is liable to become quickly overgrown with herbaceous and shrubby growth.

c. On unstable soil such as shifting sand and water-eroded places; also on lands subject to inundation.

d. On lands superficially hardened; on thin, exposed soils; and on light, sandy soils.

e. On lands in mountainous regions subject to slipping under the action of weather and water.

f. In the repairing of failed places in both natural and artificial regeneration.

Frömbling² believes that in Europe the advantages of planting and the disadvantages of seeding have been overstated. He believes that dense sowings have a great advantage over plantings, because in the former case competition for space results in

¹ Mayr, Heinrich: *Waldbau auf naturgesetzlicher Grundlage*. S. 388. Berlin, 1909.

² Frömbling, F. W.: *Saat oder pflanzung?* (Forstw. Centralblatt, S. 253-271. 1910.)

the suppression of the poor individuals. When the young stand is crowded the death of numerous individuals results in a welcome exclusion of the weak. As no planting compares in density with a successful stand from seeding, the latter is more fully composed of hardy and vigorous individuals due to the weaker being crowded out. The following principles are set forth by him in reference to seeding and planting:

a. Only a dense position in early life enables a stand, no matter of what species, to produce the best results.

b. Since in planting the spacing must always be wider than in seeding, the latter is preferable in principle.

c. Special conditions often make planting necessary. If they do not, direct seeding or natural regeneration should be employed.

Direct seeding is better adapted for the reforestation of recently cut-over and burned areas than for afforestation. It is never practicable on sites having a dense ground cover. It is often used on very rocky ground where planting is difficult. In Saxony the direct seeding of Scotch pine and Norway spruce is seldom practiced. In Prussia Scotch pine is often regenerated by direct seeding, some foresters advocating direct seeding and others planting even on the same quality of sites and under similar conditions. In Scandinavia where more than one-fourth of the total artificial regeneration is by direct seeding, coniferous forests are re-established by this method at less cost than by planting. It is generally favored by private foresters because of its comparatively low cost, although there is more or less danger of failed places, of irregular height growth, and the overcrowding of seedlings (Fig. 15).

Little direct seeding was done in the United States before the beginning of the present century. Prior to this time white pine and some hardwoods had been sown in New England and a few other eastern states. At the close of the last century Lukens and others undertook direct seeding in an effort to transform the chaparral-covered areas of southern California into coniferous stands. This was followed by extensive sowings on the National Forests, until in June, 1913, a total of 65,740 acres, including the reseeding,¹ had been sown. Western yellow pine has been used most extensively in this work, sowings having been made in nearly all parts of its range. Douglas fir has been next in importance.

¹ Greeley, W. B.: Reforestation on the national forests. (Proc. Soc. A n. For., vol. VIII, p. 264. 1913.)

both in the Rocky Mountain region and on the Pacific coast. Lodgepole pine has been sown extensively throughout the central and northern Rocky Mountain region. To a lesser extent sugar pine has been sown in California, western white pine in Idaho, and



Photograph by S. T. Dana

FIG. 15. — Reforestation by direct seeding in spots after a clear-cutting. Sweden.

red pine in Michigan. There has been but little regeneration by direct seeding in eastern and southern United States. Walnut, red oak, and a few other hardwoods have been regenerated by direct seeding in eastern United States, but only in restricted localities and in limited amount.

The present low average cost of direct seeding on the National Forests, including cost of seed, rodent poisoning, and the preparation of the ground, *viz.*, \$4 per acre, has resulted in a high percentage of total failures and too few plants per acre on sites where failures are not recorded. The present unfavorable results from direct seeding emphasize the necessity for using the best seed and giving more attention to soil preparation.

The most important considerations upon which the choice between seeding and planting should be based are the following:

- a. The difference in cost.
- b. The difference in the time required for the stand to close.
- c. The difference in the quality of the stand.

7. The Difference in Cost

The initial cost for direct seeding is less than for planting when the seed is obtained at low cost and little or no preliminary treatment of the soil is required. The cost of the seed, however, is usually a large item, and only in exceptional cases is direct seeding successful without considerable outlay for the removal of surface vegetation and the loosening of the soil. For this reason the cost of direct seeding may be far above that incurred in planting. The seed of red pine and jack pine costs in the open market from \$3 to \$4 per pound. The high cost of the seed alone usually prohibits its use in direct seeding. On the other hand, yellow pine and white pine seed can usually be purchased at from one-third to one-fourth as much. As a rule, broadleaved species are more acceptable for direct seeding than conifers.

In a comparison of the results of direct seeding and planting on the National Forests made by Greeley¹ in 1913, he gives an average of 20 per cent of successful reforestation by direct seeding as compared with 75 per cent of successful reforestation by planting. The approximate cost per acre for direct seeding was \$4 and for planting \$10. On this basis, successful restocking by direct seeding costs \$20 per acre and successful restocking by planting \$12.50.

The extremely high percentage of failures from direct seeding in the United States should not condemn the method but rather warn against its use except on sites and under conditions that give reasonable hope of success. It is the frequency of failures that makes the average cost of successful reforestation by direct seeding high in this country. When direct seeding is confined to adequately protected sites where the soil is a good germinating bed, the average cost is usually below that of planting. Greeley says, "Present results indicate that direct seeding should be confined to the best one-third or one-half of the denuded land in the National Forests. How much of this can be reforested by direct seeding at a lower cost than by planting depends chiefly upon the reduction of failures below the average of the present time. To what extent this reduction is possible the future must determine."

¹ Greeley, W. B.: Reforestation on the national forests. (Proc. Soc. Am. For., vol. VIII, p. 275. 1913.)

8. The Difference in Time Required for the Stand to Close

The time required for a stand to close is longer in the case of direct seeding than in planting. Most conifers when planted 6 feet apart close in from 6 to 10 years' time. When the same species are sown direct and there is the same number of trees per acre the resulting stand will not close in a period less than from 10 to 15 years. Because of the more rapid juvenile growth of broadleaved species, the difference in the time required for the reproduction to close is not so marked as in conifers. An advance of from 3 to 5 years in the closing of a stand is of large economic importance and must be taken into account in the choice between direct seeding and planting. On sites that are likely to deteriorate when exposed to the sun and on areas subject to erosion, the length of time required for the reproduction to close may be the deciding factor in making a choice between direct seeding and planting.

9. The Difference in the Quality of the Stand

In direct seeding the trees remain throughout life in the position where they germinate. In planting, on the other hand, the shifting of the trees to their permanent sites is a more or less severe operation and temporarily checks growth even under the best conditions. To what extent the interruption of growth caused by planting affects the later quality of the stand as compared with one arising from direct seeding is not definitely known. It is possible that certain species with deeply penetrating tap roots and few laterals in their early life are permanently injured by planting.

The difference in the early condition of the stand arising from planting as compared with direct seeding is chiefly due to the much greater irregularities in the latter. In planting the trees are all equally spaced and, as a result, the ground from the first is more likely to be fully occupied. Direct seeding seldom results in a stand of uniform density over the entire area. In some places it will be too dense and in others too open. In order to bring it to the uniformity of a planted stand it is usually necessary to incur considerable expense in filling blanks with nursery-grown stock or in shifting some of the young trees from the places where the stand is too dense to the more open spaces. If this is neglected, the stand develops unevenly and the resulting crop is not fully stocked.

10. MIXED REGENERATION

In the formation of forest crops it is often advantageous to combine natural with artificial regeneration. A naturally regenerated stand is sometimes so open in places that it must be completed either by seeding or by planting. Conditions in the different parts of most forests are variable. By shaping the regeneration to fit the conditions, greater success and usually a reduction in cost are assured. The forms of mixed regeneration are as follows:

- a. The combination of natural regeneration from seed and artificial regeneration by seeding.
- b. The combination of natural regeneration from seed and artificial regeneration by planting.
- c. The combination of regeneration from stool shoots or suckers and artificial regeneration by planting.
- d. The combination of regeneration from stool shoots or suckers and artificial regeneration by seeding.
- e. The combination of regeneration from stool shoots and natural seeding and artificial regeneration by seeding or planting.

Failed places from natural regeneration are sometimes filled by direct seeding. This method, however, is permissible only under exceptional conditions. The seeding should be done as soon as the failures are apparent, or soil deterioration and competing vegetation will render it more and more difficult. Where beech, maple or other soil-improving hardwoods are grown with pine or other conifers, the artificial regeneration of the conifers is often combined with the natural regeneration of the hardwoods. In felling stands of spruce and pine that contain a small admixture of beech, it is a common practice in Europe to leave from 4 to 12 beech trees per acre. Later the area is planted or seeded with pine or spruce. The overstanding beech by natural seeding provide from 5 to 20 per cent of the new stand (Fig. 8).

In most instances where natural regeneration is incomplete, it can be completed most economically and satisfactorily by planting. The failures from natural seeding usually occur on the poorest and driest sites where the results of direct seeding are extremely uncertain.

In mixed woods the most desirable species sometimes fail to regenerate by natural seeding, making it necessary to bring them in by artificial means. For one cause or another, the old type of

forest may be of little value and the introduction of other species may be desirable. In instances of this sort, seeding or planting must be resorted to in order to supplement the natural reproduction from seed.¹ It is often discernible at the outset that certain portions of a given area are not suitable for natural regeneration. In such cases they should be artificially restocked at once or during the period that natural restocking from seed is being attained on the remainder of the area. It sometimes happens that during



FIG. 16.— A large opening caused by windfall which made planting necessary in a forest otherwise reproduced by natural regeneration. Near Forbach, Baden.

the progress of natural regeneration under a shelterwood or by seed from scattered seed trees, windfall or other damage occurs which makes it necessary to assist natural regeneration by artificial means (Fig. 16).

¹ The stands of beech in the Sihlwald near Zurich, Switzerland, and in the Wienerwald near Vienna, Austria, are from natural regeneration. Because of the low price of beech and the enhanced value of softwoods at the present time, the natural reproduction of beech is supplemented by planting pine, spruce and other softwoods, usually in groups in the more open places.

When natural regeneration must be assisted by artificial means it is usually desirable that the two proceed together so far as possible. When the natural regeneration is too far in advance of the artificial, small openings can be filled only by using large, strong plants of quick growth, which makes the work unduly expensive.

Only to a limited extent do we find natural regeneration from seed in our coppice woods handled under a 30- to 50-year rotation. As the stools become diseased or are weakened by successive cuttings, the stand is likely to become overthin. It is often advisable to improve it by seeding with oak and other merchantable species. More often, however, better results can be attained by planting large, strong stock of the desired species in the more open spaces between the clumps of stool shoots. The trees which develop may be either held over as standards or cut with the coppice. In the latter case, the stool is vigorous and likely to produce acceptable coppice for several generations.

CHAPTER VII

FOREST TREE SEED AND SEED COLLECTING

1. DEMAND FOR FOREST SEED

THE demand for forest tree seed has rapidly increased with the development of forestry in the United States. Less than a decade ago the seed of the greater number of our forest trees was seldom found in the market and that offered was usually in limited quantity and sold at an inordinately high price. With the rapidly increasing demand of recent years, responsible seed dealers are offering in quantity seed of practically all the species that are likely to be grown in seedling and planting operations.

The forest tree seed industry is, however, as yet so new in this country and there is so much uncertainty on the part of seed collectors and seed dealers as to the demands of the market that prices are very uncertain and, on the whole, very high as compared with those prevailing in Germany and other European countries where the artificial formation of woods is an old and well-established practice. As our market becomes more firmly established and seed collectors and seed dealers are more certain as to future sales and have developed better methods for the collecting and cleaning of seed, prices will become lower and much more uniform.¹

¹ List of dealers in forest tree seed in the United States:

- Thomas Meehan & Sons, Dresher, Pa.
- North-Eastern Forestry Co., Cheshire, Conn.
- Conyers B. Fleu, Jr., Germantown, Pa.
- Otto Katzenstein & Co., Atlanta, Ga.
- J. M. Thorburn & Co., 33 Barclay St., New York City.
- Forest Nursery & Seed Co., McMinnville, Tenn.
- American Forestry Co., So. Framingham, Mass.
- D. Hill Nursery Co., Dundee, Ill.
- F. N. Crayton & Sons, Biltmore, N. C.
- Barteldes Seed Co., Denver, Colo.
- Iowa Seed Co., Des Moines, Ia.

2. SOURCES FROM WHICH SEED MAY BE OBTAINED

Seed for use in direct seeding and nursery practice may be obtained:

- a. From responsible seed dealers.
- b. Direct from seed collectors.
- c. Through personal collection or supervision.

Because of the relatively high cost of forest tree seed in this country and the more or less uncertainty of obtaining it from a collector or dealer, it is often advantageous for the user to collect the seed direct or to arrange for its collection under supervision. This is particularly true if the seed is used in large quantity and the crop can be harvested in the immediate locality. When a large quantity of seed from a more or less remote region is required, it is usually less expensive to procure it direct from a seed collector, arranging with him some months in advance of the maturity of the crop.

3. Ordering Tree Seed from Collector or Dealer

When forest tree seed is ordered from a dealer, or even direct from a collector, it is very important as yet in this country to place the order early, even some weeks before the maturity of the crop. If the order is placed late, *i.e.*, some months after the crop has been gathered, not only is the cost much higher but the certainty of securing the seed is very much diminished because collectors, as a rule, gather only sufficient seed to fill their orders at the time of collecting. As most forest tree seed cannot safely be kept over until the second year without special methods of storage, the seed collected in excess is often a total loss.

4. THE QUALITY OF FOREST SEED

Whatever the source from which forest tree seed is obtained, careful attention should be given to its quality. This is of even greater importance than it is with agricultural seed, because it deteriorates more rapidly with age and has greater variation in weight, size, and other characteristics which determine quality. Although the quality of seed is determined by many factors, the following are of particular importance:

- a. The origin.
- b. The size and weight.
- c. The degree of ripeness and age.

It should be emphasized that a large percentage of the failures, both in nursery practice and direct seeding, is due to poor seed.

5. The Origin of the Seed in Relation to Quality

We do not adequately appreciate the great importance attached to the source from which forest tree seed is obtained. The common practice of collecting seed from trees exhibiting all degrees of inherent defects and from all localities within the tree's range is condemned. Although trees of extreme youth and old age may yield excellent seed, it is uniformly of the highest quality when collected from vigorous trees in middle life. The age of the parent tree is not so important a factor as is *its condition resulting from climate, soil, and inherent defects*. The climate and soil of the region where the seed of a species of wide distribution is collected should not essentially differ from those where the seed is sown. The seed of western yellow pine collected in New Mexico and Arizona should not be used north of Colorado or on the Pacific coast. The seed of Douglas fir from Washington and Oregon should not be sown in the Rocky Mountain region or eastward, although seed of this species collected in Colorado produces hardy seedlings eastward to New England.

For many years there has been a diversity of opinion among foresters regarding the influence of the locality and the characteristics of the mother tree upon the resulting crop. Recent investigations in Europe clearly prove that *variations in the characteristics of the mother tree due to soil and climate may be transmitted through the seed*. To what extent the origin of the seed influences the growth, resistance, and form of forest crops is of vast importance. In order to secure more precise information on this subject many of the forest experiment stations in Europe have given special attention to it during the past two decades. Seed of Scotch pine, Norway spruce, and other species has been secured from mother trees growing under a wide variation of soil and climatic conditions. The characteristics of the mother trees were carefully noted and the seed sown under uniform conditions, in order that variations in the resulting trees due to the origin of the seed might be accurately compared. The trees grown from this seed in Germany, Austria, France, and Switzerland are now sufficiently advanced to permit of definite conclusions on many of the points involved.

From experiments conducted at Mariabrunn, Austria, Cieslar¹ has shown the importance of climatic varieties of forest trees in the practice of silviculture (Fig. 17). The later experiments of Zederbauer² at the same place indicate not only that seed collected from suppressed or subdominant trees produces plants less resistant to disease than seed collected from dominant trees, but also



FIG. 17.—A plantation of Norway spruce 17 years old grown from Austrian seed. The large trees at the left were grown from seed collected at 2500 feet above sea level; the smaller trees at the right were grown from seed collected between 4000 and 5000 feet above sea level. Near Mariabrunn, Austria.

that the individual characteristics of the mother tree, such as unusual divergence from the typical form of the species, may be transmitted through the seed.

From experiments conducted at Eberswalde, Prussia, Dengler³ has recorded marked variations in the rate of growth in Scotch

¹ Cieslar, A.: Die Bedeutung klimatischer Varietäten unserer Holzarten für den Waldbau. (Centralblatt f. d. gesamte Forstwesen, S. 1-19. 1907.)

² Zederbauer, E.: Versuche über individuelle Auslese bei Waldbäumen. (Centralblatt f. d. gesamte Forstwesen, S. 201-212. 1912.)

³ Dengler, L.: Das Wachstum von Kiefern aus einheimischem u. nordischem Saatgut in der Oberförsterei Eberswalde. (Zeitschrift f. Forst- u. Jagdwesen, S. 137-152. 1908.)

pine grown from seed collected near Eberswalde as compared with seed from more northern localities. Kienitz,¹ in experiments near the same place, records great variation in root and shoot growth, depending upon the soil and climatic conditions under which the mother trees developed.

Huffel,² from observations and investigations at Nancy, France, shows that the locality from which the seed of Scotch pine is derived affects to a marked degree the quality of the plants grown. Engler,³ from a long series of experiments and investigations in Switzerland, has shown that Scotch pine seedlings decrease in height growth with increase in the altitude of the site from which the seed is obtained and with increase in the latitude. When grown in Switzerland, 1-year seedlings from Scandinavian and East Russian seed complete their height growth from 1 to 2 months earlier than those from Swiss and German seed from low elevations. On low sites with a mild climate the height growth of the plants from seed collected in different localities begins at approximately the same time. On high sites, however, the plants from seed collected on high mountains and in northern latitudes commenced their height growth earlier than was the case with plants grown from seed obtained from the lowlands of Middle Europe. The terminal growth of plants from seed collected in northern Switzerland and Germany increased with increased temperature considerably more than plants from more northern and from alpine seed. The frequent appearance of top drying on pine in high situations when grown from lowland seed is due to the late closing of growth.

Trees grown from seed of crooked-stemmed, spreading, crippled mother trees are for the most part of poor form. When the poor form of the mother tree is due to weather effect or damage by man or beast, it is not carried over into the next generation through the seed. Poor growth and form, however, due to poor soil and climate is transmitted through the seed.

¹ Kienitz, M.: Formen u. Abarten der gemeinen Kiefer. (Zeitschrift f. Forst- u. Jagdwesen, S. 4-32. 1911.)

² Huffel, G.: Influence de la provenance des graines sur la qualité des plants de pin sylvestre (Revue des Eaux et Forêts, pp. 673-682. 1912.)

³ Engler, A.: Einfluss der Provenienz des Samens auf die Eigenschaften der forstlichen Holzgewächse. (Mitteilungen der schweizerischen Centralanstalt f. d. forstliche Versuchswesen, VIII. Bd., S. 81-89, 1905; u. X. Bd., S. 189-195, 1913.)

From the comprehensive study of Scotch pine and other European species, it appears that *stands having poor growth form due to adverse soil and climatic conditions and to the use of seed from the wrong locality are not suitable for the collection of seed for use in forest practice. For each locality the indigenous spontaneous species are the best sources of seed for use in that locality.*

The germination and early growth of Douglas fir grown from seed collected over various parts of its range have been studied recently by Berg and reported by Zon.¹ The results show marked differences in general appearance, growth and hardiness of the seedlings raised from seed from different sources.

Wide-crowned, short-boled, thrifty trees growing in the open are usually very prolific seed-bearers. As they owe their unsatisfactory form wholly to the light conditions under which they grow and not to inherent characteristics due to climate and soil, seed collected from them is equally as good as that collected from trees of superior quality in commercial stands.

Where a species of a given locality has defects which are transmitted through the seed, while in another locality it is free from them, a change of seed may be desirable. Thus the Jeffrey pine in the mountains of southern California is seriously injured for commercial purposes by spiral fiber in the wood.²

6. The Size and Weight of Seed in Relation to Quality

Within a given species large seed is, as a rule, of higher quality than small seed. In species of wide range, however, as illustrated in western yellow pine, burr oak and red oak, the average size of the seed in one portion of the range may be fully twice as large as in another. In these and similar cases, size alone is not necessarily a measure of quality. When size, however, is not dependent upon range but rather upon local conditions, large seed possesses a greater germinating power and produces more vigorous seed-

¹ Zon, Raphael: Effect of source of seed upon the growth of Douglas fir. (Forestry Quarterly, vol. XI, p. 499. 1913.)

² In 1901 the author collected seed of *Pinus jeffreyi* from trees with spiral fiber in the San Bernardino Mts., California. This seed was sown at New Haven, Conn., and a record of the seedlings kept during the first year. Out of 750 seedlings, spiral fiber developed in approximately 3½ per cent during the first year. A well-marked twist was evident below the cotyledons in a number of the seedlings. This experiment at least suggests that the tendency to spiral fiber may be transmitted through the seed.

lings. When seedlings from large seed are grown in competition with seedlings from small seed, they exhibit greater resistance to external injurious influences, are of more vigorous growth, and are able to crowd out less vigorous seedlings from small seed. The impetus given to seedlings from large seed is not temporary, as they usually form the dominant trees in the stand.

There is considerable variation in all species in the weight of a given volume of seed. This is particularly true of commercial seed, largely due to the variable amount of foreign matter that it contains. The weight, however, is not uniform even when the seed is equally clean and free from impurities. The variation in the weight of clean seed is chiefly due to gathering the seed before maturity and differences in seed-filling, *i.e.*, to shriveled or undeveloped kernels arising from adverse conditions for development.

7. VARIATIONS IN SEED FILLING

By the examination of 100 seeds of a given species we may find 70 of them with plump, well-developed kernels and the remaining 30 with shriveled or otherwise undeveloped kernels. In the latter for one reason or another the embryo failed to develop. The percentage of filled seed under normal conditions depends upon the species, the season and the vigor of the mother trees. Old and overmature trees produce very poorly filled seed. The best filled seed is obtained from middle-aged, normal trees.

Pollination, which in most species takes place in late spring or early summer, is favored by a dry spring and by early summer winds. Under these conditions the pollen is carried more abundantly by both insects and wind, and there is a better filling of the seed. A warm, moderately dry spring also increases the development and deposition of reserve food material in the seed and hastens its ripening. There are, therefore, fewer unripe seeds in the autumn. Unripeness is a large factor in causing the seed to be overweight in weight.

8. THE AVERAGE NUMBER OF SEEDS PER POUND

Not only is there great variation between different species in the size and weight of the seed, but there is also more or less variation within the species.

The differences in the size of seed within the species is due to individual variation, occasioned by differences in the vigor and age

of the tree; the fullness of the crop in different seasons, and differences in site, the trees on good sites producing larger seed than trees on poor sites, and the seeds from one locality averaging larger than those from another. The extreme variation in the size of fertile seed in most species is rarely greater than 1 to 3 and usually is less than 1 to 2.

The author in his studies on the variation in the size of coniferous seed of the same species from widely separated localities has affirmed the conclusions of Rafn,¹ that seed collected at the northern extension of a tree's range is usually smaller, and of Cieslar,² that the seed of a given species from high elevations is considerably smaller than that from the lowlands. The following shows the average size of the seed of three species collected in different states and based upon the number of clean seeds per pound.

| | |
|---|---------|
| Western yellow pine (South Dakota)..... | 13,500 |
| Western yellow pine (California)..... | 8,260 |
| Lodgepole pine (Montana)..... | 109,600 |
| Lodgepole pine (California)..... | 43,960 |
| Western white pine (Northwest Idaho)..... | 19,100 |
| Western white pine (California)..... | 10,250 |

The variation in the size of western yellow pine seed is as follows:

| Date of collection and locality. | Number of seeds per pound. |
|--|----------------------------|
| 1902. | |
| Western yellow pine, Oregon..... | 10,500 |
| 1903. | |
| Western yellow pine, New Mexico..... | 16,000 |
| 1904. | |
| Western yellow pine, New Mexico..... | 18,000 |
| Western yellow pine, South Dakota..... | 13,500 |
| 1905. | |
| Western yellow pine, Nebraska..... | 12,250 |
| 1908. | |
| Western yellow pine, Idaho..... | 8,336 |
| 1909. | |
| Western yellow pine, Idaho..... | 8,300 |

¹ Rafn, Johannes: The testing of forest seeds during 25 years. (Printed by the author for private circulation.) 1915.

² Cieslar, A.: Über die Erbllichkeit des Zuwachsvermögens bei den Waldbäumen. (Centralblatt f. d. gesamte Forstwesen, S. 7-29. 1895.)

The following table by Mason¹ shows the range in size of lodgepole pine seed based upon the number of seeds per pound.

| Date and locality. | Number of seeds per pound. |
|-----------------------------------|----------------------------|
| 1907. | |
| Targhee National Forest..... | 83,000 |
| 1910. | |
| Arapaho National Forest..... | 76,000 |
| Bridger National Forest..... | 96,000 |
| Hayden National Forest..... | 112,000 |
| Holy Cross National Forest..... | 105,000 |
| Bonneville National Forest..... | 105,000 |
| Beartooth National Forest..... | 94,400 |
| Madison National Forest..... | 90,200 |
| 1911. | |
| Arapaho National Forest..... | 110,000 |
| Wyoming National Forest..... | 76,632 |
| 1912. | |
| Arapaho National Forest..... | 95,254 |
| Leadville National Forest..... | 103,900 |
| Medicine Bow National Forest..... | 99,600 |
| Wyoming National Forest..... | 72,000 |

Rafn gives the following as the variations in the size of Norway spruce seed from different localities.

| Locality. | Purity. | Weight in grams of 1000 seeds. |
|-------------------------------|---------|--------------------------------|
| Norwegian northland seed..... | 98 | 4.01 |
| East Norwegian seed..... | 90 | 5.57 |
| Swedish seed..... | 98 | 5.48 |
| German seed..... | 99 | 9.01 |

In the species investigated there appears to be a striking correlation between the size of the seed and the average available moisture in the surface soil at the time of and immediately

¹ Mason, D. T.: The lodgepole pine. Manuscript. 1913.

following germination. The larger size of California seed is due to the need for a larger supply of reserve food in the seed to enable the young seedling to develop rapidly a deep root system.

The size of the seed within the species is so variable that data giving the average number of seeds per pound should not be followed blindly.

Cox¹ gives the following as the approximate number of seeds per pound for a number of economic species:

| Species. | Number of seeds per pound. |
|----------------------------|----------------------------|
| Douglas fir..... | 43,000 |
| Western yellow pine: | |
| Pacific coast..... | 9,100 |
| New Mexico..... | 16,000 |
| Black Hills..... | 13,500 |
| Engelmann spruce..... | 175,000 |
| Sugar pine..... | 2,400 |
| Jeffrey pine..... | 3,100 |
| Lodgepole pine..... | 120,000 |
| Sitka spruce..... | 400,000 |
| Western red cedar..... | 400,000 |
| Western white pine..... | 28,000 |
| White pine (New York)..... | 26,000 |
| Red pine..... | 55,000 |
| Mexican white pine..... | 2,700 |
| Arizona cypress..... | 100,000 |
| Bigtree..... | 75,000 |
| Noble fir..... | 15,400 |
| Grand fir..... | 20,000 |
| Amabilis fir..... | 13,700 |
| California red fir..... | 67,000 |
| Scotch pine..... | 69,000 |
| Austrian pine..... | 24,000 |
| Norway spruce..... | 54,000 |
| Maritime pine..... | 9,450 |

The figures given below are from counts extending over a period of ten years. They were made at the Yale School of Forestry from seed obtained from commercial sources. In all cases the figures represent averages, often of twenty or more lots of seed collected in different localities and at different times. Although it is appreciated that this table cannot be followed blindly, it will

¹ Cox, W. T.: Reforestation on the national forests. (U. S. Forest Service, Bul. 98, p. 24. 1911.)

serve as a useful guide in estimating the necessary amount of seed to collect or purchase for a definite operation in nursery practice or direct seeding.

| Species. | Number of clean seeds per pound. | Species. | Number of clean seeds per pound. |
|--------------------------------|----------------------------------|-------------------------------------|----------------------------------|
| White pine..... | 26,800 | ¹ Shagbark hickory..... | 90 |
| Western white pine..... | 18,750 | ¹ Pignut hickory..... | 210 |
| Sugar pine..... | 2,510 | ¹ Mockernut hickory..... | 113 |
| Red pine..... | 61,420 | ¹ Cherry birch..... | 488,400 |
| Scotch pine..... | 68,400 | ¹ Yellow birch..... | 424,600 |
| Yellow pine: | | ¹ Paper birch..... | 711,680 |
| California..... | 9,340 | ¹ Beech..... | 1,440 |
| South Dakota..... | 12,900 | ¹ Chestnut..... | 162 |
| Arizona..... | 15,680 | ¹ White oak..... | 208 |
| Pitch pine..... | 68,200 | ¹ Swamp white oak..... | 168 |
| Jack pine..... | 108,200 | ¹ Chestnut oak..... | 184 |
| Lodgepole pine..... | 83,000 | ¹ Red oak..... | 128 |
| Loblolly pine..... | 38,160 | ¹ Pin oak..... | 384 |
| Longleaf pine..... | 9,600 | ¹ Scarlet oak..... | 264 |
| European larch..... | 71,400 | ¹ White elm..... | 94,600 |
| Red spruce..... | 131,400 | ¹ Hackberry..... | 2,680 |
| Norway spruce..... | 59,400 | Osage orange..... | 12,140 |
| Sitka spruce..... | 295,400 | Cucumber tree..... | 3,140 |
| Engelmann spruce..... | 178,200 | ¹ Tulip..... | 18,560 |
| Douglas fir..... | 41,260 | ¹ Sycamore..... | 168,400 |
| Hemlock..... | 194,200 | ¹ Sweet gum..... | 176,800 |
| Western hemlock..... | 502,400 | ¹ Black cherry..... | 4,620 |
| Balsam fir..... | 43,800 | Honey locust..... | 2,840 |
| White fir..... | 11,120 | Black locust..... | 26,400 |
| Silver fir..... | 8,260 | ¹ Sugar maple..... | 7,160 |
| Bald cypress..... | 9,240 | ¹ Red maple..... | 18,420 |
| Bigtree..... | 124,000 | ¹ Box elder..... | 12,760 |
| Redwood..... | 162,200 | ¹ Basswood..... | 5,950 |
| Incense cedar..... | 11,480 | ¹ Dogwood..... | 4,180 |
| Arbor-vite..... | 284,300 | ¹ Black gum..... | 2,840 |
| Western red cedar..... | 324,000 | ¹ White ash..... | 6,240 |
| Red cedar..... | 17,640 | ¹ Black ash..... | 2,960 |
| ¹ Black walnut..... | 34 | Catalpa..... | 19,600 |

¹ The whole or a part of the fruit is sown with the contained seed. The count applies to the fruit or the part of the fruit that is usually sown with the seed.

9. THE NUMBER OF POUNDS OF SEED PER BUSHEL OF FRUIT AND THE COST PER POUND

The yield varies with individual trees and the quality of the fruit and also with the completeness of the extraction of the seed. There is, therefore, great variation in the yield of seed per bushel of fruit. The cost of collection is equally variable. As a rule, the greater the quantity collected the lower the cost, and the

better the seed year the larger the yield. Cox¹ gives the following as the average yield in pounds per bushel of the fruits of different species:

| | | | |
|--------------------------|------|---------------------------|-------|
| Douglas fir..... | 1.25 | Western red cedar..... | 0.75 |
| Western yellow pine..... | 1.50 | Black walnut (husked)... | 40.00 |
| Engelmann spruce..... | 0.80 | Butternut (husked)..... | 40.00 |
| Lodgepole pine..... | 0.25 | Shagbark hickory..... | 30.00 |
| Sugar pine..... | 1.60 | Bitternut hickory..... | 40.00 |
| Western larch..... | 0.50 | Pignut hickory..... | 40.00 |
| Sitka spruce..... | 1.25 | Red oak acorns (clean)... | 50.00 |
| Western white pine..... | 1.00 | White oak acorns (clean). | 70.00 |
| Red pine..... | 1.00 | Chestnut (clean)..... | 50.00 |
| White pine..... | 1.10 | | |

The available data are too fragmentary to develop a comprehensive table showing the average yield per bushel of fruit and the average cost per pound for collecting tree seed. The table on page 102, compiled from various sources, shows the results obtained from a number of specific collections of coniferous species, collected in varying amounts at different times.

10. The Degree of Ripeness and the Age of the Seed in Relation to Quality

All seed should be thoroughly ripe before harvesting. Usually for economic reasons the sooner it is gathered after ripening the better. Seed gathered a short time before maturity is not necessarily infertile, although invariably its vitality is impaired and it produces weak and inferior seedlings.² It is, therefore, highly important in the purchase of seed to know whether it was thoroughly mature when gathered.

In some species as in oak, hickory, ash, and maple, the color of the fruit is indicative of ripeness. In other species as in most

¹ Cox, W. T.: Reforestation on the national forests. (U. S. Forest Service, Bul. 98. 1911.)

² In the spring of 1904, the author gathered 100 fruits of the silver maple 7 days before maturity and planted them at once. A week later an equal number of the mature fruits was gathered from the same tree and planted. On the eighth day after planting 79 per cent of the immature seeds germinated, while 92 per cent of the mature seeds germinated on the sixth day after planting. The seedlings from the mature seeds were more robust and made more rapid growth. Two weeks after the mature seeds germinated the seedlings averaged more than twice as large as those from the immature ones.

CLEAN SEED PER BUSHEL OF CONES AND COST PER POUND

| Species. | Year of collection. | Bushels collected. | Locality. | Total no. of pounds of clean seed. | Pounds of clean seed per bushel of cones. | Cost per pound of clean seed. |
|--------------------------|---------------------|--------------------|-----------|------------------------------------|---|-------------------------------|
| White pine..... | 1910 | 4051 | N. Y. | 3905 | 0.964 | \$0.60-0.70 |
| | 1911 | 1330 | N. H. | 1410 | 1.06 | |
| | 1912 | 34 | N. Y. | 38 | 1.11 | |
| Western white pine..... | 1911 | 1383 | Dist. 6 | 695 ¹ | 0.50 | |
| Limber pine..... | 1903 | 3.5 | N. M. | 4.7 | 1.40 | 1.47 |
| Bristle-cone pine..... | 1911 | 30 | Col. | 26.6 | 0.88 | 1.75 |
| Western yellow pine..... | 1902 | 50 | N. M. | 49.1 | 0.99 | 1.59 |
| | 1903 | 1120 | N. M. | 1736 | 1.40 | 0.23 |
| | 1904 | 625 | Neb. | 1260 | 2.10 | 0.23 |
| | 1908 | 1137 | Idaho | 1478 | 1.30 | 1.05 |
| | 1911 | 500 | Col. | 409 | 0.81 | 1.90 |
| Red pine..... | 1910 | 1122.5 | N. Y. | 619.25 | 0.55 | 3.30-5.20 |
| | 1911 | 6 | N. Y. | 3 | 0.50 | |
| | 1912 | 1236 | N. Y. | | | |
| Pitch pine..... | 1910 | 125 | N. Y. | 103 | 0.824 | 1.25 |
| | 1911 | 103 | N. Y. | 90 | 0.87 | |
| | 1912 | 320 | N. Y. | 275 | 0.85 | |
| Jack pine..... | 1902 | 25 | Minn. | 18.25 | 0.72 | |
| | 1905 | 70 | Minn. | 43 | 0.614 | 4.64 |
| | 1912 | 1518.5 | Wis. | 869 | 0.57 | |
| Lodgepole pine..... | 1907 | 609 | Wyo. | 146.2 | 0.24 | 2.39 |
| | 1909 | 119 | Wyo. | 51 | 0.43 | 2.69 |
| | 1911 | 2515 | Col. | 837 | 0.33 | 1.98 |
| | 1911 | 3475 | Wyo. | 1500 | 0.43 | 1.90 |
| Jeffrey pine..... | 1912 | 100 | Cal. | 135 | 1.35 | 0.42 |
| Blue spruce..... | 1902 | 25 | Col. | 37 | 1.48 | 1.08 |
| | 1903 | 7.5 | N. M. | 9 | 1.20 | 0.90 |
| Red spruce..... | 1911 | 11.5 | N. Y. | 12 | 1.04 | |
| Engelmann spruce..... | 1911 | 28 | Wyo. | 15 | 0.53 | 3.88 |
| | 1911 | 177 | Col. | 106 | 0.60 | 0.80 |
| | 1913 | 40 | Utah | 20 | 0.50 | 1.94 |
| Hemlock..... | 1911 | 4.5 | N. Y. | 2 | 0.44 | |
| | 1912 | 57.5 | N. Y. | 109 | 1.89 | |
| Douglas fir..... | 1903 | 69 | N. M. | 87 | 1.30 | 0.73 |
| | 1907 | 247 | Wyo. | 180 | 0.73 | 1.47 |
| | 1908 | 350 | Idaho | 155 | 0.44 | |
| | 1911 | 500 | Wyo. | 472 | 0.94 | 0.83 |
| | 1911 | 292 | Col. | 199 | 0.62 | 1.31 |
| | 1911 | 25,346 | Dist. 6 | 12,600 ¹ | 0.49 | |
| | 1913 | 306 | Idaho | 285 | 0.93 | 0.75 |
| White fir..... | 1903 | 16 | N. M. | 82 | 5.10 | 0.355 |
| Arbor-vitæ..... | 1911 | 24 | N. Y. | 36 | 1.50 | |
| | 1912 | 39 | N. Y. | 59 | 1.43 | |
| Incense cedar..... | 1912 | 29.75 ² | Cal. | 55 | 1.88 | 1.83 |

¹ Estimated in part.² Estimating 1½ bushels to a filled gunny sack.

conifers, the color of the seed indicates ripeness. In the latter case, it is often desirable to begin gathering the fruits while they appear green because, if delayed too long or until they begin to change color, a large part of the seed is lost in the harvesting.

Seed gathered before maturity is light in weight and after storage the kernel becomes more or less shriveled. Past experience in this country indicates that seed collecting is begun too late rather than too early, particularly in the case of coniferous seed, and that there is a large loss caused by the seed dropping from the cones before or during the process of collecting.

Germinative energy is greatest in most seeds shortly after they mature. Some seeds, however, appear to require a more or less extended period of rest before germination will take place. After the usual time for germination passes, the vitality decreases with age. The rate of decrease depends very largely upon the species and the conditions under which the seed is stored. *When possible to obtain fresh seed it should always be used. When it is necessary to use old seed germination tests should be made immediately before the seed is sown.*

11. THE LOSS THROUGH STORAGE

The loss through storage is very largely dependent upon the temperature and moisture conditions under which the seed is stored. From his own experiments, the author believes that, if temperature and moisture are properly regulated,¹ even the most sensitive seed can be kept in dormant condition for many months without serious loss in viability. Under natural conditions, when the requirements for germination are absent, the seeds of poplars, willows, white elm, red maple, and silver maple remain alive but a few weeks after ripening. It is customary to plant the seed of these species immediately after ripening, which in southern New England is usually the first week in June. All species which mature their seed in late spring or early summer should be sown immediately after the seed matures.

¹ The author has succeeded in storing the seed of white elm, red maple, and silver maple for one year. On June 2, 1905, a quantity of the seed of each of these species was gathered at New Haven, Conn., and spread out in the shade until somewhat shrivelled and too dry for germination. On June 10 the seed was placed in a box with alternate layers of dry sand. The box was buried in the soil to a depth of 2 feet under the protection of a building. On April 25, the following spring, the box was removed and the seeds found to be in good condition, many of them having already begun to germinate.

Most seeds of temperate regions mature in the autumn and, as a rule, do not germinate under natural conditions until the following spring or later. Except in the warmer parts of the country fall-maturing seed usually germinates under natural conditions in the spring. Among the trees of New England the most notable exception is the white oak. Because of the difficulty experienced in preventing germination and in safely storing over winter, all seeds which under natural conditions germinate in the autumn should be sown immediately after the seed ripens. Most species which mature their seed in the autumn germinate from April to June the following year, the time depending upon climatic conditions and the species.

Seeds that rapidly lose their viability when stored cannot, as a rule, be held longer than the spring following their maturity. Thus the balsam fir is the only species of *Abies* that retains its viability till the spring of the second year after harvesting.

Were it not for the danger of being destroyed by birds, squirrels and other rodents, autumn seeding would usually be preferable to spring seeding. This danger can be overcome, or at least greatly lessened, by storing the seed over winter and sowing in the spring. The necessity for storing the seed over winter varies with the species. It depends upon:

- a. The probability of the seed being destroyed if not stored.
- b. The probable loss from storage.

A number of both coniferous and broadleaved species that mature their seed in the autumn do not, under natural conditions, germinate the following spring but lie dormant in the ground and germinate 1 or 2 years later. Among coniferous species some of the pines and junipers germinate so slowly that the seed is usually stratified for a year before sowing. The western white pine, the sugar pine, and Coulter's pine are extremely slow to germinate, often not over 10 to 50 per cent germinate after lying in the ground for a period of from 2 to 5 months.

When sown in the autumn, the seed of walnuts, oaks, and hickories is particularly subject to destruction by rodents. In some localities, the seed of pine and other conifers is also injured by them. Birch seed and similar small seed can, with more safety, be sown in the autumn. Although chestnut under natural conditions does not germinate until spring, the author's experience leads

him to believe that autumn seeding with protection from rodents is far more successful than spring seeding because of the difficulty experienced in storing the seed over the winter without excessive loss. The seed of all coniferous species can be safely stored in dried condition over the first winter without serious loss in germinative capacity. With these species, therefore, in order to lessen the danger from birds and rodents, it is best to sow the seed in the spring just before the season for germination arrives. So also many of our broadleaved species, as illustrated in black locust, sweet gum, and catalpa, can be similarly stored. Many of our hardwood species, however, as in walnut, hickory, oak, chestnut, beech, maple, and ash, should not be stored dry even over the first winter. When stored in dry bins at the normal atmospheric temperature and humidity, they suffer from desiccation and completely lose their germinating power; or else, when sown, lie over until the second year. When it is not expedient to sow seeds of this character immediately after gathering, they should be stored under conditions that prevent undue desiccation.

12. VARIATION IN THE KEEPING QUALITIES IN DIFFERENT SPECIES

Many forest trees retain their fruit on the tree without casting the seed for long periods after maturity. The seed of these species can be stored dry, often for a period of several years, without apparent loss in germinative capacity. Thus black locust and catalpa do not cast their seed until late winter or early spring following their maturity. A number of conifers as illustrated in jack pine, lodgepole pine and Monterey pine, often retain their fruit for ten years or more after ripening. The seeds of these species keep remarkably well without loss in viability.

The seeds of different species exhibit a remarkably wide range in keeping qualities. The control of the moisture or temperature conditions under which the seed is stored, or both combined, extends the time over which seed exhibiting varying degrees of sensitiveness to normal conditions can be safely kept. This is well illustrated in white pine seed, which under normal conditions of open, dry storage rapidly loses its viability after the first season, but which can be kept with but little loss in viability in cold storage or when stored in sealed cans or carboys.

13. THE TESTING OF TREE SEED

The external appearance of the seed will determine its genuineness, the degree of purity, and whether it is of normal size and color. The internal appearance will determine the percentage of blind, decayed, moldy, rancid, wormy, and dried-out seed. When the kernel fills the seed coat and is firm, moist, sweet-smelling, of good color, and apparently fresh, the seed is most likely good. The impaired vitality resulting from too long storage or from overdrying or drying at too high a temperature cannot be safely determined by direct examination.

A thorough test to determine the quality of tree seed should include the following:

- a. An examination for purity, *i.e.*, freedom from foreign matter.
- b. An examination for genuineness, *i.e.*, whether true to name.
- c. The determination of viability.

The high cost of most forest tree seed and the expense incurred in nursery practice and direct seeding make it imperative that only good seed be used.

14. The Determination of Purity

The percentage of purity of tree seed is determined by weight. A carefully selected sample, which represents the average of the entire lot of seed to be tested, is weighed. After weighing the sample is spread out on a sheet of white paper and all impurities separated from the seed. The weight of the impurities divided by the weight of the sample gives the percentage of impurities. As yet in this country we have no table of standards of purity for forest tree seed, and there is great variation in the amount of impurities in most species as obtained from dealers. A certain amount of impurities is admissible in all seed. This, however, varies greatly with different species, depending upon the expense involved in separating the seed from such impurities. The purity of all seeds that are easily separated from the fruit and from foreign matter is high, while it is correspondingly low for those that are difficult to separate. The seed of most conifers is easily cleaned and should be practically pure. The seed of some species, however, like the longleaf pine cannot be readily separated from the wings and is relatively impure. Other species, as illustrated in *arbor-vitæ*, have small, light, flat seed which cannot be easily

separated from all fragments of leaves and cone scales. The seed of *Eucalyptus* and birch usually contain a high percentage of impurities.

When the seed has a specific gravity greater than unity the degree of purity can be roughly determined by placing it in a vessel of water. The seeds sink while the impurities float on the surface from which they can be removed and the percentage determined after drying.

15. THE AVERAGE PERCENTAGE OF PURITY IN TREE SEED

From researches conducted at the Swiss seed control station in Zurich, Flury¹ determined the average percentage of purity of certain species to be as follows:

| | Per cent. | | Per cent. |
|------------------|-----------|--------------------|-----------|
| Beech..... | 99 | White pine..... | 92 |
| Stone pine..... | 98 | Douglas fir..... | 89 |
| Black pine..... | 97 | Norway spruce..... | 87 |
| Oak..... | 96 | Larch..... | 85 |
| Silver fir..... | 96 | Alder..... | 70 |
| Scotch pine..... | 93 | Birch..... | 28 |

The table on page 108 gives the average purity of seed purchased in the open market. It is compiled from the author's researches between 1900 and 1910 and the researches of Rafn between 1887 and 1912.

¹ Flury, P.: Untersuchungen über die Entwicklung der Pflanzen in der frühesten Jugendperiode. (Mitteilungen d. schweizerischen Centralanstalt f. d. forstliche Versuchswesen, S. 189-202. 1895.)

PERCENTAGE OF PURITY IN TREE SEED

| Species. | Toumey. | Rafn. |
|------------------------------------|-----------|-----------|
| | Per cent. | Per cent. |
| White pine..... | 94 | 93 |
| Red pine..... | 91 | 97 |
| Western white pine..... | | 97 |
| Sugar pine..... | | 99 |
| Lumber pine..... | | 98 |
| Jack pine..... | 89 | 93 |
| Western yellow pine..... | 97 | 98 |
| Longleaf pine..... | 79 | |
| Coulter pine..... | | 99 |
| Lodgepole pine..... | | 95 |
| White spruce..... | | 97 |
| Engelmann spruce..... | 88 | 94 |
| Red spruce..... | 85 | 84 |
| Sitka spruce..... | 84 | 83 |
| Colorado blue spruce..... | | 94 |
| Black spruce..... | | 85 |
| Eastern hemlock..... | | 90 |
| Western hemlock..... | | 82 |
| White fir..... | 93 | 87 |
| Balsam fir..... | | 75 |
| Douglas fir..... | 91 | 91 |
| Big tree..... | | 85 |
| Redwood..... | 83 | 72 |
| Bald cypress..... | 70 | 84 |
| Incense cedar..... | 86 | |
| Arbor-vitæ..... | 78 | 69 |
| Western red cedar..... | 80 | 72 |
| ¹ Black walnut..... | 99 | |
| ¹ Shagbark hickory..... | 99 | |
| ¹ Cherry birch..... | 34 | |
| ¹ Yellow birch..... | | 41 |
| ¹ River birch..... | | 55 |
| ¹ Paper birch..... | | 52 |
| ¹ Beech..... | 92 | |
| ¹ Red oak..... | 99 | |
| ¹ White oak..... | 96 | |
| ¹ Tulip..... | 78 | |
| Red gum..... | 94 | |
| Black locust..... | 96 | |
| ¹ Red maple..... | 80 | 91 |
| ¹ Sugar maple..... | 91 | 95 |
| ¹ White ash..... | 88 | |
| Hardy catalpa..... | 92 | |

¹ All or part of the fruit is sown with the contained seed. That part usually sown with the seed is not counted as impurities.

16. The Determination of Genuineness

On its receipt from the collector or dealer, forest tree seed should be critically examined and compared with other seed of known species. A hand lens that magnifies eight or ten diameters is necessary in examining small seed. An examination is necessary in order to determine whether the seed is true to name or mixed with other species. Without an accurately labeled collection of tree seed at hand it is difficult for the inexperienced observer to determine the genuineness of many small-seeded species.

Tree seed should be purchased only from responsible collectors and dealers who guarantee its genuineness. In many instances, the external appearance of the seed affords sufficient diagnostic characteristics. The more important of these are size, form, color, and surface irregularities. Where external characteristics will not suffice, the dissection of the seed is necessary. The color and texture of the inner seed coat, the color and consistency of the seed kernel, and the size and form of the embryo aid in identification when the external appearance of the seed will not suffice. As a specific example, from external appearance alone it is often impossible to distinguish the acorns of scarlet oak from those of black oak. The deep yellow color of the seed kernel in the latter, however, will usually distinguish it from the former in which the color is nearly white.

17. The Determination of Viability

The various methods for determining viability, or the percentage of germinable seed under the most favorable conditions, may be considered under the following heads:

- a. The determination of viability by direct inspection.
- b. The determination of viability by physical tests.
- c. The determination of viability by germination tests.

The determination of viability by direct inspection and physical tests is uncertain in results and should be used only in cases where there is not time or opportunity for germination tests. With species like red cedar, hornbeam, and tulip, because of the length of time required for germination, they are the only practical means for judging the viability of the seed.

18. THE DETERMINATION OF VIABILITY BY DIRECT INSPECTION

The method of judging viability by direct inspection is as follows: A sample of 100 or 200 seeds is selected from those to be examined, care being exercised that the sample is an average of the entire lot. Accuracy in the selection of the sample can be attained by thoroughly mixing the seed and placing a quantity of it upon a smooth, flat surface in a cone-shaped pile. The pile is then flattened out in circular form until its thickness is but two to five times the greatest diameter of the seed. It is then divided into quarters and one of the quarters selected and divided by the same method as before. This process is continued until the sample with its impurities is reduced to the approximate number of seed required. The seeds in this sample which represent an average of the entire lot are taken one at a time and carefully examined. A good lens and a sharp knife are essential in making this examination. The viable seeds are among those in which the kernel is firm, plump, and sweet-smelling. The blind, wormy, rancid, moldy, shriveled, and otherwise damaged ones are dead. The estimate of viability is the per cent of the former to the whole number examined.

19. Evidences of Viability from the External Appearance of the Seed. — The examination of the exterior of the seed seldom presents satisfactory evidence of viability. The investigations of Schwappach show that the black seeds of Scotch pine have a higher germination than the lighter colored ones. In coniferous species the outer appearance of the seed coats should be clear and bright. A wrinkled seed coat indicates that the seed is over-dry. A cracked seed coat, so long as the kernel is uninjured, does not necessarily imply loss of viability.

20. Evidences of Viability from the Internal Appearance of the Seed. — As a rule, the interior of the seed is white although there are a number of exceptions. Thus the endosperm and embryo of the seed of most pines are yellow. In the maple the embryo is green. Spots in the endosperm or embryo, abnormal softness, rancidness, and other characteristics which are not constant or characteristic of normal development indicate loss in viability. All seeds in which the kernel has failed to develop are "blind." A withered or hard embryo or endosperm usually indicates over-drying. The endosperm in old seed gradually loses

its characteristic color and appearance of freshness, and the embryo is likely to shrivel and only partially fill the cavity.

It is the common practice to estimate the viability of many seeds by the cutting test alone. This is particularly true of large seed, such as walnut, hickory, oak, chestnut, maple, ash, and those that require a long time to germinate as illustrated in cherry, tulip, hornbeam, and black gum. Large seeds as in oak and hickory are usually buried in damp sand for 30 days before testing. Smaller seeds are soaked in water until the kernel is saturated.

A large percentage of the seed that appears good under ocular examination fails to grow when subjected to germination tests. Experiments with 40 species at the Yale School of Forestry extending over a period of 10 years gave results that averaged much higher than those later obtained from germination tests. With the broadleaved, large-seeded species such as walnut, oak, hickory, maple, and ash, the results from cutting tests compared most favorably with those obtained later by germination tests, but even here they were much too high. *The ocular examination of the seed of coniferous species and small-seeded, broadleaved species gives results that are often 50 per cent higher than those obtained from germination tests.* In some instances this is due to the fact that overdried seeds, those that have been subjected to excessive heat in their removal from the fruit and those that have lost their vitality by long storage, are not detected by direct examination.

The cutting test is useful in supplementing germination tests of coniferous and other small-seeded species. Thus when the germination test is completed, the ungerminated seed should be cut open and a record made of those that are apparently viable but which for one reason or another have failed to germinate during the period allotted to the test.

21. THE DETERMINATION OF VIABILITY BY PHYSICAL TESTS

The moisture content of seed is often indicative of viability. Fresh seed always contains considerable moisture. Overdrying in removing the seed from the fruit or from long storage in a dry atmosphere may reduce the moisture content below that of viable seed. A simple test for moisture content may be made as follows: Place an average sample upon a hot plate or shovel. The moisture within the seed, as it becomes heated, expands causing the seed to puff up and finally explode and spring away. The expan-

sion and final explosion of the seed under the action of heat will not occur when it is overdry. This test is so simple in application that it is often practiced when time will not permit other methods. Seed that has lost its viability through overdrying and later has reabsorbed the lost water behaves in this test like fresh seed.

22. THE DETERMINATION OF VIABILITY BY GERMINATION TESTS

The true viability of seed can be determined only through physiological investigations, namely, by the germination of an average sample. In most European countries, forest tree seed is subjected to standard germination tests before it is placed on the market. The results of these tests are known to the buyer when the seed is purchased and serve as a basis for the sale. For the most part, the tests are made at government seed-control stations, equipped for germinating seed on a large scale under the perfect control of air, heat, light, and moisture. When the test is made but a short time prior to the purchase of the seed, the purchaser has accurate knowledge of the percentage of germination that he may expect.

Forest tree seed is usually sold in the United States without a guarantee of germination. Because of the large financial loss that invariably results from delayed or poor germination, it is particularly important, therefore, that the purchaser subject it to germination tests before sowing. Germination is the chief factor in determining the density of seeding both in nursery practice and in direct seeding.

It is found in practice that it is quite impossible to select from a given lot of seed duplicate samples that are exactly alike. Even were it possible to select uniform samples, they would not give uniform germination values because the conditions under which germination proceeds can seldom be made absolutely uniform. Bates¹ describes a series of tests made at the Fremont Forest Experiment Station with ten samples of western yellow pine seed carefully selected from the same lot. The tests were made in soil and conducted with the usual care. At the end of 25 days the germination scored from 44.2 per cent to 72.4 per cent. The difference in germination was due to the difficulty in securing average samples and uniform conditions for germination. *The utmost care must be exercised in the selection of the samples for testing and*

¹ Bates, C. G.: The technique of seed testing. (Proc. Soc. Am. For., vol. VIII, p. 128. 1913.)

in securing the greatest possible uniformity in the tests. Tests made by one method should not be compared with tests made by other methods, as they are not likely to be uniform.

The United States Forest Service has established uniform germination tests in order to determine the germination values of all seed used on the National Forests.¹ These tests are made at the National Forest Experiment Stations and at Washington.

Germination tests should always be made in duplicate. When the results of the duplicate tests vary 15 per cent or more, they should be repeated. When the tests vary less than 15 per cent, the average of the two should be used in determining germination values. The tests should be made as late as possible before the seed is required for sowing, because the later the time the more closely will the germination approximate that obtained in the field.

In all methods of testing the germination of tree seed, three conditions must be fulfilled. The seed must be supplied with adequate heat, moisture, and oxygen. Species appear to differ in their requirements for light during germination. With most species a temperature between 60° and 80° F. is most favorable; the moisture should not be in the form of free water about the seed; and the air should be admitted in sufficient quantity to supply the necessary oxygen and permit the escape of carbon dioxide.

23. Kinds of Germinating Apparatus.—Many kinds of germinating apparatus for testing tree seed have been devised. All kinds, however, depend for their effectiveness upon the control of heat, moisture, air and light, and the cost and labor of operation. Any apparatus which will meet these requirements will serve for germination tests. Haack² states that for all species that germinate within 3 or 4 weeks no special apparatus is essential although some forms are preferable to others.

All methods for testing the viability of tree seed by germination tests may be placed in the following two classes:

a. The use of soil as a medium through which air, moisture, and heat are brought to the seed.

b. The use of some medium other than soil through which air, moisture, and heat are brought to the seed.

¹ Cox, W. T.: Reforestation on the national forests. (U. S. Forest Service, Bul. 98. 1911.)

² Haack, Oberförster: Der Kiefersamen. (Zeitschrift f. Forst- u. Jagdwesen, S. 353-381. 1909.)

As a rule, the most favorable conditions for germination are attained when the seed is placed in soil kept at a suitable degree of temperature and moisture. The air between the soil particles provides an ample supply of oxygen. Garden soil or other soil containing a large percentage of organic matter is an unfavorable medium due to the various destructive fungi that are dormant in it. As germination proceeds these fungi destroy the seedlings or entirely check their development. Sterilized soil or porous, moderately fine sand is better and should be used in preference to ordinary soil.

24. GERMINATION TESTS IN SOIL. — *The soil test is the most satisfactory because it is the natural method and gives the most uniform results.* Other tests often give higher but more fluctuating results and require less time for germination. All germination investigations on an extensive scale should be by soil test. *The results obtained are closer to those actually obtained in the nursery and field.* When many tests are made, hothouse facilities are essential so that the heat, light, moisture, and air can be easily regulated. The tests can be conducted in small beds made on the benches or in suitably constructed flats. Movable flats have the advantage of being more easily emptied and refilled with soil. In either case the soil should be of uniform depth, usually 4 inches, and thoroughly homogeneous in physical and chemical characteristics. The seed is usually covered to a depth equal to its greatest diameter. Bates¹ recommends that all seed be covered to a depth of $\frac{1}{4}$ inch, that the same soil never be used for two consecutive tests and that special attention be given to securing a *uniform depth of soil both under and over the seed* (Fig. 18).

The problems of seed testing are complex and permit of exceedingly diverse results depending upon the methods and conditions under which the tests are made. Soil tests in suitably constructed hothouses are now accepted by the U. S. Forest Service as the most useful and are chiefly followed in determining germination values.

In the pot test an ordinary flower pot is filled with soil and the seed scattered over the surface. A covering of sand is scattered over the seed, or if it is very small and delicate as in willow and birch it is covered with a layer of sphagnum moss or a piece of

¹ Bates, C. G.: The technique of seed testing. (Proc. Soc. Am. For., vol. VIII, pp. 127-138. 1913.)

moist blotting paper. The moisture can be regulated better by placing the pot in a receptacle containing water, from which the moisture can reach the seed from below. Excellent results are obtained by wrapping the pot with sphagnum moss which is kept

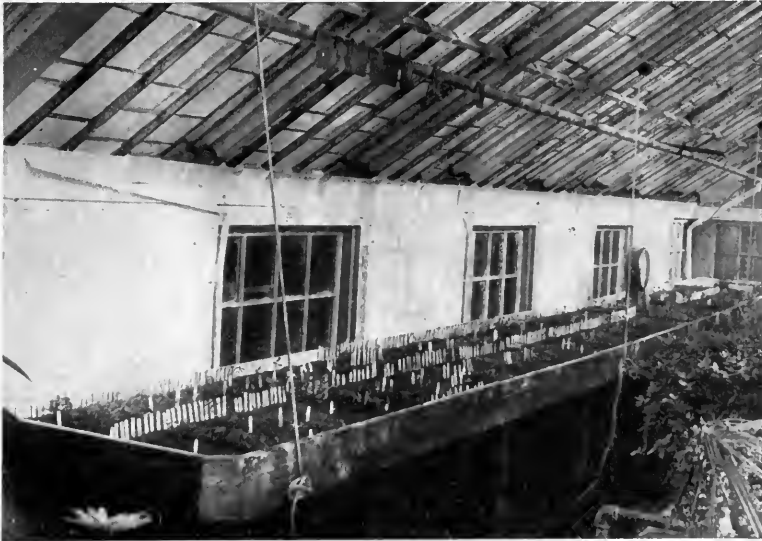

FIG. 18. — Greenhouse benches arranged for germination tests.
New Haven, Conn.

moist. The water enters the soil through the porous clay of the pot. As the seeds germinate they should be removed and an accurate count kept of those that germinate from day to day.

25. GERMINATION TESTS IN MEDIA OTHER THAN SOIL. — Sawdust, moss, blotting paper, and flannel require more attention than soil in making germination tests. If the seeds become infested with a superficial covering of mycelia, little harm is done if the test does not extend beyond a period of 21 days. This period is sufficiently long for the most vigorous germination of many species when the seed is subjected to sufficient heat and moisture. As a rule, the rapid development of fungi over the seed is an indication that it is old and the embryo probably dead.

26. *The Blotter Test.* — Heavy paper blotters serve as a useful medium between which germination tests can be made. They should be kept moist but not wet. They are particularly useful

when the period of germination does not extend beyond 1 or 2 weeks. The blotters should be placed in a moderately shallow dish and an average sample of the seed placed between them. Free water should not come in contact with the blotters or the seed will become overwet. They should, therefore, be slightly raised above the water in the dish and strips of blotting paper or flannel arranged to connect the blotters containing the seed with the water below. The dish should be more or less completely covered, depending upon the humidity of the surrounding air. A suitable temperature should be maintained and water added from time to time. One advantage of this test lies in the ease with which the progress of germination can be observed at any time

by simply removing the upper blotter.

27. Germination Tests on Plates of Porous Clay or Plaster of Paris.—

A variety of forms of porous clay plates for testing the germination of tree seed are in use. The water is conveyed to the seed through the porous plate. An impervious dish is partially filled with water and the

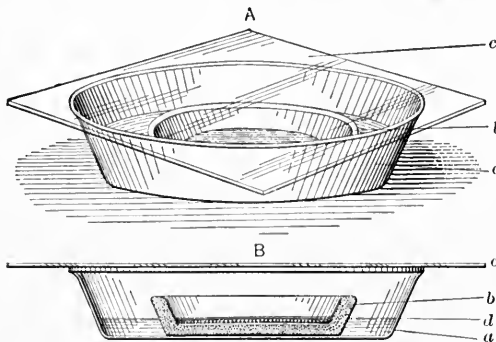

Fig. 19. — An improvised germinating apparatus.

A. Complete.

B. Cross section.

a. Impervious dish.

b. Porous plate.

c. Glass cover.

d. Water level.

porous plate upon which the seed is distributed is placed in the former so that the water comes in contact with its lower surface only. The water reaches the seed in ample quantity to induce germination by soaking through the plate. A bell jar or glass plate controls the loss of moisture through evaporation (Fig. 19). Porous germination dishes made of plaster of Paris are superior to clay plates in porosity.

Stainer's germinating apparatus figured and described by Eberts¹ has been tested by the author with satisfactory results.

¹ Eberts, E.: Zwei neue Keim-Apparate. (Allgemeine Forst- u. Jagd-Zeitung, S. 371-372. 1884.)

It is one of the best of the porous plate germinators and consists of a dish made of blue crystal glass, 8 inches in diameter and $1\frac{1}{2}$ inches high, resting on four short legs. A glass tube in the center of the dish permits the entrance of air from below during the test. The porous plate is $6\frac{1}{2}$ inches in diameter and $\frac{3}{4}$ inch high. It has 100 small depressions on its upper face for the reception of the seeds. A blue crystal glass bell jar 5 inches in diameter with an opening in the top for the exit of air fits into a groove on the upper face of the plate and covers the seeds. In making a germination test, 100 seeds are placed in the depressions on the plate and covered with the bell jar. Water is poured into the dish until it rises two-thirds the height of the porous plate. It reaches the seeds by soaking through the plate. As fast as the seeds germinate they are removed and counted (Fig. 20).

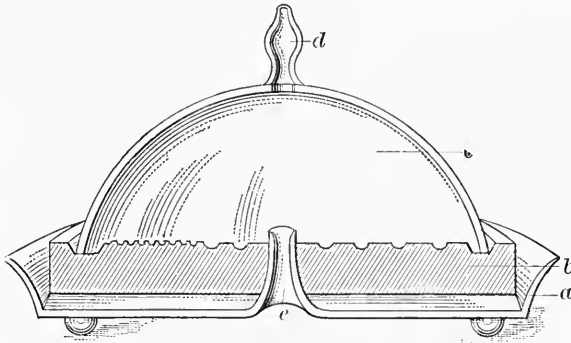

FIG. 20. — Cross section of Stainer's germinating apparatus.

- | | |
|---------------------|--------------------------------|
| a. Impervious dish. | d. Opening in cover. |
| b. Porous plate. | e. Opening in impervious dish. |
| c. Cover. | |

28. Germination Tests Between Strips of Cotton Cloth or Flannel. — Various forms of apparatus for making germination tests are in use in which the seed is placed between pieces of cloth kept continually moist by water conveyed to them by capillary action.

When but a small number of seeds are tested the flask method is useful because of its simplicity. A moderately wide-mouthed flask is partially filled with water. Two strips of flannel are suspended in the flask, one strip folded to hold the seed 1 or 2 inches above the water and the other reaching into the water

(Fig. 21). This test gives excellent and quick germination when the investigation covers a period of 20 days or less.

When a large number of samples of tree seeds are to be tested

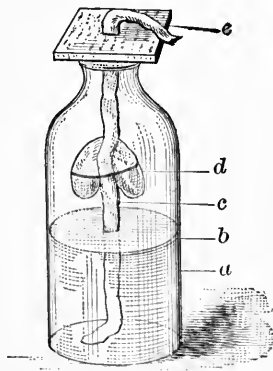

FIG. 21. — Germinating flask.

- a. Flask.
- b. Water surface.
- c. Strip of flannel.
- d. Pockets for seed.
- e. Cover.

between strips of flannel or other cloth, the Geneva seed tester is recommended. This consists of a vessel made of tin or galvanized iron, across the top of which are placed a number of glass or metal rods. A piece of cloth of the same width as the vessel is attached to the rods, in such a manner that when it is suspended over the vessel pockets are formed between the rods to hold the seed. When the apparatus is in use it is partially filled with water and the seed placed in the pockets $\frac{1}{2}$ inch above the surface of the water. Moisture is brought to the seed by capillary action through the cloth which reaches from the pockets to the water. In making this apparatus a single piece of cloth may be extended over the whole series of rods so that there

is a deep fold between adjacent rods. The exchange of air and gases is regulated by the degree of crowding of the rods (Fig. 22).

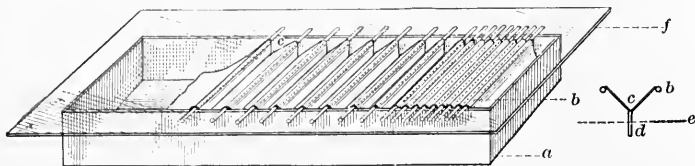

FIG. 22. — The Geneva seed tester.

- a. Impervious pan.
- b. Glass or metal rods.
- c. Fold or pocket between the rods.
- d. Cloth suspended in the water from the lower part of the fold.
- e. Position of the water surface below the fold.
- f. Glass cover.

The apparatus is placed in a hothouse or ordinary living room where the temperature is sufficiently high to induce germination.

The Jacobsen germinating apparatus¹ is a Danish invention

¹ Jacobsen, I.: Keimprüfung von Waldsamen. (Centralblatt f. d. gesamte Forstwesen, S. 22-28. 1910.)

somewhat similar to the Geneva seed germinator. It consists of a shallow impervious pan, usually made of zinc. Glass rods or perforated zinc plates are supported an inch or less above fresh water previously placed in the pan. Circular woolen cloths, cotton cloths and blotting papers are placed one above the other on the rods or plates. The sample of seed is placed on the paper and the whole covered with a glass plate so that full daylight has access to the seed. Strips of flannel or other wicks hang down from the woolen cloths into the water. It is recommended that the water be heated to a temperature of 97° F. every 3 hours during the day. This raises the temperature under the glass cover to from 78° to 82° F.

This apparatus has been in use for many years in many seed-testing laboratories in Europe.

Haack recommends that in all forms of apparatus where the seed lies on bibulous paper and secures its moisture by capillary action, the free water should be 1.2 inches below the paper, and when flannel is used but 0.6 inch below.

29. THE GERMINATING OVEN.—The germinating oven is necessary in all extensive germination tests when hothouse facilities are not available. The standard oven is double walled and made of copper. A water space is afforded by the two walls. The outer surface of the oven is usually covered with felt to lessen the loss of heat by radiation. The chamber is heated by gas or electricity and the temperature controlled by a thermo-regulator. Openings into the oven control the exit and entrance of gases. The seed is placed between moist blotters or on porous germinating plates and arranged on the shelves within the oven.

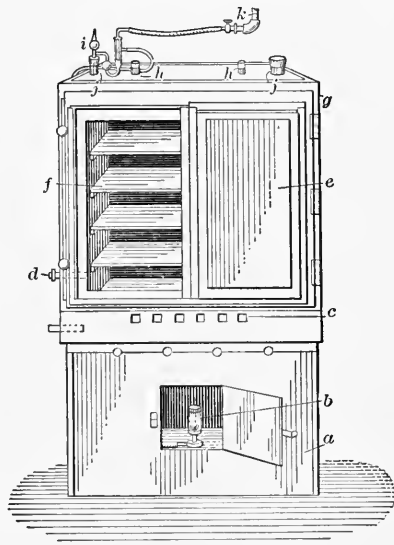

FIG. 23. — Standard seed-germinating oven. *a*, Sheet-iron base; *b*, burner; *c*, ventilators; *d*, gas exit; *e*, door; *f*, shelves; *g*, asbestos cover; *h*, openings into chamber; *i*, thermo-regulator; *j*, openings into water jacket; *k*, gas entrance tube.

As fast as the seeds germinate, they are removed and a record kept of the number that germinate each day during the test (Fig. 23).

30. Germination Temperatures. — A fluctuating temperature within certain limits is more favorable to germination than a constant temperature. Under natural conditions the temperature during the day is considerably higher than at night. This daily change in temperature stimulates the germination of seed, as demonstrated by many researches in recent years. In hothouse tests a fluctuating temperature corresponding to natural conditions should be maintained. At the Fremont forest experiment station¹ the seed is subjected to a daily fluctuation in temperature of approximately 30° F., falling at night to 55° F. and rising in the day to 85° F. Schwappach,² in a report from the Prussian seed-testing station at Eberswalde, states that the tests are made in a lighted room kept at a constant temperature of 77° F. He states, however, that white pine seed germinates more quickly by exposing it first to a temperature of from 41° to 50° F. and later raising it to 77° F. Zederbauer,³ in most of his tests, subjected the seed to a fluctuating temperature, lowered to 59° F. at night and raised to 73° F. during the day. When the seed was subjected to a constant temperature it was maintained at 73° F. Seed from hot climates requires a higher temperature for germination than seed from cold regions. Seed that naturally germinates in early spring requires a cooler temperature than seed from the same locality that germinates later when the weather is warmer. Old seed usually germinates better under a moderately low temperature. The marked effect of temperature upon the rapidity, uniformity, and capacity for germination and the lack of uniformity which now exists in germination tests make the standardization of temperature conditions for seed tests extremely important.

31. Special Treatment to Hasten Germination

Various methods of seed treatment have been advocated for the purpose of hastening germination. In general, the germination

¹ Bates, C. G.: The technique of seed testing. (Proc. Soc. Am. For., vol. VIII, pp. 127-138. 1913.)

² Schwappach, Adam: Mitteilungen aus der Waldsamen. (Zeitschrift f. Forst- u. Jagdwesen, S. 753-762. 1909.)

³ Zederbauer, E.: Die Keimprüfungsdauer einiger Koniferen. (Centralblatt f. d. gesamte Forstwesen, S. 306-313. 1906.)

of all seeds is hastened by soaking them in water for a time before planting. Among special methods of treatment to hasten germination may be mentioned the following:

a. When the pericarp or testa is more or less impervious to moisture because of its hardness or leathery character, as in basswood, it may be removed in whole or in part.

b. When the kernel of the seed is cartilaginous in character, as in honey locust and locust, soaking in hot water will hasten germination.

c. An impervious pericarp or testa may be softened and rendered more absorptive by the use of sulphuric acid or potash lye. In using these materials, however, care should be taken not to destroy the vitality of the seed by too prolonged application.

We have very little definite information regarding the practicability of subjecting refractory tree seed to special treatment in order to hasten germination. As a general rule the seed of species that under natural conditions lie over until the second year should be stratified shortly after its maturity and left in the ground until a year from the following spring when it should be removed and sown very early in the season. It is usually less expensive and far more successful than special treatment to hasten germination. It appears from the author's investigations that the only special treatment of practical value is the submerging of certain seeds in hot water for a time before sowing.

Leguminous seed and a few other species in which the endosperm is cartilaginous or horny should be soaked in hot water prior to seeding, using from four to five times as much water as seed. The temperature of the water should vary somewhat for different kinds of seed. The best results with locust are obtained by using water at a temperature of from 190° to 196° F. If boiling water is used in large quantity with a small amount of seed, the seed is killed. After the seeds have been placed in the hot water and stirred briskly for a few minutes, the vessel should be set aside until the larger number have swollen to two or three times their normal size. The swollen seeds should be planted immediately after their removal from the water. Seeds that resist the first treatment should be treated again. Larch is very irregular in germination, many seed lying over until the second season, particularly when sown late in the spring. Germination is hastened and rendered much more uniform when the seed is subjected to the hot water treatment before seeding.

All seed is injured by submerging it for too long a period in water, particularly when hot or lukewarm. The longest submergence of coniferous seed in lukewarm water should not exceed from 16 to 24 hours. A submergence in cold water for several days is usually harmless.

When seed has been kept in a dry room for some months before sowing, Mayr¹ recommends that it be transferred to a moist cellar or a moist room having a relative humidity of 70 per cent for a period of 2 or 3 weeks before seeding.

32. The Average Viability of Commercial Seed

The following table compiled from researches made by the author from 1900 to 1910 shows the average viability of fresh

| Species. | Per cent of ger- mina- tion. | Per cent sound. | Species. | Per cent of ger- mina- tion. | Per cent sound. |
|------------------------|---------------------------------------|--------------------|--------------------------------|---------------------------------------|--------------------|
| | Plus. | | | Plus. | |
| White pine..... | 68 | 9 | Shagbark hickory..... | 80 | 6 |
| Western white pine... | 16 | 57 | Cherry birch..... | 26 | 0 |
| Sugar pine..... | 47 | 29 | ¹ Beech..... | 42 | 39 |
| Red pine..... | 87 | 0 | White oak..... | 74 | 0 |
| Scotch pine..... | 83 | 3 | Pin oak..... | 68 | 0 |
| Red spruce..... | 54 | 0 | Hackberry..... | 74 | 12 |
| Engelmann spruce..... | 76 | 0 | ¹ Osage orange..... | 34 | 43 |
| Western hemlock..... | 52 | 0 | Tulip..... | 1 | 7 |
| White fir..... | 32 | 6 | Black cherry..... | 5 | 72 |
| Bald cypress..... | 21 | 0 | Black locust..... | 48 | 39 |
| Redwood..... | 42 | 0 | Red maple..... | 61 | 11 |
| Arbor-vita..... | 47 | 0 | Basswood..... | 0 | 71 |
| Red cedar..... | 1 | 62 | Hardy catalpa..... | 85 | 0 |
| Western yellow pine... | 71 | 8 | Pignut hickory..... | 85 | 2 |
| Pitch pine..... | 82 | 0 | Paper birch..... | 21 | 0 |
| Jack pine..... | 84 | 0 | Chestnut..... | 68 | 0 |
| Loblolly pine..... | 74 | 1 | Red oak..... | 83 | 0 |
| Longleaf pine..... | 31 | 3 | Red mulberry..... | 46 | 0 |
| Sitka spruce..... | 72 | 3 | Cucumber tree..... | 3 | 68 |
| Eastern hemlock..... | 21 | 0 | Sycamore..... | 8 | 22 |
| Douglas fir..... | 65 | 7 | Honey locust..... | 42 | 31 |
| Balsam fir..... | 36 | 10 | ¹ Sugar maple..... | 38 | 20 |
| Bigtree..... | 58 | 0 | ¹ Box elder..... | 19 | 47 |
| Incense cedar..... | 24 | 5 | ¹ White ash..... | 9 | 71 |
| Western red cedar..... | 54 | 0 | White elm..... | 71 | 0 |
| Black walnut..... | 84 | 4 | | | |

¹ When the seed has been stratified all or nearly all germinate within fifty days.

¹ Mayr, Heinrich: Waldbau auf naturgesetzlicher Grundlage. S. 327. Berlin, 1909.

commercial tree seed. Viability was determined by germination tests and equals the average percentage of germination at the end of the tests plus the average number of sound seed. The tests were made in soil and varied from 30 to 100 days depending upon the species. All tests were continued 100 days when there were sound seed that had not germinated. The above table should not be followed blindly in using commercial seed. With more care in collecting and storage the average viability is constantly increasing.

The deviation from average viability is shown in the tests on 923 samples of seed at the Prussian testing station from 1907 to 1909 inclusive reported by Schwappach. The following table from his report shows the average maximum and minimum viability, the difference being largely due to the effect of good and poor seed years upon viability. The seed was tested in germinating dishes of porous clay and on bibulous paper in a lighted room kept at a temperature of 77° F.

| Species. | Per cent maximum viability. | Per cent minimum viability. |
|---------------------|-----------------------------|-----------------------------|
| Scotch pine..... | 96.7 | 35.7 |
| Norway spruce..... | 96.7 | 49.7 |
| European larch..... | 50.0 | 20.0 |
| White pine..... | 86.0 | 33.0 |
| Jack pine..... | 89.0 | 35.3 |
| Sitka spruce..... | 93.7 | 22.0 |
| Blue spruce..... | 77.7 | 73.7 |
| Douglas fir..... | 85.7 | 50.0 |
| Birch..... | 34.3 | 20.3 |
| Alder..... | 43.7 | 15.0 |

More recently Rafn ¹ has published a comprehensive report on the germination of the seed of many of the forest trees of the United States, the investigations covering the years from 1887 to 1912. The following table compiled from his report shows the highest and lowest germination values met with in the tests made. The numbers within the parentheses preceded by the plus sign represent the ungerminated seeds that were sound at the end of the test. The tests were made mostly on bibulous paper in the Jacobsen germinator.

¹ Rafn, Johannes: The testing of forest seeds during 25 years. (Printed by the author for private circulation.) 1915.

| Species. | Date. | Germination in per cent after | | | | | | |
|-----------------------------|---------|-------------------------------|----------|----------|----------|----------|-----------|-----------|
| | | 5 days. | 10 days. | 20 days. | 30 days. | 60 days. | 100 days. | 200 days. |
| Red pine..... | 1905-06 | | 93 | 95 | | | | |
| | 1902-03 | | 70 | 89 | | | | |
| Pitch pine..... | 1905-06 | 65 | 93 | 96 | | | | |
| | 1903-04 | | 18 | 48 | | | | |
| Western yellow pine.... | 1910-11 | | 88 | 96 (+1) | | | | |
| | 1890-91 | | 1 | 11 | 12 | | | |
| Longleaf pine..... | 1901-02 | | 14 | 54 | 59 (+3) | | | |
| | 1890-91 | | | 1 | 2 (+5) | | | |
| Lodgepole pine (Rocky Mts.) | 1901-2 | | 81 | 93 | | | | |
| | 1896-97 | | 2 | 29 | | | | |
| Limber pine..... | 1901-02 | | 6 | | 67 (+31) | | | |
| | 1911-12 | | 9 | 40 | 56 (+24) | | | |
| Shortleaf pine..... | 1909-10 | | 51 | 69 | 69 (+22) | | | |
| | 1901-02 | | 1 | 3 | 10 (+46) | | | |
| Coulter's pine..... | 1906-07 | | | | | 2 | 27 | 65 (+28) |
| | 1908-09 | | | | | 53 | 84 | |
| Jeffrey pine..... | 1909-10 | | | | 30 | 73 | 89 (+3) | |
| | 1905-06 | | | | | | 69 (+2) | |
| White pine..... | 1905-06 | | | | | 82 | 95 | |
| | 1896-97 | | 14 | 63 | 86 | | | |
| Western white pine.... | 1902-03 | | | | | 10 | 29 (+34) | |
| | 1911-12 | | | | 15 | 21 (+31) | | |
| Sugar pine..... | 1902-03 | | | | 2 | | 2 (+29) | |
| | 1911-12 | | | | | | 55 | 88 (+1) |
| White spruce (Danish seed) | 1908-09 | | | | | | 3 | 15 (+7) |
| | 1909-10 | | 81 | 93 | | | | |
| Engelmann spruce.... | 1887-88 | | 9 | 11 | | | | |
| | 1900-01 | | 97 | 98 | | | | |
| Sitka spruce..... | 1906-07 | | 67 | 71 | | | | |
| | 1911-12 | 23 | 62 | 84 | 87 (+2) | | | |
| Balsam fir (American seed) | 1889-90 | | | 10 | 17 (+47) | | | |
| | 1905-06 | | 14 | 40 | 44 (+10) | | | |
| White fir..... | 1889-90 | | | 1 | 1 | | | |
| | 1900-01 | | 38 | 67 | 69 | | | |
| Noble fir (Pacific Coast) | 1888-89 | | | 4 | | | | |
| | 1905-06 | | | 12 | | | 72(+1) | |
| Douglas fir (Pacific Coast) | 1888-89 | | | 2 | | | | |
| | 1911-12 | 38 | 63 | 70 | 72 | | | |
| Douglas fir (Rocky Mts.) | 1892-93 | | | 7 | 13 (+60) | | | |
| | 1909-10 | | 75 | 92 | 94 | | | |
| Arbor-vitæ..... | 1909-10 | | 18 | 29 | 32 | | | |
| | 1910-11 | | | 67 | 85 | | | |
| Western red cedar..... | 1902-03 | | 24 | 41 | | | | |
| | 1909-10 | | 83 | 91 | | | | |
| | 1890-91 | | | 3 | | | | |

33. Germinative Capacity, Germination Number, and Germination Per Cent

Considerable confusion exists in the use of the terms germinative capacity, germination number, and germination per cent. All of these terms have been used by different authors to represent *the proportion of germinable seed to the dead kernels*. The term germination number is used by Mayr¹ and many other European writers to express this proportion. More recently germinative capacity has come into use and has been employed by

¹ Mayr, Heinrich: *Waldbau auf naturgesetzlicher Grundlage*. S. 367. Berlin, 1909.

Rafn, Bates,¹ and others for the same purpose. As germination per cent is sometimes employed to express germination in a given length of time, it should not be used to express the total percentage of germination irrespective of time. Boyce² has suggested the term final germination per cent to represent this proportion. The author believes the term germinative capacity is the most desirable of these terms, meets with most general acceptance, and should be used in preference to the others.

34. VARIATION IN THE GERMINATIVE CAPACITY OF FRESH SEED

The germinative capacity of fresh seed depends upon:

- | | |
|-----------------|--------------------|
| a. The species. | c. The individual. |
| b. The season. | d. The locality. |

Under the best conditions some species, as illustrated in hemlock, bald cypress, basswood, sycamore, and tulip, produce seed that average extremely low in germinative capacity. Less than 5 per cent of tulip seed on the average is fertile. Many species, on the other hand, average high in germination. When pine and spruce seed is fresh a germinative capacity of from 80 to 95 per cent is not unusual.

A wet spring is often the cause of a large number of blind seed or those otherwise imperfectly developed. A dry summer causes the seed to be small and the seedlings grown from them weak and inferior. A severe drought in August and early September ruins the chestnut crop in southern New England. In cases where none of the egg cells within the ovules become fertilized, the fruit with its contained seed fails to develop. Cold, wet weather at the time of pollination checks the flight of insects and prevents the pollen from being carried by the wind. As a result, pollination does not take place, and consequently the embryo fails to develop.

Trees growing at the limits of their range or otherwise in unfavorable localities usually produce a high percentage of infertile seed. In many instances all seeds are sterile. For this and other reasons relating to environment, age, and condition of the individual, seed collected from one tree may have a much higher

¹ Bates, C. G.: The technique of seed testing. (Proc. Soc. Am. For., vol. VIII, pp. 127-138. 1913.)

² Boyce, I. S.: Some methods in the germination tests of coniferous tree seeds. (The Forest Club Annual, University of Nebraska, vol. VI, p. 72. 1915.)

germinative capacity than seed from another tree of the same species. So also seed collected from different parts of the tree often exhibit a wide range in fertility. Thus, tulip fruits from the uppermost part of the crown often contain from 20 to 40 per cent of viable seed, while those from the lower part may be completely sterile. In most pines and other conifers, the position that the seed occupies in the cone determines its relative viability. Thus, in white pine the seeds under the lower and uppermost cone scales are usually small, blind, or otherwise imperfectly developed, while those toward the center of the cone average the highest in fertility.

Species in which the seed kernel is protected by thin, absorbent coverings usually germinate in a few days or at most in a few weeks; moreover, the germination is comparatively uniform. On the other hand, species having a thick, hard, or leathery pericarp, more or less impervious to moisture, are much slower and more irregular in germination, as is the case with walnut, hickory, chestnut, beech, oak, cherry, basswood, holly, hawthorn, and haw. In some species, the testa is thick and hard, as in red cedar which requires a year or longer for germination. In the magnolias, persimmon, and many leguminous species, the seed kernel is hard and horny, and months are required, under normal conditions, for sufficient water absorption to induce germination. Some species appear to require periods of rest before germination takes place even under the most favorable conditions. This is shown in the fact that many species, when subjected to conditions suitable for germination immediately after ripening, require two or three times as long to germinate as when they are subjected to similar conditions after a period of storage.

Even in the most quickly germinating species, a few of the seeds usually lie over and do not germinate for an entire year.¹ Seed sown in the autumn or spring that does not germinate by midsummer lies over until the following spring. The seeds of red cedar, cucumber tree, haw, and black gum, which are very slow to germinate and which usually lie over until the second year, sometimes germinate in small numbers a few weeks after seeding.

¹ In the spring of 1904, the author gathered 400 seeds of sugar maple that had been lying on the ground over winter. These seeds were immediately sown in a seedbed at New Haven, Conn. An accurate record of germination and later growth was kept. This record showed that 326 seeds germinated in 14 days, 26 later in the spring, 7 did not germinate until the following spring, and 41 failed to germinate.

The time required for germination is very largely determined by the manner in which the seed has been stored. As a rule, the drier the seed becomes in storage the longer will germination be delayed after seeding. Thus, walnut and hickory, if stored dry, lose their vitality or else lie in the ground for a full year before germinating; while, if stratified over winter, they germinate the first season.

Tests made to determine germinative capacity are seldom continued until *all the viable seeds germinate*. Bates states that in District 2 *germinative capacity is measured in twice the length of time required to measure germinative energy*. Thus, in studies made on thirteen samples of lodgepole pine seed the average energy period was 35 days and the capacity period 70 days.

When a germinative test to determine germinative capacity has extended over a period of from 30 to 100 days, depending upon the species, it is usually closed and the viability of the ungerminated seed ascertained by cutting them open.

35. Germinative Force, Germinative Energy

More or less confusion also exists in the use of the terms germinative force and germinative energy. They are often used synonymously in the United States to represent *the percentage of germination attainable under the most favorable conditions in a definite period of time*. Although each of these terms has occasionally been used by European authors with a different meaning, the term germinative energy is now widely accepted both in this country and abroad and should be used in preference to other terms. Boyce¹ has recently advocated the use of the term practical germination per cent.

Most experiments made to determine the germinative energy of tree seed have been laboratory investigations. There are few data from experiments in direct seeding or placing the seed under a covering of earth in the field. In laboratory investigations the seeds are germinated in ovens or in hothouses and accurate counts kept of those that germinate from day to day for a period of 7, 10 or more days. *The number of seeds that germinate during the definite period of time in proportion to the whole number is the measure of germinative energy*.

¹ Boyce, I. S.: Some methods in the germination tests of coniferous tree seeds. (The Forest Club Annual, University of Nebraska, vol. VI, p. 72. 1915.)

Haack's¹ investigations show that germinative energy instead of germinative capacity is the important factor in seed quality. He concludes that *it is only the rapidly germinating kernels that furnish the plants in open sowings*. He states that with Scotch pine 7 days should be sufficient to settle the judgment on seed quality rather than the longer period required for complete germination.

The germinative energy period terminates with the rapid and constant falling off in daily germination. Bates² has adopted the following for marking the termination of this period. In a sample of 500 seeds the germinative energy period ends when the germination drops below two seedlings in one day, if on the following day the germination does not exceed two. When good fresh seed from the same general locality and of the same species is tested under uniform conditions the period of vigorous germination for all samples is remarkably uniform, so much so that a definite period can be fixed. The length of this period varies not only with the species but with the origin of the seed, the locality where it is to be used, and the method of testing. Wiebecke³ found from several thousand tests on Scotch pine seed at the Eberswalde seed extracting establishment that the time limit should be 7 days for that species. He assumed that all seeds germinating during this period would be valuable in nursery and field seeding, while those that germinated later would be of little or no value. Bates states that the time is modified by a change from loam to sand in the testing bed. Tests under comparatively high temperatures on bibulous paper or plates of porous clay in the germinating oven give a shorter period than when the tests are made in soil in the hothouse. The germinative energy period in days has been determined for many species from the results obtained from tests. As the period is fixed according to the judgment of the one making the tests and the time varies with the origin of the seed and the method of testing, there is more or less lack of uniformity in the results.

When the seed is to be used in a region having a very short season favorable to germination, the germinative energy period allowed in the test should be correspondingly short. Bates places the germina-

¹ Haack, Oberforster: Der Kiefern Samen. (Zeitschrift f. Forst- u. Jagdwesen, S. 353-381. 1909.)

² Bates, C. G.: The technique of seed testing. (Proc. Soc. Am. For., vol. VIII, p. 134. 1913.)

³ Wiebecke, Forstmeister: Die Anwendung neuen Erkennens und Könnens auf die Kiefern Samen darre. (Zeitschrift f. Forst- u. Jagdwesen, S. 355. 1910.)

tive energy period of Douglas fir for Wyoming use at 35 days and for Colorado use at 21 days. After many tests made in the hot-house, he accepted 25 days as the energy period for western yellow pine, 22 days for Engelmann spruce, and 31 days for lodgepole pine for use in the northern Rocky Mountain region. From a series of experiments conducted by Zederbauer,¹ he concludes that from 14 to 21 days are sufficient for most conifers. Tests made by him on clay plates under a day temperature of from 71° to 73° F. lowered to 60° F. at night, and others made on filter paper in a germinating oven at a constant temperature of 73° F. gave the following germinative energy periods:

| | Days. | | Days. |
|---------------------|-------|------------------------|-------|
| White pine..... | 30-40 | Douglas fir..... | 28 |
| Lodgepole pine..... | 28 | Western hemlock..... | 21 |
| Pitch pine..... | 14 | Western red cedar..... | 21 |
| Jack pine..... | 14 | Bigtree..... | 14-21 |
| Blue spruce..... | 14 | Chamæcyparis (various | |
| Black spruce..... | 21 | species)..... | 21 |
| Sitka spruce..... | 21 | | |

In 1907, the officials of various seed-testing stations, at the International Congress for Agriculture and Forestry held at Vienna, agreed that germination tests conducted under the most favorable conditions should be concluded after a set time as shown below.

| | Days. |
|--|-------|
| European larch, nearly all pines and various species of Chamæcyparis | 20 |
| Scotch pine..... | 30 |
| White pine..... | 60 |
| Alder and birch..... | 20 |
| Most other broadleaved species..... | 30 |

In the author's opinion, figures showing *the course of germination*, *i.e.*, the germination in 5, 10, 20, 30, 60, and 100 days, are more useful than those showing germinative energy. When the full data showing the course of germination of a given species are available, judgment as to how long a test should continue can be more satisfactorily determined. Rafn's ² researches show the average course of germination for a large number of American species to be as follows:

¹ Zederbauer, E.: Die Keimprüfungsdauer einiger Koniferen. (Centralblatt f. d. gesamte Forstwesen, S. 306-313. 1906.)

² Rafn, Johannes: The testing of forest seeds during 25 years. (Printed by the author for private circulation.) 1915.

| Species. | Average germination in per cent after | | | | | | |
|----------------------------------|---------------------------------------|----------|----------|----------|----------|-----------|----------------|
| | 5 days. | 10 days. | 20 days. | 30 days. | 60 days. | 100 days. | Over 100 days. |
| Red pine..... | | 71.6 | 93.3 | | | | |
| Pitch pine..... | 36.5 | 67.2 | 85.5 | | | | |
| Western yellow pine..... | | 23.8 | 33.8 | 41.0 | | | |
| Longleaf pine..... | | 4.7 | 27.5 | 33.0 | | | |
| Lodgepole pine (Rocky Mts.)..... | 12.1 | 51.2 | 63.3 | | | | |
| Lodgepole pine (California)..... | | 6.0 | 20.1 | 25.3 | | | |
| Limber pine..... | | 5.0 | 36.7 | 61.7 | | | |
| Jack pine..... | 40.7 | 68.1 | 73.5 | 73.6 | | | |
| White pine..... | | 1.0 | 8.3 | 22.0 | 43.2 | 62.5 | 71.2 |
| Western white pine..... | | 1.7 | 2.6 | 10.2 | | | |
| Sugar pine..... | | | | 0.4 | 20.2 | 31.6 | 54.8 |
| White spruce (Danish seed)..... | | 56.7 | 70.9 | 71.6 | | | |
| Engelmann spruce..... | 33.0 | 75.6 | 82.4 | 82.5 | | | |
| Black spruce..... | | 36.2 | 66.2 | 69.2 | | | |
| Sitka spruce..... | | 26.3 | 62.4 | 67.8 | | | |
| Eastern hemlock..... | | | 1.1 | 1.5 | 12.5 | 18.2 | |
| Western hemlock..... | | 3.8 | 19.7 | 37.9 | | | |
| Douglas fir (Pacific coast)..... | | 15.4 | 42.5 | 49.5 | 53.2 | | |
| Balsam fir..... | | 6.1 | 20.7 | 25.2 | | | |
| White fir..... | | 14.7 | 31.1 | 36.4 | | | |
| Red fir..... | | 1.5 | 8.9 | 14.4 | 20.5 | 25.0 | |
| Redwood..... | | 8.7 | 13.5 | 14.7 | | | |
| Bigtree..... | | 8.0 | 30.1 | 37.3 | | | |
| Incense cedar..... | | 7.7 | 19.3 | 25.1 | | | |
| Arbor-vita..... | | 57.5 | 73.1 | | | | |
| Western red cedar..... | | 35.0 | 51.2 | | | | |
| Lawson cypress..... | | 15.0 | 34.0 | 34.6 | | | |
| Arizona cypress..... | | 9.5 | 28.0 | 30.4 | | | |
| Monterey cypress..... | | 0.6 | 5.4 | 10.9 | | | |
| Paper birch..... | 8.9 | 20.5 | 23.5 | 23.6 | | | |
| Cherry birch..... | | 6.2 | 30.1 | 32.8 | | | |
| Catalpa..... | 37.7 | 63.5 | 73.8 | 73.8 | | | |

36. The Utilization Value of Tree Seed

Until recently the utilization value of tree seed has been expressed by the product obtained by multiplying the purity by the germinative capacity and dividing by 100. As a specific example, white pine seed having a purity of 95.8 per cent and a germinative capacity of 82 per cent has under this interpretation a utilization value represented as follows:

$$\text{Utilization value} = \frac{\text{purity} \times \text{germinative capacity}}{100}$$

$$\text{or Utilization value} = \frac{95.8 \times 82}{100} = 78.6.$$

This method for calculating utilization value has been in use for many years. At best, however, it is but a crude approximation of the actual number of plants that should be expected in nursery or field practice. *It is far too high.*

Utilization value based upon germinative energy is now recognized as more fully expressing the real value of the seed, hence the desirability of employing it in an expression to represent utilization value. In the introduction of this factor into the formula for utilization value the following equation is used:

$$\text{Utilization value} = \frac{\text{purity} \times \text{germinative energy}}{100}$$

In a sample of western yellow pine seed having a purity of 97 per cent and a germinative energy of 49 per cent in 20 days, the utilization value is as follows:

$$\text{Utilization value} = \frac{97 \times 49}{100} = 47.5.$$

Both germinative energy and germinative capacity are sometimes introduced into the formula for utilization value. Under this interpretation of utilization value the formula is as follows:

$$\text{Utilization value} = \frac{\text{purity} \times \frac{\text{ger. energy} + \text{ger. capacity}}{2}}{100}$$

In a sample of western yellow pine seed having a purity of 97 per cent, germinative energy of 49 per cent in 20 days, and a germinative capacity of 84 per cent, the utilization value is expressed as follows:

$$\text{Utilization value} = \frac{97 \times \frac{49 + 84}{2}}{100} = 64.5.$$

Bates,¹ in developing the seed-testing investigations for the Central Rocky Mountain Region where the favorable period for germination is usually short, assumed that only those seeds which germinate very vigorously under hothouse tests are useful under field conditions. The delayed germination occurring after the seeds have been under test from 20 to 30 days is useless when they are

¹ Bates, C. G.: The technique of seed testing. (Proc. Soc. Am. For., vol. VIII, p. 134. 1913.)

used in field operations, as conditions become unfavorable for germination because of lack of moisture. In field practice germination depends upon the amount and distribution of the precipitation. *It does not depend upon how wet the soil becomes at times but how long it remains sufficiently moist to induce germination.* Even in nursery practice where suitable moisture conditions can be maintained by irrigation, the delayed germination is crowded out by the earlier, more vigorous plants or attacked by damping-off fungi. For these reasons it is becoming more and more the practice to base utilization value entirely upon germinative energy.

37. Germination Values as Compared with Tree Per Cent

Recent investigations show that *the percentage of germination obtained by standard germination tests is not proportional to the percentage of plants obtained in actual field or nursery practice.* Seed having a germinative capacity of 70 will not produce seven-ninths as many plants as seed having a germinative capacity of 90 but only about half as many. *The tree per cent lags behind the germinative capacity, and the lower the capacity the greater the divergence.* Haack¹ first pointed out this principle and proved its importance in determining the value of seed for nursery and field seeding. He found with Scotch pine that the plant per cent from seed with different germinative capacities was as follows:

| | | | | |
|---------------------------|-----|-----|----|-----|
| Germinative capacity..... | 65 | 75 | 85 | 95 |
| Plant per cent..... | 14 | 22 | 31 | 44 |
| Factor..... | 2.2 | 1.4 | 1 | 0.7 |

In the above table 85 is accepted as the average germinative capacity for fresh Scotch pine seed. Seed with this germinative capacity gave a plant per cent of 31. Applying this in practice with seed having different germinative capacities, it appears that 2.2 times as much seed should be used when the germinative capacity is but 65 and but 0.7 as much when the germinative capacity is 95. In other words, were it necessary to use 5 pounds of seed per acre having a germinative capacity of 85, it would be necessary to use 11 pounds of 65, 7 pounds of 75, and but $3\frac{1}{3}$ pounds of 95 in order to obtain the same plant per cent. These and other more recent experiments prove that *low-grade seed is much less*

¹ Haack, Oberförster: Der Kiefern Samen. (Zeitschrift f. Forst- u. Jagd-wesen, S. 353-381. 1909.)

valuable than indicated by standard germination tests and the higher the quality of the seed the nearer the tree per cent corresponds with the results obtained by germination tests.

The reason why tree per cent lags so far behind germinative capacity on all qualities of site is chiefly due to the fact that the various causes which destroy the viability of some of the seeds before ripening or between the period of ripening and seeding also decrease the vitality of the others in varying degrees. When the vitality is greatly impaired the seed may germinate but the germ is usually weak, normal roots do not develop, and it soon dies. Many years of observation of Scotch pine germination in Europe show that *the higher the germination not only the smaller the number of dead kernels but also the greater the vitality of those capable of germination.*

Bates¹ from tests on the seed of four species gives the following average germinative energy and the energy period as compared with the average tree per cent from spring field sowing and summer field sowing. The table also shows the germinative energy after the field tests. The field germination was under the most favorable conditions.

| Datum. | Western yellow pine | Lodgepole pine | Douglas fir, Col. | Engelmann spruce, Col. |
|---|---------------------|----------------|-------------------|------------------------|
| Germinative energy in per cent before field test..... | 41.4 | 58.4 | 42.47 | 39.3 |
| Germinative energy in per cent after field test..... | 42.2 | 58.4 | 44.08 | 47.2 |
| Germinative energy period in days.. | 25.0 | 27.0 | 21.0 | 22.0 |
| Tree per cent from spring seeding.. | 38.3 | 12.0 | 42.41 | 35.3 |
| Tree per cent from summer seeding | 18.62 | 37.5 | 17.64 | 39.0 |

¹ Bates, C. G.: The technique of seed testing. (Proc. Soc. Am. For., vol. VIII, p. 135. 1913.)

CHAPTER VIII

FOREST TREE SEED AND SEED COLLECTING (*Continued*)

1. SEED PRODUCTION

Few people are sufficiently familiar with forest tree seed and with methods of collecting and handling it to be safely trusted to collect the fruit and extract the seed. For this reason it is preferable to purchase it from a trained collector or dealer when but a small quantity of seed is desired. The aim of the collector should be to secure seed of high quality at the least cost per pound. Usually a full seed crop and high quality go together, also the cost of collecting rapidly decreases with the fullness of the crop.

Years when the seed of a given species is produced in abundance are known as seed years for that species. Intervening years are known as off years. During off years the seed is not only in small quantity but that which is produced is more keenly sought after by birds and rodents because of the limited supply. Insect damage is also likely to be greater. For these and other reasons the small crop in off years is usually of low quality.

The seed year of a given species usually means an abundant crop throughout most of its range. It may, however, be entirely lacking in restricted regions. On the other hand, during an off year limited portions of the range may experience a fair, or even a full, crop. We have little knowledge of the causes of seed years and off years, and although this is a matter of fundamental importance in silvicultural operations we cannot foretell with any degree of accuracy when seed years will occur.

There is a voluminous European literature on the various problems of seed production, notably the writings of Lauprecht, Schwappach, Wimmenauer, and more recently those of Sobolev and other Russian foresters. As pointed out in a recent review of the subject by Zon and Tillotson,¹ the results of the earliest in-

¹ Zon, R. and Tillotson, C. R.: Seed production and how to study it. (Proc. Soc. Am. For., vol. VI, pp. 133-152. 1911.)

vestigations have but little practical application. Observations on the mast of beech show that in a specific district in Germany there were 1 full seed year, 3 half seed years, 4 partial seed years, and 17 off years or failures between 1787 and 1811. The total amount of mast produced in these 25 years equaled that of 3 full seed years; or, in other words, the equivalent of a full seed year occurred at 8-year intervals. Between 1850 and 1873 in the same district the beech produced the equivalent of a full seed crop at intervals of 12 years. Other observations on the beech made during the same period in other localities showed the equivalent of full seed years at 7-year intervals, suggesting the effect of locality upon seed production. A more comprehensive study of seed production under a definite plan was carried on for 20 years by the Prussian government, based on an ocular estimate of the amount of seed produced by the dominant trees in the stand. Schwappach¹ in the summation of the data in 1895, although appreciating its heterogeneous character and its non-applicability to specific localities, was able to determine the average seed production of the various Prussian species from the following formula:

$$\text{Average production} = \frac{a \times 100 + b \times 50 + c \times 25}{a + b + c + d}.$$

a = number of full seed years.

b = number of medium seed years.

c = number of poor seed years.

d = number of failures.

The amount of seed produced in a full seed year is designated by 100, in a medium seed year by 50, in a poor seed year by 25, and a failure by 0.

Applying this formula to the various species for the time over which the observations were made the average annual seed production in per cent of a full crop was as follows:

| | | | |
|--------------------|------|-----------------|------|
| Birch..... | 44.8 | Silver fir..... | 34.5 |
| Hornbeam..... | 42.0 | Ash..... | 33.3 |
| Alder..... | 39.9 | Oak..... | 17.1 |
| Scotch pine..... | 37.6 | Beech..... | 16.2 |
| Norway spruce..... | 37.1 | | |

¹ Schwappach, A.: Die Samenproduktion der wichtigsten Waldholzarten in Preussen. (Zeitschrift f. Forst- u. Jagdwesen, S. 147-174. 1895.)

Although the above are average figures of seed production for an entire region, they cannot be used in judging local seed production, because the age and character of the stand and differences in soil and climate affect the periodicity of seed years. Wimmenauer, in compiling the observations made over a period of 10 years at 260 stations in Germany, found that the fullness of the seed crop of Norway spruce for a single year (1887) varied at the different stations as follows:

- 12 per cent of stations, full seed crop, expressed as 1.
- 32 per cent of stations, fair seed crop, expressed as $\frac{2}{3}$.
- 47 per cent of stations, poor seed crop, expressed as $\frac{1}{3}$.
- 9 per cent of stations, complete failure expressed as 0.

This shows slightly less than half a full seed crop as an average for the entire region.

More recent methods for studying seed production have been advanced by Russian foresters, notably Soboled.¹ Soboled's method includes:

- a. The determination of the quantity of seed per unit of area.
- b. The determination of the quality of the seed.

The seed crop, or x , is expressed by the formula $x = ap$, in which a is the weight of pure air-dried seed from a unit of area, and p is the germinative capacity.

The amount of seed per unit of area is determined by means of sample plots, each of which contains at least 100 trees of the principal species composing the stand. The collection is made from sample trees within the sample plots, and the yield of the entire plot estimated from the carefully selected sample trees. This intensive method carried out for a long period of years in a given locality measures seed production with a high degree of accuracy.

As yet the seed production of trees indigenous to the United States has not been extensively studied. We have little information on the periodicity of seed years and the average yearly production per unit of area for different regions and different species. From ocular studies Cox² estimates the following as a full seed crop for a number of western species:

¹ See reviews and discussions of these methods by Zon, Dana and others. (Proc. Soc. Am. For., vol. VI, pp. 145-152; and vol. VIII, pp. 117-130.)

² Cox, W. T.: Reforestation on the national forests. (U. S. Forest Service Bul. 98, p. 13. 1911.)

AMOUNT OF SEED PER ACRE

| Species. | Seed-bearing trees per acre. | Bushels of cones per tree. | Pounds of seed per bushel of cones. | Pounds of seed per acre. |
|--------------------------|------------------------------|----------------------------|-------------------------------------|--------------------------|
| Douglas spruce..... | 10 | 3.50 | 1.25 | 43.75 |
| Western yellow pine..... | 5 | 4.00 | 1.50 | 30.00 |
| Lodgepole pine..... | 40 | 0.50 | 0.25 | 4.00 |
| White pine..... | 7 | 1.00 | 1.10 | 7.70 |
| Red pine..... | 5 | 0.80 | 1.00 | 4.00 |
| Engelmann spruce..... | 12 | 1.25 | 0.80 | 12.00 |
| Sugar pine..... | 8 | 7.00 | 1.60 | 89.60 |

Zon¹ has recently published the results of the study of the seed production of western white pine in Idaho by the sample plot method. Four carefully selected sample plots were studied. The trees were divided into five crown classes and the sample trees selected from each. In the year that the study was made (1911), 98.8 per cent of the yield was obtained from the first two crown classes and no seed from the last two. The year was one of average seed production and the yield was found to be as follows:

| | Lbs. |
|--|------|
| Plot I, yield of germinable seed per acre..... | 5.4 |
| Plot II, yield of germinable seed per acre..... | 2.5 |
| Plot III, yield of germinable seed per acre..... | 0.6 |
| Plot IV, yield of germinable seed per acre..... | 2.9 |

2. THE LOCATION OF SEED AREAS

As the fullness of the crop varies in the different localities of a tree's range and in different years, a careful examination of the available stands must be made before the maturity of the crop, in order to locate areas where the seed crop is sufficiently heavy to make collecting profitable. When a large quantity of seed is required, a good deal of time can be wisely given to the location of available seed areas. In locating these areas attention should be given both to the abundance and quality of the seed. Localities where abundant crops abound should be avoided if on inspection the immature seed is badly infested with weevil or for other reasons is likely to be of poor quality. In the location of available seed areas not only should the abundance and quality

¹ Zon, Raphael: Seed production of western white pine. (U. S. Dept. of Agr., Bul. 210. 1915.)

of the crop be considered but attention should also be given to the question of available labor, cost of living, and transportation.

If information is received on the relative abundance of blossoming and the setting of the fruit during the spring and early summer months and the condition of the developing fruit in late summer, the problem of seed gathering in the autumn is much simpler and less expensive. An estimate of the amount of seed available in each particular locality of the tree's range should be made and the collecting confined to the particular localities where the largest amount of seed of good quality can be obtained. Due consideration, however, must be given to the climate and soil conditions under which the seed trees are growing and the suitability of the seed for use in the particular localities for which it is desired.

3. JUDGING THE MATURITY OF TREE SEED

Before proceeding with the details of collecting, it is necessary to ascertain when the seed is ripe. With many species, particularly those which hold their seed but a few days after maturity, a knowledge of the average date of ripening will not suffice. A personal inspection must be made, the fruit opened, and the seeds examined. Fleishy or pulpy fruits usually become soft and change their color at maturity. Thus the fruits of mulberry, hackberry, black gum, persimmon, elder, and haw when mature can be readily recognized from their external appearance. Dry fruits, on the other hand, may or may not show maturity from external appearance. Walnut, hickory, oak, maple, ash, and many other seeds of hardwood species assume a more or less marked change in color at maturity. In most coniferous species, however, the external appearance of the fruit is not indicative of seed maturity. When left on the tree to become dry or change in color, it either loses its seed by falling to pieces, or else it opens and the seed escapes.

It is always best to open the fruit and examine the seed of dry-fruited species. As the seed matures, the outer seed coat usually changes color and the kernel loses its soft, milky characteristics and becomes firm.

4. TIME FOR COLLECTING TREE SEED

The time to collect tree seed depends upon:

- a. The time the seed matures.
- b. The character of the seed and fruit.

With most species the best time to collect is immediately after the seed matures. This is particularly true when the seed is disseminated shortly after ripening, and when it is likely to be destroyed by birds or rodents. When the season is forward, the seed may be ripe ten days or two weeks earlier than in a late season. At the southern extension of a tree's range or at low elevations the season for collecting may be a full month in advance of that farther north, or at high elevations. The collecting of coniferous seed can be safely begun as soon as the squirrels begin to store their winter's seed supply.

When the fruit is large and heavy, as in walnut, hickory, chestnut, beech, and oak, it falls to the ground beneath the parent trees shortly after maturing. The first fruits to fall are invariably wormy or otherwise inferior. Gathering should be delayed until after the first heavy frost or until a large part of the fruit has fallen. If delayed too long, however, squirrels and other rodents destroy the best of it and collecting is correspondingly expensive.

All species which retain their unopened fruit on the tree for some months after maturity permit collection at any time before the natural dissemination of the seed. Jack pine, lodgepole pine, and some other species retain their unopened cones for a year or longer after ripening and can be collected at any time, the product of two or three crops often being gathered at the same time. Sycamore, holly, box elder, black locust, honey locust, catalpa, and basswood retain their unopened fruit on the tree well into the winter or until the following spring and can be collected in the winter, or even in the early spring, often more advantageously than in the autumn. Most birches also retain their seed until late winter or early spring.

5. METHODS OF COLLECTING TREE SEED

There are three general methods of gathering the fruit and seed of forest trees.

- a. From the ground or from a water surface.
- b. From standing or felled trees.
- c. From squirrel hoards or caches.

In any particular case, the best method to follow depends upon the species, locality, and the presence of squirrel hoards or of lumbering operations. When a large amount of seed is required it is

often best to collect it by more than one method. If squirrel hoards are available the time for collecting coniferous seed can be much lengthened as the cones remain unopened in squirrel hoards for weeks after those on the trees have opened and scattered their seed.

6. Collecting from the Ground or from a Water Surface

The only species that can be gathered from the ground advantageously are those that produce large fruit which falls to the ground unopened or which produces large, heavy seed that is not scattered by the wind as it escapes from the fruit. At times of heavy seed crops, many of the smaller-fruited species which are disseminated by the wind are blown into depressions or collect in large quantities at the foot of sloping rocks from where they can be collected at little cost. The winged fruit of elm, maple, and ash is often collected in such places.

When seed trees of birch, elm, and maple grow along water courses, the seed falling on the surface is often carried into eddies or along the bank where it collects in large quantities. After gathering it should be thoroughly dried in the shade before sacking for transportation to the seed-house or curing-shed.

7. Collecting Direct from the Tree

In most instances, tree seed must be collected from the tree by hand picking before the fruit begins to fall and before it begins to open and scatter its seed. This applies in particular to the following classes of fruit:

- a. Fruit too small to be economically picked from the ground after falling.
- b. Fruit that is wind disseminated.
- c. Fruit that bears small seed which falls from it while still attached to the tree.
- d. Fruit that bears seed that is wind disseminated.

Fruit too small to be economically picked from the ground after falling although not scattered by the wind is illustrated in hackberry, mulberry, cherry, holly, and black gum. In these species the fruit after maturity falls to the ground beneath the parent tree or is scattered by birds that pick it from the tree.

Wind-disseminated fruit is illustrated in birch, alder, ironwood, hornbeam, elm, tulip, sycamore, locust, maple, basswood, and

ash. Under particularly favorable conditions the fruit of the above trees can be collected from the ground or from a water surface; nearly always, however, reliance must be placed upon collecting it from the trees.

Species bearing small seeds which fall to the ground after maturity through the opening of the fruit while still on the tree are illustrated in the cucumber tree and witch hazel.

Nearly all species which cast their seed while the fruit is still attached to the tree are wind disseminated. The seed has special structures which facilitate its being carried by the wind greater or less distances from the parent tree. A great number of our economic species belong to this class. The seed is often scattered a few days after maturity. In all cases it is necessary to gather the fruit before it begins to open. The seed of nearly all conifers with the exception of the junipers is wind disseminated. Among broadleaved species the seeds of willows, poplars, red gum, and catalpa are disseminated in like manner.

The labor involved in collecting seed from the tree varies greatly with the species, the fullness of the crop, the size, form, and height of the tree, and the experience of the collector. It also depends upon whether the trees are climbed or whether the seed is collected from felled trees following lumbering operations. When the trees are climbed and the fruit dislodged by hand, low-branched, limby trees are easier, safer, and less expensive to collect from.

The fruit is usually borne in greatest abundance at the top of the crown and at the ends of the side branches. In gathering, it is usually advisable to permit the dislodged fruit to fall directly to the ground without attempting to deposit it in baskets or sacks while in the tree. When the fruit is small as in black cherry, hemlock, and hackberry, a canvas should be spread under the tree to catch it as it falls and thus facilitate economic gathering and sacking.

In order to reach the fruit safely and dislodge it the climber must be equipped with climbing irons and ropes, particularly when large trees are climbed. He must also have implements which will reach the outermost ends of the branches from his position in the interior of the crown and detach the fruit from the tree. Various types of pruning hooks and specially devised tools have been used for this purpose. An ordinary garden rake with iron teeth serves very well for breaking off and dislodging

the cones of white pine, red spruce, and the fruit of most other conifers and many hardwood species. Long-handled pruning hooks are useful in gathering small fruit. From a position in the interior of the crown with this tool in hand the outermost branches which are loaded with fruit can be quickly cut off and brought to the ground. The fruit of white cedar, hemlock, birch, and a great variety of other species can often be rapidly gathered in this manner. The fruit of white cedar, hemlock, red cedar,

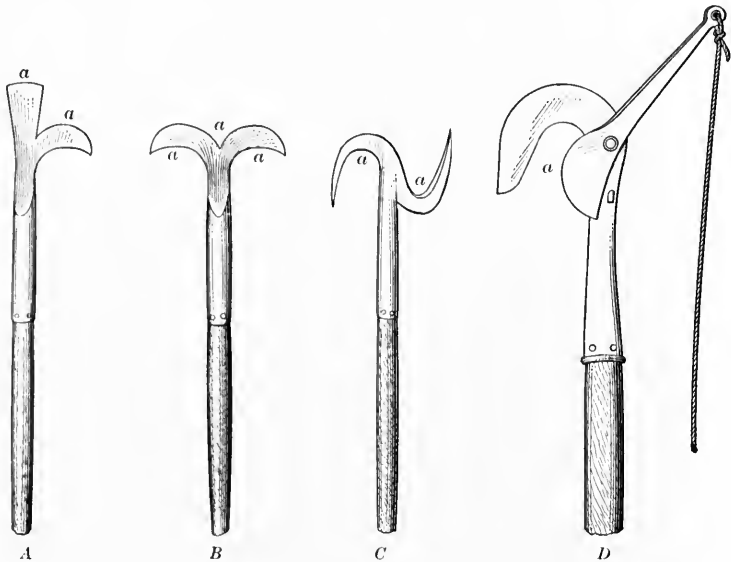

FIG. 24.—Tools useful in detaching the fruit of forest trees.

- A. Single-hook detacher.
- B. Double-hook detacher.
- C. S-hook detacher.
- D. Tree pruner.
- a. Cutting edge.

and some hardwood species, when within reach, can be rapidly removed from the tree by means of a currycomb-like tool filled with iron teeth sufficiently close to prevent the passage of the fruit. The fruit is combed from the branches into a sack or basket (Fig. 24).

All the fruit that can be reached should be detached in ascending the tree, beginning at the lower part of the crown and proceeding to the top. On the way down all fruit that has lodged

on the branches is shaken loose or otherwise dislodged. The fruit is gathered from the ground, sacked, and taken to a road or trail from where it can be easily transported to the site selected for curing, extracting the seed, and preparing the same for storage or market.

The fruits of oak, hickory, and other species which are ordinarily gathered after they fall to the ground are often collected by climbing and shaking them loose from the branches. Were one to wait until the bulk of the crop had fallen, many of the best seeds would be carried away by squirrels and other rodents.

8. Collecting from Squirrel Hoards

The fruit of many forest trees, particularly coniferous species, can often be collected from the hoards of squirrels and other rodents. Squirrels, chipmunks, and even mice store seed in caches to be used later for food.¹ Squirrels indigenous to the coniferous forests of western United States store seed in large quantities and make the largest caches. These rodents store the cones as soon as they begin to ripen and continue to do so as long as the weather permits or until the seed has fallen. They often store seed much in excess of their winter requirements, particularly in the northern Rocky Mountain region. This is especially true of Douglas fir, Engelmann spruce, western yellow pine, lodgepole pine, and western white pine.

The caches are usually difficult to find, as they are carefully concealed by covering with leaves and other forest litter. It takes considerable experience on the part of the collector to locate them. Moist sites are usually preferred, probably because the cones are less subject to opening and exposing the seed. Therefore, caches are often found in the water or mud along the borders of small streams and springy swamps. When found on upland, they are usually under a dense cover of low bushes or other woody growth, along the sides of logs, or under the tops of fallen trees. The movement of the squirrels themselves often indicates the location of the hoards. The small trails to and from the caches help to locate them. In collecting from squirrel hoards, an experienced collector passes through the stand of timber locating the caches (Fig. 25). He is followed by two or more

¹ Cox, W. T.: Reforestation on the national forests. (U. S. Forest Service, Bul. 98, pp. 17-18. 1911.)

men who gather and sack the cones and later carry them to the nearest accessible road or trail, from where they are transported to the site selected for curing and cleaning the seed. Collecting from squirrel hoards can be continued long after the cones on



Photograph by U. S. Forest Service

FIG. 25. — Gathering cones from a squirrel cache at the base of a tree.
Wasatch National Forest.

the trees have opened and scattered their seed. When a large quantity of seed is desired, this is often advantageous as it prolongs the time over which the seed can be profitably collected. When squirrel hoards are abundant, the cost of collecting is usually less than collecting from trees. Furthermore, squirrels hoard only the best cones; hence the seed is usually better than that picked from the tree. The size of individual caches varies greatly, some containing but a few cones while others may hold 10 or even 15 bushels. Under exceptionally favorable conditions a man can gather and sack from 10 to 20 bushels in a single day, although the average is usually less than half this amount. Not infrequently with such species as lodgepole pine, western yellow pine, and Douglas fir the average cost per bushel for an entire season's collecting from squirrel hoards may be less than 25 cents. This average is considerably less than half the cost of collecting the same species directly from the tree.

The gray and red squirrels of our eastern hardwood forests store the fruits of many of our nut-bearing trees, such as walnut, hickory, chestnut, beech, and oak. Usually, however, they are stored in the ground only a few in a place or else in hollow, standing trees out of reach.

9. COMPARATIVE COST OF COLLECTING CONES AND OTHER FRUITS OF FOREST TREES

The cost per bushel or pound for collecting the fruits of forest trees varies between wide limits. It not only depends upon the species but is also largely dependent upon the fullness of the crop, the cost of labor, and the experience of the collector. When a collector enters a given field for the purpose of securing a supply of seed, he either employs laborers at a stated price per day to go with him into the field and do the collecting under his supervision, or else he offers a fixed price per bushel for the fruit after it is gathered and delivered at a point agreed upon. On the whole, the latter practice is less expensive except when experienced labor is available. It requires no supervision and enables the collector to determine in advance the approximate cost price of the seed.

The average price paid in the Adirondack Mountains for collecting white pine cones and delivering them at the railroad or seed-extracting plant is 40 cents per bushel; red pine, \$1; jack pine, 80 cents; and pitch pine, 60 cents. The large-coned species in the Rocky Mountain region and on the Pacific coast usually cost from 40 cents to \$1 per bushel, although during years of abundance the cost in some localities is as low as 25 cents, particularly when the cones are obtained from squirrel hoards. Hemlock, cedar, redwood, and other species bearing small cones are collected at greater expense.

The following table by Mason shows the range in cost per bushel of lodgepole pine cones. As great a range may be anticipated with other species.

DATA ON THE COLLECTION OF LODGEPOLE PINE CONES IN
NATIONAL FORESTS IN THE LODGEPOLE REGION OF
THE ROCKY MOUNTAINS.

| National Forest. | Collecting started. | Collecting ended. | Average size of squirrel caches. | Maximum size of squirrel caches. | Average collected per man per day. | Cost of cones. |
|-------------------|---------------------|-------------------|----------------------------------|----------------------------------|------------------------------------|----------------|
| | | | Bushels | Bushels | Bushels | Per bu. |
| Year 1907. | | | | | | |
| Targhee..... | Oct. 7 | Nov. 25 | 4 | 13 | 16.5 | 0.20 |
| Year 1910. | | | | | | |
| Arapaho..... | Sept. 1 | Nov. 15 | 1.0 | 3.5 | 5.0 | 0.69 |
| Medicine Bow..... | | | | | | 0.78 |
| Bridger..... | Oct. 4 | Nov. 3 | 5.0 | 15.0 | 6.5 | 0.45 |
| Gunnison..... | Sept. 7 | Oct. 15 | 1.0 | 4.0 | 4.0 | 0.80 |
| Hayden..... | Sept. 1 | Oct. 25 | 2.0 | 7.0 | 3.0 | 0.93 |
| Holy Cross..... | Sept. 15 | Oct. 15 | | | 4.6 | 0.61 |
| Leadville..... | Sept. 1 | Nov. 30 | 5.0 | 15.0 | 6.2 | 0.73 |
| Pike..... | Sept. 10 | Oct. 29 | | | 5.3 | 1.00 |
| Shoshone..... | Oct. 5 | Nov. 7 | 2.0 | 7.0 | 5.0 | 0.60 |
| Washakie..... | Aug. 25 | Nov. 20 | 2.3 | 4.3 | 2.3 | 0.77 |
| Bonneville..... | Sept. 15 | Nov. 15 | 1.5 | 6.0 | 7.0 | 0.65 |
| Beartooth..... | Sept. 6 | Oct. 20 | | | 4.7 | 0.84 |
| Madison..... | Aug. 20 | Dec. 1 | | | 5.1 | 0.40 |
| Year 1911. | | | | | | |
| Arapaho..... | Sept. 1 | Nov. 1 | | | 5.0 | 0.40 |
| Medicine Bow..... | Sept. 1 | Nov. 10 | | | | 0.45 |
| Wyoming..... | Sept. 13 | Oct. 31 | | | | 0.85 |
| Year 1912. | | | | | | |
| Arapaho..... | Oct. 1 | Nov. 15 | | | 6.0 | 0.41 |
| Medicine Bow..... | Sept. 5 | Oct. 28 | | | | 0.45 |
| Leadville..... | Sept. 10 | Nov. 12 | | | 4.2 | 0.45 |
| Wyoming..... | Sept. 25 | Nov. 11 | | | | 0.47 |

**10. TREATMENT OF THE FRUIT AND SEED OF FOREST
TREES AFTER COLLECTING**

During the process of collecting, the fruit of forest trees is usually sacked in order to facilitate transportation to the place where it is subjected to the treatment necessary to cure it for storage or shipment or put it in suitable condition for seed extraction. The length of time that the freshly picked fruit can remain in the sacks without becoming heated, moldy or otherwise deteriorating depends upon the species and the condition of the weather. In all cases an effort should be made to get it to the place for treatment as quickly as possible. Even pine and spruce cones if left in the sack more than three or four days often mold during warm weather. Although in this case molding does not

appear to seriously injure the seed, it makes seed extraction much more difficult. After reaching its destination the method of treatment depends chiefly upon the character of the fruit.

11. Treatment of Fleshy Fruit

Fleshy fruits, as illustrated in various species of juniper, yew, mulberry, cherry, dogwood, black gum, and haw, and the semi-fleshy fruits of the honey-locust and Kentucky coffee-tree, are treated in one or another of the following ways, depending upon the mode of storage or, in some cases, upon the fancy of the collector. Where the seed can be safely stored in dried condition, the fruit as soon as it is received is spread out in a thin layer on canvas in the open sun or on a tight floor or on trays in an airy loft until the pulpy exterior thoroughly dries over the seed. As soon as dried it is ready for shipment or storage. The fruit of dogwood and cherry, particularly the black cherry, is usually treated in this manner. In most instances, it is preferable to remove the pulpy covering from the seed before storing or shipping. This can be done by macerating the fruit in water. The sacks of fruit on their receipt are left unopened until the pulpy exterior becomes soft and more or less decayed. The fruit is then placed in water and thoroughly mashed and stirred until the seeds can be washed out. The pulp rises to the surface, while the seeds sink to the bottom and hence permit of easy separation. The semi-fleshy pods of the honey-locust and the Kentucky coffee-tree should be broken up before placing them in water. Thorough mashing and stirring cause the seeds to become detached and sink to the bottom. After the seeds have been removed from the pulp, they should be spread out in a thin layer to dry. It is best to dry them slowly in the shade or in an airy loft. When thoroughly dry they are ready for shipment or storage.

The exterior covering of the fruit of black walnut is semi-pulpy in character and is usually removed before storage. This is efficiently and economically done by passing the fruit through a corn-sheller.

12. Treatment of Dry Fruit

From the standpoint of treatment before storage, dry fruits may be placed in the following classes:

a. Those in which the whole or a part of the fruit is sown with the contained seed, as in such simple fruits as hickory, beech, oak,

elm, basswood, and ash; aggregate fruits, as tulip, maple, and sycamore; and multiple fruits, as birch and alder.

b. Those in which the seed is the only part sown, as in most conifers and all dry-fruited, broadleaved species in which the fruit naturally opens to permit the dissemination of the seed. This class is illustrated in pine, tamarack, spruce, hemlock, fir, bald cypress, redwood, cedar, cypress, red gum, black locust, and catalpa.

The fruits of the first class are spread out to dry as soon as received. Simple fruit as soon as thoroughly surface-dried is ready for shipment or storage. Hickory, chestnut, beech, and oak are usually free from their outer hulls or bur-like coverings when gathered. The shagbark hickory retains some of the hulls when gathered, but they readily fall away after a short period of drying. The pignut and bitternut have thin outer hulls which are more firmly attached and are usually not removed in preparing the nuts for storage. As the acorn falls to the ground, it usually becomes detached from the cup; in a few cases, however, as in the bur oak and the overcup oak the cup overgrows the acorn to such an extent that it is very difficult to remove. The acorns of these species are stored with the cups attached. Chestnut and beech burs open with the autumn frosts and the nuts fall to the ground. When care is used in gathering no cleaning is necessary in preparation for storage. Aggregate and multiple fruits are first broken into their component parts by whipping or flailing them on a canvas or tight floor.

The fruits of the second class must be treated preliminary to seed extraction; the direct exposure of most species to the sun will cause them to open and the seed to rattle out. The resistance to opening varies greatly with different species and the conditions of the weather. The fruits of broadleaved species of this class and the smaller-coned conifers dry quickly when exposed in thin layers to full sunlight and rarely require the application of artificial heat. When the fruit is dried out of doors, arrangements should be made to protect it from rain and to prevent the seed from blowing away. The larger-fruited conifers require a much longer time and a higher degree of heat for the cones to open sufficiently to permit the escape of the seed. Under favorable weather conditions western yellow pine, loblolly pine, white pine, western white pine, sugar pine, western larch, red spruce, Sitka spruce, Engelmann

spruce, Douglas fir, white fir, and many other species may be adequately dried by solar heat.

13. DRYING CONES BY SOLAR HEAT

In drying cones by solar heat they are sometimes placed in thin layers on wire screens arranged one above the other and freely exposed to the sun. A canvas is spread beneath to catch the seed as it falls. The screens should be of suitable size to be easily moved under shelter at night or during inclement weather. When collecting seed in large quantities it is usually more economical to



Photograph by U. S. Forest Service

FIG. 26. — Drying yellow pine cones by solar heat near Golden, Colorado.

spread the cones evenly on large pieces of canvas (Fig. 26), or upon a carefully smoothed level bit of ground that is hard and compact, where they are exposed to the direct rays of the sun. If facilities afford, it is advantageous to cover them at night and during wet weather. The thicker the layer of cones on the canvas or on the ground, the longer and more irregular the drying. They should be spread thin so that the sun can strike each cone. If

the soil is cold and damp, the drying is facilitated by raising the canvas upon a platform that permits the free circulation of air beneath. The cones should be thoroughly stirred and raked over each day in order to attain uniformity in drying. When all the cones are open, the seed which has not already rattled out must be dislodged by some system of jarring.

The rapidity and evenness of drying depend largely upon the care exercised in handling the cones. As soon as they arrive at the drying ground, they should be removed from the sacks, particularly if the weather is warm and the cones moist, or they are likely to mold which makes drying difficult. Canvas drying sheets 12×14 feet are the most convenient size. From 8 to 10 bushels of cones can be spread on one of these sheets at a time. The drying ground should be level and smooth, fully exposed to the sun and the free sweep of the wind. The rapidity of drying depends entirely upon weather conditions. If drying is delayed until the late autumn rains or until winter sets in, solar drying becomes a task of continually increasing difficulty and uncertainty. Drying should begin as soon as the first cones are collected.

When good drying weather prevails it is usually less expensive to open cones by solar heat than by artificial heat. In most regions, however, the uncertainties of the weather during the autumn months has caused less dependence to be placed upon solar heat and more upon artificial heat. Moreover, certain conifers as illustrated in red pine, jack pine, lodgepole pine, knobcone pine, pitch pine, and the Monterey pine are so irregular and tardy in opening even under full sunlight that it is not ordinarily practical to attempt to open them on a large scale by solar heat.

From 3 to 14 days of good drying weather are required to open the cones of white pine, western yellow pine, Douglas fir, and Engelmann spruce. When drying by solar heat has become unduly delayed or when the weather is unfavorable, the more expensive method of artificial drying must be resorted to or the cones must be stored until the following spring.

Stored cones are quickly opened by solar heat during the first warm days of spring. If the cones are kept dry over winter, many open in storage without exposure to the direct rays of the sun. The cones are stored in bins, erected on a tight floor and protected by a projecting rainproof roof (Fig. 27).



Photograph by U. S. Forest Service

FIG. 27.— Storage building for pine and spruce cones. Medicine Bow National Forest.

14. DRYING CONES BY ARTIFICIAL HEAT

The essential requirements in drying cones by artificial heat are that they be quickly opened and that the seed does not depreciate in germinative energy or germinative capacity. These are best attained:

- a. By having the cones properly cured before drying.
- b. By subjecting them to a uniform temperature and only sufficiently long to effect their opening.
- c. By keeping the air as dry as possible in the heated chamber.

15. Curing the Cones Before Kiln Drying. — When first collected, cones usually contain large quantities of water. If placed in the kiln they are likely to dry on the surface and become stiff and hard while the center remains green. When this condition occurs no amount of later drying will cause them to open satisfactorily. This is particularly true of the large succulent cones of white pine and similar species. In small establishments the cones are cured or prepared for kiln-drying by spreading them out a few layers in depth on wire-bottomed or lath trays arranged tier above tier in the curing room. As the cones are received, they are transferred from the sacks to the trays. By means of large win-

dows reaching to the ceiling and ventilators in the roof, a free circulation of air is maintained. From 2 to 5 weeks is usually required for curing the cones. Many of the seeds rattle out and fall to the floor, which should be smooth and tight in order to prevent loss. It is often necessary to protect the windows and ventilators with wire screens in order to prevent birds, squirrels and other rodents from carrying off the seed. When the curing room is sufficiently large to hold an entire crop, a small kiln will suffice as it can be kept in continual operation for several months after the cones begin to cure. Instead of curing the cones on trays arranged in a specially designed building, they are sometimes stored in narrow bins through which the wind has a free sweep as in the modern corn crib.

Wiebecke¹ emphasizes the great importance of convenient and well-made storage and curing sheds which permit a free circulation of air and in which the cones can be protected during inclement weather. Three months of storage under the best conditions will ordinarily result in a loss in weight of from 10 to 50 per cent due to decrease in moisture. The cones of white pine open a short time after maturity and must be collected while the cone scales are still succulent and green. They require a maximum of space in the curing shed. On the other hand, the cones of jack pine and lodgepole pine do not open for months after maturity. They cure on the tree and can be closely packed in storage without harm to the contained seed.

16. Preliminary Drying Room. — In the handling of Scotch pine cones, which are quite similar to those of our red pine and some of our southern hard pines, Wiebecke recommends that a preliminary drying room be used, into which the cones are moved from the curing shed for a time before placing them in the kiln. The hot air after passing through the kiln is conducted to this room, which is maintained at a temperature of from 77° to 95° F. Without a preliminary drying room the heat from the kiln passes into the open air and is lost. The cones are taken from the curing or storage shed as needed and transferred to the preliminary drying room for a period of from 10 to 15 days. During this period the moisture content is reduced to the point of partial opening of the

¹ Wiebecke, Forstmeister: Die Anwendung neuen Erkennens und Könnens auf die Kiefersamendarre. (Zeitschrift f. Forst- u. Jagdwesen, S. 342-360. 1910.)

cones. After the transfer to the kiln a much shorter time and lower temperature is required for their complete opening than when they are transferred to the kiln directly from the storage shed.

17. The Maintenance of Uniform Temperature.— Until recently it was believed that the cones while moist and closed could be subjected to a comparatively high degree of heat but that the temperature must be lowered as drying proceeded. Kilns were constructed, making it possible for the seed to pass into a cooler compartment or room as soon as it was liberated from the cones. Recently Wiebecke¹ and others have conclusively shown that *a high temperature during the period when the cones, and consequently the contained seeds, are damp is most harmful, while the same temperature after the seed has escaped from the cones and is thoroughly dry is least harmful.* Thus, green Scotch pine cones taken from the forest and immediately exposed to a temperature of 131° F. for 20 hours, or long enough to permit seed extraction, retained on the average but a 7 per cent germinative capacity; while cones from the same lot after passing through a period of storage, preliminary drying, and exposure in the kiln for a period of from 6 to 8 hours at a temperature of 131° F. retained at the close of the run an average germinative capacity of 87.6 per cent.

The operator of a modern seed-extracting plant is confronted by the two following conditions which are worthy of careful consideration,—low temperature and increased cost for extraction and high temperature and reduction in seed quality. As high a temperature should be used as is consistent with the retention of seed quality.

Exhaustive experiments on the cones of Scotch pine and Norway spruce by Haack prove that the temperature must be gauged with extreme care, as an increase of only a few degrees above a non-injurious temperature may be very harmful. Haack recommends a constant temperature of 122° F. as the permissible heat for green cones. If the cones are dry when gathered or have been thoroughly cured, a temperature of 131° F. is permissible. Although some species, as illustrated in jack pine and lodgepole pine, will resist a higher temperature than others, *it is not safe to*

¹ Wiebecke, Forstmeister: Die Anwendung neuen Erkennens und Könnens auf die Kiefern-samendarre. (Zeitschrift f. Forst- u. Jagdwesen, S. 342-360. 1910.)

subject green or wet cones to a temperature above 122° F. for a period sufficiently long to permit seed extraction.

Properly cured cones of white pine readily open at a temperature of from 110° to 115° F. after 6 or 8 hours in the kiln. On the other hand, the cones of jack pine are particularly resistant to opening, requiring a temperature above 130° F. for at least 12 hours. The temperature should be raised as quickly as possible to that most suitable for the species after the cones have been placed in the kiln. As soon as they begin to steam the ventilators should be opened to carry off the moisture-laden air. The length of time required for the cones to open varies greatly with the species, the ventilation, and the temperature. There is also a great variation between different cones of the same species, some requiring two or three times as long as others. From 1 to 10 hours will usually suffice for the drying of all except the most resistant species. When the heating is prolonged it is often advisable to withdraw the cones from the kiln before all are opened, later returning the unopened ones for further drying.

18. The Necessity for Adequate Ventilation. — As moist heat is much more destructive to seed vitality than dry heat, adequate facilities for ventilation must be provided. When the drying is done in an improvised room heated with a stove, openings which can be opened and closed at will should be made near the floor and in or near the ceiling. By the control of the incoming and outgoing air, the moisture arising from the drying cones is carried away. Small kilns into which hot air is conducted in pipes permit of much better regulation of both temperature and moisture. The air enters the kiln already heated and the humidity is regulated by the rapidity with which it passes through the kiln and out of the ventilators.

In large kilns the hot air is forced through the enclosed chamber and kept in continual circulation by blowers. In improvised rooms and small kilns a thermometer is located in a position that will best show the average temperature of the entire heated space. In large kilns a self-recording thermometer and a hygrometer are placed so that they may be observed through a glass door communicating with the outside. The ventilators should be opened sufficiently to lower the relative humidity below 50 per cent during the early period of the drying and below 10 per cent before the cones are removed from the kiln.

19. Drying Cones in Improvised Rooms. — Cones are often collected with the expectation of opening them by solar heat. Adverse weather conditions sometimes delay the work until winter and it becomes necessary to resort to artificial heat. A room or cabin is temporarily equipped with a stove, and a number of adjustable and portable trays, arranged one above another at intervals of from 9 to 12 inches, are covered with cones. The bottoms of the trays should be of wire with the mesh sufficiently close to prevent the winged seed from dropping through. At best this is a rough and ready method, and great care must be taken that the heat and ventilation are under control. Several reliable thermometers should be hung in various parts of the room and read hourly. The presence of a window opposite the door will facilitate ventilation. Ventilators at the four upper corners of the room should be provided, if possible, to facilitate the distribution and regulation of the heat. This simple method of seed extraction is often used in the United States. Pettis in a single season removed the seed from 4000 bushels of white pine cones by this method at a cost of approximately 25 cents per bushel. The temperature should not be raised above 130° F. even with the most resistant species. For less resistant species such as the western yellow pine and white pine a temperature of 120° F. should be considered the maximum.

20. Drying Cones in Small Kilns. — The drying chamber of most small kilns is constructed of masonry or other non-conducting material into which the heat is introduced through hot air pipes. The wire-bottomed trays holding the cones are placed in the drying chamber one above the other through doors in the side of the chamber. The seed that drops from the cones during the progress of drying rattles down from tray to tray and collects in the bottom of the chamber, from where it is removed from time to time. Careful watch of the progress of drying is kept, and the trays are removed as soon as the cones open. When sufficiently dry they lose their flexible character and become stiff and brittle. The temperature and humidity can be controlled at will by shutting or opening the valves which regulate the entrance of heat and by opening or closing the ventilators.

21. Utilizing Kilns Constructed for Other Purposes. — Where large kilns constructed for the curing of hops or kilns used for drying timber are available they can often be advantageously

used in drying cones. Large quantities of cones can be dried at one time at a comparatively low cost and, as facilities are afforded for the regulation of both temperature and humidity, the quality of the seed should not suffer.

22. SEPARATING THE SEED FROM DRY CONES

In curing and drying cones only part of the seeds become detached. Some cones when thoroughly dried require only a thorough raking to dislodge the seed, as in western yellow pine and white pine. Other cones require prolonged and severe jarring. Many methods have been devised for separating the seed from the open cones after drying. The more completely the cones open under the action of heat, the easier and more complete the seed separation. No method of separation will recover all the seed. From 2 to 10 per cent usually remain in the cones. *The percentage of seed recovery is largely dependent upon the method of shipment and storage of the cones prior to drying.* MacDaniels¹ reports that the cones of Douglas fir which were received wet and stored in sacks for several weeks would not open even after being repeatedly run through the kiln.

The seed must be quickly removed from the cones after taking it from the kiln or else the extracting room must be kept warm. If the cones are brought into contact with cool or damp air after their removal from the kiln they are likely to close in a short time and make extraction difficult. In all methods of seed extraction the utmost care must be taken not to injure the seed by crushing. Coniferous seed is easily crushed or cracked, thus offering entrance for infection or causing abnormal development on germination. Wiebecke,² from numerous tests made at Eberswalde, shows that when the testa of pine seed is crushed or cracked the embryo instead of coming out normally, *i.e.*, with root foremost, comes from the seed coats with the cotyledons foremost. Such plants are useless.

When the cones are fully open they may be transferred to a room with a tight floor and flaired until the seed is separated from

¹ MacDaniels, E. H.: Operation of the Wyeth seed-kiln. Manuscript. 1912.

² Wiebecke, Forstmeister: Die Anwendung neuen Erkennens und Könnens auf die Kiefern-samendarre. (Zeitschrift f. Forst- u. Jagdwesen, S. 342-360. 1910.)

them.¹ This method of seed separation is very satisfactory with white pine and other species with large cones. Hemlock, arbor-vita and red spruce cones may be placed in partially filled sacks as soon as dried and agitated by flailing them first on one side and then on the other. The sacks are later emptied on a table covered with a wire screen through which the seed passes, after which the empty cones are discarded.²

The "cone shaker" is a practical device for separating the seed from the cones. This is a square or rectangular box sufficiently large to hold several bushels of cones. The top is formed from slats spaced wide enough to permit the passage of the unopened cones and covered with a wire screen through which the seed will pass. A heavy iron rod extends through the center of the box and projects at either end. It rests upon two uprights and has a handle at one or both ends. The dried cones are shoveled into the box one or two bushels at a time, the door is closed, and the seed rattled from the open cones by several turns of the handle. After the seed is removed from the canvas spread beneath the shaker the wire screen is taken off and the shaker again revolved in order to separate the opened from the unopened cones. The unopened cones are subjected to further drying and the opened cones discarded.³ A series of slats rigidly nailed lengthwise in the shaker increases the jarring effect. This method of removing seed from dried cones is relatively inexpensive and has been extensively used in the U. S. Forest Service, where the cones have been dried by solar heat (Fig. 28).

In modern seed-extracting plants the seed is separated from the opened cones by passing it through a "cone churn" or "revolving shaker." In its simplest form it is a cylinder, 16 feet long and 4 feet in diameter, covered with a wire screen of from $\frac{1}{2}$ - to $\frac{3}{4}$ -inch mesh, depending upon the size of the seed. A shaft extends through the center of the cylinder, upon which it revolves by hand or mechanical power. One end of the cylinder is raised 6 to 8 inches above the other. As the cones are dried, they are conveyed into the

¹ Pettis, C. R.: How to grow and plant conifers in the northeastern states. (U. S. Forest Service, Bul. 76. 1909.)

² Ibid.: The gathering of spruce seed. (New York Forest, fish and game commission, 8th annual report. 1903.)

³ Cox, W. T.: Reforestation on the national forests. (U. S. Forest Service, Bul. 98. 1911.)

elevated end of the cylinder, and gradually work their way toward the lower end. This type of cone churn is light and can be easily taken apart for transport. In recent years, it is coming into general use even in small operations when the cones are dried by



Photograph by U. S. Forest Service

FIG. 28. — Removing the seed from dried Douglas fir cones. Apache National Forest.

solar heat.¹ In the type used at Wyeth, as the cones are brought from the kiln, they are carried by mechanical conveyors to the upper end of the shaker, which is 16 feet long. Instead of being cylindrical it is 2 inches larger in diameter at the exit than at the entrance and the shaft is horizontal. The slope of the sides, due to the difference in diameter of the two ends, causes the cones to work gradually to the exit from where they are carried to the boiler room.

In the seed-extracting plant at Eberswalde² as the opened cones

¹ Cox, W. T.: Reforestation on the national forests. (U. S. Forest Service, Bul. 98. 1911.)

² Wiebecke, Forstmeister: Die Anwendung neuen Erkennens und Könnens auf die Kiefersamendarre. (Zeitschrift f. Forst- u. Jagdwesen, S. 342-360. 1910.)

come from the kiln they are quickly transferred to the "churn room" or extracting room, which is kept at a temperature of from 77° to 86° F. The churn consists of a cylinder with its sides constructed of thin bars between which the cones cannot pass but which permits the passage of the seed. By rotating the churn the seed rattles out as the cones slowly pass to the exit at the lower end. As the winged seed with such foreign matter as it contains falls to the floor it is conveyed to the wing-removing room.

23. DETACHING THE WINGS

When the seed is first separated from the cones it is mixed with a great deal of foreign matter, often from two to five times as much as the volume of the clean seed. This consists of bits of leaves, twigs, resin, small stones, and fragments of cone scales. The more or less firmly attached membranous wings on the seed of most coniferous species must be detached before it is cleaned of its foreign matter. The essential requirements in removing the wings are freedom from injuring the testa or shell of the seed and the complete removal of the wing. Two methods are practiced, *viz.*, the dry method and the wet method.

24. The Dry Method. — The simplest way to remove the wings from coniferous seed when but a small amount is treated is to rub it through a sieve in which the mesh is sufficiently small to prevent the passage of the seed with the attached wings. In many establishments the seed when brought to the cleaning room is placed in partially filled sacks which are tossed about and beaten with soft leather flails until the wings are detached.

In modern seed-extracting establishments the seed as it comes from the churn room is run through specially devised winging machines. These machines are in the form of cylinders of heavy wire with the mesh sufficiently small to prevent the seed with the attached wings from passing through. Rapidly revolving, stiff brushes within, rubbing against the drum, quickly remove the wings without harm to the seed.

25. The Wet Method. — In the wet process the seed with the attached wings is spread out on a tight floor to a depth of from 4 to 6 inches and sprinkled with water until the whole mass is slightly moist. Light leather flails are used to free the seed from the wings. The only danger is in permitting the seed to remain on the floor in a moist condition until fermentation takes place.

26. CLEANING THE SEED

Seed can be separated from the detached wings and other refuse matter by turning it on a canvas in the open with a winnowing shovel or by slowly pouring it from one basket to another through a current of air. By the exercise of due care the wings and light, worthless seed, as well as broken fragments of cone scales and other foreign matter, can be removed. This method is usually practiced when only a small amount of seed is handled. When large quantities are cleaned ordinary grain-fanning mills or specially constructed cleaning mills are more economical and more effective. Forced draft and properly arranged screens not only remove the dust, dirt, broken cone scales, and leaves but also most of the blind and otherwise overlit seed. After the seed is cleaned it is sacked or placed in carboys or boxes and is ready for storage or shipment.

27. Species that Require Special Treatment

The cones of red pine, Monterey pine, knobcone pine, and several other coniferous species cannot be satisfactorily opened by exposing them to solar or artificial heat without preliminary treatment. Before drying, they should be submerged from 5 to 20 minutes in water heated to a temperature of 130° F. On their removal from the water they should be spread out in the open air. After this preliminary treatment they open much more readily by either solar or artificial heat.

In particularly resistant species as in the European larch the cones after drying are shredded or torn in pieces in specially constructed machines.¹ Somers has recently used a machine quite similar to the ordinary grain threshing machine for extracting the seed of the western yellow pine. The cone scales are loosened or torn off in the machine and the seed liberated.

28. Seed-extracting Plants

A seed-extracting plant should be located at the point of greatest accessibility to the entire region from which the seed is drawn and from where the cleaned seed can be distributed at the least cost. Cones are usually bulky, and the directness and shortness of the haul by wagon and rail transportation are important

¹ Schlich, Wm.: Manual of forestry, vol. V, p. 765. London, 1908.

factors in the cost. Kümme¹ states that the location of the extracting plant in District 6 at Wyeth instead of Portland increased the freight charges in a single year by approximately \$700. The plant should be located on a level site, exposed to both wind and sun and accessible to a good labor market. Arrangements should be made so that the men in charge of its operation can live near by. The form and size of the curing and storage sheds should depend upon the volume of the cones treated and the species. In general, a completely equipped plant should include the following attached or closely connected rooms or buildings:

- a. Storage and curing sheds.
- b. Preliminary drying room or house.
- c. Kiln room or house.
- d. Cleaning room or house.
- e. Testing room or house.
- f. Seed-storage room or cellar.
- g. Boiler, engine, and repair house.

In some plants the preliminary drying space is in or above the kiln room, the cleaning space is in the engine and repair room, the boiler is in a separate building, and the testing and storage of the seed is elsewhere.

All modern extracting plants can be reduced to two general types so far as relates to the method of drying, *viz.*, the older type in which the cones are dried on a series of racks or drawers with perforated bottoms in an enclosed chamber, and the newer type in which the cones are dried in revolving cylinders in a heated room. The economic management of either type depends primarily upon the arrangement of the buildings and rooms in a manner to eliminate hand labor to the fullest extent and the use of automatic devices for handling the cones and seed.

29. THE OLDER TYPE OF PLANT FOR SEED EXTRACTION

The Wyeth plant, erected by the U. S. Forest Service in District 6 in 1911, may be taken as an example of the older type. It follows the design of European plants of similar type² (Fig. 29). The storage shed has a capacity of approximately 16,000 bushels;

¹ Kümme, J. F.: Annual planting report, District 6. 1911.

² Wiebecke, Forstmeister: Die Anwendung neuen Erkennens und Könnens auf die Kiefersamendarre. (Zeitschrift f. Forst- u. Jagdwesen, S. 342-360. 1910.)

the kiln when operating day and night has a daily capacity of 340 bushels of Douglas fir cones; the seed cleaning is in the engine and repair house; and the boiler is in a separate building. In operating the kiln the cones are spread out on trays arranged on trucks. They are moved through the preliminary drying room, which is heated by the exhaust air from the kiln



Photograph by U. S. Forest Service

FIG. 29.—Seed-extracting plant at Wyeth, Oregon.

chamber, then to the kiln itself entering through a door at one end and after drying passing out of a door at the other end. The heat is from two sets of steam coils, one outside the kiln chamber from which the heated air is forced into the chamber by a blower through a system of pipes and the other in the chamber. When the car with its trays is removed from the kiln it is sent directly to the seed-cleaning room.

During the first year's operation of this kiln over 22,000 bushels of Douglas fir cones were treated¹ at a cost of 26 cents per pound for extracting and cleaning the seed. The average daily (24 hours) capacity was 150 pounds of clean seed. A crew of 8 men, divided into 3 shifts, was required to operate the plant. The following season, operating for a period of 108 days and extracting and cleaning 11,834 pounds of seed, the cost was as follows:

¹ Kümmler, J. F.: Operation of the Wyeth seed kiln. (Annual planting report, District 6. 1911.)

| Species. | Total amount of seed. | Cost per pound for extracting and cleaning. |
|-------------------------|-----------------------|---|
| Douglas fir..... | 10,851 | \$0.37 |
| Western white pine..... | 420 | 0.235 |
| Shasta fir..... | 583 | 0.09 |

In this type of plant, the drying is not uniform because of the unequal temperature within the kiln. Long experience has thoroughly demonstrated that a uniform temperature is impossible when the cones are distributed in trays placed one above the other. As a result, the cones on some of the trays and around the margins dry much more rapidly than others. When they are removed, it is almost always necessary to sort out the unopened cones by hand labor and return them to the kiln. At the Wyeth plant an effort is made to maintain a temperature of 120° F. in the hot end of the kiln and from 90° to 100° F. in the other. Küm-mel states that this temperature should not be exceeded.

The operation of this plant has shown the great importance of ample storage and curing space. Thoroughly ripened cones and those adequately cured will open in the kiln in from 2 to 4 hours. On the other hand, cones heated in transit or received in wet condition, often required 10 hours or even longer in the kiln. Those received in sacks in wet condition and *permitted to remain in the sacks for some weeks could not be opened later either by high temperature or prolonged heating.*

30. THE NEWER TYPE OF PLANT FOR SEED EXTRACTION

The Foxpark plant erected in District 2 for the extraction of lodgepole pine seed is an example of the newer type. The drying cylinder in this plant is 30 feet long and 4 feet in diameter with partial divisions extending from the perimeter toward the axis which keep the cones from collecting in a mass at the bottom as the cylinder revolves. The cones enter at the upper end of the cylinder which is slightly raised above the other and gradually dry in their progress toward the exit at the lower end. It is impossible to separate the open cones from those which have not yielded their seed and the entire process is held back by the more resistant ones. Although manual labor is reduced to a minimum and the necessary heat is produced by the burning of the opened

cones the capacity of the kiln is low, due to the resistance of the cones to opening.

One of the most complete plants of the newer type is the one at Annaburg, Germany, recently visited and described by Recknagel.¹ In this plant there is a continuous movement of the cones from the storage shed through the kiln, largely controlled by automatic devices. As the cones are dried in large revolving cylinders which keep them continually on the move, a uniform temperature can be maintained.

The Annaburg plant is a large one which cost \$23,300 to construct. It has, however, an annual capacity of 22,000 pounds of

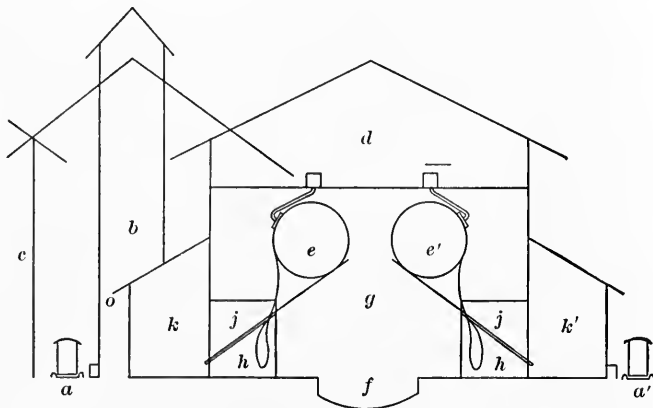

FIG. 30.—Cross section of the Annaburg seed-extracting plant.

Scotch pine seed, which is extracted and cleaned at a cost of $5\frac{1}{2}$ cents per pound. It is operated by five men, *viz.*, a superintendent, a machinist, and three workmen (Fig. 30).

The following description is from Recknagel's article:

"Side tracks (*a*, *a'*) lead to the buildings. At (*a*) the cars filled with cones are emptied and the cones immediately conveyed by a grain elevator (*b*) either to the storage house (*c*) or the filling loft (*d*). If to the former, they are spread out not over 18 inches thick on the floor and occasionally shoveled about to

¹ Recknagel, A. B.: The equipment and operation of a Prussian seed-extracting establishment. (*Forestry Quarterly*, vol. X, pp. 229-234. 1912.)

facilitate drying. If to the latter, they are shoveled into six wooden measures which hold just the proper quantity to fill the cylinders. They are then shot down (like oats from a feed loft) into the cylinders (*e*, *e'*) which after closing the six doors revolve slowly clock-wise in a masonry chamber heated to an average of 48° C. (118° F.). The cylinder is made of cast iron, perforated so as to allow the seeds to drop out but forcing the cones to remain. Each is divided into three compartments, containing 5 hectoliters ($13\frac{3}{4}$ bushels) for the entire six compartments.

“The heat is furnished from the grate (*f*) where coal and cones are burned — chiefly the former because of the excellent price received for dry cones as fuel where a hot, quick fire is needed or as kindling for household purposes. In order that the heat in the cylinders may be absolutely uniform, a thermohydrograph automatically records the fluctuations in heat and moisture content, just as a barograph records barometric variations. These sheets are kept as a permanent record of each day's operations.

“It requires from 20 to 24 hours to ‘dry’ green cones, and from 7 to 9 hours for cured cones. The seed released from the cones sifts through the perforations of the cylinder and falls down the chute into the bags suspended at (*h*). When all the seeds are out, the engine is stopped and the door of each compartment opened. Then the engine is started again and the empty cones automatically drop down the adjustable chute (*j*) into the bins (*k*) whence they are loaded directly by elevators into cars on side-tracks (*a*, *a'*).

“The bags of seed from (*h*) are taken to the winging machine. This is a smaller fine wire mesh cylinder with revolving stiff brushes inside. These brushes remove the wings without harm to the seed. From the cylinder the good seeds drop to the final cleaning screens while the wings, dust, and lighter blind seed are blown off by means of forced draught.

“After the wings are removed, the seed is screened twice and then placed in large glass carboys. No attempt is made to secure every last particle of foreign matter such as broken cone scales, but the seed is very clean. The glass carboys, each containing from 30 to 35 kilograms (66 to 77 lbs. avoirdupois), have been adopted as more satisfactory than any metal device. They are packed in willow baskets with straw padding; each basket has two handles. Basket, carboy, and all cost about 50 cents apiece.

They are preferably made of dark glass to exclude light. When the carboy is filled, it is corked (with rubber cloth around the cork as a washer) and sealed with pitch. Then the carboys are stored on shelves in a dry, dark cellar, where the mean temperature is $44\frac{1}{2}^{\circ}$ F. After storage for several years the germination per cent is practically unchanged."

31. THE STORAGE OF TREE SEED

All seed that is not sown immediately after cleaning should be carefully stored. The keeping of tree seed in condition to germinate when finally sown is often difficult, particularly so with many of our most important species. The essential conditions for storage are the regulation of moisture and a cold, or at least a cool, atmosphere. The different species vary greatly in the amount of moisture required. Even the most resistant species usually suffer when stored over winter in a furnace-heated room, or when kept over summer in a loft where the moisture content of the seed is likely to vary with variations in the humidity of the air. Many species can be safely stored over winter in a well-ventilated, unheated loft. The less resistant species, however, soon lose their viability when stored under normal atmospheric conditions of heat and moisture. The seeds of pine and most other conifers, as well as those of hardwoods like the tulip, black locust, and catalpa, are *stored dry*, while the seeds of the less resistant species, such as walnut, hickory, beech, chestnut, and oak, are *stored wet, i.e.*, under conditions which subject them to a humid atmosphere. If stored in a dry loft, they soon become shriveled and die, or else their vitality is much impaired.

Seeds are alive. They represent a dormant stage in the development of the plant. During this stage, however, life processes do not entirely cease. Respiration and transpiration still go on, increasing and decreasing with the increase or decrease in temperature and humidity. Tashiro¹ has observed by the use of special apparatus that even dry seeds give off definite CO₂ as long as they are alive. Zederbauer² shows that a low tempera-

¹ Tashiro, Shiro: New method of determining vitality of seeds. (Original communications, 8th International Congress of Applied Chemistry, vol. XXVI, p. 163. 1912.)

² Zederbauer, E.: Versuche über Aufbewahrung von Waldsämereien. (Centralblatt f. d. gesamte Forstwesen, S. 116-121. 1910.)

ture, by lowering respiration and transpiration, causes a decrease in destructive assimilation, a fact of the utmost importance in the storage of seed. The successful storage of seed requires that respiration and transpiration be reduced to the lowest possible degree. This condition can be brought about in two ways:

a. By maintaining the seed in a moist condition at a low temperature.

b. By maintaining the seed in a dry condition, that is, at a low but uniform degree of moisture.

The seeds of different species vary greatly in the degree of desiccation which they will endure without injuring or destroying their vitality. The seeds of oak and chestnut become overdry when stored at the normal humidity and temperature of the open air in winter. Under similar storage locust and catalpa are uninjured. Seeds that will not withstand a high degree of desiccation cannot be stored at normal summer temperature. When the humidity is maintained sufficiently high to prevent desiccation, respiration and transpiration are increased to such an extent that they soon die through destructive assimilation. On the other hand, the seeds of locust, catalpa, pine, and spruce remain alive for many months when kept in an atmosphere sufficiently dry to reduce respiration and transpiration below the point of rapid injury.

The method of storage best adapted to a given species does not deviate in a marked degree from the method of natural preservation of the seed up to the time of germination. Seed which matures in the autumn and is disseminated at once and covered with leaves after it falls to the ground is exposed to a low winter temperature and excessive moisture. From Zederbauer's experiments it appears that such seed when stored is favored by conditions which afford low temperature and high humidity. Seed which matures in the autumn but is retained on the trees over winter is exposed to low temperature and normal atmospheric humidity. When stored it appears to be favorably affected by low temperature but not by excessive moisture. Cieslar found that the germinative capacity of acorns is best preserved by storage at low temperature and a high degree of humidity, while the temperature and moisture conditions in the ordinary cellar, warehouse, or heated room are very unfavorable. Haack,¹ from

¹ Haack, Oberförster: Der Kiefern Samen. (Zeitschrift f. Forst- u. Jagdwesen, S. 353-381. 1909.)

a large series of experiments, has conclusively proved the favorable influence of uniform temperature and the exclusion of air for pine, spruce, and other seeds that permit of storage in dried condition. The exclusion of air maintains the seed in a uniformly dry condition and reduces respiration and transpiration to the lowest degree. For all species that will withstand thorough air-drying without injury it affords the best possible mode of storage. Haack found that the seed of Scotch pine stored in this manner for 2 or 3 years produced from 1.6 to 3.3 times the number of plants obtained from samples of the same lot of seed stored in the open air under the most favorable conditions.

32. Dry Storage

Although all species when subjected to temperatures sufficiently cool to reduce respiration and transpiration to a low degree can be stored in a moist atmosphere, seed which will withstand moderate desiccation is usually stored dry.¹

Seed should not be placed in dry storage until it is sufficiently dry to prevent heating and molding. The seed of most conifers can go into permanent storage immediately after cleaning because of the drying that it has undergone during the process of seed extraction. The seed of many broadleaved species, however, is gathered and cleaned some time before it should be stored for the winter. It should be temporarily left in thin layers in a cool, airy place, such as an open shed or barn or on trays on upper shelves in a dry cellar. Excessive drying can be judged from the shrinking of the kernel and can be checked by throwing the seed into larger heaps or by partially covering it. It is usually ready for permanent storage in October or November.

The ordinary methods of dry storage are as follows:

- a. Storage under fluctuating temperature and humidity.
- b. Cold storage.
- c. Storage in sealed cans, carboys, and boxes.

¹ Although the seeds of most conifers are stored dry, if the temperature is sufficiently low they do not suffer when stored over winter in a moist condition. In the autumn of 1906, the author stratified the seeds of 42 species of conifers. They were sown in April the following year. All species had kept in excellent condition and germinated far in advance of the same species when the seeds were stored dry.

33. STORAGE UNDER FLUCTUATING TEMPERATURE AND HUMIDITY

Most forest tree seed is stored over winter only, namely, from the time of ripening in the autumn until required for sowing the following spring. Many seed dealers handle only fresh seed, *i.e.*, seed that has been stored from one to six months. Some dealers in the United States have in recent years undertaken the storage of certain species for two or even three years. The uncertainty of the seed crop has led to marked improvements in seed storage. At times of heavy seed crops many species can be collected in excess to be used at times of shortage.

When the seed is stored over winter only, all species that are stored dry can be kept in bins, bags, or boxes in a special storage house, warehouse, or ordinary loft where they are subjected to the normal fluctuations in atmospheric temperature and humidity. The low winter temperature prevents deterioration, even when there is considerable fluctuation in humidity. When the storehouse or loft is heated, although the humidity is lowered, the increased temperature often causes unfavorable conditions. When stored in a basement or cellar under more uniform but higher temperature conditions and increased humidity, there appears to be a falling off in germination values.

34. COLD STORAGE

The length of storage of all species can be increased by keeping the seed in cold storage. This applies to seeds like pine and spruce which are stored dry, and chestnut and oak which are stored wet. Cieslar has demonstrated that the seeds of beech and oak keep much better in wet condition at a low temperature than when stored under a fluctuating temperature in drier condition. Pine, spruce and other coniferous seeds are often stored over the first winter in a seedhouse or loft where the temperature averages low because of the season. The seed which is not used the following spring is put in sacks or boxes and placed in cold storage. The low temperature checks destructive assimilation and prevents the loss incident to storage under the high fluctuating temperature of the summer season.

When forest tree seed is stored over summer in a dry condition it is good practice to place it in cold storage if facilities are not afforded for enclosing it in air-tight receptacles. The effect of

high and fluctuating temperature is shown in a set of experiments, reported by Cox,¹ with seed stored in cloth sacks for a period of three years. It was stored under three temperature conditions at Washington, D. C., and at the termination of three years the seed was tested for germinative capacity with the following results:

| Species. | Heated office. Temperature never below 32° F. | Unheated store- room. Fluctu- ating tempera- ture. | Freezing room. Temperature 6°-10° F. |
|--------------------------|--|---|--|
| Western yellow pine..... | 51.0 | 43.5 | 67.5 |
| Knobcone pine..... | 52.5 | 54.5 | 53.5 |
| Jack pine..... | 33.0 | 23.0 | 90.0 |

35. STORAGE IN SEALED CANS, CARBOYS, AND BOXES

In recent years many investigators have conclusively demonstrated that seed that can be kept in dry storage maintains both germinative energy and germinative capacity best when in air-tight receptacles. Cieslar's investigations in Austria, Haack's² comprehensive experiments on the storage of Scotch pine seed in Prussia, and the more recent investigations of the U. S. Forest Service reported by Cox³ show the superiority of this method of storage, particularly when the seed is stored for one or more years. Air-tight storage is not only desirable for first quality seed but even more desirable for seed that is relatively poor at the time of storage. Haack's researches show that exposing the seed to direct sunlight for a few days or placing it in a well-warmed room until the weight is reduced 1 or 2 per cent brings it into favorable condition for sealed storage.

At the Prussian seed establishment at Eberswalde⁴ pine and spruce seeds are stored in glass carboys. The carboys are placed in a dark cellar having an even temperature of approximately 46° F.

¹ Cox, W. T.: Reforestation on the national forests. (U. S. Forest Service, Bul. 98, p. 28. 1911.)

² Haack, Oberförster: Der Kiefern Samen. (Zeitschrift f. Forst- u. Jagdwesen, S. 353-381. 1909.)

³ Cox, W. T.: Ibid.

⁴ Wiebecke, Forstmeister: Die Anwendung neuen Erkennes und Könnens auf die Kiefern Samendarre. (Zeitschrift f. Forst- u. Jagdwesen, S. 342-360. 1910.)

It is recommended that the cellar be constructed near the extraction house, with double insulated walls and double doors, and that the roof be covered with earth and straw.

At the seed establishment at Annaburg¹ the seed is stored in glass carboys packed in willow baskets padded with straw. These are stored in a dark, dry cellar at a temperature of $44\frac{1}{2}^{\circ}$ F. The more uniform the temperature and the nearer it can be kept to freezing the better the seed keeps.

The U. S. Forest Service and many commercial dealers store coniferous seed in sealed tin cans in which they are held over until the second or third year.

Investigations, now in progress by the U. S. Forest Service, on the keeping qualities of the seed of six indigenous conifers stored in various receptacles at thirteen stations having very divergent conditions of temperature and atmospheric humidity, show the superiority of sealed receptacles over other containers even at the end of the first year of storage. These investigations have disclosed the fact that seed stored at relatively high altitudes in the West where the humidity is relatively low keep much better than when stored at low altitudes in the Middle West and East under a relatively high summer humidity, particularly when not in sealed retainers.

Haack's² investigations show that even in sealed receptacles a low temperature is preferable to a high or fluctuating one. The keeping of Scotch pine on ice in air-tight receptacles proved under all conditions superior to other methods, this being particularly true regarding the retention of germinative energy.

36. Wet or Moist Storage

Seeds which lose their vitality or in which the vitality is weakened by dry storage must be stored under conditions which afford more moisture. Seeds which do not permit of dry storage cannot be stored later than the spring following maturity if subjected to a fluctuating temperature. With the advent of spring and higher temperature the moist condition of the seed induces germination. If kept dry enough to check germination, the seed is likely to

¹ Recknagel, A. B.: The equipment and operation of a Prussian seed-extracting establishment. (Forestry Quarterly, vol. X, p. 233. 1912.)

² Haack, Oberförster: Der Kiefern Samen. (Zeitschrift f. Forst- u. Jagdwesen, S. 353-381. 1909.)

become overdry and worthless. *The best method of storage is that which keeps the seed moist and at a low temperature, i.e., at freezing or slightly above.*

The ordinary methods of wet or moist storage are as follows:

a. Storage on or in the ground.

b. Storage in running water.

Seeds kept in moist condition over winter germinate much earlier in the spring. This is often of considerable importance with species like walnut, hickory, oak, and beech. Seed should not be stored under moist conditions until late autumn or early winter.

37. STORAGE ON OR IN THE GROUND

Most species that will not survive dry storage can be safely stored in heaps on the ground. An accessible site should be selected where the soil is loose, sandy, and well drained. The area should be cleared of all vegetable matter and the fruit or seed mixed with sand. Walnuts, hickory nuts, and acorns can be piled in large heaps, and smaller fruits and seeds in small, low heaps. They should be covered with leaves or straw and later as cold weather sets in a layer of earth thrown over the covering. Bundles of straw should project through the earth covering to afford ventilation. Seed in wet storage is much less sensitive to cold than to heat. Overheating and lack of ventilation cause them to mold and decay. The earth covering should be removed early and the seed sown as soon as the soil is in condition for working. Losses from storage in heaps on the ground *are nearly always due to delay in removing the covering in the spring.* Seeds that will not survive dry storage are often kept over winter in excavations or trenches from a few inches to $1\frac{1}{2}$ feet in depth when they are mixed with sand and covered with leaves or straw.

Red oak and some species of black oaks, as well as hickory and walnut, keep very well over winter in loosely-tied burlap sacks placed flat on the ground and covered with soil. In order to keep well under this method of storage the seed should be well cured and not covered until cold weather sets in. It is not safe to attempt to keep chestnuts over winter in this manner. A high degree of moisture combined with low temperature can be secured by spreading the fruit or seed on the ground in the shade and covering it with moss, leaves, or inverted sods. Seed should

not be buried in clay or other heavy soil that does not permit perfect drainage. Squirrels and other rodents are often very troublesome. Where there is danger from this source the seed should be adequately protected. Occasional inspection is desirable. The practice of storing the seeds of walnut, hickory, oak, and other nut species in open boxes or bags in warehouses or cellars is condemned.

Seeds which lie over until the second year, such as red cedar, cucumber tree, holly, dogwood, and black gum, should be mixed with sand and buried over two winters. As soon as they begin to sprout, which is usually very early the second spring, they should be removed and sown. When seed is stored in boxes or other receptacles in alternate layers with moist sand it is said to be stratified. After the receptacles are filled with the seed and sand they are placed in a cool cellar or in pits dug in the ground. This is an excellent method of storing small quantities of all species that cannot be kept in dry storage.

The seed is placed in layers from $\frac{1}{4}$ to 1 inch deep, alternating with layers of sand 2 or 3 inches deep. Care should be taken that the sand is not wet; it should, however, be slightly moist. Instead of alternating with layers of sand the seed can be mixed with the sand in the proportion of 2 or 3 parts of sand to 1 of seed.

When a few seeds of a large number of species are stratified it is best to place each variety in a fold of thin muslin to prevent them from mixing. The folds of muslin are then arranged in alternate layers with sand.

Eastman¹ gives the following method for the storage and successful germination of red cedar. It was practiced by him for several years with uniform success. The fruit is gathered from October to January and immediately stratified without previous treatment such as soaking or the removal of the seed from the fruit. It is placed in ordinary gardener's flats. A layer of sand 1 inch in depth is put into the flat, then a layer of fruit $\frac{1}{2}$ inch in depth, this being repeated until the flats are filled. They are then buried in the ground so that the tops are slightly above the surface. Over them is placed about 8 inches of leaves or other litter weighted down with stones. They are left undisturbed until a year from the following March when the seed

¹ Eastman, R. E.: Care of the seed of red cedar. (Forestry Quarterly, vol. IX, pp. 173-174. 1911.)

is removed from the sand and sown in the nursery. The beds must be made very early as the seed begins to germinate during the first warm days of spring.

38. STORAGE IN RUNNING WATER

The seeds of most species keep over winter in excellent condition when placed in coarse, heavy sacks or wire boxes and firmly anchored in the bed of a moderately rapid stream. The seeds should be completely submerged. If the water is stagnant they are likely to spoil. Acorns keep well in this manner, and the weevil or other insects infesting them are destroyed by the water. Cieslar says that germination is retarded if the seed is stored in cold springs.

39. THE TREATMENT OF INSECT-INFESTED SEED

Sometimes as the time approaches for storage it is found that the seed is more or less badly infested with weevil or other insects. When such is the case the insects should be destroyed before storage. Various oaks, hickories, chestnuts, and leguminous species are particularly subject to this manner of injury. The best method for destroying the insects is to subject the infested seed to the fumes of bisulphide of carbon.

A few bushels of the fruit or seed are taken at a time and placed in a tight box with bisulphide of carbon in the proportion of approximately 4 ounces of the bisulphide to a bushel when the fruit or seed fill the box. The amount of bisulphide depends upon the size of the box. The poison is placed in an open vessel on top of the seed and the cover of the box tightly closed. The fumes permeate all parts of the box within 12 to 48 hours and destroy all insects which they reach.

40. THE TRANSPORTATION OF SEED

Tree seed is often gathered long distances from the region where marketed or used for seeding. It is usually shipped as clean seed. Sometimes, however, cones and the dry fruit of broadleaved species are shipped before the seed is extracted. Thus, pine cones gathered in Maine and Minnesota have been shipped in carload lots to New York for seed extraction. All seeds when in condition for storage can be sent short distances in dry wrappings. When seeds are sent long distances, however,

they must be packed in such a manner that they will not suffer from becoming too dry or too moist.

Seeds that permit of dry storage are usually shipped in sacks made of canvas or heavy cotton cloth. The sacks are usually double, *i.e.*, those containing the seeds are enclosed in others of heavier material, in order to assure against danger from leakage. When shipment is made by freight the sacks are boxed or crated. The above method is that usually followed in shipping coniferous seed. Walnuts, hickory nuts, acorns, and the fruit of other large-seeded species may be shipped loose in the car or in burlap sacks holding from 1 to 2 bushels each. If not overmoist and if shipped during cool weather, the fruit or seed is not injured by 2 or 3 weeks in transport.

On long voyages, particularly by sea, seeds are likely to become overdry or too moist if packed in ordinary wrappers. If sealed in cases or securely wrapped in paraffined paper, coniferous and other species that are ordinarily stored in dry condition can be safely shipped long distances under extreme conditions of atmospheric temperature and humidity. When packed they should be in the best condition as to moisture content, and the package and air in the package should be dry. Small seeds are often packed in powdered charcoal which absorbs any excess moisture that may gain access to the package. Even chestnuts, acorns, and other seeds of like nature, if kept in cold storage, may be shipped long distances. So far as possible all seeds that permit of dry storage should be placed in cool, dry rooms during shipment, and the shipment should be timed so as to reach its destination just before the time required for planting.

CHAPTER IX

THE PROTECTION OF SEEDING AND PLANTING SITES

SEEDING and planting should not be undertaken without certain necessary precautions against external dangers. The site should be protected from such dangers, or be capable of resisting them. This is often overlooked in artificial regeneration in the United States, and, as a result, there have been many unnecessary failures in both direct seeding and planting. Special attention must be given every site where artificial regeneration is undertaken that the seed and young plants are not injured or destroyed by:

- a. Seed-eating animals.
- b. Plant-eating animals.
- c. Fire.

1. PROTECTING THE SITE FROM SEED-EATING ANIMALS

Much of the loss from direct seeding can be directly traced to the destruction of the seed by rodents. Not infrequently from 25 to 75 per cent of the seed sown is destroyed within a week after seeding. Dearborn,¹ in a series of experiments conducted in the Black Hills, found from 30 to 70 per cent of the seed destroyed by chipmunks and mice within 6 days after seeding. Exhaustive trapping on a half acre containing 2000 seed spots secured 3 chipmunks and 11 white-footed mice, which in 3 days had taken 70 per cent of the seed. In one instance, a chipmunk was observed to visit 38 seed spots in 4 minutes.

Over many parts of the country, tree seed is the natural food of rodents. Direct seeding is usually done in the spring when food is scarce. No matter how well covered, the seed is readily found and destroyed by squirrels, chipmunks, and other rodents. In experiments conducted at the Coconino Experiment Station, seed spots were sown with yellow pine seed and covered with portable

¹ Dearborn, N.: Seed-eating mammals in relation to reforestation. (U. S. Bur. Biol. Sur., Cir. 78. 1911.)

screens. The successful germination in these spots and the complete failure in nearby, unprotected spots show the important place that animal life holds in reforestation by direct seeding.¹

Greeley² states that probably the greatest obstacle to reforestation on the National Forests by direct seeding is the destruction of the seed by rodents. Furthermore, this obstacle is extremely difficult to overcome because each area is a problem in itself, as a study must be made of the rodents present and their food habits.

Almost without exception regeneration by direct seeding throughout the entire Rocky Mountain and Pacific coast regions is impossible without protecting the site from rodents.

Although this source of injury is not so prevalent in eastern United States, squirrels are sufficiently numerous in many localities to make the regeneration of walnut, chestnut, and many oaks impossible by direct seeding without first destroying them.

When rodents abound, protection can be attained only when it is initiated before the regeneration starts. Experience has proved that in direct seeding, squirrels, gophers, chipmunks, mice, and other rodents cannot be guarded against by coating the seeds with such substances as red lead, coal tar, copper sulphate, and other materials that are distasteful to them. The coating has very little effect, as most rodents readily remove the kernel of the seed from its covering.

2. Destroying Rodents by Poisoning

The expense involved in trapping and shooting is so great that it can seldom be resorted to in clearing an area of small, obnoxious animals. In most instances, the better plan is through some system of poisoning. Some months before direct seeding, the site should be gone over carefully in order to ascertain the number and kinds of seed-eating animals that infest it or are likely to infest it when the seeding is done. A careful examination of the ground, together with the use of traps for a few days, ought to indicate the course to pursue.

The use of poisoned bait to free an area from rodents is ex-

¹ Cox, W. T.: Reforestation on the national forests. (U. S. Forest Service, Bul. 98. 1911.)

² Greeley, W. B.: Reforestation on the national forests. (Proc. Soc. Am. For., vol. VIII, pp. 261-277. 1913.)

tremely varying in its effectiveness. Munger¹ states that the control of rodents in large field operations has never been demonstrated to be practical. The many species of squirrels, chipmunks, gophers, and mice are scarcely ever the same in their relative destructiveness even on contiguous areas. Not only does each species appear to have distinctive food habits, but the food and activities of the same species differ at different times of the year. Poisoned bait distributed without regard to the destructive species and their habits is ineffective. The kind of bait, and the season and manner of applying it must be adapted to the particular species to be destroyed. If there is an abundance of rodent food on the area where the poison is distributed, it is relatively ineffective. It is, however, under such conditions that rodent damage is the least. Usually it is most effective when distributed in the spring. Poisoning the seed itself before sowing is not so effective as poisoned bait distributed over the area before the seeding. Cox² concludes from the investigations of the Biological Survey that *rodents can be greatly reduced in numbers and their depredations practically stopped by systematic poisoning.*

When rodents are abundant, it may be necessary to distribute poisoned bait several months before the seeding and again a few days before the seed is sown. When the rodents have been destroyed and a given area is practically free from the pests when the seed is sown, others may come in from unpoisoned adjacent areas and destroy the seed. It is usually desirable, therefore, *to scatter the poisoned bait over a strip from 8 to 10 rods wide entirely around the seeded area and to keep this strip well poisoned until the seed has germinated.*

When the area is poisoned in the autumn, it should be done several weeks in advance of the seeding or before the rodents begin to store their winter food supply.

Experiments made by the U. S. Biological Survey in coöperation with the Forest Service show that strychnine baits are the most effective in destroying seed-eating rodents. The following methods are recommended for preparing the bait. With slight variations in the proportion of strychnine to the other ingredients

¹ Munger, T. T.: Natural versus artificial regeneration in the Douglas fir region of the Pacific coast. (Proc. Soc. Am. For., vol. VII, pp. 187-196. 1912.)

² Cox, W. T.: Reforestation on the national forests. (U. S. Forest Service, Bul. 98. 1911.)

they are useful in destroying all rodents harmful to regeneration by direct seeding.

a. Mix 1 heaping tablespoonful of gloss starch in $\frac{1}{2}$ teacup of cold water, add 1 pint of boiling water and stir until it forms a thin, clear mucilage. Remove from the stove. Mix 1 ounce of powdered strychnine (alkaloid) and 1 ounce of powdered bicarbonate of soda and stir it into the starch. Add 1 tablespoonful of glycerine, and finally $\frac{1}{8}$ ounce of saccharin. Apply the mixture to 20 quarts of good, clean oats or wheat and mix thoroughly in order to coat each kernel.

Bell and Piper¹ report this poison as useful in destroying chipmunks, kangaroo rats, pocket mice, the smaller species of ground squirrels, and at times many white-footed mice.

Oats are usually the most successful bait. On account of the skill of chipmunks in "hulling" oats, poisoned wheat is more effective in destroying these animals. Barley, in the proportion of 16 quarts to each ounce of strychnine, has given the best results in destroying the large "digger" ground squirrels. It is most effective during the dry summer season.

b. Mix together $\frac{1}{4}$ ounce of powdered strychnine (alkaloid), $\frac{1}{4}$ ounce of powdered bicarbonate of soda, a scant $\frac{1}{2}$ teaspoonful of saccharin, 2 heaping tablespoonfuls of dry powdered starch, and add enough cold water to make a thin paste of the consistency of cream. Apply gradually to the material to be used as bait, mixing vigorously to distribute the poison as evenly as possible and to prevent the formation of lumps.

This formula is, in some respects, an improvement over the first, as the taste of the strychnine is masked for a time. The intense bitterness of strychnine detracts from success in poisoning certain rodents such as white-footed mice. The poisoned bait should be handled carefully to avoid loosening or breaking off the coating. It should be freshly prepared each morning for the day's use. The poison can be applied to oats, wheat, cracked corn, or coarse meal of all kinds. For chipmunks and ground squirrels, $\frac{1}{4}$ ounce of strychnine is sufficient for 4 quarts of bait. For white-footed mice twice as much should be used. Whole or crushed pine or spruce seed is especially attractive to the latter animals.

¹ Bell, W. B. and Piper, S. E.: Extermination of ground squirrels, gophers and prairie dogs in North Dakota. (North Dakota Agr. Exp. Sta., Cir. 4. 1915.)

A quart of poisoned grain is sufficient for about sixty baits, which are most effective when scattered near logs or stumps, along trails, and near burrows. If not exposed to rain, the bait retains its effectiveness for a long time.

Pocket gophers are not only injurious to young trees but also to the seed during germination. A poisoned bait of various vegetables, particularly sweet potatoes, is reported by Piper as most effective in killing these animals. The bait is prepared as follows:

c. Baits of vegetables should be cut about 1 inch long and $\frac{1}{2}$ inch square, and should be washed and drained. Slowly sift $\frac{1}{8}$ ounce of powdered strychnine (alkaloid) and $\frac{1}{10}$ of this quantity of saccharin (ground together in a mortar) over about 4 quarts of the dampened bait, stirring to distribute the poison evenly.

The bait is placed in the animals' runways. An iron rod is forced through the soil into the underground runway, which usually is found a few inches below the surface and parallel with it. One or two pieces of bait are dropped therein and the opening is closed.

The cost of poisoning rodents varies between wide limits, depending upon the method of distribution of the bait, the closeness of spacing in its distribution, the number of times the bait is distributed, and the relative size of the strip surrounding the seeded area necessary to poison. When it is distributed at the rate of 1 bushel of poisoned bait to 40 acres, at intervals of 15 feet in rows 40 feet apart, the cost of a single distribution varies from 10 to 20 cents per acre, depending upon the locality and the cost of labor.

Seed-eating birds are usually not harmful to direct seeding except during a short period immediately after germination when the seed coats are raised above the ground with the cotyledons still enclosed within them. When they are bitten off at this time, the young plant is destroyed.

When there is danger that the poisoned grain will be taken by birds, it should be placed in the burrows of animals, under projecting stones and logs, and in other places out of their reach.

The difficult problem of effectively eliminating seed-eating rodents, particularly white-footed mice, from badly infested sites has not been solved. Poisoning is by no means uniformly suc-

cessful. Direct seeding should seldom be undertaken on badly infested sites. Planting is more successful and less expensive when measured by the results obtained.

3. PROTECTING THE SITE FROM PLANT-EATING ANIMALS

After germination has been attained from direct seeding and after planting, the young plants are likely to be killed or severely injured by various animals, if they are not destroyed or excluded from the area. The protection should be initiated before the regeneration starts. As a rule, small animals must be destroyed; larger animals can be guarded against by fencing. Grazing animals should be excluded from all sites as soon as regeneration is begun, or else the number should be reduced to such a degree that the damage to the young trees is negligible. Game should also be under control. The amount of grazing that it is safe to permit depends upon the species and the quality of the site. Most conifers are more resistant to damage from browsing than broadleaved species. All species suffer more from being trampled by stock on poor sites where the soil is hard and compact than on good sites.

Wood rats sometimes cause considerable damage to young plantations and transplant beds in some localities in the Rocky Mountain and Pacific coast regions by cutting off the young trees and taking them to their large nests. In the investigations made by the Biological Survey effective results were obtained by dusting various baits with finely powdered strychnine. The rats are killed by the poison coming off in their mouths while carrying the bait to their nests. Raisins and whole corn when poisoned proved useful baits.

The exclusion of rabbits, which often do great harm, is a more difficult problem. Fencing is often practiced in Europe and is the most effective method of overcoming injury from them. Trapping is expensive, and the results are often of little permanent value. Cunningham¹ recommends the following as a simple and effective trap: Barrels are placed in the ground level with the surface at advantageous points. The top is so arranged that it swings freely on a rod placed crosswise over the opening. Bait is

¹ Cunningham, J. C.: Protecting trees from rabbits. (Kansas Agr. Exp. Sta., Cir. 17. 1911.)

strewn over the top. The weight of the rabbit causes the lid to turn on the rod, precipitating it into the barrel. After the barrel is set it is covered with brush, thus forming an attractive place for rabbits to congregate.

In fencing against rabbits a wire netting 4 feet wide with 1-inch mesh should be used. The netting should be supported on stakes at intervals of 18 feet. The fence is more effective in turning rabbits when constructed to slope away from the field, thus preventing them from climbing over, and when sunken into the ground for a depth of 4 inches to prevent them from burrowing under. If a heavy No. 5 wire is strung to the stakes at suitable height and the netting fastened to the wire, it forms a more substantial fence than when the netting is fastened directly to the stakes.

The damage by rabbits is usually confined to girdling or stripping the bark from small trees; sometimes, however, even the foliage is eaten. Peavy,¹ in a report on a plantation of knobcone pine and Coulter pine in Southern California, states:

“Of 4000 plants set in the early spring of 1906, all were destroyed by rabbits within a period of ten days. The greater number were eaten so completely that one had to dig below the surface in order to find the stem.”

When serious damage by rabbits is apprehended and it is impracticable to exclude them from the area by fencing, their numbers can be reduced by poisoning. The scattering of poisoned grain over the area is useless, as it is seldom eaten. Cox² recommends the scattering of poisoned twigs of forest trees or native food plants along the rabbit trails a few hours before sundown. The twigs are cut into small pieces and poisoned with strychnine.

The “Wellhouse” poison is prepared as follows:

| | |
|------------------------------|--------------------|
| Sulphate of strychnine | 1 part |
| Borax | $\frac{3}{4}$ part |
| White sirup | 1 part |
| Water | 10 parts |

When thoroughly mixed it is applied to the fresh-cut twigs with a brush.³

¹ Peavy, G. W.: Annual report to the forester. Manuscript. 1906.

² Cox, W. T.: Reforestation on the national forests. (U. S. Forest Service, Bul. 98. 1911.)

³ Cunningham, J. C.: Protecting trees from rabbits. (Kansas Agr. Exp. Sta., Cir. 17. 1911.)

Thoroughly spraying the trees immediately after planting and after each heavy rain with the following poison is usually effective in reducing the damage when rabbits are numerous:

| | |
|-----------------|-------------------|
| Strychnine..... | 4 oz. |
| Saccharin..... | $\frac{1}{2}$ lb. |
| Water..... | 10 gals. |

The trees may be coated with various repellants, *i.e.*, materials which are distasteful to rabbits and which prevent them from feeding upon all parts thoroughly coated with the obnoxious material. An effective repellant is one that resists washing off by rain and that can be applied in the form of a spray. Because of its bitter taste, commercial aloes, at the rate of 1 pound to 4 gallons of water, when sprayed on trees will repel rabbits. The common lime and sulphur spray used against scale insects is reported by Cunningham as an excellent rabbit repellant.

4. PROTECTION FROM FIRE

The cost of successful regeneration by either direct seeding or planting is such that it should never be undertaken until adequate provision has been made to protect it from fire. The seeding or planting of small areas surrounded by cultivated fields can be done without seriously considering the fire problem, because of the protection afforded by the surroundings. In the regeneration of larger areas, however, and particularly those surrounded by woodland, the fire problem should be solved before the seeding or planting is begun. The fire hazard is so great in most parts of the United States that the lack of foresight often results in the total loss of the young stand.

Fires that occur on areas recently seeded or planted are surface fires. They burn the surface layer of dry leaves and other litter, herbage and shrubs. Although fires of this character do the least amount of damage in a stand beyond the pole stage, they are always fatal to a young stand. Because of the open character of the site on which seeding and planting is usually done, the inflammable material is usually grass. The hazardous season, therefore, is after the grass dries in the autumn until the new growth starts in the spring. A grass fire that runs uniformly over the ground is nearly always of sufficient intensity to completely destroy a young plantation up to the time that the canopy closes.

5. Methods of Protection

Seeding and planting sites can be protected from fires by one or more of the following methods:

- a. By eliminating the cause of fires.
- b. By the construction of fire lines, roads and trails that prevent fires from spreading from adjacent lands.
- c. By maintaining facilities for fighting fires.

6. Reducing the Fire Hazard by Eliminating the Cause

Nearly all fires are caused by carelessness or the lack of necessary precaution on the part of railroads, farmers, campers, and sportsmen. Most states have laws regarding the careless handling of fire on forest property, but in many instances they are not adequately supported by public sentiment and consequently are more or less ineffective. Public enlightenment on the necessity for protection is necessary for the vigorous application of our present laws. The thorough posting of the area artificially regenerated is always useful in eliminating the cause of fire. The posters should be durable, preferably of cloth, and well printed. They should state the laws in relation to the setting of fire and the penalty of their violation.

7. Reducing the Fire Hazard by the Use of Fire Lines

For the most part, in regions where artificial regeneration is in progress the fires that occur start on adjacent property. When the seeding or planting is protected by an open space over which the fire will not extend there is little danger from fire. In farming regions the surrounding meadows and cultivated fields usually provide ample protection. But when the young stand abuts on an unprotected wood or other site over which fire readily runs, fire lines are necessary and should be constructed as soon as the regeneration is undertaken. A fire line is any kind of cleared strip over which fire will not ordinarily extend (Fig. 31).

Fire lines, as usually made in this country, vary in width from 6 to 60 feet. They are cleared of all inflammable material and kept so during the fire season. The simplest lines are made by plowing a double furrow or by raking a narrow strip free of inflammable material. The wider the cleared strip the more com-

plete is the protection afforded. Fire lines should not be constructed, however, with the idea that fires will be stopped by them under all conditions. Even narrow lines as afforded by trails or roads will stop most surface fires. The width of the line



FIG. 31.— A broad fire line adjacent to a public highway, protecting a white pine plantation.

necessary to stop a fire depends very largely upon the movement of the wind. It is not practical to construct a break wide enough to secure absolute safety when the wind reaches the velocity of 30 or more miles an hour. It is imperative that fire lines be properly maintained. If permitted to become covered with grass and other vegetation in dried condition, they are worse than none at all. A fire line should usually receive attention at least twice a year, *viz.*, just before the autumn fire season and in early spring. Where stumps, rocks, and other obstructions are absent, plowing is an effective method of keeping the area free from vegetation and the resulting inflammable material. When large, continuous tracts are seeded or planted it is often desirable to subdivide the area into from 20- to 40-acre divisions separated from each other by suitable fire lines.

8. Reducing the Fire Hazard by Facilities for Fighting Fire

Even with the most careful attention given to preventing fires from starting and with carefully constructed fire lines, a close supervision is necessary during the dry season in order to detect fires as soon as possible after they start.

Usually on private lands the owner must organize his own system for detecting and putting out fires. The mere fact that a tract is carefully watched vastly increases its safety, as it renders people less careless in handling fire when on or near it. When a fire is once detected the efficiency in handling it and putting it out



Photograph by Conn. State Forester

FIG. 32. — The operation of the hand-pump in fighting a surface fire.

depends primarily upon the time required to reach it. A fire reached in its early stages is easily put out. Fires in a recently planted or seeded area are usually grass fires. They are put out:

- a. By beating.
- b. By the use of sand.
- c. By the use of water.

Small grass fires and other surface fires usually can be beaten out, particularly when the grass is short and there is but little inflammable material. Branches of red cedar or other conifers, old gunny sacks, or strips of canvas serve as efficient beaters. Beating is impractical in a dense growth of brush.

Sand is very efficient in checking and putting out surface fires

on sites sufficiently free from roots and rocks to permit its being quickly dug and thrown on the advancing flames. Loam and heavier soils are less efficient.

When the accumulated litter makes a fire too hot to be beaten out, water if available can be used to good advantage. The water brought to the front of the fire in buckets should be thrown on the advancing flame with a spray pump clamped to a pail (Fig. 32). In this manner of application the water is from 3 to 5 times as effective as when thrown on the fire directly from the pail. A suitable hand-pump will throw a stream from 20 to 30 feet and can be directed to the point where it is most effective.

CHAPTER X

PRELIMINARY TREATMENT OF SEEDING AND PLANTING SITES

INSUFFICIENT attention is given to the treatment of seeding and planting sites in the United States before regeneration is begun. Many of our failures in artificial regeneration can be traced to this cause alone. The conditions of different sites are so variable that instructions regarding their preparation for the reception of seed or young plants can be given only in a general way. When the site is such that it is impracticable, on account of the cost, to bring it into suitable condition for direct seeding, *it is best to forego seeding altogether and plant.*

The treatment of the site prior to seeding and planting relates to:

- a. The soil.
- b. The vegetation.

1. TREATMENT OF THE SOIL

Soils unfavorable for artificial regeneration result from natural conditions or deterioration from misuse. An unfavorable soil is always amenable to improvement. It may call for *the reclamation of land unfit for the production of timber or the tillage of the soil prior to seeding and planting.*

2. The Reclamation of the Soil

The cost of soil reclamation in the United States is usually excessive and is seldom justified in forestry except under special conditions. The cost of draining overwet places, breaking up an impervious substratum, and the fixation of shifting sand is necessarily dependent upon the circumstances surrounding each case. The more important conditions that call for soil reclamation prior to artificial regeneration are as follows:

- a. Excess of soil moisture.
- b. Aridity.
- c. Impervious subsoil.
- d. Excess of organic matter.
- e. Instability.

3. EXCESS OF SOIL MOISTURE

Some species thrive on moist, or even wet, soils. Most species do best on fresh soils. Species acceptable for seeding and planting do not thrive in stagnant water. When there is an excess of soil moisture over that best suited for the species, successful regeneration requires the construction of works for its removal before the regeneration is begun. The removal of excess water can be accomplished by a system of drainage or by its diversion.¹ Swampy ground is always difficult and expensive to handle in artificial regeneration. When the excess water cannot be removed advantageously by diversion or drainage, the only alternative is to throw up mounds or ridges upon which the seed or plants are introduced.² In European practice, heavy limestone and clay upland soils are often ditched before artificial regeneration is begun. Not only is the regeneration more easily attained, but later growth is more rapid and the trees less subject to disease.

Drainage and diversion of water should be done with reference to their effect upon the surrounding woodland, because any radical change in the ground water during the life of the stand usually results in serious injury.

4. ARIDITY

Overarid sites due to climatic conditions can be reclaimed by irrigation. In forestry practice in the United States, irrigation is employed chiefly in the nursery. In the semiarid regions of the West, from Wyoming south to Texas and from Colorado west to California, limited areas are artificially watered for the growth of forest trees. For the most part, however, trees are grown along irrigation ditches, the adjacent fields being used for agricultural crops. Various species of *Eucalyptus* are grown

¹ Schlich, Wm.: Manual of forestry. vol. II. London, 1910.

² Gayer, Karl: Der Waldbau. 4. Aufl. Berlin, 1898.

under irrigation in the semiarid regions of California for the first one or two years after planting.¹ After the trees are once well established on suitable sites they thrive without further irrigation.

5. IMPERVIOUS SUBSOIL

A hard impermeable substratum, 4 feet or less below the surface, is injurious to forest growth, and the closer it is to the surface the more harmful it becomes. An impermeable substratum may be a compact layer of clay or a layer of sand or gravel intermixed with clay, organic matter, or iron oxide. It is sometimes formed by a deposition of lime and mineral salts at a variable distance below the surface. This impermeable layer is called "pan" or "hard-pan." Sometimes it occurs in loose, sandy soil under the action of humic acid.² The pan, however formed, seriously interferes with forest growth by obstructing the free movement of soil water. It prevents seepage to lower levels and checks the ascent of water by capillary action during dry weather. The soil above the pan is alternately too wet and too dry for forest growth. This hard, impervious layer also interferes with normal root development and increases the danger from windfall. Artificial regeneration over a pan is seldom successful.

All methods of soil treatment to overcome the bad effects of the pan are expensive and can rarely be undertaken in the reclamation of land for forest growth in the United States. For the most part, when it interferes with forest growth, shallow-rooted species must be used in the regeneration and low increment should be expected. The only effective method for overcoming its injury is by breaking through the impermeable layer, thus effecting a more uniform distribution of soil moisture and deeper root penetration.

In European practice, when the pan is not too hard or too far below the surface, it is usually broken with heavy subsoil plows specially constructed for this purpose, or by trenching.³ The pan is brought to the surface where it disintegrates under the action of sun and air. If it is 18 inches or more below the surface, it

¹ McClatchie, A. J.: *Eucalypts cultivated in the United States.* (U. S. Forest Service, Bul. 35. 1902.)

² Schlich, Wm.: *Manual of forestry.* vol. II, p. 136. London, 1910.

³ *Ibid.*

can be broken through only in places because of the large expense involved.¹ The modern method for breaking through the pan is by the use of dynamite.

6. EXCESS OF ORGANIC MATTER

The excess of organic matter in the soil is usually in the form of *peat, dry mold, and raw humus*. For the most part, peat soils are now non-productive but eventually, particularly in the northern states and alpine regions, they will form an important area for forest growth. Their reclamation requires drainage, which, by lowering the free ground water, permits the entrance of air and the gradual elimination of the peat. Their present acid condition inhibits the growth of desirable timber. This, however, can be overcome after drainage by the liberal application of lime.

Many upland areas injured by fire and covered with scanty vegetation develop a dense covering of lichens and moss. When these decompose over dry, sandy soil, they form dry mold that is harmful to reproduction. Artificial regeneration, particularly direct seeding, should not be attempted before the reclamation of the land by some method of cultivation which mixes the dry mold with the mineral soil. Raw humus often accumulates to excess in coniferous forests, so that when the stand is felled it interferes with immediate reproduction either by direct seeding or by planting. It is composed of twigs, leaves, and other litter, which from too much or too little moisture or the lack of adequate heat have not decomposed. Raw humus rapidly disappears on exposure to sunlight. A delay in artificial regeneration for a year after the forest is felled will usually suffice to make the seeding or planting possible, although in direct seeding it may be necessary to precede it by working the soil.

7. SOIL INSTABILITY

Unstable soil must be fixed before seeding or planting is attempted. Soil fixing relates to the treatment of unstable soil of steep slopes and dunes. Moving water renders the soil on all slopes more or less unstable, the degree of instability depending upon the character of the precipitation and the exposure of the soil. The degree of instability depends also upon the velocity of the wind and the amount of binding material, such as clay and humus, that is present in the soil.

¹ Heyer, Carl: *Der Waldbau oder die Forstproduktenzucht*. 5. Aufl., I. Bd. Leipzig, 1906.

8. Overcoming Soil Instability on Slopes.—In regions of heavy precipitation over short intervals of time, exposed soil on steep slopes becomes very unstable because of land slipping and surface erosion. This is particularly true when shallow soils are underlaid by impervious rock. The harm done is not only in reducing the productive power of the land, but also in covering the soil lower down with accumulations of gravel, sand, and other debris. *Where the soil is likely to become unstable when exposed, it should be kept permanently in forest growth.* Only selection cutting should be permitted, and the reproduction attained while a crop is still on the ground. As a rule, grazing should not be allowed. Where excessive soil movement has taken place, regeneration often becomes extremely difficult. *It is necessary to fix the soil that still remains before any attempt is made at seeding and planting.* Soil instability is frequent in mountainous regions where the forest has been over-cut, repeatedly burned, or over-grazed. The reclamation of denuded and excessively eroded slopes can be attained only through large expenditures in erecting protective works for the control of surface water. Such works have been constructed on an extensive scale in denuded portions of the mountainous regions of southern Europe, and under their protection successful artificial regeneration has been accomplished. The lack of proper protective measures in many of the mountain forests of the United States is already bringing about conditions of soil instability which will ultimately call for vast expenditures to control the surface flow of water before regeneration can be attained.

The control of surface water on barren slopes in order to increase soil stability *can be attained only by checking the velocity with which it flows over the surface.* This can be accomplished by either of the following two methods or by both combined.

1. By the construction of various types of revetment works or retaining walls to hold back earth, gravel, and boulders. These obstructions are built across the beds of streams and their tributaries at suitable intervals. They are constructed of masonry, timber, and earth. Trees are often felled into the bed of the stream and fences of one sort or another thrown across. The cutting of banks is usually controlled by planting willows or cottonwoods. By means of trenches and other conduits, the water is distributed over as wide a surface as possible.

2. By the reduction of the gradient. Any reduction in the gradient causes a corresponding decrease in the flow of water and a consequent decrease in soil erosion. The only method of reducing gradient is by a system of terraces which can be undertaken only at large expense.¹

Ordinarily, works of the character mentioned cannot be undertaken by private enterprise. In the full utilization of many of our present denuded mountain lands, however, they will be necessary. After a forest has been once established, the vegetation itself prevents further soil instability.

9. Overcoming Soil Instability of Dunes. — Along the Atlantic and Pacific coasts and on the shores of the Great Lakes are a number of extensive areas of sand dunes. Inland sands of shifting nature also occur in widely separated parts of the country, but more particularly in the semiarid Southwest and in Nebraska and the Dakotas. For the most part, these areas of shifting sand were originally covered with vegetation. Through excessive grazing, frequent fires or forest destruction, the surface soil became exposed to the wind and weather, and, as a result, their instability increased. The soil must be deficient in binding material, such as clay and humus, and composed of moderately fine particles in order to form dunes. When such soils become dry, they blow about and form moving or wandering dunes in the form of ridges or hills. The form and extent of these accumulations depend upon the soil and the force and direction of the prevailing winds.

Sand dunes have been comprehensively treated by Gerhardt² and many other writers in recent years. Extensive dune areas in France,³ Germany, and other European countries have been reclaimed and covered with productive forests by artificial means. Dune regions in the United States have been studied by Scribner,⁴ Hitchcock,⁵ and Westgate.⁶ The most extensive attempts at reclamation have been in the Cape Cod region of Massachusetts.

¹ Wang, Ferdinand: Fortschritt und Erfolg auf dem Gebiete der Wildbachverbauung. Wien, 1890.

² Gerhardt, Paul: Handbuch des deutschen Dünenbaues. Berlin, 1900.

³ Brown, J. C.: Pine plantations on the sand-wastes of France. Edinburgh, 1878.

⁴ Scribner, F. L.: Sand-binding grasses. (Yearbook, U.S. Dept. of Agr. 1898.)

⁵ Hitchcock, A. S.: Methods used for controlling and reclaiming sand dunes. (U. S. Bur. Pl. Ind., Bul. 57. 1904.)

⁶ Westgate, J. M.: Reclamation of Cape Cod sand dunes. (Ibid., Bul. 65. 1904.)

10. **WANDERING DUNES.** — Dunes pass through a progressive series of changes. Along the coast and large inland bodies of water they originate near the beach and travel inland. These wandering dunes have a more or less definite form and an abrupt slope to the lee. They travel with the wind at a rate depending upon its velocity and constancy. In the course of time as the dune recedes from the beach a new one is formed near the shore until a whole series finally appears as undulating sand ridges or hills, often extending several miles inland. In their progress they overwhelm all forms of vegetation, often burying forests that are 40 or more feet in height. So long as a dune is active it supports but little vegetation as the shifting sand prohibits its becoming established.¹ Inland dunes are chiefly due to excessive grazing or other factors which effect the removal of the vegetation.² They often start as blowouts at the top of hills. The blowouts become more and more enlarged through undermining the surrounding vegetation and in time a wandering dune may result. The great loss from active dunes is not only in their non-productive character but also in their encroachment upon arable land, the overwhelming of forests, cultivated fields, and other valuable property.

11. **FIXED DUNES.** — As the wandering, or active, dunes move from their place of origin, whether it be on the beach or on an inland sand hill, the action of the wind becomes less forcible. As a result, the movement of the sand becomes more intermittent and slower and vegetation has a better chance to become established. During wet periods seeds germinate and gradually the active dune is changed into a fixed dune. If the vegetation, although scanty at first, is undisturbed, it becomes denser and in regions of adequate precipitation it culminates in a forest. Thus, we find many of our coast forests on fixed dunes.

Any factor which adversely disturbs the vegetation may reconvert a fixed dune into a wandering one. Thus, large areas, both in this country and abroad, which were formerly fixed dunes covered with forests have, with their removal, become wandering dunes.

¹ Cockayne, L.: Report on the dune-areas of New Zealand. (Dept. of Lands. Wellington, 1911.)

² Bates, C. G. and Pierce, R. G.: Forestation of the sand hills of Nebraska and Kansas. (U. S. Forest Service, Bul. 121. 1913.)

In the successful management of fixed dunes and sand hills that are liable to blowouts the soil must not be impoverished or exposed to the free sweep of the wind. This can be attained best by forest growth, rigid protection from fire, the elimination of clear-cutting, and the restriction of grazing. The forest should always be kept densely stocked to the leeward.

12. Artificial Regeneration in Dune Regions. — When dunes and inland sands through mismanagement, the removal of the litter, or other causes, have become unstable, it is often necessary to reclaim them by artificial means. In many cases it also becomes necessary to check the progress of dune formation in order to prevent them from covering cultivated fields and other valuable property. *Permanent stability can be attained only when the sands liable to shift are covered with forest.* When natural regeneration cannot be relied upon or when it is too slow, seeding and planting must be undertaken after the sands are temporarily fixed.

In order to fix shifting sand *permanently*, two distinct operations are usually necessary:

- a. Cutting off the supply of sand and temporarily holding the soil in place.
- b. Establishing the forest.

13. CUTTING OFF THE SUPPLY OF SAND AND TEMPORARILY HOLDING THE SOIL IN PLACE. — In the preliminary treatment of inland sand, the blowouts on sand hills from which it originates must be protected. This is usually done by covering them with brush, sod, or other litter, or by the construction of fences to break the force of the wind.

In coastal dune regions the sand washed up by wave action under normal conditions is blown inland by every sea breeze and piled in a continuous ridge following the contour of the shore line. This is called the foredune and is of the greatest importance as it not only protects the land from the sea but also tends to prevent the sand from blowing farther inland. In all reclamation work attention is directed first to the development and maintenance of the foredune in order to cut off the further supply of sand from the sea. In cases where the foredune is well shaped and fixed, the entire dune area back of it is in its most stabilized form. When the foredune is ill-formed, low, and broken the sand from the sea passes over it and the area beyond may be very unstable. The first step, therefore, is to reconstruct and stabilize

the foredune. The foredune is constructed at a distance of from 30 to 100 yards from the shore. It must be high enough to arrest the forward movement of the sand. Its efficiency results from the fact that, although the wind will move sand along level or sloping ground, it will not lift it above a certain height.

The usual practice in the artificial formation of a foredune is to break the wind by erecting a suitable fence parallel to and at the proper distance from the coast. The forward movement of the sand is arrested, part being deposited in front of the fence while the remainder passes through the openings and comes to rest in the comparatively quiet area beyond. As soon as the fence is nearly covered by the accumulated sand it is removed and re-erected on the top of the developing dune. This process is continued until the sand, continually washed up by the waves, is no longer carried over the crest of the dune. As the foredune develops it often becomes necessary to erect an additional fence of brush or other material on its leeward side. The aim should be to force the dune to develop a moderate slope on both faces as this is essential to its permanency. As soon as the dune has been raised to the proper height attention can be given to fixing the sand temporarily on the area behind it. As a rule, the foredune must be from 25 to 35 feet in height. The slope to the windward is usually from 4° to 14° and to the leeward from 20° to 30° . After the dune has reached the proper size it must be given close attention in order to keep it in repair. This is accomplished by planting sand-binding plants, covering the surface with litter which prevents the wind from reaching it, or by constructing a network of brush fences over it.

Because of the salt spray and high wind velocity the foredune cannot usually be planted with trees. In order to keep it in place permanently the best results are attained by planting various grasses and sedges which develop long, heavy rootstocks. Although many species have been used for this purpose, the common beach grass (*Ammophila arenaria*) has proved most effective in this country. This grass grows naturally in most of the dune regions of both this country and Europe. It spreads rapidly by means of creeping underground stems or rhizomes. Beach grass cannot be established by seeding. The heavy rootstocks or underground stems are gathered either in the fall or in the early spring and reset immediately. Plants should be 2 years old

when set, and the rootstock should show two nodes at the base. The arrangement and closeness of the planting vary greatly under different conditions. Most commonly the plants are set at 1-foot intervals in rows from $1\frac{1}{4}$ to $1\frac{1}{2}$ feet apart. The dune is kept in suitable form chiefly through the arrangement of the planting.

Kellogg¹ reports the following procedure in establishing beach grass on the Pacific coast. The grass is planted between September and March when the sand is moist. Two-year old plants are collected by pulling up the rootstocks by hand and dividing



Photograph by U. S. Forest Service

FIG. 33.— A plantation of beach grass on shifting sand.

them into sections with one or two nodes on each piece. They are set out in rows from 12 to 18 inches apart at right angles to the prevailing wind, the plants of one row alternating with those of the next. The planters usually work in pairs. One man inserts a long, straight, heavy spade into the wet sand and presses it to one side, thus making a V-shaped opening. The other inserts from 2 to 4 plants into the opening which is closed by the first man inserting the spade at one side and pushing the soil firmly against the plants (Fig. 33).

¹ Kellogg, F. B.: Sand dune reclamation on the coast of northern California and southern Oregon. (Proc. Soc. Am. For., vol. X, p. 41. 1915.)

The establishing of a suitable grass cover cannot usually be attained for less than from \$30 to \$75 per acre. In time shrubs and other vegetation come in on the leeward side of the foredune, rendering it more stable and decreasing the cost of maintenance. After the foredune has been formed and adequately fixed the important work of planting in its lee should be undertaken. This should have for its object the ultimate development of a forest. When left to themselves these sandy stretches gradually become covered with vegetation, but the process is so slow that the only practical method for reclamation is *to fix the sand by planting sand grass or by other means and after it is sufficiently stable to set out young trees*. In fixing the sand behind the foredune, brush, sod, and similar materials are often useful.

14. ESTABLISHING THE FOREST. — After the sand in the lee of the foredune is adequately fixed the site is ready for forestation. As a rule, coniferous trees are preferable. However, in some instances rapidly-growing deciduous species such as birches and alders are used on special sites. Direct seeding is rarely successful due to the adverse conditions of the site. Three or 4-year transplants should usually be used. They should be closely spaced and all failures reset the following season. The species acceptable for use depend upon the locality. Pitch pine has been used to a large extent in fixing the coast dunes in New England.¹ Blue gum, Monterey cypress, and acacias have proved useful in places along the Pacific coast.

15. The Tillage of the Soil

The tillage of the soil necessary for successful regeneration depends upon the circumstances of each particular case. The more thoroughly the soil is prepared for the reception of the seed or the young plants the less is the loss from unfavorable weather conditions and the more vigorous the growth. Nearly always, particularly in direct seeding, some form of soil loosening or tillage is necessary.² Mayr³ states that *all unfavorable sites not*

¹ Westgate, J. M.: Reclamation of Cape Cod sand dunes. (U. S. Bur. Pl. Ind., Bul. 65. 1904.)

² Cox, W. T.: Reforestation on the national forests. (U. S. Forest Service, Bul. 98. 1911.)

³ Mayr, Heinrich: Waldbau auf naturgesetzlicher Grundlage. Berlin, 1909.

amenable to soil preparation should be planted. Heyer¹ emphasizes the particular need of thorough soil preparation on all but the most favorable sites whenever regeneration by direct seeding is undertaken and points out its advantages due to fewer failures in the stand and better growth.

Two centuries of forest culture in Europe have conclusively demonstrated that *successful artificial regeneration is chiefly a matter of soil management.* The surface soil should be neither too wet nor too dry, too loose nor too compact. It should be fresh and free from excessive litter and herbage.

The roughness of the surface, the compactness of the soil, and the presence of roots, stones, and other obstructions that usually characterize forest soils make special implements and tools often desirable. This is clearly shown in the great variety of implements and tools that have been devised for the cultivation and loosening of the soil in forest culture in Europe. Schlich² states that a considerable number are of doubtful utility, which is fully in accord with the experience of the author who has tested a large number of tools and implements of European origin that have been recommended as useful in the cultivation of forest soil. The introduction of novel tools and implements can be recommended only after their efficiency has been thoroughly tested and it has been proved that their use results in a considerable saving of labor or in better work. As a rule, the average laborer will do more and better work with tools and implements with which he is familiar than he will with imported ones, the use of which he has first to learn. The changing of soil-working tools, therefore, for each change in soil conditions is impractical and unnecessary. In general, in the United States we should rely upon the ordinary agricultural tools and implements of each particular locality, modified when necessary to resist the adverse conditions of forest soils.

In many cases, however, tools useful in agriculture cannot be used in forest tillage. We have not yet developed tools in the United States for the special purpose of working forest soil. Attention is called on the following page to a number of foreign tools that have proved most useful in soil preparation for seeding

¹ Heyer, Carl: *Der Waldbau oder die Forstproduktenzucht.* 5. Aufl., I. Bd. Leipzig, 1906.

² Schlich, Wm.: *Manual of forestry.* vol. II, p. 168. London, 1910.

and planting. It is reasonably certain that similar tools must be used more and more in the United States in preparing adverse sites for artificial regeneration.

16. DEEP TILLAGE

Deep tillage can be attained only by use of the plow, spade, or grub hoe. The use of the ordinary plow is restricted to comparatively level areas, fairly free from stones, large roots, and other obstructions. Forest plows are usually fitted with heavy wheels, by means of which they can be lifted over obstructions of various sorts. Plows of this construction are illustrated in Alemann's forest plow and Eckert's forest plow,¹ both of European origin. Weinkauff² has recently designed a forest plow with a roller which lifts it over roots, stones, and other obstructions.

Because of the expense involved, plowing the entire area should not be attempted except under conditions which make regeneration uncertain or difficult without it. Such conditions are present usually only *on sites where the herbaceous vegetation forms a continuous turf, as in prairie regions and old pastures.*

Seeding and planting should never be undertaken in prairie regions without thoroughly breaking up the sod some time in advance of the forestation. A year or two of cultivation prior to the seeding or planting is preferable. On such sites planting is far more successful than direct seeding.

The advisability of plowing old pastures and other sod-covered areas in naturally forested regions depends upon:

- a. The cost involved and the thoroughness with which the work can be done.
- b. The species to be used in the regeneration.
- c. The quality of the site, particularly in reference to surface soil moisture.
- d. The character of the regeneration, *i.e.*, whether direct seeding or planting.

A part of the cost of plowing is balanced by the less labor involved in the seeding or planting. Its necessity decreases with the size of the stock used in planting, its hardiness, rapidity of growth, and

¹ Heyer, Carl: Der Waldbau oder die Forstproduktenzucht. 5. Aufl., I. Bd., S. 118, 119. Leipzig, 1906.

² Weinkauff, Forstmeister: Neue Bodenbearbeitungsmethoden und Zukunftswerkzeuge. (Forstw. Centralblatt, S. 46-48. 1910.)

depth of early root penetration. When the undisturbed turf is likely to cause the surface soil to become extremely dry, both from the withdrawal of water to sustain the dense vegetation and from its cutting off the percolation of the precipitation into the soil, plowing is advantageous.

The chief advantages derived from plowing or other deep tillage of the soil are as follows. Against these must be set the large increase in the initial cost.

In direct seeding:

- a. The seeds come into intimate contact with the mineral soil and as a consequence germination is more uniform and certain.
- b. The young plants become more quickly established through an increase in soil moisture and plant food.
- c. The seedlings are not so likely to be smothered or crowded out by other vegetation.

In planting:

- a. Smaller and younger stock can be used in the regeneration.
- b. Because of the more rapid growth and less danger of loss a wider spacing is permissible.
- c. The danger from late and early frosts is lessened.

In recent years much controversy has arisen regarding the efficiency of deep tillage when the soil is turned over by plowing. Möller,¹ after ten years of repeated experiments, clearly shows the benefits of raw humus (dry turf) on the growth of conifers in sandy soils. From his investigations the turning over of the soil with the plow so as to bring to the surface a layer of 3 or 4 inches of non-humous sand is very bad practice; so also the seeding or planting of pine in furrows from which the humus has been removed is poor practice. The better practice is the thorough cultivation and loosening of the soil by *mixing the surface humus and sand together*. Möller contends that the worse kinds of raw humus through proper treatment become the best kinds of fertilizer for pine. Among the roller plows the form devised by Weber which works the soil to a depth of 12 inches and thoroughly loosens it without turning under the surface humus is one of the best. The Danish rolling harrow² works on the same principle but loosens

¹ Möller, Alfred: Demonstration und Vortrag im Versuchsgarten der mykologischen Abteilung. (Zeitschrift f. Forst- u. Jagdwesen, S. 330-332. 1912.)

² Metzger, Forstassessor: Einiges über die dänische Rollegge. (Allgemeine Forst- u. Jagd-Zeitung, S. 279-283. 1900.)

the soil to less depth. It is believed that implements patterned somewhat after the better of the European forest plows of the wheel and roller types could be advantageously introduced into the United States.

Artificial regeneration on heaths is always very difficult, due to the mineral soil being too poor to support satisfactory growth. The organic matter overlying the mineral soil contains humic acid and other sour humous constituents deleterious to tree growth. The difficulty is often increased by the presence of pan at shallow depths. Greve¹ recommends the burning of the surface as the first operation, care being taken to injure the organic matter in the surface soil as little as possible. The surface layer of organic matter is then thoroughly mixed with the mineral soil beneath. It is usually useless to attempt artificial regeneration on heaths without previous soil preparation.

17. SHALLOW TILLAGE

Various types of harrows, drags, cultivators, hoes, and rakes are used in working forest soil to a depth less than 5 inches. Harrows, drags, and cultivators with rigid frames and teeth are not suited for working forest soil. The implement should be of the roller type or the teeth should be flexible. Weinkauff² recommends the spring harrow as the most efficient implement for working ordinary forest soil to a depth less than 5 inches either as an aid to natural regeneration or previous to full seeding. The latter implement has been used by the U. S. Forest Service in soil preparation for full seeding on the National Forests. In Europe the Danish roller harrow is used for the same purpose. Rakes and hoes in great variety are used in the shallow tillage of forest soil. As a rule, light and medium soils are worked immediately before the seeding or planting is begun. Heavy soils, particularly those containing considerable raw humus, are worked in the autumn and left exposed to the action of air and frost over winter.

¹ Greve, Forstmeister: Flachbearbeitungs-Verfahren bei Heideaufforstungen. (Zeitschrift f. Forst- u. Jagdwesen, S. 581-604. 1906.)

² Weinkauff, Forstmeister: Neue Bodenbearbeitungsmethoden und Zukunftswerkzeuge. (Forstw. Centralblatt, S. 46-48. 1910.)

18. TREATMENT OF THE VEGETATION

Vegetation is seldom entirely absent from the seeding or planting site. Artificial regeneration is most easily attained under an open overwood or nurse crop. It is most difficult on areas covered with grass or other dense surface vegetation.

Overdense vegetation is harmful to artificial regeneration for one or more of the following reasons:

- a. Because of its more vigorous growth it overtops and suppresses the young plants.
- b. It increases the danger from insect and fungous attacks.
- c. Through competition it decreases the soil moisture available for the young plants.

19. Treatment of Recently Cut Areas

Areas that have been recently cut are usually clear of grass and other forms of herbaceous vegetation and shrubs that are particularly harmful to reproduction. Such areas are, therefore,



FIG. 34. — Planting white pine on a recently felled area. The tops and other litter on the ground. Near New Haven, Conn.

easily regenerated by seeding or planting. The exposing of the soil to the sun causes a rapid decomposition of the humus and a large amount of soluble plant food is liberated. The plants quickly become established and make rapid juvenile growth. They should be set in the mineral soil beneath the litter which not

only serves as a mulch to decrease the loss of soil moisture through evaporation and lessens the danger of erosion but by its decay adds materially to the organic richness of the soil (Fig. 34).

The amount of litter on the surface and organic matter in the mineral soil is, however, sometimes so great immediately after a stand has been felled that it is inimical to direct seeding. Germination is always best in mineral soil. When direct seeding follows clear-cutting, therefore, it should be delayed until the organic matter has partially decomposed or the area should be cultivated in order to expose the mineral soil. It is sometimes advisable to burn over the area immediately before seeding. This is particularly true when there is an excess of organic matter and when the loss from burning will be more than compensated by the exposure of the mineral soil and by the supply of plant food immediately liberated.

20. Treatment of Areas Covered with Herbaceous Vegetation

Idle farm lands, denuded lands subject to frequent fires, and stands of open timber usually have a more or less rank surface growth of grass, ferns, or other herbaceous vegetation. *It is nearly always desirable to burn over such areas in the late autumn or early spring while the dried grass and other herbaceous material is in suitable condition for burning.* This procedure facilitates regeneration and reduces the danger from insects and other pests. The advantages usually more than compensate for the loss to the soil of the material burned. The ash, in providing immediately a small amount of available plant food, is often of advantage.

When the soil is covered with a thick matting of grass it may be necessary to remove the sod before the regeneration is undertaken. This can be done by plowing. Young plants make much more rapid growth on plowed land and the loss during the first few years is less. Whether this is always of advantage is a debatable question. In some cases it appears to be followed by evil effects, particularly where the trees are closely spaced. Thus, white pine planted in plowed fields on first quality sites usually grows rapidly and evenly. As the canopy closes, the intensity of the competition causes all the trees to suffer alike, and the ultimate result is very disastrous unless thinning is begun very early. On the other hand, when the trees are set on un-

plowed land the young trees from the first show considerable variation in height growth, and, as a result, when the canopy closes the competition is not so intense and early thinnings are not so essential.

21. Treatment of Areas Covered with Shrubby Vegetation

Vast areas in the National Forests and in other parts of the United States are covered with a growth of low woody plants. The value of this vegetation lies chiefly in the protection which it affords the soil and in its effect upon the surface flow of water.

Although in some localities, as in the foothills of southern California, this type of vegetation occurs where the site factors are too adverse for forest growth, in the aggregate enormous areas throughout the country that are perfectly capable of sustaining forests of large economic importance are given over to an almost worthless growth. Thus, in eastern Pennsylvania large areas are covered with a dense growth of scrub oak (*Quercus nana*) seldom over 6 to 10 feet in height.

The problem of transforming these shrub-covered areas into profitable forest is one of large importance. In semiarid regions where the natural vegetation is chaparral, the transformation can seldom be made without first removing the chaparral. Burning or cutting it does not suffice as it quickly coppices from the root and overtops the young trees when planted. Planting or seeding beneath the chaparral seldom, if ever, results in a successful stand. It must usually be grubbed out root and branch, which necessitates an expenditure of from \$50 to \$100 per acre, a sum rarely, if ever, justified under present conditions.

In the brush-covered areas of more humid regions that were formerly covered with forest, the problem is not so difficult. If protected from fire, they ultimately become reclothed with timber. The time required, however, is often so long that it is desirable to bring the regeneration about by artificial means. When the brush cover is open and composed of thin-foliaged plants regeneration is often possible without the removal of the vegetation. The problem of artificial regeneration is far more difficult on areas covered with scrub oak and other species that form dense thickets in almost pure stands. Large transplants of hardy, rapidly-growing species should be used. Direct seeding should be avoided.

22. Treatment of Areas Covered with an Overwood

Artificial regeneration by either seeding or planting is usually easily accomplished under an overwood of suitable density. The



FIG. 35. — A plantation of white pine established under an overwood of oak and chestnut. Near New Haven, Conn.

overwood serves as a nurse crop for the introduced plants while they are becoming established (Fig. 35). When the overwood is dense artificial regeneration is not successful. A portion of the stand must be harvested before seeding or planting is undertaken.

CHAPTER XI

ESTABLISHING FORESTS BY DIRECT SEEDING

1. GENERAL CONSIDERATIONS

DIRECT seeding differs from natural seeding in that the seed is brought to the site and scattered by man instead of being self-sown. In natural seeding a large proportion of the seed is destroyed by animal life and by adverse climatic conditions. Under the very best conditions, only a small percentage of the seed which falls from the trees during the autumn and winter germinates. Among the seedlings that result from the germination only a few grow and become established.

We cannot hope to distribute as much seed in artificial regeneration as is ordinarily scattered in natural seeding. *The necessary diminution in the amount of seed used per unit of area must be compensated for by better conditions for germination, establishment, and early growth.* The chief factors which determine the degree of germination and establishment and the rate of early growth on a given site are as follows:

- a. The quality of the seed.
- b. The species.
- c. The vegetative cover.
- d. The condition of the surface soil.
- e. The freedom of the site from seed-eating birds and rodents.
- f. The quantity of seed sown per unit of area.
- g. The time of sowing.
- h. The depth of covering.

Only seed of the highest quality should be used in direct seeding. Seed in which the viability has been weakened by long storage should be confined to nursery work where the environmental conditions that influence germination and early growth are under better control.

Seeds containing a large amount of reserve food and germinating in the early spring are better adapted for direct seeding than small seeds which are slow to germinate and which produce plants of

slow juvenile growth. Hickory, oak, and beech are usually regenerated by direct seeding. Because of the relatively small size of most coniferous seeds and the slowness of early growth, direct seeding is less certain to result in favorable stands. Some species, however, are useful on favorable sites, more especially those such as western yellow pine, white pine, and Douglas fir from which the seeds can be obtained at relatively low cost. The cost of the seeds of red pine and jack pine prohibits their use in direct seeding.

A high cover, if not too dense, is advantageous in direct seeding provided there is little or no ground cover. The shade protects the surface soil from rapid changes in moisture and temperature, thus improving conditions for germination. In many parts of Europe beech is regenerated by direct seeding under oak.

A low cover formed from a dense growth of chaparral, ferns, or grass is a decided disadvantage. It not only provides a safe retreat for rodents and other seed-eating animals but, as soon as germination takes place, directly competes with the young seedlings. The roots of grass and of similar low vegetation draw their nutrients and water supply from the surface layers of the soil, and the intensity of the competition usually proves fatal to the introduced plants.

The chief advantages that result from cultivating the soil are as follows:

- a. It improves the moisture conditions by permitting the precipitation to enter with greater freedom.
- b. It facilitates aëration, or the freedom with which air can enter.
- c. It renders the soil warmer.
- d. It enables the roots of the young seedlings to enter the soil more easily, penetrate to greater depth, and thus become more quickly established.
- e. It induces greater chemical activity, which results in the liberation of an increased amount of available plant nutrients.

Under no condition should direct seeding be undertaken until it is reasonably certain that the seed will not be destroyed before germination takes place. The aim in direct seeding should be to secure a stand that is neither too open nor too dense. It should be sufficiently close to form a crown cover at a reasonably early date and, at the same time, give each tree the best growing space to meet its demands for development.

The time of sowing has a direct bearing upon the degree of success attainable in direct seeding. In a country as large as the United States with its great variety of economic species and wide diversity in climatic conditions, no particular season can be said to be the best time for direct seeding. The time of sowing depends chiefly upon:

- a. The characteristics of the species.
- b. The climatic conditions.

Seeds maturing before midsummer should be sown at once because of the difficulty of keeping them until the following spring. Were it not for the danger of being destroyed either by animal life or by adverse climatic conditions while lying on the ground over winter, direct seeding in the autumn would be acceptable for all autumn-maturing seeds. All species which naturally germinate in the spring can be sown either in the autumn or in the spring. Seeds which can be easily stored with little danger of deterioration and at small cost are sown in most localities in the early spring. Because of their rapid deterioration when stored, birch, alder, and fir seeds are often sown in the autumn. Chestnut deteriorates rapidly under storage and, when the seed can be protected from animal life, should be sown in the autumn. Walnut, hickory, oak, and beech are sometimes sown in the autumn.

In the more southern parts of the United States the season of the most abundant rainfall is a determining factor in seeding. On the Pacific coast where the rainy season is in winter, direct seeding should be done in January or February or in late autumn in order that the seed coats may become thoroughly soaked and be in condition for germination during the first warm days of spring. Early seeding is very important in order that the young plants may become well established before the summer drought begins.

Insufficient covering is one of the chief reasons why so few of the viable seeds in natural regeneration germinate and become established. Only a comparatively small percentage of the total fall of seed is carried by the winter and spring rains into the mineral soil or even down to it. If the cover is too thin, its full value as a protection against the drying and carrying away of the seed by wind, water, and animal life is not fully attained. If too dense, germination is retarded or it may fail altogether.

Loose and dry soils permit of a comparatively deep covering over the seed while heavy and wet soils require a shallow covering. On sites exposed to the full action of the sun the covering should be thicker than on shady sites. On average sites the depth of covering should not exceed from 1 to 3 times the diameter of the seed. The following table shows the average depth of covering for a number of species:

| | Inches | | Inches |
|---------------|---------------|------------------|---------------|
| Walnut..... | 3 | Ash..... | $\frac{1}{4}$ |
| Hickory..... | 2 | Maple..... | $\frac{1}{4}$ |
| Oak..... | 1½-2 | White pine..... | $\frac{1}{4}$ |
| Elm..... | $\frac{1}{2}$ | Yellow pine..... | $\frac{1}{2}$ |
| Chestnut..... | 1½ | | |

2. METHODS OF DIRECT SEEDING

The various methods of direct seeding may be classed under the following heads:

- a. Full seeding.
- b. Partial seeding.

In full seeding the seed is distributed more or less evenly over the entire area to be stocked. In partial seeding only definite portions of the area are seeded. In the latter case the cost of regeneration on sites that require soil preparation is usually less, due to the smaller quantity of seed required and the necessity for cultivating only a portion of the total area.

3. Full Seeding

Contrary to general opinion, full seeding when properly done is usually expensive, often more so than partial seeding or even planting. Only in exceptional instances where the large amount of seed required can be obtained at a relatively low cost and where it can be sown without preliminary treatment of the site is it possible to attain successful regeneration at a low cost by full seeding. At the present prices of forest tree seed in the United States the cost of the seed alone prohibits full seeding with many economic species. Even with relatively inexpensive seed this manner of regeneration must usually be confined to recently cleared and burned areas that require little or no cultivation. Failures have resulted from most attempts at full seeding in this country because *we have used far too little seed per unit of area and have not given enough attention to the preparation and protection of the site.*

4. AMOUNT OF SEED REQUIRED

The following figures given by Schlich¹ show the average amount of seed used in full seeding in European practice. The amounts are in pounds per acre.

| | | | |
|--------------------|------|------------------|------|
| | Lbs. | | Lbs. |
| Oak..... | 550 | Silver fir..... | 40 |
| Beech..... | 150 | Spruce..... | 10 |
| Ash and Birch..... | 30 | Scotch pine..... | 6 |

Maw² gives the following as the average amount of seed required for use in full seeding in England:

| | | | |
|-------------------|------|------------------------|------|
| | Lbs. | | Lbs. |
| Oak..... | 900 | Scotch pine..... | 6 |
| Beech..... | 150 | Norway spruce..... | 8 |
| Norway maple..... | 45 | Silver fir..... | 60 |
| Ash..... | 35 | Sitka spruce..... | 4 |
| Birch..... | 10 | Western red cedar..... | 2 |

The following table shows the amount of seed recommended by different authors for full seeding on average sites in German practice. It also shows that practitioners do not agree on the amount of seed best to use.

| Species. | Amount of seed per acre recommended by | | | |
|----------------------|--|------------------------|------------------------|--------------------------|
| | Mayr, H. ¹ | Heyer, C. ² | Gayer, K. ³ | Burekhardt. ⁴ |
| Scotch pine..... | 8.92 lbs. | 7.14 lbs. | 7.14 lbs. | 5.36 lbs. |
| Norway spruce..... | 3.57 " | 12.25 " | 12.85 " | 12.05 " |
| Silver fir..... | 4.46 " | 37.48 " | 62.55 " | 49.06 " |
| European larch..... | 8.92 " | 12.85 " | 17.13 " | |
| Pedunculate oak..... | 367 qts. | 239 qts. | 401 qts. | 304 qts. |
| Beech..... | 110 " ⁵ | 80 " | 201 " | 128 " |
| European ash..... | | 36.79 lbs. | 44.6 lbs. | 33.9 lbs. |
| European birch..... | | 30.1 " | 44.6 " | 32.11 " |
| Maple..... | | 44.6 " | 35.68 " | 26.76 " |

¹ Mayr, H.: *Waldbau auf naturgesetzlicher Grundlage*. S. 383. Berlin, 1909.
² Heyer, Carl: *Der Waldbau oder die Forstproduktenzucht*. I. Bd., S. 176. Leipzig, 1906.
³ Gayer, Karl: *Der Waldbau*. S. 321. Berlin, 1898.
⁴ Burekhardt, Heinrich: *Säen und Pflanzen*. Trier, 1893.
⁵ Only 18 quarts per acre in full seeding under an overwood.

¹ Schlich, Wm.: *Manual of forestry*. vol. II, p. 157. London, 1910.
² Maw, P. T.: *The practice of forestry*. pp. 140-141. Brockenhurst, Hants, 1909.

The present tendency abroad is toward a smaller amount of seed per unit of area and better protection and soil preparation. Frömbling,¹ however, warns against the use of too few seeds and the consequent reduction in density of the young stand. He contends that dense stands call more rarely for extensive repairs; they cover the soil, furnish earlier intermediate harvest and more valuable final harvest, and the saving at the start prevents final waste.

Full seeding has been practiced only to a limited extent in the United States and with but few species. For the most part it has been by broadcasting coniferous species on uncultivated sites. Poor results have been due to four primary causes:

- a. The use of insufficient seed.
- b. The destruction of the seed by rodents.
- c. Poor germination due to adverse seedbeds.
- d. The death of the seedlings from summer drought.

In 1911 the following amounts of seed per acre were used in full seeding on some of the National Forests:

| | Lbs. |
|--------------------------|------|
| Douglas fir..... | 1½-3 |
| Western yellow pine..... | 6-10 |
| Western red cedar..... | ¾-¾ |
| Sitka spruce..... | ½-¾ |

The following table is a summary of our present knowledge of the average amount of fresh seed required per acre in full seeding in the United States. Where data derived from experience in this country are insufficient, the figures are based upon the experience of other countries.

| | Lbs. | | Lbs. |
|--------------------------|-------|-------------------|---------|
| White pine..... | 5-9 | Red oak..... | 400-600 |
| Red pine..... | 4-6 | White oak..... | 600-800 |
| Western yellow pine..... | 8-14 | Chestnut..... | 200-350 |
| Pitch pine..... | 4-6 | Beech..... | 50-150 |
| Loblolly pine..... | 4-6 | Cherry birch..... | 10-20 |
| Red spruce..... | 4-8 | Tulip..... | 20-30 |
| Sitka spruce..... | 3-6 | Black cherry..... | 10-25 |
| Eastern hemlock..... | 3-6 | Black locust..... | 6-8 |
| Western hemlock..... | 4-6 | Sugar maple..... | 15-25 |
| Douglas fir..... | 6-12 | Box elder..... | 20-30 |
| White fir..... | 20-35 | White ash..... | 15-25 |
| Western red cedar..... | 1½-5 | | |

¹ Frömbling, E. W.: Saat oder Pflanzung? (Forstw. Centralblatt, S. 253-271. 1910.)

5. IRREGULARITY IN FIELD GERMINATION

In full seeding germination is usually slower and more uneven than in the nursery or in partial seeding because of the less perfect covering of the seed and the greater variation in the moisture conditions of the surface soil. With many species germination extends over a period of several weeks, while in others a large percentage of the seed lies over until the second year, particularly when the season is dry or the sowing has been delayed until late in the spring. Under average conditions of spring sowing, germination should take place within the following periods:

| | |
|---|--------|
| | Weeks. |
| Walnut..... | 4-10 |
| Hickory..... | 4-8 |
| Ash ¹ | 4-8 |
| Oak..... | 4-6 |
| Conifers (junipers and a few pines excepted)..... | 3-6 |
| Maple..... | 2-4 |
| | Days. |
| Willows and poplars..... | 2-6 |

6. THE COST OF FULL SEEDING

Aside from the cost of the large quantity of seed necessary in full seeding, the expense for labor varies between wide limits. When there is no cover to remove and the soil does not require working, the only expense is for the seed and its distribution. When the traveling is good one experienced workman can sow by hand from $\frac{3}{4}$ to $1\frac{1}{4}$ acres per hour, depending upon the size and weight of the seed. The cost for labor does not usually exceed 35 cents per acre. When the seed is covered by dragging or harrowing the total cost for labor is usually between \$1.50 and \$2.50 per acre. When the cover is dense necessitating its removal by hand labor and when the soil requires deep cultivation the cost may exceed \$50 per acre, a sum which makes this method of regeneration prohibitive.

7. SCATTERING THE SEED

The site is seldom in condition to permit the use of a seeding machine. Most of the larger machines used for full seeding in Europe are constructed on the principle of the grain seeder, sowing the seed either broadcast or in drills. Such machines are the

¹ Red, white, and green ash often lie over until the second year.

Runde, Roch, Göhren, Rotter, and Drewitz. Their practicability for use in full seeding depends upon the condition of the soil and the character of the topography. The ground is usually too rough to permit the use of special machines, and the topography is too broken or obstructions such as stumps, roots, and stones interfere.

An entirely practical method is the distribution of the seed with a hand seeder such as is used in agricultural pursuits. This is particularly useful in sowing coniferous seed where the ground is precipitous or covered with obstructions (Fig. 36).



Photograph by U. S. Forest Service

FIG. 36. — Sowing yellow pine seed with the cyclone seeder. Montezuma National Forest.

The best universal method for sowing is by hand, though considerable experience is necessary in order to attain uniformity. Even distribution of the seed can be accomplished best in the following manner:

a. Divide the area to be sown into divisions conforming to the topography and allot the requisite amount of seed to each division.

b. If the seed is small, thoroughly mix it with bran, sawdust, or sand, so as to add bulk to the quantity sown.

c. Cross-sow, *i.e.*, sow one-half of the seed in one direction and the remainder crosswise.

When mixed seeding is desired, the requisite amount of each

species can be sown separately or the seeds may be mixed before sowing. Mixing the seeds of two or more species before sowing should not be done if they vary in size or weight, because they cannot be distributed evenly; it is best to sow them separately, one crosswise of the other, provided the topography of the site permits.



Photograph by Conn. State Forester

FIG. 37.—A pure stand of white pine established by broadcast seeding on plowed land. Thirty years old. Enfield, Conn.

When hand sowing is undertaken in a rough country it is necessary to divide the area into sections determined by the topography and sow each section in the direction that it can be accomplished most easily. The seed is distributed as the sower, guided by stakes set at suitable intervals, walks back and forth across the area. The width of the strip that can be seeded by each passage over the area depends upon the size and weight of the seed. It varies with different species as follows:

| | Ft. |
|--------------------------|-------|
| Western yellow pine..... | 25-35 |
| White pine..... | 20-30 |
| Douglas spruce..... | 10-20 |
| Sitka spruce..... | 8-10 |
| Western red cedar..... | 6-8 |

The spring-tooth harrow is useful for covering seed in broadcast sowing. This implement consists of two sections, each $3\frac{1}{2}$ feet wide, and is drawn by a team of horses (Figs. 37 and 38).



Photograph by Conn. State Forester

FIG. 38. — The same stand shown in Fig. 37, after a thinning which removed 13 cords of wood per acre.

8. Partial Seeding

In regeneration by partial seeding the seed is distributed at intervals over the area to be stocked. The cover is removed and the soil worked only in the particular places where the seed is sown. When the site is clean and the soil loose, little or no preparation is required. On sites that require a clearance of the cover and the working of the soil, much less labor is required than in full seeding.

The cost of the removal of the cover and soil preparation is influenced not only by the character of the cover and soil but also by the form, size, and spacing of the seeded portions. In some instances, particularly in seeding in strips, the cultivated places over which the seed is scattered may occupy one-half of the total area. On the other hand, where the regeneration is in small seed spots spaced at 6-foot intervals the prepared and seeded area is about one-twentieth of the total.

The chief advantages of partial seeding over full seeding are as follows:

- a. From one-half to one-eighth as much seed is required.
- b. No cultivation is required except on the areas where the seed is sown.
- c. The best places can be selected for the seeding.
- d. The seed can be better covered.

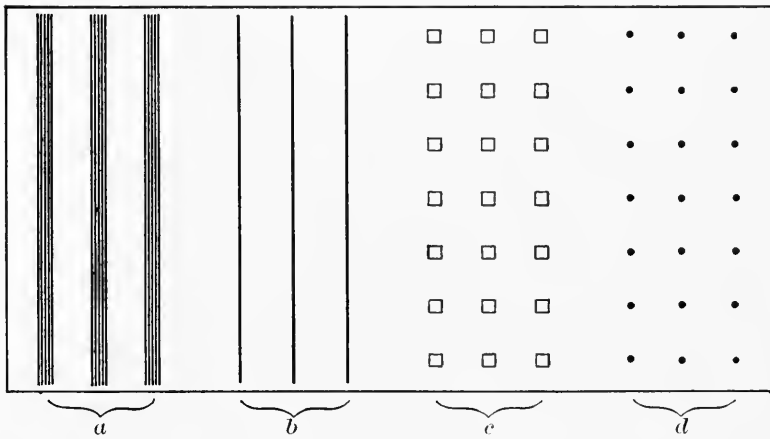

FIG. 39.—Diagram showing the arrangement of the seeded places in partial seeding.

- a. Strip seeding.
- b. Line seeding.
- c. Spot seeding.
- d. Hole seeding.

9. METHODS OF PARTIAL SEEDING

The places over which the seed is distributed in partial seeding are of various forms and sizes and arranged in a variety of ways (Fig. 39). They should be distributed as evenly as possible. The more important methods of partial seeding are as follows:

- a. Seeding in strips.
- b. Seeding in lines.
- c. Seeding in spots.
- d. Dibbling or seeding in holes.

10. Seeding in Strips. — In this manner of regeneration seeded strips of varying width alternate with unseeded ones. Its advantages over full seeding are less cost for seed and decreased labor where clearance and soil cultivation are necessary. The width of the seeded strip usually varies from 2 to 4 feet, depending upon the species and the site, particularly the character of the soil and the cover. The strips should be sufficiently wide to prevent the young seedlings from being unduly crowded by the growth on the alternating unseeded strips. The spaces between the seeded strips should be from 4 to 6 feet wide. If wider, the trees are likely to be too unevenly distributed and they fail to grow erect because of the excess of side light.

Strip seeding can be practiced most advantageously on sites that permit of more or less thorough soil preparation. It cannot be practiced where there is an excessive amount of litter or woody vegetation on the ground. Where conditions permit, the strips are best and most economically prepared for seeding by turning a series of shallow furrows and by harrowing the plowed soil until in suitable tilth. The seed is usually scattered by hand and covered by hand-raking. When the strips are cultivated and free from obstructions and surface vegetation seeding machines may be used as in full seeding. A well-selected branch with numerous side limbs drawn over the seeded strip is best for covering small seed.

Instead of broadcasting small seed on cultivated strips it may be sown in three or more parallel rows. The trees in the interior rows, crowded by the side rows, grow erect and clear themselves of side branches.

11. Seeding in Lines. — Under conditions that permit the plowing of furrows, seeding in lines is one of the least expensive methods of partial seeding. Single furrows are turned at intervals of from 3 to 6 feet and the seed sown along the furrows in single lines. It is a method better adapted for the regeneration of walnut, hickory, oak, and other large-seeded species than for the regeneration of conifers and small-seeded hardwoods. The seed is usually sown along the furrows at intervals of from 1 to 4 feet. As usually practiced one workman goes ahead dropping the seed on the fresh upturned soil and another follows and covers it. The ordinary hoe is the best implement to use in covering the seed. Large seeds are dropped, mostly, one in a place, at closely

spaced intervals, but sometimes two or more seeds are sown together at more widely spaced intervals.

The following are the chief advantages from seeding in furrows:

- a.* Hand labor is not required in preparing the soil for seeding.
- b.* Only from one-fourth to one-sixth of the total area is worked.
- c.* A comparatively small amount of seed is required.
- d.* The seed can be placed at varying positions in the furrow, depending upon the conditions for germination.

The disadvantages from seeding in furrows are:

- a.* The narrowness of the furrow often permits the vegetation to crowd in from the sides and overtop the young seedlings.
- b.* The surface soil turned under in furrowing exposes the poorest soil, in which the seed is sown.

Where a rank growth of weeds or other surface vegetation at either side of the furrow is sufficiently tall and dense to smother or seriously retard the growth of the young plants, it should be periodically removed during the first two years following the seeding.

On overwet sites two furrows may be thrown together forming a "blind furrow" and the seed sown on the ridge. The depressions at either side serve to carry off the excess water. The chief danger in sowing on ridges formed in this manner is from the vegetation turned under. This danger can be overcome by making the furrows from 6 to 9 months before the seeding. The furrows should parallel each other and follow the direction of the contour lines on sloping ground.

Thorough preparation of the soil is usually required in sowing conifers and small-seeded, broadleaved species in lines. In European practice the soil is worked in lines from 3 to 5 feet apart. The cultivated lines are from 12 to 18 inches wide and worked to a depth of from 4 to 12 inches. The lines are broken by horse power or by hand labor in the autumn preceding the regeneration. They are reworked by hand in the spring and all roots and sods removed, after which the seed is sown in a single drill either by hand or with a machine which sows and covers it in the same operation. Line seeding of conifers has not been attempted in the United States. It is the most successful method of direct seeding in Germany.

12. THE COST OF STRIP AND LINE SEEDING.—The cost of strip and line seeding is largely determined by the expense in-

curred in soil preparation. When the soil is prepared with the plow or other horse-drawn implement, the cost usually varies from 50 cents to \$2 per acre, depending upon the width of the strips and their distance apart. The single furrow turned at intervals of from 4 to 6 feet is the least expensive. The cost rapidly increases with the substitution of hand labor for plowing.

Oak and hickory are sometimes regenerated in New England by line seeding. The cost is approximately as follows:

| | Per acre. |
|---|-------------------------|
| Furrowing at 6-foot intervals..... | \$0.75 to \$1.25 |
| Sowing and covering the seed..... | 1.25 to 1.75 |
| Cost of seed, red oak at \$1.50 per bu..... | 1.50 to 3.00 |
| Total..... | <u>\$3.50 to \$6.00</u> |

The above costs relate to the original seeding only; they do not take into consideration the cost incurred in filling blanks by later seeding or planting.

In the regeneration of Scotch pine in Prussia by line seeding, the soil is thoroughly worked by hand in narrow lines the autumn following the removal of the old stand or sometimes the following spring. The lines are spaced at approximately 4-foot intervals and worked to a width of 15 inches. Eight days' labor per acre is required to prepare the soil in the manner noted. Immediately preceding the seeding four additional days are required to rework the soil on the strips to a depth of several inches, remove all roots and prepare the surface for the seeding. The seed is sown in a single row in the center of the prepared strip with a seeding machine drawn by two men and guided by a third. The three men can seed about $7\frac{1}{2}$ acres per day. The seed is sown in early April at the rate of $1\frac{3}{4}$ pounds per acre. This method of seeding usually gives about 20,000 plants per acre, which are reduced to 10,000 five years later. Prussian methods of thorough soil preparation result in complete stands and few failures. The large amount of labor required per unit of area prohibits the introduction of this method of line seeding in the United States. However, it clearly emphasizes the importance of thorough soil preparation, without which we can scarcely hope for uniform success.

13. Seeding in Spots. — The sowing of seed in prepared and unprepared spots has been the most common practice in direct seeding in the United States. At the present time more intensive

methods are practiced than formerly, and sowing in spots without preliminary working of the soil has been almost entirely abandoned.¹

Sowing in spots is well adapted to rough sites or those covered with stones, stumps, logs, and other obstructions which prohibit the use of horses in working the soil. Where it is necessary to work the soil by hand labor, it is the best and least expensive method of direct seeding. More attention can be given to the clearing away of the ground cover and the working or loosening of the soil on the spots where the seed is sown, as the cost is less than in preparing the site for full seeding or for sowing in strips or lines because the area cultivated in proportion to the total is much smaller.

Seed spots vary greatly in size, form, and distance apart, depending upon the species and the conditions of the site. In size they vary from 4 to 6 feet on a side to mere openings a few inches in diameter. They are usually made square or rectangular in form, but are sometimes irregular. The spacing is dependent upon the size of the seed spot, as well as the species and site. They are distributed over the area as regularly as practicable. Irregularities are justifiable, however, when necessary to secure the best places for the seed.

Successful regeneration from seeding in spots depends upon the species, the site, and the thoroughness with which the soil is prepared. It is usually most successful under an open overwood where the soil is comparatively free from surface vegetation and on recently lumbered areas. It is least successful on dry, thin, leachy soils covered with surface vegetation. On comparatively clean, loose soils in regions of sufficient soil moisture, it is not customary to loosen or otherwise prepare the soil prior to seeding. The seed is scattered on the seed spots and covered by means of a rake or hoe. Seed spots are usually prepared at the time of seeding or but a few days before. On sour or heavy soils, however, the spots should be cleared of surface vegetation in the autumn and the soil thoroughly loosened and left to cure over winter.

14. LARGE SEED SPOTS. — Large seed spots are sometimes useful on moderately clean soils under an open overwood. They

¹ Greeley, W. B.: Reforestation on the national forests. (Proc. Soc. Am. For., vol. VIII, p. 265. 1913.)

are not infrequently from 3 to 6 feet in diameter and spaced at wide intervals, often 30 or more feet distant from each other. Pine and other conifers are sometimes established under an open hardwood stand in this way with the expectation of cutting the hardwoods after the conifers are established. A hundred or more seedlings develop on a single seed spot, many of which are transferred when from 2 to 4 years old to the open spaces between the seed spots.¹

Large seed spots should be used in preference to small ones in direct seeding on failed places in natural regeneration. Natural regeneration in Austria is often assisted by cutting the weeds and brambles so as to make a better germinating bed on the failed places² and by making seed spots about 2 feet square. In the same country the introduction of beech into coniferous plantations is often attained by the formation of seed spots at regular intervals, 7 feet long by 2 feet wide, each sown with a handful of nuts. Large seed spots should be used on sites that are very foul or likely to become overgrown with wild growth after seeding. When large seed spots are well prepared, their size prevents excessive early competition from the side.

Large burns, on which the surface vegetation has been more or less completely destroyed, can sometimes be regenerated by seeding in large seed spots on the best soil without previously working it. The seed is scattered on the exposed soil and covered by raking. If more than 8 feet intervenes between the seed spots, it is usually necessary later to shift some of the seedlings to the intervening spaces.

15. SMALL SEED SPOTS. — Seed spots are usually made from 8 to 12 inches in diameter and spaced at intervals of from 3 to 8 feet in each direction. The U. S. Forest Service recommends the following procedure in the formation and seeding of seed spots in District 2:³

“A spot 8 to 12 inches in diameter is cleared of sod, weeds or stones so that the soil is exposed. The soil is then worked to a

¹ This method of regeneration has been successfully practiced in changing cullied hardwood stands to white pine in Pennsylvania.

² Woolsey, T. S.: A glimpse of Austrian forestry. (Proc. Soc. Am. For., vol. IX, p. 7. 1914.)

³ Greeley, W. B.: Reforestation on the national forests. (Proc. Soc. Am. For., vol. VIII, p. 267. 1913.)

depth of 2 or 3 inches with a grub hoe, stout rake or other tool. From 10 to 15 seeds are scattered over the spot and lightly covered with soil. The soil is then firmed over the seed with moderate pressure of the foot. When available, a light covering of leaf litter is scattered over the spot."

Seeding in small, prepared seed spots is the only method extensively practiced in the direct seeding of conifers in the United States. This method has not proved as successful in the past as it is likely to prove in the future when more careful attention is given to the selection of suitable sites and the necessary preparation of the soil for the reception of the seed (Fig. 40).



Photograph by U. S. Forest Service

FIG. 40. — Sowing Douglas fir seed in small prepared seed spots.
Pike National Forest.

Greeley emphasizes the fact that advantage must be taken of every feature of the site that may afford protection to the young seedlings in locating the individual spots. Placing the spots on the north or east side of a stump, stone or mound of earth may afford the seedlings sufficient protection to bring them through the first summer, which is by far the most critical period in determining the success or failure in the regeneration after germination has been attained.

The regeneration of conifers by direct seeding in small, prepared seed spots has been far more successful in some parts of

Europe than in the United States. The author believes that this is due primarily to confining the seeding to more favorable sites, to better soil preparation, to better protection, to closer spacing, and to the use of fresh, high-grade seed. During the past 50 years about one-fourth of the artificially regenerated public forests in Norway and Sweden have been established by direct seeding in small, prepared seed spots (Fig. 15). As a rule, the seed spots are spaced at approximately 4-foot intervals in each direction and the seed sown immediately after cutting or after fires. They are usually cultivated to a depth of 6 inches in order to get out the roots and thoroughly mix the organic material on the surface with the mineral soil. When a few trees are left standing on the area to be seeded the regeneration is more successful, due to the protection which they afford the soil and young growth.

The wide spacing of small seed spots so often practiced in the United States and the neglect in filling blanks are not likely to result in successful stands. Even under the most favorable conditions *a spacing of 6 feet is believed to be the widest spacing permissible.*

The ordinary garden rake has been extensively used in the United States in preparing seed spots. It can sometimes be used to advantage on areas that have been recently burned and are practically clear of living vegetation. It permits only a superficial working of the soil and should not be used in preparing seed spots on compact soil or areas covered with surface vegetation. The ordinary potato digger with heavy cylindrical teeth permits a much deeper working of the soil and has been used in preference to other implements on some of the National Forests. The grub-hoe is the most useful tool for preparing small seed spots on soils overrun with surface vegetation or filled with stones and roots. The long-handled hazel hoe with wider blade is more useful on ground without dense surface vegetation and without roots and stones in the surface soil. The wider hoe is a hindrance rather than a help on rocky soils. The ordinary rakes and potato diggers are not so useful for making seed spots as the special tools with broad, flat teeth used in European practice, as the latter permit deep working of the soil and the easy removal of surface vegetation. The ordinary flat-tined spading-fork can be formed into a tool well adapted for making seed spots under all ordinary condi-

tions of soil and soil cover. A straight handle is substituted for the ordinary crooked handle and the 5 tines are bent inward at right angles $4\frac{1}{2}$ inches from the end, thus forming a 5-toothed rake with broad, flexible teeth. It is strong and durable and does efficient work even on compact soils and areas covered with considerable surface vegetation (Fig. 41).

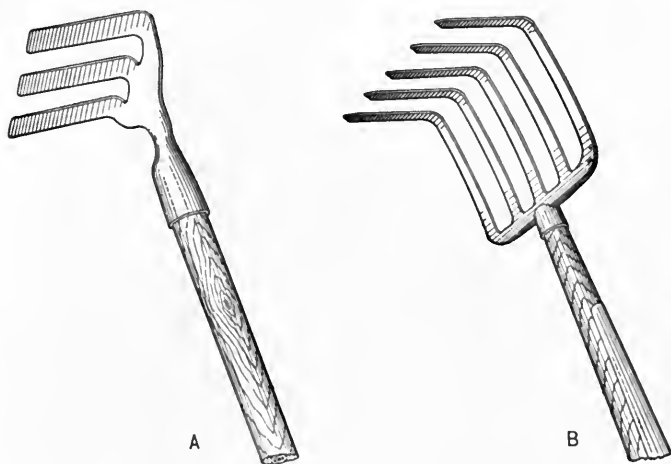

FIG. 41.—Tools useful for making small seed spots.

- A. European rake with broad, flat teeth.
- B. Standard spading fork with teeth bent to form a rake.

In sowing in small seed spots the crew usually works in 1-man units, and the spacing is judged by the eye. The straightness of the rows is of minor importance so long as the spots are distributed with reasonable uniformity. The seed is usually carried in a sack under the left arm, suspended from the shoulder and fastened at the belt. After the surface vegetation has been removed and the soil thoroughly loosened and mixed the seed is scattered over the surface, covered with mineral soil and pressed down with the feet.

A number of special implements have been devised for loosening the soil in seed spots and regulating the amount of seed sown in each spot. The Eckbo seed planter (Fig. 42) consists of a thin steel tube, 4 feet long and $1\frac{1}{2}$ inches in diameter with a detachable rake on one end and a screw cap on the other. The rake is $6\frac{1}{4}$ or $7\frac{1}{8}$ inches wide with 5 or 6 cylindrical teeth. The seed is

poured into the steel tube and passes in correct amount for a single seed spot into a sliding receptacle on the lower end just above the rake. After the seed spot is prepared the forward movement of a small rod attached to the side of the tube permits



FIG. 42.— The Eckbo seed planter.

- a. Hollow handle for carrying the seed.
- b. Sliding receptacle for measuring the seed.
- c. Rod for opening the sliding receptacle.
- d. Detachable rake.

the requisite amount of seed to fall out over the spot. The advantages claimed for this implement over the ordinary garden rake, potato digger, and hoe are as follows:

a. A large increase in the number of seed spots that can be made and sown in a given unit of time.

b. The distribution of the same amount of seed in each seed spot.

From experiments conducted by Brower on the Uinta National Forest he concludes that it does better and less expensive work than the ordinary rake or hoe. Perfectly clean seed must be used in the seeder. Foreign matter is likely to clog the seed receptacle and prevent successful operation. Its chief defect appears to be in not scattering the seed evenly over the seed spot.

The author has found the Spitzenberg loosening spade¹ a very efficient tool for the thorough and deep loosening of the soil in the formation of seed spots. It is heavy and slow in operation and has not been used in the United States except for demonstration purposes.

Several forms of the torsion rake are sometimes used abroad in making small seed spots.² The torsion rake consists of an upright T-handle, to the base of which is attached an iron disk carrying 8 or more teeth. The teeth are inserted vertically in the spot selected for seeding and the soil loosened by turning the handle to the right or left (Fig. 43).

¹ Spitzenberg, G. K.: Die Spitzenberg'schen Kulturgeräte. 2. Aufl., S. 13-24. Berlin, 1898.

² Heyer, Carl: Der Waldbau oder die Forstproduktenzucht. 5. Aufl., I. Bd., S. 134. Leipzig, 1906.

Spiral borers¹ are very efficient implements for loosening the soil for seed spots that are only from 4 to 6 inches in diameter (Fig. 44). They are forced vertically into the ground and turned around to the right until the soil is thoroughly loosened to the

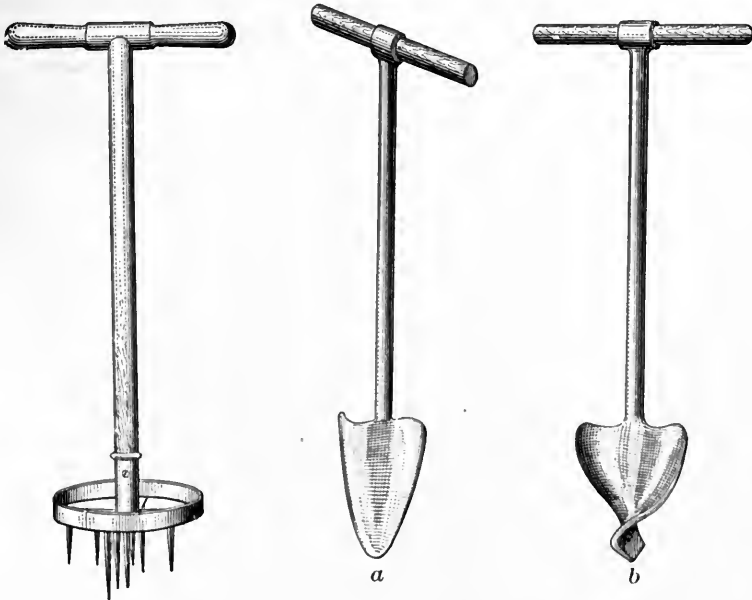

FIG. 43.—Torsion rake.

FIG. 44.—Spiral borers.

required depth. The seed is then pressed into the soil or placed on the surface and covered by hand with fine earth.

A Swedish seed flask devised by Hallströme has given good results in distributing a uniform amount of seed over the seed spot. In using this flask, however, the seed spots are made and the seed sown by different workmen.

16. THE COST OF SEEDING IN SPOTS.—The cost of sowing in seed spots depends chiefly upon the labor required for the preparation of the spots for the reception of the seed. When the site is foul and the ground hard and compact necessitating the removal of the surface vegetation and the loosening of the soil to a depth of 6 inches or more, the cost is usually as high as

¹ Gayer, Karl: Der Waldbau. 4. Aufl., S. 331. Berlin, 1898.

that incurred in planting on similar sites. When the area is free from surface vegetation and the ground is loosened only to a depth of 2 or 3 inches, an experienced workman will make and sow from 250 to 400 seed spots per hour. Under extremely adverse conditions this number may be reduced to 50 or even less. As only from one-fourth to one-eighth as much seed is used as in full seeding, the cost of the seed is usually low. Thus, white pine

sown in seed spots spaced at 6-foot intervals with from 25 to 30 seeds per spot requires but 1 pound of seed per acre. The cost of seeding in small seed spots including the cost of the seed but excluding reseeding or planting failed places is usually from \$2.50 to \$5 per acre.

17. Dibbling or Seeding in Holes. — Large seeds such as walnut, hickory, chestnut, and oak are sometimes sown 1 or 2 in a place in small holes made with the dibble or with similar implements. The tool is inserted into the ground to the required depth, withdrawn, and 1 or more seeds placed in the opening. Among special tools should be mentioned the acorn planter (Fig. 45), with which oblique openings are made in the ground. The seeds lie on the side and are in better position for germination and the openings are more completely and more easily closed by pressure of the feet than are those made with the ordinary dibble.



FIG. 45.—Acorn planter.

Several types of hand corn planters have been extensively used in the direct seeding of conifers on the National Forests (Fig. 46). The eclipse planter which can be adjusted for various sizes of seed and for sowing the requisite number has been more generally used than others. It permits of very rapid work, as 1 workman can seed from $\frac{1}{2}$ to 1 acre per hour when the seed is sown at 6-foot intervals. In operating the corn planter the seeds pass from the implement in a compact cluster and are forced into the soil with an iron plunger. When the soil is loose and free of surface vegetation, the seed is well covered. When compact or covered with surface vegetation, it is insufficiently covered. The plunger is likely to crush the seed on compact soil. Small seeds such as

spruce and larch are usually covered too deep on loose, sandy soil. The successful regeneration of yellow pine has been attained in the Black Hills, South Dakota, by seeding with the corn planter in loose soils free of surface vegetation. Sowing in prepared seed



Photograph by U. S. Forest Service

FIG. 46. — Direct seeding with the corn planter. Pike National Forest.

spots, although more costly than seeding with the corn planter, has almost entirely superseded the latter, due to the greater certainty in securing a successful stand.

18. Sowing in Pits and on Mounds. — When the site is excessively wet or overdry, the seed spots should be raised above or lowered below the general surface of the ground so as to attain better soil moisture conditions. Lowering the surface of the seed spot from 4 to 8 inches causes the surface water to collect in the pit and thoroughly saturate the soil. There is less danger of the young seedlings suffering from summer droughts. Seeding in pits is best on loose, porous soils.

On overwet sites the seed spots may be raised on mounds of sufficient height to bring the germinating seeds and the young seedlings well above the high water mark. After the mounds are formed, seeding should be delayed until the ground is in good tilth. The large amount of hand labor involved in constructing mounds makes this method of soil preparation prohibitive except in special cases.

CHAPTER XII

THE FOREST NURSERY

1. GENERAL CONSIDERATIONS

THE forest nursery is an essential part of every well-managed forest. There is need for nursery-grown stock in forests that are regenerated by natural means because failed places invariably occur and planting must be employed to complete the stand. Direct seeding is seldom uniformly successful and the regeneration must usually be completed by planting. Windfalls frequently interfere with the established plan of natural regeneration and planting is necessary. Forest fires by completely destroying large areas of forest often make regeneration by planting the only practical method. Abandoned farm lands, prairies, and other denuded areas must, in most cases, be forested by planting. Under certain conditions it is advantageous to manage the forest under a system of clear-cutting followed by planting, as is the usual practice in growing Scotch pine in Europe.¹

Forest stock is grown in *commercial nurseries* which distribute the trees to their customers as required, or it is grown in *home nurseries* owned and managed by the forest owner. *Permanent nurseries* are those where forest stock is grown continuously year after year on the same site. *Temporary nurseries* are used for a few years only, usually to grow stock for planting on a particular area. They are then abandoned and new ones laid out where additional planting is necessary.²

Commercial forest nurseries have long been established in Europe, some of which have an annual output of 50 to 100 million trees. These nurseries not only supply the local trade but also have a large export business. It is only within comparatively recent years that commercial forest nurseries have been established in the United States. The forest stock necessary to supply

¹ Mayr, Heinrich: *Waldbau auf naturgesetzlicher Grundlage*. S. 361. Berlin, 1909.

² Schlich, Wm.: *Manual of forestry*. 4th ed., vol. II, p. 199. London, 1910.

the demand was imported from Europe or grown in domestic nurseries where the principal business was the growing of trees for horticultural and decorative uses. The cost of planting stock has been inordinately high and the price has fluctuated from year to year. The rapid development of commercial forest nurseries in the United States in recent years has resulted in reduced prices and the planter has greater assurance that the stock will meet his requirements.

A standardization of prices for the different kinds and classes of forest stock has not as yet been attained in the United States, and one dealer is likely to charge two or three times as much as another. The planter in placing his order should see that it is given to a responsible dealer. *He should deal direct with the nursery and familiarize himself with the current quotations for standard kinds and classes of stock.* The purchaser of stock should insist that it be properly inspected for insect and fungous diseases before leaving the nursery and that the shipment be accompanied by a certificate showing such inspection. The stock should be carefully examined on its receipt and all plants rejected that fail to meet the specifications under which they were purchased.

It is particularly important that the order be placed early, if possible, several months before the stock is wanted for planting. When the order is placed late in the spring or only a few days before the stock is wanted, the particular species or class may be sold out or only inferior stock remain unsold. The rush of orders may also delay shipment until too late for successful planting.

2. TEMPORARY NURSERIES

Temporary nurseries are usually small and are increased or decreased in number with the demand for planting material. As a rule, a single nursery that supplies all the stock for planting in a given forest district is better than several small ones that are shifted about from place to place as circumstances require. The single nursery is more easily supervised, better cared for, and usually better located. The stock can be grown at a lower cost because a single large nursery with a given yearly output costs less to manage and maintain than several shifting ones of equal production. Temporary nurseries do not yield as good plants and the required output cannot be as effectively maintained.

Wherever possible, temporary nurseries should be partially surrounded by high forest so as to break the force of the wind. They are usually located on recently felled areas where there is an abundance of organic matter in the soil and are abandoned before the soil deteriorates under successive cropping. Manuring is not necessary. Temporary nurseries are often advantageously maintained in mountainous regions where site conditions rapidly change, as it gives an opportunity to grow each kind of stock in the same vegetative zone as the area to be planted. The cost of transportation is much reduced as the plants are grown on or near the site where they are used. This is an important factor when large trees are used in planting. The time between the lifting of the stock in the nursery and the setting in the plantation is also reduced. Temporary nurseries are usually favored when planting is limited to supplementing natural regeneration, when the stock required varies in amount from year to year, and when only a small number of plants are required. Temporary nurseries are sometimes advantageous on light, sandy soils where the humus is largely in the surface layer. In the formation of the nursery the soil is worked to a depth of but 2 or 3 inches. The first two or three crops of young trees make excellent growth due to the large amount of vegetable mold in the surface soil.

3. PERMANENT NURSERIES

Permanent nurseries are usually large and intensively managed. Some of the forest nurseries of Europe have been in existence for more than one hundred years. Permanent nurseries are usually located near the superintendent's residence. A large amount of labor is required in nursery work, particularly for a period of two or three months in the spring. It is highly important, therefore, to locate the permanent nursery where labor is available and where the minimum amount of time is consumed in going to and returning from work. It should also be located with reference to inexpensive and easy transportation. When the stock is distributed by wagon or by pack animals, it is important that the nursery be located so that all parts of the forest can be reached most directly by the established roads and trails.

A moderate difference in the altitude of the nursery as compared with the planting site, even a difference of one or two thousand feet, should not ordinarily necessitate the establishment

of separate nurseries, unless there is a well-marked difference in the vegetation. *It is important, however, that the nursery be established at the lowest elevation in the forest over which the stock is used because it is more accessible, stock of suitable size can be grown in shorter time and at less cost, work can begin earlier in the season, and there is much less danger of frost injury.*

There is no essential difference in the management and treatment of temporary and permanent nurseries. In the latter, however, the original outlay can be greater as the cost can be spread over a long term of years.

4. FACTORS WHICH DETERMINE SUCCESS IN THE PRODUCTION OF NURSERY STOCK

The degree of success in the production of nursery stock for forest planting is largely dependent upon the following:

- a. Efficient administration and supervision.
- b. The systematic execution of nursery operations in reference to time and order.
- c. The selection of a suitable site.
- d. The economic and successful development of the site.
- e. The utilization of the best cultural methods.
- f. The utilization of the best lifting, storage, and packing methods.
- g. The elimination of losses in the stock from preventable causes.

5. Administration and Supervision

The success of a forest nursery is intimately bound up with its administration and supervision. The administration must determine the species, amount, and various classes of stock required year after year for planting in the particular forest that it supplies, or, in the case of commercial nurseries, that will find a market. Superior judgment in these matters prevents great losses through producing the wrong species or the wrong classes of stock, and from growing more than is needed at one time and too little at another. The administration provides plans for the distribution of the output of the nursery by seasons, species and classes of stock, often several years in advance, and initiates and acts upon all administrative features.

The nursery superintendent is responsible to the administration for the production of the stock desired at the time when wanted and at reasonable cost. His entire time is given to the work in large permanent nurseries. Even in small nurseries and temporary nurseries one man must be held responsible for all nursery operations. When the magnitude of the work does not justify the continuous services of a superintendent, an arrangement should be made whereby he is also placed in charge of planting or woods work of various kinds. The superintendent should make an inventory of all stock in the nursery at least once each year, preferably in August, as a basis for autumn and spring distribution. The inventory should show the number of plants of each species as regards age, size, quality, and whether seedlings or transplants. A second inventory should usually be made in the spring in order to show the surplus stock and serve as a basis for the area of new seedbeds of the various species necessary to keep the nursery adequately stocked.

6. The Execution of Nursery Operations in Reference to Order and Time

There is no other calling more exacting than the nursery business in the order in which the many operations are performed and in the time of their execution. A delay of two weeks in spring transplanting may cause a loss of 50 per cent in the transplant beds. Sowing the seedbeds ten days earlier in the autumn than they should be sown may induce autumn germination and cause the total destruction of the young plants by winter killing. Because of the exacting nature of the business, nursery practice on an extensive scale demands a well-considered working plan, a carefully arranged budget, and a complete set of nursery records. A cost-keeping system should be established in which all the expenditures incurred in the different projects are charged. As most forest nurseries collect and deal in forest tree seed as well as planting stock the various projects which call for separate cost tabulations are usually as follows:

- I. Forest tree seed:
 - a. Collecting.
 - b. Cleaning.
 - c. Purchase.
 - d. Sale and distribution.

II. Nursery:

- a. First-year seedlings.
- b. Second-year seedlings.
- c. Third-year seedlings.
- d. First-year transplants.
- e. Second-year transplants.
- f. Third-year and older transplants.
- g. Purchase of nursery stock.
- h. Sale and distribution of nursery stock.

A carefully determined proportion of the cost of superintendence, office expenses, and other overhead expenses should be charged against each project. By so doing it is possible at any time to determine the cost of each and the profit or loss from its operation.

As all cultural operations are at a standstill in winter this should be the time of active office operations. Definite plans for the year should be formulated and office records for the past year put into permanent form for filing. The inventory should be analyzed and the kinds and classes of stock to be moved the following spring determined. *Commercial nurseries aim to grow each year what they believe the trade will absorb.* As the requirements of the market cannot be accurately known in advance, excess stock of certain kinds and classes is likely to accumulate while other kinds and classes are grown in insufficient quantity. The elimination of losses from excess stock depends largely upon the efficiency of the sales department. The sales for spring delivery are charged against the various kinds and classes of stock as they are received. Circulars and special letters to prospective purchasers offering special inducements often assist in moving excess stock and are sometimes the only means by which it is prevented from becoming a total loss. Catalogs, advertising, and similar matters should receive attention during the winter. The permanent labor should be employed during this season in general repairs and in making screens and other nursery structures necessary for the operation of the business for the entire year. All non-perishable supplies required during the year should be secured and all necessary permanent improvements made.

7. The Selection of the Nursery Site

The site must be favorable for the growth of the particular species that are required. When large numbers of plants are produced year after year it is often desirable to grow but a single species in a given nursery. A site can be chosen which is best adapted to the special requirements of the particular species. When species of diverse requirements are grown, the conditions are necessarily more or less unfavorable for at least a portion of them. By selecting a site of average conditions where the soil is neither too light nor too heavy, too wet nor too dry, too cold nor too warm, species of different requirements can be grown successfully. In nearly all localities because of the necessity for irrigation, *the nursery site should be selected with reference to an adequate supply of water.*

8. SOIL CONSIDERATIONS

The soil that most fully meets the requirements for growing a diversity of species of varying requirements is *a sandy loam or loamy sand*. It should be deep and fresh. A good soil is prerequisite to success and economy in plant production. An unfavorable soil can be artificially improved by manuring, or by the application of sand or clay, as the case requires, but only at considerable cost. On the whole, the physical characteristics of the soil are more important than its fertility, as the latter can be overcome by the application of fertilizers. A heavy clay should be avoided even more than a very light sand. The former lacks in porosity and permeability, the distribution of the soil water is uneven, and it is likely to be cold and overwet. Plants grown upon it are in greater danger of being thrown by the frost. It is much more difficult and expensive to work in all seasons, and in the spring, when work is most pressing, it often cannot be worked at all. The addition of fertilizers, more particularly organic manures, to very light soils greatly improves their physical characteristics.¹

The seedlings are thrifty and the roots well developed in a deep soil of good quality, and consequently there is a minimum of loss when they are set in the permanent plantation. The plants

¹ Bates, C. G. and Pierce, R. G.: *Forestation of the sand hills of Nebraska and Kansas*. (U. S. Forest Service, Bul. 121, p. 27. 1913.)

develop a rambling root system with few fibrous roots when the soil is poor and overlight. As a result, they are difficult to lift and set in the plantation and the loss is excessive. The root system is small and imperfectly developed and the plants are difficult to lift without injury when the soil is heavy.

It is a mistaken belief that, when planting is to be done on a poor site with inferior soil, the stock should be grown on a similar soil. The stock for planting on all sites should be as well developed and vigorous as possible. It should be grown on the most favorable soil and under the best conditions.

9. SLOPE, ASPECT, AND SURROUNDINGS

A perfectly level site is usually undesirable, particularly if the soil is somewhat heavy. A level site is preferable on light, sandy soil. A gentle slope, just sufficient to permit perfect drainage, is best for the average site. If the slope is more than 5 degrees, erosion is likely to occur and terracing is necessary in forming the seedbeds. The location of the nursery with reference to aspect depends chiefly upon latitude and altitude. Eastern and southern aspects are best for most species in cold regions of adequate rainfall. In most localities in temperate United States, eastern and southeastern aspects should be avoided because of the greater frost danger, and southern and southwestern aspects because of overdryness of the soil during periods of drought.

Where provision is made for irrigation, southern aspects in northern latitudes and at high elevations are best because of their greater warmth. For most localities in the United States, however, a northern or western aspect is best because the vegetation starts later in the spring and is not so much injured by frost, and the loss of water through evaporation from the surface soil is not so rapid.

Nurseries should not, as a rule, be established in narrow valleys or at the depths of deep canyons because the lack of direct sunlight for a large part of the day seriously checks growth. Such sites are also subjected to frost damage because the colder air seeks the lower elevations in hilly and mountainous regions.

The nursery should not be fully exposed to the free sweep of the wind. It should be protected by a high forest or a well-

developed wind break, at least on the windward side (Fig. 47). It should not be entirely surrounded by high woods in regions where the soil is heavy or overwet because the movement of the air is so completely checked that the soil is difficult to work particularly during the spring months. To what extent it is advantageous to



FIG. 47. — A forest nursery protected by a high forest. Near Chorin, Prussia.

protect a nursery by surrounding vegetation in the form of high forest depends upon the conditions affecting each particular site. In general, some protection, at least on the windward side, is desirable.

10. Development of the Nursery Site

The manner of developing the site necessarily depends upon the locality and the permanency of the nursery. In general, it relates to putting the site in good physical condition for the growth of the desired stock and in the construction of permanent improvements.

11. THE GROUND PLAN

Although the shape of the nursery must necessarily conform to the topography and other features of the site it should, when possible, be rectangular or square. Nurseries of irregular shape

present difficulties in arrangement and maintenance. Before work in a nursery is commenced a plan should be made showing all permanent features (Fig. 48).

Every large nursery should be permanently divided by roads and crossroads into blocks or compartments, square or rectangular

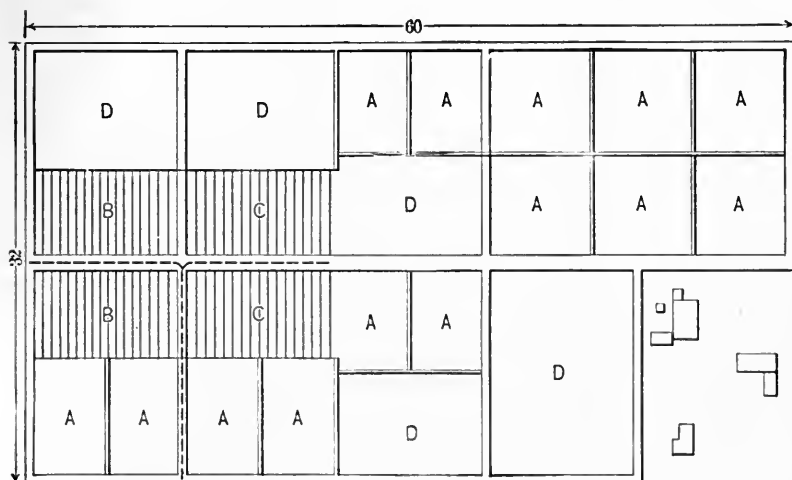

FIG. 48. Nursery plan. *A*, transplant beds; *B*, 1-year seedbeds; *C*, 2-year seedbeds; *D*, soiling crops. Area, 12 acres; annual capacity 1,000,000 white pine transplants (2-1) and 1,000,000 white pine seedlings (2-0).

in shape. The main roads should be 10 or 12 feet wide, and the other roads 8 feet. A large amount of space where seedbed frames and other material can be piled is required in working the nursery. It is a mistake, therefore, to make the roads narrow. Both seedbeds and transplant beds when not bordering on roads should be surrounded by temporary paths, from $1\frac{1}{2}$ to 2 feet wide. Seedbeds are usually 4 feet wide and from 12 feet long to the entire length of the compartment. Transplant beds are 4 or 6 feet wide or the entire width of the compartment. They are usually as long as the compartment. The seedbeds should not, as a rule, be continued year after year in the same compartment, and the transplant beds in other compartments. A rotation permits of more economical methods of manuring and the improvement of the soil by growing soiling crops.

12. THE AREA

The size of the nursery necessary to produce stock for a definite forest region bears no relation to the area of forest but rather to the number, size, species, and character of stock required yearly in its management. Where the regeneration is entirely by planting, particularly if large transplanted stock is used, the nursery must be extensive, embracing from $\frac{1}{2}$ to 3 acres for every 1000 acres of forest.¹ Where planting is used only to supplement direct seeding and natural regeneration, small temporary nurseries are adequate to supply stock for extensive forests.

The circumstances affecting the conditions in one locality as compared with another are so variable that no general rule can be applied. Pettis² gives the following as the number of white pine and spruce trees of various ages that can be produced annually in a nursery of given size when allowance is made for the paths between the beds but not for roads.

| Age of trees. | Number of trees annually produced in nursery. | | | |
|-------------------------------|---|------------------------------|------------------------------|------------------|
| | Area, $\frac{1}{8}$ acre. | Area, $\frac{1}{4}$ acre. | Area, $\frac{1}{2}$ acre. | Area, 1 acre. |
| 2-year seedlings..... | 240,000 | 480,000 | 960,000 | 1,920,000 |
| 3-year transplants (2-1)..... | 35,000 | 70,000 | 145,000 | 290,000 |
| 4-year transplants (2-2)..... | 9,000 | 20,000 | 40,000 | 80,000 |

Schlich³ recommends that the nursery be about $\frac{1}{2}$ per cent of the area to be planted annually when 2-year seedling spruce is planted at 4-foot intervals. When the same species is pricked out at the expiration of 2 years in the seedbeds and grown for an additional 2 years in the transplant beds, the nursery should contain from 2 to 4 per cent of the area to be planted annually. Broadleaved species, such as oak, chestnut, walnut, beech, ash, maple, and rapidly growing conifers like larch, require much larger nursery space in proportion to the area planted annually. Furthermore, the area required increases rapidly with the age of the stock and the number of times transplanted. When 1-year

¹ Reuss, Hermann: Die forstliche Bestandesgründung. S. 107. Berlin, 1907.

² Pettis, C. R.: How to grow and plant conifers in the northeastern states. (U. S. Forest Service, Bul. 76, p. 33. 1909.)

³ Schlich, Wm.: Manual of forestry. 4th ed., vol. II, p. 201. London, 1910.

stock is used, as is the usual practice with catalpa and black locust, the nursery should embrace from 1 to 2 per cent of the area to be planted annually. When possible, the forest nursery should have twice the area that is in seedbeds and transplant beds at any given time in order that there may be a rotation of crops and an opportunity for the land lying fallow or being used for the production of soiling crops at frequent intervals.

13. NURSERY BUILDINGS

The number, character, and kind of buildings depend largely upon the size and permanency of the nursery. *The supervisor or nursery foreman should reside on the grounds in order to be within reach at all times.* The labor employed in nurseries is largely of a temporary character. When the nursery is located near a town, the workmen usually live in their own houses and are employed at a fixed price per hour while actually engaged. When the nursery is inaccessible to an adequate supply of labor, temporary quarters must be provided on or near the nursery for the large number of laborers required for a period of several weeks during the autumn and spring months. One or more of the skilled laborers, who are capable of handling men and taking charge of specific operations, are usually employed throughout the year. These men should also reside on or near the nursery, a contingent which sometimes necessitates the erection of permanent quarters for them.

Aside from suitable quarters for the superintendent and for a part or all of the labor, necessary stable room and tool sheds must be provided, also packing and storage sheds for the stock after lifting, while it is stored, sorted, and packed, and for storing packing boxes, seeds, and other material used in nursery practice (Fig. 49).

14. HEDGES AND FENCES

It is always advantageous to fence the nursery. As the chief purpose of the fence is to protect the nursery from cattle and other animals, it may be of woven wire, wood, or stone or it may be a living hedge. Under most conditions a well-constructed woven wire fence is efficient in protecting the nursery from animal life. It can be made rabbit proof by using a small mesh netting

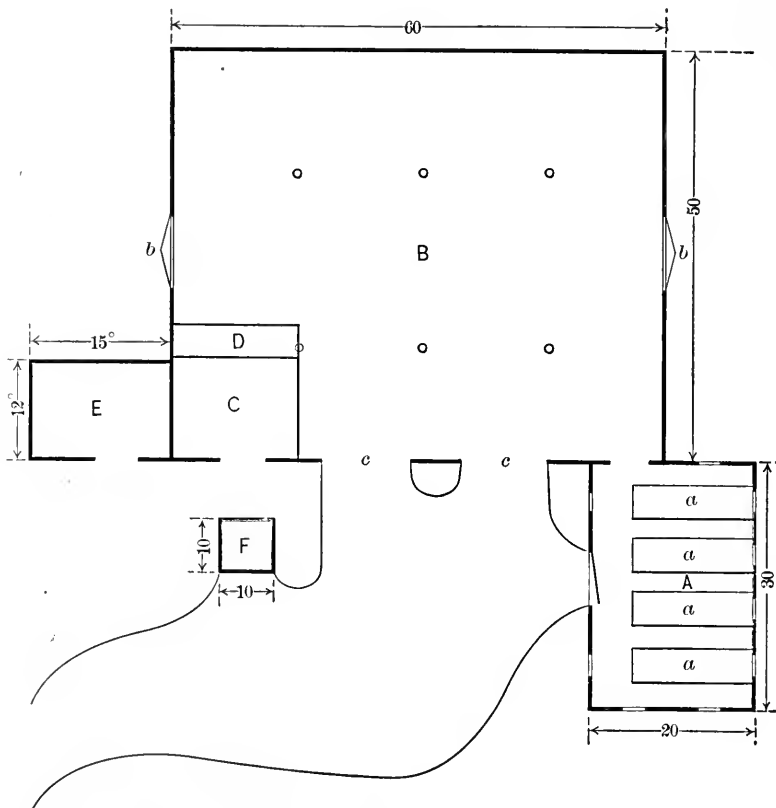

FIG. 49.—Plan of the sorting, storage, and packing rooms at the North-eastern Forestry Company's nursery. Cheshire, Conn.

- | | | | |
|-------|-----------------|----|--------------------|
| A. | Sorting room. | C. | Packing room. |
| a. | Sorting tables. | D. | Record room. |
| B. | Storage room. | E. | Moss room. |
| b, b. | Windows. | F. | Shipping platform. |
| c, c. | Doors. | | |

for the lower portion of the fence, the under edge of which is inserted from 4 to 6 inches in the ground.

In regions of excessive rainfall, stone walls and other close fences are objectionable as they obstruct the free passage of the wind, thus checking soil evaporation. On the other hand, fences of this character are preferable in localities that suffer from excessive soil evaporation. Living hedges of hemlock, arbor-vitæ, privet, and other suitable species are admirable for checking wind velocity at the surface of the ground. When the nursery is on



FIG. 50.—Interior hedges in a forest nursery. Near Chorin, Prussia.

light, sandy soil and liable to suffer from summer drought, the hedge is preferable. The chief objection to its more extended use is the long time that it takes to grow and the frequent attention required in order to keep it properly trimmed. Where lines of interior hedges are used in large nurseries, they should be at right angles to the direction of the prevailing wind (Fig. 50).

Gates or turnstiles should be constructed at advantageous points. Because of the large amount of labor required in nursery work and the necessity for frequently passing in and out of the nursery, turnstiles are usually preferable to small gates.

15. SOIL MANAGEMENT

Even under the best and most economical methods of management a large amount of hand labor is required in nursery operations. *Intensive rather than extensive culture produces the best plants at the least cost.* The amount of labor required to work the soil properly and keep it free from weeds depends not only upon its texture and compactness but also upon the thoroughness of its preparation when the nursery is laid out.¹

Where it is the purpose to grow a variety of species of various ages, it is usually preferable to prepare all parts of the nursery for the production of all kinds of plants. The best preparation is a deep working of the soil. This loosening and mixing of the soil should be done in the autumn, care being taken to keep the better soil near the surface. It can be done by hand trenching or by plowing. Although hand working, loosening the soil to a depth of from 1 to 2 feet and throwing in ridges, gives the most thorough preparation, it is very costly and must usually give way to plowing. It is often advantageous to use a subsoil plow in order to loosen the soil to a depth of from 12 to 14 inches. All stones and roots should be removed and the land should be leveled or terraced where necessary. When the land is worked in the early autumn and allowed to lie fallow over winter, its physical condition is improved by its exposure to frost and winter rains.

As soon as the land is in condition to work in the spring, it should be manured, plowed, and harrowed. The top soil should be worked until it is in a finely divided condition, entirely free from lumps. On particularly foul sites where the ground is filled with weed seed or where there is an excess of undecomposed organic matter, it is advisable to cultivate a field crop for the first season. A crop like potatoes, cabbage, or corn that requires thorough and clean cultivation throughout the season is preferable. After the field crop is harvested in the autumn, the ground is plowed and left fallow over winter. The following spring it is in condition for the formation of the seed and transplant beds. *Under no conditions should sod be turned under in the autumn or spring and the area immediately used for seedbeds or transplant beds.* The cost of maintenance will be excessive and there is danger of serious depredations by the larvæ of the May beetle and other insects.

¹ Reuss, Hermann: Die forstliche Bestandesgründung. S. 113. Berlin, 1907.

When nurseries are maintained for a long period of time on the same site, it is well worth while to give the most careful attention to thorough soil preparation. An expenditure of \$100 or even \$150 per acre should not be considered excessive where the surface is uneven or where stones and roots must be removed and deep working is required.

Under special conditions, the shallow working of the soil, even in permanent nurseries, is preferable. This is particularly true of nurseries where only small and surface-rooted plants such as spruce are grown. Deep working may be harmful on soils that are naturally loose and open and where the fertility is chiefly in the surface layer. It is rarely advantageous in temporary nurseries.

16. DRAINAGE AND IRRIGATION

Surface drainage should be perfect. The slope of the land should be sufficient to carry off all surface water but not enough to cause erosion. The site should be brought to a uniform grade when it is relatively flat but with minor unevenness, so that water will not stand in pools in the depressions. Springy slopes and low flats where the water is near the surface should be drained by means of open ditches or covered drains. Such sites, however, should be avoided whenever possible.

Irrigation is necessary in the conduct of nursery operations except in the most favored localities and under exceptional conditions. Although some species can be grown without irrigation in regions of adequate precipitation for farm crops, an ample supply of water very greatly reduces the cost of the stock, materially increases the size and makes success more certain. It is particularly important that coniferous seedbeds be irrigated the first year.

The facilities for irrigation should be fully considered in locating the nursery. The water may be obtained from a near-by spring, stream or pond or from a well. The source of the supply should be at a higher elevation than the nursery in order that the water may be distributed by gravity. When the source is at a lower elevation, the water is elevated to a reservoir or tank located on the highest ground in the nursery, from which it is distributed by gravity as required. In small temporary nurseries no special provision is usually made for irrigation, but water is brought by

hand from a near-by well or other source from time to time as required.

17. Distribution of Water.— The arrangement for the distribution of the water is of considerable importance. It is usually brought from the reservoir to the beds in a series of iron pipes which are laid on the surface or at some distance below. When on the surface, the pipes are relocated each season and taken apart and stored over winter and during the spring when the ground is worked. This method of distribution is practiced in many of the forest nurseries in the United States. The main pipes should be at least two inches in diameter in large nurseries in order to permit a rapid distribution of water. The main pipes are laid along the main roads and the smaller ones along the lateral roads and paths at either side. Hydrants are located at convenient points.

There is considerable advantage in the distribution of water through pipes laid temporarily on the surface, as they can be shifted from one part of the nursery to another, depending upon the particular place where the seedbeds are located. Water is usually artificially applied only to the seedbeds, which may occupy one-tenth or less of the entire nursery. When the pipes are laid underground, all parts of the nursery should be piped so that the seedbeds can be located, if need be, in any part. Underground pipes should be below the frost line or else the water should be drawn off during cold weather. Where the water is drawn off during freezing weather, the pipes need be only sufficiently deep to escape the plow in working the soil.

Water is distributed to the beds in one of the following four ways:

- a. Sprinkling.
- b. Flooding.
- c. Percolation from furrows.
- d. Sub-irrigation.

18. SPRINKLING.— The distribution of water over the beds as a finely divided spray is admirable, as it is the nearest approach to rain. *It should be uniformly distributed at a rate sufficiently slow to permit its complete absorption by the soil.* The application should be sufficiently prolonged to wet the soil thoroughly to a foot or more in depth. Light sprinkling at frequent intervals, which only moistens the soil to a depth of 1 to 3 inches, is not as effective as a prolonged application at infrequent intervals.

The Skinner system of irrigation, by which a fine spray is uniformly distributed over the beds is rapidly coming into use in permanent nurseries in the United States. Although costly to install, in the end it usually proves less expensive than any other method of water distribution by sprinkling. In this method of irrigation a series of pipes is supported at a varying distance from the ground, in which small openings are made at from 2- to 4-foot intervals and fitted with special nozzles.

Both stationary and portable methods of installing the system have been practiced in forest nurseries. When the installation is



Photograph by E. J. Zavitz

FIG. 51. — The Skinner overhead system of irrigation in operation.

permanent $\frac{3}{4}$ -inch pipes with the nozzles at 4-foot intervals are usually used. The pipes are raised on iron or wooden posts from 3 to 6 feet above the beds. They are usually arranged parallel to each other and 50 feet apart. Under a water pressure of 30 pounds it is possible to irrigate for a distance of 25 feet on each side of the pipe when the units are 100 feet long (Fig. 51). The main feed pipe through which the water is brought to the overhead pipes should be at least $1\frac{1}{2}$ inches in diameter and the water should have a pressure of at least 25 or 30 pounds.

In the portable method of installation a single line of overhead $\frac{3}{4}$ -inch pipe 100 feet long with nozzles at 4-foot intervals is supported on iron standards about 1 foot above the ground. A small two-wheeled iron cart at one end of the line supports a small motor driven by water which slowly causes the pipe to rotate. The spray reaches to a distance of about 25 feet on each side of the line. The water is brought to the system through an ordinary garden hose from near-by hydrants. The pipe can be quickly uncoupled into short lengths and transferred to a frame on the cart, after which it can be easily transported to any part of the nursery.

19. FLOODING. — Special attention should be given to the construction of the beds in order to make the application of water by flooding effective. Each bed should be as nearly level as possible, and the paths surrounding it should be from 4 to 6 inches above the general level. The water is permitted to flow over the depressed beds as required, usually to the depth of from 2 to 4 inches. The ground becomes thoroughly saturated by this method of irrigation. It is used chiefly in regions of scanty summer rain or where for other reasons large quantities of water are required.¹ The chief objection to flooding arises from the fine sediment that it leaves on the surface of the small plants and the hard crust formed on the surface of the bed after the water is taken up by the soil. Where flooding is practiced the seed should be sown in drills so that the soil between the rows can be worked after each irrigation.

20. PERCOLATION FROM FURROWS. — The water may be applied so as to reach the plants by percolation through the soil. By this method of irrigation the water is made to flow in small furrows between the rows of seedlings or transplants or between narrow beds when the seed is broadcasted. The water will readily percolate for a distance of two or more feet at either side of the furrow in loose, permeable soil when the nursery is graded and suitably arranged. This is an excellent, inexpensive, and efficient method of irrigation. Its great advantage over flooding is in the non-formation of a surface crust, and its advantage over sprinkling is in its reduced cost and decreased loss of water through evaporation. It is particularly acceptable for irrigating transplants and

¹ Bates, C. G. and Pierce, R. G.: *Forestation of the sand hills of Nebraska and Kansas.* (U. S. Forest Service, Bul. 121, p. 26. 1913.)

hardwood seedlings grown in rows a foot or more apart or in narrow beds. Furrows are run between the rows or between the beds and water directed through them until the soil is adequately saturated, after which they are closed by cultivation.

21. SUB-IRRIGATION. — Sub-irrigation requires much less water than any method of surface irrigation. This method has been successfully introduced into some of the western nurseries.¹ The water is distributed through a system of concrete tiles open at the joints and laid a few inches under the surface. The water seeps into the soil and is distributed by capillary action.

22. The Amount of Water Required. —The seedbeds should be carefully watched during dry weather. Coniferous species show lack of water by the withering and dying of the lowermost leaves and by all the plants dying in irregular patches through the center of the beds. If water is not applied immediately after the first signs of damage are in evidence, all the plants over extensive areas may be killed within a period of four to seven days. Where an excess of water is applied, particularly on heavy soils and over extended periods, the roots are likely to rot, the tops turn yellow, and the plants finally die in patches.

Excessive watering results in the production of tender, overgrown, sappy plants that lack resistance when set in the field. On the other hand, the lack of water causes great loss in the seedbeds during the first and second years, and also in the transplant beds where the ground becomes dry soon after the plants are pricked out.

The amount of water necessary to apply during the growing season is extremely variable, depending upon the climate and the soil. In exceptionally favorable regions, irrigation may not be necessary. Again, it may be necessary to apply water but two or three times during the season. Over most parts of western United States, the frequent application of water throughout the growing season is essential for successful nursery practice. In the forest nursery at Halsey, Nebraska, weekly or bi-weekly irrigation is practiced except during periods of moist weather. In dry, hot weather as much as two inches per week are applied. At this nursery it was the former practice to apply all water with hose

¹ Bates, C. G. and Pierce, R. G.: *Forestation of the sand hills of Nebraska and Kansas.* (U. S. Forest Service, Bul. 121, p. 24. 1913.)

and spray; now, however, the beds of larger trees are irrigated by flooding and the seedbeds are usually flooded before the seeds germinate.

23. THE FERTILITY OF NURSERY SOIL: MANURING

Large amounts of potash, phosphorus, nitrogen, and other chemical elements in compounds available as plant nutrients are taken yearly from the soil by growing nursery stock. Nothing is returned to the soil as the trees are removed root and branch. A rapid deterioration of the soil takes place unless its fertility is maintained by the liberal application of fertilizers. Nursery stock can be successfully grown for a period of several years on exceptionally good soils without manuring, but sooner or later the application of fertilizer becomes necessary.

On rich, sandy loams and other soils having a high degree of fertility, the decrease in productivity due to successive cropping is often very slow. As a rule, fertilizers should not be applied until the appearance of the crop clearly shows their need. Experiments conducted at the Wind River nursery indicate that a heavy dressing of well-composted manure worked into the surface soil of the seedbed had the effect of stimulating top growth far more than root growth. It also had the effect of producing irregular-sized plants and retarding the formation of winter buds. These unfavorable results more than overbalance the increase in average size due to fertilizing.

The application of the plant nutrients that are deficient in the soil, without regard to their effect upon its physical condition, will seldom suffice. *Special attention should always be given to maintaining an adequate supply of humus.* As the nursery stock leaves nothing on the ground to decay and form humus, soiling crops and stable manure are usually preferable to concentrated or commercial fertilizers when used alone.¹

Whether a vegetable, animal, or mineral fertilizer alone or in mixture will give the best results at least cost depends upon local conditions as well as upon the physical and chemical characteristics of the soil. *Fertilizers are most effective when applied in the form of fertilized soil or compost.* Thereby the danger of excessive

¹ Mayr, Heinrich: *Waldbau auf naturgesetzlicher Grundlage*. S. 410. Berlin, 1909.

application is not likely to occur and they are brought to the young trees in their most useful form.

Extensive researches and experiments conducted in Europe by Heck, Grundner, Kienitz, Engler, Swappach, Möller, Reuss, and others *prove the necessity for the liberal use of fertilizers in permanent nurseries*. Recent investigations of Pettis,¹ Bates,² and others in the United States show favorable results from the application of farm manures and various commercial fertilizers. Experiments conducted by the author at New Haven on sandy loam from 1900 to 1908 show that two successive crops of 2-year white pine seedlings are as many as can be grown without applying fertilizers, as there is a marked falling off in size and quality, due entirely to soil exhaustion, particularly the absence of humus.

As fertilizers not only add useful plant nutrients to the soil but also improve its physical condition, sand added to a clay or other heavy soil, by improving its consistency and causing better plant growth, is a fertilizer. The application of stable manure or other well-rotted organic material to an overlight soil or a very heavy soil is particularly useful in improving its physical condition. It renders overlight soils less permeable and heavy soils more permeable to both air and water.

The materials which are brought into the soil by manuring and which directly supply a deficiency in plant nutrients are for the most part phosphates, potash salts, and nitrates or materials which become converted into these in the soil. Lime, magnesia, and sulphur in various forms can occasionally be applied to advantage. *The sole purpose of fertilizers is to increase growth and quality, whether it be brought about by their ameliorating effect upon the soil or by directly supplying the essential plant nutrients in available form.*

24. Classification of Fertilizers Used in Nursery Practice. — Although all kinds of materials that are useful in improving the fertility of soil may be used in nursery practice when properly applied, those most acceptable may be classed as follows:

a. Fertilizers of vegetable origin, such as leaves, moss, weeds, and other similar material; also soiling plants, such as the cowpea,

¹ Pettis, C. R.: New York forest, fish and game commission. Twelfth annual report, p. 29. Albany, 1907.

² Bates, C. G. and Pierce, R. G.: Forestation of the sand hills of Nebraska and Kansas. (U. S. Forest Service, Bul. 121. 1913.)

soy bean, lupine, buckwheat, and rye, grown on the site and plowed under.

b. Fertilizers of vegetable origin, such as forest litter and other refuse from the nursery mixed with rich loam, raw humus, turf or peat and composted for one or two years before using.

c. Fertilizers of animal origin, such as dried blood, guano, bone, tankage, and similar products. These materials are particularly rich in phosphorus and nitrogen in available form or in a form which gradually becomes available in the soil.

d. Fertilizers of animal and vegetable origin mixed, such as stable manure. The excrement of all kinds of warm-blooded animals mixed with straw, sawdust, or other litter.

e. Fertilizers of mineral origin, such as nitrate of potash, kainit, superphosphates, saltpeter, Thomas slag, hardwood ashes, turf ashes, lime, gypsum, clay, and sand. Many of these are rich in nitrogen, phosphorus, or potash. The last four, however, are chiefly valuable in improving the physical qualities of certain soils.¹

25. The Use and Application of Fertilizers of Vegetable Origin. — Fertilizing materials of vegetable origin should, as a rule, be thoroughly composted before they are applied to the soil, particularly the seedbed. They are slow to break down and mix with the mineral soil when applied in fresh condition. Ney² and other European writers emphasize the advantages from bringing them together and composting *until they are thoroughly disintegrated and broken down into small particles*. Hardwood leaves, moss, and other forest litter, when well decayed, are particularly useful for adding in liberal quantities to heavy impermeable soils. An application of a dressing from 2 to 4 inches in depth is very beneficial before the soil is turned over in the autumn, when seedbeds are to be made the following spring. The large quantity of fertilizers of vegetable origin necessary to make a radical change in the physical condition of the soil or to add adequately to soil fertility makes the cost of application excessive when they are brought to the nursery from a distance. The same results can usually be obtained at much less cost by crop rotation and the growing of soiling plants. Even when soiling crops are made use

¹ Vonhausen, Wilhelm: Die Düngung der Forstgärten. (Allgemeine Forst- u. Jagd-Zeitung, S. 228-231. 1872.)

² Ney, C. E.: Die Lehre vom Waldbau. S. 228. Berlin, 1885.

of, however, considerable quantities of mild manure, such as leaf mold, can be used to advantage in the seedbeds.

Provision for manures of vegetable origin must be made at least 1 year and usually 2 years in advance, because of the time required after gathering and bringing to the nursery before they are sufficiently disintegrated for advantageous use. Better results can usually be obtained at equal cost on average soils by adding animal or mineral fertilizers to those of vegetable origin because of their greater richness in available plant nutrients and the much less quantity required.

26. SOILING PLANTS IN NURSERY PRACTICE. — A great variety of soiling plants are used in nursery practice. Leguminous crops, such as cowpeas, field peas, soy beans, and lupines are usually best for this purpose because of their importance in increasing the supply of nitrogen. Buckwheat and rye are often useful on sites where nitrogen is supplied in other forms, because of the large amount of organic matter produced in a comparatively short time and the volume of humus that results from their decay. Cowpeas have given excellent results and are used by many nurserymen in the United States. The peas are sown broadcast in late May or early June, following the removal of the transplants. The crop is rolled to the ground in the autumn before the first severe frost and while the seed is still green. It is then covered with a heavy dressing of well-rotted farm manure, at the rate of 10 to 50 tons per acre.

Good results have been attained on light, sandy soils by applying a heavy dressing of stable manure in the winter or early spring and growing a soiling crop the following summer. This crop is plowed under in the autumn and the seedbeds or transplant beds prepared the following spring. The soiling crop not only enriches the soil in nitrogen but, when grown on a heavy dressing of stable manure, breaks it down into more usable form for the following crop.

Buckwheat is very largely used in the forest nurseries in New England. It grows well on a variety of soils, can be sown as late as June, and plowed under 2 or 3 months later. There is no better crop for clearing the soil of weeds, and none that rots more rapidly after plowing under or that leaves the soil in better physical condition for nursery crops. Excellent results have been attained on the sandy loam soils near New Haven, Conn., by

sowing buckwheat in early summer after the nursery stock has been removed. A heavy dressing of stable manure is applied shortly before the buckwheat matures and the whole plowed under. The nursery beds are made the following spring. If the buckwheat is allowed to mature, a volunteer crop comes up the following spring in the seedbeds and transplant beds, which entails considerable expense for removal.

Cowpeas and other varieties of peas and beans do best on soils rich in lime.¹ They make an indifferent growth and add but little to soil fertility when grown on exhausted soils poor in lime. Such soils should be enriched by the application of fertilizers, particularly lime, before the soiling crop is grown. The yellow lupine does much better than peas and beans on soils poor in lime, but when used on exhausted soils the area should be manured with Thomas slag or some other fertilizer with like properties.

When leguminous soiling crops are grown twice in succession on poor soils, there is a very large increase in their fertilizing value the second year, due to the greater abundance of tubercles on the roots and the resulting increase in available nitrogen in the soil. If the root tubercles fail to develop satisfactorily on the roots of the soiling crop, the soil should be inoculated. This can be done by mixing earth from fields where they have developed abundantly with the seed before sowing, or by scattering inoculated soil over the sown field.

If the soil is allowed to become exhausted, there is always great difficulty and considerable expense involved in improving its condition by the use of soiling crops. It is usually advantageous to alternate nursery crops with ordinary field crops whenever sufficient land is available. This is the ordinary practice in many commercial nurseries. A field crop, such as potatoes or corn, is grown the first year after fertilizing with a heavy dressing of stable manure or other suitable fertilizer. Nursery crops are then grown for two or three years. Clover, alfalfa, and other perennial legumes may be grown for one or more years followed by a cultivated field crop and later by nursery crops. *Nursery crops should always be preceded by cultivated field crops, such as potatoes and corn, in this system of rotation.* Otherwise, the ground will be left in foul condition and entirely unsuited for nursery purposes.

¹ Mayr, Heinrich: *Waldbau auf naturgesetzlicher Grundlage*. S. 410. Berlin, 1909.

27. The Use and Application of Fertilizers of Animal Origin. —

Fertilizers of animal origin are chiefly dried blood, tankage, guano, hoof-meal, bone, and fish. The dung of domestic animals is usually placed in a class by itself, as it is invariably mixed with straw and other litter. Dried blood, tankage, guano, and hoof-meal are particularly rich in available nitrogen, while bone and fish are rich in phosphoric acid. All of the above are concentrated manures of high market value and are chiefly used in nursery practice to enrich low-grade fertilizers or for special purposes. They are valuable for stimulating rapid growth in seedbeds when applied just before the beds are formed or as a top dressing at the beginning of the second year's growth. In the latter case, care should be taken not to overstimulate growth by excessive application. When applied before seeding, it is best to mix them thoroughly with the surface soil when the beds are formed. From 500 to 1500 pounds per acre should ordinarily be used, depending upon the condition of the soil. A top dressing of fertilizers rich in plant nutrients tends to hold root development near the surface and to produce a root system well suited for transplanting.

28. FARM MANURES. —The dung of domestic animals varies greatly in quality, depending upon its origin, the method of storage, and the amount and kind of litter with which it is intermixed. The richer the food of the animal in plant nutrients, the more valuable the excreta as a fertilizer. The less the loss of valuable constituents by exposure to rain and leaching and by uncontrolled fermentation the better the quality. *Farm manures are the most useful fertilizers for general purposes that can be used in nursery practice either alone or in combination with other materials composted with them. This is particularly true whenever they can be obtained at reasonable cost. Not only are they rich in plant food, but their large bulk makes them of superior value in improving the physical condition of the soil.* Cow manure is better than horse manure because of its greater freedom from litter and the less danger of its becoming "fire-fanged" during storage. Much less time is required for its decomposition.

Farm manures in the fresh state should be used in nursery practice only when applied to farm crops or soiling crops in rotation with nursery crops. When fresh farm manures are received at the nursery, they should be rotted either out of doors in piles known as compost heaps or under cover where loss from leaching is prevented.

Leaves, nursery refuse, bits of turf, raw humus, forest litter, and similar materials, when available at little cost, can be added to the manure advantageously in many instances. Lime is sometimes added to hasten decomposition and prevent the loss of nitrogen during fermentation. Phosphate rock and kainit are sometimes added to increase the phosphorus and potash. Farm manures, particularly horse manure, when loosely piled out of doors are liable to heat and become "fire-fanged." This causes them to lose a large part of their plant nutrients, particularly nitrogen. This condition can be prevented and the decomposition hastened by building a fence around the pile and turning in a number of hogs to tread it down and root it over. It becomes well rotted in from 12 to 16 months and suitable even for seedbeds.

A simple form of compost heap, suitable for the nursery, can be made as follows: A layer of rich forest soil or turf, 8 to 10 inches in thickness, is spread over the ground. A layer of the various fertilizing materials that are to be composted are spread over the forest soil or turf. The pile is built up of alternating layers of soil or turf and fertilizers, each layer not over 4 to 6 inches in thickness. A layer of rich soil, 5 to 8 inches deep, is spread over the pile. The length of time required for the compost to become suitable for use depends upon the character of the fertilizing materials and the rapidity of decay. A year will usually suffice.

29. The Use and Application of Fertilizers of Mineral Origin.— Although fertilizers of mineral origin have as yet but little use in forest nurseries in the United States, they can often be used to great advantage in localities where farm manures are not available or where they are required to improve the physical condition of the soil. The more important of these materials are nitrate of potash, kainit, Chilian saltpeter, superphosphates, Thomas slag, wood ashes, turf ashes, lime, gypsum, sand, and clay. Lime, gypsum, sand, and clay are chiefly useful in improving the physical conditions of the soil. Lime also adds to soil fertility by neutralizing acids and acid compounds, promoting the formation of nitric acid and nitrates, and in making other plant foods in the soil more available. When lime is used in nursery practice, it should be applied only to soils in which it is clearly deficient and then, as a rule, in compost.¹

¹ Schlich, Wm.: Manual of forestry. 4th ed., vol. II, p. 204. London, 1910.

Recent experiments by Guif¹ on sandy soil poor in plant nutrients show the great importance of lime even when used alone in stimulating growth in spruce, Scotch pine, and fir, both in the seedbed and in the transplant bed. The experiments appear to show that lime had a better effect on growth than superphosphates, nitrate of potash, or cow manure where the following amounts were used per 100 square feet of seedbed or transplant bed.

| | Lbs. |
|-------------------------|------|
| Nitrate of potash | 7.3 |
| Superphosphates..... | 9.2 |
| Lime..... | 18.3 |
| Cow manure..... | 550 |

Nitrate of potash, Chilian saltpeter, and other materials rich in available nitrogen should not be applied to the seedbeds or transplant beds until they are needed by the growing plants, because they are leached from the soil and lost by excessive rainfall. *They should be applied sparingly, only in quantity necessary for immediate use. When used in excess, not only is the surplus lost through leaching, but the young nursery stock, particularly coniferous stock, is likely to be seriously injured.* It is best to apply them at the rate of 100 to 200 pounds per acre, one or more times during the growing season as found necessary, or in mixture with other materials.

Kainit and wood ashes are particularly rich in potash. Either may be used to supply a deficiency in potash due to the repeated removal of nursery crops. Kainit gives good results on soils that are inclined to be overwet. Wood ashes, although chiefly valuable for their potash content, contain considerable phosphoric acid and also serve as an important amendment for sandy soils. Leached ashes have lost a large part of their available plant food, but as a soil amendment are as valuable as in the unleached form. Potash is not readily lost from the soil by leaching. Either kainit or wood ashes can be added to the soil in the autumn and by so doing all danger from applying to the beds immediately before the seed is sown or after the plants are up is removed. A ton of kainit per acre is not too much to apply to overwet soils deficient in potash. One or two tons of hardwood ashes per acre can be used as a top dressing in the autumn, to be worked into the soil the following spring.

¹ Guif, E.: Annales de la Science Agron., 6. 1913.

Mineral phosphates are derived chiefly from phosphate rock of several varieties and from Thomas slag, a by-product in the manufacture of steel. When applied in the raw state phosphate rock is very slow in becoming available as plant food. It is usually chemically treated to produce the so-called superphosphates in which the phosphorus is in available form for plant food. Raw phosphate rock, Thomas slag, and the superphosphates are rarely used in nursery practice except in mixture with other materials. Phosphate rock and Thomas slag are usually mixed with composts of vegetable origin, while superphosphate is one of the principal ingredients of standard mixed commercial fertilizers which are sometimes used as a top dressing.

If the soil is not of the proper consistency when the permanent nursery is first established, it is usually advisable to improve it by adding sand to a heavy stiff soil and loam to a very loose, light soil. Although this procedure entails considerable expense, it will usually pay in the end. Wherever muck can be obtained at little cost for transportation, it is an excellent amendment for sandy soils as well as tenacious clays. The actual plant food content, however, can be much more economically secured from other sources. Its value depends upon the large content of organic matter which has the same physical effect upon the soil as humus. Large quantities are necessary in order to improve materially the physical condition of the soil. At least 40 to 50 tons of dry muck per acre should be used. Its effect is lasting, and it can be gradually applied through a series of years. When used on soils deficient in plant food, lime and commercial fertilizers rich in the deficient nutrients should also be applied.

30. The Quantity of Fertilizer Required. — The quantity of fertilizer necessary depends not only upon the kind of soil, but also upon the species and the length of time that the plants remain in the beds. The quantity, therefore, can be stated only in a general way. *The condition of the stock invariably indicates whether we are using adequate fertilizer for acceptable results.*

Heavy applications of farm manures and commercial fertilizers are usually expensive. A part of this outlay can be recovered by growing a field crop immediately after applying the manure or other fertilizer. This procedure gives a change of crops, permits a thorough working of the soil, and removes all danger of overstimulation of growth in the nursery stock. A common practice

with nurserymen is to work the nursery under a rotation of 3 or 4 years. A heavy dressing of farm manure or other fertilizer is applied and a farm crop is grown the first year. This is followed by seedbeds or transplant beds which occupy the soil for 2 or 3 years, after which the rotation is repeated.

Pettis¹ has made the light, sandy soils of the New York State nurseries in the Adirondack Mountains highly fertile and has improved their consistency by using muck, hardwood ashes, and nitrate of soda as the principal fertilizers. The muck, which contains nearly 70 per cent of organic matter, is excavated and exposed to the air for several months before using. A heavy dressing is spread over the soil in late winter or early spring, and unleached hardwood ashes (40 bushels per acre) added to neutralize the acid. Later when the beds are formed, the nitrogen is increased by the application of from 300 to 400 pounds of nitrate of soda. Although the above produced excellent results, the same author² has found that well-rotted horse manure is equally, if not more, efficacious at less cost.

It has been the practice on the loose, sandy soil at the Halsey nursery³ to grow nursery stock for 1 or 2 years and after its removal to apply from 50 to 120 tons of well-rotted farm manure per acre. This is turned under in the spring and a soiling crop grown the first season, which breaks down the manure into more available form. The soiling crop is plowed under in the autumn, and the seed or transplant beds formed the following spring.

At the Fort Bayard nursery soil fertility is maintained by applying well-rotted horse manure at the rate of 25 to 30 tons per acre at intervals of two to four years. Mexican beans are also grown as a soiling crop. At the Monument nursery, after the trees are removed in the spring, a liberal application of well-rotted stable manure is spread over the land and plowed under to a depth of 10 inches. The area is then sown to field peas at the rate of 75 pounds per acre. As soon as the peas are in blossom they are plowed under and a second crop sown. This crop is plowed under

¹ Pettis, C. R.: New York forest, fish and game commission. Twelfth annual report, p. 29. Albany, 1907.

² Ibid: How to grow and plant conifers in the northeastern states. (U. S. Forest Service, Bul. 76. 1909.)

³ Bates, C. G. and Pierce, R. G.: Forestation of the sand hills of Nebraska and Kansas. (U. S. Forest Service, Bul. 121, p. 28. 1913.)

just before the peas mature, and the seedbeds and transplant beds formed the following spring. At the Pilgrim Creek nursery sheep manure is applied just before the formation of the beds at the rate of 3.1 cubic feet per 100 square feet of seedbeds, and from 4 to 5 cubic feet to an equal area of transplant beds. At the Garden City nursery stable manure is applied before growing cow-peas as a soiling crop in rotation with nursery crops.

The author has been very successful in growing successive crops of coniferous seedlings on sandy loam by the application of well-rotted cow manure, bone meal, and hardwood ashes. The fertilizer is applied in alternate years prior to the formation of the seedbeds and in the following amounts.

| | |
|-------------------------------|------------------------|
| Cow manure..... | 10 to 30 tons per acre |
| Bone meal..... | 5 to 8 cwts. per acre |
| Unleached hardwood ashes..... | 8 to 16 cwts. per acre |

The cow manure and one-half of the other fertilizers are uniformly spread over the soil and turned under in the early spring. The remainder of the bone meal and ashes are worked into the surface soil when the beds are formed. *Experience shows that it pays to apply fertilizer in sufficient quantity to sustain vigorous growth in seedlings when grown in dense stands.*

Van Slyke¹ recommends for general nursery practice the following amounts of various commercial fertilizers per acre to overcome any marked deficiency in nitrogen, available phosphoric acid and potash.

For deficiency in nitrogen use one of the following:

| | Lbs. |
|-----------------------------|---------|
| a. Nitrate of soda..... | 60-120 |
| b. Sulphate of ammonia..... | 50-100 |
| c. Dried blood..... | 100-200 |

For deficiency in available phosphoric acid use one of the following:

| | Lbs. |
|------------------------|---------|
| a. Acid phosphate..... | 200-400 |
| b. Dissolved bone..... | 175-350 |
| c. Bone meal..... | 250-500 |

For deficiency in potash use one of the following:

| | Lbs. |
|----------------------------|---------|
| a. Nitrate of potash..... | 60-120 |
| b. Sulphate of potash..... | 60-120 |
| c. Kainit..... | 240-480 |

¹ Van Slyke, L. L.: N. Y. Agr. Exp. Sta. Bul. 94 (new series).

Schlich¹ states that for ordinary nursery purposes the following application of fertilizer may be considered as suitable. Stable manure, 80 to 100 cwts. per acre, or a mixture of the following: basic slag (Thomas slag) 10 cwts.; sulphate of potash 5 cwts., or kainit 20 cwts.; and sulphate of ammonia 1 to 2 cwts.

The large commercial forest nurseries at Halstenbek, Germany, rely almost entirely upon horse manure, street sweepings, raw humus, weeds, and nursery litter for the maintenance of soil fertility.² As a rule, these materials are composted in large compost houses. The horse manure and raw humus or street sweepings are arranged in alternate layers, the former in layers about 5 inches in thickness and the latter about one-half as thick. As much as 100 cubic yards of composted material is often applied to a single acre of coniferous seedbeds. Only from one-half to one-quarter as much is used for most broadleaved species. Although commercial fertilizers are rarely used, the growth of spruce and occasionally other species is sometimes stimulated by applying Chilian saltpeter between the rows, at the rate of 200 to 250 pounds per acre.

Scotch pine seedlings have been grown for 70 years in some European nurseries without rotation with other crops. The beds are formed in April or early May, the seed sown in drills, and the stock removed a year later. The beds are immediately resown, and the cropping repeated in the same manner year after year. The soil is fertilized each year with a mixture of moor soil, ashes, and nursery refuse, composted for at least one year.

¹ Schlich, Wm.: *Manual of forestry*. 4th ed., vol. II, p. 204. London, 1910.

² Schwarz, Alexander: *Der Waldpflanzenzucht-Betrieb in und um Halstenbek (Schleswig-Holstein)*. (Forstw. Centralblatt, S. 472-502. 1903.)

CHAPTER XIII

THE FOREST NURSERY (*Continued*)

1. Cultural Operations; Technique and Methods

THE portions of the forest nursery that are not lying fallow or given over for the time being to soiling and agricultural crops are formed into *seedbeds* and *transplant beds*. The relative proportion of each depends upon the kind and character of the stock produced. In exceptional cases only seedlings are grown, the stock being transferred directly from the seedbed to the plantation. In other cases, the seedlings are all transferred to transplant beds for a period of one or two years before planting in the field. When the stock is made into transplants the area of the seedbeds varies from one-twentieth to one-sixth of the area of the transplant beds, depending upon the species and the length of time that the stock remains in the seedbeds and in the transplant beds.

2. SEEDBEDS

In most nurseries seedlings are grown in rotation with transplants and other crops. The size and form of the seedbeds depend upon the locality and species and also upon the cultural methods employed, particularly the method of shading, watering, and working the soil.

Assuming that the soil has been adequately enriched and prepared by previous cultivation and cleaned of all debris, such as sods, weeds, roots, and stones, the beds are formed shortly before the seed is sown.

In European practice, seedbeds are usually made from 1 to 1.2 meters (3.28 to 3.94 feet) wide.¹ In most of the large forest nurseries of northern Germany the beds for all species are 1.2 meters (3.94 feet) wide and usually of the same length as the compartment, or when the compartment is large of but one-half its length. When the beds are sown broadcast or in closely

¹ Heyer, Carl: *Der Waldbau oder die Forstproduktenzucht*. 5. Aufl., 1. Bd., S. 228. Leipzig, 1906.

spaced drills, a width greater than 4 feet is objectionable as they cannot be cultivated and weeded readily from the paths. When the drills are wide-spaced so that one can walk between them in weeding, the beds are often 6 or more feet wide. Not infrequently a single bed occupies an entire compartment. Seedbeds in the United States in which conifers and the small-seeded broad-leaved species are grown are usually 4 feet wide.

Walnut, oak, and other hardwoods that can be grown without shade are usually sown in wide-spaced drills, without dividing the compartments into separate beds.

Preliminary to forming the beds, particularly when they are 6 feet or less in width, a measuring line is stretched along the two sides of the compartment, on which the ends of the beds abut. Stakes are driven to mark the sides of the beds and the paths. Lines are stretched across the compartment and fastened to the stakes, thus marking off the beds and the paths (Fig. 52).

When it is advisable to raise the surface, soil is removed from the paths and thrown into the adjacent beds until the desired elevation is attained. The surface is shaped with the ordinary garden rake and a special form of roller which brings it to a uniform contour.

The elevation of the seedbeds above the paths depends upon their width, the character of the soil, and the method of irrigation practiced. Seedbeds more than 4 feet wide are seldom raised above the paths and the surface rounded to bring the middle

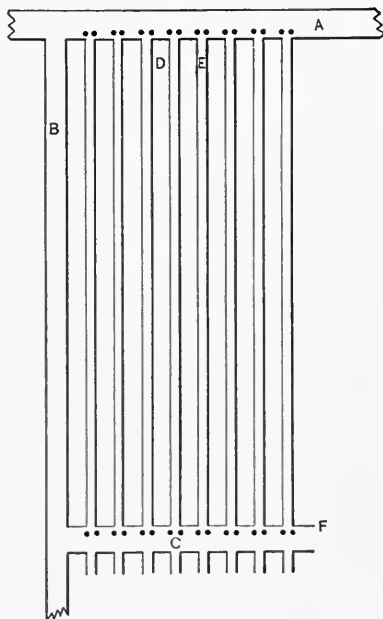

FIG. 52. — Diagram of the arrangement of seedbeds in the compartment.

- A. Main road.
- B. Secondary road.
- C. Temporary road on which the ends of the seedbeds abut.
- D. Seedbeds.
- E. Paths.
- F. Line of stakes shown as black dots.

higher than the margin. On loam and clay soils the 4-foot bed should be, as a rule, from $1\frac{1}{2}$ to 3 inches higher in the middle than at either side. A well-rounded bed permits of more perfect drainage. On porous soils where water does not stand even after prolonged rains, the beds should not be raised appreciably above the paths or made higher in the middle.

Wherever irrigation by flooding is practiced the beds should be flat and depressed below the paths.

3. Rolling the Seed-beds.

—After the beds have been brought to the desired contour, it is usually advisable to roll them preliminary to seeding, as it firms the surface soil and makes it more retentive of moisture.

When the beds are 6 feet or less in width, the roller is usually of the same width as the beds (Fig. 53). When the surface of the bed is flat the ordinary garden roller is used.

When the surface of the bed is rounded the roller must be of a form suitable to give the desired contour. The revolving roll is usually turned from a piece of hard wood of the same

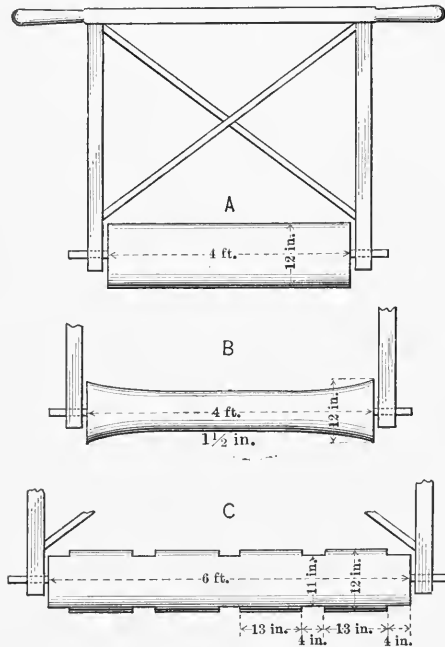

FIG. 53. — Types of rollers used in forming seedbeds.

- A. Roller for forming flat beds.
- B. Roller for forming flat beds with a curved surface.
- C. Roller for forming flat beds sown in strips.

length as the width of the bed. It is 12 inches in diameter at the ends and from 9 to 6 inches in the center, depending upon the contour of the beds.

A third type of roller is used when the seed is sown in strips lengthwise of the bed and not uniformly over the surface. The revolving roll is also turned from a piece of hard wood of the same

length as the width of the bed. Its diameter in its wider parts is 12 inches and in the narrower parts 11 inches. The wider divisions are 13 inches wide and the narrower ones only 4 inches. Where this method of seeding is practiced the beds are 6 feet wide. When the roller is drawn over the bed, it leaves four depressions 13 inches wide and $\frac{1}{2}$ inch deep, separated by slightly elevated strips 4 inches wide. The seed is sown only in the depressions. This method of seedbed formation is highly recommended by Kensington.¹ When spruce is grown in fully stocked seedbeds 4 feet wide, the plants in the interior of the beds are usually dwarfed as compared with those on and near the border. This detriment to the production of high grade stock can be obviated by the above method of culture.

4. Curbing the Seedbeds. — A curb of wood or stone is often placed around the seedbeds when less than 6 feet in width. The curb checks the washing of the soil in raised beds and permits the development of a full stand of seedlings along the borders. Coniferous seedbeds are curbed the first year in many nurseries in the United States. The curb is usually constructed from 4 by 1 inch strips of relatively inexpensive lumber, set on edge and nailed to stakes driven into the soil at suitable intervals. The upper edge of the curb should be flush with, or but slightly above, the surface of the seedbed. When the ground is sloping and terracing is necessary, heavy curbs made of stones or poles may be necessary on the lower sides of the seedbeds while no curb whatever is needed on the upper. *It is becoming more and more the practice to dispense with the curb in many of the large commercial nurseries and depress the paths but slightly below the margin of the beds.*

5. Time of Seeding. — The control of the moisture in the seedbeds through irrigation and shading and their protection from birds and rodents make it possible to extend the time during which the seeding can be done in the nursery much beyond that acceptable for direct seeding in the open. Seedbeds may be sown in most parts of the United States at any time when the soil is suitable for working from late autumn to early summer. The best time within this period depends upon the following:

- a. The species.
- b. The local climate.
- c. The method of nursery practice.

¹ Kensington, W. C.: State afforestation in New Zealand. (Report, Dept. of Lands. Wellington, 1911.)

All species in which the seed cannot be easily kept over winter without great loss in viability should be sown in the autumn. Thus, chestnut, many oaks, and the various species of fir and cypress usually produce much better stands when sown in the autumn. Western white pine, sugar pine, larch, and the Pacific form of Douglas fir should, in most localities, be sown in the autumn. When sown in the spring or early summer they are much slower and more irregular in germination. The important dangers to which autumn-sown seedbeds are subjected are injury by mice and other rodents and germination before cold weather begins. *Provision must be made to protect the beds from rodents and the seeding must be delayed until all danger of warm weather is past.* Although all species may be sown in the autumn when adequately protected, it has been the usual practice in the United States to sow in the spring or early summer, except species slow to germinate or which produce seed difficult to store in dried condition.

Local climatic conditions may be favorable for autumn seeding in one locality and less favorable in another. Regions subject to heavy winter precipitation and prolonged summer drought are usually favorable for autumn seeding, while regions subject to dry, cold winters with little snow are much less favorable. Regions with a short growing season and late spring are usually favorable for autumn seeding, while regions with an early spring and long growing season are more favorable for spring seeding.

The present tendency in nearly all parts of the United States is more and more toward autumn seeding because of its relation to nursery practice. It makes possible the distribution of labor to better advantage. Work is comparatively slack in the late autumn, while the lifting, packing, and shipping of nursery stock during the spring months often delay the seeding until early summer. Stock produced from late seeding is but one-half to one-third as heavy as that from autumn or early spring seeding and is much more subject to winter killing.

Autumn-sown seedbeds that are shaded during the first year are much more liable to be overgrown with moss than are spring-sown beds. When the soil is loose and sandy, damage from moss seldom occurs. On loam and heavier soils, however, the abundant growth of moss often completely covers the soil between the young seedlings. *This condition can be remedied best by breaking*

up the compact surface soil of autumn-sown beds in the early spring before the seed germinates.

6. Methods of Seeding.—Seedbeds are sown *broadcast* or in *drills*. There is much controversy regarding the advantages and disadvantages of each. Broadcast seeding is chiefly practiced in sowing conifers and small-seeded broadleaved species in seedbeds that are covered prior to germination and the young seedlings protected by shading. Drill seeding is the general practice in sowing in the open large-seeded broadleaved species, such as chestnut, oak, and hickory. Until recently the drill seeding of conifers was extensively practiced in the nurseries on the National Forests. In recent years, however, this practice has largely given way to broadcast seeding. In most localities and under average conditions the latter is the less expensive and better method. Much depends, however, upon the species, climate, and soil conditions under which the trees are grown.

The chief advantage in broadcast seeding is *the much larger number of plants that it is possible to produce per given area of seedbed and the resulting decreased cost of production*. For this reason broadcast seeding is preferable on the ordinary nursery soils, such as sand and loam, that have adequate water supply when the stock remains in the seedbed only one or two years. When it is necessary to hold the stock over for an additional year after it has reached the most suitable size for lifting, drill seeding makes the checking of growth by wrenching or root pruning easier to accomplish. Drill seeding is usually preferable on heavy soils as it renders cultivation possible, thus facilitating the entrance into the soil of both air and water.¹

The following advantages in drill seeding under special conditions of soil and climate may overbalance the economic advantage usually possible in broadcast seeding.

- a. More complete germination is usually attainable.
- b. The cultivation and loosening of the soil is possible.
- c. Damping-off can be better controlled through cultivation.
- d. Irrigation is not so essential.
- e. Root pruning can be better accomplished.

7. SEEDING IN DRILLS.—After the beds have been rolled or otherwise smoothed, drills of suitable depth and width are made

¹ Bates, C. G. and Pierce, R. G.: *Forestation of the sand hills of Nebraska and Kansas*. (U. S. Forest Service, Bul. 121, p. 30. 1913.)

for the reception of the seed or else machines are used which form the drills and sow and cover the seed in a single operation. Many tools and special devices have been made to facilitate drill seeding. When the drills are close together, 5 inches or less, they should extend crosswise of narrow beds in order to facilitate weeding and hoeing. When of greater distance apart it is usually advantageous to run them lengthwise of wider beds in order to facilitate cultivation.

Broadleaved species, such as walnut, hickory, oak, chestnut, ash, maple, and catalpa, which are usually grown in the United States in uncovered and unshaded seedbeds are sown in drills from 6 to 30 inches apart depending upon the mode of cultivation. When horses are used in cultivating the beds the drills should be not less than 18 inches apart.

Bates and Pierce¹ recommend the following practice in sowing the larger-seeded broadleaved species in Nebraska and Kansas when irrigation is practiced. Prior to seeding the well-graded and tilled area is furrowed at 30-inch intervals. The furrows are 4 inches deep, and water is permitted to flow through them until the soil is thoroughly saturated. The next day the seed is sown in the moist furrows and covered to a depth of from 1 to 2 inches. The ground is cultivated immediately afterward. Sometimes water is again run in the furrows before the seed germinates. When it is necessary to apply water after the trees are up, it is run through temporary furrows between the rows.

When the larger-seeded hardwoods are sown in seedbeds tilled with hand cultivators or hoes, a drill spacing of from 6 to 12 inches is adequate for all but the most rapidly-growing species, particularly when the stock remains in the seedbed but a single year.

In many of the larger commercial forest nurseries in Europe the larger-seeded broadleaved species are grown in seedbeds 1.2 meters (3.94 feet) wide. The drills run lengthwise of the bed, there being 6 drills per bed for oak and 8 for beech, ash, maple, and linden.

Small-seeded broadleaved species, like alder, birch, and red gum, can seldom be successfully grown in open seedbeds. The beds must be mulched or otherwise protected prior to germina-

¹ Bates, C. G. and Pierce, R. G.: *Forestation of the sand hills of Nebraska and Kansas.* (U. S. Forest Service, Bul. 121. 1913.)

tion and the young seedlings given partial shade for a few months following germination.

In Europe alder is usually grown in seedbeds under a high cover of wide-spreading trees which provide approximately half shade. Birch seedlings are very small and delicate. They are likely to be killed by a few days' exposure to full sunlight at the time of germination unless protected by shading. They grow rapidly and can usually be exposed to full sunlight 6 to 8 weeks after germination.

Small-seeded broadleaved species grown in seedbeds under shade are usually sown broadcast or in closely-spaced drills extending crosswise of the beds. They are subjected to the same manner of treatment as coniferous species during the period of germination and early growth.

Gayer¹ recommends for small-seeded species, such as spruce, larch, and most pines, drills $\frac{3}{4}$ inch deep and $1\frac{1}{4}$ inches broad, and a drill distance of 4 inches. A drill distance of more than 4 inches is seldom justified with slow-growing conifers that are carried but 1 or 2 years in the seedbed. A wider spacing does not permit sufficient utilization of the soil and abnormally increases the cost of the stock. Larch and other species of rapid juvenile growth and slower-growing species that remain longer than 2 years in the seedbed permit a wider spacing of the drills.

The drills in most coniferous nurseries in the United States where drill seeding is practiced are usually made at from 4- to 6-inch intervals. The former practice was to space the drills at from 6- to 12-inch intervals and to use hand cultivators in tending the seedbeds. The tendency during recent years has been toward closer spacing and increasing the number of seedlings per square foot.

In some of the larger nurseries, particularly those on the National Forests, the drills run lengthwise of the beds and the seeding is done with the Planet Jr. hand drill which automatically regulates the spacing of the drills, the quantity of seed, and the depth of cover. Although this method permits uniform and rapid sowing, better cultivation and control of damping-off, and easier root pruning and lifting of the stock, it is being abandoned due to the relatively small number of seedlings produced per square foot of seedbed as compared with broadcast seeding.

¹ Gayer, Karl: *Der Waldbau*. 4. Aufl., S. 341. Berlin, 1898.

8. *Formation of the Drills.* — The depth, form, and size of the drills depend upon the size of the seed and the character of the soil. Large seed requires narrow but deep drills, the seed falling in a single line. Small seed requires broad but shallow drills, the seed falling in narrow bands rather than in lines. They should be deeper in dry, sandy soils than in heavy, moist soils.

A great variety of implements are in use for forming the drills. Drill markers for large-seeded broadleaved species that are sown in wide-spaced drills are operated by horse power, ten or more drills being made in a single trip over the compartment. When similar species are sown in closer-spaced drills in narrow beds the drill marker is like a strong-toothed rake with large teeth spaced 2 or more inches apart, depending upon the spacing of the drills. The drills are made 3 or 4 at a time by drawing the implement lengthwise or crosswise of the bed. The seed is usually sown by hand and a hoe or rake used in covering it.

Small, closely-spaced drills for conifers and small-seeded broadleaved species are often made with *marking boards* or *drill rollers*.

9. *Marking Boards.* — Marking boards permit of accurate and rapid work. Although a great variety of such boards are in use, they are essentially alike in their application. They can be used only when the surface of the bed is flat. They are of the same length as the width of the bed and of variable width, depending upon the spacing of the drills and the number made with a single application of the board. For moderately deep, narrow drills equally spaced the form described by Heyer¹ is as good as any. Three triangular battens about 1½ inches on a side are attached to two cross pieces parallel to each other and at the desired distance apart. By placing the board across the bed and pressing the battens into the soil three V-shaped drills are made, the depth depending upon the pressure applied to the board (Fig. 54).

For smaller single or double drills, small battens of variable shape are nailed to the under side of a board, as long as the width of the bed. Small seeds, as of spruce and most pines, should be sown in a narrow band rather than in a single line.

¹ Heyer, Carl: *Der Waldbau oder die Forstproduktenzucht*. 5. Aufl., 1. Bd., S. 274. Leipzig, 1906.

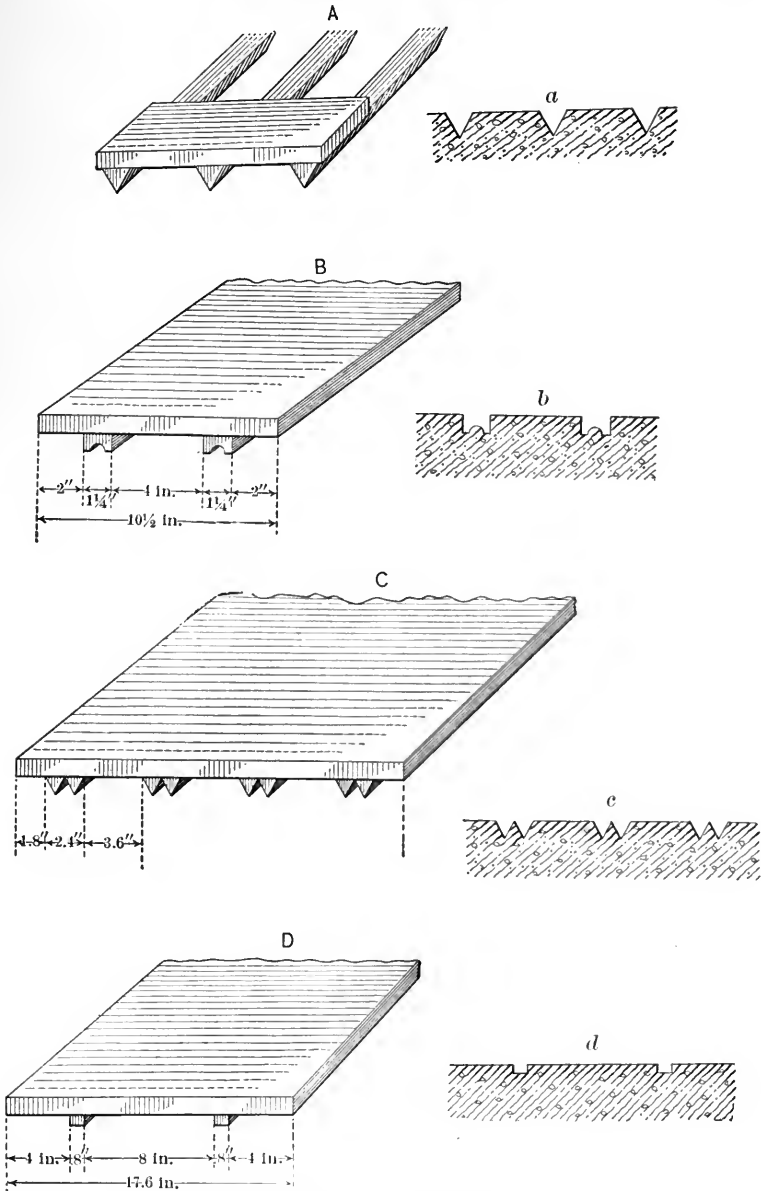

FIG. 54. — Types of marking boards.

- A. Marking board with V-shaped battens.
- B. Marking board with Ω-shaped battens.
- C. Marking board with W-shaped battens.
- D. Board for marking broad drills.

a, b, c, d. Form of drills.

In all of these boards the form and size of the drill is determined by the shape of the batten. When the construction of the batten is triangular, the seed necessarily lies in a single narrow line. When wider drills are desired, the batten should be rectangular. When concave on the lower face, the seed is thrown into two lines at the outer margins of the drill.

10. Drill Rollers. — A number of roller implements have been constructed for forming the drills. They are very effective, permit of rapid work, and are recommended when a large amount of seeding is done in drills. The form devised by Sauer¹ permits of very

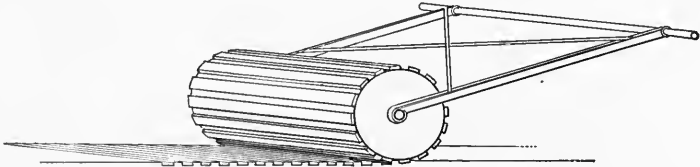

FIG. 55. — The Sauer type of drill roller.

rapid work. It places the seed at the best depth and the drills at a uniform distance apart. In order to use this implement, however, the beds should be perfectly flat, the surface soil finely pulverized and neither too moist nor too dry. It consists of a hardwood roller of the same length as the width of the bed, on the

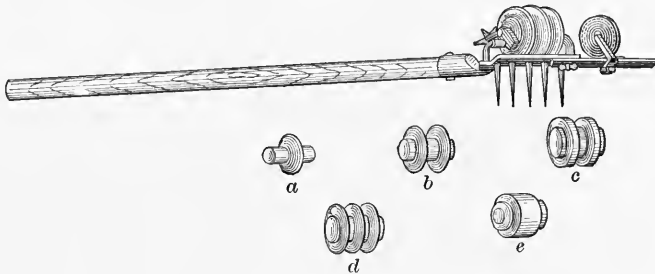

FIG. 56. — The Spitzenberg drill former.
a, b, c, d, e. Detachable rollers.

circumference of which are nailed a number of battens spaced at the desired drill distance. The form of the battens determines the form of the drills (Fig. 55).

¹ Sauer, Karl: Säeapparat für Nadelholz-Saatbeete. (Forstw. Centralblatt, S. 449-452. 1904.)

The Spitzenberg drill former¹ introduced from Europe does not permit of as rapid work but is adapted for use on seedbeds curved upward in the middle and for making the drills of variable depth and form. The tool is fitted with a number of detachable rollers for making drills of variable depth and spacing. It has a straight handle like a hoe and is drawn back and forth across the bed, the roller with its elevations forming the drills. A marker attached to the roller forms a line in the soil parallel with the drills which serves as a guide in spacing (Fig. 56).

11. Distribution of the Seed in Drill Seeding. — Various methods are practiced for the even distribution of the seed in the drill. Hand distribution of small seed does not permit of uniform seeding except where great care is taken and much time spent in the sowing. Hand distribution has the advantage, however, in that it is equally efficacious with large, small or winged seed and whether wet or dry. Small, light seed cannot be sown in drills by hand on windy days without scattering it between the drills.

12. The Seeding Trough. — The simplest device for the even distribution of coniferous seed is the *seeding trough*. Various types are advocated by different foresters. They are all alike in principle and consist of V-shaped troughs of the same length as the width of the bed. A cup holding the quantity of seed desired for a single drill is used to bring the seed into the trough where it is evenly distributed by hand. When the seed is scattered along the side of the trough it rattles into position at the bottom and is more evenly distributed than when it is placed directly in the bottom. When the trough is opened at the bottom all the seeds fall into the drill at one time (Fig. 57).

Although various forms of this device are in use, that described by Heyer² is one of the simplest and best. Four boards 4 inches by $\frac{1}{4}$ inch and of the same length as the width of the bed are firmly nailed together to form two V-shaped troughs in which the sides have a divergence of approximately 60°. When these two troughs are brought together with one side of each in a single plane, there is a V-shaped space between for the reception of the seed. The two troughs are fastened together with two pieces of strap iron

¹ Spitzenberg, G. K.: Die Spitzenberg'schen Kulturgeräthe. 2. Aufl. Berlin, 1898.

² Heyer, Carl: Der Waldbau oder die Forstproduktzucht. 5. Aufl., 1. Bd., S. 276. Leipzig, 1906.



Photograph by U. S. Forest Service

FIG. 57. — Using the V-shaped seeding trough in the Pike National Forest.

in such a manner that the space between can be closed for the reception of the seed and opened to permit its escape (Fig. 58).

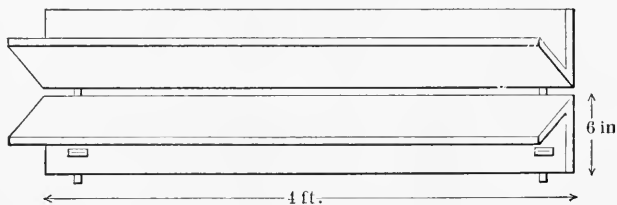

FIG. 58. — The double-V seeding trough.

13. The Seeding Lath. — The seeding lath is the most practical device for the rapid and even distribution of coniferous seed in drill seeding. The form devised by Eszlinger¹ is most extensively used. It is as long as the width of the bed and made from two

¹ Eszlinger, Forstassessor: Säelatte für Nadelholzsamen. (Forstw. Centralblatt, S. 535-539. 1890.)

strips of wood, approximately an inch in width, joined together to form a trough. Small rectangular notches are cut in one of the pieces so that when the two are joined the notches are at the bottom of the trough. The size and spacing of the notches determine the amount of seed sown in the drill.

In order to facilitate the rapid filling of the seeding lath a seed-box is advantageous. This box is slightly longer than the lath, curved at the bottom, and 6 or more inches in diameter. The lath is inserted in the box of seed and the trough completely filled. It is then removed and partially inverted over the box, causing

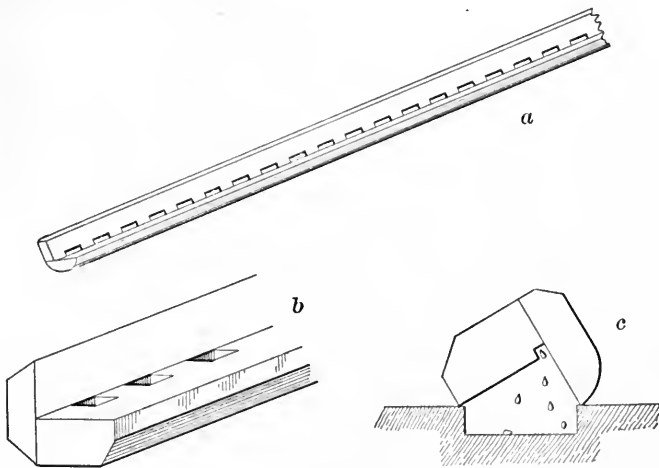

FIG. 59. — Eszlinger's seeding lath.

- a. Lath showing the size and spacing of the notches.
- b. Enlarged section of the lath.
- c. Cross-section of lath inverted over the drill.

all the seed to fall back except that in the regularly-spaced notches or depressions. The lath is now brought over the drill and completely inverted, causing all the seed to fall into it. The drills should be made broad and shallow. They are usually made with a marking board on which the battens are 1 inch wide and $\frac{1}{2}$ inch thick. The drill should be as wide as the trough in the seeding lath, so that when the latter is inverted all the seed will fall into it. As the density of seeding depends upon the size and number of notches in the trough, a different lath must be available for each quantity of seed sown (Fig. 59).

14. *Covering the Seed in the Drills.* — The depth of soil covering should be from 1 to 4 times the average diameter of the seed, depending upon the locality and the character of the soil. Deep covering is more acceptable on sand and loam than on clay soils. It is also more acceptable in regions having a dry atmosphere. Dry soils permit a deeper covering than wet soils.

Walnut, oak, and other broadleaved species sown in large, wide-spaced drills are usually covered by means of the hoe or rake. Special implements have been devised for covering shallow, closely-spaced drills. Among them the Spitzenberg seed coverer¹ has already been introduced into the United States from Europe. It is recommended as an effective and practical implement for rapidly covering shallow drills (Fig. 60).



FIG. 60. — Spitzenberg seed coverer.

a. Open metal roller for covering the seed.

b. Solid wood roller for firming the soil.

15. *Drill Machines.* — A number of machines have been constructed which mark the seedbeds, sow and cover the seed in a single operation. European foresters — Spitzenberg,² Hacker,³ Hörmann,⁴ and others — have constructed practical drill machines for use in forest nurseries. The Spitzenberg machine is useful in sowing large seed-like fruits such as the oak and hickory. It can be adjusted for density of seeding and depth of covering. The machine is operated by two men, one going ahead and drawing it across the bed by means of a rope and belt over the shoulder, and the other operating and guiding it from behind. The Hacker machine is for sowing coniferous and other small seed in shallow, closely-spaced drills crosswise of narrow seedbeds. It is operated

¹ Spitzenberg, G. K.: Die Spitzenberg'schen Kulturgeräte. 2. Aufl., S. 60. Berlin, 1898.

² Ibid.

³ Hacker, R.: Hacker'schen Gastensaatmaschine. (Centralblatt f. d. gesamte Forstwesen, S. 135. 1891.)

⁴ Hörmann, Forstamtsassessor: Ein neues Säegerät. (Forstw. Centralblatt, S. 622-628. 1903.)

by one man who draws it back and forth crosswise of the bed by means of a straight handle similar to that in the ordinary garden rake.

The Planet Jr. seed drill of American origin, extensively used by truck gardeners and farmers, is the only seed drill widely used in forest nurseries in the United States. It is used in sowing locust, Osage orange, and a few other broadleaved species in open seedbeds, and in sowing yellow pine and other conifers in seedbeds on some of the National Forests. It is operated by one man who pushes it by means of two handles lengthwise of the bed. It is not practical for seeding in closely-spaced drills running crosswise of narrow beds, nor is it entirely satisfactory for sowing coniferous seed, as the line in which it falls is too narrow and unless special precautions are taken most species are covered too deeply (Fig. 61).

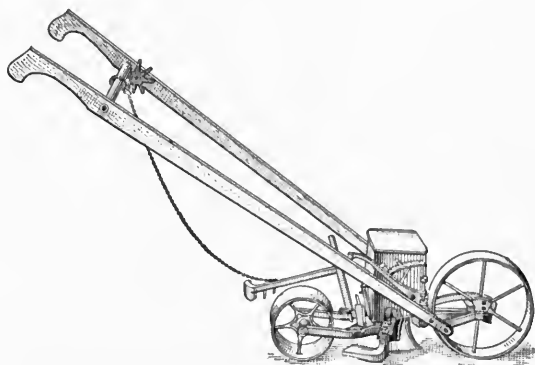

FIG. 61. — The Planet Jr. seed drill.

16. BROADCAST SEEDING. — In broadcast seeding the seed is scattered over the bed as evenly as possible, usually by hand. If the bed has previously been rolled, the top soil should be slightly loosened by raking in order to prevent the seed from moving after it strikes the soil. An ordinary garden rake will serve for this purpose, but where there are a large number of beds to seed a special rake as wide as the bed is preferable. When the surface of the bed is flat and 4 feet wide, a 4-foot strip of hard wood into which 6-inch spikes are inserted at $1\frac{1}{2}$ -inch intervals to form the teeth makes an excellent rake for the purpose. When

the surface of the bed is curved, the spikes should be inserted in the wooden strip so as to conform to the surface of the bed (Fig. 62).

With most species it is impossible to distribute the seed evenly over the bed while the wind is blowing. During windy weather seeding should be confined to early morning or late afternoon.

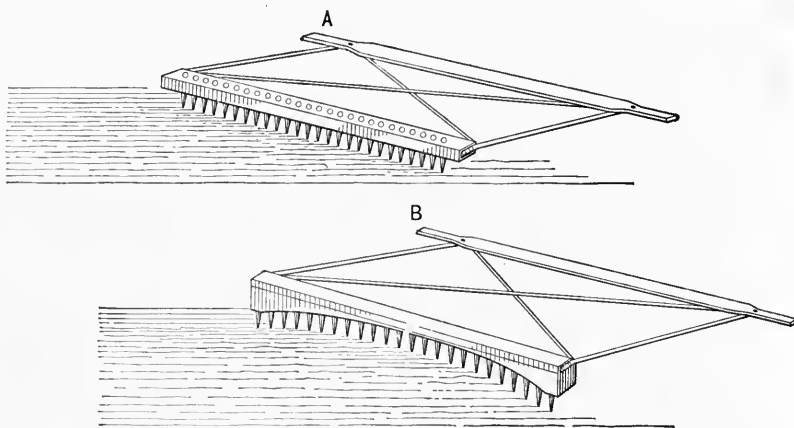

FIG. 62.—Special rakes for breaking the surface soil of seedbeds. The rakes are turned to one side to show the arrangement of the teeth.

A. Rake for use on flat beds.

B. Rake for use on beds with curved surface.

Considerable experience is required in order to scatter the seed evenly by hand. The work is facilitated by dividing the beds into small units with from 20 to 60 square feet in each. The seed likewise is divided into a similar number of parts, one for each unit. This provision will facilitate the even distribution of the seed and attain the correct amount in each bed. The hand carrying the seed should be brought within 2 or 3 feet of the bed. If held too close, the seed is less evenly distributed. An experienced man can sow broadcast an area of from 1500 to 4000 square feet per day.

17. Covering the Seed.—Immediately after the seed is broadcast it is pressed into the soil with one of the various forms of rollers already described or by means of a hoe or other tool with a smooth, flat surface. If the soil is overmoist, it will stick to the tool, carrying the seed with it, and render the operation impractical. Pressing the seed into the soil before covering makes the latter

operation easier and eliminates the danger of deep covering. Even with the greatest care the even distribution of the seed is disturbed and the resulting stand is likely to be irregular when the seed is covered by raking. *The covering soil should be sifted over the seed-beds.*

A strong, circular sieve with $\frac{1}{4}$ -inch mesh, such as is commonly used by gardeners (Fig. 63) or a rectangular sieve of the same length as the width of the bed may be used (Fig. 64). The former is handled by 1 man while another shovels in the soil. The latter is handled by 2 men, one on each side of the bed while a third keeps it filled with soil. The larger sieve permits of more rapid work and is recommended when a large

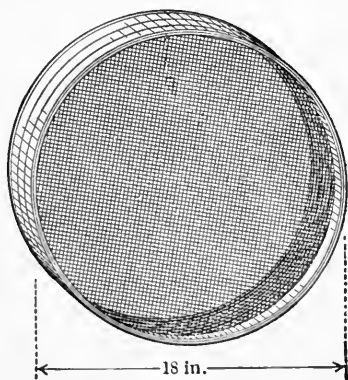

FIG. 63. — Circular sieve.

area of seedbeds is sown. The covering soil should be but slightly moist. If overwet, it sticks to the sieve and cannot be rapidly and evenly applied. Although experience at the New York State nurseries and at the Yale School of Forestry indicates

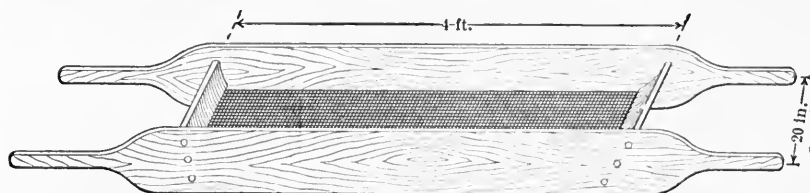

FIG. 64. — Rectangular sieve.

that a covering of fine loam induces better germination than sand, *the latter is preferable because of its freedom from crusting when wet.* It is very important that the covering soil be free from weed seed and the spores or mycelia of damping-off fungi. Surface soil should not be used. Excavations should be made and the covering soil taken from a foot or more below the surface.

Watch should be kept over the beds during the operation of covering and only sufficient soil applied to cover the seed. For most coniferous species $\frac{1}{4}$ inch is ample when the beds are protected by mulehng

or other cover after seeding. The looser and coarser the covering soil, the greater the depth can be without injury. Overdeep covering is a common defect in nursery practice particularly when the soil is likely to become compact on the surface.

18. Quantity of Seed per Given Area of Seedbed. — The quantity of seed to sow on a given area of seedbed depends upon a number of factors, of which the following are the more important:

- a. The species.
- b. The tree per cent value of the seed.
- c. The length of time that the seedlings remain in the seedbeds.
- d. The quality of stock required.
- e. The method of seeding.

Overdense seeding causes the resulting seedlings to be tall, slender, and weak. *The tendency in many forest nurseries in the United States in recent years has been toward the overcrowding of the seedbeds.* As a result, much of the 2- and 3-year seedling coniferous stock has been ill-suited for transplanting or field planting. On the other hand, when the stand is too thin it unnecessarily increases the cost. *Quantity should be secondary to quality.*

Insofar as the species is the greatest factor in determining the size of the seed, it is of the highest importance in determining the quantity that should be sown on a given area. The number of seed per pound is a rough index of the quantity that should be sown. In species that have seed of approximately the same size, those which grow most rapidly should ordinarily be less densely crowded, and consequently a less amount of viable seed should be sown. Thus, rapidly-growing species like larch should have 2 or 3 times the space in the seedbed during the first and second years as slow-growing species like hemlock and spruce.

The *utilization value* of the seed determined from germination tests, or better yet the *tree per cent* or the percentage of seedlings to be expected under the particular nursery practice, should always be taken into consideration in determining the most acceptable amount of seed for a given area. Thus, white pine seed that has been stored in the open for a year after collecting should ordinarily be sown twice as dense as fresh seed, due to its diminished utilization value and the much smaller number of plants to be expected from a given quantity. Most species can

safely stand 2 or 3 times as close in the seedbeds the first year as they can the second. When they remain through the third year they should have from 2 to 4 times the space of 2-year seedlings.

In general, when the seedlings are transferred direct to the plantation they should have twice the space in the seedbed as when grown for transplanting; hence but one-half the quantity of seed should be used.

19. QUANTITY OF SEED PER UNIT OF AREA IN DRILL SEEDING.—From one-half to one-third as much seed is used in drill seeding as in broadcast seeding. Schlich¹ recommends from one-half to one-fourth as much. For European practice, Mayr advocates the following amount of seed for 100 feet of drill:²

| | Oz. |
|--|------|
| Spruce, Scotch pine, and black pine..... | 10.8 |
| Larch and white pine..... | 32.4 |
| Fir and stone pine..... | 54.0 |

This density, however, should be used only when the plants remain in the seedbed but 2 years and are then transferred to the transplant bed. When the seedlings remain in the seedbed until planted out less density is essential.

The tendency in the United States has been toward a gradual increase in the quantity of seed for a unit of area, due to a closer spacing of the drills as well as an increase in the amount of seed used per linear foot. Thus in drill-seeding Douglas fir at the Wasatch nursery in 1906 only one pound of seed was used to 558 square feet of seedbed, while in 1911 one pound of seed was used to 51 square feet of seedbed with a resulting increase of seedlings per square foot from 25 to 146.

Gayer³ recommends the following amount of seed per 100 square feet of seedbed when broadleaved species are sown in drills:

| | |
|-----------------------|-----------|
| Oak and chestnut..... | 1.6 qts. |
| Beech..... | 4.16 qts. |
| Ash and maple..... | 0.3 lb. |
| Elm..... | 0.23 lb. |
| Alder..... | 0.36 lb. |
| Birch..... | 0.41 lb. |

¹ Schlich, Wm.: Manual of forestry. 4th ed., vol. II, p. 210. London, 1910.

² Mayr, Heinrich: Waldbau auf naturgesetzlicher Grundlage. S. 400 Berlin, 1909.

³ Gayer, Karl: Der Waldbau. 4. Aufl., S. 345. Berlin, 1898.

When fresh seed of the following broadleaved indigenous species is sown in drills spaced from 6 to 10 inches and the stock is permitted to remain but a single year in the seedbed before transferring to the plantation, the following amount should be used for each 100 square feet of seedbed.

| | |
|--|------------|
| Black walnut..... | 4-6 qts. |
| Shagbark hickory..... | 2½-3½ qts. |
| Red oak..... | 2-3 qts. |
| White oak and chestnut..... | 1½-2 qts. |
| Beech..... | 3½-4½ qts. |
| Tulip..... | 5-8 lb. |
| Black locust, catalpa, and elm..... | 10-15 lb. |
| Ash, box elder, and Osage orange..... | ¼-½ lb. |
| Honey locust, sugar maple, and basswood..... | 1-1½ lb. |

When the stock is transferred to the transplant bed after the first year, fully twice as much seed can be advantageously used. When the stock remains in the seedbed for a second year or when the drills are wide spaced, one-half as much seed should be used.

20. QUANTITY OF SEED PER UNIT OF AREA IN BROADCAST SEEDING. — Views differ so widely as to the best amount of seed to use with different species and under different conditions that it is impossible to give average data. In general, coniferous seed should be sown in sufficient quantity to produce from 50 to 200 seedlings per square foot, depending upon the species, their rapidity of growth, and the length of time that they are to remain in the seedbed. It is far better to sow thick than to sow thin, as an overdense stand can be thinned to the required density in the first weeding.

Pettis¹ gives the following as the amount of seed to sow for each 48 square feet of seedbed when fresh seed of average viability is used, when the seedlings are to remain in the seedbed for two years and then are set in the transplant bed, and when the beds are sown in the spring.

| | Oz. | | Oz. |
|------------------|-----|---------------------|-----|
| White pine..... | 10 | Norway spruce..... | 8 |
| Red pine..... | 6 | White spruce..... | 8 |
| Scotch pine..... | 8 | European larch..... | 16 |
| Jack pine..... | 6 | Hemlock..... | 8 |
| Pitch pine..... | 10 | Balsam..... | 12 |
| Red spruce..... | 6 | Arbor-vitæ..... | 6 |

¹ Pettis, C. R.: How to grow and plant conifers in the northeastern states. (U. S. Forest Service, Bul. 76, p. 34. 1909.)

When the seed has an unusually high viability less should be used. When the viability has been reduced by storage or other causes, more seed should be used.

The author believes that when the viability of the seed is the average for the species, the amounts given in the above table are too high for the best results. In his experience, red pine, jack pine, and arbor-vitæ sown at the rate of 6 ounces to 48 square feet of seedbed produce 300 or more seedlings per square foot, which is far too dense for the production of satisfactory stock.

Schlich¹ recommends the following amount of fresh seed for 48 square feet of seedbed when broadcasted:

| | Oz. |
|---------------------|-----|
| Scotch pine..... | 4.4 |
| Norway spruce..... | 4.4 |
| Austrian pine..... | 6.4 |
| European larch..... | 8.0 |

21. Formula for Seed Quantity. — The following formula expresses the amount of seed required for any given area of seedbeds:

$$S = \frac{PF}{EYN}.$$

S = The quantity of seed in pounds or quarts.

P = The area of seedbeds in square feet.

F = The desired density or number of plants per square foot.

E = The utilization value of the seed.

Y = A variable factor expressing the relation between tree per cent and utilization value.

N = The number of seeds per pound or quart.

The necessity for the factor *Y* in the above formula is due to tree per cent being far below utilization value based upon germinative capacity and usually below utilization value based upon germinative energy. Many seeds of weakened vitality germinate but do not develop, others germinate "rump first" and soon wither and die. To what extent tree per cent in the nursery lags behind germination values derived from tests varies with the quality of the seed and to some extent with its size. Old seed in which the vitality has been impaired by storage or fresh seed in which the vitality has been weakened by gathering before maturity or by overheating in extracting from the fruit may exhibit a tree per cent 20 per cent or more below the number that germi-

¹ Schlich, Wm.: Manual of forestry. 4th ed., vol. II, p. 210. London, 1910.

nate during the energy period in germination tests. As a general rule, tree per cent and utilization value based upon germination tests are much closer together in species having large seed than in species with small seed.

Applying the above formula, white pine seed with a germinative energy of 0.55 in 40 days, with 26,800 seeds per pound and a tree per cent equal to 0.8 of the utilization value based on germinative energy will require 6.3 pounds of seed to sow 500 square feet of seedbed at a density that will give 150 plants per square foot, thus

$$S = \frac{500 \times 150}{0.55 \times 0.8 \times 26,800} = 6.3.$$

Where germination values are not available experience has shown that the fresh seed of large-seeded conifers like western yellow pine when sown under excellent seedbed conditions has an average tree per cent value of 50 to 65. In other words, there should be expected in the seedbed from one-half to two-thirds as many plants as there was seed sown. Smaller-seeded species like white pine and spruce when sown under similar conditions have a tree per cent value of 25 to 50. There should be expected from one-fourth to one-half as many plants as there was seed sown.

The following table based upon the number of seeds per pound, the tree per cent value of fresh seed of average viability, and the number of seedlings per square foot of seedbed gives the amount of seed required for 500 square feet. When a larger or smaller area is sown or a larger or smaller number of seedlings are desired per square foot or when the tree per cent value of the seed is higher or lower than the average the amount of seed required for any area can be found by making the proper substitutions in the formula.

| Species. | Seeds per pound. | Tree per cent. | Area. | Seedlings per square foot. | Seed required in pounds. |
|----------------------------------|------------------|----------------|-------|----------------------------|--------------------------|
| White pine..... | 26,800 | 0.45 | 500 | 150 | 6.22 |
| Sugar pine..... | 2,510 | 0.60 | 500 | 75 | 24.9 |
| Yellow pine (California seed) .. | 9,340 | 0.50 | 500 | 100 | 10.7 |
| Red pine..... | 61,420 | 0.50 | 500 | 175 | 2.85 |
| Norway spruce..... | 59,400 | 0.40 | 500 | 175 | 3.16 |
| Red spuce..... | 131,400 | 0.35 | 500 | 200 | 2.18 |
| Englemann spruce..... | 178,200 | 0.25 | 500 | 200 | 2.15 |
| Douglas fir..... | 41,260 | 0.30 | 500 | 150 | 6.05 |
| Eastern hemlock..... | 194,200 | 0.20 | 500 | 200 | 2.57 |
| White fir..... | 11,120 | 0.20 | 500 | 100 | 22.48 |
| Redwood..... | 162,200 | 0.25 | 500 | 150 | 1.85 |
| Arbor-vitæ..... | 284,300 | 0.20 | 500 | 200 | 1.75 |

Schwarz¹ gives the following as the average number of plants obtained from one pound of high-grade fresh seed in the best European practice:

| | Plants. |
|---------------------|---------|
| White pine | 13,600 |
| Jack pine..... | 34,000 |
| Scotch pine..... | 27,000 |
| European larch..... | 6,800 |
| Norway spruce..... | 27,000 |
| Douglas fir..... | 13,600 |
| Silver fir..... | 2,275 |

The average number of plants obtained from a pound of seed during a period of 6 years at the Wasatch nursery was 10,343 for Douglas fir and 5919 for yellow pine.

22. The Management of Seedbeds After Seeding and Prior to Germination.—Heavy-seeded broadleaved species such as walnut, hickory, and oak, and species quick to germinate such as maple, catalpa, and elm do not require special treatment after seeding aside from the cultural methods of ordinary farm crops. Ash, cherry, and other species that lie over until the second year are usually covered with a mulch of leaves or straw which is removed as germination starts. Except in the most favorable localities, all coniferous species and small-seeded broadleaved species such as *Eucalyptus*, birch, and alder should be protected from the sun and wind as soon as they are sown. *The surface soil should be kept uniformly moist throughout the period of germination.* When the soil contains germinating weed seed, Mayr² recommends that boiling water be applied to the beds a short time after the tree seed is sown. The hot water destroys the germinating weeds and the insects in the surface soil. It also hastens germination. When the seed is covered to a depth less than 0.65 inch the temperature of the water should not exceed 175° F. Coniferous seedbeds are invariably covered during germination in all the larger forest nurseries in New England. Seedbeds of yellow pine and a few other species are uncovered during germination in some of the nurseries on the National Forests but only in those where climatic conditions are such that covering has proved unnecessary.

¹ Schwarz, Alexander: Der Waldpflanzenzucht-Betrieb in und um Halstenbek. (Forstw. Centralblatt, S. 491. 1903.)

² Mayr, Heinrich: Waldbau auf naturgesetzlicher Grundlage. S. 402. Berlin, 1909.

Any method for protecting the seedbeds during germination that will keep the surface soil adequately and uniformly moist is acceptable. The following methods are practiced.

- a. Covering with brush or mulch.
- b. Covering with scrim, cheese-cloth, or burlap.
- c. Covering with lath screens or seedbed boxes.

23. COVERING WITH BRUSH OR MULCH. — Brush strewn over the bed immediately after seeding is the simplest method of pro-



FIG. 65. — Seedbeds covered with a mulch of leaves held in place with lath screens.

tecting it from wind and sun. Coniferous branches from 3 to 6 feet long are the best for this purpose, care being taken to distribute them uniformly over the bed. Heath brush, when available, forms an effective and inexpensive cover for coniferous seedbeds prior to germination. The brush should be taken off as the seed begins to germinate.

Another simple method for protecting the seedbed prior to germination is by mulching with leaves, moss, hay, or straw. Leaves of oak, maple, and other hardwood species are the best for this purpose. Hay and straw should not be used when other material

is available as they bring in weed seed and increase the cost of later cultivation. It is often necessary to place brush, lath screens, or other suitable material on the mulch to prevent its disturbance by the wind (Fig. 65). When the seedbeds are adequately moistened before mulching, it is often unnecessary to water them before germination starts. When water is needed it is applied over the mulch. One advantage of mulching arises from its effect on the growth of weeds. The weed seeds that germinate before the tree seeds grow upward into the mulch and are thus destroyed. *The mulch must be removed as soon as germination starts.*

24. COVERING WITH SCRIM, CHEESE-CLOTH, OR BURLAP. — Scrim, cheese-cloth, and burlap are extensively used for protecting seedbeds prior to germination in many large nurseries in the



FIG. 66. — Seedbeds covered with burlap after broadcast seeding.

United States (Fig. 66). Where nursery operations are conducted on a large scale this manner of protection is usually more satisfactory and often less expensive than covering with brush or mulching with leaves, due to the facility with which they can be placed over the beds and later removed. They have the added advantage of not introducing weed seed as is often the case when mulch is used. Furthermore, the soil warms up more quickly and germination is earlier. This is of great advantage in high altitudes and other localities where the growing season is short and when

the beds are sown in early spring while the soil is cold. This method of protecting autumn-sown seedbeds is not as satisfactory as the ordinary mulch, particularly if the soil is heavy and liable to crack.

The relative advantages of scrim, cheese-cloth, and burlap depend chiefly upon the cost of the material and the degree of protection required. Cheese-cloth affords the least protection and burlap the most. Scrim is intermediate in its effect. Where one of these materials is used it is spread over the seedbed in contact with the soil and tacked to the curb or held in place by pegs driven into the ground at either side, or it is attached to frames which raise it a few inches above the surface of the bed. When scrim is used only during the period of germination, it is spread over the beds in contact with the soil. When also used to shade the beds after the seed germinates, it is tacked to frames. As soon as germination begins the frames are raised a foot or more above the beds and are held in place by stakes driven into the soil along either side.

25. COVERING WITH LATH SCREENS OR WITH SEEDBED BOXES.—The following is a simple, efficient, and inexpensive method for protecting seedbeds prior to germination in nurseries where screens made of laths are later used to protect the young seedlings from the wind and sun. The beds are surrounded by board strips 4 inches wide and 1 inch thick. These strips are set on edge along the margin of the beds or on the curbs when present. The ordinary lath screens 4 by 6 feet or 4 by 12 feet are placed on these strips which raise them a few inches above the beds. The spaces in the screens are filled with loose laths. This serves to enclose the beds completely, and prevents the free movement of air and the loss of moisture from the surface soil.

In nurseries where the ordinary seedbed boxes are used they are adjusted over the beds prior to seeding and serve to protect the seed during germination as well as the seedlings after germination takes place. These boxes are usually made as follows:¹ A framework of wood, usually 12 feet long, 4 feet wide and 1 foot high, covered on the sides and ends with $\frac{3}{4}$ -inch mesh netting, is first placed in position over the bed and sunk in the soil so that the top of the bottom sill, which serves as a curb, is level with the soil at

¹ Pettis, C. R.: How to grow and plant conifers in the northeastern states. (U. S. Forest Service, Bul. 76, p. 16. 1909.)

the margin of the seedbed. The beds are well rounded and the paths depressed 2 or 3 inches below their margin. Two covers fit over the framework: the first is made of $\frac{3}{4}$ -inch mesh wire netting, and the second of laths spaced to produce half shade. As soon as the seed is sown both of these covers are placed in order over the beds and loose laths are adjusted in the open spaces in the second cover. The sides and ends of the framework are closed by tacking building paper or other light material over them (Fig. 67).



Photograph by U. S. Forest Service

FIG. 67. — Standard seedbed boxes completely enclosed during the period of germination.

The seedbeds are thus entirely closed and remain in this condition during the period of germination. By raising the second cover from time to time the progress of germination can be observed and water supplied by sprinkling, if necessary. The complete seedbed box, including the framework and the two covers, costs from \$2.50 to \$5 for materials and labor, depending upon the locality and the number made. If properly taken care of when not in use, they will last from 5 to 8 years if chestnut or other durable wood is used in their construction.

26. The Management of Seedbeds After Germination Begins. — When seedbeds are covered during germination *the cover should be partially or completely removed as soon as germination starts in order to give the young plants necessary air and light.* Usually the larger percentage of the viable seed germinates at approximately the same time. Even when germination is irregular there should be but little delay in the removal of the cover. If left on too long, the seedlings grow tall and spindling for lack of light, and their weak, succulent tissues endanger them to disease.

Various methods for shading seedbeds are practiced. Any method which will provide half shade uniformly distributed is usually acceptable. To what extent the young seedlings should be shaded immediately after germinating depends largely upon weather conditions. If the weather is dry and bright, full overhead shade is desirable for the first few days. If it is warm, moist, and cloudy, the cover should be entirely removed and the beds dried out by exposing them to the air and wind. Careful attention should be given to them the first 4 weeks after germination, and the shade increased or decreased depending upon the conditions of the weather. There is little danger from damping-off after the first month, and the seedlings can, as a rule, be safely grown under half shade for the remainder of the season.

Partial shading for at least a part of the first year is generally advocated in growing coniferous seedlings in forest nurseries in the United States not only for the more tolerant genera such as spruce, hemlock, and fir but also for pine and larch. The seedlings of most species of conifers are small and delicate in their early youth and often are killed or severely injured by exposure to wind and sun. The damage is chiefly due to drying the tender stem below the cotyledons and the effect of exposure on the surface layer of the soil. *When damage due to the desiccating action of wind and sun does not occur, all species can be grown in open seedbeds.* Coniferous species that are indigenous to warmer and less humid sites than the nursery where the seed is sown can often be grown without shade. When the seed is sown in the autumn it germinates earlier than spring-sown seed and the resulting plants are more resistant to damage from summer heat and drought; consequently shading is not so essential. The owners of nurseries located at high and intermediate elevations where there is a short growing season usually grow as many species as possible without shade, because

of the earlier germination, better hardening of the autumn growth, larger proportion of root to shoot, and shorter, stockier plants. Researches by Cieslar¹ show that coniferous seedlings make their best growth in open seedbeds when the soil is protected by a mulch of moss or other litter which checks the loss of moisture from the surface soil but permits the tops of the young plants free exposure to the light. All species show an increase in height growth with an increase in shade up to a given degree, but it is more pronounced in intolerant than in tolerant species. *Although shade stimulates height growth, it depresses volume growth of both root and shoot and tends to produce less acceptable stock for the general purposes of planting.* Shaded stock does not ripen its wood so well in the autumn and, as a consequence, is more subject to frost damage.

Although better stock can often be grown in open seedbeds, particularly when a mulch is worked in about the plants as soon as they are up, the danger from the drying out of the young plants in open beds is usually so great that *shading must be resorted to in order to overcome the hazard of excessive loss.* Overshading is decidedly harmful. Only sufficient shade should be given to prevent injury.²

The economic necessity for shading the seedlings must be determined for each locality through experience. Western yellow pine, Scotch pine, and Austrian pine are successfully grown without shade at the Wasatch nursery and some other western nurseries at high elevations. Larch, spruce, and fir are grown under shade the first year. Autumn-sown seedbeds of all conifers are unshaded at the Wind River nursery, while it has been found economically advantageous to shade spring-sown beds during the first season. At the Halsey and Fort Bayard nurseries and at other western nurseries located at low elevations where the air is warm and dry during the growing season, all coniferous seedbeds are shaded. Although western yellow pine can usually be grown without shade after the seedlings are a month old, spruce and fir should often be shaded even during the second and third years in order to attain the best economic results. In New England and elsewhere east of the

¹ Cieslar, A.: Licht- und Schattholzarten: Lichtgenuss und Bodenfeuchtigkeit. (Centralblatt f. d. gesamte Forstwesen, S. 4-22. 1909.)

² Pearson, G. A.: Forest planting in Arizona and New Mexico. (Proc. Soc. Am. For., vol. IX, p. 463. 1914.)

Mississippi River, experience has not as yet demonstrated the wisdom of growing coniferous stock without cover. *The covering of the beds during germination and partial shading during the first season should not be dispensed with in any locality in the United States until experience has demonstrated that the elimination of cover and shade is an economic advantage.*

A more or less firm crust sometimes forms on the surface of the soil which prevents small-seeded species from breaking through as they germinate. Large flakes of crust are sometimes raised up an inch or more by the thousands of rapidly germinating seeds beneath. This condition is extremely disastrous to what would otherwise be excellent germination. *It can be prevented by breaking the crust prior to germination with the special tool described below.* A flat board 18 inches long and 12 inches wide is filled with nails set in rows $1\frac{1}{2}$ inches apart and spaced $\frac{1}{8}$ inch in the rows so that

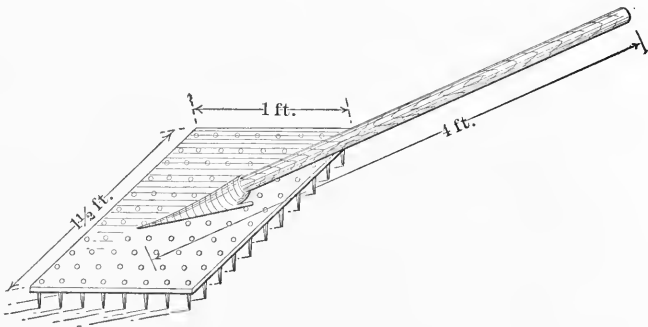

FIG. 68. — Tool for breaking the surface crust of seedbeds prior to germination.

the nails in one row alternate with those in the next. The points extend $\frac{1}{8}$ inch below the lower face of the board. A straight handle about 4 feet long is attached in such a manner that the board can be quickly passed over the bed driving the small teeth into the crust and effectively breaking it without disturbing the position of the seed (Fig. 68).

27. SHADING SEEDLINGS WITH NATURAL COVERS. — Seedbeds may be shaded with either natural or artificial covers. The most common form of natural cover is an open stand of wide-crowned trees that give from one-half to one-third shade. Although alder is often grown under this form of cover in Prussia and a great

variety of coniferous and broadleaved species in northern Italy and elsewhere in southern Europe, it is very little used in forest nurseries in the United States. The chief objection to it is the unequal distribution of the shade and the interference of the trees with the working of the soil. The trees also compete with the nursery stock for the moisture and available plant nutrients in the soil. As a rule, the trees should stand at intervals of about 20 feet. Their moving shade not only protects the young plants but also contributes to the comfort of the laborers in working the nursery.

Seedbeds under a live cover are usually made from 3 to 6 feet in width and of variable length, often the entire length of the compartment. The most usual width is 4 feet, as a wider bed is more difficult to weed and manage.

In some parts of Europe a live cover is formed by growing hemp or some other rapidly-growing species along the south border of narrow seedbeds which checks the wind and provides adequate protection from the sun.¹ Alder is sometimes grown in the seedbed with various coniferous species. It soon grows above the conifers and forms a nurse crop or live cover from 1 to 5 feet in height. The alder plants are at first from 8 to 10 inches apart and are gradually thinned out. Not only do they shade the conifers but they also improve the quality of the soil.

28. SHADING SEEDLINGS WITH ARTIFICIAL COVERS. — Several forms of artificial cover are used for shading seedbeds. In most localities they have proved less costly and more successful than live or natural ones. The degree of shading can be controlled better and they do not compete with the growing stock for soil moisture and nutrients. All forms of artificial cover may be classed under the following heads:

a. High covers.

b. Low covers.

The former are raised sufficiently high above the seedbeds to permit horses to pass beneath in working the soil. Low covers are removed in the formation and working of the seedbeds.

29. High Covers. — High covers are continuous over the entire compartment. Posts sufficiently long to reach 8 feet above the surface of the seedbeds are set upright in the soil at intervals of from 9 to 12 feet. Slender poles or scantlings are spiked to the

¹ Woolsey, T. S.: A glimpse of Austrian forestry. (Proc. Soc. Am. For., vol. IX, p. 23. 1914.)

top of the posts forming a framework over which the cover is distributed in sufficient quantity to permit half shade to reach the seedbeds beneath (Fig. 69).

A more substantial but more costly form of high cover has been extensively used in the nurseries in many of the National Forests.



FIG. 69. — High cover formed of brush on a framework of posts and poles.

In this form the framework is covered above, or both above and on the sides, with lath or narrow slats spaced so as to give the desired degree of shading (Fig. 70).

High cover has some advantages over low cover but in most localities they are more than counterbalanced by decided disadvantages including greater cost. The greatest objection to the high cover is the difficulty in shifting it with changes in weather conditions. Furthermore, it does not permit the rotation of seedlings with transplants or field crops because of the expense in moving it to other parts of the nursery.

High cover should be used only in localities where there is no need for regulating the density of the shade with changes in the season and weather. The seedbeds under high cover vary in width from 3 to 7 feet, with $1\frac{1}{2}$ - to 2-foot spaces between for



FIG. 70. — High cover formed of posts and scantlings covered with mats woven from narrow slats and wire.

paths. The beds are either the entire length of the cover or broken at intervals to facilitate working.

30. Low Covers. — The various kinds of low covers useful in shading seedlings are usually raised from 1 foot to $1\frac{1}{2}$ feet above the surface of the seedbed. They do not extend uniformly over the entire compartment, but there is a separate cover for each bed. A low cover may be any one of the following:

1. Brush screens.
2. Lath or slat screens.
3. Serim, cheese-cloth, or burlap screens.

31. Brush Screens. — Branches of forest trees, preferably hemlock, spruce, fir, and other conifers, form the simplest kind of low shade cover for seedbeds. When branches 3 to 6 feet in length are laid over the beds during germination, they are removed and stuck upright in the soil as soon as the seed begins to germinate. The longer branches are placed along the south border of the beds so as more effectively to shade them. Sometimes the branches are bent inward at the tops if otherwise the shade does not extend over all parts of the beds.

When special care is taken in covering the seedbeds and the branches are well distributed this is a perfectly practical method

and affords good results. It is often used in small temporary nurseries in Europe, particularly in Austria and Germany, and might very well be introduced into small ranger nurseries and into farmers' nurseries in the United States.

A more durable form of brush screen, often used in small nurseries located in or near the woods, is made as follows: Slender branches of suitable kinds are woven into a framework 4 feet wide and 6 or 12 feet long. The frame is made of small poles nailed or lashed together. Considerable care is required in order to make durable brush screens with the branches uniformly spaced. They are raised about a foot above the seedbeds on stakes driven into the soil.

32. Lath or Slat Screens. — Lath or slat screens are the kinds more generally used in forest nurseries in the United States. Three general types are in use:

1. The 4 by 6 ft. and 4 by 12 ft. screens.
2. The rolled screen 4 ft. wide and of any desired length.
3. The 4 by 12 ft. seedbed box.

In all of these types the spacing varies with the degree of shading required. Usually the intervening spaces are of the same width as the laths or slats.

In the first type, standard laths 4 feet long and $1\frac{5}{8}$ inches wide are nailed to three strips 2 inches wide and $\frac{3}{4}$ inch thick. Two of these strips are 6 or 12 feet long, depending upon the length of the screen, and are nailed at right angles to the laths 2 inches from either end. The other strip is oblique to the end strips and serves as a brace. A 6-foot screen for half shade requires 28 laths. It is supported from 1 foot to $1\frac{1}{2}$ feet above the seedbed on poles or strips nailed to the tops of stakes driven into the soil at the sides of the bed (Fig. 71).

In the second type, standard laths or strips of wood from $\frac{1}{2}$ inch to $1\frac{1}{2}$ inches wide and 4 feet long, are woven with 4 soft fence wires into mats the length of the seedbed. As the wires are soft, the mats are easily rolled up when not in use. Stakes are driven along both sides of the seedbed, on the top of which slender poles or strips are nailed. The screen is adjusted over the seedbed by rolling it along the poles or strips. This type of screen is easily handled in working the seedbed, can be stored in the minimum of space, and is very durable (Fig. 72).

The third type is the standard seedbed box. It is extensively

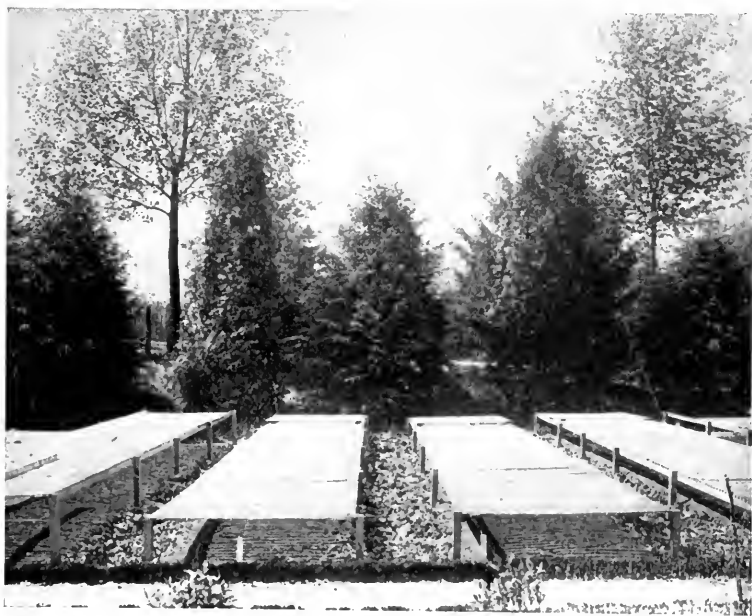
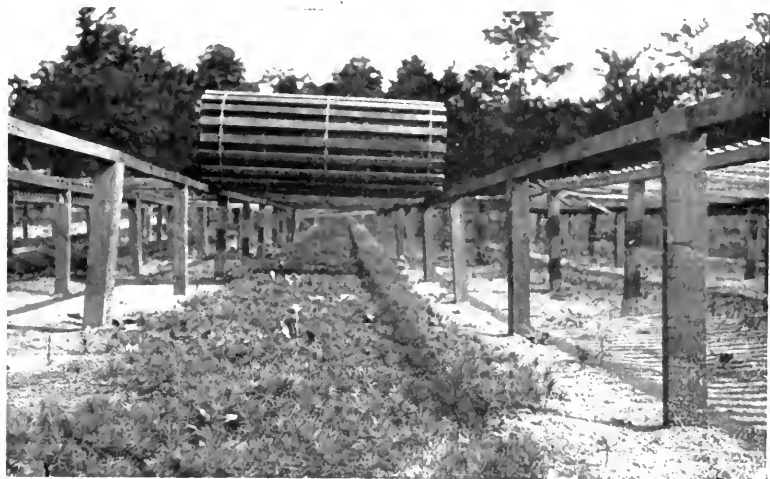

FIG. 71. — Low cover formed of 4-by 6-foot lath screens supported on stakes 1 foot above the seedbed.



Photograph by E. J. Zavits

FIG. 72. — Low cover of lath mats supported $1\frac{1}{2}$ feet above the seedbeds.

used in many forest nurseries (Fig. 67). The shade screen is the uppermost cover of the box. It is made of laths nailed to a frame 12 feet long and 4 feet wide, which fits the top of the box and can be removed and replaced without disturbing the wire screen beneath.

33. Scrim, Cheese-cloth, or Burlap Screens.—Screens made by tacking scrim, cheese-cloth, or burlap over wooden frames serve very well for protecting seedbeds from the sun. The frames are usually 4 by 6 feet in size and are made by nailing together two side pieces 6 feet long and 4 inches wide, and two end pieces 4 feet long, in the form of a rectangular frame. The side pieces are set on edge and the end pieces are set flatwise. The fabric is stretched over the frame. When the frame rests on the seedbed the side pieces raise the fabric slightly above the surface of the bed.

The screens are quickly made, are relatively inexpensive, and, when properly cared for, last from two to four years. They serve a double purpose. By placing them over the seedbeds immediately after seeding they protect the beds prior to germination. When germination begins they are raised a foot or more above the beds and supported on stakes. This method of shading seedlings is seldom used in forest nurseries in the United States. In New Zealand coniferous nursery stock of many species indigenous to the United States is grown under similar screens.¹

Except in dry, warm regions where there is a maximum of sunlight the broken shade produced by lath screens or brush is preferable because the danger from overshading is not so great.

Beech and some other tolerant broadleaved species cannot be grown in most localities without protection from the sun during their early development. This can be attained by erecting a brush or lath cover over the seedbeds or, according to Bagneris,² by the following method of culture. The seed is sown at the bottom of narrow trenches running east and west. These trenches are 4 inches in depth and, as the plants develop, the soil is filled in about them until level. The base of the young stem is particularly sensitive to direct exposure to the sun. Injury is prevented by this manner of protection.

¹ Goudie, H. A.: State afforestation in New Zealand. (Report, Dept. of Lands, p. 7. Wellington, 1911.)

² Bagneris, G.: Manuel de sylviculture. 2. éd., p. 259. Paris, 1878.

34. Weeding and Cultivation. — Seedbeds should be kept free from weeds. This necessitates from 3 to 6 weedings or cultivations the first season. The frequency depends upon the condition

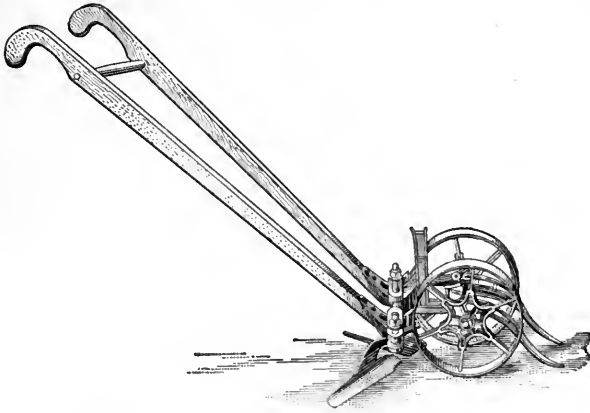

FIG. 73. — The Planet Jr. 2-wheel cultivator.

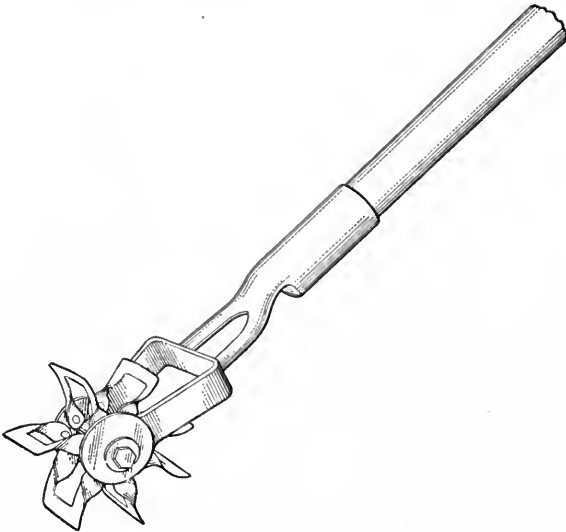

FIG. 74. — The Spitzenberg wheel hoe.

of the soil, particularly its freedom from weed seed. It is also influenced by the season. Horses may be, and usually are, used in cultivating broadleaved species sown in wide-spaced rows. Hand

cultivators of the type of the Planet Jr. which can be adjusted for deep or shallow cultivation, are useful in cultivating narrow rows running lengthwise of the beds (Fig. 73). When the drills run crosswise of narrow beds the ordinary garden hoes or special nursery hoes are used in the cultivation. The author has found the Spitzenberg wheel hoe¹ rapid and effective in working the soil between the rows and keeping it free from weeds. It is made in varying widths to conform with the spacing of the drills (Fig. 74).

When the seedbeds are sown broadcast and when the drills are spaced at intervals of 3 inches or less the ordinary methods of cultivation which loosen the soil are impractical, and hand weeding is the only cultivation practiced. The weeds are thrown into the paths as they are removed from the beds and later carted to the compost pile. The paths are worked periodically with a Dutch hoe or scraper and the weeds removed with as little disturbance of the soil as possible.

35. Autumn Treatment of Seedbeds. — Broadleaved species are usually left unprotected in the seedbeds over winter, except in regions where they are likely to be thrown by the frost. When protected they are covered with a light mulch of leaves or straw.

Except in regions that experience little frost coniferous seedbeds are usually covered the first winter. When uncovered, the alternate freezing and thawing of the surface soil forces the small plants out of the ground and seriously injures or destroys them. The shade cover should be removed in the early autumn after growth has ceased in order that the seedlings may harden their wood for the coming winter. This is particularly important in regions having a short growing season or when the seedbeds have been sown late. The following methods are practiced in protecting coniferous seedbeds during the first winter:

- a. Mulching with leaves, hay, or straw.
- b. Covering with burlap.

A mulch of leaves, hay, or straw is very effective in preventing coniferous seedlings from being thrown by the frost. It should be applied late in the autumn. The brush, lath screens, or other cover used to protect the beds from the sun during the summer should be placed over the mulch to hold it in place (Fig. 65). It

¹ Spitzenberg, G. K.: Die Spitzenberg'schen Kulturgeräthe. 2. Aufl., S. 32. Berlin, 1898.

should be removed as soon as danger from severe spring frosts is over. If left on during an extended period of warm spring weather, the plants "scald" and are seriously injured or killed.

In many permanent nurseries, mulch has been replaced, in recent years, by burlap for the winter protection of coniferous seedbeds. When purchased in large quantities it is usually less expensive than mulch, because of the rapidity with which it can be placed over the beds and later removed. It is effective in protecting the seedlings from being thrown by the frost and there is less danger of the plants being injured by scalding, or by mice and



FIG. 75. — One-year coniferous seedlings in winter condition covered with burlap. One bed uncovered to show the seedlings.

other rodents forming nests and working in the seedbeds during the winter.

A single thickness of burlap is spread over the beds, preferably after a light fall of snow, and tacked to the curb at the side or held in place by pegs. If it is removed after all danger of severe spring frosts is over and before there has been a period of warm weather, the seedlings will be found in the same condition as when covered (Fig. 75).

36. Approximate Size of 1-Year Seedlings. — One-year stock varies greatly in size, depending upon the species, season, soil, climate, and density of stocking. The following table gives the

height of shoot and the length of root of 30 species grown under uniform conditions in uncrowded seedbeds on deep, fertile, sandy loam at New Haven, Connecticut:

| Species. | Shoot in inches. | Root in inches. | Species. | Shoot in inches. | Root in inches. |
|----------------------|---------------------|--------------------|-------------------|---------------------|-----------------------|
| White pine..... | 1½- 2½ | 4 - 7 | Beech..... | 3- 7 | 6-10 |
| Sugar pine..... | 2½- 3 | 14 -22 | Chestnut..... | 10- 6 | 14-26 |
| Red pine..... | 1 - 1½ | 5 - 9 | White oak..... | 3-17 | 12-22 |
| Red spruce..... | $\frac{3}{4}$ - 1 | 3 - 5 | Red oak..... | 8-14 | 8-16 |
| Norway spruce..... | 1 - 1½ | 4 - 6 | White elm..... | 10-20 | 8-14 |
| Douglas fir..... | 1½- 2 | 7 - 9 | Osage orange.... | 16-22 | 10-16 |
| Eastern hemlock..... | $\frac{3}{4}$ - 1½ | 2½- 5 | Tulip..... | 8-14 | 12-16 |
| White fir..... | 1¾- 2½ | 9 -14 | Sycamore..... | 7-12 | 8-10 |
| Bald cypress..... | 6 - 9 | 3 - 5 | Black cherry..... | 12-18 | 10-16 |
| Redwood..... | 2½- 3 | 7 -11 | Black locust..... | 20-30 | 6-12 |
| Incense cedar..... | 2 - 2½ | 12 -16 | Sugar maple..... | 6-10 | 8-12 |
| Arbor-vitæ..... | $\frac{3}{4}$ - 1½ | 3 - 5 | Box elder..... | 20-28 | 8-16 |
| Black walnut..... | 8 -14 | 18 -30 | Basswood..... | 10-18 | 12-18 |
| Shagbark hickory.... | 2 - 4 | 16 -28 | White ash..... | 3- 8 | 8-16 |
| Sweet birch..... | 7 -15 | 5 - 9 | Catalpa..... | 12-22 | 10-16 |

37. The Management of the Seedbeds after the First Year.

— Most broadleaved species are left in the seedbed but one year or through one growing season, after which they are either transferred to the transplant bed or to the field. Coniferous species remain in the seedbed for a period of from one to three years. Rapidly-growing hardwoods like walnut, black locust, and catalpa, unless crowded in the seedbed, often in a single year become too large for advantageous use. When grown under the most favorable conditions many conifers, as illustrated in yellow pine, Scotch pine, European larch, incense cedar, and Douglas fir, are removed from the seedbed at the end of the first year. Under most conditions conifers are retained in the seedbed for two years (Fig. 76). At high altitudes or elsewhere where the growing season is short they are retained in the seedbed during the third year.

When the beds are adequately stocked, the seedlings shade the soil after the first year and an artificial shade is not required. The ground is so completely covered with the young trees that few weeds develop and there is but little expense for weeding.

The rapidly-growing seedlings require large amounts of water during the second year. Special attention must be given to irrigation during dry periods or large losses are likely to occur.



FIG. 76.— White pine seedbeds; stock 2 years old. Near Cheshire, Conn.



FIG. 77.— White pine seedbeds; stock 3 years old. Approximately 50 per cent removed when 2 years old. Near Cheshire, Conn.

Usually it is not necessary or desirable to mulch or otherwise cover the seedbeds during the winter except the first year.

Dense seeding of conifers is practiced in many nurseries, and a portion of the plants removed at the end of the first year, leaving, however, sufficient stock to form a full stand the second year. At the end of the second year all the plants are removed or else the surplus stock is again removed, leaving enough to form a full stand for the third year. *If the beds are thoroughly saturated with water before the 1-year stock is removed, it can usually be pulled without injury, particularly if several plants are removed together.* When 2-year beds are thinned, pulling the seedlings causes more damage and it is safer to lift the stock with a spade or trowel (Fig. 77). When the excess stock is not required for transplanting, overdense stands of 1- and 2-year seedlings are often thinned by clipping out the excess plants with a pair of shears. This is preferable to pulling or lifting the excess stock as it does not disturb the roots of the plants that remain.

38. WRENCHING OR ROOT PRUNING THE STOCK IN THE SEEDBEDS.—Seedlings that remain in the seedbed through but one growing season are never root pruned prior to lifting. It is sometimes advantageous to root prune older stock while still in the seedbed. This is usually done in the autumn after the season's growth is complete. Its purpose is to check growth and induce those species which produce a deep tap root with few lateral roots to develop a more diversified root system. Broad-leaved species that remain in the seedbed longer than the first year, if likely to become too large by the end of the second year, may be held in check by root pruning in the early autumn following the first summer's growth. Conifers are not root pruned in the seedbed at the end of the first season's growth except the more rapidly-growing species grown under the most favorable conditions. When conifers are retained in the seedbed longer than the second year, it is almost always advisable to check their growth and improve the root system by severe root pruning at the termination of the second season's growth.

Root pruning in the seedbed can be practiced only when the seedlings are grown in bands or lines. Goudie¹ advocates the root pruning of Douglas fir, Monterey pine, and some other American

¹ Goudie, H. A.: State afforestation in New Zealand. (Report, Dept. of Lands. Wellington, 1911.)

conifers at the end of the first season's growth in New Zealand nurseries. The trees are grown in bands 11 inches wide extending lengthwise of the beds. Root pruning 1- and 2-year yellow pine when grown in rows is practiced to considerable extent in the United States.

One or the other of the following methods is usually practiced in root pruning seedlings in the seedbed. Two men equipped with short-handled spades insert them on each side of the row or band of seedlings at an angle of about 45°. The spades are pushed well under the trees cutting off the tap roots and the more vigorous side roots. Small stock can be quickly root pruned with a large, heavy knife which is run obliquely under the row of seedlings at either side. This method of root pruning can be practiced only in light, loose soil free from stones. The blade of the knife should be broad and thin in order to be easily forced through the soil. A tool known as the U-shaped root pruner is used in a number of nurseries for root pruning small trees when grown in rows or narrow bands. The cutting edge is U-shaped. The tool is thrust into the ground at the end of the row by means of two handles from 8 to 10 inches apart and the cutting edge forced under the row of small plants from 5 to 8 inches below the surface.

39. SOWING SEED IN POTS AND FLATS

In warm regions where early growth is very rapid the seedlings are set in the field when but a few months old. The seed is often sown in pots. The plants when set in the field are either removed from the pots, care being taken not to disturb the soil about the roots, or the pot is placed in the soil with the contained plant. In the latter case the pot is made of paraffined paper, unbaked clay, or other material which will disintegrate and permit the development of the roots after being placed in the ground. Several seeds are usually sown in each pot and the number of seedlings reduced to one or two after they are well established. Paper pots are usually square in cross section and without bottoms. They are placed in ordinary gardener's flats and filled with soil, after which the seed is sown. When the pots are circular in outline the spaces between are also filled with soil. The flats and the contained pots are taken to the field, when ready for planting, and the pots removed one at a time as required. Pot seeding is costly and seldom justified in this country.

Species of *Eucalyptus* and occasionally other trees with fine, delicate seed are sometimes sown in ordinary gardener's flats or boxes. The flats should be at least 4 inches deep and filled with a good quality of nursery soil. The seed is usually sown broad-



Photograph by U. S. Forest Service

FIG. 78. — Blue gum (*Eucalyptus globulus*) growing under cover in flats or shallow boxes. Near Santa Monica, California.

east and a light covering of sand sifted over the top. Ample seed should be used to assure a full stand. Seedlings started in flats are usually pricked out into other flats when a few months old where they are grown until required for planting (Fig. 78). Seeds

sown in pots and flats should be protected during germination and the young seedlings should be shaded later in much the same manner as in ordinary seedbeds.

40. TRANSPLANT BEDS

A transplant is a tree that has been grown one or more years in the seedbed or as wild stock and later reset in the transplant bed. Trees may be transplanted one or more times. As a rule when used in silvicultural practice they are transplanted but once. Transplanting is necessary when robust plants are desired. Transplants have a more compact root system with more small fibrous roots than seedlings of the same age. They have a shorter, stockier shoot and a more regular and symmetrical crown. The greatest objection to the use of transplanted stock is its high cost. Wagner believes, however, that the transplanting of Norway spruce develops an unnatural root system and he advocates the use of seedling stock although the loss may be much greater. Fron states that coniferous plants should not be transplanted even without any consideration of cost because untransplanted stock is much better than transplanted when future growth and development are duly considered. Although there is much controversy regarding the use of untransplanted as compared with transplanted stock, *it must be admitted that the latter is necessary for planting adverse sites because of the much greater losses that occur when untransplanted stock is used.* When the object is to produce large, strong plants with a full, spreading root system, they are transplanted two or more times at intervals of one or two years between each successive transplanting. Broadleaved species when grown in the United States for forest planting are seldom transplanted but are transferred from the seedbed to the field when one or at most two years old. Conifers, on the other hand, often are transplanted. *It is the author's belief that transplanted conifers are used far more extensively than is necessary and that in many localities where we are now using transplanted stock, robust seedlings which can be produced at less than half the cost can be used with equal success.*

Recent experiments by the U. S. Forest Service in Montana and Idaho indicate that much less cost per surviving tree is incurred by planting seedling pine on the better sites than by planting transplants. Experiments conducted at the Priest River ex-

periment station indicate that western white pine seedling stock has a rate of growth equal to transplants, and a lower cost per surviving tree. Yellow pine seedlings have greater survival, more rapid growth, and a cost per surviving tree 300 per cent less than yellow pine transplants. The extensive coniferous plantations established in recent years by the Pennsylvania Forest Service have been formed almost entirely from 2-year seedling stock. The large plantations of white pine made in Michigan during the past decade by the Forest Commission have been formed by planting 2-year stock in plowed furrows. This regeneration has been attained at a cost of from \$7 to \$8 an acre with a percentage of failed places, in many instances, of less than 6 per cent of the total number of trees planted. Although the above results are by no means conclusive and are applicable to special sites, they clearly indicate the usefulness of seedlings in the artificial regeneration of coniferous forests in the United States. The present tendency to use white pine and red pine transplants on all classes of sites in New England is expensive and unnecessary. Well-grown, robust seedlings will succeed equally well on the better sites and the regeneration can be attained at much less cost per surviving tree.

Mayr¹ states that in European practice the various species of pine are usually grown to the proper size for field planting without transplanting. The practitioner must determine for each species and locality the size and quality of stock that it is most advantageous to use. His judgment must be based chiefly upon the characteristics of the species and the condition of the site as to cover and soil.

The stock used for transplanting is usually 1-, 2-, or weakly developed 3-year plants. In the tropics the most suitable age is often but a few weeks. The various species of *Eucalyptus* and occasionally other species are transplanted in California and Florida when but a few months old. When used for forest planting, the stock usually remains in the transplant bed but 1 or 2 years. When left longer in the transplant bed most species require thinning and severe root pruning or retransplanting. *Stock grown for forest planting in the United States is usually held only 1 year in the transplant bed.*

¹ Mayr, Heinrich: *Waldbau auf naturgesetzlicher Grundlage*. S. 404. Berlin, 1909.

It is seldom necessary or desirable to erect an artificial cover over transplant beds. Sometimes, however, they are formed under an open stand of trees which provides a natural shade. If the transplant beds are exposed to the sun the plants are hardier and better able to resist exposure when finally transferred to the field. Watering transplant beds is rarely necessary except in regions of deficient summer rain.

41. The Size and Form of Transplant Beds.— The ground for transplant beds is prepared much the same as for seedbeds. It is deeply plowed, manured when necessary, and carefully leveled. It is particularly important that coarse manure and dense vegetation are not plowed under immediately before the formation of the beds, as they seriously interfere with the setting of the transplants and harbor the larvæ of the May beetle and other destructive insects. Transplant beds are usually much larger than seedbeds. The form and size depend primarily upon the method of cultivation practiced in tending them. When hand cultivation with the hoe and similar tools is practiced the beds are from 3 to 6 feet wide with the rows usually extending cross-wise. When wheel cultivators like the Planet Jr. or horse-drawn cultivators are used, the rows extend lengthwise of the beds and a single transplant bed may occupy an entire compartment. The paths between the transplant beds are usually 18 inches wide and slightly depressed below the surface of the beds or on the same level.

42. Season for Transplanting.— Although adequate care makes transplanting possible at any time when the soil can be worked, *the cost of the operation and the percentage of loss incurred are chiefly dependent upon the season and weather conditions during the transplanting and immediately afterward.*

Early spring is the best time for transplanting in nearly all parts of the United States. This applies to all species and all classes of stock. The stock should be transplanted as soon as possible after lifting from the seedbeds.

Broadleaved species should not be transplanted after the buds open and the foliage begins to develop. Most conifers can be safely transplanted, if weather conditions are favorable or facilities are afforded for watering the beds, for a period of several weeks after spring growth has begun. *Late transplanting, however, should not be attempted during dry, windy weather and when the*

surface soil is dry, as it invariably results in excessive loss. Ordinarily transplanting should begin as early in the spring as the ground is in condition to work and be continued until new growth starts.

The greatest objection to autumn transplanting in most parts of the United States is the loss due to the trees being thrown out of the ground by the frost in early spring. Were it not for this danger autumn transplanting in many localities would be preferable to spring transplanting. Autumn transplants that survive winter damage start their growth much earlier than spring transplants and make larger and more vigorous plants. When there is danger that seedlings set in the transplant bed in the autumn will be thrown by the frost, the beds should be lightly mulched with leaves or straw.

Although a limited period in the spring is usually the best time for transplanting, large nurseries which transplant several million trees yearly find it necessary to extend the transplanting over a longer period. Thus, in many of the large nurseries at Halstenbek, Germany, transplanting begins about the middle of September and ends the following August, but the best results are obtained from the early spring transplanting. In many of the small nurseries transplanting is confined to a period of about three weeks in the spring just before the buds begin to start. If for one reason or another the transplanting is not completed during this period, it is deferred until the following year.

43. The Transplanting Distance. — The spacing in the transplant bed should be governed by one or more of the following considerations:

- a. The smaller the plants the closer the spacing.
- b. The longer the plants remain in the transplant bed the wider the spacing.
- c. The more crown space required the wider the spacing.
- d. Light-demanding species require wider spacing than tolerant ones.
- e. The spacing should become wider with each transplanting.

Pettis¹ recommends that 2-year coniferous seedlings be transplanted in rows 6 inches apart and at a spacing of 4 inches in the rows, when the plants are to remain in the transplant beds 2

¹ Pettis, C. R.: How to grow and plant conifers in the northeastern states. (U. S. Forest Service, Bul. 76, p. 21. 1909.)

years. When they remain in the transplant beds but 1 year, they are spaced only 2 inches in the rows.

Most conifers when transplanted after 1 or 2 years in the seed-bed can be safely set at $1\frac{1}{2}$ -inch intervals in the rows when they remain but a single year in the transplant beds. Only the most rapidly growing species like larch require a wider spacing. When the plants remain in the transplant beds over the second year they should have at least twice the space in the rows. Broad-leaved species when transplanted require a wider spacing.

The following table shows the closest spacing in the transplant beds that can be practiced in the production of first-class stock. Wider spacing is usually more costly as fewer plants are produced on a given area of transplant bed, but when wider spacing makes cultivation less expensive through the use of hand or horse cultivators it often is justified.

TABLE OF SPACING IN TRANSPLANT BEDS

| Species. | Age of seedlings in years. | Space between rows in inches. | Spacing in rows in inches. | Time in transplant beds in years. |
|-----------------------|----------------------------|-------------------------------|----------------------------|-----------------------------------|
| White pine..... | 1 | 6 | $1\frac{1}{2}$ | 2 |
| White pine..... | 2 | 6 | $1\frac{1}{2}$ | 1 |
| White pine..... | 2 | 8 | 3 | 2 |
| Scotch pine..... | 1 | 6 | $1\frac{1}{2}$ | 1 |
| Scotch pine..... | 2 | 6 | 3 | 1 |
| Scotch pine..... | 2 | 10 | 4 | 2 |
| Red pine..... | 2 | 6 | $1\frac{1}{2}$ | 1 |
| Red pine..... | 2 | 6 | 3 | 2 |
| Jack pine..... | 1 | 6 | $1\frac{1}{2}$ | 1 |
| Jack pine..... | 2 | 6 | 3 | 1 |
| Jack pine..... | 2 | 10 | 4 | 2 |
| Yellow pine..... | 1 | 6 | $1\frac{1}{2}$ | 1 |
| Yellow pine..... | 2 | 6 | 3 | 1 |
| Yellow pine..... | 2 | 10 | 4 | 2 |
| Norway spruce..... | 2 | 6 | $1\frac{1}{2}$ | 1 |
| Norway spruce..... | 2 | 6 | 3 | 2 |
| Norway spruce..... | 3 | 8 | 3 | 1-2 |
| Sitka spruce..... | 2 | 6 | $2\frac{1}{2}$ | 2 |
| Engelmann spruce..... | 2 | 6 | $1\frac{1}{2}$ | 2 |
| Douglas fir..... | 2 | 6 | $1\frac{1}{2}$ | 1 |
| Douglas fir..... | 2 | 6 | 3 | 2 |
| White fir..... | 2 | 6 | $1\frac{1}{2}$ | 2 |
| European larch..... | 1 | 8 | 4 | 1 |
| Red oak..... | 1 | 12 | 4 | 1 |
| Beech..... | 1 | 12 | 6 | 1 |
| White ash..... | 1 | 12 | 6 | 2 |
| Sugar maple..... | 1 | 12 | 4 | 1 |

44. Transplanting Methods. — Various methods have been developed for “pricking out” or transplanting young trees. All methods may be classed under the following heads:

- a. Hole or pit transplanting.
- b. Trench or furrow transplanting.

Under the former a separate opening is made in the soil for each plant. Under the latter many plants are set out at one time in a common trench or furrow.

45. HOLE OR PIT TRANSPLANTING. — This method is most useful in transplanting large stock, particularly hardwood species and conifers that are transplanted for the second time. A planting line is stretched lengthwise of the transplant bed. Wire makes an excellent planting line as it does not stretch. The planting intervals are marked on this line or are judged by the eye. The planters open holes at the desired intervals and set the plants by hand. The tool used depends upon the size and form of the plants, particularly the roots. The openings for the insertion of plants like oak, chestnut, and hickory that have long tap roots and few weak laterals are often made with a planting staff or similar implement.

The hole or pit method is also used in many nurseries for transplanting small stock such as 1- and 2-year conifers. In planting small stock a board is often used in the place of a planting line as a guide in setting the plants. When the transplant beds are 6 feet wide the board is 3 inches longer than the width of the bed. Two 3-inch pegs are inserted on the under face of the board to prevent it from slipping when placed on the ground. The width of the board depends upon the spacing of the rows. When 6 inches apart, the board should be 5 inches wide. Notches are cut opposite each other on both edges of the board at $1\frac{1}{2}$ -, 2-, or 3-inch intervals, depending upon the spacing of the plants in the row. A line is stretched along one side of the bed and the board is placed at the end of the bed with one end against the line and at right angles to it. After the row is planted the board is moved along and another row planted, the work proceeding in like manner until the bed is filled. If care is taken to keep the end of the board against the line and at right angles to it, the plants will be in straight lines in both directions (Fig. 79).

Pettis¹ states that 2 workmen, 1 at each end of the board,

¹ Pettis, C. R.: How to grow and plant conifers in the northeastern states. (U. S. Forest Service, Bul. 76, p. 21. 1909.)



Photograph by U. S. Forest Service

FIG. 79. — Transplanting Douglas fir seedlings by the hole or pit method. Near Pocatello, Idaho.

should transplant 1- or 2-year coniferous seedlings at the rate of from 400 to 500 per hour. In this method of transplanting the workmen kneel on the unplanted portion of the bed facing the board and make openings in the soil opposite the notches in the board. The openings are made with the dibble, trowel, or planting hammer, held in the right hand. The plants are inserted with the left hand and the openings closed. The dibble should be used only when the stock is very small and has weak lateral roots. Care should be taken that the roots are not curled upward at the ends due to the narrowness of the opening. A long, narrow trowel or the ordinary mason's trowel is very effective in transplanting by this method. The plants should be set at the same depth as they were in the seedbeds and the soil should be thoroughly firmed about the roots. Mayr¹ recommends the planting hammer as an efficient tool for setting small transplants (Fig. 80). It is more

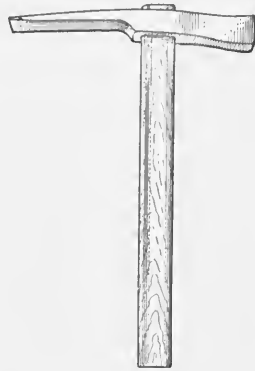

FIG. 80. — The planting hammer.

¹ Mayr, Heinrich: *Waldbau auf naturgesetzlicher Grundlage*. S. 406. Berlin, 1909.

rapid in operation than the dibble or trowel. In using the planting hammer the workman faces the planting line or board and with the right hand inserts the hammer. A hole back of the blade is

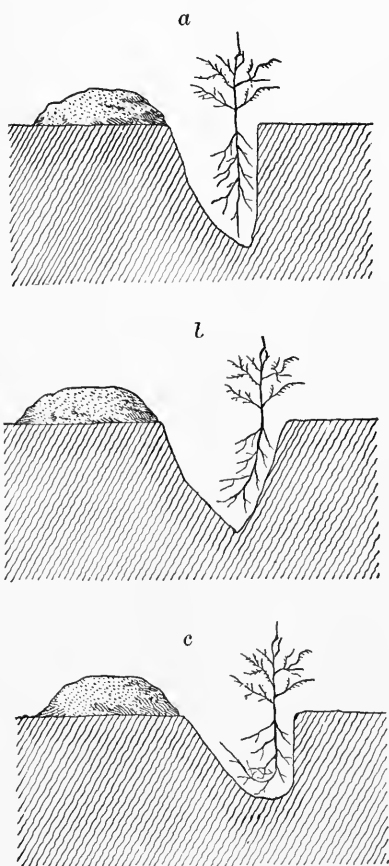

FIG. 81. — Cross sections of planting trench.

- a. Correctly made; one side vertical.
- b. Incorrectly made; side not vertical.
- c. Incorrectly made; too shallow.

are usually made with the hand plow, the short-handled spade, the hand trencher, the trenching rake, or by special machines.

47. Trenching with the Spade. — A board slightly narrower than the space between the rows is placed on the transplant bed.

formed by a forward movement of the handle. The plant is inserted in this opening with the left hand and the hammer withdrawn. A backward movement of the blade closes the opening.

46. TRENCH OR FURROW TRANSPLANTING. — Transplanting in trenches is usually less expensive and more effective than pit or hole transplanting when small stock is used. Horse and hand plows, spades, various kinds of trenchers, and Hacker's transplanting rake and machine are used for making the furrows or trenches which run either crosswise or lengthwise of the bed. The plants are set by hand one at a time or various kinds of planting boards are used in which a number of plants are strung and planted at one time.

The opening for the insertion of the plants can be satisfactorily made with the ordinary one-horse plow when the rows are wide spaced and extend lengthwise of the bed. When the rows are spaced at intervals of 15 inches or less the trenches

The workman, standing with one foot on the board and the other on the bed, opens up a trench with the spade along one side of the board. This trench should be vertical on the side next the board and from 4 to 10 inches deep, depending upon the length of the roots of the plants (Fig. 81). As soon as the plants are in the trench and the soil firmed about the roots the board is moved forward the spacing distance of the rows, and the operation continued until the bed is planted. The spade is the only tool used in the formation of the trenches in lining out seedlings in most forest nurseries in the United States.

48. Trenching with the Hand Trencher. —

The hand trencher can often be used to advantage in making small V-shaped trenches in loose, sandy soil for transplanting 1- and 2-year conifers. The author has found this implement impractical for use on compact soils as it cannot be readily forced into the soil to sufficient depth (Fig. 82). Heyer¹ recommends a hand trencher made of wood for the rapid making of trenches in which small plants are set.

Mast² recommends the following as a very efficient trencher. Two plates of

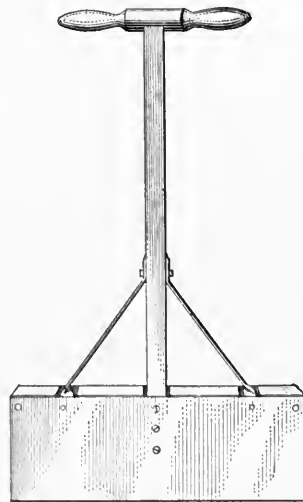

FIG. 82. — The hand trencher.

are welded together along one edge and drawn out to a thin cutting blade. The opposite edges of the plates are separated about an inch, allowing space into which thin pieces of $\frac{3}{4}$ -inch pipe slightly flattened are inserted and riveted. One piece is inserted in the center and the other two at $1\frac{1}{2}$ inches from the ends of the plates. All are brought together in a cross or 4-way pipe connection 8 inches above the plates. Into the upper opening of the cross a piece of pipe 20 inches long is fitted, at the upper end of which is attached a T-handle. This trencher weighs from 18 to 24 pounds.

¹ Heyer, Carl: *Der Waldbau oder die Forstproduktenzucht*. 1. Bd. S. 289. Leipzig, 1906.

² Mast, W. H.: New tools for transplanting conifers. (*Forestry Quarterly*, vol. X, p. 4. 1912.)

In its operation it is placed at the point where the trench is to be made and forced into the soil by pressure of the foot on the top of the blades. By moving the handle to and from the body, it is readily worked into the soil to the depth desired. The implement leaves a trench with smooth sides, 2 or 3 inches wide at the top and any desired depth up to 12 inches.

The trencher is acceptable for use only in loose, sandy soil, entirely free from stones, roots, and other obstructions. As the soil becomes heavier the trencher is forced into the ground with increasing difficulty and the sides of the trench are too compact for successful transplanting.

49. SETTING THE PLANTS IN THE TRENCH BY HAND. — In many nurseries as the trench is made workmen set the plants by hand. A number of plants are held in the left hand and the workman kneeling on the bed facing the trench begins at the right taking the plants one at a time between the thumb and forefinger of the right hand and places them in the desired position against the wall of the trench with the roots hanging vertically downward. With the remaining fingers of the right hand the loose soil is brought against the roots. After all the plants are set the trench is completely filled and the earth pressed down with the feet.

This method works very expeditiously with experienced labor and is the only method practiced in many of the largest nurseries both in Europe and in the United States. Although excellent in principle, it is very difficult to fill in the soil about each tree as it is set without some of it occupying the trench where the following tree should be set. *The roots are likely to be set too shallow or bent to one side and as a result the plants develop a lop-sided root system.*

50. SETTING THE PLANTS IN THE TRENCH WITH THE TRANSPLANTING BOARD. — Of late years a great variety of transplanting boards have been constructed with the object of facilitating and reducing the cost of transplanting. In all of these boards the plants are placed in grooves or notches at regular intervals along the board and brought over the trench with the roots hanging vertically downward. When properly adjusted the earth is filled in about the roots and the board removed. When the trench is made sufficiently deep, the planting board is a very efficient and valuable nursery implement. The plants are more regularly

spaced and much deeper and more uniformly planted than when they are pricked out singly by hand.

A stringing table or rack upon which the board rests while the plants are inserted in the grooves is used with all except the combined transplanting and trenching board. This should be of suitable height to permit the stringers to place the plants in the grooves most rapidly and with the least expenditure of energy. The seedlings are kept moist in pails or baskets suspended under the center of the table within easy reach of the stringers. A few seedlings are taken in the left hand by each stringer and rapidly transferred with the right hand to the notches in the board. The stringer at the right end of the board begins at that end, while the stringer at the left end begins in the center of the board and strings toward the left. Care should be taken to adjust the plants in the notches so that when finally planted they are set at a uniform depth. The table should be enclosed at the back, the two ends, and above by a canvas or burlap screen to protect the young seedlings from the sun and wind.

51. *Types of Transplanting Boards.*—Rath's transplanting board, in which the plants are held in the notches by means of a string, and a somewhat similar board described by Fischbach¹ are recommended by European authorities as among the best of this type. A transplanting board on this principle has been used to some extent in some of the nurseries on the National Forests (Fig. 83). It is 6 feet long, 6 inches wide, and 1 inch thick. One edge of the board is beveled down to $\frac{1}{2}$ inch in thickness and notches cut in it at intervals of from 1 to 3 inches, depending upon the spacing desired, and approximately 1 inch deep. The board is suspended on hooks on one side of the stringing table so that the notches reach above the surface of the table. The trees are "threaded" into the notches at right angles to the surface of the board and held in place by a heavy string drawn taut while being carried to the trench and planted. When the board is in place the roots hang against the vertical wall of the trench. Soil is filled in about them and thoroughly firmed, after which the string is loosened and the board removed.

The simplest type of transplanting board is the following, which also serves as a trenching board and has long been in use in Europe.

¹ Fischbach, C. von: Eine neue Pflanzlatte. (Allgemeine Forst- u. Jagd-Zeitung, S. 7-11. 1884.)

It is 4 or more feet in length, 5 or 6 inches wide, and 1 inch or more in thickness. A row of holes $\frac{1}{4}$ inch in diameter or larger are bored $\frac{1}{2}$ inch from the edge at the spacing interval desired. Wedge-shaped slots are cut from the edge of the board into the

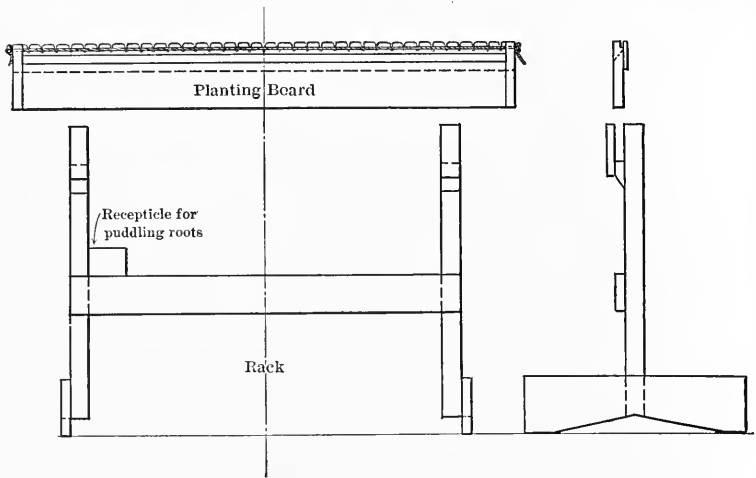

FIG. 83. — Stringing rack and transplanting board in which the plants are held in place with a string.

holes with the point of the wedge upward. Before the slots are cut the edge of the board between them is strengthened by nailing. In operating this board, it is placed upon the bed and serves as a trenching board. After the trench is dug the board is moved forward until the slots overhang its vertical edge and the seedlings are threaded into the holes through the slots. The spreading leaves of the seedlings prevent them from falling through. After threading, the board is pushed backward until the roots hang against the vertical wall of the trench. The soil is filled in and thoroughly firmed with the feet. A backward movement of the board disengages the seedlings as the holes must be large enough so that the slightest pull will draw them through. The size of the holes should be governed by the size of the stock transplanted (Fig. 84).

In using the board the stock should be nearly uniform in size or the smaller trees will pull through the holes while the larger ones will be pulled out of the soil or the tops injured in removing the board.

This simple board permits of rapid work, and when due care is taken the plants are well set. In 1912 at the Wind River nursery a maximum of 6533 trees per man was pricked out in one day (8 hours) and an average of 5165 trees per day for a period of 10

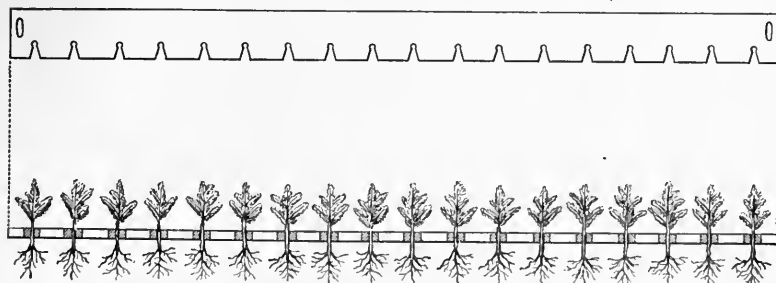

FIG. 84. — The combined trenching and transplanting board.



Photograph by U. S. Forest Service

FIG. 85. — Operating the combined trenching and transplanting board on the Columbia National Forest.

days. As the board rests upon the ground while stringing, the task is very irksome and tiresome. Furthermore, the plants cannot be as well protected from the sun and wind as when a board is used that is placed upon a table or rack while stringing (Fig. 85).

Transplanting boards in which a thin board or lath fits down over the plants after they are placed in the notches are superior to boards fitted with a string, as the plants are more securely held in place during the transplanting. In recent years a number of transplanting boards of this type have been constructed in the United States.

The one described by Mast¹ is 6 feet 3 inches long, 5 inches wide and 1 inch thick, with a handle attached in the middle and a piece of wood $1\frac{1}{2}$ inches wide nailed flush with the back of the board at the lower edge so as to project beyond the front. V-shaped notches are cut into this projection at from 1- to 3-inch intervals depending upon the spacing. When the trees are threaded into these notches the tops lie flat against the face of the board with the roots projecting beyond the lower edge. A thin, narrow slat is placed over the seedlings just above the notches and fastened by two buttons. This serves to hold the plants in place while transplanting.

In operating this board the transplanting crew usually consists of 5 or 6 men. Two or 3 men thread the seedlings in the transplant boards and bring them to the planters, 1 or 2 make the trenches with the spade or trencher, and 2 set the trees in the trenches and fill in about them. The division of labor depends upon the size of the plants and the relative ease with which the soil can be worked.

Mast reports that an experienced crew of 6 men can transplant with this board 2-year coniferous seedlings at the rate of from 25,000 to 35,000 in a working day of 8 hours.

The Yale transplanting board was constructed and first used by the author² in 1907 (Fig. 86). This board has since been introduced into many of the larger forest nurseries in the United States and Canada and is now more generally used than any other in this country. The board as usually made is 6 feet long and 6 inches wide with notches for the reception of the plants along the lower edge. It is fitted with 2 hinged handles. A thin board 6 feet long and 3 inches wide is attached to the upper end of the handles and swings down and holds the plants in place

¹ Mast, W. H.: New tools for transplanting conifers. (Forestry Quarterly, vol. X, p. 5. 1912.)

² Toumey, J. W.: The Yale transplanting board. (Forestry Quarterly, vol. IX, p. 539. 1911.)

while planting. The depth of planting is easily controlled and the soil is quickly filled in about the roots because of the protection afforded the tops while planting.

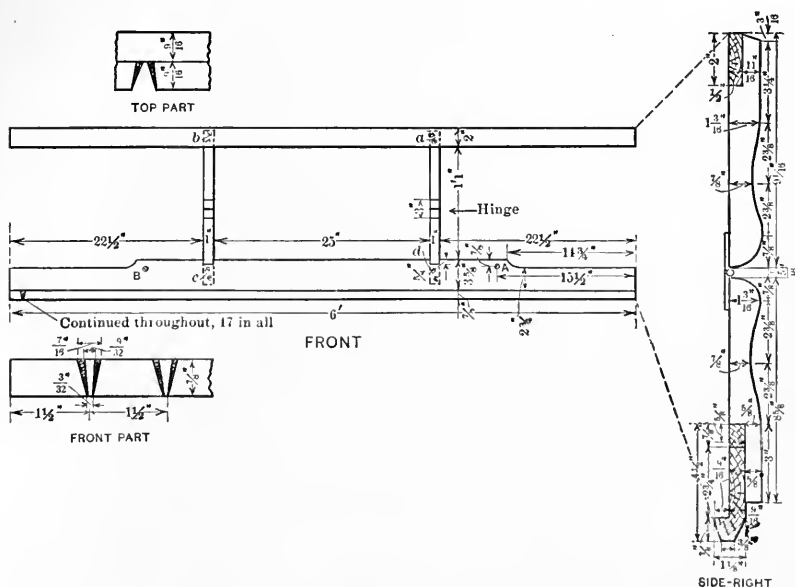

FIG. 86. — The Yale transplanting board.

In transplanting 1- and 2-year coniferous seedlings a crew of 5 laborers usually works with 2 boards. Two men trench and fill in about the roots, 2 men, women, or children stand at the stringing table and place the plants in the boards, and 1 man handles the boards in placing them in position over the trenches. A well-trained crew of 5 laborers working on loose soil, free from roots and stones, can transplant 1- or 2-year coniferous seedlings at the rate of from 25,000 to 40,000 per day of 8 hours. The rapidity of transplanting depends upon the character of the soil. When properly handled this board will set plants better and more uniformly than they can be set by hand and much more rapidly. It has proved more useful than other transplanting boards tested by the author and is more easily operated by inexperienced workmen (Fig. 87).

52. *Hacker's Apparatus and Machine for Transplanting 1- and 2-year Coniferous Seedlings.* — Two types of pricking-out implements devised by Rudolph Hacker have been much used in Europe in recent years. They very materially reduce the cost of



FIG. 87. — Operating the Yale transplanting board. Near New Haven, Conn.

making coniferous transplants on loose, well-tilled soil, but as yet they have been used only in an experimental way in the United States.

Both forms are constructed for use on transplant beds only 39 inches wide, with the rows extending crosswise of the beds. The two types are as follows:

- a. Hacker's pricking-out apparatus.
- b. Hacker's pricking-out machine.

The former is the simpler apparatus and consists of 2 heavy iron rakes, 3 or more transplanting frames, and 2 stringing tables or staffs (Fig. 88).¹ Five men or women form a transplanting crew, 2 of whom open and close the trenches with the rakes, while the remaining 3 string the plants in the frames and hold them in position while being set. The rakes are used in pairs. The handles are set oblique to the rake heads, one bending to the

¹ Hacker, R.: Vereinsachter Verschulapparat. (Centralblatt f. d. gesamte Forstwesen, S. 373. 1891.)

right and the other to the left, so that the workmen standing one on each side of the bed by working together open the trench at right angles to its length. The width of the rake head is such that the two together equal the width of the bed. The trench is



FIG. 88. — Hacker's pricking-out apparatus.

opened by striking the heavy, flat teeth of the rakes into the loose soil and bringing it forward. If the soil is in good tilth and not overwet or too dry, a trench several inches deep with a vertical or nearly vertical wall can be quickly made. The transplanting frame with the contained plants is brought over the trench which is then rapidly closed by a backward movement of the rakes. The stringing tables or staffs are very light and easily moved, thus preventing the loss of time in walking back and forth from them to the trenches. The transplanting frames are small and light, about $39\frac{1}{2}$ inches long, $2\frac{1}{4}$ inches wide, and $\frac{5}{8}$ inch thick. A board of the proper length and thickness is beveled on the upper face to a width of about $1\frac{1}{2}$ inches and on the lower face to 2 inches. A piece of strap iron $2\frac{1}{2}$ inches wide and the length of the board is nailed to the lower face and bent over the beveled edge. V-shaped notches are cut in the iron at intervals of 1 inch or more depending upon the spacing desired. These notches are approximately $1\frac{1}{2}$ inches deep, $\frac{3}{8}$ inch wide at the top and $\frac{1}{8}$ inch at the bottom.

The stringers stand facing the notches holding the plants in the left hand and stringing them into the board with the right. When the board is filled it is carefully removed from the table or staff and brought over the trench with the roots hanging downward against the perpendicular wall. Great care must be exercised in handling the frames or some of the plants will drop out. When

the soil is loose and free from obstructions 1-year coniferous seedlings can be pricked out very rapidly.

Hacker's pricking-out machine differs from the apparatus previously described in that a 2-wheeled frame carrying an iron rake of the same width as the bed is substituted for the transplanting rakes. In operating the machine it is placed crosswise of the bed with a wheel in the path at either side. The operator sits on a raised seat between the wheels facing the portion of the bed that is being planted. By means of his hands he manipulates the iron rake which is in a movable frame controlled by the feet. The rake is thrust into the soil and pulled forward, opening up a V-shaped trench. The transplanting frame is brought over the trench and the roots of the trees suspended against the vertical wall. A backward movement of the rake closes the trench, after which another trench is made and the operation continued until the entire bed is pricked out. The bed is gone over later and, where necessary, plants righted and the soil firmed about the roots.

One man working the machine and three men or women handling the frames and stringing the plants can transplant from 30,000 to 40,000 plants per day on well-prepared soil. The original machine has been improved and is extensively used in many forest nurseries in Europe.¹ It has not been introduced into the United States.

53. The Cultivation of Transplant Beds. — Broadleaved transplants in wide-spaced rows are usually kept free of weeds and the soil in acceptable tilth with the ordinary cultivators used in tending farm crops. Coniferous transplants and broadleaved species in closely spaced rows are kept in acceptable tilth by hoeing or by using the Planet Jr. or other hand cultivators. Cultivation should begin a few days after the trees are transplanted and should be repeated as often as necessary to keep the beds free from weeds and the surface soil loose and in good tilth. It is good practice to cultivate the beds as soon as practicable after each rain in order to loosen the surface soil and conserve the moisture. The cultivation of transplants during the first season costs from 25 cents to \$1 per thousand plants depending upon the character of the stock and the soil. Transplant beds seldom require shading in summer or mulching in winter.

¹ Hacker, R.: Ein maschine zum Uberschulen junger Nadleholzpflanzen. (Centralblatt f. d. gesamte Forstwesen, S. 433. 1883.)

54. POT TRANSPLANTING.

Pot transplanting is sometimes practiced in growing various species of *Eucalyptus* and to lesser extent in growing conifers in the warmer and more arid portions of the United States. The plants are transferred to the pots from the seedbeds or flats when from a few weeks to a year old. Collapsible pots, open at the bot-



Photograph by U. S. Forest Service

FIG. 89. — Pricking out plants into paraffined paper pots.

tom and made of paraffined paper, are chiefly used. These pots are filled with soil and arranged in flats. One or occasionally two seedlings are planted in each. After growing therein for a few months or an entire season the trees are planted with the pots. One man can prepare the soil and pot from 600 to 750 plants per day (Fig. 89).

CHAPTER XIV

THE FOREST NURSERY (*Continued*)

1. The Lifting and Later Treatment of Nursery Stock

EVERY operation from the lifting of the stock in the seedbed or transplant bed to the resetting in the nursery or field requires care and attention. The roots should be injured as little as possible in the lifting and the stock should be stored under conditions which afford adequate air and moisture. At no time should the plants, particularly the roots, be exposed to direct sunlight for a longer period than necessary. When the roots have been severely bruised or broken in lifting or when the plants have been injured in transport through lack of aëration or overdrying, more or less loss is to be apprehended when planted. It is not enough for plants to barely survive the planting; they ought to thrive from the first. The vigor exhibited by stock set in the transplant bed or forest plantation depends very largely upon the condition of the stock when planted. The loss incurred in transferring nursery stock from the seedbed to the transplant bed should not exceed from 5 to 10 per cent. If greater, nursery practice should be modified to overcome this loss. The loss incurred in transferring the stock from the nursery to the forest plantation is much less under control and depends upon a large number of variable factors. If the loss from a given method of practice exceeds 25 per cent, it should ordinarily be abandoned for one more certain of success.

Nursery stock should be set in the transplant bed or the field as soon as possible after lifting. The greater success attained in recent years in planting conifers in Nebraska and elsewhere under adverse climatic conditions is largely due to planting the stock soon after lifting. Bates and Pierce¹ recommend that special care be taken that the fine soil particles be left adhering to the roots as the plants

¹Bates, C. G. and Pierce, R. G.: *Forestation of the sand hills of Nebraska and Kansas.* (U. S. Forest Service, Bul. 121, p. 33. 1913.)

are lifted and that they be immediately transferred to planting baskets in which there are several double layers of burlap padded with damp moss. The trees are arranged in layers between the pads of burlap, thus keeping them adequately moist until planted. The trees should not be puddled or placed in pails or tubs of water, as it washes the fine particles of soil from the roots and severely injures the smaller rootlets. The soil which naturally adheres to the small rootlets when kept moist after the plants are lifted effects a close contact between the roots and the new soil when the trees are planted.

When the planting site is near the nursery the work should be so organized, particularly when climatic conditions are unfavorable, that the stock can be planted the same day or the day following its removal from the nursery.

It should be the practice in every forest nursery to prick out 1- and 2-year coniferous seedlings the same day they are lifted from the seedbeds. By a proper organization of the lifting and transplanting crews, when all of the work is conducted in the same or nearby nurseries, there is need for only a few hours to intervene between the lifting and transplanting. When 1-year conifers are lifted several weeks before transplanting and subjected to the ordinary methods of transport and heeling-in they invariably show a marked depreciation in vitality and growing power. One workman will ordinarily lift 1- or 2-year coniferous seedlings from fully stocked seedbeds as rapidly as 14 men can transplant.

The number of years that forest nursery stock remains in the seedbed and in the transplant bed, and the number of times transplanted are usually expressed by figures following the name of the species. Thus, white pine (1-0) signifies 1-year white pine seedlings; white pine (2-0), 2-year seedlings; white pine (1-1), 2-year plants, 1 year in the seedbed and 1 year in the transplant bed; white pine (2-1), 3-year plants 2 years in the seedbed and 1 year in the transplant bed; and white pine (2-1-1), 4-year plants 2 years in the seedbed and twice transplanted. The sum of the figures equals the age of the stock.

The following table gives the species and classes of coniferous stock most largely grown for forest planting in the different forest regions in the United States.

| Region. | Species. | Classes. |
|--|----------------------|-----------------------------------|
| Northern and central forest regions | White pine..... | (2-0), (1-2), (2-1), (2-2) |
| | Red pine..... | (2-0), (2-1), (2-2) |
| | Scotch pine..... | (2-0), (1-1), (2-1) |
| | Jack pine..... | (1-1), (2-1) |
| | Red spruce..... | (2-1), (2-2) |
| | Norway spruce..... | (2-0), (2-1), (2-2) |
| Northern Rocky Mountain region | White spruce..... | (2-1), (2-2) |
| | European larch..... | (2-0), (1-1), (2-1) |
| | Western white pine.. | (2-0), (3-0), (1-2), (2-1) |
| | Yellow pine..... | (2-0), (1-1), (2-1) |
| | Lodgepole pine..... | (3-0), (2-1) |
| | Engelmann spruce.. | (1-1), (2-1), (2-2) |
| Central and southern Rocky Mountain region | Douglas fir..... | (3-0), (1-2), (2-1) |
| | Western larch..... | (2-0), (1-2) |
| | Yellow pine..... | (2-0), (1-1), (1½-1) |
| | Austrian pine..... | (1-2), (2-1) |
| | Limber pine..... | (1-1), (2-1) |
| Northern Pacific Coast region | Engelmann spruce.. | (2-1), (2-2), (2-3) |
| | Douglas fir..... | (2-0), (1-1), (1-2), (2-1), (2-2) |
| | Western white pine.. | (2-0), (1-1), (1-2) |
| | Yellow pine..... | (2-0), (1-1), (1-2) |
| | Maritime pine..... | (1-1) |
| | Norway spruce..... | (2-1) |
| Central and southern Pacific Coast region | Douglas fir..... | (1-1) |
| | Japanese larch..... | (1-1), (1-2) |
| | Western red cedar.. | (2-1) |
| | Noble fir..... | (1-1), (1-2) |
| | Sugar pine..... | (2-0), (1-1) |
| | Yellow pine..... | (2-0), (1-1) |
| | Jeffrey pine..... | (1-1), (1-2) |
| Bigtree..... | (1-1) | |
| Incense cedar..... | (1-1) | |
| Deodar cedar..... | (1-1) | |

2. LIFTING NURSERY STOCK FROM SEEDBEDS AND TRANSPLANT BEDS

The method best to employ in lifting stock depends upon its size, the character of the root system, the density of the stand, and the soil. *It should be accomplished by exerting as little strain as possible on the tops of the plants while removing them from the soil.* When too much force is applied the ends of the small rootlets are broken off and the cortex on many of the remaining roots loosened and the trees rendered useless. Many of the lateral roots are broken at their union with the main axis and the lower part of the stem is sometimes split. If the beds are dry, they should be thoroughly moistened one or two days preceding the

removal of the trees. The stock should be transferred to baskets or boxes as soon as it is lifted. It should be protected from the sun and wind and taken at once to the packing shed for assortment and shipment or for storage, or else taken to the field for planting.

3. Lifting Nursery Stock from Broadcasted Seedbeds and from Seedbeds with Closely Spaced Rows.—One- or 2-year coniferous stock is usually removed from the seedbed with the lifting



FIG. 90. — Lifting white pine (2-1) with the short-handled spade.
Near Cheshire, Conn.

fork, the ordinary short-handled spade, or the spading fork. The spade or fork is inserted vertically in the soil close to the plants and deep enough to reach the lower roots. A piece of the bed with the contained plants is removed and shaken until it falls to pieces releasing the plants. On the heavier soils the inserted spade or fork should be moved vigorously backward and forward, at the same time gently pulling on the plants. The roots are gradually liberated and the plants removed with little

injury. When seedbeds are fully stocked with 1- or 2-year conifers from 40,000 to 75,000 plants can be lifted with the spade or fork and placed in buckets or baskets by 1 workman in a day of 8 hours. Each crew of 2 men working under average conditions should lift and transfer to the baskets or boxes from 20,000 to 40,000 coniferous transplants (2-1) in a day (Fig. 90). The number rapidly decreases with the size of the stock, the compactness of the soil, and the spacing.

The same methods that are practiced in lifting seedlings from wide-spaced rows are used in lifting transplants. One or 2 rows are removed at a time. Usually 2 men work together, one handling the spade or fork and the other lifting the plants from the loosened soil. In the author's opinion the lifting fork (Fig. 91) is better for lifting transplants than the ordinary spade or spading fork. It is much easier to operate with the same expenditure of energy, can be forced to a greater depth in the soil, and is stronger and more durable. The handle is similar to that of the ordinary short-handled spade except that it is straight and stronger. The fork is 8 or 10 inches wide and 4- or 5-pronged. It is made of tool steel, and the flattened, straight prongs are from 8 to 16 inches long depending upon the character of the stock lifted, particularly its length of root. The fork is forced vertically into the soil about 3 inches from the plants and the handle brought backward. By this operation the prongs are moved forward and upward loosening the soil and lifting the plants.

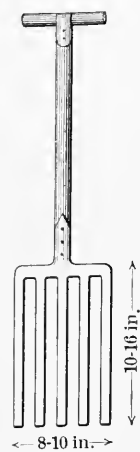

FIG. 91.—The lifting fork.

Mayr¹ recommends the digging of a trench parallel with the first row of trees and about 3 inches distant. The trench should be as deep as the roots penetrate the soil. Ordinarily 2 men constitute the lifting crew. One forces the spade into the soil 1 or 2 rows back from the trench and brings the soil with the contained seedlings forward into the trench. At the same time the second workman grasps the trees as they move forward and lifts them from the soil.

¹ Mayr, Heinrich: *Waldbau auf naturgesetzlicher Grundlage*. S. 395. Berlin, 1909.

4. Mechanical Devices for Lifting Seedlings and Transplants.

— A number of mechanical devices have been developed in Europe and the United States for lifting the stock from the seedbed and transplant bed. Laudenberger's mechanical tree lifter¹ is representative of the form often used in Europe. It consists of a heavy steel rake as long as the width of the bed supported on a wooden frame which spans the bed and rests on the path on either side. The long teeth are forced obliquely into the soil beneath the seedlings or transplants and a portion of the bed with the contained plants raised by means of the heavy handles which work as levers from the supporting frame. This machine can be used only on light, loose soil free from all obstructions. Two men operate it while others follow, shake the soil from the roots and gather the plants into baskets or boxes for transport to the packing shed. This method of lifting seedlings and transplants has not been introduced into the United States. Uiblagger reports, however, that it reduces the cost of lifting coniferous stock from seedbeds to approximately one-half that incurred in lifting with the spade or fork.

The Feigley tree digger (Fig. 92) is used in lifting large seedlings and transplants at some of the nurseries on the National Forests. This implement is operated by horse power much the same as a plow. It is essentially a horizontal, sharp-edged wedge which is run under the trees at any desired depth not exceeding 12 inches. It lifts the entire body of soil with the contained trees and drops it again, thereby loosening the roots so that the trees are rapidly pulled without much loss of roots. It is run close to the plants, loosening at one time a strip of soil about a foot wide the entire length of the bed. After the loosened plants are removed, another strip is similarly loosened. The implement is difficult to guide and is likely to injure some of the plants by cutting off the roots too near the surface. The soil is loosened to such an extent that the plants must be quickly removed to prevent the roots from becoming dry.

A tree digger devised by S. D. Smith was first used at the Halsey nursery in 1913. It has been used chiefly in lifting coniferous transplants from beds 6 feet wide. The device consists of a heavy steel-bitted blade, 7 feet long and 12 inches wide, mounted

¹ Uiblagger, C. von: Die Laudenberger'sche Pflanzenhebmaschine. (Forstw. Centrallblatt, S. 109-114. 1908.)



FIG. 92. — The Feigley tree digger.



Photograph by S. D. Smith

FIG. 93. — The Smith tree lifter in operation.

in a slanting position on an iron frame. The frame is made of 5-inch channel iron and the cutting edge of the blade of $\frac{3}{8}$ -inch steel. The device is drawn lengthwise of the bed by means of a cable and capstan operated by horse power. The blade, which reaches across the bed, can be adjusted for any desired depth. When in operation the machine moves forward at the rate of about 6 feet per minute. The soil with the contained plants is lifted by the blade. As it drops over the rear, 4 men following behind remove the plants from the loosened soil and transfer them to boxes or baskets or to other workmen for heeling-in. Smith reports that this device reduced the cost of lifting coniferous transplants at the Halsey nursery in 1914 to about one-half the cost of lifting by hand. The entire machine weighs approximately 350 pounds and costs about \$80 to construct (Fig. 93).

5. SORTING, COUNTING AND BUNDLING NURSERY STOCK

As soon as seedlings and transplants are lifted they should be transferred to baskets or boxes for transport to the packing shed, to some other part of the nursery for transplanting, or to the forest plantation. If there is any delay in getting the stock into baskets or boxes, it should be temporarily heeled-in as lifted to be later taken to the packing shed, transplant bed, or field. During moist and cloudy weather it is sometimes advantageous to count, sort, and pack the stock in the nursery as lifted. When the weather is dry and windy the roots are likely to become over-dry in the process of sorting and counting if done in the open field.

When seedlings and transplants are grown for home use, it is not necessary to count the stock or tie it in bundles with a definite number of trees in each, neither is it necessary to sort out the culls and trees with double



FIG. 94. — Bundle of 50 white pine seedlings (2-0).

leaders or those that are otherwise undesirable. They can be eliminated as the stock is set in the transplant bed or field. When the stock is sold or prepared for long transport, it is carefully sorted and tied into bundles of 25, 50, 100, or 200 plants each (Fig 94). Except in cases where accurate count of the stock is required, it should be estimated in the bed before lifting. In the estimate no account should be taken of culls. The actual counting and bundling of small stock is a slow and expensive operation.

When seedlings and transplants are prepared for sale or for packing and rail shipment they are usually brought to the pack-

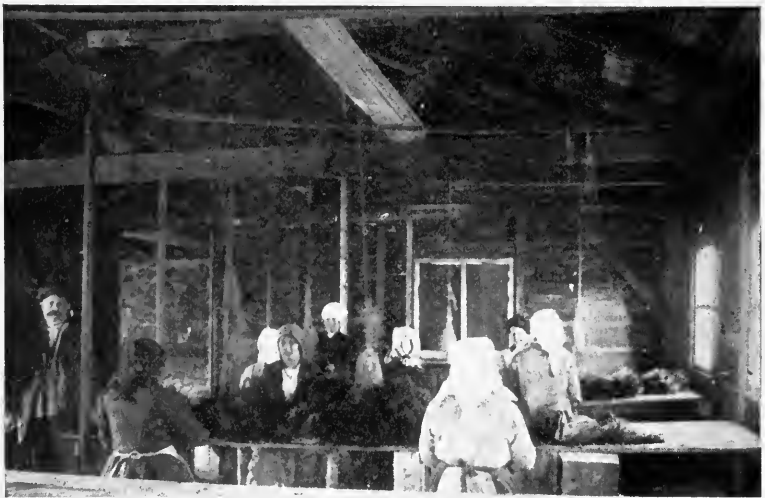

FIG. 95. — Sorting and bundling white pine nursery stock (2-1).
Near Cheshire, Conn.

ing shed as soon as they are lifted and spread out on long tables where the culls and other discards are thrown out, after which they are counted, tied in bundles, and heeled-in until packed for shipment (Fig. 95). *The culls and discards should not be reset in the nursery. They represent the poorer and weaker individuals in which many of the defects are inherited.*

One workman will sort, count and bundle 1- or 2-year coniferous seedlings at the rate of from 15,000 to 20,000 in 8 hours, and 3- or 4-year plants once transplanted at the rate of from 10,000 to 15,000.

6. METHODS OF STORING NURSERY STOCK

Many nurserymen lift their stock in late autumn before the ground freezes or in early spring as soon as the soil is free from frost and store it until ready for shipment or transport to the plantation or transplant bed. When large operations are under way or when stock is purchased from commercial nurseries, weeks, or even months, often intervene between the lifting of the stock and the final resetting in the transplant bed or field. It is sometimes packed and repacked two or three times. Under such conditions the utmost care must be taken in order to prevent the stock from becoming severely injured. Deciduous stock can be lifted in the autumn and held over winter in storage with much greater success than evergreen stock.

Nursery stock is usually stored by one of the following methods:

- a. Heeled-in in the open.
- b. Heeled-in under cover.
- c. In cold storage.
- d. In snow or ice pits.

The term heeling-in is applied to the temporary burying of the plants in moist soil in order to prevent the roots from becoming dry. Deciduous species can be completely covered with soil. At least a portion of the tops of evergreen species should ordinarily be exposed to the air but not to direct sunlight.

When small stock is heeled-in in the open a trench is dug in loose, well-drained soil with the wall sloping slightly from the vertical. The plants are arranged in an upright position in a thin layer against this wall. It is particularly important that they be disposed in a thin layer if they are to remain for some weeks in the trench. When the stock is placed in thick layers or in untied bundles, it is impossible to bring the soil into intimate contact with the roots and they are likely to become overdry. If coniferous stock is overwet and the tops are covered with leaves or other litter, it often molds and becomes worthless. The trench should be deep enough to prevent the bending of the roots or otherwise cramping them out of their natural position. As fast as the plants are arranged along the sloping wall, a workman fills in the soil against them taking it from the opposite wall so as to form the next trench. Soil should be piled against the roots and the lower part of the stems and carefully worked in between them with the fingers and firmed with the feet.

Nursery stock is often heeled-in on the floor of the packing shed (Fig. 96). When possible, the packing shed should be located on sloping ground with the floor on a grade with the ground on the lower side. The arrangement permits the easy unloading and loading of stock as it is brought in from the nursery and later shipped to its final destination. The floor should consist of a foot or more of clean sand. Facilities should be afforded for light and ventilation and the sand should be kept moist. Stock lifted in the autumn or in the early spring, when not shipped directly



FIG. 96. — About 400,000 coniferous seedlings and transplants heeled-in on the floor of the packing shed and awaiting shipment. Near Cheshire, Conn.

from the field, is heeled-in on the floor of the packing shed and packed and shipped as required. The trenches are rapidly excavated in the loose sand and the plants heeled-in without untying the bundles if the period of storage is short. The trees are usually sorted and tied in bundles as they are received from the seedbeds or transplant beds. When the stock remains in the packing shed for several weeks it should be heeled-in without sorting and bundling until required for shipment.

Nursery stock can be held for long periods in cold storage when properly packed. This method of storage is sometimes practiced in holding stock for late shipments when under ordinary methods

of storage new growth is likely to start before the shipments can be made.

Nursery stock stored under the ordinary methods of heeling-in starts its growth with the advent of warm weather. When stock is required for late planting, growth can be held back by storing it in snow or ice pits on the planting site. Heyer¹ recommends the snow pit as an acceptable method for storing small stock beyond the normal time for planting (Fig. 97).

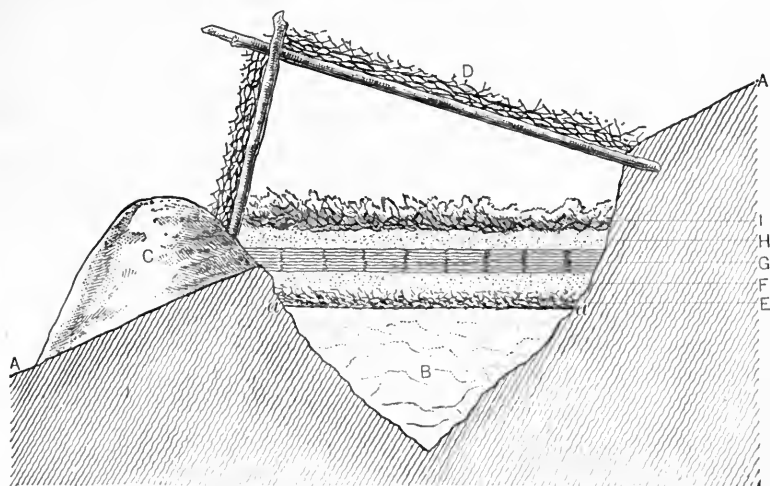

Fig. 97. — Snow pit for storing nursery stock.

- | | | | |
|------|----------------------|----|---------------------------|
| A-A. | Line of slope. | E. | Layer of twigs. |
| B. | Snow. | F. | Layer of soil. |
| C. | Excavated soil. | G. | Seedlings or transplants. |
| D. | Shelter of branches. | H. | Layer of soil. |
| | | I. | Layer of branches. |

Suitable places for snow pits can usually be found on the area to be planted. Holes due to windfalls on northern slopes can often be utilized. If such are not available, they must be dug. They should be excavated to a depth of about 5 feet and filled with snow firmly packed down. A layer of twigs is placed on the snow, followed by a layer of fresh soil. The plants are disposed in a compact layer on the soil and the whole covered with another layer of fresh soil to the depth of several inches and a

¹ Heyer, Carl: *Der Waldbau oder die Forstproduktenzucht*. 5. Aufl., 1. Bd., S. 221. Leipzig, 1906.

layer of branches spread over the top. A rude shelter of branches is erected over the pit. Plants can be held for many weeks in a dormant condition under this shelter.

7. THE TRANSPORT OF NURSERY STOCK

In packing nursery stock for transport the weather conditions, distance, and time in transport must be considered. Careful packing and protection must be given when the transport is during warm, dry weather. In cold weather the plants must be protected from freezing. When the stock is a long time in transport, there is danger of its becoming overdry unless well packed with the roots protected by an abundance of moist, but not wet, moss. If the tops of evergreens are not exposed to the air, the plants are likely to mold or the centers of the bundles become heated and worthless.

If the distance of transport is short, as is the case where a home nursery is maintained to grow stock for planting in the immediate vicinity, the plants may be packed in a wagon or other vehicle for transportation and taken directly to the planting site. They may be placed in the wagon box, in planting baskets, or in large packing cases or boxes.

When seedlings are moved from the seedbed to a nearby transplant bed, the plants are carried in baskets, pails, boxes, or other convenient receptacles.

When weather conditions are such that the roots will not become overdry during the operation of transplanting or field planting, they should not be placed in water or "puddled" as this tends to wash the fine soil from them or mass them together. When there is danger, however, that the stock will suffer from exposure to sun and wind, it is best to drench it with water, place it in tubs or buckets of water, or subject the roots to a puddle made of clay. Mayr¹ states that young nursery stock can lie in cold water for an entire week without appreciable detriment to its vitality.

When nursery stock is not more than one or two days in transit, it may be placed in large, covered hampers or baskets or in boxes that afford sufficient ventilation, but without moss or other packing. The plants are arranged so that the roots overlap and protect each other, while the tops are exposed to the air. These

¹ Mayr, Heinrich: *Waldbau auf naturgesetzlicher Grundlage*. S. 405. Berlin, 1909.

receptacles with their contents are thoroughly drenched with water before shipping.

When a few small plants are to be sent by mail or express, the weight of the wrappings is often more than that of the plants. They can usually be economically and successfully transported by packing the roots in damp moss, rolled in paraffined paper and wrapped with burlap.

If the plants are to be transported by rail or there is uncertainty in the time that they will remain in transport, the roots should be protected by placing moist moss around them. Care should be taken, however, that the moss is not overwet. Sphagnum moss is the best medium in which to pack the roots of plants in order to prevent overdrying. It can be gathered in large quantities at low cost in sphagnum swamps. If the nursery is not near a source of supply, it can be purchased by the bale or barrel from any dealer in gardener's supplies.

The trees are packed in bales, boxes, crates, or baskets depending somewhat upon the size and character of the stock and the fancy or convenience of the shipper.

8. Packing in Bales and Bundles. — Deciduous stock, even when of large size, is often baled or bundled for shipment. Fifty or more plants are bundled together with the roots in one direction and firmly tied. The roots are packed in damp sphagnum moss and the whole firmly wrapped in burlap. Usually heavy paper is wrapped about the moss-covered roots before the burlap is applied in order to prevent overdrying.

The following method of packing is practiced on some of the National Forests:¹ The plants, as lifted, are sorted and tied in bundles of 50 or 100 each. The roots of each bundle, with the tips bent back, are rolled in a layer of moist moss, and the roots and moss then wrapped in a piece of burlap about $1\frac{1}{4}$ feet square. The wrapped bundles are packed in boxes having the bottoms and the lower part of the sides and the ends tight, but with the tops and upper part of the sides constructed of slats with air spaces between. These boxes are especially designed for transportation to the plantation on pack animals. They are 24 inches long, 14 inches wide, and 15 inches deep. A layer of moist moss is placed in the bottom of the box and the bundles

¹ Wilcox, A. R.: Nursery practice at the Wind River nursery. Manuscript. 1913.

are placed upright upon it, the burlap about them being held in place by crowding. The box will hold about 1500 medium-sized transplants. When filled, moss is crowded into all open spaces along the sides. A layer of moss is also placed along the sides of the box as the bundles are put in. After nailing on the slat covers, it is thoroughly drenched with water. A box weighs approximately 75 pounds when packed and ready for shipment.

9. Packing in Boxes. — Tight boxes should never be used in shipping nursery stock. The size and form of the box should be governed by the size and character, as well as the quantity, of the stock in the shipment. Many nurseries use second-hand boxes purchased from nearby towns and villages, selecting forms and sizes suitable for the classes of stock that they handle. When such boxes are available they serve admirably as shipping boxes and cost less than new boxes. When second-hand boxes are not available standard forms of shipping boxes are constructed at the nursery (Fig. 98).

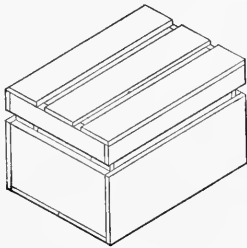

FIG. 98. — Standard shipping box for coniferous seedlings and small transplants.

In shipping broadleaved species in which the roots occupy more diameter space than the tops, the trees are tied in bundles of 25 to 100, depending upon their size, and the bundles arranged in the box with *the roots toward the ends of the box and the tops overlapping*. Damp moss, straw, or hay is packed about the roots and the whole surrounded by burlap. One or more cleats are firmly pressed down on the plants and fastened with nails driven into the box from the side. It is very important that the plants should not become loose and shake about during transport.

Coniferous roots occupy much less diameter space than the tops; furthermore, because of the foliage the tops demand air. In packing small coniferous seedlings and transplants a quantity of damp sphagnum moss is placed crosswise of the center of the box and at equal distance from the ends. A number of the bundles are placed side by side so that the roots rest upon the moss and the tops are within 2 or 3 inches of the end of the box. An equal number of bundles are now placed with the tops lying in the other

direction and the roots overlapping those of the first layer. When so placed, the tops should be within a few inches of the other end of the box. Layer after layer is filled in, placing damp moss between the layers where the roots come in contact and also crowding it between the plants and the sides of the box. After the last layer is put in, the exposed roots are covered with moss and finally with a piece of burlap or heavy paper. Two 3-inch cleats are placed crosswise of the box or crate, pressed down upon the plants, and held in place by nails driven in from the sides. Considerable pressure should be exerted on the plants in order to prevent them from slipping out of place during transport. If the box is more than $1\frac{1}{2}$ feet in height, cleats should be put in when the box is half filled and additional ones after filling. Slats with wide openings between are nailed over the top. After marking the box it is ready for shipment.

10. Packing in Hampers or Baskets. — Coniferous forest stock imported into the United States from Europe is usually shipped in large hampers or baskets, woven by hand from beech, willow, and oak sprouts. They have a capacity of from 20 to 50 cubic feet and are strong, light, and durable. When available, there is no better receptacle for long and delayed shipments of nursery stock. In filling the baskets, a quantity of damp moss is placed on the bottom and a cylindrical column of wood or twisted hay set upright in the center. The bundles of plants are arranged in layers around this column with the roots toward the center and the tops in contact with the circumference of the basket. Damp moss is placed between the layers of roots. After the basket is filled, the plants are pressed down and a thick layer of damp moss placed over the roots. Burlap is drawn over them and tied to the sides of the basket. The cover is brought down and tied in place, after which the plants are ready for shipment.

Pettis has practiced the following method in the annual distribution of millions of trees from the Adirondack nurseries to various parts of the State of New York. Large, covered hampers or baskets are taken to the nursery and the stock as lifted is packed in them with the roots turned toward the center of the basket. When the basket is filled the cover is tied down. After drenching with water it is ready for shipment (Fig. 99).



Photograph by C. R. Pettis

FIG. 99. — Shipping baskets for coniferous stock.

11. Packing in Wire Crates. — Neuhaus¹ advocates the use of packages made from wide-meshed wire netting for shipping coniferous seedlings and small transplants. Such packages are inexpensive, durable, light, and easily handled. Willow baskets and boxes are considered best for export and long transport, but for ordinary transport when the stock is not more than a week in transport wire crates are equally useful. The ordinary inch-mesh galvanized wire netting, $1\frac{1}{2}$ or 2 feet wide, should be purchased in rolls and cut in lengths determined by the diameter of the bundles of trees. The netting is covered with fine balsam or hemlock twigs upon which is spread a layer of damp moss where the roots come. The bundles of seedlings or transplants are placed upon the moss with the roots overlapping and the tops outward in either direction. A stick 8 inches longer than the width of the netting is fastened along either side by weaving it in and out through the mesh. The two sticks are brought together and securely tied. The bundle when tied is cylindrical in shape and as long as the width of the netting. When properly packed the roots are well protected and the tops are freely exposed to the air. From 1000 to 5000 plants can be packed in a single bundle. Care should be taken that the

¹ Neuhaus, K.: Neue Verpackungsmethode für Pflanzen. (Schweizerische Zeitschrift für Forstwesen, S. 195. 1912.)

wire is drawn tightly about the plants and that the covering over the moss protects it from the rapid loss of moisture through evaporation.

During the past few years an increasing number of forest nurseries in the United States are shipping coniferous seedlings and small transplants in wire cases or crates (Fig. 100). These are usually made of $\frac{1}{4}$ - to $\frac{1}{2}$ -inch-mesh galvanized wire and are cylindrical in form with closed ends, one of which is removable to permit packing. They are made in various sizes but most com-



Photograph by U. S. Forest Service

FIG. 100. — Unpacking and heeling-in coniferous nursery stock on its receipt in wire shipping crates. Pike National Forest, Colorado.

monly are $2\frac{1}{2}$ feet in diameter and $1\frac{1}{2}$ feet deep, or 2 feet in diameter and 2 feet deep and hold from 5000 to 20,000 2-year coniferous seedlings.

Due to its small size coniferous stock suitable for forest planting should be shipped by express. The added cost per thousand over freight shipment is more than balanced by the shorter time in transit and the less danger of injury. Shipments are liable to be delayed even under the best facilities for transport, hence close supervision should be given to packing and shipping. Each package should be marked "Live plants, prompt delivery necessary."

12. THE WEIGHT OF NURSERY STOCK USED IN FOREST PLANTING

The weight of the various classes of stock useful in forest planting varies between wide limits. The shipping weight depends upon the method of packing as well as the net weight of the plants. The average net weight and the average shipping weight of 1000 plants of the various classes grown at New Haven, Conn., under average conditions of spacing and soil fertility are shown in the following table.

| Species. | Net weight in pounds. | Shipping weight in pounds. |
|--------------------------|-----------------------|----------------------------|
| White pine (1-0)..... | 0.68 | 2.36 |
| White pine (2-0)..... | 4.58 | 12.34 |
| White pine (3-0)..... | 26.80 | 45.36 |
| White pine (1-2)..... | 29.76 | 54.20 |
| White pine (2-1)..... | 21.42 | 40.76 |
| Red pine (2-0)..... | 4.16 | 10.94 |
| Red pine (2-1)..... | 20.42 | 39.86 |
| Scotch pine (1-0)..... | 1.94 | 6.26 |
| Scotch pine (2-0)..... | 9.64 | 22.36 |
| Scotch pine (2-1)..... | 54.80 | 70.25 |
| Yellow pine (2-0)..... | 8.36 | 19.26 |
| Yellow pine (1-1)..... | 7.08 | 15.64 |
| Yellow pine (2-1)..... | 36.20 | 54.24 |
| Norway spruce (2-0)..... | 3.74 | 7.54 |
| Norway spruce (2-2)..... | 68.40 | 84.75 |
| Red oak (1-0)..... | | 32.25 |
| Red oak (2-0)..... | | 64.20 |
| Beech (1-0)..... | | 17.54 |
| Beech (2-0)..... | | 48.40 |
| White ash (1-0)..... | | 7.76 |
| White ash (2-0)..... | | 31.40 |

13. TREATMENT OF NURSERY STOCK ON ITS RECEIPT FROM THE SHIPPER

Nursery stock should be unpacked as soon as it is received from the shipper and planted at once or else heeled-in until required. If it has been but a few days in transit and is well packed, *puddling is not necessary and usually does more harm than good.* When it has been several weeks in transit, the roots are often over-dry. As the stock is unpacked the bundles should be opened and the roots thoroughly puddled. It should ordinarily be heeled-in at the most convenient place on the planting site where the soil is deep, free from obstructions, and friable.

When stock is handled in exceptionally dry weather it is usually

advisable to moisten the roots of coniferous plants during the process of sorting and tying in bundles. The counting and sorting table at the Pocatello nursery has a sloping top with a shallow trough at the lower edge which contains water into which the roots are dipped as the plants are counted and tied in bundles. *If the plants have been a week or longer in transit, particularly if the roots appear even slightly dry, they should be puddled as soon as they are unpacked and the bundles opened.*

Puddling consists in dipping the roots into a mixture of clay and water of the consistency of paint. Usually a hole is excavated in the soil at a convenient place and clay or clay-loam thrown into it and thoroughly mixed with water. The plants are taken a bundle at a time, the string loosened or removed, and the roots submerged in the puddle. Care should be taken that all the roots are completely coated with the mud.

CHAPTER XV

THE FOREST NURSERY (*Continued*)

1. The Overcoming of Stock Losses from Preventable Causes

SUCCESSFUL nursery practice demands fully stocked seedbeds and transplant beds. Some losses in the seedbeds after germination should be expected due to the elimination of weak individuals. When fresh seed of high quality is sown it should not exceed 5 to 10 per cent. Losses in the transplant bed should be expected also. These minor losses due to various causes are of little moment and should be provided for in the seeding. Excessive losses due to preventable causes require special consideration. Such losses are liable to occur in any nursery where provision is not made for eliminating the cause or for checking the damage as the loss begins. They relate to:

- a. The loss of viable seed between the time of sowing and complete germination.
- b. The loss of plants in the seedbeds and transplant beds.

2. THE LOSS OF GERMINABLE SEED

Aside from the sowing of adequate seed of high quality under conditions which afford the best environment for germination, the fullness and evenness of the stand at the start depend chiefly upon the percentage of loss in viable seed after sowing and before germination takes place. This loss is due almost entirely to seed-eating rodents. Squirrels, chipmunks, gophers, and various species of mice are usually very destructive when abundant in the vicinity of the nursery unless efficient protective measures are in effect. The damage by rodents is almost entirely confined to the period preceding germination, during which time the seeds are dug up and destroyed, although large seeds such as chestnut and oak are often destroyed by squirrels several weeks after germination starts. Squirrels and chipmunks work in the day-

time, usually early in the morning or late in the afternoon. Mice are strictly nocturnal in their feeding habits. When the seedbeds are sown in the spring the period of damage is seldom longer than from 3 to 6 weeks. If germination is irregular and some of the viable seeds are slow to germinate, the damage may continue all summer and is not confined to the loss of seed but also includes the loss of young seedlings destroyed in digging up the seed. Autumn-sown seedbeds are subjected to a much longer period of damage. The beds in rodent-infested regions should be closely watched for evidences of damage, which are usually most apparent in the early morning. The degree of damage is expressed by the number of fresh holes in the seedbeds and by the quantity of seed-coverings scattered over the surface. Whenever evidences of damage appear measures should be immediately taken to prevent serious losses.

All measures undertaken in forest nurseries to prevent the destruction of seed by rodents relate to the following:

a. Measures taken to prevent the rodents from reaching the seedbeds.

b. Measures taken to destroy the rodents.

The first effort in control should be directed toward keeping the nursery and its surroundings free from rubbish and other material that may afford nesting places and retreats for rodents. Rodents have been effectively excluded from many nurseries by screening against them. Thus, at the Pocatello nursery the lath house in which the seedbeds are formed is enclosed by closely-woven wire screens about 2 feet high and partially embedded in the soil. The ordinary seedbed box provides an effective barrier against squirrels and chipmunks.

When rodents occur in destructive numbers in large nurseries the damage can usually be greatly reduced or entirely eliminated by systematic methods of destruction. When once destroyed over the nursery and adjacent areas they seldom become troublesome in later years. They are most effectively reduced by systematic trapping or poisoning. The same methods should be used in the nursery that are practiced in freeing a site from rodents preliminary to direct seeding.

Moles are troublesome in many nurseries, due to the numerous tunnels made by them and the drying out of the soil above the tunnels. The benefit derived, however, is often more than the

harm done, due to the large number of white grubs and other insects destroyed. When overabundant they are most effectively reduced by trapping.

3. THE LOSS OF PLANTS

The death of young trees in the seedbeds and transplant beds is usually due to one or more of the following causes:

- a. Adverse weather conditions.
- b. Birds.
- c. Injurious insects.
- d. Parasitic fungi.

4. Protecting the Nursery from Injury Caused by Adverse Weather Conditions.—Losses due to adverse weather conditions are accompanied by marked physiological disturbances in the activities of the plants. The trees turn brown and die, in whole or in part, without a definite symptom to indicate the cause. This condition is known as blight.¹ Losses caused by blight are often excessive, not infrequently the entire stock of one or more species being completely destroyed. The more common and destructive forms of these physiological troubles are *sun scorch*, *winter killing*, *frost damage*, and *root rot*.

Sun scorch is due to a lack of balance between the water absorption by the roots and transpiration from the foliage during the growing season. *It is most likely to occur in dense stands of 2-year seedlings in midsummer when the ground is the driest and the loss of moisture through transpiration the greatest.* In serious cases of sun scorch the trees are killed outright, usually in large patches through the middle of the beds. In less serious cases only the terminal bud and the leaves are affected. The leaves rapidly lose their green color, become straw-colored and finally deep brown. Sun scorch is sometimes very harmful in transplant beds of conifers after they have begun their growth. If weather conditions cause excessive water loss which the roots cannot supply, the browning of the foliage occurs and the plants die. The loss in transplant beds, however, does not occur in distinct patches as in the seedbeds. The trouble is most common on very light, sandy soils which during droughts are quickly reduced to a low water content. *Sun scorch is entirely prevented by the thorough watering*

¹ Hartley, C.: The blights of coniferous nursery stock. (U. S. Dept. of Agr., Bul. 44. 1913.)

of the beds during dry periods. Dense stands of seedlings exhaust the soil moisture very rapidly; hence, close watch must be kept over the seedbeds during dry periods, and if the soil about the roots of the seedlings becomes overdry a thorough moistening to the depth of root penetration is essential.

Winter killing is the death of the whole or part of the plant as a result of the top drying when the soil and roots are frozen. The water given off by the top cannot be replaced by absorption from the soil. Sudden periods of warm weather in the midst of cold winter weather cause the most damage. Trees affected by winter killing in the seedbeds and transplant beds have the same general appearance as those affected by sun scorch. The damage is greatest during winters with low temperature and little snow. It can be prevented by protecting the nursery by windbreaks and by mulching the beds during the winter.

Winter molding or mulch injury sometimes results from a heavy fall of snow which remains over the beds until late in the spring, or from a heavy mulch of leaves or other material which packs down over the seedlings and is not removed sufficiently early. *The damage appears to be due to the plants not being exposed to the sun and air early in the spring rather than to the character and quantity of covering during midwinter.* In regions of heavy snowfall when the snow comes early and lasts until late in the spring the artificial mulching of nursery beds is unnecessary; the snow is a good mulch in itself. When a heavy mulch of leaves or like material is applied and is followed by a heavy fall of snow which continues throughout the winter and early spring, there is almost always considerable loss from molding. No more mulch should be used than necessary to provide protection from the sun and only loose, light material should be used. It should be removed during the first warm days of spring. When winter molding or mulch injury has occurred in coniferous seedbeds the leaves turn brown and fall from the plants soon after they are uncovered. The terminal bud is almost always severely injured or destroyed. Even in cases where all the leaves are killed the roots remain healthy.

Ebermeyer¹ describes a blight which sometimes occurs in coniferous nurseries due to a sudden period of warm weather in early

¹ Ebermeyer, E. W. F.: Die physikalischen Einwirkungen des Waldes auf Luft und Boden. S. 251. Aschaffenburg, 1873.

spring when the soil is cold and the roots unable to supply the transpiration losses. It is most liable to occur on heavy, cold, overwet soils and can be prevented by shading the beds in early spring.

Frost damage is due to the formation of ice crystals in unripened tissues while the vital processes are still active in the cells. It is usually confined to the part of the plant above ground although the early autumn freezing of the soil may injure growing roots. When seedbeds are sown in late spring or early summer the resulting plants are later in maturing their wood and they are likely to be severely injured by early autumn frosts. When seedbeds are sown in the autumn and the seeding is followed by a period of warm weather, germination takes place and the seedlings are destroyed or severely injured by freezing. In the latter case mulching or shading will not protect the young plants from injury. *The damage can be avoided by delaying the seeding until all danger of autumn germination is past.* Species like white pine, jack pine, and Douglas fir that start their growth early are often severely injured by late spring frosts. The terminal buds and young shoots are destroyed if severe frosts occur after growth begins. The simplest method to prevent injury in localities where late frosts are likely to occur is the holding back of early growth by shading the beds. When there is likelihood of a killing frost during the growing season the beds can be protected by covering them with hay, straw, or other light material. Where there is an abundant water supply and the slope of the ground permits, frost damage can be prevented by flooding.

The excessive use of water during the early growing season, particularly on heavy soil, often causes the roots to rot and the tops of coniferous stock to turn yellow. After the damage appears, the stock seldom recovers but quickly turns brown and dies. This loss which is often excessive can be entirely avoided by the proper regulation of the water supply. It seldom occurs except in nurseries under irrigation.

5. Protecting the Nursery from Injury by Birds.—Birds are seldom harmful in the forest nursery until germination takes place. They seldom dig up the seed if it is well covered. Many species are highly beneficial due to the harmful insects that they destroy. They are chiefly destructive to conifers and small-seeded, broad-leaved species that raise the seeds above the ground as they germi-

nate. Many birds nip off the tops of the young trees and destroy them while the seed is still attached. Damage by birds is confined to a period of from 2 to 4 weeks immediately following germination. When the last of the seed coats is cast the danger is over.

The mourning dove, junco, bluejay, Canadian jay, blue-headed grosbeak, and redpoll linnnet are particularly harmful in many western nurseries. The English sparrow, blackbird, robin, and finch are often harmful in forest nurseries in New England and the Lake States.

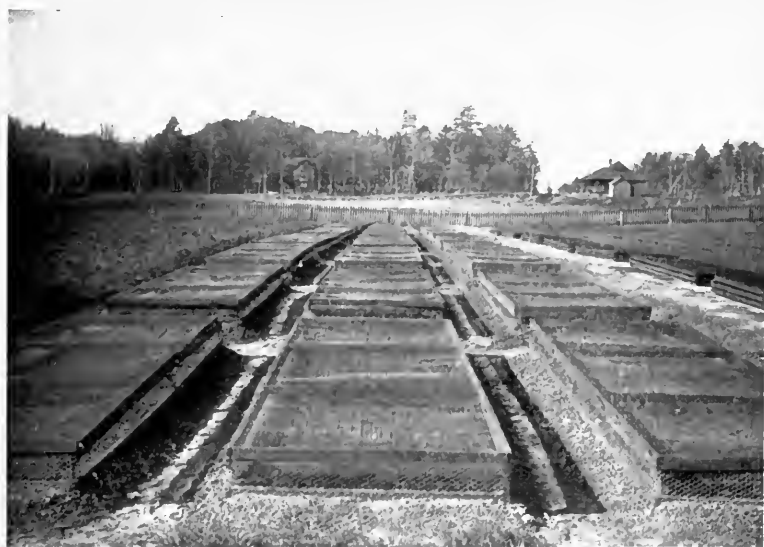

FIG. 101. — Standard seedbed boxes with wire tops and sides which effectively protect the beds from birds.

The most effective method of protecting seedbeds from birds is by covering them with wire netting (Fig. 101). Coating the seed with red lead prior to seeding is usually effective in protecting the seed and young plants from finches, sparrows, and most other injurious birds. The lead is distasteful to the birds and does not injure the seed. Sufficient water is applied to thoroughly moisten the surface of each kernel. Enough red lead is then stirred in to color the seed. One pound will coat from 6 to 10 pounds of seed. Watching the seedbeds and driving the birds off as they

appear can be economically practiced in large nurseries and is often preferred to other methods. The scattering of poisoned bait along the borders and over the seedbeds is practiced in some forest nurseries in western United States. Although usually effective it should not be practiced as it causes the destruction of large numbers of birds highly useful in destroying harmful insects. *Insect-eating birds should be protected and their presence in the nursery encouraged by erecting suitable places in which to nest and rear their young* (Fig. 102).

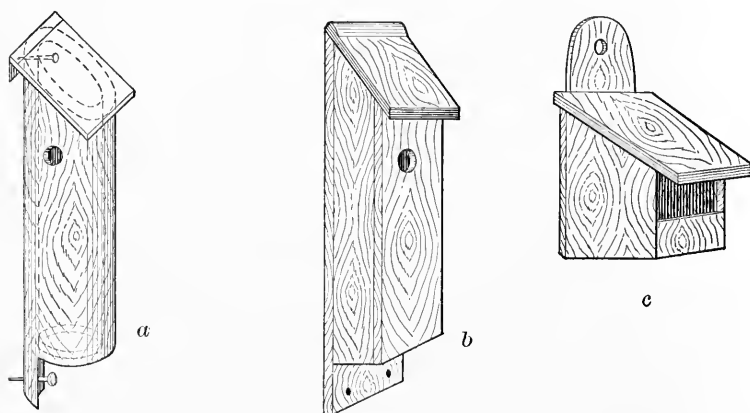

FIG. 102.—Types of nesting boxes useful for placing in and about the forest nursery.

If precautionary measures are taken to protect the seedbeds for a few weeks immediately following germination, the greater the number of birds in and about the nursery the safer it is from insect depredation. Bird houses differ greatly in their construction. Some birds are satisfied with almost any sort of lodging, while others are more exacting. In general, wood is the best building material. A porch at the entrance is unnecessary. Dearborn¹ gives the following as suitable dimensions of nesting boxes for various species of birds.

¹ Dearborn, Ned: Bird houses and how to build them. (U. S. Dept. of Agr., Farmers' Bul. 609. 1914.)

| Species. | Floor of cavity. | Depth of cavity. | Entrance above floor. | Diameter of entrance. | Height above ground. |
|-------------------------|------------------|------------------|-----------------------|-----------------------|----------------------|
| | Inches. | Inches. | Inches. | Inches. | Feet. |
| Bluebird..... | 5×5 | 8 | 6 | 1½ | 5-10 |
| Robin..... | 6×8 | 8 | * | * | 6-15 |
| Chickadee..... | 4×4 | 8-10 | 8 | 1½ | 6-15 |
| White-breasted nuthatch | 4×4 | 8-10 | 8 | 1½ | 12-20 |
| Dipper..... | 6×6 | 6 | 1 | 3 | 1- 3 |
| Tree swallow..... | 5×5 | 6 | 1-6 | 1½ | 10-15 |
| Martin..... | 6×6 | 6 | 1 | 2½ | 15-20 |
| Phoebe..... | 6×6 | 6 | * | * | 8-12 |
| Crested flycatcher..... | 6×6 | 8-10 | 8 | 2 | 8-20 |
| Flicker..... | 7×7 | 16-18 | 16 | 2½ | 6-20 |
| Red-headed woodpecker. | 6×6 | 12-15 | 12 | 2 | 12-20 |
| Downy woodpecker..... | 4×4 | 8-10 | 8 | 1¼ | 6-20 |

* One or more sides open.

6. Protecting the Nursery from Injury by Insects.—A large variety of insects infest nursery soil and feed upon the roots of the growing trees, while many others feed upon the tender branches and foliage. Only those species are mentioned which occur more or less frequently in forest nurseries in large numbers and cause serious damage. It is the duty of the forester to watch his seedbeds and transplant beds for evidences of insect injury. As soon as harmful insects appear they should be destroyed. Prompt action is usually essential.

Annihilative measures should vary somewhat in each case depending upon the habits of the insect concerned, the kind of trees and the season. The life history of the insect determines at what stage in its development its destruction can be accomplished.

Leaf-eating insects are easily destroyed by spraying the trees with arsenate of lead used in the proportion of 1 pound of the chemical to 12½ gallons of water. The arsenate should contain at least 14 per cent of arsenic oxide and not more than 50 per cent of water. When used in the above proportion it will not harm the tenderest foliage even when applied in midsummer. Grasshoppers have been successfully combated at the Page nursery by applying a mixture of Paris green in moist bran. A mixture of Paris green, manure, salt, and water, known as the *Criddle* mixture has been successfully used against grasshoppers at other nurseries. The seedbeds can be protected against them by using screens with ⅛- to ¼-inch-mesh.

The larvæ of moths sometimes injure the buds of pine and other

species and cannot be reached by ordinary methods of poisoning. The pine moth (*Retina frustrata*) has seriously injured yellow pine in some nurseries in western United States but no effective remedy is yet known.

Insects which injure the plants by sucking the sap from the leaves or bark cannot be destroyed by ordinary methods of poisoning. A material which acts externally on the bodies of the insects must be used. The standard materials for this purpose are kerosene emulsion, soap and water, and tobacco extract. The pine bark aphid (*Chermes pinicorticis*), often found in forest nurseries infesting white pine, is one of the most destructive of this class of nursery pests. It can be effectively controlled by spraying with kerosene emulsion.

The common red spider (*Tetranychus bimaculatus*) often causes considerable damage in forest nurseries in the United States, particularly in the eastern states. Under favorable conditions this pest infests nearly all kinds of nursery stock, but is particularly harmful in 2-year coniferous seedbeds. The insect is minute and, when present in ordinary numbers, usually escapes notice. When present in large numbers the leaves turn yellow and have an unhealthy appearance. Close inspection of the plants with a pocket lens shows these "spinning mites" as minute red specks on the leaves and twigs. They injure the plants by piercing the epidermis and feeding on the sap.

Serious injury from this insect seldom occurs except during dry weather in late summer or autumn. When not overabundant it can usually be held in check by drenching the beds with water at frequent intervals. The water should be sprayed against the plants with considerable force. Chittenden¹ recommends the following methods of control for the red spider.

a. Flowers of sulphur, mixed with water at the rate of an ounce to a gallon, and sprayed over the infested plants.

b. Potash, fish oil, whale oil, and other soap solutions at the rate of 1 pound to 20 or 30 gallons of water sprayed over the infested plants.

c. A kerosene-soap emulsion prepared by combining 2 gallons of kerosene and $\frac{1}{2}$ pound of whale oil soap with 1 gallon of water. The emulsion diluted with 10 parts of water is sprayed on the infested plants.

¹ Chittenden, F. H.: The common red spider. (U. S. Dept. of Agriculture, Bureau of Entomology, Cir. 104 1909.)

Sulphur, when used on coniferous seedbeds in New England, has resulted in rather serious harm to the plants. Kerosene-soap emulsion has also caused some injury. The best results have been obtained with a nicotine product, a commercial preparation known under the name "Black leaf 40." One pound of the preparation will make from 160 to 400 gallons of spraying solution. From 3 to 4 pounds of good laundry soap or whale oil soap should be added for each 100 gallons of the solution.

Among insects which infest the soil those most harmful to nursery stock are the common white grubs, *viz.*, the larvæ of a number of species of *Lachnosterna* usually known as May beetles. The species of *Lachnosterna* are widely distributed over the United States and some species are present in nearly all nurseries. The species most injurious in the New England states are: *L. crenulata*, Forst.; *L. fusca*, Froh.; *L. fraterna*, Harris; *L. hirticula*, Knoch.; and *L. nova*, Smith.

The adult beetles feed chiefly on broadleaved trees. The large, white larvæ live in the ground and feed upon the roots of various plants. They often occur in great numbers, are ravenous feeders and require several years for full development. They are particularly abundant on areas covered with sod or weeds. When such areas are plowed and seedbeds or transplant beds immediately formed the insects transfer their damage from the roots of the grass and weeds to the young trees and do a vast amount of damage. The usually light, porous soil of seedbeds affords special attraction to the female beetle when laying her eggs. The damage to forest nurseries in the United States has been confined chiefly to transplant beds where the soil has not been thoroughly tilled for a year before the formation of the beds. The evidence of damage is shown by the young plants turning yellow and finally dying as the roots are eaten off. If close watch is kept of infested beds and the plants dug up as soon as the first evidence of injury is apparent, the larvæ are usually found close to the destroyed roots. This method of destroying the pest is the one usually practiced in forest nurseries in the United States. It is expensive and only partially successful.

Nurseries surrounded by stands of hardwood trees are particularly subject to damage by the larvæ of May beetles as the adult insects feed upon the foliage and swarm over the adjacent nursery beds at the time the eggs are deposited in the soft soil.

So far as possible all larvæ should be destroyed in working the soil in the formation of the beds. If the nursery is free from the larvæ they can be prevented from entry by surrounding the beds with a trench. Starlings and other birds that feed upon the grubs should be encouraged by hanging up nesting boxes around the nursery.

Although measures for exterminating the grubs must be undertaken when evidences of damage are first discovered, the most effective and least expensive methods for preventing loss are cultural. Nursery beds are rarely seriously infested when the soil has been free from vegetation for several months prior to their formation. *When sod or a heavy growth of weeds is plowed under, potatoes or other cultivated farm or garden crops should be grown for at least a season before the formation of the nursery beds.*

7. Protecting the Nursery from Injury by Parasitic Fungi. —

Various diseases due to parasitic fungi cause more or less serious damage in forest nurseries. The most serious of these diseases in the United States are *damping-off* and *blister rust*. Graves¹ calls attention to the injury of coniferous seedlings in nurseries at Baltimore, N. C., by *Ascochyta piniperda*. Layerberg records a serious disease of various species of forest nursery stock in Europe believed to be caused by *Pestalozzia hartwigii*. It results in the death of the cortex just above the ground and completely girdles the trees. Hartley² records this or a similar disease under the name *stem girdle* as appearing on the stems of 2- and 3-year conifers in the United States. It attacks the plant just above the ground and causes the death of the cambium. The stem is constricted at the point of injury but abnormally large just above it. The trees usually die the second year after the injury becomes apparent. It has appeared in western nurseries on Scotch pine, yellow pine, white fir, Douglas fir, and Norway spruce. The author has observed this or a similar disease on white pine in various places in New England, chiefly, however, in plantations and natural stands on trees from 6 inches to 3 feet or more in height.³

¹ Graves, A. H.: Notes on diseases of trees in the southern Appalachians. (Phytopathology, vol. IV, p. 63. 1914.)

² Hartley, C.: The blights of coniferous nursery stock. (U. S. Dept. of Agri., Bul. 44. 1913.)

³ This disease of white pine in New England appears to be associated with a large mound-building ant *Formica exsectoides*. Groups of diseased trees are usually confined to the vicinity of the mounds formed by these ants.

The disease spreads slowly and seldom does serious damage in the United States. Whenever it appears, however, the infested trees should be promptly pulled up and destroyed. It usually appears over areas from a few feet up to several yards in extent often killing every tree in the infested area.

Needle-cast caused by *Lophodermium pinastri*, although one of the most serious diseases in European nurseries, has not as yet been introduced into the United States. In Germany it is known under the name "Schütte" and is recognized as the commonest cause of the blight of pines both in the forest nursery and in the plantation. Its presence is first made known by the reddening of a few isolated needles in the early autumn which turn brown, develop fruiting bodies of the fungus, and fall from the tree before winter. It progresses rapidly the following spring and often destroys all foliage by the latter part of May. It is believed by Hartley and others to be almost certain to cause trouble in forest nurseries in the United States in the future. The disease is controlled in Germany and elsewhere in Europe by spraying with Bordeaux mixture in midsummer.¹

8. DAMPING-OFF.—Damping-off is a general term applied to the destruction of young plants by parasitic fungi immediately after germination. It is a serious hindrance to raising most conifers and small-seeded broadleaved species. The disease is generally the most destructive under moist conditions, particularly when the air is hot and humid. It is caused by species of *Pythium*, *Rhizoctonia*, *Fusarium*, and possibly *Trichoderma*.²

Pythium debaryanum and various species of *Fusarium* appear to be the most destructive damping-off fungi in western nurseries. A number of species of *Fusarium* have been very destructive in the New York state nurseries, in the Vermont state nurseries, and in some private forest nurseries in eastern United States.³ Hartig⁴ records the same or similar fungi as very destructive to pine and spruce seedlings in Germany.

¹ Stumpff, K.: Die Schütte und ihre Bekämpfung. (Zeitschrift für Forst- und Jagdwesen, S. 675-687. 1900.)

² Spaulding, Perley: Damping off of coniferous seedlings. (Phytopathology, vol. IV, p. 73. 1914.)

³ Gifford, C. M.: The damping-off of coniferous seedlings. (Vermont Agri. Exp. Sta., Bul. 157, p. 147. 1911.)

⁴ Hartig, R.: Ein neuer Keimlingspilz. (Forstlich-naturwissenschaftliche Zeitschrift, S. 432-436. 1892.)

Damping-off is a universal trouble in seedbeds of all kinds. There is no positive means of control which will invariably and under all conditions check the disease after it has become fully established. It is especially difficult to check in coniferous seedbeds because the plants are so close together that the disease quickly spreads from one to another. Furthermore, weather conditions which aggravate the disease cannot be overcome in the open air. The disease sometimes kills the seedlings before they are above ground. More often it first appears a few days after they are up and continues for several weeks or while the stems are soft and succulent. The trouble usually ceases after the stems become woody. The fungus present in the soil makes its way through the epidermis into the tender stems of the seedlings at the surface of the soil or in the roots immediately below the surface. It first appears on the stem as a small watery spot. It develops rapidly and in a day or two so weakens the plant that it usually falls over and soon withers and dies. If weather conditions are unfavorable all the seedlings may be destroyed within a week after germinating. Usually, however, some survive in patches over the seedbeds. Under more favorable weather conditions only a few plants here and there become diseased.

Damping-off fungi are nearly always present in ordinary nursery soils. The various methods practiced to prevent or overcome injury relate to the following:

- a. Partial or complete sterilization of the soil prior to seeding.
- b. Attaining conditions in the seedbeds inimical to the rapid development of the fungi.

Steam sterilization by the inverted pan method by which the soil in the seedbeds is subjected to steam under pressure for several hours was tested by Gifford and found only partially effective, as the soil becomes rapidly reinfested after heating. Gifford¹ secured excellent results by disinfecting the beds with formalin several days before sowing the seed. The solution used was 1 part commercial formalin (40 per cent formaldehyde gas in water) and 100 to 200 parts water. It was applied at the rate of 1½ gallons per square foot of seedbed. Formalin will often kill the seed if applied at the time of seeding. When applied several days prior to seeding repeated experiments have shown no perceptible injury.

¹ Gifford, C. M.: The damping-off of coniferous seedlings. (Vermont Agri. Exp. Sta., Bul. 157, p. 156. 1911.)

Spaulding obtained excellent results by treating the beds with formalin before seeding. He has also successfully used zinc chloride and copper sulphate on alkaline soils. He has also found sulphuric acid an excellent general disinfectant against damping-off fungi when used with adequate precautions. All of these fungicides appear to leave a residue in the soil which protects against reinfection.

In the sulphuric acid treatment the seedbeds are thoroughly soaked with the chemical, applying it at the rate of $\frac{3}{16}$ ounce per square foot of seedbed in from 300 to 500 times the volume of water depending upon the character of the soil. Strongly alkaline soils require more disinfectant per square foot than acid soils. Soils subject to rapid drying in the surface layers should receive much less than soils that remain moist. *Sulphuric acid seriously injures the germinating seedlings when it is permitted to become concentrated through the drying of the surface soil during the period of germination.* Hartley recommends its use only when the nurseryman knows how to recognize and prevent injury. As the injury is always due to the concentration of the acid in the surface soil consequent to capillary action and evaporation, it can be prevented by keeping the beds uniformly moist during germination and for a period of 3 to 6 weeks following. The serious injury or destruction of the plants by sulphuric acid when the soil moisture is not under perfect control is so certain that the author recommends the formalin treatment as a more practical and safer method of preventing damping-off by soil sterilization.

Attaining conditions in the seedbed by cultural methods inimical to the rapid development of damping-off fungi is often more practical and less expensive than the sterilization of the soil by heat or chemicals. The sowing of the seedbeds in the autumn or early spring is usually much less favorable to the development of damping-off fungi than sowing in late spring or early summer. Intelligent control of irrigation and shading greatly reduces the loss from damping-off. The beds should not be kept overwet and the shade cover should be removed at night and during cloudy weather, particularly if the weather is warm and moist. The quality of the seed has a marked influence on the disease. Poor seed is more irregular in germination and produces seedlings of weak vitality. Hence, the seedbeds are subject to injury for a longer period and the plants are much less resistant.

The writer for several years has had uniform success in preventing loss from damping-off in spring-sown seedbeds by practicing the following cultural method. After the seed is sown a deep hole is excavated near the seedbeds and the subsoil from a depth of two or more feet beneath the surface is used for covering the seed. Pettis has used this method with success in the large New York State nurseries. The author believes the above is the most practical cultural method for controlling the disease.

9. BLISTER RUST. — Several species of blister rust infest various pines in the United States. They occur on the pine, however, in but one stage of their development, namely, the *Peridermium* stage. They cause the greatest amount of damage to young trees in nurseries and plantations, often killing them in large numbers. Older trees are rarely killed outright as infection is confined to the smaller branches and twigs. Nursery stock is usually infected on the stem near the ground. Infection may occur when the trees are but one or two years old. It enters through the bark and is usually slow in developing. Usually one or more years intervene after infection before evidence of the disease shows on the surface of the bark. During this period the infested stock is often shipped from nurseries without the shipper or the recipient really knowing of its presence. This condition of slow early development in the host makes the disease a very difficult one to eliminate when shipments are permitted from infected nurseries. The disease first makes its presence known by a perceptible swelling of the stem due to the thickening of the diseased bark. The swelling proceeds rapidly and the following spring the fruiting bodies burst through the bark setting free a multitude of yellow dust-like spores. If badly diseased stock is shipped at this time clouds of spores arise from the plants as they are unpacked. The disease is nearly always fatal to young plants¹ as the infection on the stem gradually spreads until the tree is completely girdled.

Blister rusts indigenous to the United States have been found on yellow pine, jack pine, and pitch pine nursery stock in New England and to some extent on yellow pine in the West. The great danger, however, from excessive losses in forest nurseries in the United States from blister rust is due to the white pine

¹ Spaulding, Perley: The blister rust of white pine. (U. S. Bur. Pl. Ind., Bul. 2 6, p. 16. 1911.)

blister rust introduced from Europe. This is a disease of the white pine and a number of allied species. Although long known in Europe as one of the most destructive nursery pests, it did not appear in the United States until 1906.¹ Since then it has been investigated by Stewart, Spaulding, Clinton, and others. Although first recognized in this country in 1906, it is now widely distributed. The uredo stage which occurs on various species of *Ribes* has been reported from such widely separated localities as Kansas and Vermont. It has been found in a number of localities in Connecticut, Massachusetts, and New York. Spaulding² has recently reported the disease as infesting the crown of a large white pine in Vermont. As yet it has appeared in forest nurseries in the United States only on stock imported from Europe. It is now, however, so widely distributed that it is believed to be but a matter of time before it will be found infesting nursery stock grown in this country. Its possibilities for causing enormous losses are so great that close watch should be kept in all nurseries that grow white pine and allied species in order to prevent its gaining a foothold. Wild and cultivated species of *Ribes* in the vicinity of the nursery which harbor the uredo form of the fungus should be destroyed. If the disease appears in the seedbeds or transplant beds, all the stock should be pulled up and destroyed. There is no known method of treatment which will save a young tree when once infected.

¹ Stewart, F. C.: An outbreak of the European currant rust (*Cronartium ribicola*). (N. Y. Agri. Exp. Sta., Tech. Bul. 2, p. 61. Geneva, 1906.)

² Spaulding, Perley: New facts concerning the white pine blister rust. (U. S. Dept. of Agri., Bul. 116, p. 2. 1914.)

CHAPTER XVI

ESTABLISHING FORESTS BY PLANTING

1. HISTORICAL

A LARGE number of factors influence the degree of success in all planting operations. The more adverse the climatic and soil conditions the more careful the planter must be in every operation from the protection of the site to the establishment of the plantation.

Planting early becomes an established part of forest practice in the development of forestry in every country. At first the planting stock is taken from existing woods, but later it becomes more and more the practice to grow it in forest nurseries.

Planting really began in the United States more than a century and a half ago.¹ Between 1740 and 1750 an experiment in growing oak for ship timbers was made at Pembroke, Mass. In 1819, Mr. Russell of Chelmsford, Mass., planted pitch pine collected from existing woods on light, sandy soil too poor for agriculture. In 1820, Mr. Allen of Smithfield, R. I., seeded and planted 40 acres with chestnut, oak, hickory, and locust. Between 1846 and 1850 Richard Fay of Lynn, Mass., seeded and planted 200 acres with oak, ash, maple, white pine, Norway spruce, and European larch. Between 1850 and 1860 Joseph Fay of Woods Hole, Mass., planted 125 acres with white pine, pitch pine, Norway spruce, and European larch.

Although the planting of trees for forestry purposes extends back to the early history of the country, prior to 1890 the greater part of the planting was in the prairie states west of the Mississippi River. The Timber Culture Act was passed by Congress in 1873. This act provided that the title to 160 acres of public land or a proportionate part thereof could be obtained by planting one-fourth of it with forest trees. This act, together with state laws offering a bounty for the planting of forests or exemption

¹ Graves, H. S.: The practice of forestry by private owners. (Yearbook U. S. Dept. of Agr., pp. 415-428. 1899.)

from taxation, stimulated planting in many states. Although much planting was done prior to the repeal of the Timber Culture Act it is only within the past fifteen years, or since the establishment of national and state forests, that planting on a progressive and extensive scale has been under way. The recent rapid increase in planting in the United States is shown in the consumption of nursery-grown planting stock. Between 25 and 35 million trees were planted for forestry purposes during the year 1915.

2. THE PLANTING MATERIAL

The forester must consider the stock that he uses in planting operations from many different standpoints, all of which have more or less bearing upon the cost and the degree of success in the formation of the plantation. In general, these relate to the following:

- a. The origin of the planting material.
- b. The size and age of the planting material.
- c. The source from which the planting material is obtained.
- d. The handling of the planting material.
- e. The pruning of the planting material.

3. The Origin of the Planting Material

Planting material as to origin may be classed as follows:

- A. Complete planting material: Plants with both root and shoot.
 - I. Seed plants: Plants grown direct from seed.
 1. Seedlings: Plants grown from seed without transplanting.
 - a. Wild seedlings: Plants developed on uncultivated soil from the natural fall of seed.
 - b. Cultivated seedlings: Plants developed in cultivated soil from artificially sown seed.
 2. Transplants: Plants that have been reset one or more times.
 - a. Wild transplants: Wild seedlings reset one or more times.
 - b. Cultivated transplants: Cultivated seedlings reset one or more times.

- II. Vegetative plants: Plants grown from vegetative parts of the mother tree.
 - 1. Rooted cuttings: Sections of branches that have been rooted by planting for a time in cultivated soil.
 - 2. Layers: Twigs that have become rooted while still attached to the mother tree but later detached.
 - 3. Suckers: Shoots that arise from adventitious buds on the surface roots of the mother tree and are later detached.
- B. Incomplete planting material: Plants with either root or shoot but not both.
 - 1. Unrooted shoot cuttings: Parts of the branches of the mother tree of various sizes and ages.
 - a. Sections of branches cut from rapidly developed 1- and 2-year wood.
 - b. Larger sections cut from old wood.
 - 2. Root cuttings: Parts of the roots of the mother tree of various sizes and ages.

All species may be grown from seed. Plants grown from seed are usually more thrifty, live to greater age, and on the whole are more desirable than other classes. Incomplete planting material usually is set in the nursery for a year before placing in the permanent plantation.

4. The Size and Age of the Planting Material

An adequate description of planting material should give both the size and age of the stock. It is customary to give the height in inches or feet and the number of years that it has grown both as a seedling and as a transplant. Thus, 10-inch white pine (2-2) is planting stock 10 inches high that has been grown in the seedbed 2 years, in the transplant bed an additional 2 years, and has been transplanted once; 5-inch yellow pine (1-1) is planting stock 5 inches high that has grown one year in the seedbed and an additional year in the transplant bed; 18-inch Scotch pine (2-1-1) is planting stock 1 foot 6 inches high that has grown 2 years in the seedbed and 2 years in the transplant bed, but has been twice transplanted.

The stock used in planting varies in height from a few inches to several feet. Because of the expense involved, stock more

than a foot in height should seldom be used in forest planting. Coniferous species, with the exception of larch and a few rapidly growing cedars, are best suited for planting purposes when from 4 to 10 inches in height. Because of its more rapid juvenile growth the stock of broadleaved species is usually larger.

The chief advantages which result from the use of small stock are as follows:

- a.* It is usually much less expensive.
- b.* The cost of handling and planting is considerably less.
- c.* There is less interruption in growth due to the lifting, transport, and planting of the stock.
- d.* The root system is less liable to injury.

These important advantages are often more than counterbalanced by the following disadvantages:

- a.* It is less able to compete with grass or other vegetation on the planting site.
- b.* It is more likely to die or be severely injured by summer drought, because the roots immediately after planting are not so deeply imbedded in the soil.

In most cases cost limits the size of stock that can be advantageously used in forest planting. The smallest stock that it is safe to plant on each particular site should be used. Small stock should be used in underplanting because of the effect of the overwood in retaining moisture in the surface soil and the relative freedom of the site from grasses and other herbage. On the other hand, large stock should be used on open sites overrun with vegetation or where the surface soil is porous and likely to become overdry during the growing season. Large plants should also be used in filling blanks in plantations already formed, on sites where small and tender plants are liable to be injured by frost and in mixture with another species of more rapid juvenile growth.

The age of the stock, in most instances, varies from 1 to 4 years. With broadleaved species the age is usually 1 or 2 years, while with most conifers it is from 2 to 4 years.¹

¹ One-year seedlings of white pine have been successfully used in underplanting open stands of mixed hardwoods in southern Connecticut. The use of similar stock for planting open fields has invariably resulted in failure. One-year Scotch pine is extensively used in planting operations in Prussia, but only on carefully prepared sites where the vegetation has been removed and the site thoroughly cultivated.

Although as a general rule young stock is preferable for use in silvicultural operations, the age best adapted for use depends primarily upon:

- a. The species.
- b. The site.

There is great variation in different species in the rapidity of juvenile growth. In general, rapidly growing species are ready for planting at an earlier age than slowly growing ones. Thus, catalpa, black cherry, and black locust, unless crowded in the nursery, often become too large for advantageous handling in a single year. On the other hand, hemlock, balsam, and most species of spruce are usually not large enough for planting purposes until 3 or 4 years old.

5. The Source from which the Planting Material is Obtained

The stock used in planting operations may be obtained as follows:

- a. By growing in home nurseries.
- b. By collecting wild stock.
- c. By the purchase of nursery or wild stock.

6. THE ADVANTAGES OF HOME NURSERIES

Where operations are conducted on a large scale the stock should be grown in home nurseries,¹ *i.e.*, in nurseries owned and controlled by the planter. The chief advantages arising from the use of home-grown nursery stock are as follows:

- a. It is available for use when desired.
- b. The danger of deterioration through transport is eliminated.
- c. The size and age of the stock desired can be secured with greater assurance.
- d. When grown on a large scale the cost is usually less.
- e. There is greater assurance that the plants are true to name as the origin of the seed is usually known.
- f. It is usually better adjusted to the climatic and soil conditions of the planting site.
- g. The introduction of harmful insects and serious fungous diseases is eliminated.
- h. It can be better graded to fit the particular requirements of each planting site.
- i. The conditions under which it grew are known.

¹ Reuss, Hermann: Die forstliche Bestandesgründung, S. 95. Berlin, 1907.

When trees are ordered from an outside nursery, if not in stock, they are usually obtained elsewhere and not infrequently are packed and repacked two or more times before they reach the planter. They are often several weeks in transit or in storage. Because of the congestion of spring work in large nurseries the stock often is lifted months before it is shipped and is stored in packing sheds. A serious hindrance to successful planting often arises from the uncertainty in securing the stock from the nursery at the most opportune time for planting, especially when it is shipped for some distance or sent by freight. Even when it reaches the planter on the date agreed upon, weather conditions are often adverse to successful planting. On the other hand, where the stock is grown in home nurseries there is no delay between lifting the plants and setting them out.

When planting operations are conducted on a small scale or when a small amount of stock of a variety of species is required, it is usually more advantageous to collect wild stock or to purchase the trees required from a responsible dealer. The successful and economic production of nursery stock requires special training and experience on the part of the grower. When grown on a small scale by inexperienced workmen the result is uncertain and the cost likely to be excessive.

7. THE USE OF WILD STOCK

In most instances the quality of nursery-grown stock is far superior to that of wild stock. The root system is better developed and the shoot is more "stocky" and vigorous. The buds are better developed and the young plants grow much more vigorously after transplanting. They invariably yield better results under adverse conditions. Wild stock of all species may be used but with varying degrees of success. All species which form a deeply penetrating tap root with few weak lateral roots during early life should not be used as wild stock in planting operations. Even with the greatest care the loss will be excessive. On the other hand, species which develop a diversified root system during their early life, as in the sugar maple, white pine, and red spruce, are more acceptable for use as wild stock.

Not only is wild stock poorly developed but it is uneven in size and quality. When such stock is used many plants are set which should be discarded and, as a consequence, the percentage of loss

is increased. The quality depends largely upon the conditions under which the wild stock developed. When gathered in existing woods it is likely to be dwarfed with a poorly developed root system. When grown in open fields or along roadsides it is usually better developed and far more desirable for planting purposes.

Although wild stock is always inferior to nursery-grown trees, its use, particularly for small plantations, is often permissible due to its low cost. When handled with care and planted on favorable sites, selected wild stock of nearly all species can be used with a fair degree of success. It is often desirable to transplant wild stock in the nursery for a year before planting.

Wild stock should not be depended upon except when it is gathered in the locality where it is required for use. The planter should personally supervise the gathering, discarding all inferior plants. When collected at a distance it usually exhibits great variation in quality and suffers severely because of the time intervening between collecting and setting it in the plantation.

8. THE PURCHASE OF NURSERY AND WILD STOCK

The recent rapid development of forest nurseries in the United States with the resulting competition has brought about an improvement in the quality of the stock placed upon the market and very greatly reduced its cost. Thus, white pine and other species extensively used in planting operations can be purchased from forest nurseries at less than half of what they cost ten years ago. Because of the greater variety and the quantity of stock now grown, the planter is far more certain of securing the particular classes of stock that he desires.

The cost of collecting wild stock varies with the species, its size, relative abundance, and the character of the soil. From 6- to 12-inch hard maple often grows in very dense stands along roadsides and under open stands in the forest. This stock can be collected and tied into bundles at a cost of from 30 to 50 cents per thousand. From 3- to 8-inch white pine can be collected and bundled under exceptionally favorable conditions at a cost of from 50 cents to \$1 per thousand. In localities where wild stock is very scattered and uneven in size it can be gathered and graded into sizes suitable for planting only at large expense, often more than the cost of superior stock from nurseries.

9. IMPORTED FOREST STOCK

Until recent years a large part of the coniferous stock used in silvicultural work in this country was imported from Europe. Owing to the length of time in transit and the danger of importing infected stock, its general use should be discouraged. The recent development of forest nurseries in the United States and the prices at which the better nurseries supply all classes of stock useful in silvicultural practice make the importation of planting stock no longer necessary.

10. The Handling of the Planting Material

Close attention must be given to all classes of stock used in forest planting from the time it is lifted in the nursery or woods until it is finally set in the plantation. Past experience in this country provides ample evidence that far too little attention is given to this important matter.

All kinds of planting material with developed roots are either *balled plants* or *naked-rooted plants*. Balled plants are lifted in the nursery or field with a ball of earth about the roots and are reset in the plantation with the soil attached. Naked-rooted plants are lifted without the soil attached. The former can be handled with the least danger from injury due to exposure and other causes.

11. The Pruning of the Planting Material

A balance between the root system and the part of the plant above the ground is maintained under natural conditions. As a rule, only a part of the root system is secured when plants are lifted in the nursery or as wild stock from existing woods. Many of the smaller roots which constitute a large part of the absorbing surface are broken off and left in the soil. When the trees are planted there is always a more or less serious upsetting of the natural balance between root and shoot. When the root system is excessively reduced without a corresponding reduction of the shoot surface, the plants are likely to suffer during dry periods from the loss of water from the comparatively large shoot surface which cannot be replaced by absorption through the roots. *In general, therefore, the more severely the root system is injured or cut back in lifting the trees, the greater the necessity for pruning the tops before planting.*

Since every cut produces a wound through which the spores of fungi may gain access to the living tissues of the tree, as little pruning should be done as is necessary to maintain a proper balance between root and shoot. In many cases the diseased condition of young stands of timber can be directly traced to injurious fungi gaining access to the trees at the time of planting. Plants should be lifted with the least possible injury to the root system, particularly to the fine rootlets which constitute the chief absorbing surface, as this precaution will usually make the pruning of the top unnecessary. In cases where the trees are lifted with balls of earth about the roots, there is the least disturbance in the natural balance between root and shoot and there is the least necessity for pruning the top.

The chief advantage of nursery-grown stock over wild stock lies in the fact that the former has a better root system and the plants are lifted with much less damage. The pruning of small nursery-grown trees can usually be avoided because with suitable care they can be grown with a compact root system which can be lifted with little injury.

12. CONDITIONS UNDER WHICH PRUNING IS DESIRABLE

Under the following conditions root or shoot pruning is desirable prior to planting:

- a. When for one reason or another there is not a proper proportion between root and shoot.
- b. When certain roots have been severely injured.
- c. When the tap root is unusually long, making planting expensive and inconvenient.
- d. When there is more than one leader.
- e. When there are abnormally developed side roots or side branches, or the trees are otherwise ill-shaped.

It is safer to throw away ill-shaped trees and those with a defective root system than it is to plant them after the necessary pruning and invite the introduction of disease.

13. INJURIES FROM PRUNING

The injury from pruning depends chiefly upon the species and the locality. On the whole, broadleaved species withstand pruning better than conifers. The amount of injury is chiefly dependent upon the degree of exposure to fungous diseases and the rapidity

with which the wounds heal. Most species of evergreen broad-leaved trees have poor recuperative power after injury and consequently suffer severely from pruning, as is the case with rhododendrons and laurels. Among broadleaved species, willows, poplars, oaks, alders, chestnut, mulberries, elms, and maples are fairly resistant to pruning due to their recuperative power after injury. Beech, birch, walnut, cherry, and ash are much less resistant.

Although conifers, as a rule, are slow to recuperate after pruning, there are a number of exceptions. Larch withstands pruning fairly well, while most species of cedar, cypress, and juniper withstand severe pruning without injury. When trees are planted on fertile, moist soil they suffer less from pruning than when planted under more unfavorable conditions.

14. Other Factors which Influence the Quality of the Planting Material

There are a large number of factors in addition to the above which determine the quality of various classes of planting material. Success in planting depends very largely upon the selection of planting material from the standpoint of its vigor and growing power. In the inspection of stock to determine its quality, special attention should be directed toward the relative proportion of root to shoot. *In general, the larger the root system in proportion to the shoot the more vigorous the plant and the greater its growing power.* So also the more compact the root system the better the plant. A plant with a rambling root system and few fibrous roots, as is likely to be the case when grown on sterile, sandy soil, is of poor quality. The chief advantage of transplants over seedling stock of the same size is due to the more compact and fibrous root system of the latter. The shoot should be neither too slender nor too thick. Over-slender plants are weaklings and should never be planted. They usually arise from overcrowding in the nursery or, in the case of wild stock, from excessive shade. Plants that are abnormally short and stout are liable to be diseased and should be discarded. The buds should be well developed and, in the case of coniferous stock, the foliage should be healthy. Plants in which the foliage is dwarfed and yellow should not be used in planting operations.

Freedom of the stock from fungous diseases and insect enemies is also a mark of quality. All stock should be carefully inspected, and under no conditions should non-inspected stock be used in forest planting.

15. THE PLANTING SEASON

Even with the utmost care planting is always accompanied by damage to the root system and the checking of growth for a more or less extended period. The lifting of a plant in the nursery or field, the storing for any length of time, and the final planting are severe checks on its vitality. The greatest danger arises from the root system becoming overdry, either during the period of lifting, storing, or planting or during the first few weeks after planting. The danger from overdrying during and after planting can be best overcome by planting during the most favorable season and by selecting days when the weather conditions are best for field operations. Trees can be lifted and planted with the least danger on damp, overcast days. Ordinarily planting should not be attempted on hot, dry days during high winds, particularly if the soil is dry. It is far safer to hold the stock in storage until the weather conditions are more favorable.

From extended studies by Engler¹ on the periodicity of root growth in silver fir, white and Scotch pine, beech, oak, birch, and maple, it was ascertained that the development and production of roots are not continuous. Root growth is interrupted by periods of repose which do not exactly correspond with those when the shoots are at rest. The growth of the roots of coniferous species was entirely suspended from November to March or April, while root growth in the deciduous trees did not appear to undergo complete arrest in growth even in mid-winter. However, the period from February to the beginning of March is the least favorable for root growth, due to the low temperature of the soil. In general, root growth begins its rapid development from a few days to several weeks before the buds start. *For this reason spring planting is most successful when conducted at least one or two weeks before the buds begin to swell. The new root growth will not be injured or broken off in setting the plants.*

¹ Engler, Arnold: Untersuchungen über das Wurzelwachstum der Holzarten. (Mitteilungen der schweizerischen Centralanstalt f. d. forstliche Versuchswesen, VII. Bd., S. 247-317. 1903.)

It was found that the roots undergo a cessation of growth in summer due to drought, but in October there is a new period of activity, which is much more intense and more prolonged in deciduous species than in the conifers. It appears from these investigations that the autumn planting of broadleaved species should be just before this new period of root activity begins. It also appears that deciduous species, because of the greater growth of the roots in late autumn, are more acceptable for autumn planting than are spruce, pine, and other conifers.

16. Winter Planting

Over most parts of the United States winter planting should be avoided, because it is harmful to the young trees if there is frost either in the ground or in the air at the time of planting. Only in the southern part of the country is it safe to plant forest stock during the winter months.

17. Summer Planting

Summer planting also is objectionable because the trees are then in active growth. This new growth is young and tender, and requires a large amount of moisture to sustain the transpiration current. The soil at this season is more likely to be dry, and the loss of soil moisture through evaporation is at its maximum. In those localities, however, which have a well-defined rainy season during the summer months with little or no rain during the winter and spring, planting ordinarily begins at the commencement of the summer rains. It is extremely doubtful whether there is any portion of the United States where the summer rains are sufficiently abundant to make this season preferable to the spring months for forest planting.

18. Autumn Planting

In most parts of the United States the planting season falls between September 15 and May 15. Between these dates the planting should be done at such times as there is no frost in the air or soil. At high elevations, particularly in the Rocky Mountain region, because of the shortness of the growing season and the long time required for the frost to disappear completely from the soil in the spring, planting is often delayed as late as June.

More or less controversy exists as to whether autumn or spring is the preferable season for planting. On the whole, deciduous trees are better adapted for autumn planting than those which hold their leaves over winter. Localities subject to late frosts should be planted in late spring; so also heavy, stiff soils and exposed places should be planted in the spring. On the other hand, light soils and well-sheltered sites may often be advantageously planted in the autumn.

The chief objections to autumn planting are as follows:

- a. The trees are liable to be thrown by the frost.
- b. They are subject to injury by the wind.
- c. On heavy or overwet soils the roots are liable to decay.

Where the soil is subject to alternate freezing and thawing during the winter months, its contraction and expansion force the recently set plants out of the soil. In many localities this is the most serious objection to autumn planting.

Autumn winds, if high, may seriously injure recently planted trees by swaying them back and forth. This may so loosen them in the soil that autumn root growth is checked and they become dried out during the winter.

The chief advantages of autumn planting are the extension of the planting period and the formation of new root growth during the late autumn. Plants set in the autumn start earlier and make more rapid growth the first season. *In order to attain these results autumn planting of deciduous species should be done immediately after the leaves are cast, and evergreen species should be planted but little later. This will give opportunity for new roots to start and for the trees to become settled in the soil before winter.* In high altitudes and on other sites where the buds expand and the leaves appear almost as soon as the frost is out of the ground, autumn planting is usually preferable because of the shortness of the spring season suitable for planting. So also autumn planting is often desirable for species that start their growth very early in the spring, as is the case with elm, maple, larch, and poplar. As a rule, the only excuse for autumn planting is when operations are conducted on a large scale and the necessary planting cannot be completed in the spring.

19. Spring Planting

Almost without exception the most favorable time for planting is in the spring two weeks or more before the buds begin their growth. At this time the roots are active and become quickly established. When plants are taken from the nursery at this time and immediately set in the plantation, there is very little interruption of growth and the conditions are most favorable for maximum success. In the spring planting of deciduous species, it is particularly important that the trees be set before the leaves start their growth or even before the buds have appreciably swollen. When the planting is delayed until the leaves have started, they invariably wither and die on the trees and the later foliage which results from the unfolding of dormant buds is usually ragged and open. Most conifers, on the other hand, can be successfully planted after the new growth is fairly well advanced. They do better, however, when set before the new growth has started. When stock cannot be planted until after the spring vegetation is well advanced, it should be stored under conditions that prevent the new growth from starting.

Although in most localities early spring is the best season for planting all species, this period is of short duration varying from two to four weeks, depending upon the locality. When there is but a small amount of planting to be done, special effort should be made to set the trees at this time. When operations are conducted on a large scale, the economic handling of labor often prevents the planting of all the stock during the most favorable period. Both autumn and spring planting must be undertaken in order to distribute the labor economically. In cases where the planting is confined to a single species, well-protected sites and those having a porous, open soil should be selected for autumn planting; while the more exposed sites and the heavier soils should be reserved for spring planting. When two or more species are to be planted, the broadleaved species and the deciduous conifers should be planted in the autumn and the evergreen conifers in the spring. As regards spring planting, the hardier species should be planted early, while late spring should be reserved for the planting of tender species.

In regions like portions of California where there is a pronounced wet and dry season and where the wet season occurs during the

winter months, autumn and late winter or early spring planting is more successful than late spring planting, because in the latter case there is insufficient root development before the dry season begins to enable the trees to survive.

20. SPACING METHODS

Spacing, or the manner of distribution of the plants over the area, may be either irregular or regular.

21. Irregular Spacing

In this manner of spacing no attempt is made to set the trees in lines in either direction. The average distance between the plants, however, should be fixed upon and the planters should not deviate too widely from this distance. The distance is judged by the eye and considerable practice is necessary in order to distribute the plants with sufficient uniformity. The more experienced and the smaller the crew, the more uniform will be the distribution of the plants. A single inexperienced man unable to judge the planting distance will seriously interfere with the efficiency of the entire crew.

Irregular spacing should be practiced only on extremely rough sites, in underplanting where the trees are wide-spaced, and in filling up small irregular spaces in existing stands. An advantage resulting from this manner of spacing is that the best places can be selected in which to set the trees, as no attempt is made to keep to definite lines. An irregularly spaced plantation of the same density as one set in rows is a more effective barrier against wind action, and the litter on the forest floor is more likely to remain undisturbed. Irregular spacing is usually preferable when the trees are planted for esthetic purposes.

The irregularity of the spacing interferes to a greater or less extent with the facility in making the first and second thinnings and consequently is an important factor in determining the cost. In close stands irregularly spaced, the trees marked for removal are more likely to lodge against the neighboring trees in felling and are transported to the roads or margin of the plantation with greater difficulty than is the case where the trees are disposed in lines.

22. Regular and Semi-regular Spacing

In nearly all planting operations in the United States the trees are set by some system of regular or semi-regular spacing, *i.e.*, an effort is made to plant them in rows a uniform distance apart and at equal distances in the rows. In practice, however, absolute uniformity is rarely attained nor is it desirable when it entails additional expense. Where the same number of trees per acre is used in the planting, all methods of regular or semi-regular spacing show inappreciable differences after one or two thinnings. The question of cost, therefore, should determine the method best to use on any particular site.

23. ADVANTAGES OF REGULAR SPACING

The advantages of regular spacing as compared with irregular spacing are as follows:

a. The trees being in rows, blanks can be filled more readily and the young trees can be found more quickly in protecting them from competing vegetation.

b. The trees have a more uniform growing space and, as a result, the site is more completely occupied.

c. Cultivation, when necessary, can be resorted to without the necessity of hand labor.

d. The early thinnings can be removed more readily and at much less cost.

e. When mixed stands are desired, the required mixture can be more readily attained.

When 2- to 5-inch trees are planted on sites covered with grass and other herbage, unless the trees are set in rows it is impracticable to attempt to fill the blanks for a period of several years or until the young trees clearly show above the herbage. This necessary delay in filling blanks adds greatly to the cost, because much larger stock must be used than when the filling is done the year following the formation of the plantation. On open sites it is also often necessary to protect the young trees from weeds, grasses and other herbage which, if not removed, will overtop and smother them during the first year or two after planting. Economy in providing this protection demands the finding of the young plants amongst the herbage without undue waste of time. It is sometimes necessary to cultivate plantations for a period of

two or more years following the planting. This is particularly true of plantations made in prairie and semi-arid regions where the trees are likely to suffer from lack of soil moisture because of the competition of grasses and other herbaceous vegetation. Frequent cultivation also prevents excessive loss of moisture from the soil through evaporation. Under conditions where cultivation is necessary, it is usually continued until the stand closes. Economy demands that as little hand labor as possible be employed in cultivating the plantation, consequently regular spacing should be practiced so that horses may be used.

24. METHODS OF REGULAR SPACING

In all methods of regular spacing the trees are set in straight lines. All methods require the marking of the planting area in order to guide the planters. When the area has been plowed, as is the common practice in prairie planting, it is marked out in straight lines at the required intervals and in both directions. The trees are set at the intersections of the lines. The marking is done by horses in the same manner that a field is marked in preparing it for a crop of corn. On unplowed areas, planting lines or planting chains are stretched across the area at the required intervals and the plants are set along them at definite points which mark the desired spacing. The trees in regular spacing are arranged as follows (Fig. 103):

a. Squares, *i.e.*, the plants are set at the 4 corners of squares, the rows crossing each other at right angles and equally spaced in both directions.

b. Rectangles, *i.e.*, the plants are set at the 4 corners of rectangles. The rows cross each other at right angles and are wider spaced in one direction than in the other.

c. Equilateral triangles, *i.e.*, the plants are set at the 3 corners of the triangle. The rows cross each other obliquely.

d. Superposed squares, *i.e.*, the plants are set at the 4 corners of squares. In setting the plants a second crew of planters follows the first crew and sets a plant in the center of each square, judging the distance by the eye.

In the United States regular spacing as described above is confined to plowed areas, chiefly in the prairie regions of the Middle West, agricultural land in the East, and *Eucalyptus* plantations in California. The trees are usually set in squares or rectangles.

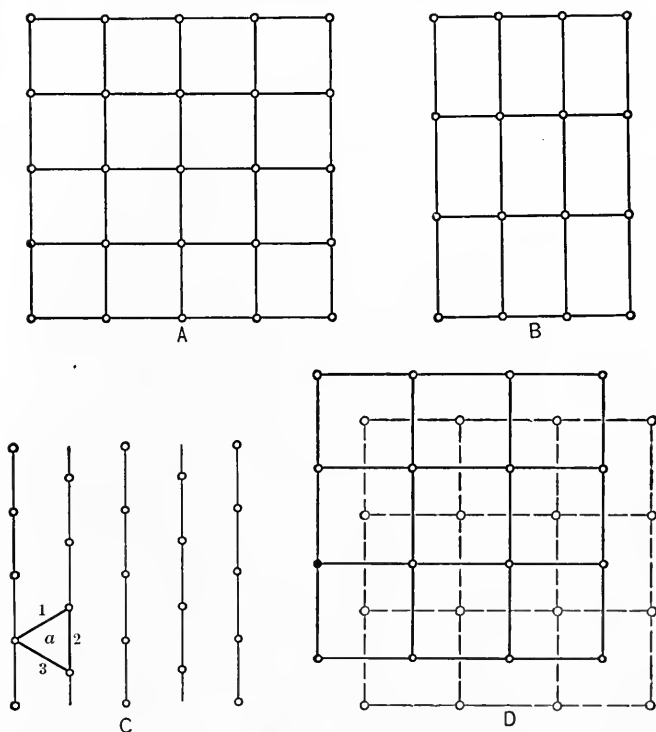

FIG. 103. — Methods of regular spacing.

A. Squares.

B. Rectangles.

C. Equilateral triangles.

D. Superposed squares.

25. METHODS OF SEMI-REGULAR SPACING

Under most conditions where planting is done in the United States, some method of semi-regular spacing is practiced. In this manner of spacing the planting area is not marked to indicate the point at which each tree is set as in regular spacing. Semi-regular spacing can be used on all sites and with an experienced crew gives results which for most purposes are comparable with regular spacing. The spacing is judged entirely by the eye or by a series of flags set in lines across the field.

The organization of the planting crew and its division into units vary with the method of planting and implements used and the character of the stock. In some instances each member of the planting crew carries his own stock, opens the hole and in-

serts the plant, thus performing the entire operation. In other instances the trees are carried by one or two members of the crew and given to the planters one at a time as needed. Again a portion of the crew may make the holes, while another inserts the plants.

When the planting crew consists of 11 men, namely, 5 hole

diggers, 5 planters, and 1 foreman, the arrangement of the men may be as follows (Fig. 104): The 5 hole diggers are arranged in a line at one end of the field, 4, 6 or 8 feet apart depending upon the spacing. The flanking man, or number 1, determines the direction, speed of planting, and the spacing. He advances across the field and makes the holes at the desired intervals. Number 2 keeps one planting space behind number 1, and number 3 one space behind number 2. This brings the line of diggers (1, 2, 3, 4, 5), diagonal to the direction of planting. This position is desirable in order to keep the spacing

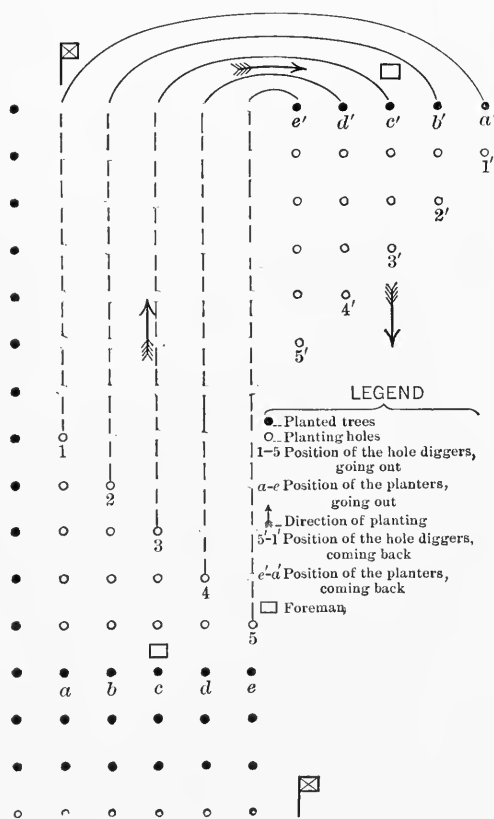

FIG. 104.—Diagram of the position of the men in a planting crew of 11 workmen.

ing reasonably uniform at the least effort. The 5 planters (*a*, *b*, *c*, *d*, *e*) should be kept at right angles to the direction of the planting in order to attain adequate supervision. After planting across the field, hole digger number 5 becomes the flanking man and the position of the entire crew is reversed. If

the crew is too large, the hole diggers furthest away from the flanking man are likely to get badly out of alignment from the accumulated errors of the others.

It is often necessary to establish lines of flags across the planting area in working with large inexperienced crews in order to keep the rows reasonably straight and at the desired distance apart. A line of flags may be used to guide the direction of the flanking man or a line may be set for each man in the crew. It is necessary to set the flags sufficiently close in the lines to enable the planters to keep a straight course across the field by sighting along the lines. When a line of flags is set for each planter they should be of different colors in order to eliminate confusion in following the lines. The flags are set by the foreman of the planting crew. Care must be taken in setting the flags that they be in straight lines across the planting area and that the lines be correctly spaced. The distance between the plants in the line is determined by the eye or by means of a measuring stick carried by the planter.

26. The Number of Plants per Acre

The approximate number of plants required per acre in irregular spacing is found by dividing 43,560, the number of square feet in an acre, by the area in square feet allotted to each plant.

The number of plants required per acre in regular spacing is as follows:

Square planting,

$$\text{No. of plants required} = \frac{43,560}{(\text{Planting distance})^2}.$$

Rectangular planting,

$$\text{No. of plants required} = \frac{43,560}{\text{Spacing in line} \times \text{spacing between lines}}.$$

Triangular planting,

$$\text{No. of plants required} = \frac{43,560}{(\text{side of equilateral triangle})^2} \times 1.155.$$

Superposed squares,

$$\text{No. of plants required} = \frac{43,560}{\frac{1}{2} (\text{side of square})^2}.$$

When the planting is in squares at 6-foot intervals, each plant occupies 36 square feet; therefore, the number of plants required

per acre equals 43,560 divided by 36, or 1210. When the planting is in rectangles 4 feet on one side and 6 feet on the other, each plant occupies 24 square feet; therefore, the number required per acre equals 43,560 divided by 24, or 1815. When the planting is in equilateral triangles 6 feet on a side, each plant occupies 31.2 square feet; therefore, the number required per acre equals 43,560 divided by 31.2, or 1398. When the planting is in superposed squares 8 feet on a side each plant occupies 32 square feet; therefore, the number required per acre equals 43,560 divided by 32, or 1362.

Applying the above formulæ, the following numbers of plants are required per acre:

In square planting:

| Spacing. | Plants. | Spacing. | Plants. |
|----------|---------|----------|---------|
| Feet. | | Feet. | |
| 3 × 3 | 4840 | 6½ × 6½ | 1031 |
| 3½ × 3½ | 2556 | 7 × 7 | 889 |
| 4 × 4 | 2722 | 7½ × 7½ | 775 |
| 4½ × 4½ | 2151 | 8 × 8 | 681 |
| 5 × 5 | 1742 | 8½ × 8½ | 603 |
| 5½ × 5½ | 1440 | 9 × 9 | 538 |
| 6 × 6 | 1210 | | |

In rectangular planting:

| Spacing. | Plants. | Spacing. | Plants. |
|----------|---------|----------|---------|
| Feet. | | Feet. | |
| 3 × 4 | 3630 | 5 × 6 | 1452 |
| 3 × 5 | 2904 | 5 × 7 | 1245 |
| 3 × 6 | 2420 | 5 × 8 | 1089 |
| 4 × 5 | 2178 | 6 × 8 | 908 |
| 4 × 6 | 1815 | 6 × 10 | 726 |
| 4 × 8 | 1361 | 8 × 10 | 545 |

In triangular planting:

| Spacing on side of equilateral triangle. | Plants. | Spacing on side of equilateral triangle. | Plants. |
|--|---------|--|---------|
| Feet. | | Feet. | |
| 3 | 5590 | 6 | 1398 |
| 3½ | 4107 | 6½ | 1197 |
| 4 | 3145 | 7 | 1027 |
| 4½ | 2485 | 8 | 786 |
| 5 | 2013 | 9 | 621 |
| 5½ | 1663 | | |

Planting in superposed squares:

| Spacing on side of square. | Plants. | Spacing on side of square. | Plants. |
|----------------------------|---------|----------------------------|---------|
| Feet. | | Feet. | |
| 6 | 2420 | 10 | 872 |
| 7 | 1778 | 11 | 720 |
| 8 | 1362 | 12 | 605 |
| 9 | 1076 | | |

27. PLANTING RULES OF GENERAL APPLICATION

The following well-established rules are of general application in all methods of planting and are worthy of special notice.

a. The trees should be planted so that the roots reach to a greater depth than that attained by the downward desiccation of the soil during summer droughts.

b. With due allowance for the settling of the soil, the collar of the tree should occupy the same position in reference to the surface soil that it did in its original position in the nursery.

c. The root system should be given, so far as practicable, its natural position in the soil, and the roots should not be crowded together, bent to one side, or placed in a single vertical plane.

d. When the site is overwet due to free water near the surface or other causes, the trees should be planted above the general level of the surrounding soil, *viz.*, on mounds or ridges.

e. When the site is overdry, due to soil or climatic conditions, the trees should be planted below the general level of the surface soil, *viz.*, in pits or trenches so that they can make greater use of the lower soil water.

f. Only the best and the freshest soil should come in contact with the roots in filling in about the trees.

g. In planting on steep slopes a step-like niche should be made and the plant set deep in the niche. The soil removed in making the niche should be placed on the lower side of the opening.

h. One plant should usually be set in a planting hole. Under special conditions two or more coniferous plants are planted together. When such is the case, the plants should be small.

i. The stem should usually be given an erect position and the soil thoroughly firmed about the roots. In planting for soil protection, the plants are sometimes placed oblique.

j. The smaller the planting material, the less expensive and the quicker and more certain the results, provided the trees are able to survive the planting operation.

k. The pruning of coniferous stock should usually be restricted to cutting back the longer roots. Broadleaved species require the pruning back of the longer roots and the re-forming of the crown when ill-shaped.

28. Depth of Setting the Roots and the Downward Desiccation of the Surface Soil

The depth to which soils dry out during summer and autumn droughts does not depend entirely upon climate. It is very largely determined by the character of the soil and cover. Loose, sandy soils on exposed sites dry out rapidly, particularly when covered with a surface vegetation of grass or weeds. The roots of the planted tree must reach to a greater depth than is the case when planted in heavier soils or under an overwood. Partially-shaded sites usually have more or less mulch over the surface soil and are, as a rule, more free of surface vegetation. The soil is usually loose and porous and more moisture is retained in the surface layers.¹ Much smaller and shorter-rooted stock can be successfully planted under partial shade than in the open.² The chief reason why coniferous transplants succeed better than seedlings on open, dry sites is because of their stronger and larger roots which reach to greater depth in the soil.

White pine plantations in southern New England on exposed, open sites having loose, sandy soil covered with grass and weeds, often fail when 1- or 2-year seedlings are planted, while 3- and 4-year transplants are usually successful. A plantation of white pine made by the author in 1905 near New Haven, Conn., on loose, sandy soil on an open, exposed site covered with grass and weeds was planted partially with 2-year seedlings and partially with 3-year transplants. Less than 20 per cent of the seedlings survived the first season, while the loss of transplants was less than 3 per cent. Seedlings of the same species planted in the same locality under an overwood gave a loss of less than 2 per

¹ Pearson, G. A.: The role of aspen in reforestation. (The Plant World, vol. XVII, p. 249-260. 1914.)

² Kimball, G. W. and Carter, E. E.: Influence of shade and other factors on plantations. (Forestry Quarterly, vol. XI, pp. 176-184. 1913.)

cent. The great difference in the percentage of plants that survived the first season on the open site was primarily due to the greater depth of the roots of the transplants in the soil. In the case where the seedlings were set under an overwood the surface soil did not dry out so completely, due to the protective cover and less surface vegetation.

29. Bad Effects of Planting with the Collar of the Tree too Deep in the Soil

The importance of planting so that the collar of the tree occupies the same relative position in reference to the surface soil that it had in its former position in the nursery cannot be overemphasized. This is of particular importance in planting spruce and other shallow-rooted species on heavy soil when the stock is more than 1 year old. When spruce or other shallow-rooted species 2 or more years old is planted with the collar much below its former position early growth is slow and the plant assumes a stunted appearance. These unfavorable results are due to the development of a new root system on the shoot just below the surface of the soil and the dormancy or death of the old roots.

Although we have little information drawn from observations on deep planting in the United States, the investigations of many European foresters clearly prove that poor results are likely to follow the setting of plants too deep in the soil. Geist,¹ from extended observations on Scotch pine in Germany, found that the best growth takes place and the stands remain closed to the end of the rotation only when the bracing roots are near the surface. He found that the deeper this species is set below the collar the poorer the growth and the greater the danger that many of the trees will die in the polewood stage. Many investigators have recorded the bad effects from the deep planting of Norway spruce. The older the plants the more disastrous the results.

Reuss,² from extensive investigations with Norway spruce in Austria, concludes that deep planting is the most frequent fault

¹ Geist, Senator: Welchen Einfluss hat ein zu tiefer Stand der Kiefer auf deren Lebensdauer und Ertrag. (Zeitschrift f. Forst- u. Jagdwesen, S. 589-596. 1913.)

² Reuss, Hermann: Die forstliche Bestandesgründung. S. 248-270. Berlin, 1907.

that is likely to occur in planting and is the most serious in its effect upon the future stand. Although the plants remain alive, shoot growth is unsatisfactory and the old root system makes little or no growth. In from 3 to 5 years after planting only dead roots of the original root system remain. Later the dead roots become infested with fungi (species of *Polyporus* and *Nectria*), which are the primary or contributing cause of the later death of many of the trees (Fig. 105).

It appears from investigations on Scotch pine and Norway spruce in Prussia that 1-year seedlings can safely be set considerably deeper than their original position in the seedbed. The 1-year plant has the capacity for changing its root system without

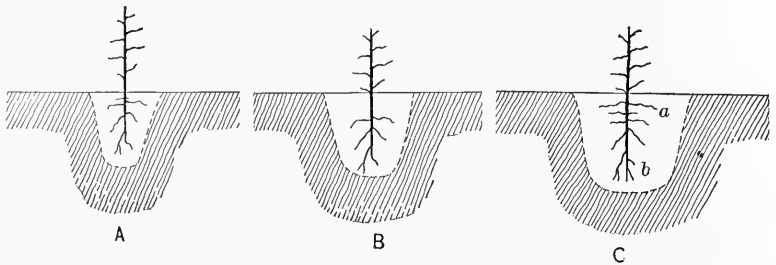

FIG. 105. — Diagram showing the effect of deep planting.

- A. The correct position of the collar of the tree in planting.
- B. The collar of the tree too deep in the soil.
- C. Two years after deep planting.
 - a. A new root system formed above the old.
 - b. The old root system dead and dying.

losing any part of it, but when more than a year old it suffers severe injury.

Although the planting with the collar well below the general level of the soil will often enable trees to survive summer drought, the practice is not desirable even on dry sites because of its effect upon later root development.

Species like the oak, chestnut, and hickory which naturally develop a deeply penetrating tap root during their juvenile growth, suffer much less from deep planting than spruce, hemlock, and most pines. Deep planting is less harmful on open, porous soils, such as sand and loam, than it is on heavy soils such as clay and lime.

30. Bad Effects from Bending or Crowding the Roots in Planting

Heyer, Fürst, Mayr, and most other European authors have, in the author's opinion, overemphasized the necessity for placing the roots so that they occupy as nearly as possible their original position in the soil. Although trees, particularly when more than 1 year old, usually become more quickly established and make more rapid juvenile growth when the root system is given its original position, economic planting does not permit or require over-refinement in this respect.

Investigations made by the author near New Haven, Conn., on 2-year seedlings of white pine show little difference in growth in plants set on loose, sandy soil with the roots in a vertical plane, crowded together in a narrow cylindrical hole, or spread out in their normal position.

Möller,¹ from a long series of experiments with Scotch pine on sandy soil in Prussia, concludes that it does not matter apparently whether the roots are bent to one side, tied together, or crowded into the planting hole. *He found that if the roots were not permitted to dry out, the above manner of treatment was not likely to kill the trees or even appreciably to check their growth.*

This does not imply that careless methods should be employed in planting but that unnecessary refinements should be avoided. That method which insures success at the least cost should be selected. All that is needed is to bring the roots into the soil in as natural a position as possible without excessive care which entails additional expense. On loose, sandy soils the slit method of planting which necessitates the crowding of the roots into a single plane is often acceptable because of its low cost. On the other hand, on heavy, compact soils it has time and again proved a complete failure. As a rule, the larger the stock the greater the necessity for spreading the roots so that they assume their natural position. Small plants have but few roots and they are short and flexible; hence, less attention in planting is necessary in order that they be properly disposed in the soil.

One of the most frequent defects in planting arises from crowd-

¹ Möller, Alfred: Versuch zur Bewertung von Kieferplanzmethoden. (Zeitschrift f. Forst- u. Jagdwesen, S. 629-632. 1910.)



FIG. 106.

a. Yellow pine killed from crowding its roots into a shallow planting hole.

b. Yellow pine in the same plantation in good condition and tap-root re-established. Planted in deeper hole.

ing trees with large roots into shallow holes. In such cases the roots are bent to one side and the tree rises obliquely from one side of the planting hole (Fig. 106). *The hole should be deep enough for the tap-root to hang vertically downward and wide enough to give as much spread to the lateral roots as economic planting will permit.*

31. The Advantages of Mound or Ridge Planting on Overwet Sites and Under Certain Other Adverse Soil Conditions

Where trees are planted in soil that contains free water most species will not survive the planting operation. The site is likely to be cold and the plants slow in starting. There is a lack of air in the soil and the roots usually decay. By raising the soil into mounds or ridges and setting the plants on the top of the mound or ridge after the soil has had opportunity to settle, the roots are brought into warmer and better drained soil. The height of the mound or ridge depends upon the wetness of the soil. It should be sufficiently high to bring the lowermost roots above the free soil water. The cost of mound and ridge planting is usually very high, but in the regeneration of wet land it is often the only recourse except through a thorough system of drainage which is usually even more costly.

Stolze¹ recommends the following method of planting on poor heath soils. The year before the planting is done, beds 12 feet wide are formed by throwing up the soil from intervening ditches 4 feet wide and 2 feet deep, thus raising the beds 7 inches above their former level. It was found that heath soils where reproduction was impossible without soil treatment gave good results by this method. Trees set in the beds the year following their formation made excellent height and diameter growth.

Mathey² has successfully practiced the following method of mound planting on dry, shallow, limestone soils. Mounds to the number of 160 per acre with ditches intervening are thrown up one year prior to planting. The soil excavated from the ditches is used to form the mounds. From four to ten plants are set on a single mound. Conditions in the United States seldom, if ever, justify the costly methods of mound and ridge planting practiced in Europe. The least expensive method of planting above the general level of the soil is by throwing up double furrows with the plow where the site permits. A year later the plants are set on the upturned furrows.

¹ Stolze, Emil: Rabattenkulturen und ihre Erfolge. (Zeitschrift f. Forst- u. Jagdwesen, S. 26-33. 1912.)

² Mathey-Dijon, Alph.: Hügelpflanzung auf trockenem, flachgründigem Kalkboden. (Schweizerische Zeitschrift f. Forstwesen, S. 169-170. 1907.)

32. The Advantages of Pit or Trench Planting on Overdry Sites

The depression of the surface of the planting hole below the general level of the soil is of very decided advantage from the standpoint of moisture available for the roots during periods of prolonged drought, as the lowermost roots, particularly those of small, short-rooted plants, can be brought to a depth of a foot or more below the general surface of the soil. The objections to this method of planting are the added expense and the usually poorer soil that the roots are brought in contact with when the trees are planted at the bottom of pits or trenches. If the soil is loose, the depressions are likely to fill with sand blown in by the wind, thus injuring or completely covering small plants. When small plants are set in the bottom of plowed furrows the same manner of damage is likely to occur.

The commonest method of planting below the general level of the surface soil is planting in furrows. Furrow planting is practiced in the sand hills of Nebraska¹ and elsewhere on exceptionally dry sites that permit of furrowing with the plow.

33. Bad Effects of Poor Soil About the Roots of Newly Set Plants

Where there is marked contrast between the fertility of the upper soil layer as compared with the deeper soil, the best soil removed in the opening of the planting hole should be brought into contact with the roots on filling in about the plants. This provision will stimulate the plants to quick growth and rapid root development. Care should be exercised that surface litter, which is usually coarse and contains an excess of organic matter, is not brought in contact with the roots in planting. It dries out rapidly and is to be avoided even more than the less fertile soil from the bottom of the hole.

Mayr,² Heyer,³ Gayer,⁴ Reuss,⁵ and other European authors

¹ Bates, C. G., and Pierce, R. G.: *Forestation of the sand hills of Nebraska and Kansas.* (U. S. Forest Service, Bul. 121. 1913.)

² Mayr, Heinrich: *Waldbau auf naturgesetzlicher Grundlage.* S. 419. Berlin, 1909.

³ Heyer, Carl: *Der Waldbau oder die Forstproduktenzucht.* 5. Aufl., 1. Bd., S. 330. Leipzig, 1906.

⁴ Gayer, Karl: *Der Waldbau.* 4. Aufl., S. 373. Berlin, 1898.

⁵ Reuss, Hermann: *Die forstliche Bestandesgründung.* S. 108. Berlin, 1907.

emphasize the desirability of fertile soil next to the roots of newly set plants. Although the trees remain alive when sterile soil is used, the foliage assumes a lighter color and little or no new growth takes place. In European practice fertile soil is usually brought to exceptionally poor sites for use as a filling soil. Fertilizers mixed with the native soil are also used for the same purpose.

34. The Advantages of Planting in Deep Notches on Steep Slopes

The loosening of the soil incident to mountain planting is usually the cause of more or less erosion, particularly on exposed open sites. When the plants are set flush with the surface soil, as is the common practice on level land, they are likely to be badly

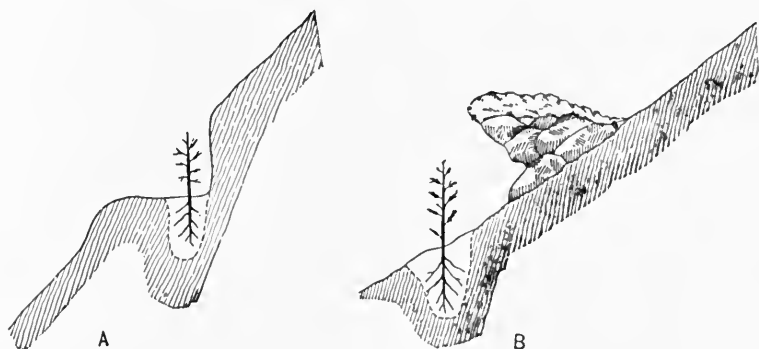

FIG. 107.

- A. Plant set in a step-like niche on a steep slope.
- B. Plant protected by stones on a steep slope.

injured or destroyed through erosion. The author has witnessed great injury from this cause in the mountains of New Mexico and elsewhere in western United States. This danger can be avoided by placing the planting hole in a deep, step-like niche. The size of the niche should be determined by the size of the planting stock, steepness of the slope, and the soil and climate.

On shallow, rocky soils that do not permit of making step-like niches for the reception of the plants, stones, clods of soil, or bits of wood should be placed on the slope just above the plant, to protect it from erosion and assist in retaining moisture in the surface soil (Fig. 107).

35. Conditions Under which More than One Plant May be Set in a Planting Hole

It is the common practice in the United States in all methods of planting to place but one plant in a planting hole. Under conditions where little loss is apprehended, one plant is preferable because the excess plants must later be removed. Under certain conditions in European practice, two or more plants are set together in a single hole. On poor soils that require enriched soil or fertilizers in the planting hole, the openings are often made large and two or more plants set in different places in the opening.

Block and bunch planting are practiced only with very small plants, usually conifers. In the former method¹ from 10 to 20 small plants, usually 1 year old, are removed from the seedbed in a compact bit of soil in the form of an inverted pyramid from 6 to 9 inches square. In planting, an opening of the same form as the earth carrying the seedlings is made in the soil. This method is practicable only when the seedlings are grown near the planting site and on soil sufficiently tenacious to hold together. Bunch planting² is sometimes practiced in wild stands that are overdense in some places and open and bare in others. Plants in the overdense places are lifted with balls of earth and reset in the open places. The balls usually contain more than one plant, hence the method is termed bunch planting.

36. Erect Planting and the Necessity for Firming the Soil about the Roots

Oblique planting is not practiced in the United States. In this method a slanting opening is made in the soil with a special planting iron or long-handled dibble. The plant is inserted and the opening closed by pressure of the foot. Only very small trees can be planted by this method, and it should be practiced only under special conditions. The plants are necessarily set very shallow and the young trees have a sloping position, both of which are objectionable under most conditions. The method is useful chiefly

¹ Heyer, Carl: *Der Waldbau oder die Forstproduktenzucht*. 5. Aufl, 1. Bd., S. 322. Leipzig, 1906.

² Mayr, Heinrich: *Waldbau auf naturgesetzlicher Grundlage*. S. 420. Berlin, 1909.

in underplanting with small hardwoods, although it has been successfully used in planting 1- and 2-year pine.¹

In all other methods of planting, the trees should stand erect. Slovenly methods of planting, more particularly the crowding of the trees into planting holes that are too small or too shallow, invariably tend to throw the plants from an erect position or else to bend them at the collar, particularly when set at the side of the planting hole. Moreover, when the planting hole is too shallow, the root system is thrown out of its natural position in the ground.

An intimate contact between the particles of fresh soil and the roots can be attained only by thoroughly firming the soil about the roots at the time of planting. A slight firming of the surface soil after the hole has been filled is insufficient. It is important that the soil be compressed about the roots to the very bottom of the planting hole. When the soil is loose about the roots, air spaces are likely to occur, the root hairs are not in intimate contact with the soil particles, and the plants suffer from the lack of moisture.

37. Advantages in Using Small Planting Material

Although trees of all ages may be planted, age in silvicultural operations is limited by the size and weight of the stock and the cost involved. In forestry operations in the United States, only trees under 5 years of age need be considered. Broadleaved species should seldom be used when more than 2 years of age, and conifers when more than 4. In European practice somewhat older trees are sometimes used, but the high cost is seldom, if ever, justified in the United States.

As a general rule, small plants are best because the operation of handling, transport, and planting is much less expensive. The roots of small plants are injured less in lifting and transport, and consequently they more easily survive the interruption of growth due to the planting. Furthermore, they adjust themselves more readily to new conditions.

38. The Necessity for Pruning Young Trees before Planting

As a general rule, plants used in forest practice should not be pruned unless it is absolutely necessary. European researches clearly show that the unhealthy condition of planted forests is

¹ Mayr, Heinrich: *Waldbau auf naturgesetzlicher Grundlage*. S. 421. Berlin, 1909.

often due to fungi entering wounds made in the trees at an early age. In pruning operations every cut is a wound which exposes the plant to disease that may later render the tree unfit for use.

The smaller the stock used in planting, usually the less the need for pruning because of the less injury to the crown and root system in the operations of lifting, transport, and planting.

39. THE USE OF LAYERS

A layer is a branch which is made to strike root while still attached to and obtaining nourishment from the parent plant. After the roots have developed, its connection with the parent is severed and it is planted in the nursery or field in the same manner as ordinary seedling or transplanted stock. The tendency in plants to strike root from the stem cambium is quite common, particularly in trees of warm regions. This method of propagation has very little use in practical forestry but is more useful in horticulture. The three kinds of layers from trees and shrubs are:

- a. Layers from bent-over branches.
- b. Layers from stool shoots.
- c. Aerial layers.

In the formation of layers from bent-over branches, the herbage and litter is cleared from the ground at the proper point and the ground loosened. The branch is bent downward to this point and held in place with a forked peg driven into the ground and covered to a depth of from 3 to 6 inches with rich earth. Sometimes a stem with numerous branches is bent down and covered in similar manner, each of the branches as well as the main axis later becoming rooted plants (Fig. 108).

In making layers from stool shoots the parent plant is cut close to the ground in early spring. By midsummer or as soon as the stool shoots are well advanced a mound of rich earth is thrown up around the stump and the base of the new shoots. The shoots of some species produce abundant roots in the fresh soil and are soon ready to be removed and set in the nursery or field.

Where the stems or branches cannot be bent to the ground, aerial layerings are sometimes made by encircling a portion of the stem with soil surrounded with sphagnum moss kept continually moist.

In all methods of producing layers the rooting is facilitated by the rupture of the bark at the point where the branch is brought beneath the soil. With thick, hard-barked species a ring of bark may be removed or a notch cut on the lower side a third of

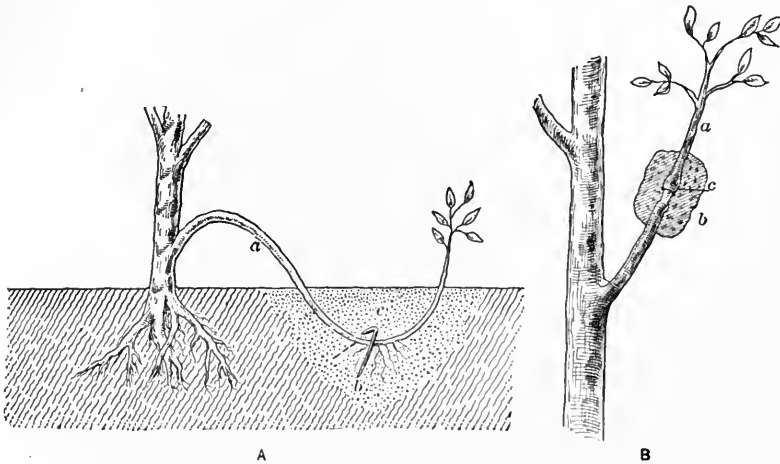

FIG. 108.

A. Layer from a bent-over branch.

B. Aerial layer.

the way through the stem. As a rule, 2-year wood roots more freely than 1-year. The effect of cutting through the bark is to stimulate the formation of callus from which the roots later develop.

Only a few forest trees propagate freely from layers. Beech, elm, and ash root freely in a single year. With many species it takes 2, or even 3, years. Layers should not be removed from the parent tree until they are well rooted. In stands of young sprouts, stool shoots of beech, ash, and basswood can be brought on their own roots by bending over the 2- or 3-year shoots and treating them as described above. When the old stumps are defective the stand can be greatly improved in this way. When the layers are well rooted their connection with the parent tree is severed and they become independent plants.

40. PLANTING ROOT SUCKERS

The use of root suckers in planting operations is necessarily confined to a limited number of broadleaved species, *viz.*, those that freely develop shoots along their surface roots. The species

most frequently propagated in this manner are black locust, *Ailanthus*, silver poplar, and many surface-rooted shrubs. The formation of root suckers can be greatly stimulated by uncovering the surface roots of the parent tree, cutting incisions through the bark and later covering them again.

When the sucker is from 1 to 3 years old it is prepared for removal from the parent tree by cutting off the root from 6 to 10 inches from the shoot at either side. This should be done at least 1 year before the sucker is removed for setting in the nursery or plantation. If removed without this preliminary treatment it is almost invariably without fibrous roots and consequently of little or no value for field planting. The trees produced from root suckers are usually inferior to those grown from seed. A portion of the root of the mother tree remains with the sucker and becomes overgrown. Trees grown from root suckers are likely to develop rotten heart.

41. PLANTING ROOT CUTTINGS

Pieces of well-developed roots from 6 to 10 inches long and $\frac{1}{2}$ to 1 inch thick may be used to propagate a number of broadleaved species. The cuttings are made in autumn or winter and planted directly or wrapped in moss and stored in a cool, moist cellar. The process of storing develops a callus at the cut ends and stimulates the production of buds. Root cuttings are never set directly in the field but are set in the nursery for 1 or more years or until they are sufficiently large for planting in the open field. They are usually placed in V-shaped trenches in an upright position and completely covered with soil well pressed down. The end of the cutting from nearest the stump of the parent tree should be uppermost.

When root cuttings are stored over winter they are set in the nursery in the spring just before vegetation starts. Many woody species of the families *Rosaceæ* and *Oleaceæ* may be freely propagated by root cuttings. This method is most serviceable in horticulture. It is rarely used in propagating stock for forest planting.

42. PLANTING SHOOT CUTTINGS

Shoot cuttings are pieces of branches which are placed in the soil to develop roots. Before the development of roots their only means of absorption from the soil is through the end of the cut-

ting. There is no absorption through the bark. Shoot cuttings are made both from growing wood and from ripened wood. When made from growing wood the immature growing tips are cut from the branches of the parent plant and immediately set in moist sand in a greenhouse or frame where the moisture conditions of both the soil and the atmosphere are under control. This method of propagation is very largely used in floral and horticultural work. It is sometimes used in the extensive propagation of *Thuja*, *Chamaecyparis*, and other genera of the cedar tribe, particularly when horticultural varieties that do not come true to seed are desired.

When shoot cuttings are used in silvicultural work they are usually made from ripened wood. It is generally true that cuttings made from ripened wood root better although they require more time and do not always make as good plants. Many species that grow freely from ripened wood will not root at all when the cuttings are made from immature wood. When properly handled and when made from mature wood many woody species can be made to strike root. Although shoot cuttings are extensively used in nursery work, where trees and shrubs are grown for park and decorative planting, their use in forestry practice is confined to species which start quickly after the cuttings are set and which grow rapidly, as illustrated in the various species of willow, poplar, and sycamore.

In the preparation of the cuttings, wood of the current year, or at most but 2 years old, is gathered in late autumn or early winter before heavy frosts have begun. The gathered wood is either immediately made into cuttings or stored in a cool cellar where it is covered with moist sand or sphagnum moss to keep it from becoming overdry. The cuttings are made from 6 to 12 inches long, preferably from wood $\frac{1}{2}$ to $\frac{3}{4}$ inch in diameter. The upper end of the cutting should be severed just above a normal well-developed bud. The cut should be made at nearly right angles with the shoot, only sufficiently oblique to permit a clean cut without bruising the bark. It can be done best with a sharp thin-bladed knife made especially for the purpose.¹

¹ In European practice cuttings are sometimes made with a special machine with which three laborers — one to operate the machine and two to assist in bringing the wood to the machine and in tying the cuttings into bundles — can cut and tie 30,000 cuttings in a single day.

As rapidly as the cuttings are made they are tied in bundles of 25 to 100, taking care to have them all tied with the upper end of the shoot in the same direction. These bundles are then buried in moist sand with the butts downward and firmly pressed against the soil. They should be buried sufficiently deep to protect them from frost.

When the wood is held over winter in storage the cuttings may be made in late winter or early spring, placing them in water or in damp moss until wanted for planting. In preparing them for shipment they are usually wrapped in damp moss.

Under ordinary conditions they should be set in the nursery or in the field in late spring. In setting in the nursery they are put into V-shaped trenches, placing them from 1 to 3 inches apart. The trenches are usually from 1 to 1½ feet apart to permit of cultivation. *They should be set nearly vertical in the soil, with only sufficient slope to permit of easily and quickly firming the soil about them.* The uppermost bud should be level with the surface. Only 1 bud should be permitted to develop. This can be controlled by rubbing off the remaining buds as the cutting is set. If the lower end of the cutting has become somewhat dry and a callus has not formed, it should be slightly shortened by making a fresh cut.

After remaining in the nursery for a year, root development has usually made sufficient progress to warrant their transfer to their permanent position in the field or forest.

The cuttings of cottonwood are sometimes set in their permanent location at once. When set in the field in unrooted condition, care should be taken that they are set with the uppermost bud level with the surface and the soil firmly pressed about them. They should never be forced into the ground as it injures the cambium at the lower end of the cutting and interferes with later growth. They should be set in holes or in furrows as in ordinary planting or in small openings made with a planting iron or special tool (Fig. 109)



FIG. 109.—Tread dibble for setting unrooted cuttings.

Various willows and poplars readily strike root from wood several years old. With these species shoot cuttings are often 6 to 8 feet long, and 2 to 6 inches in diameter. They are set out immediately after cutting, burying the butt end 2 or more feet in the ground. Large cuttings of this character are chiefly used in planting along streams to hold the bank in place and along irregular ditches.

CHAPTER XVII

ESTABLISHING FORESTS BY PLANTING (*Continued*)

1. PLANTING OPERATIONS: TECHNIQUE AND METHODS

PLANTING is always accompanied by more or less injury to the plant. Even under the most favorable conditions and with the exercise of the utmost care, there is always some arrest of growth. *The chief aim to attain in planting should be to reduce the interruption of growth to the lowest degree possible consistent with economy.* This is necessary in order that the trees may become established quickly. It is not sufficient that the plants barely live; they ought to be handled in their removal from the nursery or field, in transport, and in planting so that they quickly make new root and shoot growth. By so doing, the danger from summer drought and suppression by competing vegetation is much reduced.

All well-established methods of planting are useful under special conditions. In deciding upon the method to follow in planting a given species in a given locality, the practitioner must be guided primarily by the expense involved. *He should use the method that will result in a successful plantation at the least cost.* Inexpensive methods that give acceptable results with one species or in a given locality may be totally unsuited for other species or in other localities.¹

The methods and technique pursued in planting white pine in New England cannot be successfully followed in planting western yellow pine in the sand hills of Nebraska. European methods and technique cannot be blindly followed in the United States. Each practitioner must select the method that seems best suited to his particular conditions and modify it as circumstances require.

2. Classification of Planting Methods

A great variety of planting methods have been developed to meet the varying conditions of site and planting material in

¹ Bates, C. G. and Pierce, R. G.: *Forestation of the sand hills of Kansas and Nebraska.* (U. S. Forest Service, Bul. 121, p. 40. 1913.)

the most successful and economic manner. Only a comparatively small number, however, are generally practiced in this country.

In general, all planting methods can be classified under the following heads:

- a. Planting with the roots enclosed in a ball of earth.
- b. Planting with the roots naked.

3. PLANTING WITH THE ROOTS ENCLOSED IN A BALL OF EARTH

Trees lifted with the soil attached to the roots are known as "balled plants." The use of such stock insures the greatest degree of success and the least interruption of growth after planting. It is especially suitable for the planting of very young and tender plants. With larger plants, the labor involved in lifting and planting and the cost of transport are prohibitive. When the work is properly done, few of the trees fail to grow. It is far too expensive for general silvicultural operations and is chiefly confined to special operations and to decorative planting where cost is of secondary consideration. The "balling" of the roots is chiefly confined to conifers and evergreen broadleaved species. It is seldom necessary to ball the roots of deciduous species when used in silvicultural operations.

The use of balled stock in silvicultural operations in the United States is justified only in the following special cases:

- a. When quick results are desired and cost is of secondary importance.
- b. On adverse sites where naked-rooted plants are likely to fail.
- c. When the planting operation is done out of season.
- d. With certain tender plants, as in the various species of *Eucalyptus*.

Species that produce a spreading root system when young, as is the case with hemlock, spruce, and most pines, can be balled to better advantage than those that develop a long tap root with few short laterals.

It is impractical to attempt to lift trees with balls of earth when the soil is filled with stones or roots, or when it is loose, sandy, or gravelly. Clay-loam free from all obstructions is the best soil.

After the plants are lifted, the soil about the roots is left unprotected or else it is covered. When the plants are small and the soil tenacious, no protective covering is required.

The various steps in the handling of balled plants are as follows:

- a. Lifting the stock with balls of earth.
- b. Transporting the stock with balls of earth.
- c. Planting balled stock.

4. Lifting Balled Stock. — Special attention should be given to the manner of lifting in order that the root system may be wholly or chiefly contained in the ball. If the ends of the roots are severed in the process of lifting, the larger part of the absorbing surface has been cut away and but little is gained by having the remaining roots encased in the ball of earth (Fig. 110).

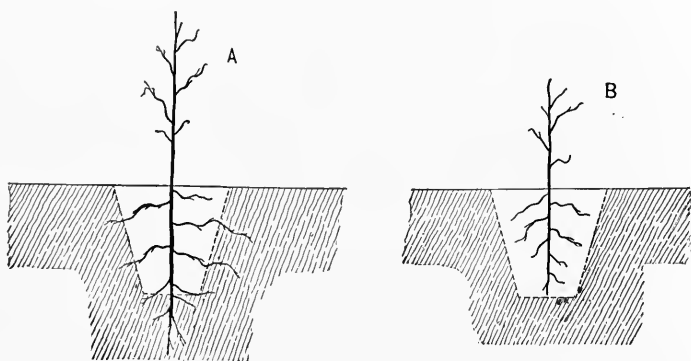

FIG. 110.

- A. Balled plant with the root system incompletely retained.
- B. Balled plant with the root system completely retained.

Small plants may be lifted and planted with an ordinary trowel; with larger plants, a heavy hoe or spade may be used. The soil must be sufficiently moist and binding to retain the ball intact during transport and planting. Dry soil should be thoroughly moistened before the plants are lifted. If the situation is such that water cannot be brought to the area where the stock is to be lifted, the operation should be delayed until after a heavy rain.

5. Transporting Balled Stock. — Balled plants are costly and difficult to transplant due to the weight of the soil and the great care necessary in order to keep it attached to the roots. Ordinarily the stock should be grown close to the planting site and the process of

lifting, transportation, and planting carried on as a continuous operation. When the stock is lifted with a trowel or ordinary spade and the balls are more or less variable and irregular in shape, the planting hole should be sufficiently large so that the plant with the attached ball can be set at the proper depth without breaking or loosening the soil about the roots. In all cases, the soil of the planting hole and the ball should come into intimate contact, leaving no spaces for the air to enter and dry out the plant (Fig. 111).

When small plants are lifted with the trowel, they are usually set upright in a flat or shallow box. By proper manipulation of the

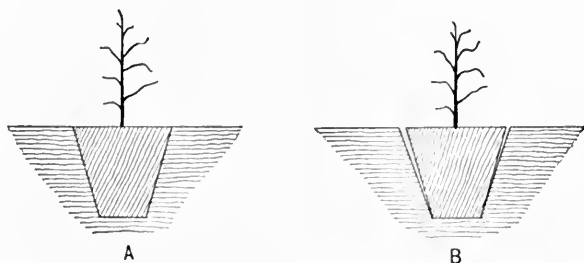

FIG. 111.

- A. Balled plant properly planted.
 B. Balled plant improperly planted.

trowel in lifting, an inverted cone-shaped ball of suitable size is secured. If the soil proves too loose to hold together, one or two handfuls of moist clay may be wrapped about the small ball before placing it in the box. The plants are transported to the planting site in flats or boxes and removed one at a time as they are required for planting. The hoe and spade are often used in lifting and setting larger plants with attached balls when the distance of transport is very short. Often in natural regeneration plants are too close together in some places, while blanks occur in others. Both the hoe and spade are used in shifting some of the plants from the overdense places to those where natural regeneration has failed.

The difficulty experienced in keeping the ball intact during transport and planting has led in some instances to the development of special tools for lifting and planting, and in others to the growing of small stock in flats, pots, or other receptacles, which at the time of planting are taken to the field and the plants with the

ball attached removed one at a time as wanted for planting or else in the case of special receptacles, each of which contains but a single plant, the receptacle itself with the contained plant is set in the soil at the proper depth. In the latter case, the receptacle must be of such a character that it will readily disintegrate and not interfere with the later development of the plant.

6. Planting Balled Stock.—As a general rule, the upper part of the ball should be level with the surface of the soil when the tree is set. When the planting hole is of the same size and form as the ball no adjustment is necessary in order to attain this end. It is necessary only to press the ball into place firmly. When the planting hole is larger and of different size than the ball, as the earth is filled in, the tree should be carefully adjusted to the proper position. The soil should be thoroughly tamped in order to fill all spaces between the ball and the sides of the hole.



FIG. 112.—The cylindrical spade.

7. Lifting and Planting Balled Plants with Special Tools.—Dr. Carl Heyer¹ devised the method of lifting and planting small and medium-sized plants by means of a cylindrical or hollow spade (Fig. 112). This spade is made in various sizes varying from 2 to 6 inches in diameter at the cutting edge and from one-eighth to one-fifth larger at the upper end. It is not practical, however, for lifting plants with balls of earth more than 5 inches in diameter as the ball will not remain in the spade when it is withdrawn from the soil. It

can be used only in lifting plants that are sufficiently wide-spaced to permit its use without interfering with adjacent trees, *e.g.*, in lifting 2-inch balls the plants should be at least 3 inches apart, and in lifting plants with 5-inch balls the plants should be 6 inches apart.

In operation, the cylindrical spade is placed over the tree to be removed with the stem in the center. It is then thrust verti-

¹ Heyer, Carl: *Der Waldbau oder die Forstproduktenzucht*. 5. Aufl., 1. Bd., S. 314. Leipzig, 1906.

cally into the soil to the full depth of the blade and turned round until the ball is loosened at the base. As the spade is removed, the tree with the attached ball is lifted from the ground. By placing the right hand on the base of the ball, it is forced upward and out of the spade. When plants are lifted with this tool, the planting hole is usually made with the same implement. The ball fits the hole if the spade used in lifting is the same size as that used in planting. On stiff, heavy soils the ball shrinks more or less during dry weather causing an opening between it and the planting hole. On such soils, therefore, this method of planting is not satisfactory.

The semi-conical spade was devised in Europe to facilitate the easy lifting and planting of balled stock (Fig. 113). It is recommended for planting beech and other shallow-rooted species. It is thrust into the ground at the requisite distance from the tree to be lifted and at the proper angle and turned around on its axis until the cone-shaped ball is entirely detached. The planting hole is made with the same or a similar spade and when properly executed is of the exact size to fit the lifted plant.¹

Neither of the above spades is adapted for use on stiff clay and loose sand. They will not work in soils filled with stones or roots, but permit of rapid and effective work when the soil is uniform in texture and of suitable consistency.

Roth² has recently devised a tool for rapidly lifting small balled plants and for making the holes in which they are set. The tool is placed over the plant to be lifted and pressed into the soil. Two semi-circular cutting blades, when forced downward, cut out a cylindrical column of soil with the plant in the center. By exerting pressure on a lever the blades are pressed together at the



FIG. 113.—The semi-conical spade.

¹ Mayr, Heinrich: *Waldbau auf naturgesetzlicher Grundlage*. S. 303. Berlin, 1909.

² Roth, Julius: *Neue forstliche Geräte*. (*Forstw. Centralblatt*, S. 358-366. 1915.)

base, thus permitting the ball to be removed, after which the pressure is removed and the ball slips out.

Various types of spades have been devised for lifting plants with attached balls in the form of an inverted pyramid. The ordinary spade with a straight cutting edge can be used. The spade is thrust into the soil at a suitable distance from the plant on each of the four sides. In inserting the spade, it is held so that the cut gradually slopes toward the tree to be lifted. When properly executed, the removed ball is in the form of an inverted pyramid. The chief difficulty in the use of the ordinary spade is in making the planting holes of the exact form to fit the pyramid-shaped balls.

The triangular spade,¹ which has a triangular cutting edge, is more easily operated in lifting the plants without breaking the ball. The pyramid-shaped ball is acceptable only for very small or surface-rooted plants as it consists mostly of surface soil.

In block planting, the stock is grown in carefully prepared seedbeds or in large seed spots on the area to be regenerated. When grown in seedbeds, the entire surface of the seedbed with the contained plants is lifted in the form of small cone-shaped or pyramid-shaped balls 5 or 6 inches in diameter, each of which contains from 10 to 20 small plants. These are transported to the planting site. Slowly growing conifers are suited best for this method of lifting. The planting holes should be made of the exact form to fit the ball as removed from the seedbed. This is effected by using the same tool in making the hole that is used in lifting the seedlings.²

8. PLANTING NAKED-ROOTED PLANTS

Under all ordinary circumstances, naked-rooted plants are used in forest planting. Although such plants suffer greater loss and experience a greater interruption in growth, the lower cost due to easier handling and transport more than compensates for the losses and interruption of growth under most conditions of site and with most kinds of stock.

In all planting operations with naked-rooted plants, the size

¹ Heyer, Carl: *Der Waldbau oder die Forstproduktenzucht*. 5. Aufl., 1. Bd., S. 321. Leipzig, 1906.

² Kozesnik, Moritz: *Aus dem waldbaulichen Alphabete*. (Centralblatt f. d. gesamte Forstwesen, S. 161-163. 1894.)

and shape of the opening in the soil depends chiefly upon the size and character of the plant and upon the tool used in making it. A large number of methods are used and a great variety of planting tools have been devised for planting naked-rooted plants of various sizes and in various kinds of soil. In general, all methods may be placed in the following classes:

- a.* Those in which the opening is made by compression of the soil.
- b.* Those in which the opening is made by removing the soil and piling it at the side of the hole.

9. Planting Operations where the Opening is Made by Compression of the Soil.—In the various methods of planting where the opening is made by pressing the soil to one side, cone- or wedge-shaped tools are usually used. An inverted cone-shaped opening or a wedge-shaped slit is made in the soil into which the naked roots of the plant are sunk. When the plant is in position and the roots inserted to the required depth, the soil is pressed in about them.

Many methods have been practiced and a large number of special implements have been devised for planting trees in openings made in the soil by compression. The advantages of these methods of planting are as follows:

- a.* The cost is relatively low.
- b.* The planting can be done with great rapidity.
- c.* The plants can be set with the roots at great depth.

The cost per thousand for setting plants is from one-third to one-half the cost of planting in holes made with a spade, grub-hoe, or mattock. On suitable soil a man should set from 100 to 200 per hour. The rapidity with which the planting can be done makes it possible to extend the planting over a shorter period of time, and permits its being done at the most favorable time as to season and weather conditions. Plants with long tap roots, such as the oak, chestnut, and some pines, can be planted rapidly by this method and, at the same time, the roots can be placed well down in the soil where moisture conditions are most favorable.

The disadvantages that result from these methods of planting are usually very great and, on most sites and with most kinds of planting stock, overbalance the advantages mentioned above. The more prominent of these disadvantages are as follows:

- a.* In the formation of the planting hole the soil is rendered compact on all sides of the opening.

b. On hard, compact soils it is difficult to bring the soil into contact with the roots in closing the hole.

c. They cannot be used on areas covered with grass or other herbage or with litter.

d. The roots are crowded together in a single mass or else spread out in a single plane; conditions which may be harmful on certain soils.

e. Areas where the soil is filled with roots and stones cannot be satisfactorily planted.

f. The opening is so narrow the roots are likely to be doubled backward in setting the plant.

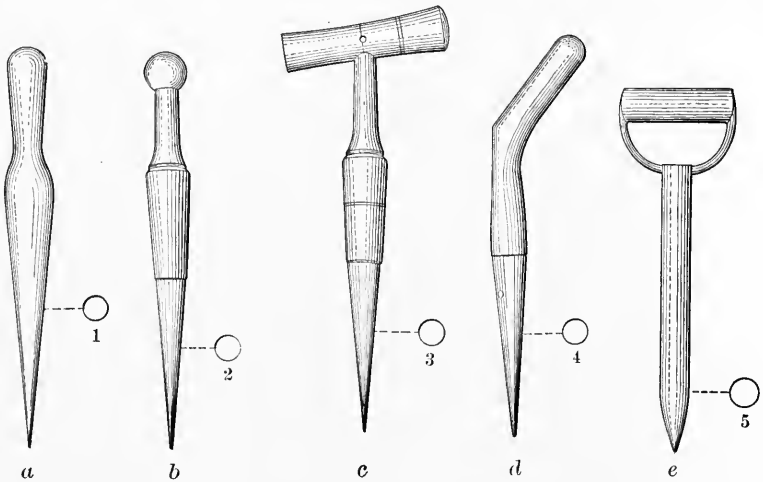

FIG. 114.—Types of dibbles.

- | | |
|-----------------------------|---------------------------------|
| <i>a.</i> Planting peg. | <i>d.</i> Pistol-grip dibble. |
| <i>b.</i> Knob-grip dibble. | <i>e.</i> Spade-handle dibble. |
| <i>c.</i> T-grip dibble. | 1-5. Cross sections of openings |

10. PLANTING WITH TOOLS WHICH MAKE THE OPENING IN THE SOIL IN THE FORM OF AN INVERTED CONE OR PYRAMID.—The simplest implements for making openings in the soil for the purpose of setting small trees are the dibble and planting peg (Fig. 114). A great variety of dibbles are used for this purpose. They differ greatly in the ease with which they can be forced into the ground. Dibbles are made of wood or iron or a combination of the two.

The ordinary garden dibbles and planting pegs are too small and blunt-pointed for field planting in forestry practice. The straight-handled dibble terminating in a knob is difficult to use without tiring or blistering the hand except when the soil is loose and open. The spade-handle dibble is slightly better, but the best forms for effective use are the pistol-grip and the T-grip. The cross section of the opening made with the ordinary forms of dibble is circular. Special forms of the dibble are sometimes used in forest planting which make the opening triangular or semi-circular in cross section.¹ These special forms are often called planting daggers (Fig. 115). The Spitzenberg three-edged planting dagger,

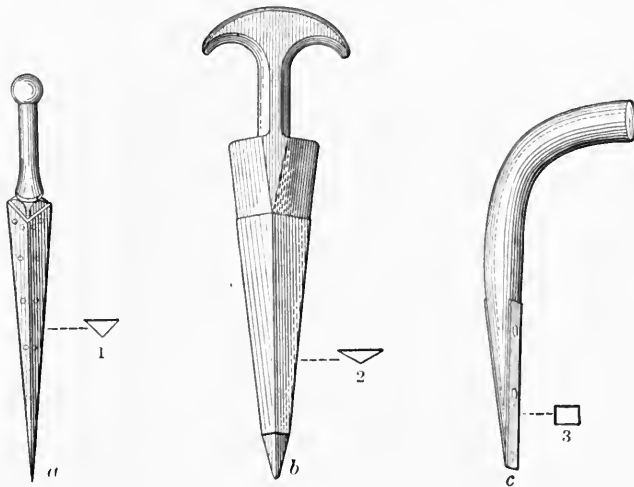

FIG. 115. — Types of planting daggers.

- a.* Knob-grip planting dagger. *c.* Pistol-grip planting dagger.
b. T-grip planting dagger. 1-3 Cross sections of openings.

one of the best of this class of implements, has all of the advantages of the dibble, is easier to manipulate in making the opening and permits of closing the orifice more quickly after the plant is inserted and of bringing the soil into closer contact with the roots.

In planting with the dibble, it is inserted vertically into the soil and then withdrawn. A plant held between the forefinger and thumb of the right hand is inserted in the opening, care being taken that the roots hang vertically downward. The tool is reinserted in a slanting position a few inches from the original insertion

¹ Schlich, Wm.: Manual of forestry. 4th ed., vol. II, p. 223. London, 1910.

in such a manner that the lower points of the two openings come together (Fig. 116). It is then moved forward, firmly pressing the soil against the roots of the plant. Careful attention must be given to the insertion of the tool at the proper slant so that when it is pressed forward the opening will be completely closed. When not properly inserted, the lower part of the planting hole is likely to remain open.

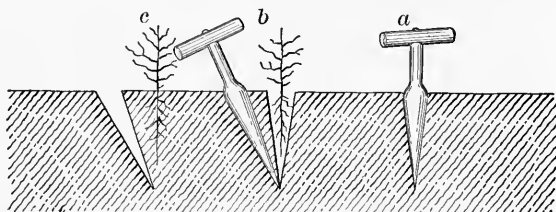

FIG. 116. — Planting with the dibble.

- a.* Inserting the dibble. *b.* Inserting the plant.
c. The opening closed.



FIG. 117. — Planting Norway spruce with the dibble under an overwood of oak and chestnut. Near New Haven, Conn.

This is an extremely rapid method of planting, but it is usually necessary to work the soil beforehand although it can sometimes be practiced in underplanting without previously working the soil (Fig. 117). It is particularly well adapted for planting on light,

sandy soils not likely to be overrun by surface vegetation. Only very small plants or those with a weak development of lateral roots should be planted with the dibble. The ordinary dibbles should never be used in setting transplants.

Buttlar's planting iron is a German tool which has been extensively used in Europe (Fig. 118). It is made entirely of iron, weighs about 7 pounds, and the pistol-grip handle is covered with leather in order to make its operation easier on the hand. The diameter is much greater than that of the ordinary dibble, and its weight assists in forcing it into the soil. It has been introduced into the United States for demonstration purposes but has not been used in field planting. It is used abroad chiefly in close planting small coniferous seedlings on well-prepared soil (Fig. 119). It permits of rapid work on such soil, as 1 man can plant on the average from 1200 to 1500 trees in a single day and under exceptionally good conditions as many as 1800. Under adverse conditions, as few as 500 plants are given by Heyer as a day's work.¹ The method of conducting the planting operation is much the same as with the dibble. The small plants are carried in the ordinary planting box, planting basket, or pail, with the roots protected. The tool is forced into the soil at the desired point and withdrawn. A plant is inserted to the desired depth, care being taken that the roots extend vertically downward in the hole. The roots are much easier to insert if they have been thoroughly puddled, as this operation causes the small laterals to lie closer to the tap root.

On sites where the soil is compact, where roots or stones are present, or where deeper and larger openings are required than can be made satisfactorily with the dibble, the planting staff (Fig. 120) or the ordinary crowbar may be used to make the openings and to close them after the plants are inserted. Two workmen are employed, one to make and close the openings and the other to insert the plants. Even when the soil is loose and open, the

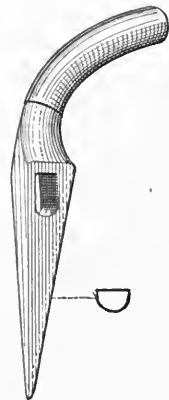

FIG. 118. — Buttlar's planting iron.

¹ Heyer, Carl.: *Der Waldbau oder die Forstproduktzucht*. 5. Aufl., 1 Bd., S. 346. Leipzig, 1906.



FIG. 119. — A plantation of 1-year Scotch pine planted at 18-inch intervals in rows about 4 feet apart. Near Eberswalde, Prussia.

dibble, planting peg, and Buttlar's planting iron cannot be used to make openings to a depth greater than from 5 to 8 inches. The planting staff is a much heavier tool. Even in resistant soil it can be forced downward with little effort. The Wartenberg planting staff¹ is one of the best of this type of tools. It weighs from 12 to 14 pounds and is made of iron with the exception of the cross-bar handle. The heavy iron head is pointed, 4-sided, and about 10 inches in length. The entire tool is approximately 36 inches long. In its operation, the workman stands upright, raises the point of the tool a foot or two above the soil and quickly thrusts it downward.

The author has found this tool most suitable for planting oak and other deep-rooted trees, particularly species with long and heavy tap roots and poorly-developed laterals. It works best on loam or sandy soils. When the soil is heavy it is almost impossible to close the opening about the roots properly. The rapidity with which the plants can be set depends chiefly upon the compactness of the soil and its freedom from roots and stones.

¹ Heyer, Carl.: *Der Waldbau oder die Forstproduktenzucht*. 5. Aufl., 1. Bd., S. 349. Leipzig, 1906.

On average soils 1 workman to make and close the openings and a boy to insert the plants will average from 1200 to 1800 trees per day.

An ingenious planting tool was invented by Jensen¹ in 1913 and placed upon the market. It differs from all other planting tools in carrying the plant into the soil at the same time that the opening is made for its reception (Fig. 121). This tool has been tested experimentally by McLean² with satisfactory results.



FIG. 120. — The Wartenberg planting staff.

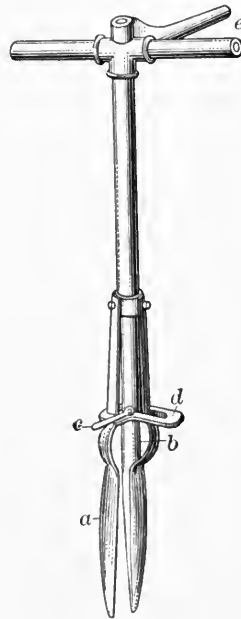

FIG. 121. — Jensen's tree planter.

As yet it has not been used sufficiently on various soils in different localities and with various kinds of stock to warrant a statement of its effectiveness as a planting tool. It is especially adapted for planting tap-rooted species without strong lateral roots on loam and sandy soils. It is said to work well on brush-covered areas and burns, but not on gravelly and stony soils.

¹ The Jensen planting tool is manufactured and sold by N. B. Jensen, Ephraim, Utah.

² McLean, F. T.: A mechanical tree planter. (Forestry Quarterly, vol. XII, p. 139-140. 1914.)

The tool weighs about 10 pounds and is approximately 38 inches in length. It is made of iron and steel throughout. The shaft and crossbar handle are constructed of inch tubing. Three strong bayonet-shaped knives are securely bolted to the lower part of the shaft and pass through a foot-rest at the lower end of the shaft and extend about 13 inches beyond. The knives are so arranged that they converge to a point with a triangular space between them. This space is about 1 inch in diameter with the exception of just beneath the foot-rest where it is about 3 inches wide.

In operating the tool the movement of a small lever (*c*) attached to the foot-rest raises one of the blades (*a*). The plant is inserted in the groove between the other blades and the first blade lowered to its former position. The roots lie in the triangular space with the crown in the wider space (*b*) beneath the foot-rest. The tool is now thrust vertically into the ground with the foot upon the foot-rest (*d*) until the flare in the blades is level with the surface. The opening made is triangular in shape, about 1 inch in diameter, and 10 inches deep. The tool is now turned to the right, and at the same time pressure is gradually applied to the lever (*e*) at the top of the handle. The pressure forces the blades apart. As the sharp edges of the blades are turned outward, the turning movement forces the soil inward about the roots.

A single workman can plant 2-year coniferous seedlings with this tool at the rate of from 75 to 100 per hour. The greatest objection to its use appears to be the uncertainty in the firming of the soil about the roots. On overwet soils, particularly clay, the soil sticks to the blades and the tool will not work at all.

11. PLANTING WITH TOOLS WHICH MAKE THE OPENING IN THE SOIL IN THE FORM OF A NOTCH OR SLIT.—The chief distinction between the methods of planting in notches or slits and those previously described is in the shape of the opening.

Several planting tools known under the name of planting ax and planting hatchet are in use in Europe (Fig. 122). These tools are the smallest and simplest of those used in opening a slit or notch in the soil in which the plant is set. With a swing of the arm the hatchet or ax is forced into the soil, and on its removal the plant is inserted in the notch. The opening is closed by forcing the earth at either side into it by 2 or 3 well-directed blows with the thick end of the tool. Sometimes the foot is used to compress the soil more completely about the roots

of the plant. These tools work best on loose or moderately loose, sandy or loam soils free from roots and stones and covered with little or no vegetation or litter. The most common form of planting hatchet weighs from 3 to 4 pounds and has a wooden handle from 12 to 16 inches in length. The blade is from 3 to $3\frac{1}{2}$ inches broad at the bit and from 7 to 9 inches long. This implement has been used to some extent in England and on the continent but not in the United States. Another form sometimes used in planting operations in Germany weighs about $3\frac{1}{2}$ pounds. On loose soil free from stones and roots the planting of small stock with this tool can be done with great rapidity. On the sandy soils of Prussia a workman will set on the average a thousand plants per

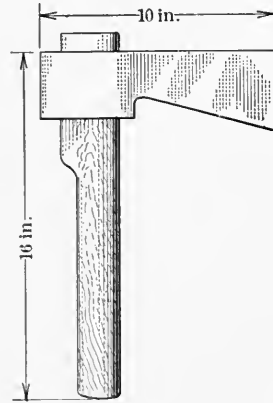

FIG. 122. — The planting ax.

day, including the lifting and transporting of the stock from the nearby nursery. Wagener¹ records the successful use of this tool in planting millions of 1- to 3-year conifers, both in the open and under an overwood.

The notch or slit into which the plant is inserted may be made with the ordinary spade or with special tools known as notching spades. When the ordinary spade is used it is thrust vertically into the soil to the desired depth and the notch enlarged by moving the handle backward and forward until the opening is sufficiently wide to insert the plant. One man is required to make and close the openings and another to insert the plants. The chief objection to this method of planting with the ordinary spade is in the form of the opening. Under the backward and forward movement of the spade it assumes more or less the form of an hour-glass, *i.e.*, comparatively wide at the top and bottom and constricted in the middle. It is extremely difficult to insert the plant properly and fill the opening afterward so that the soil comes in contact with all the roots. In closing the opening the spade is inserted 2 or 3 inches from the plant and the soil pressed forward about the roots. The foot may also be

¹ Wagener, Gustav.: *Der Waldbau und seine Forstbildung*. S. 419. Stuttgart, 1884.

used to compress the soil further and bring it into closer contact with the roots. In planting operations on a large scale it is difficult to supervise the work properly. The root mass is likely to be bent in the form of the letter U, with the root tips out of the ground. Even at best, the roots are spread out in a single plane. This method of planting is practical only on sandy soil free from stones and roots and on sites free from grass and other herbaceous vegetation. Three men working together, two making and closing the slits and inserting the trees, while the third man carries them, can, under favorable conditions, plant from 3000 to 5000 trees per day. When planting on dry sites, shallow furrows are usually turned and the slits opened in the bottom. This method has been used in the United States, particularly in the Kansas and Nebraska sand hills.¹

Where the soil is covered with a more or less continuous sod or is sufficiently stiff to hold together, the British method of notch-

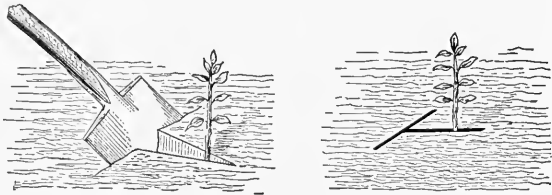

FIG. 123. — T-notching with the ordinary spade.

ing with the ordinary spade may be practiced² (Fig. 123). The spade is inserted vertically to the depth of 8 or 10 inches. It is then withdrawn and again inserted at right angles to the first insertion so as to form a T-shaped opening. By bending the spade backward a notch is opened. When sufficiently wide, the plant is inserted and the spade withdrawn. The earth settles in about the roots of the plant and is pressed down with the foot. When properly done and when the stock is not too large, rapid planting can be accomplished. Two men working together, one operating the spade and the other inserting the plants, can plant from 2000 to 2500 trees per day. This method permits the planting at suitable depth, in an upright position, and with the

¹ Bates, C. G. and Pierce, R. G.: Reforestation of the sand hills of Kansas and Nebraska. (U. S. Forest Service, Bul. 121, p. 40. 1913.)

² Schlich, Wm.: Manual of forestry. 4th ed., vol. II, p. 227. London, 1910.

soil firmly pressed about the roots. The chief objections are that the roots are spread out in a single vertical plane and the grass or other herbaceous vegetation is close about the inserted plant. It should be used only in humid regions where the young trees are able to compete with the surface vegetation.

Several notching spades have been devised to overcome the objection to the ordinary spade in making the opening for the reception of the plant. All of these are alike in that the blade is wedge-shaped, being much thicker at the top than at the bottom. Consequently, after its insertion in the soil, it is unnecessary to move the handle backward and forward to an appreciable extent in order to make the opening sufficiently wide to insert the plant (Fig. 124).

The spade is held in a vertical position and thrust into the soil, opening up a V-shaped cleft. The opening is closed about the inserted plant with the feet. One man is required to operate the spade and another to insert the plants and close in the soil about them. On loose, sandy soil free from stones and roots, two men working together will set from 2500 to 3000 plants in a single day. This tool has been used chiefly in Europe in setting 2-year seedling pine on sandy soil. It has been used in the United States only for experimental purposes.

Another type of notching spade has a straight handle and a triangular blade from 4 to 8 inches wide, 12 inches long, and terminating in a point. The cutting edges are sharp and easily penetrate the soil. The blade is made of pressed steel. This type of notching spade is considered superior to the ordinary spade because of the ease with which it can be thrust into the soil and the form of the opening made.¹ It permits of rapid and efficient planting when the stock is of suitable form and size and the soil favorable.

The planting lance and a number of special tools are in use for making the opening in the soil intermediate in form and size between that made with the dibble and the notching spade. They



FIG. 124. — The notching spade.

¹ Heyer, Carl: *Der Waldbau oder die Forstproduktenzucht*. 5. Aufl., 1. Bd., S. 357. Leipzig, 1906.

are all more or less spade-like but have a much thicker and narrower blade. They have been used in the United States for demonstration purposes only but merit a much more extended use for planting tap-rooted, broadleaved species and small conifers when conditions are favorable. The planting lance described by Baudisch¹ is fitted with a foot-rest by means of which it can be readily forced into the soil in the same manner as a spade. Among the better of this class of tools should be mentioned Prouvé's planting iron of French origin² and the Saxon planting iron with a broad foot-rest and narrow 3-edged blade (Fig. 125).



FIG. 125.—Planting iron with 3-edged blade.

Small plants may be planted very rapidly with either the grub-hoe or mattock without removing the soil from the opening. By two or three strokes of the tool the surface litter and herbaceous growth is cleared from an area 6 to 8 inches in diameter where the tree is to be planted. A deep thrust of the tool is made into the center of this spot sending the cutting edge to a depth of from 6 to 8 inches. By forcing the handle forward, the cutting edge with its load of soil is raised, opening up a crevice into which the plant is introduced with the left hand and the roots shaken down into the opening below the cutting edge of the tool. The tool is now withdrawn, and the plant brought upright in the center of the hole, as the earth falls in about the roots. When the work is carefully done, the trees are planted sufficiently deep, the roots are fairly well spread out, and only moist soil comes in contact with them. This is an admirable method for planting 2-year coniferous stock, such as pine and spruce, on loam or sandy soil. The work, however, should be closely supervised as the method permits of too shallow planting and the oblique setting of the plants when done by unskilled and careless workmen. This method of planting is much more rapid than ordinary hole plant-

¹ Baudisch, C.: Die Pflanzlanze. (Centralblatt f. d. gesamte Forstwesen. S. 312. 1879.)

² Mayr, Heinrich: Waldbau auf naturgesetzlicher Grundlage. S. 418. Berlin, 1909.

ing. It has been successfully practiced by the author for a number of years in planting 2-year white pine seedlings under an overwood.

The trencher method of planting, as developed in the progress of forestation in the sand hill regions of Nebraska and Kansas,¹ has proved more successful in that locality than other methods when cost is taken into consideration. It has been developed since 1909 and, consequently, has not been sufficiently tested to warrant a specific statement as to the range of conditions under which it can be successfully used. It is best adapted, however, for loose, sandy soils free from stones and roots.

In planting by this method, the area is first gone over with an ordinary breaking plough or a side-hill plow and furrows made at intervals of 4, 5, or 6 feet as desired.

The furrow is usually shallow, varying from 2 to 4 inches in depth. The trencher is run in the bottom of the furrow. It makes a continuous V-shaped slit approximately $4\frac{1}{2}$ inches wide at the top and



Photograph by U. S. Forest Service

FIG. 126.—Planting yellow pine by the trencher method. The first team is the plow team. The second is the trencher team. The men are planting in the V-shaped slit in the bottom of the furrow. Near Halsey, Nebraska.

¹ Bates, C. G. and Pierce, R. G.: Reforestation of the sand hills of Nebraska and Kansas. (U. S. Forest Service, Bul. 121, p. 41. 1913.)

from 8 to 10 inches deep. The planters move along the furrows, setting the plants in the slit at the desired points, usually at from 3- to 6-foot intervals (Fig. 126). The slit being continuous permits the bringing of the roots into a vertical position much more effectively than when it is 7 inches or less in length as is the case when made with a spade or with other hand tools. The plant is inserted with the left hand, and as soon as the roots are properly disposed the opening is closed with the foot or with the spade. In the latter case, the spade is held with the back to the plant and thrust the full depth of the blade vertically into the soil about $1\frac{1}{2}$ or 2 inches from the plant. By bringing the spade forward the soil is pressed against the roots and the opening closed. The planters are usually divided into crews of 3 men, 1 carrying the plants and 2 planting.

Two horses on the plow and 4 on the trencher prepare the soil as fast as 9 to 12 men can plant. The planters should follow as closely after the trencher as practicable, as the trees should be planted before the surface of the soil in the opening becomes dry. Plantations of western yellow pine in the sand hills of western Nebraska, planted with the trencher in 1911, had at the end of the first year after planting from 90 to 92 per cent of thrifty plants. Although this excellent result was partially due to the favorable season, it is believed by Bates and Pierce that planting with the trencher will prove more effective and less costly than any other method in the Kansas and Nebraska sand hills. Calculating the work of each horse based upon cost as two-fifths that of a workman, the planting of from 1000 to 1100 coniferous transplants is an average day's work of 8 hours. This is a remarkably high average for any method of setting out transplants.

The chief objections to the method are:

1. The deep layers of the soil in which the trees are planted are much less fertile than the surface layers, hence early growth is slow.
2. The roots are disposed in a single vertical plane as in planting with the notching spade or with similar implements.

On dry sites where the soil and soil cover are suitable, these disadvantages are often overbalanced by the following decided advantages:

1. The cost is lower than by most other methods of planting.
2. The roots are placed uniformly deeper in the soil.

12. Planting Operations in which the Opening is Made by Removing the Soil—Hole Planting.—Hole planting is applied to all methods of planting in openings made by removing the soil and piling it at one side. The planting hole is usually made with the ordinary spade, grub-hoe, or mattock. Many methods have been developed and are in use by different practitioners, all of which have for their object *economical and successful planting*. In general, the more adverse the site, the more costly must be the method selected for the regeneration. Etter¹ emphasizes the fact that the poorer the site the more care required and the higher the necessary cost of successful regeneration. He states that on extremely adverse sites even the most careful methods for setting naked-rooted plants are unsuccessful and that "ball" planting proves best and cheapest in the end.

The planting hole may or may not be made by the workman who sets the plants. Often the two operations are conducted by different workmen. In either case, however, the plants should usually be set as soon as practicable after the holes are dug or before the excavated soil has become overdry from exposure to the air. On sour soils, particularly peat soils, the planting holes should be made some months in advance of the planting in order to give the excavated soil an opportunity to "weather" and be in better condition as filling soil.

In setting the plant it is held between the thumb and forefinger of the left hand and lowered into the planting hole to the desired depth. The best soil is worked in between the roots with the right hand, after which the remainder of the filling soil is rapidly brought in about the plant with a suitable tool or with the hands. In filling the hole, special emphasis should be given to the following:

- a. Avoid bringing dry soil in contact with the roots.
- b. Avoid setting too deep.
- c. Avoid bringing litter and other undecomposed organic matter in contact with the roots.
- d. See that the mineral soil is in intimate contact with and is firmly pressed about the roots.

Although hole planting is usually much more expensive than planting with the dibble, notching spade, planting lance, and

¹ Etter, P.: Betrachtungen über die Bepflanzung der Schläge auf Süd- und Westhängen im schweizerischen Mittelland. (Schweizerische Zeitschrift für Forstwesen, S. 7-12. 1906.)

similar tools, it has many advantages and is more generally practiced. The more important of these advantages are as follows:

- a. It permits the use of stock of all sizes.
- b. The stock can be more uniformly set with the roots at the desired depth.
- c. It can be used on all classes of soil — on dry, wet, steep, and otherwise unfavorable sites.
- d. It permits the better distribution of the soil between the numerous roots in refilling the planting hole.
- e. The planting hole can be made below the general surface of the soil or raised on mounds above it in planting on overwet and dry soils.
- f. The roots can be arranged more nearly in their natural position before bringing in the filling soil.
- g. The work permits of closer supervision and consequently is better executed on the part of inexperienced workmen.
- h. On sites where the soil is very poor, it permits the adding of compost or enriched soil to the filling earth.

13. HOLE PLANTING WITH THE GRUB-HOE AND MATTOCK. — Most forest planting in the United States is done with the ordinary straight-handled grub-hoe (Fig. 127*a*). *It is the most useful planting tool known.* It can be used almost equally well under a wide range of soil and cover conditions and with various kinds and sizes of plant material. In the ordinary form of this tool the handle, which is made of wood, is approximately 36 inches long. The blade is from 8 to 12 inches long with a large eye at the upper end, through which the handle passes. It curves inward and gradually widens toward the cutting edge. This tool can be obtained with various widths and lengths of blade and weighing from 3 to 6 pounds. The ordinary stock grub-hoe with a straight handle, 4-inch width of blade, and weighing 4 pounds is the form most commonly used. A grub-hoe with a slightly curved or bent handle and straight blade is an improvement over the ordinary stock tool and is the form most largely used in European practice. It permits the making of the planting hole with sides more nearly vertical. By placing the blade of the ordinary stock tool in the forge, it can be straightened so that it is more nearly at right angles with the curved handle which should replace the straight one.

The ax-mattock differs from the grub-hoe in being much heavier and in having an additional blade for cutting brush and roots that interfere with the digging of the planting hole (Fig. 127*b*). It is much more cumbersome and more difficult to manage in planting and should not be used except on sites where brush and roots make the use of the grub-hoe impracticable. On glacial drift and other exceptionally stony soils, the ax-mattock should be replaced with the pick-mattock, as it facilitates the loosening of the stones uncovered in making the planting hole (Fig. 127*c*).

Both the grub-hoe and mattock are rapidly dulled in the proc-

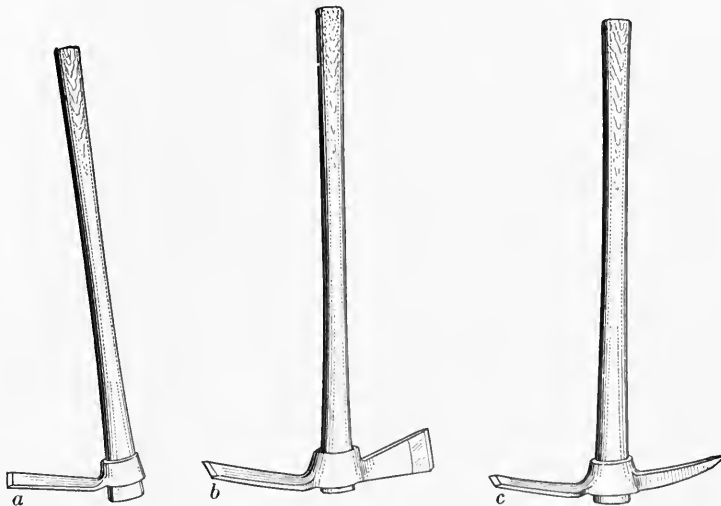

FIG. 127.

a. Grub-hoe.

b. Ax-mattock.

c. Pick-mattock.

ess of planting, particularly if the ground is stony. Each workman should carry an 8- or 10-inch flat file in order to keep the planting tool in the best condition for effective work. On large operations all tools should be sharpened on an emery wheel each morning or evening. If the blade has been worn down to a length of 7 inches or under, it should be either discarded or taken to a blacksmith and drawn out to its former length.

The cost of hole planting with the grub-hoe and mattock depends upon the experience of the workmen, the character of the site, and the form and size of the stock. On moderately loose

soils, fairly free from stones, roots, and soil cover, a maximum of 1000 plants can be set by 1 workman in a day of 9 hours. Under adverse soil conditions and with transplanted stock, this may be reduced to 250. From 500 to 600 coniferous transplants is the average number that can be planted in 1 day.

In conducting a planting operation where the plants are set in holes made with the grub-hoe or mattock, the planting crew is usually divided into units of 2 men each, with a foreman over each group of 5 to 10 units. One workman in each unit digs the



Photograph by C. R. Pettis

FIG. 128. — Planting white pine (2-1) on a lumbered and burned area in the Adirondaek Mountains, New York.

holes and the other follows with a pail or basket of seedlings or transplants and sets the plants, filling in the earth about the roots with a trowel or with his hands and firming it with his feet (Fig. 128). Although the 2-man unit is most usually employed in planting with the grub-hoe or mattock, better results can often be attained with 1, 3, or more men in the planting unit, the size varying with the character of the cover and the condition of the soil.

On areas covered with dense, high brush the cover impedes the

workman digging the holes more than it does the planter. Compact, stony soils also check the rapidity with which the planting holes can be made. On favorable sites where there is little or no surface vegetation and the soil is loose and free from stones, 1 man digging holes can usually keep 2 planters busy. On unfavorable sites where the soil is compact and overrun with brush and other surface vegetation, 1 workman will dig the holes no faster than a single planter will set the trees. The size of the planting unit should ordinarily be as follows: Under adverse cover or soil conditions there should be 1 man to dig the holes and 1 to plant; under favorable cover and soil conditions there should be 1 man to dig the holes and 2 to plant; and under intermediate conditions there should be 2 men to dig the holes and 3 to plant.

The Department of Forestry of the State of Pennsylvania has planted several million trees annually within the past decade. Successful regeneration has been attained at a cost below \$10 per acre by planting seedling stock. Transplants are seldom used and only in limited quantity.¹ Thus in the spring of 1915, of 4,329,321 trees planted less than one-eighth were transplants. The average cost per thousand for planting was \$2.96, while the average cost per acre for new plantations was \$8.61. The latter includes the cost of the stock and the cost of planting. The comparatively low cost for effective planting is due to the use of seedlings and efficiency in planting operations.

The effective organization of the planting crew is recognized as one of the most important tasks in a planting operation.² A poorly organized crew is difficult to handle; the work is poor in quality and high in cost. The number of men in the planting crew varies from operation to operation and from day to day in the same operation, hence the plan of organization is flexible. The crew is organized on the basis of planting units. If small the planting crew may comprise but one unit. A planting crew of more than three units is unwieldy. A planting unit should ordinarily include the following workmen:

¹ Report, Pennsylvania Dept. of Forestry, p. 142. 1911.

² The author is indebted to Prof. J. S. Illick for the account of the organization of the planting crews in planting on the Pennsylvania state forests.

| | | | |
|------------------------------|-----------|-----------|-----------|
| Grub-hoe or mattock men..... | 5 | 4 | 6 |
| Plant distributors..... | 1 | 1 | 1 |
| Planters..... | 5 | 4 | 6 |
| Foremen..... | 1 | 1 | 1 |
| Total..... | <u>12</u> | <u>10</u> | <u>14</u> |

The above shows the general plan of organization. In many operations it is advisable to have 1 or 2 extra planters. In extreme cases where the holes are easily dug and the planting is difficult it is sometimes desirable to have 2 planters for each man with a grub-hoe or mattock. Although 1 plant distributor is usually sufficient for a planting unit of 10 to 14 men, if the area is covered with scrub oak or similar cover or if several species are planted in mixture, 2 plant distributors are necessary. Experience has shown that a planting crew of 2 units, *e.g.*, 20 to 28 men, is the most efficient as it can be handled by a single foreman. In organizing the planting unit the grub-hoe or mattock men should form a diagonal line in proceeding across the planting site (Fig. 129). The planters should proceed in a straight line at right angles to the direction of planting. The plant distributor moves back and forth in front of the line of planters and drops a plant at each hole just before it is needed for planting. The foreman should insist that the plant distributors keep the roots moist and that the plants are not dropped too far in advance of the planters. It is necessary for the planters to be in a straight line at right angles to the direction of planting in order that the plant distributor can easily supply them with fresh plants.

The effort of the foreman should be not only to plant the trees well but to plant them economically. *The cost of planting depends largely upon the position of the men in the planting unit.* The best workers should be placed at the end positions. The 2 end or outside grub-hoe or mattock men should be not only good but also steady workers, as they lead the planting unit. A leader who attempts an over-rapid pace is as objectionable as one who tends toward the other extreme.

On favorable sites the entire operation from the digging of the planting hole to the setting of the tree is often done by a single workman. The chief objection to the 1-man unit when a large number of planters are employed is the difficulty in securing adequate supervision. The desired spacing distance cannot be so

14. HOLE PLANTING WITH THE CYLINDRICAL SPADE. — On soils sufficiently free from stones and roots the planting hole is sometimes made with the cylindrical spade (Fig. 112). This spade is used chiefly in planting long-rooted, deciduous species with weak lateral roots. The tool is thrust vertically into the soil and on its removal a column of earth from 3 to 5 inches in diameter and from 8 to 10 inches in depth is removed with it. In inserting the spade

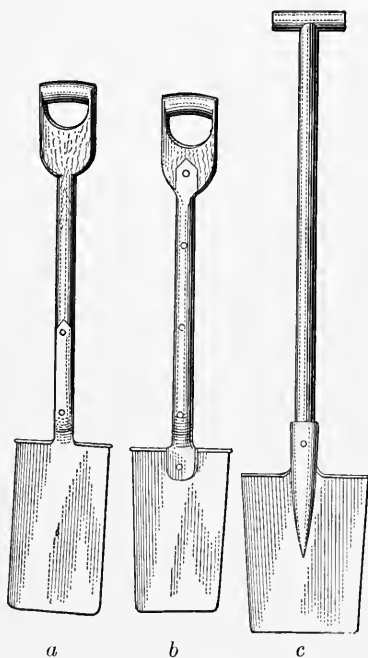

FIG. 130. — Types of spades used in hole planting.
a. Stock spade with short handle.
b. Heavy spade with reinforced handle.
c. Planting spade of German origin.

for the second hole, the column of soil from the first hole is ejected at the top and becomes the filling soil for the second hole. As the holes are narrow and correspondingly deep, special attention must be given to refilling them. As the soil is piled close to the hole the best of it can be brought into contact with the roots as the tree is planted. A 2-man unit is employed in this method of planting. One workman digs the hole and a second man follows the digger, setting the tree by holding it with the left hand at the desired depth in the center of the hole and filling in the soil about the roots with the other hand. This method of planting can be used only on loose loam or sand free from stones and roots. From 400 to 600 coniferous transplants (2-1) can be planted by each workman in a day.

15. HOLE PLANTING WITH THE ORDINARY SPADE. — Under suitable conditions of soil and cover the ordinary short-handled or long-handled spade can be used advantageously in hole planting. When the planting stock is large and the roots long a deep hole is necessary. When the hole is made with the grub-hoe or mattock an excessive amount of soil must be removed in order that it may have sufficient depth. This can be obviated by digging the hole with the spade (Fig. 130).

The usual method of spade planting is setting the plants in square holes.¹ The spade is inserted in a vertical position on the 4 sides of the soil to be removed. When completed, the hole is square in cross section, usually from 6 to 8 inches on a side, and from 7 to 12 inches deep, depending upon the size of the plants. Planting with the spade in square holes is not suited for compact, heavy soils, neither can it be practiced on soils filled with rocks or roots. Two-man planting units are necessary. One workman goes ahead digging the holes at the desired intervals.

The removed earth is placed adjacent to the hole so that the best filling soil can be quickly brought into contact with the roots in setting the plants. The second workman follows immediately after the workman digging the holes and plants the trees. The excavated soil should not be permitted to become dry before the trees are set. The tree is lowered into the center of the hole with the left hand slightly below the position that it will occupy when planted. The best filling soil is gradually brought into contact with the roots and at the same time the

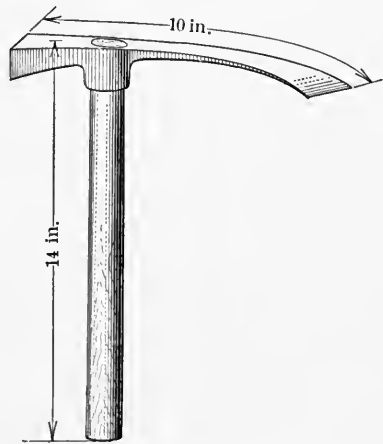

FIG. 131.—Planting hammer for planting small coniferous trees in the field.

tree is raised to the desired position. The roots are spread and the soil pressed about them with the right hand. The remainder of the soil is now filled in either with the hand or with the trowel and adequately compressed with the feet. From 300 to 400 coniferous transplants, 3 or 4 years old, can be planted by each workman in a day.

16. HOLE PLANTING WITH THE PLANTING HAMMER AND SIMILAR TOOLS.—The planting hammer has not been used in the United States but is often used in Europe for planting small stock when a shallow planting hole will suffice (Fig. 131). It is particularly useful in planting 1- and 2-year seedling conifers on cultivated

¹ Bates, C. G. and Pierce, R. G.: Reforestation of the sand hills of Nebraska and Kansas. (U. S. Forest Service, Bul. 121, p. 41. 1913.)

strips on loam and sand free from roots, stones, and surface vegetation. The tool is made of steel fitted with a straight wooden handle from 12 to 16 inches long. The metallic part is from 8 to 10 inches in length with a blade on one end and a flat surface for hammering on the other. The blade is slightly curved and $1\frac{1}{2}$ inches wide at the cutting edge. The tool weighs approximately $2\frac{1}{2}$ pounds. The planting crew is arranged in 1-man units. The planting hole is dug with from 1 to 4 strokes of the hammer which is held in the right hand and the soil is piled at one side. The plant is held between the thumb and forefinger of the left hand and lowered to the desired depth in the hole. The filling soil is brought in about the roots with the blade of the tool and the earth firmed by 2 or 3 strokes of the tool.

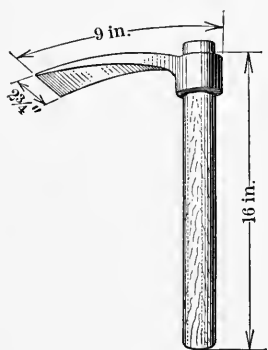

FIG. 132. — Short-handled grub-hoe.

A tool somewhat similar to the planting hammer is extensively used on some of the National Forests. It is known as the short-handled grub-hoe. It is made of pick steel and is fitted with a straight or slightly curved handle 16 inches long. The form of the tool is very similar to that of the ordinary grub-hoe (Fig. 132). It is, however, much smaller and lighter. The total length of the blade including the eye through which the handle passes is only 8 or 9 inches and the cutting edge is only $2\frac{3}{4}$ inches in width. Its weight, including handle, is about 2 pounds. In using this tool the planting crew is arranged in 1-man units, each workman carrying the plants in a waterproof canvas bag attached to his belt and supported from the shoulder.

As each planter carries his own trees in a shoulder bag, there is no lost motion in setting down or picking up pails or baskets. No time is lost in adjusting the differences of speed between the men digging the holes and those setting the trees as is common when planting in 2- or 3-man planting units. The spots selected for the holes are very carefully chosen since the man who digs the hole must plant the tree.

This method has been used successfully in District 1, U. S. Forest Service, particularly in planting small conifers on fresh, loose soil, free from heavy sod. The number of trees planted per

man in 9 hours when working in 1-man units varies from 1000 to 1300 depending upon the size of the stock and the character of the soil and cover. This is from 30 to 50 per cent more than the number planted per man in the same locality when working with the ordinary grub-hoe in 2-man units.

17. Receptacles for Plants in Field Planting

Several kinds of receptacles are in use for carrying plants in field planting (Fig. 133). The pail and basket are extensively used for this purpose in the United States. The ordinary 16-quart pail of galvanized iron is more widely used than any other receptacle, when the roots are kept in water or in a puddle of mud. The pail is partially filled with water or thin mud and the trees placed therein in an upright position.

Strong, well-constructed baskets of the size and form of the ordinary market basket are also largely used. The baskets should be approximately 7 inches deep, 12 inches wide, and 22 inches long. The bottom of the basket is covered with wet sphagnum moss and the trees placed thereon in a horizontal position. The roots are covered with damp moss. So far as the protection of the stock is concerned there is no better method for carrying trees

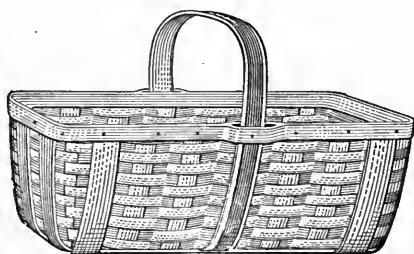

a

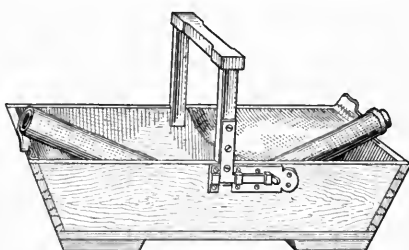

b

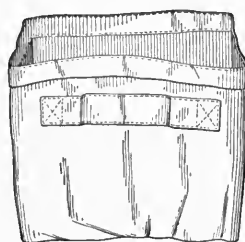

c

FIG. 133. — Receptacles for plants in field planting.

- a.* Planting basket.
- b.* Spitzenberg planting box.
- c.* Planting bag.

in planting operations. Care should be taken to keep the roots well covered with moss as the trees are removed one at a time for planting. More durable baskets made to order from metal are used in District 4, U. S. Forest Service.

Spitzenberg¹ has designed a plant box for carrying small plants in field planting. The handle is made to swing back on a hinge in order to be out of the way in filling the box with plants. Pieces of heavy cloth attached to the sides are arranged to swing over the top and protect the roots from wind and sun. The box is shallow with sloping ends to permit the easy removal of the stock as required for planting. The inside dimensions are approximately as follows: height, 4 inches, breadth .12 inches, and length at top 20 inches reduced to 16½ inches at the bottom due to the sloping sides. The author has used this box but does not find it superior to the pail or basket.

Various kinds of bags constructed from heavy canvas or waterproof material are often used for carrying small stock in planting operations. A canvas bag 12 inches high and approximately 12 inches in diameter with a heavy strap handle has replaced the pail and basket on some of the National Forests. This bag holds from 500 to 2000 coniferous plants of the size ordinarily used in planting. Damp moss is placed in the bottom of the bag and the plants placed in an upright position on the moss. The advantages claimed for the bag over the pail and basket are its lightness and the ease of handling. A smaller bag arranged for attaching directly to the belt of the planter has met with increasing use in recent years. It is usually provided with a shoulder strap for support and a clasp that holds it firmly to the belt on the left side and out of the way of the free movement of the arms in planting.

The latter form of bag is provided with a waterproof lining so that the roots of the stock can be kept moist without wetting the planter. It holds between 1400 and 1500 yellow pine seedlings (2-0) or between 500 and 600 yellow pine transplants (1-2).

18. Special Planting Methods

Every practitioner must fully appreciate that the method to pursue in planting is the one that gives the best results at the least cost. He must fully appreciate that all methods that have

¹ Spitzenberg, G. K.: Die Spitzenberg'schen Kulturgeräte. 2. Aufl., S. 90. Berlin, 1898.

proved useful in the past and have met with extensive use either in this country or abroad are worthy of consideration. The author in describing the following special planting methods, all of foreign origin, does not believe that they should be extensively used in this country. He does believe, however, that they should be known by practitioners in the United States in order that advantage may be taken of whatever special merits they possess either in reducing the cost of planting or in making success more certain. The more important of these special methods are as follows:

- a.* Biermann's planting method.
- b.* Grohmann's planting method.
- c.* Alemann's planting method.
- d.* Manteuffel's planting method.
- e.* Cone planting method.
- f.* Kozesnik's planting method.
- g.* Splettstösser's planting method.
- h.* Oblique planting.

19. BIERMANN'S PLANTING METHOD

This is a method of hole planting that has met with considerable favor in Europe on certain types of soil and with certain species. It has not been used in the United States. Field planting under this method is carried on as follows: The planting hole is dug more or less symmetrical in form so as to facilitate planting. It can be made with any suitable implement but preferably with the spiral borer or with the semi-circular spade. In operating the borer it is gradually forced into the ground by rotating it from right to left. The hole is from 8 to 10 inches deep and two-thirds as wide. In the operation of planting, compost, turf ashes or other fertilizing material is added to the filling soil which is distributed over the area at suitable points before the planting is begun. In setting the plant a handful of the prepared soil is pressed against one side of the hole. The plant is taken in the left hand just above the collar and the roots brought into contact with the prepared soil in the hole and a second handful brought over and pressed against them. The best of the excavated soil is now brought into the hole and finally the remainder. A vigorous downward pressure of the boot heel at the outer margin of the hole is necessary in order properly to compress the soil (Fig. 134).

This method is useful on very poor soils where plants are slow to start after planting. It entails considerable additional expense due to the cost of the preparation of the enriched filling soil and its transport and distribution. Its advantages are in the rapid

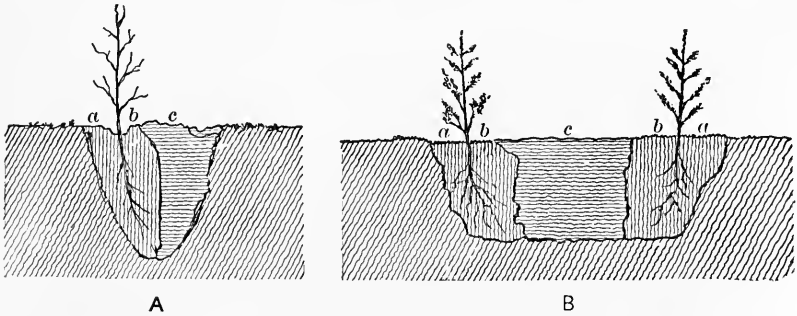

FIG. 134. — Biermann's planting method.

- A. Setting 1 plant in the hole. B. Setting 2 plants in the hole.
a. Enriched sod against the side of hole.
b. Enriched sod against the roots.
c. Excavated soil, replaced.

growth of the plants immediately after planting and a diminished loss from summer drought during the first year.¹ The method is simple, suited for all kinds of plants, and can be used on various sites. Its comparatively high cost hardly justifies its introduction into the United States except under special conditions where cost is a secondary consideration.

20. GROHMANN'S PLANTING METHOD

Another method which has for its object the placing of the best filling soil about the roots has been described by Grohmann under the name "overthrow culture." A planting hole is made with a spade and the removed surface soil laid beside the hole. A second hole is then made and the surface soil with its humus content is thrown each time into the bottom of the previously made hole. In planting, the roots are brought into contact with this rich surface soil. When this method is practiced the surface soil must be moist. The lower soil is used to fill the upper portion of the planting hole.²

¹ Gayer, Karl: *Der Waldbau*. 4. Aufl., S. 364. Berlin, 1898.

² Mayr, Heinrich: *Waldbau auf naturgesetzlicher Grundlage*. S. 421. Berlin, 1909.

21. ALEMANN'S PLANTING METHOD

This method is sometimes used abroad in planting on sod and is also used to a limited extent in the United States. The planting hole is quadrangular in form and the sod is cut through on three sides over a space from 10 to 12 inches square and turned back on the uncut side (Fig. 135). The soil beneath is thoroughly loosened and the plant inserted in the center of the planting hole with the roots spread in their natural position and with the best filling soil about them.



FIG. 135. — Alemann's planting method.

- a. Inverted sod split through the middle.
 b. The tree planted and the sod ready to be replaced.

The inverted sod is cut into two pieces on a line with the tree, brought back into its original position and thoroughly firmed with the feet.¹ The sod is sometimes completely removed, cut into two pieces, and inverted about the plant. It serves as a mulch and keeps the soil beneath from becoming overdry.²

22. MANTEUFFEL'S PLANTING METHOD

Planting on previously constructed ridges or mounds has from early times been recommended for wet areas and on frosty sites. The object is to raise the plants above the standing water and away from the bad effects of the frost. The disadvantages in this method of planting are its high cost, the danger of injury from drought during dry weather and from ants and other injurious insects that make their nests in the upraised soil. The mounds or ridges are made in the autumn and the trees planted the following spring. Manteuffel's planting method was developed for planting shallow-rooted species on ordinary upland soils. It

¹ Heyer, Carl: *Der Waldbau oder die Forstproduktenzucht*. 5. Aufl., 1. Bd., S. 359. Leipzig, 1906.

² The term "sod planting" is often applied to planting on inverted sods. This method is sometimes useful in planting on wet, level ground overgrown with grass. The sod is removed in squares from 10 to 12 inches on a side and inverted. Several months later, after it has had time to decay, the trees are planted in the inverted sods.

has been used chiefly in Europe in planting 2- and 3-year spruce on poor soils. This method includes three more or less distinct operations—namely, the formation of the mound, setting the plant, and covering the mound (Fig. 136).

The soil for the formation of the mound is usually obtained elsewhere. This culture soil should be rich loam or soil that has been enriched by the addition of ashes, compost, or other fer-

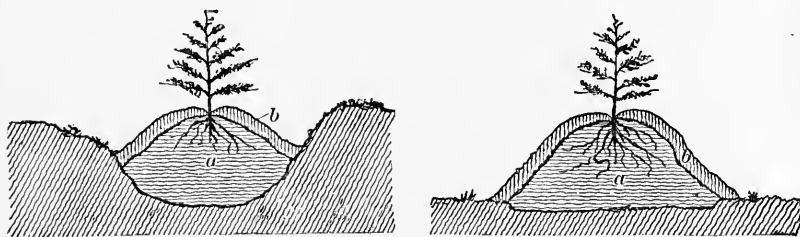

FIG. 136. — Manteuffel's planting method.

a. Enriched or ordinary filling soil.

b. Sod cover.

tilizers. The amount required for the formation of the mound depends upon the size of the plant. For very small plants 375 cubic inches of culture earth will suffice; for large plants four times this amount may be necessary. The culture earth is distributed some time before the trees are set. It is conveyed in buckets or strong baskets, each of which holds the requisite amount for the formation of one mound. It is deposited in regular, cone-shaped heaps at the places where the trees are to be planted. In cases where a growth of weeds, other vegetation, or excessive litter interferes with the formation of the mounds, it should be cleared away. In some instances, the culture soil is obtained by scraping the ordinary surface soil together into small heaps at regular intervals.

The workman in setting the plant opens the loose earth of the mound with his hand and inserts the plant with the roots spread out at the base of the mound, and fills in the soil so that the mound retains its former symmetrical form. As soon as the tree is planted, the mound is covered with sod, moss, or other litter. When covered with sod, two crescent-shaped pieces of suitable size are cut from the surface soil near the mound. When the mound is large, more than two pieces may be necessary. One piece is inverted and placed on the north side of the mound; the remaining

sod or sods are now brought over the south side, the edges well overlapping those of the first. This arrangement, when properly executed, gives the soil beneath the greatest protection from becoming overdry in summer. The stem of the plant rises from the top of the mound between the edges of the overlapping sods.

This method of planting is very costly. An average day's work including the distribution of the culture soil, the formation of the mounds, the setting of the plants, and the covering of the mounds, permits the planting of from 90 to 120 trees. Under this culture, however, growth is very rapid with most shallow-rooted trees, and excellent results have been obtained in Europe even in exceptionally dry years.

Although special tools have been constructed in Europe for use in this method of planting, ordinary planting implements, such as the grub-hoe and spade, may be used in forming and covering the mounds. The chief advantages claimed for this method are as follows:¹

a. The decayed grass and forest weeds just beneath the roots of the plant provide a rich source of nourishment for its early development.

b. The application of the culture soil promotes early growth and later development of the plant, owing to its contained ashes and other fertilizing materials and because of its physical condition.

c. The mound soil remains moist for a long time owing to its sod cover. The evaporation of the contained water is very slow through the thick mulch. Furthermore the soil in the mound is warmer than is the case with soil not raised above the general level.

d. The plants are exposed to much more light when on mounds than is likely to be the case when set by ordinary methods or in pits.

Leaving the mound uncovered after planting reduces the cost by one-half but owing to the rapid drying out of the soil is unsafe under most conditions.

This method is best adapted for coarse, gravelly or hard clay soils that under ordinary methods of planting are almost certain to give poor results.

¹ Manteuffel, F. von: Ueber das Verhalten der Hügelpflanzungen. (Allgemeine Forst- u. Jagd-Zeitung, S. 85-89. 1861.)

23. CONE PLANTING METHOD

In the cone planting method (Fig. 137) the planting hole is made in the ordinary way with the spade or grub-hoe, the earth being piled at the side.¹ The planter takes the plant in his left hand and with the right builds a small cone-shaped mound in the

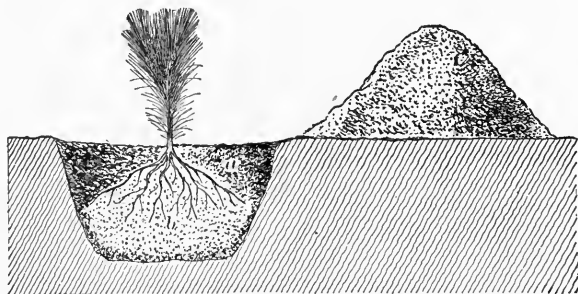

FIG. 137. — Cone planting method.

bottom of the hole (*b*). For this purpose only the best soil is used. A trowel is sometimes used to build the mound. The plant is brought down over the mound and the roots extended over its surface, the right hand being used to arrange them. By means of a trowel, or hand hoe, or with the bare hand, more of the best filling earth is now brought over the roots (*a*), then the remainder of the soil (*c*) is added and the whole thoroughly firmed down with the feet. Moss, litter, or stones can be advantageously brought over the filling soil after it has been firmed down. This method is adapted only for plants with spreading and shallow roots. It is an excellent method for planting spruce and permits of moderately rapid execution.² An experienced workman should prepare the holes and set from 200 to 400 plants per day, depending upon their size. The chief advantages of this method are the better disposition of the roots in the soil and the bringing of the best filling soil into contact with them.

This method has been used with success in planting under the

¹ Bates, C. G. and Pierce, R. G.: Reforestation of the sand hills of Nebraska and Kansas. (U. S. Forest Service, Bul. 121, p. 41. 1913.)

² Heyer, Carl: Der Waldbau oder die Forstproduktenzucht. 5. Aufl., 1. Bd., S. 336. Leipzig, 1906.

adverse conditions present in the sand hills of Nebraska, but the greater cost as compared with the trencher method has not justified its introduction further than for experimental purposes.

24. KOZESNIK'S PLANTING METHOD

A method of hole planting made known by Moritz Kozesnik¹ has met with marked success in Austria and elsewhere in Europe. By this method, field planting with 1- to 3-year stock such as is usually used in silvicultural work is carried out as follows (Fig. 138).

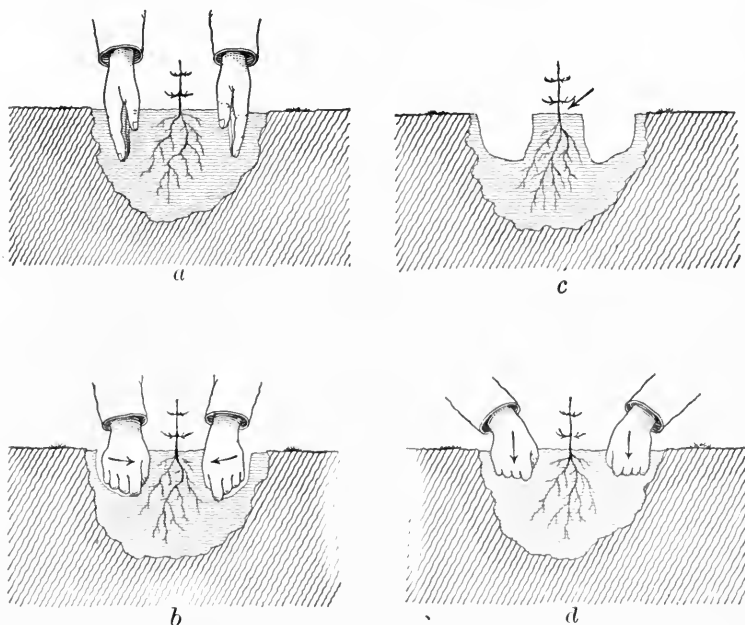

FIG. 138. — Kozesnik's planting method.

The planting hole is opened up with the spade or grub-hoe a little deeper than the greatest length of the roots. The planter who follows immediately behind the workman opening up the holes holds the plant in his left hand just above the root collar and lowers it until the roots reach the bottom of the hole. The best of the filling earth is thrown in with the right hand. For this operation a trowel or small hand hoe may be used. While the

¹ Kozesnik, Moritz: Die neue Pflanzungs-Methode im Walde. 3. Aufl. Wien, 1908.

earth is being thrown in, the left hand is gradually raised until the plant is brought to the proper height, *i.e.*, until the collar is brought level with the surface. This operation allows the larger roots to assume a vertical position with their absorbing surface deep in the soil. After the hole is filled with loose earth, the plant is released and both hands thrust deep into the loose soil, one at either side of the stem and about 2 inches from it, the open palms facing the tree (*a*). The hands are closed in their position in the soil, and the earth compressed horizontally about the upper part of the root system (*b*). The hands are removed, leaving an elevated mass of earth with empty spaces at either side (*c*). These are filled with earth and the closed fists brought down upon them, pressing the soil vertically. This firms the soil about the lower parts of the root system (*d*). Care should be taken not to apply the downward pressure too near the stem so that the tree is disturbed in its position in the soil. The hollows left by the downward pressure are later filled with soil. Loose earth should then be scattered about the plant.

Only well-developed, thrifty nursery plants should be used, and the soil should be in suitable condition as to soil moisture. Experience has demonstrated that when this method is properly executed it results in a healthy and vigorous plantation. It demands that the root system be handled with great care in lifting and transplanting the stock. The trees develop in a uniformly pressed soil which stimulates the capillary movement of water, and the loose earth at the top retards evaporation. Some experience is required on the part of the workman before rapid planting can be attained. Under average conditions with experienced labor, a single workman will set from 200 to 300 plants per day, including the digging of the holes. On adverse sites when ordinary planting methods have resulted in excessive loss, this method has met with considerable favor in Austria.

25. SPLETTSTÖSSER'S PLANTING METHOD

This method is of recent German origin. It has been used with success in planting 1- and 2-year pine and deep-rooted broad-leaved species like oak. It was devised by Splettstösser¹ to overcome the disadvantages of slit-planting and dibble-planting and,

¹ Splettstösser, Forstmeister: Einfluss unserer Kulturmethoden auf das Absterben der Kiefer. (Zeitschrift f. Forst- u. Jagdwesen, S. 689-711. 1908.)

at the same time, permit the plants to be set at comparatively low cost on uncultivated soil.

Three separate tools are required in planting by this method: namely, the borer, the plant holder, and the tamper. The borer is about 3 feet long with a cylindrical boring base in two parts that open by a movement of the handles (Fig. 139). The latter work like a pair of scissors. The diameter of the cylinder is from 4 to 8 inches, depending upon the size of the trees to be planted. The tool is applied vertically to the soil with a boring motion. It is turned several times to the right, only a small amount of force

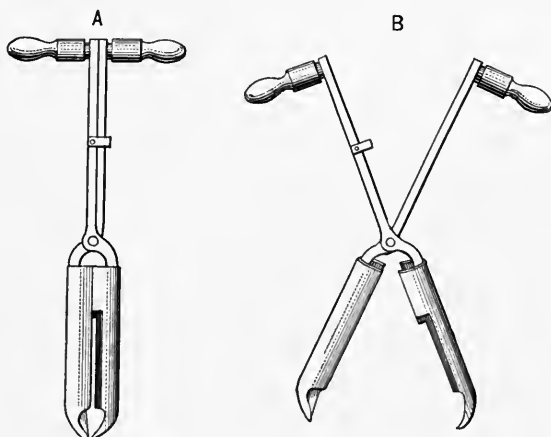

FIG. 139. — Splettstösser's planting borer.
A. Closed. B. Opened.

being required. The hole is made as deep but not deeper than the length of root of the tree to be planted. When the desired depth is reached, the borer is removed with the contained soil, which by a movement of the handles is released in a compact pile by the side of the hole. The plant holder insures the proper depth of planting and the setting of the plant in the center of the hole. When the holder is not used, the plant is held in the left hand while the earth is brought in about the roots with the right. When the holder is used, both hands are free to bring in the filling soil and firm it about the roots. The planting hole is so narrow in proportion to its depth that a special firming tool is used in firming the soil. This tool is made of iron with the exception of the handle which is of wood. After the hole is partially filled, the tamper is used to firm the soil close to the wall of the hole, leaving

the soil in the center somewhat loose. A second tamping is done when the hole is nearly filled, and after filling the soil is firmed with the hands.

Although the above appears to be a complicated procedure, when adequate precision is attained in all parts of the manipulation not only are the trees well planted but the work is rapid. Kranold reports the experience in 74 plantations in West Prussia where the cost of making the holes and setting the plants was from \$0.21 to \$1.23 per thousand plants. Based upon wages in the United States the cost should not exceed from \$0.85 to \$4.50 per thousand.

An experienced workman can make 180 holes per hour on open, sandy soil free from stones and grass. The work slows down rapidly with adverse cover and soil conditions. The method is impractical on sod and on heavy loam and clay soils. Under ordinary conditions 1 workman will make the holes as fast as 2 can plant. Although this method of planting has not been practiced in the United States, it has been favorably received by many European foresters. Möller¹ states that *unquestionably it is technically perfect and approaches as near as possible the ideal of pine planting. Its most significant advantage is the cheapness of its work.*

The tool is made in three sizes which bore holes about 4, 6, and 8 inches in diameter. A hole 4 inches in diameter is large enough for 1- and 2-year seedling pine. The larger tools are required for transplants.

26. OBLIQUE PLANTING

Oblique planting has been practiced to some extent in Europe but not in the United States. In this method of planting the trees are set at an angle of from 30 to 60 degrees from the vertical. As usually practiced, an oblique opening is made in the soil with an iron bar or planting iron, the plant inserted, and the opening closed with the feet. Prouvé's planting iron is used chiefly for making the opening (Fig. 140). The chief advantage in this method of planting is the ease and thoroughness with which the soil is firmed about the roots. The chief objections are the shallowness with which the plants are set and the sloping position of the young trees. Oblique planting permits the plant-

¹ Möller, A.: Versuch zur Bewertung von Kiefernplanzmethoden. (Zeitschrift f. Forst- u. Jagdwesen. S. 629-633. 1910.)

ing of the trees with the least disturbance of the soil, which is an advantage on sloping sites where the soil is likely to wash away when disturbed and loosened by ordinary planting methods. This method has been successfully employed in planting small

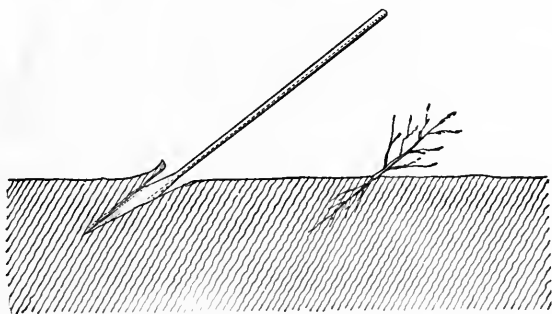

FIG. 140. — Oblique planting.

seedling beech under cover in some parts of France and Germany.¹ It is a rapid and inexpensive method of planting but subjects the plants to heavy loss except on sites where abundance of moisture is retained in the surface soil. It succeeds better in underplanting than on open sites. Perona² states that large hardwood stock can be successfully planted by this method when the soil conditions are favorable. Emeis³ recommends this method for planting 1- and 2-year seedlings in ordinary planting holes made with the spade or grub-hoe. The hole is made with one side sloping about 30 degrees from the vertical and the plants are inserted with the roots against this side. The earth is filled in and firmed with the feet. It permits the setting of the plant quickly without bending or doubling back the roots which is likely to occur in vertical planting unless special care is taken. It also permits the firming of the soil quickly about the roots.

Most foresters object to oblique planting because of the sloping position of the tree and the possibility of its affecting the straightness of the timber. This objection has little importance in planting on high mountains for protection purposes.

¹ Mayr, Heinrich: *Waldbau auf naturgesetzlicher Grundlage*. S. 421. Berlin, 1909.

² Perona, C. V.: *Economia forestale*. p. 85. Milan, 1892.

³ Emeis, Forstdirektor: *Die Schragpflanzung im Forstbetriebe*. (*Allgemeine Forst- u. Jagd-Zeitung*, S. 185. 1899.)



THE BOTANICAL NAMES OF SPECIES APPEARING IN THE TEXT

- Alder (*Alnus glutinosa*, Gaertn.).
Amabilis fir (*Abies amabilis*, Forbes).
Arbor-vitæ (*Thuja occidentalis*, L.).
Arizona cypress (*Cupressus arizonica*, Greene).
Austrian pine (*Pinus laricio*, Poir.).
Bald cypress (*Taxodium distichum*, Rich.).
Balsam fir (*Abies balsamea*, Mill).
Basswood (*Tilia americana*, L.).
Beech (*Fagus americana*, Sweet).
Big tree (*Sequoia wellingtonia*, Scem.).
Bitternut hickory (*Hicoria minima*, Britt.).
Black ash (*Fraxinus nigra*, Marsh).
Black cherry (*Prunus serotina*, Ehrh.).
Black gum (*Nyssa sylvatica*, Marsh).
Black locust (*Robinia pseudacacia*, L.).
Black oak (*Quercus velutina*, Lam.).
Black spruce (*Picea mariana*, B., S. & P.).
Black walnut (*Juglans nigra*, L.).
Blue gum (*Eucalyptus globulus*, Labill.).
Blue spruce (*Picea parryana*, Sarg.).
Box elder (*Acer negundo*, L.).
Buckeye (*Æsculus octandra*, Marsh).
Bur oak (*Quercus macrocarpa*, Michx.).
Butternut (*Juglans cinerea*, L.).
California red fir (*Abies magnifica*, A. Murr.).
Catalpa (*Catalpa speciosa*, Engelm.).
Cherry birch (*Betula lenta*, L.).
Chestnut (*Castanea dentata*, Borkh.).
Chestnut oak (*Quercus prinus*, L.).
Cottonwood (*Populus deltoides*, Marsh).
Coulter pine (*Pinus coulteri*, D. Don.).
Cucumber tree (*Magnolia acuminata*, L.).
Dogwood (*Cornus florida*, L.).
Douglas fir (*Pseudotsuga mucronata*, Sudw.).
Eastern hemlock (*Tsuga canadensis*, Carr.).
Engelmann spruce (*Picea engelmannii*, Engelm.).
European ash (*Fraxinus excelsior*, L.).
European beech (*Fagus sylvatica*, L.).
European birch (*Betula alba*, L.).
European larch (*Larix larix*, Karst.).

- Grand fir (*Abies grandis*, Lindl.).
Green ash (*Fraxinus pennsylvanica*, var. *launceolata*, Sarg.).
Hackberry (*Celtis occidentalis*, L.).
Hardy catalpa (*Catalpa speciosa*, Engelm.).
Hemlock (*Tsuga canadensis*, Carr.).
Honey locust (*Gleditsia triacanthos*, L.).
Hornbeam (*Carpinus betulus*, L.).
Incense cedar (*Libocedrus decurrens*, Torr.).
Jack pine (*Pinus divaricata*, Du Mont de Cours.).
Jeffrey pine (*Pinus ponderosa*, var. *jeffreyi*, Vasey).
Kentucky coffee tree (*Gymnocladus dioica*, K. Koch).
Knobcone pine (*Pinus attenuata*, Lemm.).
Lawson cypress (*Chamaecyparis lawsoniana*, A. Murr.).
Limber pine (*Pinus flexilis*, James).
Loblolly pine (*Pinus taeda*, L.).
Lodgepole pine (*Pinus contorta*, var. *murrayana*, Engelm.).
Longleaf pine (*Pinus palustris*, Mill.).
Maritime pine (*Pinus pinaster*, Ait.).
Mexican white pine (*Pinus strobiformis*, Engelm.).
Mockernut hickory (*Hicoria alba*, Britt.).
Monterey cypress (*Cupressus macrocarpa*, Gord.).
Monterey pine (*Pinus radiata*, D. Don.).
Noble fir (*Abies nobilis*, Lindl.).
Norway spruce (*Picea abies*, Karst.).
Osage orange (*Toxylon pomiferum*, Raf.).
Overcup oak (*Quercus lyrata*, Walt.).
Paper birch (*Betula papyrifera*, Marsh).
Pedunculata oak (*Quercus pedunculata*, Ehrh.).
Pignut hickory (*Hicoria glabra*, Britt.).
Pin oak (*Quercus palustris*, Muench.).
Pitch pine (*Pinus rigida*, Mill.).
Red ash (*Fraxinus pennsylvanica*, Marsh).
Red cedar (*Juniperus virginiana*, L.).
Red maple (*Acer rubrum*, L.).
Red mulberry (*Morus rubra*, L.).
Red oak (*Quercus rubra*, L.).
Red pine (*Pinus resinosa*, Ait.).
Red spruce (*Picea rubens*, Sarg.).
Redwood (*Sequoia sempervirens*, Endl.).
River birch (*Betula nigra*, L.).
Scarlet oak (*Quercus coccinea*, Muench.).
Scotch pine (*Pinus sylvestris*, L.).
Shagbark hickory (*Hicoria ovata*, Britt.).
Shortleaf pine (*Pinus echinata*, Mill.).
Silver fir (*Abies picea*, Lindl.).
Silver maple (*Acer saccharinum*, L.).
Sitka spruce (*Picea sitchensis*, Carr.).
Stone pine (*Pinus cembra*, L.).

- Sugar maple (*Acer saccharum*, Marsh).
Sugar pine (*Pinus lambertiana*, Dougl.).
Sweet birch (*Betula lenta*, L.).
Sweet gum (*Liquidambar styraciflua*, L.).
Sycamore (*Platanus occidentalis*, L.).
Tulip (*Liriodendron tulipifera*, L.).
Walnut (*Juglans nigra*, L.).
Western hemlock (*Tsuga heterophylla*, Sarg.).
Western larch (*Larix occidentalis*, Nutt.).
Western red cedar (*Thuja plicata*, D. Don.).
Western white pine (*Pinus monticola*, D. Don.).
Western yellow pine (*Pinus ponderosa*, Laws.).
White ash (*Fraxinus americana*, L.).
White elm (*Ulmus americana*, L.).
White fir (*Abies concolor*, Lindl. & Gord.).
White oak (*Quercus alba*, L.).
White pine (*Pinus strobus*, L.).
White spruce (*Picea canadensis*, B., S. & P.).
Yellow birch (*Betula lutea*, Michx.).

INDEX

- Acacia, 198.
Acorn planter, 228.
Administration of nurseries, 234-235.
Alder, 70, 129, 135, 140, 268, 281, 371.
Alemann's planting method, 435.
Alfalfa, 254.
Annaburg seed-extracting plant, 163-166.
Arbor-vitæ, 102, 130, 282, 283, 284, 302.
Ash, 62, 111, 135, 148, 210, 211, 213, 268, 281, 285, 371.
 European, 211.
 white, 20, 212, 302.
Ashes, 252, 257.
Autumn planting, 373-374.
Ax-mattock, 423.
- Balled plants, 401-406.
Balsam, 282.
Baskets, planting, 431.
 shipping, 341-342.
Basswood, 140, 148, 302.
Beach grass, use in sand dune reclamation, 196-198.
Beech, 62, 68, 81, 87, 135, 148, 208, 211, 212, 302, 371.
 in mixture with oak, 69.
 in Sihlwald, 88.
 in Wienerwald, 88.
Biermann's planting method, 435.
Bigtree, 129, 130.
Birch, 70, 129, 139, 140, 211, 212, 268, 281, 371.
 cherry, 130, 302.
 paper, 130.
Birds, damage by, 104-105, 180, 350-353.
 nesting boxes for, 352.
Black locust, 63.
Blight, 348.
- Blister rust, 356, 360.
Block planting, 392, 406.
Borer, spiral, 227.
Box elder, 212, 302.
Boxes, seedbed, 288.
 shipping, 340.
Broadcast seeding, 277-280.
Brush covers, 286.
Buckeye, 20.
Buckwheat as soiling crop, 253-254.
Burlap covers, 287, 298.
Buttlar's planting iron, 411.
- Catalpa, 63, 105, 130, 148, 167, 268, 285, 302.
Cedar, 148, 371, 397.
 incense, 20, 102, 130, 302.
 red, 126, 142.
 western red, 129, 130, 211, 212.
 white, 142.
Chamaecyparis, 129, 397.
Cheese-cloth covers, 286, 298.
Cherry, 62, 140, 285, 371.
 black, 147, 212, 302.
Chestnut, 62, 111, 139, 148, 210, 212, 266, 268, 281, 302, 371, 386.
Chipmunks, damage by, 176-177, 346.
 protection from, 177-179.
Clover as soiling crop, 254.
Coffee-tree, Kentucky, 147.
Compost, 250, 252, 255-256, 261.
Cone churn, 157.
Cone planting method, 438.
Cone shaker, 157.
Cones, collecting, 138-146.
 curing prior to kiln-drying, 151, 152.
 drying, methods of, 149-155.
 extracting seeds from, 156-159.
Coppice, 89.

- Corn planters for seeding conifers, 228.
- Cottonwood, 398.
- Covers for seedbeds, artificial, 293-298.
natural, 292-293.
- Cowpeas as soiling crop, 253.
- Crates for transport of nursery stock, 342-343.
- Criddle mixture, 353.
- Crop, mixed, 64-70.
origin of, 6-7.
pure, 62-64.
- Cultivator, Planet Jr., 299.
- Curbs for seedbeds, 265.
- Cuttings, root, 396.
shoot, 396-399.
- Cyclone seeder, 214.
- Cylindrical spade, 404-405, 428.
- Cypress, 266, 371.
Arizona, 130.
bald, 148, 302.
Lawson's, 130.
Monterey, 130, 198.
- Daggers, planting, 409.
- Damping-off, 269, 356-360.
- Dibbles, 408-411.
- Dibbling large seeds, 228.
- Direct seeding, compared with natural seeding, 207.
compared with planting, 82-86.
cost of, 84-85, 213, 219-220, 227-228.
factors governing, 207-210.
loss in, 176.
methods of, full, 210-216.
partial, 216-229.
- Dogwood, 147.
- Drainage in nursery, 245.
- Drill former, Spitzenberg, 273.
- Drill machines, 276.
- Drill, Planet Jr., 269, 277.
- Drill rollers, 272.
- Drills, seeding in, 267-277.
- Dunes, forestation of, 193-198.
- Eckbo seed planter, 226.
- Elm, 140, 210, 281, 371.
white, 103, 302.
- Erect planting, 392.
- Erosion, prevention of, 192.
- Esthetic planting, 46.
- Eszlinger's seeding lath, 275.
- Eucalyptus*, 18, 107, 285, 306, 308.
- Exotics, use of, 17.
- Experiment station, Coconino, 176.
Fremont, 112.
- Fences about nursery, 241.
- Fertilizers, application of, 252-258.
classification of, 251.
necessity for, 250, 251.
- Fiegley tree digger, 331.
- Fillers, use of, 70.
- Fir, 62, 148, 266, 291.
balsam, 104, 130.
Douglas, 20, 62, 92, 95, 102, 129, 130, 212, 266, 281, 284, 302, 304, 350, 356.
red, 130.
silver, 107, 135, 211.
white, 102, 130, 212, 284, 302.
- Fire, effect on choice of species, 37.
protection from, 184-187.
- Full seeding, amount of seed per acre, 212-213.
cost of, 210, 213.
scattering seed in, 213-217.
- Fungi, effect on choice of species, 38.
protection from, 356-361.
- Geneva seed tester, 118.
- Germination, field, 213.
number, 124.
per cent, 124.
tests, 112-122.
values, 123, 132-133.
- Germinative capacity, 105, 124-127.
- Germinative energy, 103, 127-130.
- Germinative force, 103, 127-130.
- Gophers, damage by, 346.
protection from, 180.
- Grasshoppers, protection from, 353.
- Grazing, in relation to choice of species, 38.

- Grohmann's planting method, 434.
 Growth form, transmission through seed, 94.
 Grub, white, damage from, 354.
 Grub-hoe, planting with, 422-428.
 Gum, black, 111, 126.
 blue, 19, 198, 306.
 red, 141, 148.
- Hackberry, 140.
 Hacker's drill machine, 276.
 seed coverer, 276.
 transplanting apparatus, 321.
 Hacker's transplanting machine, 322.
 Hardpan, 190.
 Hedges, 241-243.
 Heeling-in, 335-337, 374.
 Hemlock, 68, 102, 142, 148, 282, 284, 386.
 eastern, 130, 212, 302.
 western, 20, 129, 130, 212.
 Hickory, 111, 139, 148, 208, 210, 213, 220, 268, 285, 386.
 shagbark, 302.
 Hoos, 299-300.
 Hole planting, 421-443.
 Holly, 140.
 Hornbeam, 111, 135, 140.
 Humidity, in relation to choice of species, 25.
 Humus, 36, 191, 250, 252.
- Insects, effect on choice of species, 37.
 protection from, 353-356.
 Inventory of nursery stock, 234.
 Ironwood, 140.
 Irrigation in nursery, 245-250.
- Jacobsen germinating apparatus, 118.
 Jensen's tree planter, 413.
 Juniper, 371.
- Kozesnik's planting method, 439.
- Larch, 69, 266, 269, 291, 371.
 European, 282.
 Lath screens, 288, 296.
 Laudenberg tree lifter, 331.
- Laurel, 371.
 Layers, definition, 7.
 use of, 394-395.
 Leguminous crops as soiling plants, 253.
 Lifting fork, 330.
 Light, influence on choice of species, 24.
 Locust, 140.
 black, 105, 148, 212, 302.
 honey, 141.
 Lupines, 253.
- Manteuffel's planting method, 438.
 Manure, farm, 255-256.
 Maple, 111, 148, 210, 213, 268, 281, 285, 368, 371.
 Norway, 211.
 red, 103.
 silver, 103.
 sugar, 126, 212, 302.
 Marking boards, 270-272.
 Mattock, planting with, 422-428.
 May beetles, damage by, 355.
 Mice, damage by, 346.
 protection from, 179-181.
 Mixed stands, 61, 64-71.
 Moles, damage by, 347.
 Mound planting, 435-437.
 Mulberry, 20, 140, 371.
 Muleh, covering seedbeds with, 286.
 injury from, 349.
- Nectria*, 386.
 Needle cast, 357.
 Nitrates, 251, 256-257.
 Nitrogen, 250, 251, 252, 253, 255.
 Notching spade, 415-417.
 Nurse trees, 70-71.
 Nursery, administration of, 233.
 buildings, 241.
 cost-keeping system for, 234.
 cultural operations in, 262-325.
 drainage of, 245.
 ground plan of, 238-239.
 irrigation of, 245-250.
 kinds of, 230.
 site, 236-238.

- Nursery, size of, 240.
 soil management, 244, 250-261.
 state, 356-357.
- Nursery stock, advertising, 235.
 bundling, 333.
 classification of, 327.
 counting, 334.
 imported, 369.
 lifting, 326-333.
 packing, 339-343.
 protecting in the nursery, 348-361.
 pruning, 369-371.
 purchase of, 368.
 sorting, 333-334.
 storage of, 335-338.
 transport of, 338-343.
 treatment on receipt from shipper, 344.
 weight, shipping, 344.
- Oak, 20, 54, 62, 68, 69, 111, 135, 148, 208, 210, 211, 220, 263, 268, 281, 371, 386, 412.
 live, 20.
 pedunculate, 211.
 red, 212, 302.
 white, 212, 302.
- Oblique planting, 392, 442-443.
- Organic matter in soil, excess of, 191.
- Osage orange, 302.
- Overwood, 25, 68, 206.
- Paris green, 353.
- Partial seeding, 216-229.
- Paths in nursery, 263.
- Pick-mattock, 423.
- Pine, 54, 148, 166.
 Austrian, 291.
 bristle-cone, 102.
 Coulter's, 104.
 jack, 85, 129, 130, 139, 282, 283, 350, 360.
 Jeffrey, 95, 102.
 limber, 102, 130.
 loblolly, 212.
 lodgepole, 20, 78, 102, 129, 130, 139.
 longleaf, 20.
- Pine, Monterey, 105, 304.
 pitch, 102, 129, 130, 198, 212, 282, 360.
 red, 85, 102, 130, 212, 282, 283, 284, 302, 308.
 Scotch, 18, 81, 95, 129, 135, 211, 220, 261, 282, 356, 365, 386.
 stone, 107.
 sugar, 84, 130, 266, 284, 302.
 western white, 97, 130, 266.
 western yellow, 20, 92, 97, 102, 104, 130, 158, 176, 210, 212, 284, 285, 356, 360.
 white, 62, 102, 129, 210, 212, 280, 282, 284, 302, 308, 334, 350, 360, 365, 368, 424.
- Pine bark aphid, 354.
- Pine bud moth, 354.
- Planet Jr. cultivator, 299.
 seed drill, 269, 277.
- Plantations, amount of stock used
 annually in, 363.
 history of early, 362.
- Planting, ax, 415.
 bag, 430, 431.
 basket, 431.
 borer, 441.
 box, 431.
 dagger, 409.
 definition of, 82.
 hammer, 313, 429.
 history of, 362.
 iron, 411, 418, 442.
 lance, 417.
 material, 363-372.
 methods, 400-443.
 rules for, 383.
 season, 372-376.
 silvical basis for, 3.
 spacing in, 376-383.
- Planting and seeding, choice between, 82-86.
- Poisoning rodents, 177-181.
- Pollenation, effect on seed quality, 96.
- Polyporus*, 386.
- Poplar, 141.
- Pot transplanting, 325.

- Precipitation, in relation to choice of species, 26-29.
- Pricking out, 312-325.
- Protection of planting and seeding sites, from fire, 183-187.
- from plant-eating animals, 181-183.
- from seed-eating animals, 176-181.
- Prouvé's planting iron, 418, 442.
- Pruning nursery stock, 369-371, 393-394.
- Puddling, 344.
- Pure stands, 61-64.
- Rabbits, protection from, 181-183.
- Rakes, 226, 278.
- Receptacles for plants, 431.
- Reclamation of soil, 188-198.
- Red lead for coating seeds, 351.
- Red spider, damage by, 354.
- Redwood, 20, 130, 148, 284, 302.
- Regeneration, artificial, 14-15, 81.
- choice between natural and artificial, 75-81.
- mixed, 87-89.
- natural, 4-14.
- Rhododendron, 371.
- Rodents, protection from, 176-183, 346-348.
- Rollers, for forming drills, 272.
- for forming seedbeds, 264.
- Root cuttings, 6, 7, 396.
- Root rot, 348.
- Rotation of crops, 252, 254, 258, 261, 262.
- Roth's planting tool, 405.
- Rye as soiling crop, 253.
- Sand dunes, 193-198.
- Saxon planting iron, 418.
- Sauer's drill roller, 272.
- Screens, 295-298.
- Scrim screens, 298.
- Seed, cleaning, 160.
- collecting, 137-146.
- color as indicative of ripeness, 101.
- coniferous, detaching wings from, 159.
- Seed, cost per pound, 100, 102.
- covering in seeding, 276-280.
- curing, 146-156.
- dealers, list of, 90.
- demand for, 90.
- distribution in seeding, 213-216.
- drying, 146-156.
- extracting, 156-166.
- flask, Swedish, 227.
- genuineness, determination of, 109.
- loss of, in seedbeds, 346-348.
- in storage, 103-105.
- maturity, determination of, 138.
- number, of pounds per bushel of fruit, 100-102.
- per pound, 96-100.
- packing for shipment, 175.
- production, study of, 134-137.
- purity, determination of, 106-108.
- quality, 91-103.
- quantity required, formula for, 283-285.
- in broadcast seeding, 282.
- in drill seeding, 281.
- in full seeding, 212.
- respiration and transpiration, 166.
- size of, 96-100, 103.
- storage, loss in, 103-105.
- methods of, 166-174.
- stratification of, 104, 121, 168.
- testing, 106-120.
- transport of, 174-175.
- trees, 95.
- viability of, 122-123.
- Seedbeds, arrangement of, 263.
- boxes, 288, 296, 351.
- covers, 286-300.
- curbing, 265.
- damage by rodents, 346-348.
- management, prior to germination, 285-289.
- after first year, 302-304.
- after germination, 290-302.
- mulching, 300.
- preparation of, 262-265.
- shading, 290-298.
- size of, 262.
- watering, 245-250.

- Seeding, experimental, 16.
 factors which determine success in,
 207.
 lath, 274.
 machines, 213.
 methods of, 210-229, 267-280, 305-
 307.
 silvical basis for, 3.
 time of, 104, 209, 265-267.
 trough, 273.
- Seeding and planting, choice between,
 82, 84.
- Seedlings, classification of, 327.
 size of, 301-302.
- Semi-circular spade, 433.
- Semi-conical spade, 405.
- Shoot cuttings, 6, 7, 396-399.
- Short-handled grub-hoe, 430.
- Silvics, definition of, 3.
- Silviculture, definition of, 3.
- Site factors, 3, 20, 21, 40-43.
- Skinner system of irrigation, 247-248.
- Slit planting, 414-420.
- Smith tree digger, 331.
- Snow, mechanical effect of on choice
 of species, 28.
- Snow pit, for storing nursery stock,
 337.
- Soil, factors, effect on choice of spe-
 cies, 31-36.
 fertility of, 250-261.
 reclamation of, 188-198.
 tillage, 198-202.
- Soiling crops, 253, 254.
- Spacing, in planting, 376-383.
 in transplant beds, 310-311.
 principles which determine, 52-60.
- Spade, planting with, 404-406, 415,
 428-429.
- Species, choice of, 16-39, 43-51.
 dependent in pure stands, 62-63
 tolerant in pure stands, 62.
- Spiral borer, 227.
- Spitzenberg's drill former, 272.
 planting box, 431.
 planting dagger, 409.
 seed coverer, 276.
 wheel hoe, 299.
- Spletstösser's planting method, 440.
- Spring planting, 375.
- Spruce, 54, 68, 148, 167, 211, 284, 291,
 386.
 black, 129, 130.
 blue, 102, 129.
 Engelmann, 20, 102, 130, 284.
 Norway, 18, 62, 81, 92, 98, 135,
 282, 302, 356, 386.
 red, 102, 212, 282, 284, 302.
 Sitka, 129, 130, 211, 212.
 white, 130, 282.
- Squirrels, damage by, 104, 176-179,
 346.
- Stainer's germinating apparatus, 117.
- Stands, mixed, 64-70.
 pure, 62-64.
- State nurseries, New York, 357.
 Vermont, 356.
- Stem girdle, 356.
- Stool shoots, 6, 7.
- Storage of seed, loss in, 103-105.
 methods of, 166-174.
- Stratification of seed, 104, 121, 168
- Stream flow, regulation of, 45.
- Stringing table, 317-318.
- Subsoil, impervious, 31, 190.
- Sub-irrigation, 249.
- Suckers, root, 6-7, 395-396.
- Summer planting, 373.
- Sun scorch, 348.
- Sycamore, 140, 148, 302.
- Tamarack, 148.
- Thuja*, 397.
- Tillage of forest soil, 198-202.
- Timber culture act, 362.
- T-notching, 416.
- Torsion rake, 227.
- Transplant beds, 307-309, 310-311,
 324.
- Transplanting, methods of, 312-325.
 season for, 309-310.
 spacing in, 310-311.
- Transpiration current, in relation to
 evaporation, 26-27.
- Transport, of nursery stock, 338-343.
 of seeds, 174.

- Tree lifter, 331.
Tree per cent, 132-133, 280.
Trench transplanting, 314-324.
Trencher planting, 419-420.
Triangular spade, 406.
Tulip, 20, 62, 140, 148, 212, 302.
Turnstiles, 243.
- Underplanting, 365.
Utilization value of seed, 130-132,
280.
- Vegetation, treatment on seeding and
planting sites, 203-206.
Ventilation, in drying cones, 154.
Viability of seed, 109-113, 122-124.
- Walnut, 62, 139, 210, 213, 263, 268,
285, 302, 371.
Wartenberg planting staff, 412.
- Water content, definition of, 25.
in relation to choice of species,
32-35.
Water distribution in the nursery,
246-249.
Wheel hoe, 299.
Wild stock, use in nursery practice,
367.
Willow, 141, 371, 399.
Wind, in relation to choice of species,
29-30.
Winter killing, 348.
Winter molding, 349.
Winter planting, 373.
Wood rats, protection from, 181.
Wrenching stock in seedbeds, 304.
Wyeth seed-extracting plant, 161-
163.
- Yale transplanting board, 320.



32120005

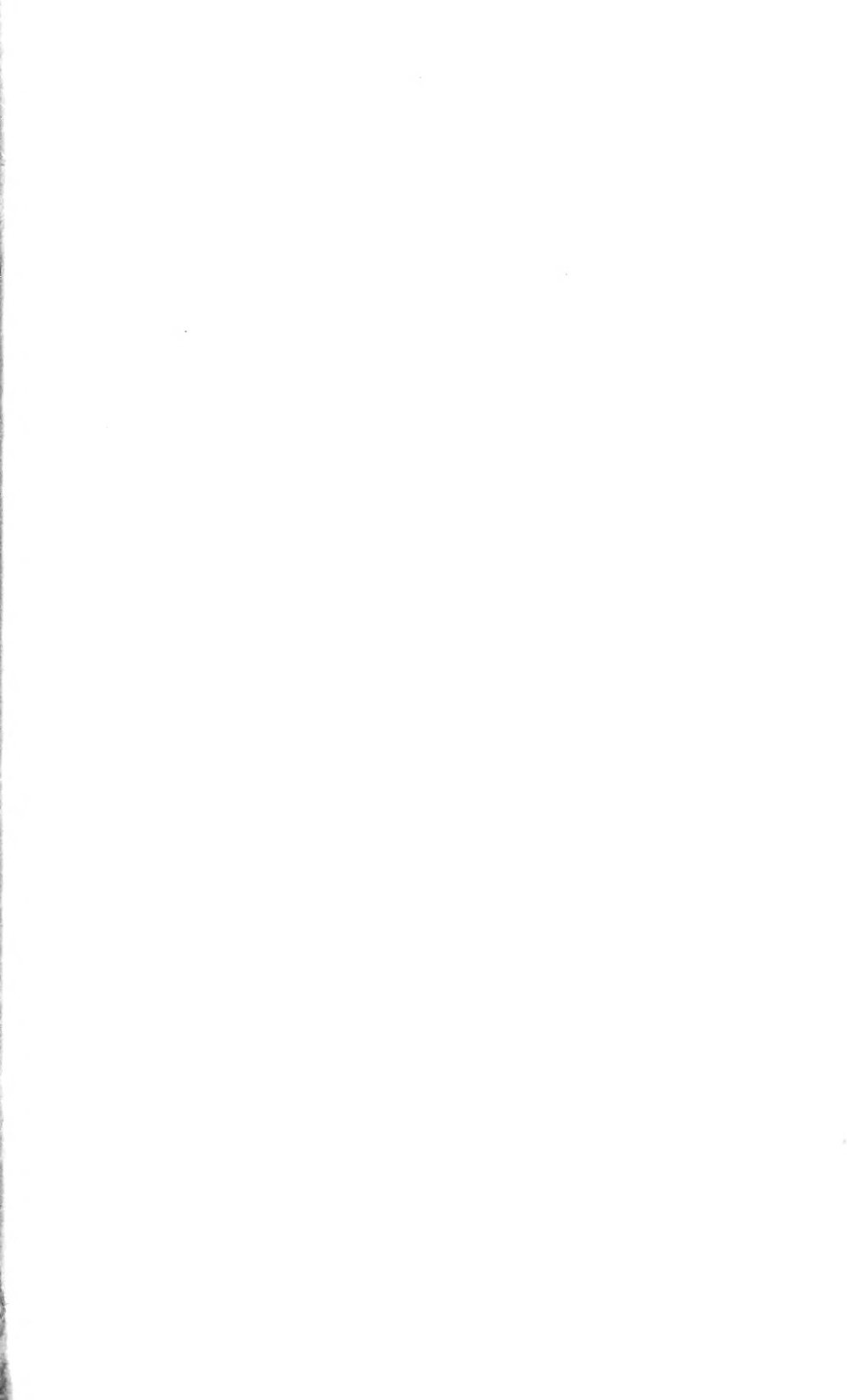



DUE DATE:
SEP 30 1992

~~NOV 26 1991~~

Fines increase
50¢ per d

