

**DYEING
AND
CHEMICAL TECHNOLOGY
OF TEXTILE FIBRES**

E. R. TROTMAN
M.B.E., Ph.D.

FOURTH EDITION

GRIFFIN



LONDON

CHARLES GRIFFIN & COMPANY LIMITED
42 DRURY LANE, LONDON, W. C. 2

© Charles Griffin & Co. Ltd, 1970

All Rights Reserved

No part of this publication may be reproduced, stored in a retrieval system, or transmitted, in any form or by any means, electronic, mechanical, photocopying, recording or otherwise, without the prior permission of Charles Griffin & Company Limited.

1st edition 1924
2nd edition 1946
2nd impression . 1948
3rd edition 1964
4th edition 1970

ISBN 0 85264 165 6

*Set and printed in Great Britain by
Butler and Tanner Ltd, Frome and London*

PREFACE TO FOURTH EDITION

THERE are many excellent textbooks describing particular aspects of **bleaching** and dyeing. There are, however, not many that give a survey of the whole field in one volume. The hope that, in this respect, ***Dyeing and Chemical Technology*** of ***Textile Fibres*** would fulfil a need has received ample confirmation by the demand for previous editions.

What is provided in one volume is not only the scientific and technical information which will be required by the dyer and finisher in his day-to-day work, but also such other information and references to original sources as will assist him to follow the literature and keep abreast of current developments.

The text consists virtually of two portions. The first describes the chemistry and properties of the textile fibres together with the processes which precede dyeing. The second part, with the exception of the last two chapters dealing with testing and the theory of colour, describes the dyes and the methods by which they are applied. Where specific details of dyeing or other processes are given, usually only one set of operating instructions is quoted. The purpose of these is to demonstrate general principles and provide instructions that are applicable to the most common conditions. The reader, however, will also find the information required to enable him to modify the standard instructions to suit the many variations necessitated by local conditions, such as the nature of the water supply, the technical skill of the labour available, and lack of uniformity in the properties of the textiles presented to the processer.

The author is grateful to those who reviewed the Third Edition for their helpful suggestions and these have been taken into account in the preparation of the present book. Most chapters contain additional matter of current interest. The chapter dealing with the relationship between colour and chemical constitution has been expanded and an addition has been made in the form of an introduction to the theory of dyeing. The final paragraphs at the end of the book include an introduction to instrumental match prediction.

Thanks must be expressed to the many organizations who helped with illustrations and the supply of information and also to the librarian Mr Smirfitt, M.Sc., A.T.I., and his staff at the Hosiery and Allied Trades Research Association for their very great assistance on many occasions. The author is grateful to Dr W. L. Lead who helped with reading proofs, and he would also like to express his great appreciation **to** Charles Griffin & Co. Ltd for their painstaking editing and for publishing this book.

E. R. TROTMAN

Nottingham

January 1970

C O N T E N T S

<i>Chapter</i>	<i>Page</i>
1 History of dyeing	1
<p>The early history of dyeing textile materials and the use of dyes derived from natural sources. Perkin's discovery of Mauveine and a short description of the synthetic dyestuff industry.</p>	
2 General properties of fibres	42
<p>Some general properties of textile fibres and yarns. The building of macromolecules by polymerization. The use of X-ray diffraction methods in investigating molecular structure of fibres. The significance of crystalline and amorphous regions and the determination of their relative proportions. Fibrillar structure of fibres. The nature of intermolecular forces in crystalline regions. Molecular weight of polymers. Relative humidity and moisture content of fibres. Classification of fibres.</p>	
3 Cotton and the chemistry of cellulose	37
<p>The natural history and structure of cotton fibres. The chemistry of cellulose and of its degradation products. The fluidity and other tests for determining the degree of degradation of cellulose. The action of physical conditions and chemicals on cotton. Mercerization and the explanation of the action of sodium hydroxide by Donnan's theory of membrane equilibrium.</p>	
4 Multicellular vegetable fibres	66
<p>The multicellular vegetable fibres, including descriptions of flax, ramie, hemp, and jute; short descriptions are included of their preparation for spinning and their properties and uses.</p>	
5 Animal fibres	74
<p>The growth of animal hairs and the tissues of which they are composed. Wool sorting and qualities. The chemistry of proteins and keratin and the properties conferred by salt and cystine cross links. The relationship between elastic properties and molecular structure and α and β keratins. The cultivation of silkworms and the properties of silk.</p>	
6 Regenerated man-made fibres	109
<p>The production of nitrocellulose rayon by Chardonnet. Regenerated cellulose yarns, including cuprammonium and viscose and the more highly orientated fibres obtained by stretch spinning. Polynosic fibres. The preparation of cellulose acetate and spinning fibres from the product. The production and uses of alginate yarns. A short description of regenerated protein fibres.</p>	

7	Synthetic fibres	131
	The large-scale preparation of hexamethylene diamine and adipic acid. The spinning and properties of nylon 66 and other polyamides. Polyesters, including the manufacture of terephthalic acid and Terylene. The properties of acrylonitrile and the polyacrylonitrile fibres. Fibres obtained from polyurethane and vinyl products. Crimping thermoplastic yarns. Elastomeric fibres.	
8	Water and water purification	160
	The classification of natural waters and the impurities in the classes. The hardness of water and lime-soda and base-exchange methods of Softening. Sequestering agents. Methods of determining temporary and permanent hardness. Effluents.	
9	Detergents and scouring	183
	The properties of waxes and vegetable oils and the manufacture and properties of soap. Anionic and cationic compounds. Surface tension and the mode of action of surface-active compounds, including the theory of detergency. Kier boiling cotton; scouring wool, silk, and the man-made fibres. Solvent scouring.	
10	Bleaching	222
	Bleaching powder and sodium hypochlorite and the determination of available chlorine. Bleaching cellulosic fibres with hypochlorites. Hydrogen peroxide and its properties and use in bleaching textiles. The use of sodium chlorite for bleaching cellulosic and other fibres. Stoving with sulphur dioxide. Fluorescent brightening agents.	
11	Unshrinkable and other finishes	260
	Causes of shrinking of wool and a review of shrink-proof finishes. Assessment of shrinkage and degradation of wool fibres by chemical action. Description of crease-resist and easy-care finishes for cellulosic materials. Cross-linking. Methods for making fabrics fire resistant, water repellent, and moth- and mildew-proof.	
12	Introduction to chemical constitution and colour, theory of dyeing, and classification of dyes	303
	Theories of relationship between colour and chemical constitution of organic compounds. Introduction to theory of dyeing. Classification of dyes.	
13	Dyeing machines	335
	Basic requirements of dyeing machines and the materials used in their construction. Descriptions of machines for dyeing loose stock, hanks, packages, fabrics, and garments.	

- 14 Basic dyes 368
- Chemistry and chemical classification of basic dyes. The nature of the affinity of basic dyes for fibres and a description of the methods of application. The fastness and other properties of basic dyes and their uses.
- 1.5 Acid dyes 378
- The chemical nature, classification, and application of acid dyes. Theoretical explanations of the nature of the affinity of animal fibres for acid dyes and the action of dyebath assistants. Application of acid dyes at high temperature and in the presence of organic solvents, and in the dyeing of silk.
- 16 The direct dyes 405
- The discovery of direct dyes and their classification according to chemical structure. Theory of dyeing and the relationship between structure and substantivity. The effects of temperature, electrolytes, and liquor-ratio on dyeing. Description of various after-treatments to improve wet-fastness.
- 17 Mordant dyes 430
- Valency and the significance of covalent bonds in lake formation. Naturally occurring mordant dyes. The properties and application of acid mordant dyes and of the 1:1 and 2:1 premetallized dyes.
- 18 Azoic dyes 444
- The dyeing of Para Red and the development of the substantive series of naphthol derivatives. Bases used for diazotization and coupling in the production of azoic dyes and the preparation of stabilized diazonium compounds. Description of the methods of application of azoic dyes.
- 19 Sulphur dyes 463
- The chemistry, general properties, application, and after-treatment of sulphur dyes. Tending of cellulosic fibres by residual sulphur. Water-soluble sulphur dyes.

- 20 Vat dyes 474
- Chemical characteristics of indigoid and anthraquinone vat dyes, and the relationship between structure and affinity for cellulosic fibres. The application of vat dyes and the use of restraining agents. Fastness properties and accelerated photochemical action. Continuous methods for dyeing with vat dyes.**
- 21 Disperse dyes and dyeing cellulose acetates 506
- Disperse dyes and their mechanism of dyeing. Description of the methods of application, including diazotization and coupling on the fibre. Fastness properties of disperse dyes and gas fading.**
- 22 Reactive dyes 520
- Reactions of cyanuric chloride and the chemistry of reactive dyes. Evidence supporting the formation of a covalent bond between the dye molecule and cellulose. Application of dichlorotriazinyl dyes at low temperatures and monochlorotriazinyl dyes at high temperatures, by batch and continuous methods. Description of the Remazol, Primazine and Levafix dyes. Procilan dyes.**
- 23 Dyeing synthetic fibres 544
- Presetting thermoplastic fibres. Dyeing polyamides, polyesters, and polyacrylonitriles.**
- 24 Dyeing materials containing mixtures of fibres 574
- Dyeing materials composed of mixtures of fibres. Description of the cross-dyeing and production of solid shades on wool and cellulosic unions. Dyeing textiles containing polyamides, polyesters, or polyacrylonitriles mixed with other fibres.**
- 25 Testing dyed materials 587
- Use of grey scales in expressing results of fastness tests. Determination of light fastness and description of fading lamps, and the effect of humidity on light fading. Washing, perspiration, bleaching, cross-dyeing, and mercerization fastness tests. Identification of dyes by spotting tests and chromatographic methods.**

26 Colour	615
The spectrum and additive and subtractive primaries. Description of Oswald's and Munsell's systems of colour classification and the C. I.E. chromaticity chart. The design and use of colorimeters and spectrophotometers. Instrumental match prediction.	
Appendix: Miscellaneous information and tables	649
Comparative thermometer scales. Comparison of hydrometer scales. Specific gravities of caustic soda and caustic potash lyes. Specific gravities of sulphuric acid. Temperatures of dry saturated steam. Decinormal solutions. Hydrochloric acid specific gravities. Specific gravities of acetic acid, formic acid, and ammonium hydroxide solutions. pH intervals over which indicators change colour. Gallons, litres, and pints conversion table. Conversion factors.	
Name index	661
Dyestuff index	664
General index	667

LIST OF SOME ABBREVIATIONS
USED IN THIS BOOK

<i>Abbreviation</i>	<i>Explanation</i>
<i>Am. Dyes. Rep.</i>	<i>American Dyestuff Reporter</i>
<i>Ber.</i>	<i>Berichte der Deutschen Chemischen Gesellschaft</i>
<i>Biochem. J.</i>	<i>Biochemical Journal</i>
<i>C.I.</i>	Colour Index
<i>C.I.E.</i>	Commission Internationale de l'Eclairage
<i>Helv. Chim. Acta</i>	<i>Helvetica Chimica Acta</i>
<i>Ind. Eng. Chem.</i>	<i>Industrial and Engineering Chemistry</i>
<i>I.S.O.</i>	International Standards Organization
<i>I.W.T.O.</i>	International Wool Textile Organization
<i>J.A.C.S.</i>	<i>Journal of the American Chemical Society</i>
<i>J. Amer. Chem. Soc.</i>	<i>Journal of the American Chemical Society</i>
<i>J.C.S.</i>	<i>Journal of the Chemical Society</i>
<i>J. Chem. Soc.</i>	<i>Journal of the Chemical Society</i>
<i>J. Opt. Soc. Amer.</i>	<i>Journal of the Optical Society of America</i>
<i>J. Res. N.B.S.</i>	<i>Journal of Research, National Bureau of Standards</i>
<i>J.S.C.I.</i>	<i>Journal of the Society of Chemical Industry</i>
<i>J.S.D.C.</i>	<i>Journal of the Society of Dyers and Colourists</i>
<i>J. Text. Inst.</i>	<i>Journal of the Textile Institute</i>
<i>Melliand Textilber.</i>	<i>Melliand Textilberichte</i>
N.B.S.	National Bureau of Standards
<i>Proc. Roy. Soc. Lond.</i>	<i>Proceedings of the Royal Society, London</i>
<i>Rev. Mod. Phys.</i>	<i>Review of Modern Physics</i>
<i>Text. Res. J.</i>	<i>Textile Research Journal</i>
<i>Trans. Farad. Soc.</i>	<i>Transactions of the Faraday Society</i>

**DYEING AND
CHEMICAL TECHNOLOGY
OF TEXTILE FIBRES**

Also by E. R. Trotman

Textile scouring and bleaching

I · History of dyeing

THE dyeing of textiles is usually understood to mean giving them a colour which is of comparative permanence. This implies that it should not be possible to wash the colour out easily in laundering, nor should it fade rapidly when exposed to light. The condition of permanence distinguishes dyeing from tinting (when the material is given a colour which is very easily removed with a detergent and water). Yarns are tinted occasionally so that different counts and qualities can be identified during weaving or knitting or any operation which precedes dyeing. In the definition of dyeing the permanence, or fastness, of the colour bestowed was qualified by the adjective comparative. There is probably no dye which can be guaranteed not to alter shade under all conditions. There are great variations in the fastness of different dyestuffs but, as will be revealed, there have been many significant milestones in the search for better fastness during the last hundred years,

It is believed that dyeing was **practised** as early as 3000 **B.C.** in China, although no conclusive proof of this is available. The earliest records of Indian religious and social practices belong to the period of about 2500 **B.C.**, and they contain references to coloured silk and gold brocades from which it can be concluded that dyeing was then already an established practice. It could be that the craft was transmitted through Persia to Egypt. Relics of ancient civilization have been better preserved and more thoroughly explored in Egypt than in any other Eastern country. From paintings on the walls of tombs it can be inferred that as long ago as 3000 **B.C.** the Egyptians were making coloured mats which they hung on their walls. It has also been established beyond doubt that Dyer's thistle, also known as Safflower, was in use in 2500 **B.C.** to produce red and yellow shades. By about 1450 **B.C.**, the Egyptians were making textile materials of astonishingly delicate structure and were able to dye them in a whole range of different colours.

In the chronological sequence of history, classical civilization followed that of the Far and Middle East. Tyrian Purple, the badge of the patrician Roman, is believed to have originated in the Phoenician town of Tyre. We owe much of our knowledge of classical dyeing to the writings of Pliny, who has left a record of a number of recipes in use during his era. There was also a dyer's work-shop excavated at Pompeii. The walls are decorated with a series of murals illustrating various operations as they were then performed. It is interesting to observe that one illustration is of Mercury bearing a bag of money, symbolic of the fact that, in those days, dyeing was a profitable trade.

With the collapse of the Roman Empire, the Dark Ages descended upon Europe, a period during which we have practically no records of the arts and crafts. It is not until 1371 that information about dyeing made its appearance again, when the dyers formed their own independent Guild in Florence. This Guild had only a short life, because it was dissolved in 1382, but soon afterwards, dyers' Guilds were to appear throughout all the European countries. In London the first charter was bestowed upon the Worshipful Company of Dyers in 1471. As was the custom in those days, the Guild exercised a strict control over entry into the trade, the workmanship and the trading practices of its members.

Until the middle of the last century, all dyes were obtained from natural sources. Indigo, extracted from the plant *Indigofera tinctoria*, and Alizarin, obtained from the root of madder, have been used in India since the beginning of recorded history. Some of these products were probably exported to adjacent countries such as Iran (Persia), and may have spread from there to the Middle East. Neither alizarin nor indigo was available in Europe until the route to the East via the Cape of Good Hope had been opened up. *Carthamus tinctorius* or safflower, also known as Dyer's thistle, is a plant common in Asia, Africa and the Mediterranean countries. The flowers contained a colouring principle which was used by dyers as a source of delicate rose and rich scarlet colours, and as a cosmetic when mixed with talc. A textbook on dyeing and calico printing, written by Parnell in 1844, gives a good account of the natural dyestuffs which were in use before the advent of synthetic dyes.

We also know from Roman history that woad was used by ancient Britons. It was obtained from a plant known as *Isatis tinctoria*, which was cultivated in France, Germany, and in Britain. The active substance in the plant was indigotin, which was the same compound from which indigo was prepared in the East. Indigotin is blue, but is virtually insoluble in water. Before it can be used as a dyestuff it has to be reduced. Until modern chemical reducing agents were available, dyers had to rely upon natural fermentation of vegetable matter, in the course of which hydrogen, a reducing agent, was produced. Woad contained the micro-organisms required to set up fermentation, which would bring about reduction of the indigotin. It was therefore only necessary to allow an aqueous infusion of the plant to stand under the right conditions, and in time, a liquor suitable to use for dyeing would be produced. It was, however, an extremely skilful operation to control the fermenting mass in such a way that only the correct hydrogen-producing micro-organisms would flourish and multiply, and not become exterminated by some other species which had not the desired characteristics.

When the trade route to the East was opened up, in spite of much protest from the woad growers oriental indigo soon replaced indigotin from all other sources. Woad was then only cultivated for its value as an ingredient to

initiate fermentation of the indigo infusion. It is interesting to record that Tyrian purple has the same chemical structure as indigo, except that two hydrogen atoms have been substituted by bromine. Both of these colouring matters belong to a group which is now known as the vat dyes, and which is described fully in Chapter 20.

In order to give some idea of the trouble which had to be taken to prepare indigo for dyeing, the following notes, taken during the setting of a vat with the aid of woad, are quoted from the Jubilee issue of the *Journal of the Society of Dyers and Colourists*, 1934. The vat in which the fermentation was carried out was circular in cross-section, with a diameter of 6 ft and a depth of 7 ft. The following is the daily record from the Dyer's diary.

TUESDAY 5 p.m. Filled with water and heated to 60°C (140°F). Four and a half hundredweight of broken woad added.

WEDNESDAY 9 a.m. Liquor heated to 60°C (140°F) and stirred. 3 p.m. heated again to 60°C (140°F) and stirred. 5 p.m. added 6 gallons of indigo paste, 14 lb of madder, 9 pints of slaked lime and 30 lb of bran. Heat to 60°C (140°F), stir, and then cover the vat and leave it overnight.

THURSDAY 9 a.m. Liquor olive-brown in colour, sample of sediment showed a mild state of fermentation. Slight sourness discernible. Add 2½ pints of lime, heat to 54°C (130°F) and stir. At 1 p.m. slight frothing on the surface noticed, the colour of the liquor was dark olive-brown and fermentation was active. On plunging a stirring rake to the bottom of the vat, coppery blue stars rose to the surface of the liquor in the vat, and the odour of the sediment was slightly sour. Two pints of lime were added, and the liquor was stirred. At 4 p.m. a blue flurry appeared on the surface, together with an abundance of coppery blue stars and blueveins. Fermentation was still active, and the odour of the sediment was a little less sour. A further 2 pints of lime were added with stirring. At 5.30 p.m. much flurry had accumulated, and the liquor had become a yellowish olive colour with a slightly ammoniacal smell. A swatch of white wool cloth was immersed during 15 minutes when it dyed a good medium blue. This indicated that reduction of the indigo was proceeding satisfactorily. Two pints of lime and 1½ gallons of indigo paste were added, and the temperature was raised to 54°C (130°F). At 9.30 p.m. there was an abundance of flurry, the surface was a dark blue colour, and the liquor itself a dull yellow. By this time, the fermentation was abating, and the odour was slightly ammoniacal. A further 2 pints of lime were added, the temperature again raised to 54°C (130°F), and the liquor left overnight.

FRIDAY 9 a.m. The flurry was as before, and there was a coppery blue skin on the surface. The liquor was slightly turbid and amber yellow

in colour. The fermentation had abated considerably, and the appearance and odour of the vat were normal. The temperature was allowed to fall to 32°C (90°F), and a piece of heavy beaver cloth weighing about 80 lb was placed in the vat and moved about gently for 2 hours, when it dyed satisfactorily. This vat would now be maintained by additions of the requisite amounts of bran and lime, together with indigo paste about every third evening. This would keep the fermentation active, whilst the lime would serve the dual purpose of keeping the growth of the micro-organisms under control, and rendering the reduced indigo soluble.

This description of the dyeing of indigo has only been quoted at some length to give an example of the complicated methods which the dyer was compelled to use when all the knowledge about his craft was entirely empirical. Applied science had not then had an opportunity to find explanations for what was happening, and to simplify the operations.

Most of the colouring matters of natural origin used in medieval times were not capable of producing permanent colours on textiles by themselves. The fibres had to be prepared for the reception of the dye by impregnation with metallic oxides such as those of aluminium, iron, or tin. These substances were known as mordants, derived from the French word 'mordre', which means to bite. The name was considered appropriate, because it was believed that the oxides bit the dye and held it on to the fibre. One of the most commonly used natural mordant dyes was alizarin, obtained from the roots of the madder plant, which was cultivated extensively in Europe, the Near East, and India. It dyes a comparatively fast red colour on an aluminium oxide mordant, and a purple-to-black shade with iron oxide. A variety of chocolate-coloured tones can be obtained by using mixed mordants of aluminium and iron oxides. Madder, cultivated in Turkey, yielded an exceptionally bright red, which accounts for the name, Turkey red, which came to be used as a general description of alizarin reds. The discovery of the Western hemisphere and the opening up of shipping routes to the Americas brought fresh natural mordant dyes to the European market. Amongst these was Brazil wood, also known as Peach wood, which contained a water-soluble colouring matter producing red dyeings on an aluminium oxide mordant, brown shades on an iron oxide mordant, and rose-coloured effects with tin oxide. Haematoxylin, extracted from Logwood, found the most extensive application, and was used in great quantities for dyeing black on a chromium oxide mordant.

Cochineal came to the European dyers from Mexico, and was obtained from the female insect of the species, *Coccus cacti*. It dyed a crimson shade on an aluminium mordant, and was very similar to Kermes, which was extracted from an insect native to Spain. Cochineal forms a very fine crimson on an aluminium mordant, and scarlet on tin oxide; this was

used, until recently, to dye the material for the Guards' ceremonial uniforms.

A limited number of inorganic pigments found a use in dyeing. A grass green was dyed by passing cloth first through a solution of chromium chloride and then through a solution of sodium arsenate. Chrome yellow, which is lead chromate, is deposited in a comparatively permanent form on materials by passing them consecutively through solutions of lead acetate or nitrate, and potassium bichromate. A much longer description of the art of colouring textiles with natural dyes could be given, but the subject is only of historical interest, and this is not the place to pursue it further.

The year 1856 witnessed an event which was to bring about a fundamental change, not only in the practice of dyeing, but also in the course of time, in the whole field of chemical industry. The new era was initiated by William Perkin, the son of a London builder, who was destined, in the first place, to follow in his father's footsteps. He was sent to the City of London School, which happened to be one of the very few which taught science in those days. His master noticed Perkin's aptitude for chemistry and appointed him as his assistant, when he, no doubt, carried out the experiments to illustrate the instructor's teaching. Perkin's science master wanted him to go to the Royal College of Chemistry, which at that time was under the guidance of the celebrated German chemist, Hoffman. Perkin's father wished his son to study architecture, and was greatly disappointed at the choice of chemistry as a career, but did not raise objections.

Perkin proved to be a promising student, and was kept so busy at the Royal College of Chemistry assisting Hoffman that he had no time to pursue his own research. He therefore set up a somewhat improvised laboratory in his own home, which he used during his holidays and in his spare evenings. Hoffman, in drawing attention to the desirability of producing quinine synthetically, set a target which Perkin, at the age of 18, endeavoured to achieve in his own laboratory. In the course of his experiments he oxidized aniline with potassium dichromate, and obtained a black precipitate. When this was extracted with ethyl alcohol, a brilliant purple solution was produced. All these experiments, which were to lead to such momentous results, were carried out during the Easter vacation in 1856. Perkin's oxidation of aniline brought him no nearer to his main objective, namely the synthesis of quinine, but a few further experiments led him to conclude that he had produced a useful dyestuff. This work was of profound significance. It was the first time that a chemist had created a dye from comparatively simple organic molecules. It was also made from what was virtually a waste product in the destructive distillation of coal in the gas-works, and the discovery eventually opened up an entirely new aspect of chemical industry.

Perkin sent a sample of his mauve dye to Pullar's of Perth, who tried it out in their works and gave it a favourable report, provided that it could

be manufactured at an economic cost. Perkin, still only 18 years old, assisted by his father and his brother, built a factory at Greenford near London. Here he devised and erected a plant for nitrating benzene, a reaction which had never been carried out on an industrial scale before. He pioneered the large-scale reduction of nitrobenzene to aniline, and worked out a means of oxidizing the aniline and extracting the dyestuff. The greatest tribute is due to Perkin, who had the acumen, imagination and perseverance to found a new industry with no previous experience at his disposal to guide him. One must, at the same time, admire the faith which his father had in him, which took the concrete form of providing the financial backing which he needed.

Perkin's work fertilized the minds of organic chemists all over the world. If one dyestuff could be made synthetically, there was no reason why others should not. In the hundred years which have passed since the original discovery, many thousands of dyestuffs have been synthesized in research laboratories, and out of these between 1500 and 2000 have become successful commercial products. Perkin was already manufacturing aniline on a commercial scale, and it was therefore natural that early applied research was directed towards dyestuff synthesis based upon aniline as the starting point. In 1858 fuchsine was introduced in Lyons by a chemist named Verguin. He prepared it by oxidizing a mixture of one molecular equivalent of paratoluidine, together with two molecular equivalents of aniline with stannic chloride. This was the first of the triphenylmethane group, which are basic dyes (see Chapter 14) and all of which possess intense brilliance of colour. Some basic dyes are still used because nothing has since been discovered of equal brightness, but unfortunately there is a price to be paid for this asset, in the form of lack of fastness to light. The first synthetic dyes faded quickly, and this brought about a measure of prejudice against them, which lasted for some time.

Medlock and Nicholson in 1860 obtained fuchsine by a more effective route, using arsenic oxide as the oxidizing agent, and called the product Magenta. This was soon followed by the production of a dyestuff which was at that time known as Violet Imperial or Bleu de Lyons. It was prepared by heating Magenta with aniline. Unfortunately, it was only soluble in alcohol, which placed a great limitation on its application. A great step forward, however, was made by Nicholson in 1862, when he heated Bleu de Lyons with sulphuric acid, thereby making it water soluble by sulphonation. This reaction is used very widely now to make insoluble coloured products soluble in water, and therefore useful as dyestuffs. Sulphonation also makes a dye which can ionize in water, the dyestuff ion being anionic, or bearing a negative charge. This gives it the power to combine with the basic groups of wool or silk. The blue Nicholson obtained by sulphonation was known as soluble, or Alkali Blue (C.I. ACID BLUE 110), and it still finds a limited use.

In 1863, Lightfoot discovered the first successful method of dyeing a good black based on oxidizing cotton impregnated with aniline. The process gave what was known as Aniline Black, and was probably used for about sixty years before it was superseded by better methods. Hoffman, who had been Perkin's teacher, methylated or ethylated the amino groups in the magenta molecule, and prepared a series of dyes originally called the Hoffman violets. The two which survived were the pentamethyl derivative of magenta, which later became known as Methyl Violet, and the hexamethyl substitution product called Crystal Violet.

All the early dyes were discovered as a result of purely empirical experiments. They were all derivatives of benzene, and it was not until 1865 that Kekulé proposed the six-membered hexagonal ring structure, to account for the isomerism of the substitution products of benzene. This model provided a satisfactory framework for the interpretation of the chemistry of benzene. It became possible to propose and confirm structural formulae for the existing synthetic dyes and, by inference, to initiate many profitable research projects. The next important event was the manufacture of Alizarin. Reference has already been made to Alizarin as one of the natural dyes widely used in ancient and medieval times. In 1868 Graebe and Liebermann in Germany and W. H. Perkin in Britain almost simultaneously discovered methods of synthesizing Alizarin from anthracene which is a hydrocarbon extracted from the products of destructive distillation of coal. Perkin started to manufacture Alizarin in 1869 and Graebe and Liebermann's process was developed in Germany a year later. The Germans, however, were now overtaking the British in the race to become the dominant producers of dyes. Although Perkin had a start of one year, by 1873 Britain made 435 tons of Alizarin whilst Germany made 1000 tons. A few years later Perkin retired from the dyestuff manufacturing industry which, from then onwards, rapidly declined in this country till by 1885 it was estimated that 80 per cent of the dyes used in Britain were of foreign origin.

In 1858 a discovery of outstanding importance was made by Peter Griess, a chemist in a Burton-on-Trent brewery. He brought to light what was known as the diazo reaction. When aromatic primary amines are treated with nitrous acid (produced by the action of hydrochloric acid on sodium nitrite) they form diazonium salts as illustrated in the equation:

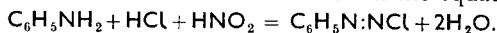

The important property of these compounds is that they will couple with aromatic amines and hydroxy derivatives to form highly coloured products which, when rendered soluble by sulphonation, give rise to a great range of dyestuffs known as the azo dyes. A simple example of a coupling reaction is shown in the following equations:

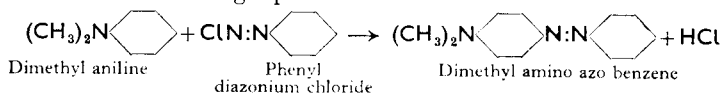

The historic structure given to the diazonium salts was used in the above equation. Because the weight of evidence points to the fact that ionization occurs in aqueous solutions, it is now considered that their structure is akin to that of an ammonium salt as shown below:



Some of the earliest dyes prepared by this reaction were Bismarck Brown in 1865, and Chrysoidine G in 1876. The latter is very simple in structure and was obtained by coupling diazotized aniline with *m*-phenylenediamine

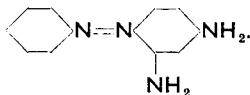

Orange II made its appearance in 1876 and was obtained by coupling diazotized sulphanilic acid with beta naphthol

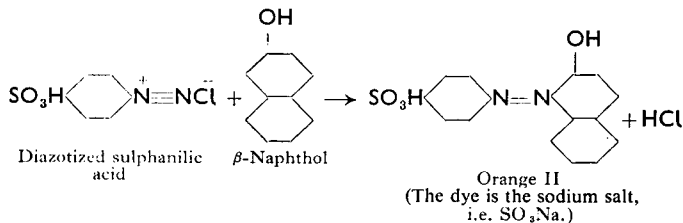

Orange IV was made by coupling diazotized sulphanilic acid with diphenylamine. In 1877 Roccelline, the product of coupling diazotized alpha naphthylamine with the 4-sulphonic acid of beta naphthol, was added to the family of azo dyes. These were some of the early azo acid dyes with a direct affinity for wool and silk.

Until 1884 all the synthetic dyes which had appeared had no affinity for cotton. They could only be applied after the fibre had been mordanted. This was a lengthy and complicated operation not suitable for quick and cheap dyeing of the mass-produced cloths coming from the looms in Lancashire in the wake of the industrial revolution. It was, therefore, a very welcome event when in 1884 Böttiger prepared Congo Red and found that it would dye unmordanted cotton by the extremely simple process of merely boiling the material in a solution of the dye. The urgent need to simplify the dyeing of cotton was a great incentive to follow up Böttiger's work, and it was not long before an adequate range of analogous dyes became available.

These so-called direct dyes which arose out of Böttiger's discovery were extremely useful and still find very extensive application. Their weakness, however, is a lack of fastness to washing and other wet processes. Ever since 1884 there has therefore been a constant search for some means of producing colours on cotton which will stand up better to washing. The approach, until recently, has been to build up an insoluble colour within

the fibre by successive application of two soluble components capable of combining in situ. This idea was first given practical expression by A. G. Green, who synthesized a yellow direct dye named Primuline which itself was of no importance because its fastness was very poor. It did, however, contain within its molecule a primary amino group. Green demonstrated that it was possible to dye cotton with Primuline, then cause it to react with nitrous acid, and subsequently couple the diazotized product with beta naphthol to give a red dye of much greater wet-fastness. This principle has since been extended to quite a number of dyes and is still in use for blacks and navies where adequate fastness at a comparatively low cost is required.

An analogous method of obtaining colours on cotton of satisfactory wet-fastness consists of synthesizing an insoluble azo colour within the fibre. In 1880 Read Holliday showed that it was possible to dye cotton by padding it with beta naphthol and subsequently passing it through a solution of diazotized beta naphthylamine. This was called the Vacanceine Red process, but it never found much favour. In 1889 Meister, Lucius, and Bruning with the Badische Co. introduced Para Red, in which the fibre was first padded with beta naphthol and then coupled with diazotized paranitraniline. This was very successful and in a short time entirely replaced the use of Alizarin for dyeing fast red shades on cotton.

β -naphthol had no affinity for the fibre and had to be fixed temporarily by drying before coupling with the diazonium salt. This made application tedious and caused poor rubbing fastness. In 1911 Zitscher and Laska discovered that the anilide of 3 : 2-hydroxynaphthoic acid had a significant affinity for cellulose. This compound could be coupled with a variety of diazotized bases and was the forerunner of many analogous naphthoic acid derivatives. The name azoic dyes has been given to what has become a very important group of colours obtained by this method.

In 1893 a French chemist, Raymond Vidal, obtained a product which would dye cotton a greenish black by heating together a mixture of sodium sulphide and sulphur with either paranitrophenol or aminophenol. This was the first of a group known as the sulphur dyes, and was followed by the discovery of sulphur blues, greens, yellows, browns, and oranges. They are cheap, easy to apply, and of good light- and wet-fastness, but they lack brightness of colour and this places a limitation upon their use.

Tyrian purple and indigo, which have been used since time immemorial, possessed fastness properties which far surpassed those of the early synthetic dyes. The ancients got surprisingly good results using methods based entirely on empirical knowledge. These colours belong to the group known as the vat dyes which all undergo reversible oxidation and reduction. The oxidized state is an insoluble coloured pigment, and the reduced compound is soluble in alkali, has an affinity for cotton, and is colourless or quite different in colour from the oxidized pigment. Dyeing with vat dyes involves applying the reduced form to the fibre and then oxidizing it either

by exposure to air or by treatment with some oxidizing agent. The chemical structure of indigo was established by von Baeyer in 1880, and this was followed by the synthesis of a number of substituted indigos, some of which became established as successful vat dyes. A new era in the development of vat dyes arrived in 1901 when René Bohn, by fusing beta aminoanthraquinone with caustic potash, obtained an insoluble blue substance resembling indigo both in appearance and in the fact that it was rendered soluble by the action of a reducing agent in the presence of alkali. The substance proved to have the properties of a vat dye and was introduced into commerce under the name of Indanthrene Blue. It was the first of a large number of anthraquinone vat dyes which have vastly increased the range of shades and also the fastness of this group. The vat dyes are expensive and somewhat troublesome to apply, but their outstanding fastness makes them invaluable for many purposes.

Before leaving cotton dyeing there is one more recent development of profound importance. Neither the direct dyes nor the insoluble pigments formed in situ enter into any form of true chemical combination with the cellulose. It has been known for some time that cyanuryl chloride could combine with cellulose. The first of the so called reactive dyes to appear on the market contained a cyanuryl chloride group which made them capable of entering into true chemical combination with the fibre. The result was the production of a range of colours in bright shades with extremely good fastness to wet treatments and to light. Several other reactive groups have now been introduced into dye molecules such as trichloropyrimidyl, primazine, sulphonethanolamide sulphuric acid ester and the vinyl sulphone structural units.

Cellulose acetate yarn, when it appeared on the market in 1921, presented a new problem because it had no adequate affinity for any of the existing dyestuffs. The first satisfactory method of coloration was due to Holland Ellis who observed that many simple insoluble azo dyes would be absorbed by cellulose acetate from an aqueous dispersion, stabilized with sulphated fatty alcohols or similar surface active compounds. A large number of dyes whose application depends on this principle have now made their appearance and are known as the disperse dyes. The demand for this group has increased very significantly with the advent of the truly synthetic man-made fibres.

A very brief summary of the historical developments in the dyeing of vegetable fibres has been given, and some comment on the evolution of the dyeing of animal fibres is desirable. The original basic dyes, which were the direct descendants of Perkin's mauve, were all capable of dyeing wool and silk, but left much to be desired from the point of view of fastness. Nicholson's Soluble Blue and Alkali Blue discovered in 1862 were the first of the large group of acid dyes which are for wool what the direct dyes are for cotton. The acid dyes are, almost without exception, sodium salts of sul-

phonic acids. In acid solutions the sulphonic acid is liberated and undergoes ionic dissociation; this liberates dye anions which can enter into combination with the cationic groups in the animal fibre. Originally these dyes were prepared by sulphonating basic dyes, but with the exploitation of Griess's diazonium reaction the main development was in the field of sulphonated azo dyes. There are now many acid dyes covering a great range of shades with light and washing fastnesses varying from indifferent to excellent. With increasing fastness, however, there tends to be greater difficulty in obtaining level dyeing. Logwood was used in great quantities to dye wool black on a chrome mordant, but the process was slow. A significant advance was made when it was found that azo dyes containing hydroxyl groups in a position ortho to the azo group, could be dyed on the wool first and then fixed or mordanted by adding sodium bichromate to the boiling acid bath after the dye was exhausted. This group is known as the after-chrome acid dyes, and their introduction to the trade dates from 1889. The first well known one was Diamond Black F, marketed by Bayer & Co. in 1890. The after-chrome dyes are extremely fast to washing and are usually more level dyeing than the fast acid dyes. They are not, however, available in bright shades. In 1900 a further simplification was achieved by the Berlin Aniline Co. in the metachrome process where the dyeing and mordanting were carried out simultaneously, a method used extensively for dyeing khaki for uniforms. A great advance, however, was made when the Neolan dyes appeared on the market. These were the forerunners of a large and important class which are now grouped together under the classification of premetallized dyes. These are, in fact, the dyestuff chromium complex in a soluble form directly applicable to the wool and requiring no further treatment. These dyes still further shorten the dyeing cycle, and make shade matching easier because in the after-chrome method the final mordanting entirely alters the colour. The premetallized dyes, whilst not so bright as the acid colours, offer a fairly adequate range of shades with supremely good fastness characteristics.

2 General properties of fibres

THERE are many fibrous structures in nature, but only those which can be spun into yarns suitable for weaving or knitting can be classified as textile fibres. In order that it may have commercial value a textile fibre must possess certain fundamental properties. It must be readily obtainable in adequate quantities at a price which will not make the end-product too costly. It must have sufficient strength, elasticity, and spinning power. The latter property implies a measure of cohesion between individual fibres which will give strength to the yarn when they are twisted together. The spinning of fibres is, without doubt, helped when there is a certain amount of surface roughness or serration, and it is also promoted by fineness and uniformity of diameter. In addition to these fundamental properties there are others which are desirable, such as durability, softness, absence of undesirable colour, and an affinity for dyes. Some fibres have few, and others have many, of these properties: silk, as an example, possesses most of them developed to a high degree. Some of the valuable properties, such as colour or softness, may be latent, and the object of finishing processes is to develop them to the highest possible extent without in any way damaging the fibre.

There is a distinction between what are commonly known as staple fibres and continuous filaments. Staple fibres, of which wool and cotton are the classical examples, are of the order of one to four inches in length. These have to be converted into yarns by carding and spinning processes. Continuous filaments, as the name implies, are hundreds, if not thousands, of feet in length. Silk is the only abundant naturally-occurring example, but all man-made fibres are in the first place produced as continuous filaments. The single strand of the continuous filament is a monofilament. Commercial yarns usually consist of several monofilaments lightly twisted together or, to use a term well known in the trade, 'thrown'.

When making very delicate materials it may be necessary to use a yarn which is so fine that it would break down under the stresses imposed on it during manufacture. The strength, however, is sufficient once the fabric is made because of the mutual support of adjacent threads. In such cases it is customary to impart temporary strength to the yarn by a process known as sizing. This consists of impregnating the thread with some easily removed substance such as starch or dextrine and, in the case of the more modern man-made fibres, with a synthetic product such as polyvinyl alcohol or polyacrylic acid. The size is 'usually removed before the article is dyed or bleached. Yarns are frequently referred to as warp or weft yarns. In a

woven cloth the warp is the strength-giving element which provides the scaffold or frame upon which the cloth is built. The weft yarn, which is taken backwards and forwards by the shuttle, is often fuller or spongier, its purpose not being to provide strength but to act as a filler so that the finished material shall have a solid appearance. Knitted web is defined as a weft fabric because it contains no warp and is made entirely of interlocking rows of loops orientated in the weft direction.

Until just after the beginning of the present century nothing was known about the molecular structure of textile fibres. As chemical knowledge about natural products advanced it became apparent that fibre-forming molecules were of great molecular weight, and were formed by polymerization of simpler organic substances. Some explanation of the phenomenon of polymerization is desirable because it is essential for an understanding of textile chemistry. A polymer is a giant molecule of extremely high molecular weight formed by the joining together of thousands of simple molecules. A molecule capable of entering into polymerization is referred to as a monomer. The simplest example of polymerization is the formation of polyethylene from ethylene. The ethylene molecule has a double bond ($\text{CH}_2=\text{CH}_2$) which, under the right conditions, is capable of linking with adjacent molecules as shown in the equation below:

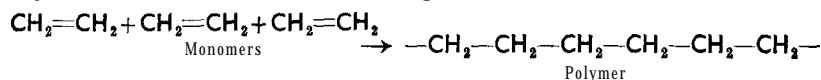

Theoretically there is no limit to the amount of such coupling and therefore to the ultimate size of the molecule which will be formed. In practice, the degree of polymerization depends upon the conditions under which the reaction is carried out. Both the melting point and the fibre-forming potential increase as the size of the molecule becomes greater. If ethylene be caused to react at temperatures of about 300°C under pressures between 100 and 200 atmospheres, the polymer is a liquid or a semi-solid. This is no use for the production of fibres, but if the pressure is increased to the order of 1000 atmospheres the product has a molecular weight of about 10,000 and will yield continuous filaments with an adequate degree of strength. Pressure and heat are not enough in themselves to initiate polymerization, and the presence of a catalyst is nearly always necessary. Catalysts which have been used in the preparation of polyethylene are benzoyl peroxide, ditertiary butyl peroxide, hydrogen peroxide and **per-sulphates**. In 1950 Ziegler reported that compounds of the nature of $\text{Al}(\text{C}_2\text{H}_5)_3$ or TiCl_4 , when used as catalysts, made it possible to obtain polyethylene at much lower pressures. This reduced the cost of the extremely expensive plant required for the high-pressure technique.

The work of Ziegler and Natta led to the preparation of stereospecific polymers by the use of selected catalysts. The term denotes spatial arrangement of substituents of asymmetric carbon atoms in individual units.

When the substituent groups are all on the same side of the plane of the main chain the polymer is described as isotactic, and syndiotactic refers to the structure in which they alternate in their spatial relationship to the plane. In an atactic polymer the arrangement is random. These alternative spatial arrangements are illustrated diagrammatically in Fig. 2.1.

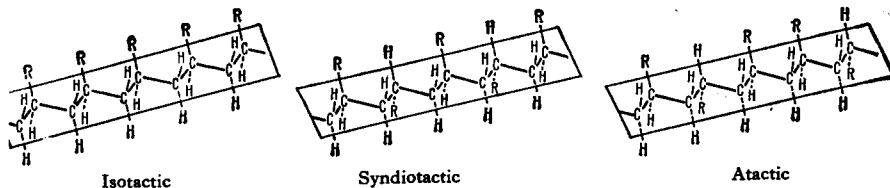
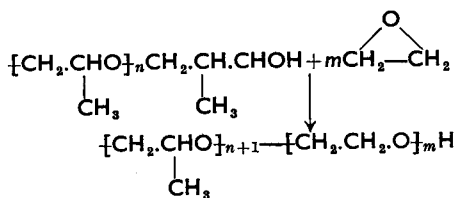

Fig. 2.1 Planar representation of chains of polymeric alpha-olefines

(Courtesy of Ciba)

Block copolymers

In a normal copolymer the distribution of the two components, A and B, would be ABABABAB. In a block copolymer, however, the arrangement would be $A_n B_m A_n B_m$. There are various methods by which these block copolymers may be prepared and the simplest is to react a prepolymer of one of the components which has an active end group with the second monomer. As an example, one block may be a polypropylene oxide chain ending in a hydroxyl group. This will then react with m molecules of ethylene oxide as follows:



The $-\text{CH}_2\text{-CH}_2\text{-OH}$ end group reacts with polypropylene oxide giving another hydroxyl end group capable of again reacting with ethylene oxide.

Graft Copolymers

The general structure of a graft copolymer would be:

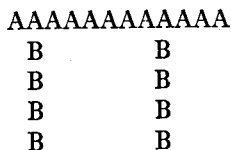

Adkins and Houtz (*J. Amer. Chem. Soc.*, 55, 1609, 1933) were the first to demonstrate that polymerized side chains could be attached to the back-

bone of a pre-formed polymer. It is necessary to create free radicles or tri-valent carbon atoms in the main chain. This has been done by irradiation with γ -rays or ultraviolet light. Thus polyethylene, under the influence of γ -rays emitted by radio-active cobalt, gives active carbon sites in the following manner:

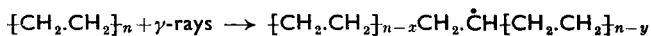

To this free radicle polystyrene can be grafted

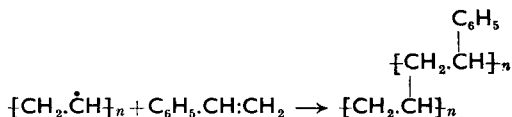

In a similar manner isotactic polypropylene can be treated with oxygen under pressure at 70 to 80°C to yield hydroperoxide groups

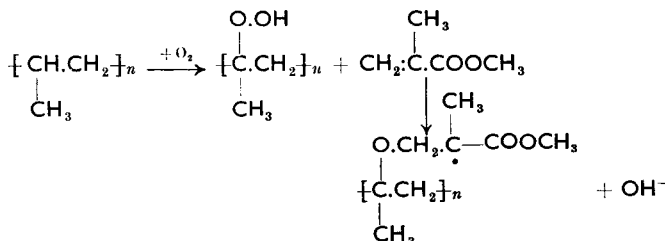

Reactions of this nature have an interesting bearing on the manufacture of polypropylene fibres.

The uniting together of ethylene molecules is represented by the general equation, $nR \rightarrow R_n$, and is an example of addition polymerization. Another form is condensation polymerization when two molecules unite with the elimination of water, expressed as a generalization as follows:

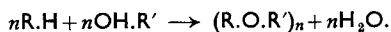

The first commercially successful plastic, or synthetic resin as it was called in those days, was bakelite. This was a condensation polymer produced from formaldehyde and phenol, with the elimination of water as shown below:

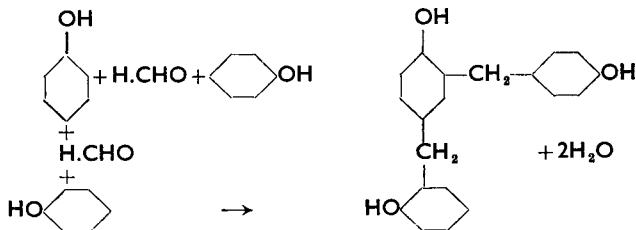

Other condensation polymers of great significance in the textile industry

are the polyamides and the polyesters which will be described in greater detail in the chapters dealing with synthetic fibres.

All textile fibres are composed of macromolecules produced by polymerization of simpler compounds. The mechanism by which this is achieved in nature is obscure, but much has been learned from the chemistry of the fibre-forming complex molecules of synthetic origin. Not every polymer can make a textile fibre: starch, for instance, is a polymer built out of glucose units, and cotton is also composed of the same basic monomer. One is fibrous, but man has never succeeded in converting starch into a fibre. The difference lies in the spatial arrangement of the molecules. To make a successful fibre the macromolecules must be straight chains capable of lying parallel to each other in the direction of their longitudinal axis in such a way that they can exercise mutual attraction. The attractive forces are

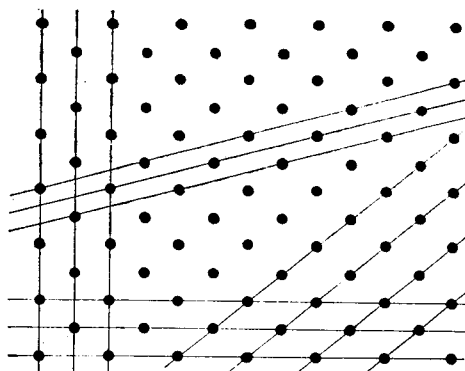

Fig. 2.2 Various reflecting planes of atoms in a crystal
(Courtesy of International Wool Secretariat)

either chemical bonds, hydrogen bonds, or Van der Waals forces which are of a physical nature.

The evidence for the existence of these parallel straight chains in textile fibres is based upon X-ray phenomena. In 1912 Laue reported that characteristic patterns of dots appeared on a sensitive paper placed in the path of a beam of X-rays which had passed through a crystal. Sir William Bragg examined patterns obtained by reflecting the X-rays from the surface of a crystal. These responded to mathematical treatment and yielded fundamental information about the spatial arrangement of the atoms in a number of crystalline substances. During the decade commencing in 1920, the X-ray technique was used by Astbury, Meyer and Mark to investigate the molecular arrangement of textile fibres. It was found that when a beam of X-rays is caused to pass through a fibre at a right-angle to its longitudinal axis, a definite pattern of dark spots is produced. This shows that there must be some regular arrangement of molecules and atoms and it is therefore concluded that fibres contain crystalline portions; crystalline, in this

sense, meaning arrangement of the atoms in a definite recurring pattern.

If the regularly arranged atoms in a simple crystal are represented by the spots in Fig. 2.2 it will be apparent that there are many planes from which a beam of rays can be reflected. Some are indicated by the parallel lines.

Planes of atoms will only give bright images on sensitive paper when the reflected waves do not diminish their intensity by interference, but are in

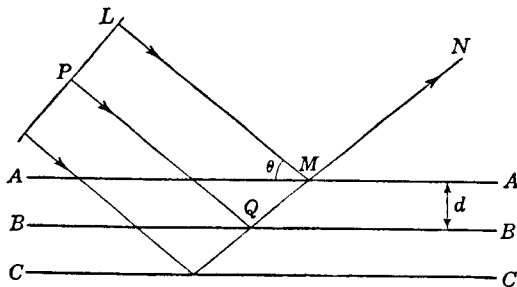

Fig. 2.3 X-ray reflection from equidistant planes



Fig. 2.4 X-ray rotation photograph of benzil
(From S. Glasstone, 'Textbook of physical chemistry', 2nd edition.
Copyright 1946. D. Van Nostrand Co., Inc., Princeton, New
Jersey)

phase and exhibit mutual reinforcement. In Fig. 2.3 *AA*, *BB*, and *CC* represent planes of atoms separated by the distance *d*. When a beam of parallel X-rays impinges at the angle θ , part of the beam (*LM*) will be reflected by the plane *AA* along the path *MN*. Some of the rays will penetrate to the layer *BB* and be reflected along *QN*. If the path *LMN* differs in length from *PQN* by a whole number of wavelengths, then the two beams will reinforce each other. The conditions under which such

reinforcement takes place is when Bragg's law is fulfilled, which is expressed by the equation

$$n\lambda = 2d \sin \theta,$$

where n is a simple whole number (1, 2, or 3) and λ is the wavelength.

When λ and θ are known it is thus easy to calculate d , which is a measurement of fundamental importance in examining crystal structure.

To gain all the information possible the angles θ at which reinforcement occurs must be observed for all possible planes of atoms (see Fig. 2.2). In order to ensure that this has been done the crystal must be rotated through 360° whilst the X-ray is directed upon it. A typical rotation photograph is that for a crystal of benzil $C_6H_5.CO.CO.C_6H_5$ shown in Fig. 2.4.

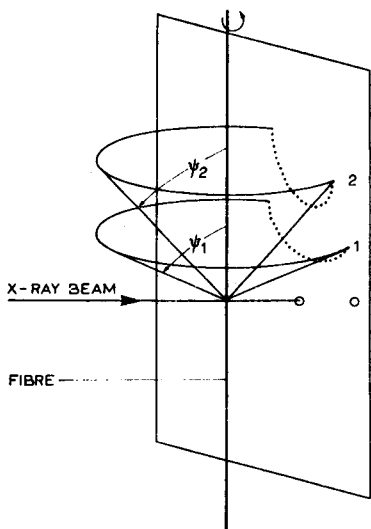

Fig. 2.5 (a)

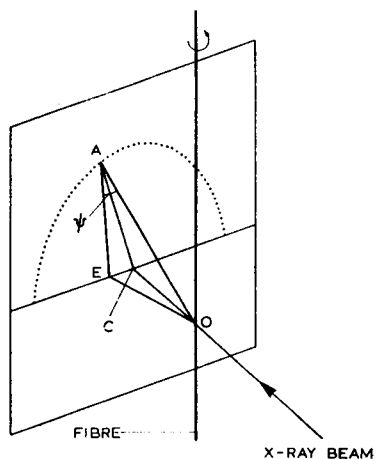

Fig. 2.5 (b)

If an X-ray beam be transmitted through a fibre which is rotated through 360 degrees the diffraction spots will occur on the bases of a series of cones forming angles of ψ_1 , ψ_2 , etc. respectively with the vertical axis, as illustrated in Fig. 2.5 (a). If a sheet of photographic film be inserted so that it intersects the cones the pattern of the spots will take the form of hyperbolae. The angle ψ is related to the repeat b of the structural pattern in the following manner:

$$\psi = \frac{\mu\lambda}{b}$$

where μ is a whole number and λ is the wavelength of the X-ray beam. It is usual to use an X-ray tube with a copper target giving a wavelength of 1.52 \AA (0.152 nm).

The repeat distance b can be calculated from a fibre X-ray diagram, Fig. 2.5 (b), in the following manner:

$$b = \frac{\lambda}{\cos \psi}$$

but
$$\cos \psi = \frac{AE}{AO} = \frac{AE}{\sqrt{(CA^2 + CO^2)}} = \frac{AE}{\sqrt{(CA^2 + O^2)}}$$

The X-ray diagrams for ramie and Terylene in Figs. 2.6 and 2.7 below show a similarity to the typical crystal rotation photograph. This is because

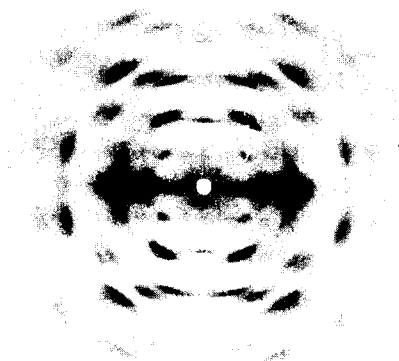

Fig. 2.6 X-ray diagram of ramie

(Courtesy of H. J. Woods)



Fig. 2.7 X-ray diagram of Terylene

(Courtesy of Elsevier, 'Fibres from synthetic polymers')

in transmitting through a fibre the ray is bound to fall upon planes of atoms at all possible angles.

As might be expected, textile fibres give more blurred images than do pure crystalline substances, and there is also a greater number of diffused rays over the whole area of the photographic plate. This is due to the amorphous regions where the fibre polymer molecules are not arranged in a regular pattern. There is much chemical and physical evidence to support the view that all textile fibres consist of crystalline and amorphous regions in which the molecules are arranged at random. It is probable that the same long-chain molecule passes through both amorphous and crystalline regions.

It was originally believed that a structure to which the name *fringed*

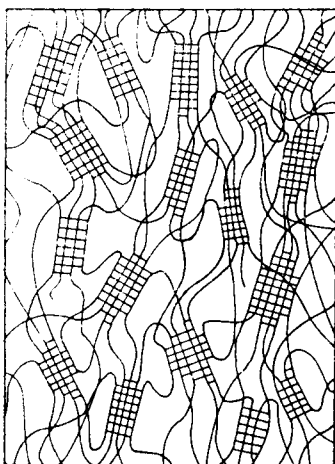

Fig. 2.8 (a)—Fringed micelle structure

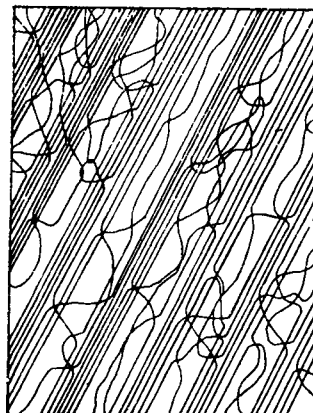

Fig. 2.8 (b)—Fringed fibril structure

(*J. W. S. Hearle, J.T.I., 1962, p. 451*)

micelle was applied represented the arrangement of the molecules in the fibre. This is shown diagrammatically in Fig. 2.8 (a) in which the heavily shaded crystalline portions end in fringes of molecules departing in different directions. Hearle, however (*J. Polymer Sci.*, 1958, 8, 432) proposed a somewhat different model, to explain certain electron microscope evidence. He suggested that fibres contained *fringed fibrils* in which the orientated or crystalline regions were very long structures winding their way through the fibre and separated by non-crystalline regions, as illustrated in Fig. 2.8 (b).

The fibrils in man-made fibres assume a somewhat random position in relation to each other with an overall tendency towards longitudinal orientation, but with many aberrations as shown in Fig. 2.9. The natural fibres of plant origin contain a high proportion of fibrillar structure. The

proportion in cotton, for example, is about two thirds. Their configuration is in the form of spirals as shown in Fig. 2.10 with the intervening space filled with non-crystalline regions.

The relative proportions of crystalline and amorphous regions can be ascertained in a number of ways. One of the simplest is by density. It is possible to calculate the density of the crystalline region from a knowledge of the spacing between the molecules and the molecular weight of the

Direction ↑ of
Fibre | Axis



Fig. 2.9—Fibrillar structure in a man-made fibre

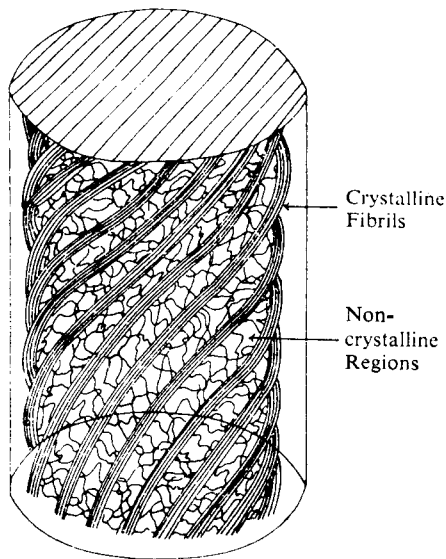

Fig. 2.10—Fibrillar structure in a plant fibre

(*J. W. S. Hearle, J.T.I., 1962, p. 455*)

units in the chain. Since the density of the fibre is less than the theoretical density of the crystalline portions, it is easy to determine how much is amorphous. In the case of Terylene, infra-red absorption spectra have provided useful information. Crystalline Terylene gives two absorption bands, whereas randomly-arranged molecules only give one. One band, therefore, is common to both states and the other is not. From the relative intensities of these bands it is possible to calculate the proportion of crystalline structure in the fibre.

Very much work has been done on chemical methods of determining the proportions of the states, particularly in the case of cellulose, which responds more readily than other fibres to this approach. Methods are based on the assumption that amorphous regions are more accessible to chemicals than the crystalline ones. If cellulose is treated with $N/1$ hydrochloric acid the amorphous phase will hydrolyse first and, by studying the rate of disintegration of the molecules, it has been possible to arrive at reasonably accurate estimates of the relative proportions of the two states. It must, however, be emphasized that some doubts have been cast on the accuracy of the results obtained by this method. The amount of scattering in the X-ray diagram can be used to estimate the randomly-arranged component. This, however, requires a very specialized approach and a detailed description would be out of place.

As a result of these investigations it is generally agreed that naturally-occurring cellulosic fibres contain of the order of 60 to 70 per cent of molecules orientated in crystalline structure. The regenerated celluloses contain 30 to 40 per cent, Terylene 50 per cent, and nylon between 50 and 60 per cent.

The readiness with which long-chain polymers crystallize is governed by the structure of the monomer and the linearity of the main chain. In the case of cellulose this relationship is referred to in the next chapter. Linear main chains are produced by the condensation or polymerization of bifunctional monomers which are those in which the uniting groups are such that the molecules can only link up end to end. A good example of this is nylon 66 made by the co-polymerization of adipic acid



and hexamethylene diamine,

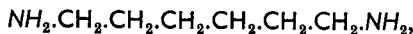

in which the reacting groups are italicized. A trifunctional monomer which will not give a straight chain is glycerol which condenses with succinic acid to give a complex polymer branching in all directions.

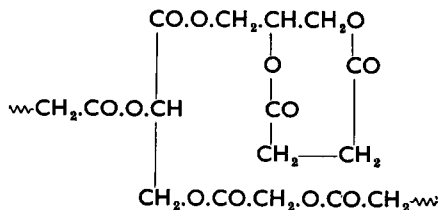

The significance of chain configuration is illustrated in the polypropylenes. These, as already explained, exist in isotactic and atactic forms. The spatial arrangements of the two forms are shown in Figs. 2.11 (a) and (b). The black line in 2.11 (a) shows the helical structure of isotactic poly-

propylene. The reason for the helical configuration is that there is not room for the methyl groups in a zig-zag chain.

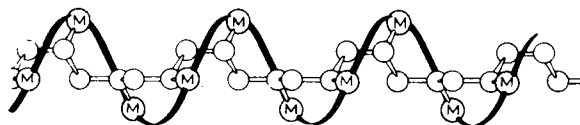

Fig. 2.11 (a) Isotactic polypropylene
(*M* = Methyl groups)

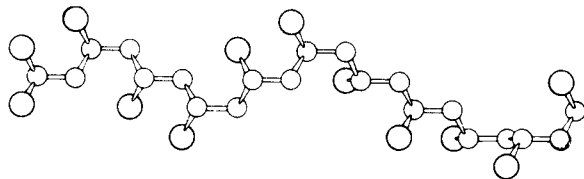

Fig. 2.11 (b) Atactic polypropylene
(Courtesy of 'Ciba review')

It was not until the technique of stereospecific polymerization of propylene was developed that it was possible to spin useful fibres from polypropylene. The isotactic form gives fibres with a melting point of 170°C and a tenacity of 7/8 g per denier, which compares with steel wire of equivalent cross-section.

Side chains must be absent or comparatively simple because, if they are bulky, they keep the main chains apart and prevent the formation of compact crystal structures. The effect of this is to separate the main chains from each other by a distance which is too great for the binding forces to come into play. This is well illustrated by the progressive methoxymethylation of nylon, as demonstrated in Table 2.1.

Table 2.1 Progressive methoxymethylation of nylon

	Methoxyl (%)	Amide groups substituted (%)	Melting point (°C)	Elastic stretch (%)
Polyhexamethylene adipamide (unorientated)	0	0	264	45
N. Methoxymethylated product	5.77	22	185	285
N. Methoxymethylated product	7.81	32	130	370

The melting point falls as the binding forces holding chains together decrease, and higher elastic stretch is an indication of random molecular arrangement. The ethylene glycol condensation polymers formed with

the isomeric phthalic acids afford further evidence. Terephthalic acid condenses with ethylene glycol to give a straight-chain polymer with a very 'streamlined profile':

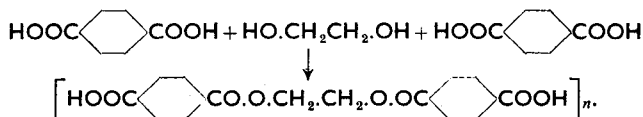

This forms a highly crystalline polymer possessing excellent fibre-forming properties. Metaphthalic acid

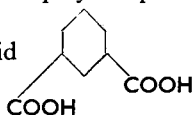

gives a non-crystalline pro-

duct with ethylene glycol which can be spun into a fibre. This, however, is no use because of its low melting point and virtual absence of tensile strength.

Finally the product obtained with orthophthalic acid

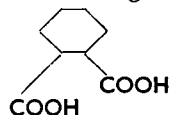

is non-crystalline and entirely devoid of fibre-forming attributes.

The intermolecular forces which come into play in the orientated or crystalline regions are of three kinds. The most powerful are the chemical linkages, then the phenomenon known as hydrogen bonding, and finally the rather ill-defined physical attraction known as Van der Waals forces. The effect of these forces, which will be proportional to the degree of orientation, is shown in Table 2.2.

Table 2.2

(FIERZ-DAVID, *Abriss der Chemische Technologie der Textilfasern*, 1948, 57)

<i>Fibre</i>	<i>Orientation</i>	<i>Tenacity</i> (g/denier)
Fortisan H	Extreme	8-9
Fortisan	Extreme	6
Durafil	Extreme	5.5
Tenasco	High	3.6
Viscose rayon	Moderate	2
Viscose monofil	Slight	1

The chemical bonds are found in the naturally-occurring protein fibres. Salt linkages between adjacent amino and carboxyl groups probably exist in wool,

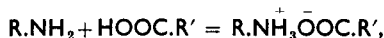

and adjacent molecular chains are also united by cystine linkages:

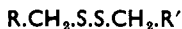

Additional chemical linkages can be created by causing amino groups in adjacent protein molecules to condense with formaldehyde

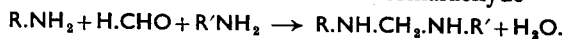

Hydrogen bonding

This is a phenomenon which plays a great part in textile technology and a few words of explanation are therefore desirable. There is much evidence to show that a hydrogen atom which has already united with one monovalent atom or group can enter into a loose form of combination with another strongly electronegative atom. The outstanding example is the existence of the stable HF_2^- ion. The fluorine atom is intensely electronegative and the HF_2^- ion probably results from one hydrogen nucleus (proton) holding two fluorine atoms by valency or electrostatic forces. This phenomenon is referred to as the formation of a hydrogen bond with the second fluorine atom. It is the electronegative elements which can enter into a hydrogen bond union and the most important are oxygen, nitrogen, sulphur, and fluorine.

According to its molecular weight, and by analogy with other compounds of comparable structure, water should be a gas. It is a liquid because the molecules are held together by numerous hydrogen bonds (indicated by dotted lines):

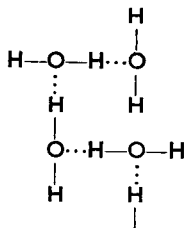

In the same way dimethyl ether is a very volatile liquid but has the same empirical formula as ethyl alcohol which boils at 78°C . This is accounted for by the formation of hydrogen bonds.

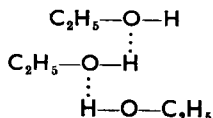

There are good reasons for believing that the hydrogen bond is not similar to a covalent or other chemical linkage. Its bond energy is of the order of 5 kcal/molecule compared with corresponding figures of the order of 50 to 120 with conventional bonds. It has been established that in the $\text{O}-\text{H} \cdots \text{O}$ system, the distance between the two oxygen atoms is 2.5 to 2.9 Å (0.25 to 0.29 nm), but the equilibrium position of the hydrogen atom is 1 Å (0.1 nm) from one oxygen and 1.5 to 1.9 Å (0.15 to 0.19 nm) from the other, indicating, again, that the hydrogen bond is of a different order

from that uniting the oxygen and the hydrogen in the hydroxyl group. The OH group probably constitutes a dipole R.O.H and this permits electrostatic attraction to operate between the positive end of the dipole and an adjacent strongly electronegative atom. (For further information see BARRER, *J.S.D.C.*, 1941, 264, and PAULING, *The Nature of the Chemical Bond*.)

Finally, there are the attractive forces between adjacent chains which cannot be due to hydrogen bonding or to normal chemical valency. Polythene, for instance, when orientated, exhibits quite a high measure of cohesion in the crystalline portion, and this effect is more marked with polyisotactic propylene. The straight $\text{CH}_2\text{CH}_2\text{CH}_2\text{CH}_2$ chain has no scope for hydrogen bonding and the possibility of chemical linkage is entirely absent. In these cases the attraction is due to physical molecular cohesion attributed to what are called Van der Waals forces.

The bond energy is used to express the strength of the attractive force holding atoms together. The energy is measured in terms of the number of kilocalories per molecule necessary to sever the bond. To give an illustration of the relative strengths of these linkages the figures in Table 2.3 are quoted.

Table 2.3

Nature of bond	Bond energy (kcal/molecule)
—CH=CH—	100
—C—C—	58.6
C=O	149
—C—H	87
Salt linkage in wool	13
Hydrogen bond	5
Van der Waals forces	2

The energies of single bonds provide fundamental information, but the strength of a textile fibre depends on the sum of all the bonds and other binding forces. This is expressed as the cohesive force of standard length of the chain molecule. Some comparative figures in Table 2.4 are quoted from *Fibre Science* (Textile Institute).

Molecular weight of polymers

There are various ways in which the molecular weights of the giant molecules in fibrous substances can be determined. A simple method, applicable to molecular weights of not less than 40,000, is by osmotic pressure.

The osmotic pressure apparatus (Fig. 2.12) consists of an open ended

Table 2.4

Nature of chain	Cohesive force (Cals per 5 Å (0.5nm) chain length)
(—CH ₂ .CH ₂ —) _n Polythene	1000
(—CH ₂ .CHCl—) _n Polyvinyl chloride	2600
Cellulose	6200
(—CO.NH.CH ₂ —) _n Polyamide	5800
—CO.NH.CH(R)— Silk fibroin	9800

cylindrical cell *A* to which is attached a filling tube *B* and a capillary measuring tube *C*. The membranes are attached to the open ends of *A* and held in place by perforated metal plates clamped with bolts. The solution of the polymer is then run into *B* and a steel rod with a diameter which is slightly less than the inside measurement of *B* is inserted. This adjusts the initial level in *B* to a height convenient for observation and also serves to keep the meniscus in *B* in a constant position. The whole apparatus is then immersed in a vessel containing the solvent to a depth sufficient to ensure that the lower end of *D*, which is a capillary tube of the same internal diameter as *C*, is immersed. A meniscus of the solvent will be formed in *D* which is a measure of the surface tension of the solvent alone and, as the latter passes through the membranes into the open ended cell, it will increase the volume inside the osmometer, causing the meniscus in *C* to rise. The difference between the levels in *C* and *D* is proportional to the osmotic pressure which bears a direct relationship to the molecular weight of the polymer in solution.

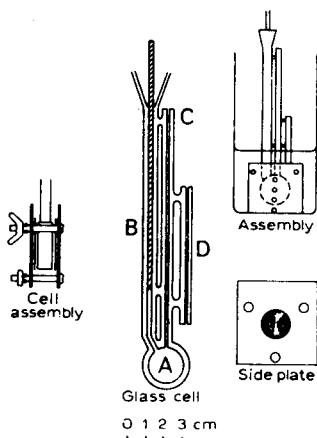

Fig. 2.12 Zimm-Myerson osmometer

Reprinted from *J. Amer. Chem. Soc.*, 1946, 46, 911. Copyright 1946.
By permission of copyright owner

Most polymers have end groups which only occur at the termination of the chains. Thus nylon can be represented as:



There is only one COOH group and one NH₂ group per molecule, therefore

$$\text{Molecular weight} = \frac{(\text{Wt of polymer}) (\text{No. of end groups per molecule})}{(\text{Number of end groups estimated})}$$

The primary amino groups can be determined by dissolving the fibre in a phenol, methanol, water mixture and titrating with dilute acid, ascertaining the end point by conductivity measurements. The carboxylic acid end groups are estimated by dissolving the nylon in hot benzyl alcohol and titrating with dilute alkali in the presence of phenolphthalein.

The end-group method was applied to the determination of the molecular weight of cellulose by Haworth and others. The structural formula for cellulose is discussed in Chapter 3. The two end groups have the structures

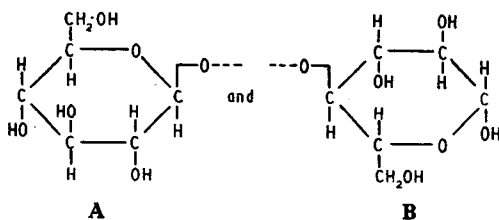

whilst the groups within the chain are represented by the following formula:

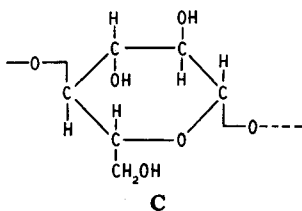

If all the hydroxyl groups are converted into —O.CH₃ by methylation, the two end glucose units will each have four methoxy groups compared with three in all the other components in the chain. When the methylated cellulose is hydrolysed, **B** above breaks down with the loss of one methyl group. There will therefore only be one tetramethyl glucose unit in the product of hydrolysis, and this can be separated by distillation under reduced pressure. There has, however, been some dispute about the accuracy of this method. More recently Wolfram (*J. Amer. Chem. Soc.* 1937, 1938, 1939) formed mercaptals with the aldehyde structural isomer

of the end glucose unit and then determined the amount of sulphur present in the product:

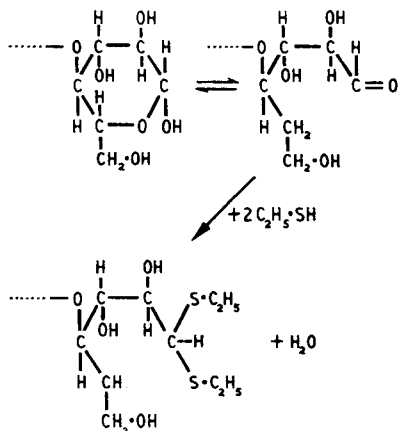

The ultracentrifuge has been a useful tool in determining molecular weights. It has an advantage over other methods because it is reasonably accurate over a range of 5000 to 100,000. A dilute solution of the polymer is centrifuged in a specially designed cell until equilibrium is established in the sedimentation of the heavier molecules. The concentration of the solute in various parts of the cell is measured from time to time by the absorption of a transmitted beam of monochromatic light or by refractive index measurements. The molecular weight is calculated from a relationship between the density of the solvent, the angular velocity of the centrifuge, and the distance from the centre of the rotor at which the maximum concentration of the solute is situated at equilibrium.

In 1944 Debye showed that when a beam of light passes through a solution of a non-absorbing polymer the scattering bears a relationship to the size and shape of the molecules. The scattering is caused by slight lack of uniformity in the distribution of the molecules, and the larger they are the less mobile they become, and therefore the greater is the possibility of a heterogeneous condition.

In describing a polymer, it is often more important to know the number of monomer units linked together than the actual mean molecular weight M . The term degree of polymerization, often abbreviated to D.P., is used to express this factor. Thus in cellulose the molecular weight of the single glucose residue is 162 and $\text{D.P.} = \frac{M}{162}$. Another term in common use is the fine structure of a fibre, and this refers to the macromolecular constitution as opposed to the morphological appearance.

Swelling

All textile fibres exhibit the phenomenon of swelling to a greater or less degree, and this is intimately bound up with the fine structure. When immersed in water there is an alteration in the dimensions of a fibre, and this is almost entirely in diameter and only to an insignificant extent in the direction of the longitudinal axis, as illustrated in Table 2.5.

The water molecules only penetrate into the amorphous regions of the fibre. This has been established, in the case of cotton, because X-ray diffraction photographs have shown that the intermolecular spacing in the crystalline portions is not altered when the fibre is in the swollen state. In Table 2.5 it will be seen that the highest degree of swelling is found in viscose rayon, where it is known that the amount of crystallinity is extremely low. Nylon, which has highly orientated molecules, only swells 5 per cent of its diameter. The amount of swelling is not only a measure of the accessibility of the fibre to water but also to dyestuffs and chemicals in solution. Viscose adsorbs more dye than cotton because the dissolved dyestuff can wander more freely into the amorphous regions where there exists a continuous phase on each side of the boundary of the fibre. At the other end of the scale Terylene can have a crystallinity as high as 75 per cent, and it presents great difficulty in dyeing because there is so little opportunity for the dye molecules to migrate into the fibre.

Closely associated with the property of swelling is the amount of moisture that fibres will contain when at equilibrium with the atmosphere. The water content will depend upon the relative humidity of the surrounding atmosphere. Many physical properties of textiles vary considerably with moisture content, so it is desirable to specify a standard atmosphere in which all measurements should be made. By convention this is 65 per cent relative humidity at 70°C (158°F). Under such conditions fibres have the following moisture contents:

Wool	16 per cent	Terylene	0.4 per cent
Cotton	8.4 per cent	Silk	11 per cent
Viscose	12 per cent	Orlon	0.9 per cent
Nylon	4 per cent		

There are two factors which determine the amount of water which a fibre will retain when in equilibrium with the surrounding atmosphere. The first, and by far the more important, is the extent of the amorphous regions because this determines the accessibility to water molecules. The second is the number of polar groups in the molecular chain because they can exercise secondary affinities for water. It is due to the absence of polar groups that Terylene and Orlon are extremely low in moisture retention and, conversely, that silk is higher than might be expected.

The moisture content of textiles is of great industrial importance. The absorption of water vapour from air is a reversible process. The fibre will

take up more moisture if the atmosphere becomes damp and will give it up if the air becomes dry. It is obvious, therefore, that the actual weight of a given mass of wool or any other fibre will vary from day to day according to the state of the air. The moisture content of the atmosphere is expressed as its relative humidity. The quantity of water which the air can take up is governed by the condition that the pressure of the water vapour, independently of that of the air, cannot exceed a certain value for any given temperature. The maximum pressure is the same as that which the water vapour would exert if no air were present. The actual pressure of air saturated with water vapour is the sum of the two pressures, that is to say,

Table 2.5
(Quoted from *Artificial fibres*, Moncrieff)

<i>Fibre</i>	<i>Swelling (width increase per cent)</i>	<i>Swelling (length increase per cent)</i>
Viscose	26	3-5
Silk	18.7	1.7
Wool	16	1.2
Cotton	14	1.2
Nylon	5	1.2

the pressure of the atmosphere and the maximum pressure of water vapour at that particular atmospheric temperature.

The dampness or dryness of air depends upon the pressure of the water vapour present compared with the maximum for the atmospheric temperature. The nearer the actual pressure of the water vapour present approaches to the maximum, the damper the air is, and, on the other hand, the farther apart the two pressures are the drier it is. When the water exerts the maximum vapour pressure for the atmospheric temperature and no more can be taken up, the air is said to be saturated. When damp textile materials are exposed to saturated air they cannot lose any moisture, but if they are in a dry state they can absorb water from the air.

Relative humidity

This is the term used to express the state of the air with regard to its moisture content. It is really the percentage which the vapour pressure of the moisture present is of the maximum vapour pressure corresponding with the atmospheric temperature. Expressed in another way:

$$\text{Relative humidity} = \frac{p}{p_1} \times 100,$$

where p represents the actual pressure of the water vapour, and p_1 the

maximum pressure at the same temperature. Relative humidities are usually determined with wet- and dry-bulb thermometers or with hygrometers.

For commercial dealings it is essential that there should be an agreed standard moisture content for textile fibres. The so-called regains for various fibres have been arrived at by rather empirical methods but have received universal commercial recognition. The regain is the average amount of water which 100 lb of completely dried material will take up from the air when exposed during a considerable period. The regain for cotton, for instance, was determined by exposing 100 lb of it, which had been dried out completely to the atmosphere and then, finding the point of equilibrium, by weighing it daily over a considerable period. It was found that the average weight was $108\frac{1}{2}$ lb, and $8\frac{1}{2}$ was said to be the regain of cotton. It must be emphasized that $8\frac{1}{2}$ regain does not mean that cotton contains $8\frac{1}{2}$ per cent of moisture. It means that $108\frac{1}{2}$ lb of cotton contain $8\frac{1}{2}$ lb of moisture, which is equivalent to 7.9 per cent. The regains recognized for various fibres are given in Table 2.6.

Table 2.6

	<i>per cent</i>		<i>per cent</i>
Cotton	8.5	Carded woollen yarns	17
Silk	11	Flax and hemp	12
Viscose and cuprammonium rayon	11	Jute	13.75
Acetate rayon	6	Nylon	4.5
Worsted yarns	18.25	Terylene	0.4
		Orlon	1.5

The relationship between the regain of wool and the relative humidity at three different temperatures is shown in Fig. 2.13.

An examination of this graph reveals that an increase of relative humidity from 50 to 70 at 24°C (75°F) would cause a change from $112\frac{1}{2}$ lb to 116 lb in the weight of 100 lb of dry wool. Fluctuations of this order are not without significance, especially when dealing with an expensive fibre.

In commerce, yarns or fabrics are bought and sold either by implication or by contract at 'correct condition' weight. This is calculated by drying a weighed sample until it is constant in weight, when the true dry weight is revealed. To this the standard regain is added to give the 'correct condition' weight. Giving a specific numerical example: a reputed 10-lb bundle of cotton yarn weighed 10.19 lb at the beginning of the test. Out of this a random sample weighing 372.1 g was taken, of which the dry weight was 334.8 g. Therefore the percentage dry weight equals

$$\frac{334.8 \times 100}{372.1} = 89.97 \text{ per cent.}$$

To this must be added 8.5 per cent regain, giving 97.62. The difference between 97.62 and 100 is the excess of moisture present (as a percentage).

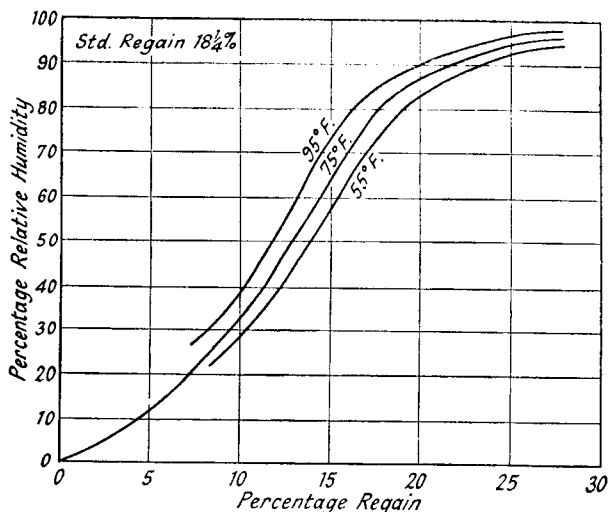

Fig. 2.13 Regain curves for wool at different temperatures

The original bundle contained $\frac{10.16 \times 97.62}{100}$, which is equal to 9.92 lb of cotton at 'correct condition' weight.

The term conditioning is applied to the addition of moisture to finished textiles. There is no reason why goods should be sold containing less than their standard allowance of water, especially when a condition of sale is that there should be a minimum weight for the article. The final hot pressing of fabrics or garments, or the drying of yarn, may often leave less than the standard permitted regain. In such cases conditioning may be practised by exposure to an atmosphere in which a high relative humidity is maintained.

Moisture determination in connexion with large-scale yarn purchasing is usually carried out in specially-designed conditioning ovens. These are not commonly required by dyers and finishers. It is, however, often desirable to carry out quick moisture-content determinations for routine process control. The small, rapid regain apparatus shown in Fig. 2.14 is suitable for this. It consists of an air heater and a blower which impels a stream of hot air over the sample to be tested.

The temperature of the air stream can be controlled thermostatically over a range of 80°C (176°F) to 130°C (266°F). Having ascertained the weight of the container with its sealing caps, a known weight of yarn is put into it. With the caps removed hot air is blown through the sample. The container, with the caps replaced, is weighed at intervals until it is constant in weight, which indicates that all the moisture has been removed. Thus the dry weight is ascertained and the percentage regain or moisture content can be calculated.

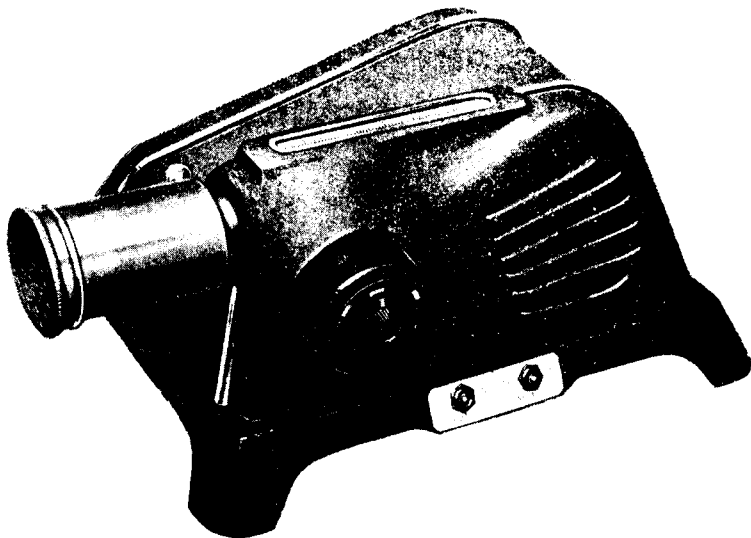

Fig. 2.14 Instrument for rapid determination of moisture
(Courtesy of Reynolds and Branson)

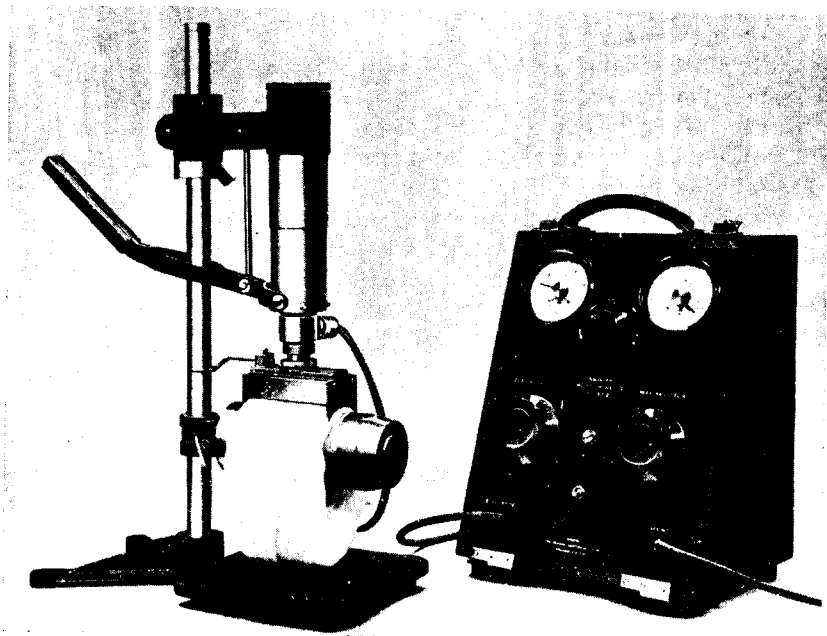

Fig. 2.15 Shirley moisture meter
(Courtesy of Record Electrical Co.)

There are also recording instruments based upon the relationship between the moisture content and the electrical properties of the material. The Shirley moisture meter (Fig. 2.15) depends upon the effect of moisture on the resistance of a sample of material compressed between two electrodes.

Classification of textile fibres

Before entering upon a detailed description of the individual textile fibres, it is desirable to refer briefly to the groups into which they may be classified. The first broad division is:

- (1) Naturally-occurring fibres of vegetable origin.
- (2) Naturally-occurring fibres of animal origin.
- (3) Regenerated man-made fibres which use some naturally-occurring substance as the raw material.
- (4) Synthetic man-made fibres which use some simple artificially-prepared organic compound as the initial raw material.
- (5) Mineral fibres which are entirely inorganic.

(1) Natural fibres of vegetable origin

These may be either unicellular or multicellular. Cotton is the only unicellular vegetable fibre which, as the classification implies, consists of a single cell. The multicellular fibres are usually extracted from the stems of herbaceous plants. The better known members of this group are flax, ramie, jute, and hemp.

(2) Animal fibres

These are either hairs or secretions of animal origin. Wool is the hair fibre with the greatest world consumption in this group. Other examples of animal fibres are mohair obtained from the Angora goat which originated in Turkey, cashmere from the Tibetan cashmere goat reared in China, Northern India, and Iran, and alpaca from a South American animal closely related to the llama. Of animal secretions the outstanding example is silk.

(3) Regenerated man-made fibres

These usually consist of complex substances of natural origin which, in themselves, are no use as textile fibres, but which can by chemical and mechanical means be converted into continuous filaments suitable for use in textile industries. The classical example is viscose rayon. Cellulose, derived from wood pulp, is converted into a form which is a viscous liquid. This is subsequently forced through very fine orifices into a coagulating bath where it is precipitated in the form of a continuous filament. Other regenerated fibres, such as cuprammonium rayon and acetate yarn, are made from cotton linters, the useless fibres at the base of the seed coat. A more recently developed regenerated fibre of vegetable origin is algininate

made from alginic acid extracted from seaweed. This, however, has only limited use for specialized purposes at present.

Regenerated fibres of protein origin

The success of the regenerated cellulosic fibres stimulated the imagination of chemists. The obvious sequel was to produce a regenerated protein with properties resembling wool or silk. Much research and capital expenditure has been devoted to the production of lanital from milk casein, ardil from ground-nut protein, saran from soya bean, and vicara from maize. None of them proved really commercially successful and their manufacture has now virtually ceased.

(4) *Synthetic fibres*

The pioneer in the field of truly synthetic fibres was Carothers, who demonstrated that two comparatively simple compounds derived from phenol, namely, hexamethylenediamine and adipic acid, could be caused to polymerize to form a potentially fibrous polymer. This was spun into yarn which was successfully placed on the market as nylon. Shortly afterwards ethylene glycol and terephthalic acid were condensed to a polymer from which Terylene or Dacron was made. Ethylene is a by-product in the cracking of petroleum and is the starting point in the manufacture of vinyl chloride and acrylonitrile, from which Vinyon and the various polyacrylonitrile fibres respectively are spun.

(5) *Mineral fibres*

These form a small group which have limited uses for specialized purposes. Asbestos fibre can be spun and made into fireproof fabrics or protective clothing. Fibrous glass is made in substantial and increasing quantities and it is used for insulation tape, industrial filter cloths, and for many other purposes when bonded with polystyrene or other plastic substances.

3 · Cotton and the chemistry of cellulose

COTTON

COTTON is the oldest and the most important of the textile fibres. It has been used in the East and Middle East for thousands of years and was found in use in America when the continent was discovered. Cotton spinning and weaving were at one time Britain's most important industry, and during the last century cotton cloth was her greatest single export.

Each cotton fibre is a unicellular hair collected from the seed of the cotton plant. The function of these hairs is to protect the young unripe seed and to assist in its dispersal when it is mature. Each fibre, however long or short it may be, consists of one single complete vegetable cell. Although it differs from them in shape, cotton has the morphological characteristics of all vegetable cells. A fundamental difference between animal and vegetable cells is that the former have no protective wall whilst the latter have an outer skin composed of cellulose. Enclosed within this wall is the living protoplasm and a fluid which is essentially a solution of various mineral salts, called the cell sap. Protoplasm is a jelly-like substance of very complex chemical constitution composed of nitrogenous substances called proteins. In a young and growing cell the whole of the enclosed space is filled with protoplasm and cell sap so that the structure is distended and turgid. A part of the protoplasm will be collected into a denser and more refractive nucleus which is seen in the illustration of the cell in Fig. 3.1.

When the cell becomes mature the protoplasm dies and the sap disappears, leaving an almost empty structure. The cotton fibre is now dead and the contents of the cell are no longer visible under the microscope, but the dried-up protein and the salts which are deposited as the sap evaporates still remain in the central cavity. These are amongst the impurities which have to be removed when the cotton is scoured and bleached.

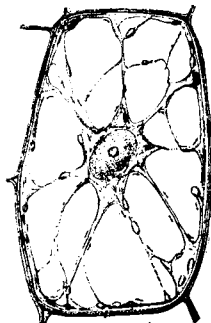

Fig. 3.1 Vegetable cell
(After Vines)

Natural history of cotton

The cotton plant belongs to the natural order of the MALVACEAE or, in colloquial language, the mallow family. It grows in sub-tropical climates, most of it being cultivated in Asia, Africa, America, Egypt, India, and other places. There are various species, and *Gossypium herbaceum* and *Gossypium*

hirsutum are mainly cultivated in America and India. *Gossypium peruvianum*, as its name implies, originated in Peru and spread to other South American countries, and *Gossypium barbadense* produces the fine silky Sea Island cotton. The plant is perennial but, after a few seasons, the value of the crop deteriorates both in quantity and quality; the best results are obtained when it is cultivated as an annual. In order to maintain a high standard of quality, constant attention to proper methods of cultivation and the use of fertilizers is necessary. Many generations of selective breeding and cross-fertilization are required to develop and make permanent a successful new strain.

The flowers appear in June and the cotton is usually ripe for gathering between August and October. As the flower withers it is succeeded by a closed pod. This contains seeds which are wrapped up in young, actively-growing hairs. When the seeds are nearly ripe the pod bursts open and the cotton hairs project, forming a white fluffy mass. This is called a boll. The fibres are now exposed to the sun when they complete their ripening, and the content of the cell gradually dries up, leaving the cotton in a fit state for harvesting. The proper drying up of the cell in the sun is a very important factor in producing one of the essential properties of cotton, namely, its characteristic twist. After the crop has been gathered the fibres are removed

from the seed by a process known as ginning. In this operation the seeds are fed into a hopper from the bottom of which they are conveyed by spirally grooved, leather-covered rollers past two knives known as doctors, which are set so that they will cut off fibres of a reasonable length, but leave behind on the seed the very short ones which are of no use for spinning. If the ginning is carried out carelessly some of the fibres are torn or ruptured and little knots of short fibres are carried on with the cotton. These give rise to white opaque spots or neps in the yarn which detract from its value. Un-ripe fibres which have died before they were fully matured also form neps. When examined under the microscope these consist of a mass



Fig. 3.2 Nep

of fibres all mixed up into a small aggregate (see Fig. 3.2). They are responsible for irregularity in the yarn and also tend to dye a deeper shade,

especially when composed of unripe fibres. The cotton, after ginning, will contain fragments of seed coat, portions of leaf or stem, and accidental dirt, all of which will have to be removed at a later stage. The short hairs remaining on the seed coat are known as linters and are collected and used for the manufacture of rayons. The remaining seeds, shorn of all fibres, are pressed to remove the bulk of the cotton-seed oil, which is used in soap making; and the residue forms cotton-seed cake, a valuable cattle food.

Structure of cotton fibre

Each hair consists of a single elongated cell. The upper end tapers to a point whilst the lower end is open where it has been removed from the seed by the gin. As is apparent in Fig. 3.3, the fibre contains many convolutions throughout its length. By microscopic examinations, differential staining, and the action of swelling agents, it is possible to discern four

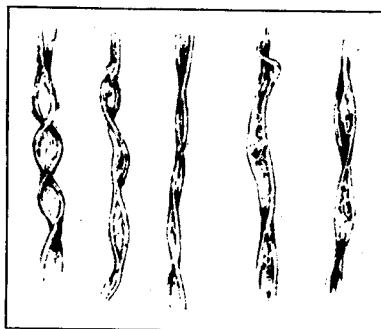
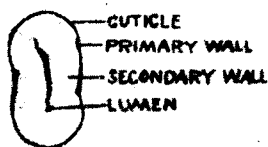

Fig. 3.3
Cotton fibres

principal components of the fibre, see Fig. 3.4 (a). There is the primary wall of the young cell which becomes the outer skin of the mature fibres and is, itself, covered with a cuticular layer of wax and pectic matter. The secondary wall constitutes the bulk of the cellulosic component and is laid



(Bailey)

Fig. 3.4 (a) Cross-section of cotton



Fig. 3.4 (b)
Growth rings

Anderson and Kerr, *Ind. Eng. Chem.* 1938)

down in successive layers visible as rings in the cross-section of a swollen fibre, corresponding with daily growth, Fig. 3.4 (b). Finally there is the lumen which is the cavity left by the dried cell sap and has a lining of a thin film of residual protein matter.

The cuticular cellulose is insoluble in Schweitzer's reagent, which is a solution of copper hydroxide in ammonia. The bulk of the cellulose

is, however, soluble. If a cotton fibre be mounted in Schweitzer's reagent on a microscope slide a series of globular swellings, as seen in Fig. 3.5, may

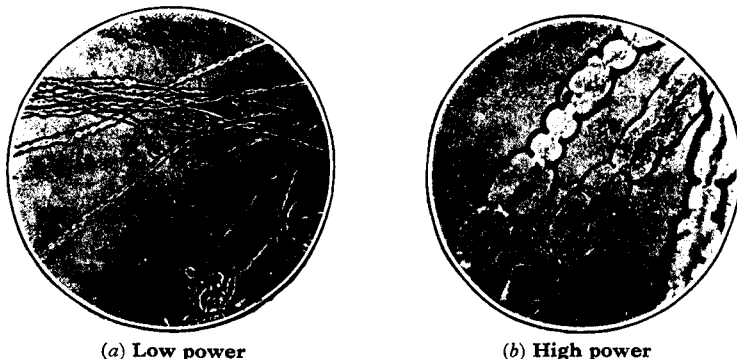

(a) Low power (b) High power
Fig. 3.5 Globular swellings of cotton in Schweitzer's reagent

be observed. The constricted portions are those where the insoluble cuticular layer has formed bands, and the swollen regions are where the cellulose, prior to dispersing into solution, has expanded and forced its way through the cuticle. If the microphotograph (Fig. 3.5b) be observed carefully it will be seen that the lumen is still apparent as a continuous thread in the centre. It has not disappeared because of the insolubility of the inner lining of the lumen.

In a fully ripened cotton fibre there are between 200 and 300 convolutions per inch. They are more numerous in the better qualities than in coarser varieties. Sometimes, however,

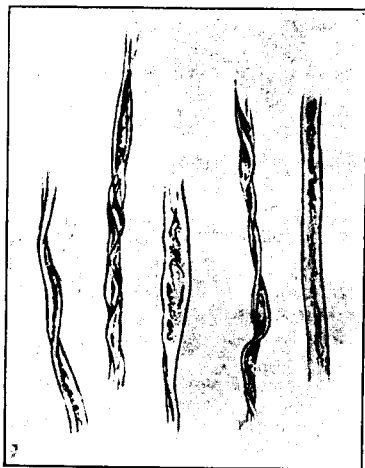

Fig. 3.6 Unripe or dead fibres

there are cells with comparatively little twist; they are the unripe or only partially matured ones. On occasions twist is entirely absent, the cell walls are extremely thin and the lumen is collapsed so that the fibres look more like flat pieces of slightly twisted tape. These are dead fibres in which growth came to an end before they were mature. All cotton contains a few dead and unripe fibres, but where conditions for growth are favourable the number is small. Bad seasons, overcrowding, neglect of cultivation, and worn-out plants are amongst the causes of excessive undeveloped fibres. Their microscopic appearance is shown in Fig. 3.6.

The detection of unripe or dead fibres is facilitated by treatment with

Schweitzer's reagent before examination. They have very little or no cuticle and therefore they do not form globular swellings. They can also be detected by microscopic examination under polarized light, because when lying at an angle of 40° to the axis of a selenite plate in a polarizing microscope they are purple to dark blue, changing to yellow or orange when rotated through 90° . Ripe fibres, on the other hand, are yellow to yellowish-green both before and after rotating through 90° .

Types of commercial cotton

Cotton may be classified according to the mean length of its fibres, in other words, its staple. As a rule, the valuable properties vary directly with the length of the fibre. A few typical varieties are as follows:

Sea Island cotton

This is of the highest quality and the most valuable of all the commercial cottons. It grows on the coast of the Gulf of Florida, in Barbados, and in other adjacent islands where the climate is favourable. The average length of the fibre is about two inches and the diameter which is $1/1500$ in. is less than that of any other cotton. Owing to its fineness it can be used for spinning counts as high as $1/200$. Sea Island cotton is also characterized by its uniformity, its lack of immature fibres, and its highly developed twist. Its most striking properties, in comparison with other varieties, are its highly developed lustre and its softness. Its colour varies from white to cream and well-made Sea Island cotton materials approach quite closely to silk in handle and appearance.

Egyptian cotton

There are two kinds of Egyptian cotton, one brown and the other white. It is, like Sea Island, very regular and contains few immature or dead fibres. Its average length lies between 1.5 and 1.75 in., its diameter is about $1/1500$ in. and it can be spun as fine as $1/200$ count. The brown discoloration can be removed during bleaching but it does make the process more difficult. White Egyptian cotton is not so fine, having a staple of about one inch, and is not suitable for counts higher than $1/70$.

South American cotton

This has a staple between 1 and 1.5 in. It has a mean diameter of $1/1300$ in., and has come into prominence recently because it appears to be very suitable for mixing with regenerated man-made fibres.

American cotton

This is cultivated in the United States, and is the most abundant type of cotton. The staple varies between 1 and 1.25 in. and the diameter is $1/1200$ in. It has a good natural colour but cannot be used for the extremely fine counts.

Indian cotton

This is a short fibre of between 0.6 and 0.8 in. length. It is therefore only suitable for spinning coarse counts.

China cotton

This is about the lowest commercially acceptable grade, the fibres being only 0.5 to 0.7 in. long. Its twist is not highly developed and it is rather harsh. It does not spin a good yarn alone, and is usually used in a mixture with better qualities. The properties of commercial cottons are summarized in Table 3.1.

Table 3.1 Properties of commercial cotton

<i>Origin of cotton</i>	<i>Length of fibre (in.)</i>	<i>Diameter (in.)</i>	<i>Limit for spinning</i>
Sea Island	2.0 and over	1/1500	1/200
Egyptian	1.5 to 1.75	1/1500	1/200
South American	1.0 to 1.5	1/1300	1/70
American	0.9 to 1.25	1/1200	1/70
Indian	0.6 to 0.8	1/1200	Coarse counts only
Chinese	0.5 to 0.7	1/1200	Coarse counts only

Constituents of raw cotton

Raw cotton contains, in addition to cellulose, the usual constituents of a vegetable cell. These are oil and wax, pectoses and pectins, proteins and simpler related nitrogen compounds, organic acids, mineral matter, and natural colouring matter. Cotton yarns or piece goods may contain, in addition, adventitious dirt, size, and machine oil. The approximate composition of raw cotton is as follows:

Cellulose	85.5 per cent
Oil and wax	0.5 per cent
Proteins, pectoses, and Colouring matter	5.0 per cent
Mineral matter	1.0 per cent
Moisture	8.0 per cent

It will be apparent that if cotton is properly purified before bleaching it must lose 6.5 per cent in weight. In order to understand the scouring and bleaching processes it is necessary to know something of the chemistry of these impurities.

Oils and waxes

The oils and waxes of cotton consist of:

- (a) glycerides, which are readily saponifiable oils and fats;
- (b) waxes, which are saponified with difficulty;

- (c) unsaponifiable oils;
- (d) free fatty acids; and
- (e) traces of soaps.

Fargher and Probert (*J. Text. Inst.*, 1923, **14r**, 49) investigated the fatty matter obtained by extracting two tons of cotton with benzene. They obtained 750 g of a crude brown waxy product which they endeavoured to separate into its constituents by extracting it successively with light petroleum ether, benzene, alcohols, and chloroform. They claimed to have separated gossypyl alcohol ($C_{30}H_{61}OH$), ceryl alcohol, and montanyl alcohol ($C_{28}H_{57}OH$). Later work by Chibnall and others (*Biochem. J.*, 1938, **28**, 2189) suggested that neither gossypyl nor montanyl alcohol had been obtained in their pure form. Montanyl alcohol (C_{28}) is probably a mixture of 40 per cent of (C_{28}), 40 per cent of (C_{30}) and 20 per cent of (C_{32}), which, within the limits of experimental error, would give the same physical properties as those attributed to montanyl alcohol by Fargher and Probert. Similarly gossypyl alcohol (C_{30}) is probably a mixture of 20 per cent of (C_{28}), 40 per cent of (C_{30}) and 40 per cent of (C_{32}). These monohydric alcohols of high molecular weight combine with fatty acids to form waxes which are hard substances with comparatively high melting points. They do not hydrolyse easily and are split up into the sodium salt of the fatty acid and the alcohol only after prolonged boiling in an alcoholic solution of sodium hydroxide.

Fats are esters of fatty acids with glycerol and they have low melting points and are hydrolysed into soap and glycerol quite easily by boiling in an aqueous solution of sodium hydroxide (see Chapter 9).

Nitrogen constituents of raw cotton

These are derived from what was the protoplasm of the living cell. They consist of proteins and the degradation products of proteins such as polypeptides and amino acids. It is believed that nitrogen-containing compounds may be associated with the natural colouring matter. The chemistry of proteins is described in greater detail in Chapter 5.

Pectates

Natural cotton contains derivatives of pectic acid. They appear to exist mainly as calcium and magnesium pectates, but free pectic acid and methyl pectate are also present. There is still a measure of doubt about the exact constitution of pectic acid, but it has been established that it is a polymer with a high molecular weight. The evidence which is available supports the view that it is composed of galactouronic acid units (**1**) in which some of the carboxyl groups may exist as methyl esters ($-COOCH_3$) or as calcium or magnesium salts. The esterified form is soluble in water. Free pectic acid and the calcium and magnesium salts do not dissolve in water but are

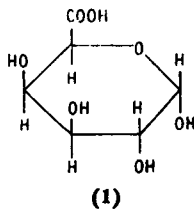

broken down into soluble products by alkali hydroxides or sodium carbonate.

Mineral matter

The nature and amount of mineral matter found in cotton depends to some extent on the composition of the soil on which it was grown. It is the residue of the salts contained in solution in the sap when the cell was still a living and growing organism. The exact nature and proportions of the salts has not been ascertained, but it can be inferred from an examination of the ash. The residue after the organic matter has been removed by combustion amounts to between 1 and 2 per cent, and analysis gives the following approximate composition (per cent):

Potassium carbonate	44.8
Potassium chloride	9.9
Potassium sulphate	9.3
Calcium sulphate	9.0
Calcium carbonate	10.6
Magnesium sulphate	8.4
Ferric oxide	3.0
Aluminium oxide	5.0

The carbonates of potassium and calcium were not in that state originally, but are the products of combustion of the salts of organic acids of those metals.

CELLULOSE

When all the impurities have been removed the main constituent of the fibre, cellulose, remains. A knowledge of the chemistry of this substance is essential for understanding the technology of bleaching and dyeing. Cellulose has an empirical formula of $(C_6H_{10}O_5)_n$. Pure cellulose is a white substance with a specific gravity of 1.5. It burns freely in air with a luminous smokeless flame. When subjected to dry distillation it yields a mixture of volatile substances, including acetic acid. It is hygroscopic, and it has been suggested that cellulose can form three hydrates: $C_6H_{10}O_5 \cdot \frac{1}{3}H_2O$ or $\frac{1}{2}H_2O$ and $C_6H_{10}O_5 \cdot 1\frac{1}{3}H_2O$. Cellulose is insoluble in water and organic solvents, but dissolves in ammoniacal copper hydroxide and in concentrated solutions of certain salts such as zinc chloride and calcium thiocyanate. It is insoluble in solutions of alkalis but dissolves in cold concentrated sulphuric acid. Like other carbohydrates, when heated with concentrated sulphuric acid it swells

up, forming a mass of carbon. It is also attacked by hydrochloric and nitric acids. Solutions of cellulose are colloidal in their properties.

It has been known for a long time that one of the products of the hydrolysis of cellulose is glucose, and various workers have demonstrated that the yield, when methoxy cellulose is hydrolysed with dilute acids, is virtually theoretical. This indicates that cellulose consists of nothing but glucose molecules linked together. Starch and glycogen also give theoretical yields of glucose on hydrolysis, but neither nature nor man has ever succeeded in making a fibrous substance out of them. It is obvious, therefore, that there must be some unique structural arrangement of the glucose units within the cellulose. It was not until the great work of Haworth, Hirst, Irvine, and others on the chemistry of sugars had made sufficient progress, that it was possible to create a model of the cellulose molecule.

In 1926 W. N. Haworth demonstrated that sugars were cyclic in structure and that the points of attachment of the oxygen atom in the ring were the first and the fifth carbon atoms as shown in (2).

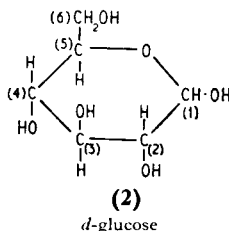

This is commonly referred to as the pyranose structure because of its similarity to pyran (3).

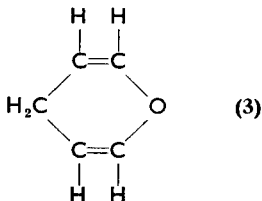

It has been established by measuring the rotation of polarized light by glucose, crystallized under varying conditions, that there are two forms of dextrorotary glucose, known as the alpha and beta glucoses. The difference between them lies in the distribution of the hydroxyl groups above and below the pyranose ring, which should be imagined as lying in a plane at right angles to the surface of the paper (4). By convention the heavy line represents the front of the hexagonal ring.

From the foregoing it will be apparent that cellulose is a polymer of glucose, and that it must contain a large number of $-\text{CH}_2\text{OH}$ and >CHOH

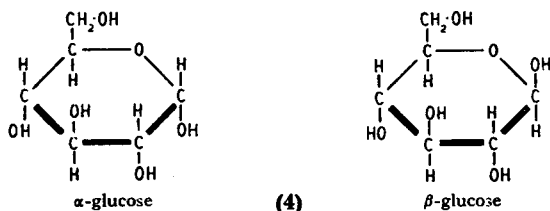

groups. It has been found in practice that it is much easier to isolate and identify the intermediate products in the breaking down of the chain if the hydroxyl groups have been methylated or acetylated. In 1923 Irvine and Hirst showed that if cellulose is completely methylated a theoretical yield of 2:3:6 trimethyl glucose (5) is obtained, from which it can be deduced

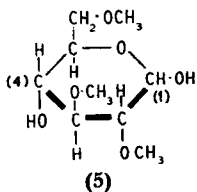

that the linkage is between the hydroxyl groups attached to the 1 and 4 carbon atoms. The octa-acetate of a sugar known as cellobiose had been isolated from fully acetylated cellulose. When its constitution was determined by Haworth, Freudenberg and Braun, a great step forward was made in establishing the structure of cellulose. Cellobiose is hydrolysed by the enzyme emulsin which it is known will only break down links between beta glucose molecules. This important fact, together with an elegant application of sugar chemistry research (see PRESTON *et al.*, *Textile Science*), proved that cellobiose consists of two beta glucose molecules linked together at the 1:4 carbon atoms as shown in (6).

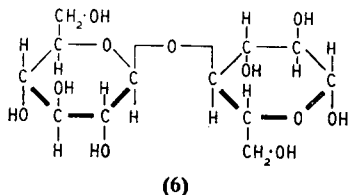

A consideration of the structure of beta glucose shown in (4) shows that if the linkage is between hydroxyl groups in the 1:4 positions, each alternate unit must be turned through an angle of 180° . This is necessary to bring the —OH groups to the same side of the plane of the molecular configuration, and therefore adjacent to each other. Starch is a polymer of alpha glucose molecules in which this alternate rotation of the molecule is not required for condensation leading to linkages in the 1:4 positions. This

difference is of profound significance because theoretical considerations demonstrate that it is only in the case of the beta linkage that it is possible for the polymer to be orientated in a straight line and therefore to be potentially fibre-forming.

The accepted structural formula for cellulose is therefore;

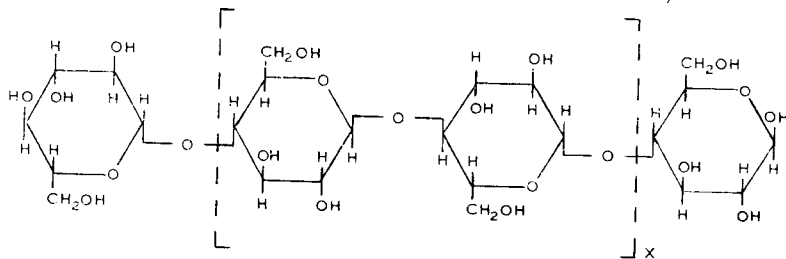

Confirmation of the structure of cellobiose came from the interpretation of X-ray diffraction diagrams for cellulose. Most of the work has been done on ramie because, amongst the natural fibres, it contains cellulose in the most highly crystalline state. The pattern indicates a repeating period along the longitudinal axis of 10.3 \AA (1.03 nm) which is in very close agreement with what molecular models indicate should be the corresponding dimension of a cellobiose molecule as shown diagrammatically in (7).

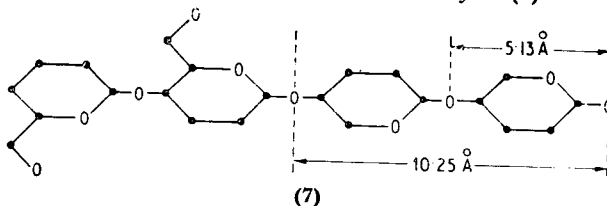

The other dimensions of the unit cell are 7.9 and 8.35 \AA (0.79 and 0.835 nm) as shown in Fig. 3.7.

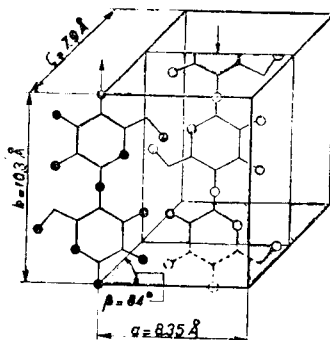
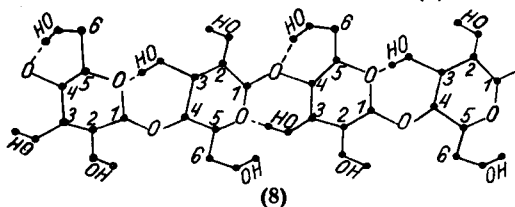

Fig. 3.7 Diagram of the positions of the atoms in the elementary cell of native cellulose

(After Meyer and Misch)

A further fact which emerges from a study of the spatial arrangement of the atoms is that the hydroxyl group attached to the carbon atom numbered 6 in the conventional glucose formula (i.e. the CH_2OH group) is within hydrogen bond-forming distance of the oxygen atom in the beta glucoside link as shown in the structural formula (8).



Probable intra-molecular hydrogen bonds indicated by broken lines.

Molecular weight of cellulose

This has been determined by methods described in Chapter 2. There is no certainty about the molecular weight because the result varies according to the method of determination and the source of the cellulose. Most investigators agree on a figure of approximately 570,000, which is equivalent to a chain length of 3600 glucose units. Recent estimates with centrifugal methods suggest a structure of 10,000 glucose units giving a molecular weight of about 1,580,000.

Hydrocellulose

This is produced by the action of dilute acids on cellulose. It results from the cleavage of chains by hydrolysis, see (9).

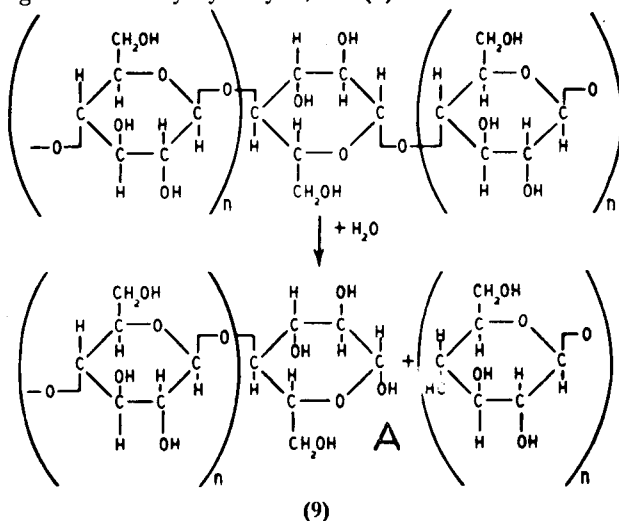

The end group A is a reducing structure because it can undergo tautomeric change to an aldehyde (10).

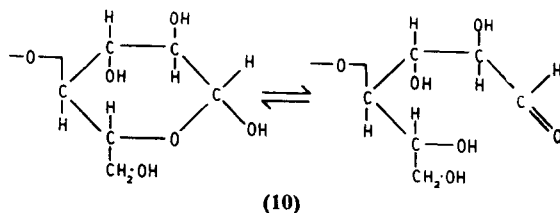

Hydrolysis lowers the degree of polymerization and therefore the tensile strength of the fibre. It also gives a derivative with greater reducing power because of the increased number of end groups capable of aldehyde transformation. The extent of the breakdown depends upon the pH of the acid and temperature. There is usually very little hydrocellulose formation in aqueous solutions of mineral acids and none with organic acids. If non-volatile acids, whether organic or inorganic, are not removed, hydrocellulose can be formed rapidly at the higher temperatures which prevail during drying.

If goods made out of cellulosic fibres are not neutralized properly after treatment with acid, they are liable to develop hydrocellulose gradually during storage. This applies with all mineral acids and as little as 0.01 per cent of sulphuric or hydrochloric acid will gradually cause serious tendering. This form of damage is particularly dangerous because the goods can be supplied as perfect in good faith and found to be faulty at a later date when they are unpacked.

Oxycellulose

Cellulose is easily oxidized into a variety of products known as oxycelluloses. There are essentially three points at which oxidizing agents can attack the glucose molecule.

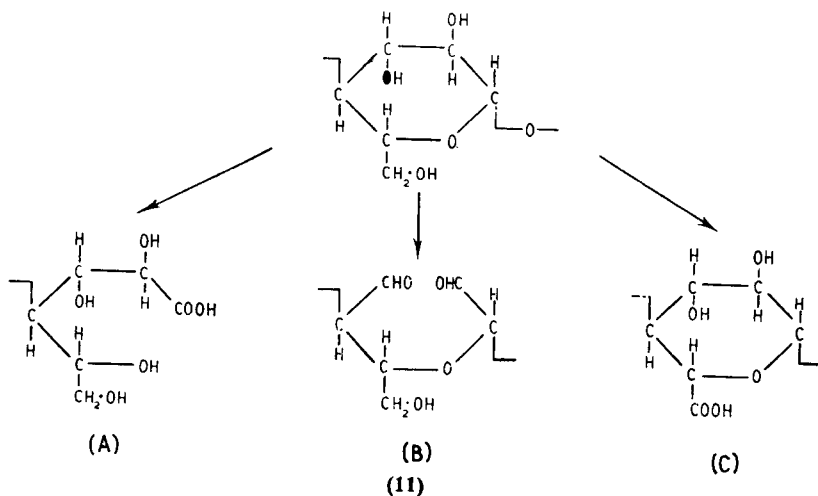

In two cases oxidation results in the production of acidic carboxyl groups [(A) and (C) in (11)], and in the other instance a reducing product with two aldehyde groups is formed [(B) in (11)]. This accounts for the fact that both acidic and reducing types of oxycellulose exist. It will be seen that none of these products of oxidation necessarily causes chain cleavage. Oxycellulose formation is, nevertheless, accompanied by all the characteristic attributes of reduction in the degree of polymerization. The reason is that after oxidation the glucose rings are more easily ruptured in the manner shown in (12), and all the conventional tests for measuring depolymerization are carried out with alkaline reagents.

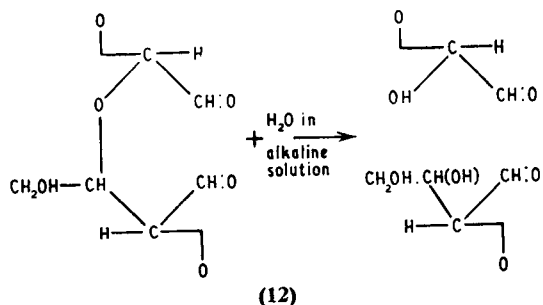

Tests for hydrocellulose and oxycellulose

The methods which are used are based on identification of carboxyl or reducing aldehyde groups, or on measuring the decrease in the degree of polymerization. Breakdown in chain length and reducing action are common to both hydrocellulose and oxycellulose, but the acidic properties associated with the presence of carboxyl groups is a property possessed only by the latter.

The copper number is an expression of the reducing power of degraded cellulose. It is the number of grams of copper which are reduced from the cupric to the cuprous state by 100 g of cellulose when it is boiled with Fehling's solution or some equivalent reagent. Pure cellulose has a copper number ranging between 0.2 and 0.3, but when degraded it may be as high as 14.

Fehling's solution is prepared in the following way. Two separate solutions are required which are mixed in equal volumes just before use. One component consists of 34.63 g of crystalline copper sulphate dissolved in 500 ml of water, and the other 70 g of sodium hydroxide and 173 g of Rochelle salt (potassium sodium tartrate) dissolved in 500 ml of water. Alternatively, Clibbens and Geake (*J. Text. Inst.*, 1924, 27) recommend the following solutions:

- (a) 100 g of crystalline copper sulphate dissolved in 1 litre of water, and
- (b) 50 g of sodium bicarbonate and 350 g of crystalline sodium carbonate dissolved in 1 litre of water.

When determining the copper number the correct dry weight of about 3 g of cellulose is obtained. The sample is then cut into small pieces which are placed in a flask together with 100 ml of Fehling's solution and 200 ml of water, and boiled under a reflux condenser for 15 minutes. After boiling, the mixture is filtered through a Gooch crucible with a purified asbestos fibre mat, and washed well with boiling water. The cuprous oxide containing content of the Gooch crucible is then transferred to a beaker to which has been added 1 to 2 g of ferric alum dissolved in dilute sulphuric acid. Ferrous sulphate in an amount exactly equivalent to the cuprous oxide will now be formed:

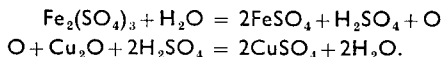

The ferrous sulphate is determined by titration with decinormal potassium permanganate, each ml of which will be equivalent to 0.0063 g of copper.

The disadvantage of using Fehling's solution for quantitative determinations is that boiling with sodium hydroxide converts some reducing oxy-cellulose into a non-reducing variety by hydrolysis, accompanied by oxidation brought about by oxygen derived from the atmosphere.

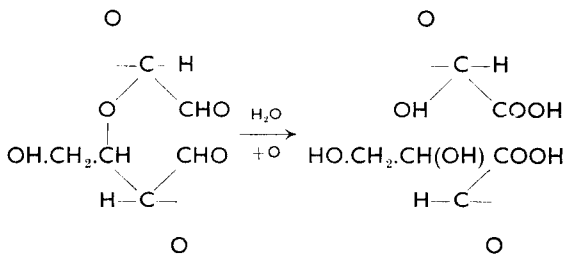

It was to overcome this source of inaccuracy that Clibbens and Geake (*loc. cit.*) proposed to use solutions (a) and (b) specified in a previous paragraph. These are free from sodium hydroxide. Immediately before the beginning of the determination, 5 ml of solution (a) are added to 95 ml of solution (b). The mixture is heated to boiling point and poured over 2.5 g of the material to be tested, which is contained in a conical flask, the capacity of which is slightly more than 100 ml. The cotton is distributed throughout the liquid by means of a glass rod, and any air bubbles present are allowed to escape. The flask is then immersed in a constant-level water-bath which is kept boiling vigorously. The flask should be immersed deeply in the water, and care should be taken to cover the top of the bath sufficiently to prevent cooling of the reaction mixture by currents of cold air. The flask, the mouth of which has been closed with a pear-shaped glass bulb, is allowed to remain in the boiling water for exactly 3 hours. The contents are then filtered with suction and the cotton is washed first with dilute sodium carbonate solution and subsequently with hot water. The cuprous oxide is then dissolved by treating the cotton on the filter with 15 ml of a solution containing

100 g of ferric alum and 100 ml of conc. H_2SO_4 per litre followed by either one or two further applications of 10 ml each. The cotton is finally washed with 2s sulphuric acid, and the combined filtrates are titrated with standardized potassium permanganate.

Fehling's solution can also be used as a qualitative test for the presence of aldehyde groups due to either hydrocellulose or osycellulose formation. When cotton is boiled gently with the Fehling's solution for about 10 minutes a red deposit of cuprous oxide can be observed either in local patches or as a uniform stain, according to the distribution of the degradation.

Methylene blue test

Pure cellulose has no affinity for methylene blue, but the presence of carboxyl groups associated with acidic osycellulose or residual mineral acid associated with hydrocellulose formation do cause cellulosic fibres to absorb the dye. Both qualitative and quantitative tests are based on these facts. If cotton be immersed in a cold solution of methylene blue and then rinsed with boiling water, any significant degree of staining indicates degradation. Methylene blue can also be used as a reagent for quantitative estimation. From 1 to 2 g of cotton are cut into small pieces and shaken for 18 hours in a glass-stoppered bottle with 50 ml of a solution containing 0.4 milli-mole of well-purified methylene blue hydrochloride per litre. A measured volume of the solution is then withdrawn and the remaining methylene blue is determined either colorimetrically or by titration with Naphthol Yellow S. The latter method depends upon the fact that when a solution of Naphthol Yellow S is run into one containing methylene blue, a reddish-brown precipitate is formed, the blue colour of the solution becoming less intense and finally changing to yellow. The end point is not easy to detect with accuracy.

Methylene blue does not react with aldehyde groups which are characteristic of hydrocellulose or oxidation of cellulose under acid conditions. Thus a sample with a high copper number and low methylene blue affinity indicates either hydrocellulose or acid oxidation. Hydrocellulose is usually accompanied by residual traces of acid. If there is a reduction in the methylene blue absorption brought about by boiling in dilute sodium hydroxide, it indicates the presence of acid, because this treatment has no effect upon the number of carbosyl groups. The latter will only be converted into sodium carbosylate which will revert to sodium chloride and carboxylic acid groups with the hydrogen chloride in the methylene blue hydrochloride.

Silver nitrate test

This is also referred to as Harrison's test. The reagent is a solution containing 1 per cent of silver nitrate, 4 per cent of sodium thiosulphate, and

4 per cent of sodium hydroxide. The material is boiled or padded with the solution and then steamed. Those parts containing oxycellulose or hydrocellulose will stain black or dark grey due to the formation of silver by reduction. This provides a useful qualitative test.

Alkalinity of ash

This is probably the simplest method of testing for carboxyl groups which, since they are a product of alkaline oxidation, will be present as —COONa . A sample is steeped in $N/10$ sulphuric acid for 1 hour, and next washed twelve times with distilled water. The material is then steeped in fresh distilled water for 3 hours, rinsed and dried. In this way all the alkaline ash-forming constituents, other than the —COONa groups, are removed. After this treatment the sample is weighed and then ignited in a silica crucible and heated until all the carbon has gone. The residue is dissolved in water and the alkalinity determined by titration with $N/10$ sulphuric acid.

Fluidity test

The employment of the viscosity of a solution of cellulose in an ammoniacal solution of copper hydroxide as an indication of average chain length was first suggested by Ost in 1911. It was investigated critically by Farrow and Neale in 1924, and finally established as a reliable test by Clibbens and Geake (*J. Text. Inst.*, 1928, 77).

The cuprammonium solution which is used contains 15 g of copper, 240 g of ammonia, and rather less than 0.5 g of nitrous acid per litre. It is

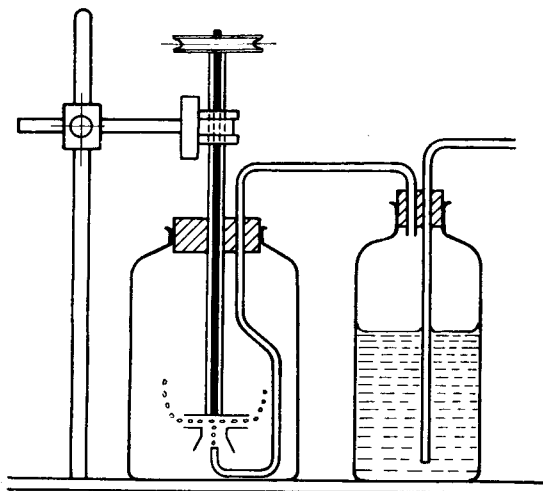

Fig. 3.8 Apparatus for preparation of cuprammonium solution

prepared in a large earthenware bottle of about 5 litre capacity which is surrounded by ice. Through a cork in the neck passes an iron stirrer and an iron inlet tube which conducts a stream of air into the trumpet-shaped base of the stirrer (Fig. 3.8). A mixture containing 2.6 litres of ammonia (sp gr 0.880) and 0.4 litre of water together with 3 g of cane sugar and 180 g of precipitated copper is put into the bottle. Air is blown in at the rate of 10 litres per hour, having previously passed through a wash bottle containing ammonia (sp gr 0.9). The stirrer is set in motion and gradually the

copper goes into solution. After about 5 hours sufficient copper should have dissolved. The amount in solution can be ascertained by colorimetric comparison of a sample diluted 1 in 10 with a standard solution. When the undissolved copper has had time to settle, the supernatant liquid is drawn off. The copper in it is determined by titration with potassium iodide and sodium thiosulphate, and the ammonia by titration in the presence of methyl red, and the solution is adjusted to the specified concentration by dilution with water and the appropriate amount of ammonia. It is tested for nitrous acid with a nitrometer, and the solution is rejected if the concentration exceeds 0.5 g per litre. This stock solution is stored in a blackened bottle provided with a tap at the bottom and connected at the top through a wash bottle containing alkaline pyrogallol to a gasholder filled with nitrogen.

The fluidity of the cellulose is determined in the viscometer shown in Fig. 3.9. It has an internal diameter of 1 cm and a length of approximately 26 cm. The lower capillary at *D* is 2.5 cm long and has an internal diameter of 0.088 cm. The wide portion of the viscometer tube is etched with two rings *B* and *C* at heights of 6.2 and 24.2 cm vertically above the flat lower end of the capillary *D*. The upper end of the tube is closed with a rubber stopper carrying a second capillary *E*. The test is based on the viscosity of a solution

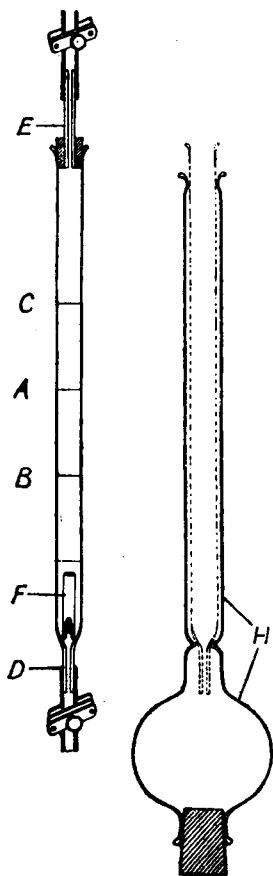

Fig. 3.9 Viscometer

containing 0.5 g of dry cellulose dissolved in 100 ml of the reagent. Each tube is individually calibrated to give the precise weight of cellulose necessary to yield a solution of this concentration in the volume contained in the viscometer.

After the clip at the bottom has been closed, the tube is about three-quarters filled with cuprammonium solution and then a few drops are run out at the bottom to make sure that the capillary is full. A small piece of steel rod (F) 2.7 cm long and $\frac{1}{4}$ in. diameter, which acts as a stirrer, is placed in the tube. The weighed sample of cellulose is entered next and mixed in with the aid of a thin glass rod. The viscometer is then filled completely with cuprammonium solution and the top stopper (E) is pushed home so that some liquid overflows through the upper capillary, thus displacing all air. The top clip is closed, the stopper is wired into position, and the viscometer is wrapped in black cloth or otherwise protected against exposure to sunlight, and is fixed to a rotating disc. The rotation should be adjusted to such a rate that the steel stirrer drops during each half-rotation, but not with excessive force. About four revolutions per minute is generally found to be satisfactory. The shaking device is allowed to operate until the cellulose has dissolved completely, but the usual practice is to run it overnight. The tube is then placed in the jacket H (Fig. 3.9), which is supported vertically in a thermostat maintained at 20°C (68°F). When equilibrium has been established with regard to temperature the top stopper is removed and the liquid is allowed to run out freely through the bottom capillary from which the rubber tube and clip had been removed previously. The time in seconds required for the meniscus to fall from the etched ring C to that at B is recorded. Each tube has a constant which is arrived at as follows. Calibration is carried out with a glycerine solution adjusted to have a specific gravity of 1.1681 at 20°C (68°F). The fluidity (F) in absolute units of this solution is 6.83 and the time t which it takes to flow from C to B is observed. With a fluidity of 6.83 and a density of 1.1681 (d), it can be proved that the constant $K = 1.075(dFt)$. When this constant is divided by the time required by the cellulose solution to fall from the top to the bottom mark, the result gives its fluidity.

Experience has proved that fluidity provides a very sensitive measure of the degree of degradation of cellulose molecules. When cotton is bleached with sodium hypochlorite normally a fluidity greater than 8 would not be expected. If a value of 10 or more is obtained it can be taken as indication of excessive degradation. In commercial practice it should be possible to work consistently to fluidities between 4 and 5, unless the material is exceptionally difficult to bleach or an outstanding degree of whiteness is required. Quite a number of investigations relating fluidity with loss of tensile strength have been reported in the literature. These are referred to by Vaeck (*J.S.D.C.*, 1966, **82**, 374). The curves shown in Fig. 3.10 are graphical representations of various relationships between tensile strength and fluidity recorded by four different observers. Essentially all the curves are very similar except the one marked **4** which shows that in the higher range of fluidities the tensile strength decreases less rapidly than reported by Clibbens and Ridge. This deviation, however, is of little importance

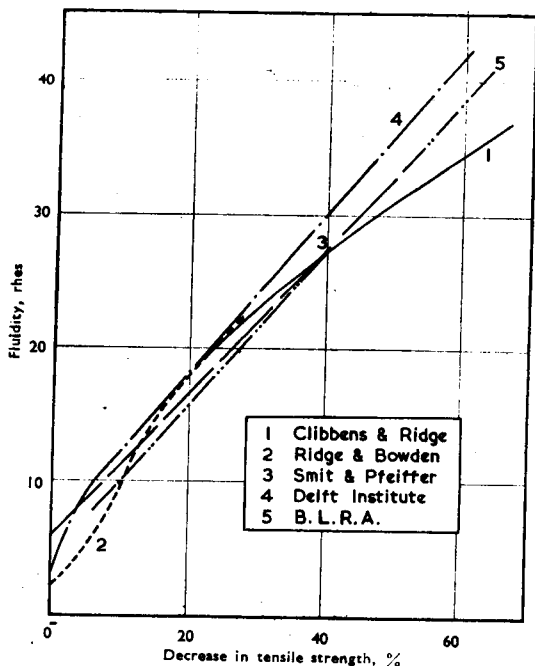

Fig. 3.10 Curves relating tensile strength loss to fluidity after hypochlorite bleaching (no mechanical wear)
(Courtesy of British Launderers' Research Association)

to the practical bleacher since it would be undesirable for commercially bleached cotton to have a fluidity above 8.

Fluidities of regenerated celluloses

A 0.5 per cent solution of a regenerated cellulose has a fluidity of about 40, which is approaching the limit of accuracy of measurement. It is therefore usual to work with a 2 per cent solution which brings fluidities into the range of 7.5 to 35, and normally well-bleached regenerated cellulose rayon should have a fluidity of 11 to 12. For mixtures of cotton and viscose or other chemically similar rayons, the weights of fibre required per 100 ml of cuprammonium solution are given in Table 3.2.

If the fluidity of the mixture be represented by F_m , and that of the cotton and rayon by F_c and F_r respectively,

then
$$F_c = 1.4 \times F_m$$

and
$$F_r = 0.5 \times F_c + 8.$$

Thus if the fluidity of the mixture be 5

then
$$F_c = 5 \times 1.4 = 7$$

$$F_r = 0.5 \times 7 + 8 = 11.5.$$

Table 3.2

<i>Percentage of cotton in mixture.</i>	<i>Concentration of solution in g per 100 ml</i>
80	0.762
75	0.807
66.7	0.875
60	0.948
50	1.088
40	1.267
33.3	1.424
25'	1.649

Action of heat

Cotton can be heated in a dry state to 150°C without undergoing decomposition, but if the heating is prolonged a brown colour develops gradually. A very slight brown discoloration can occur at temperatures lower than 150°C which causes no deterioration in the fibre but is sufficient to spoil the effect of bleaching. Care should be taken to control the temperature of drying machines, and they should not be allowed to exceed 93°C (200°F). Prolonged exposure at high temperature to an atmosphere containing oxygen causes tendering due to the formation of oxycellulose.

Exposure to air during a long period, especially in the presence of sunlight, will have an effect upon cotton similar to that of dry heat. Oxycellulose is formed gradually accompanied by tendering. Turner (*J.S.D.C.*, 1920, 165) made a study of the significance of light and other factors. He found that moisture had no effect upon the rate of tendering. The removal of oxygen from the surrounding atmosphere very greatly reduced, although it did not entirely inhibit, the destructive effect of light. The tendering by light and air is accelerated by traces of metals such as copper. Cotton may contain copper in small quantities derived, for example, from copper rollers over which the yam passes in wet doubling machines, made before stainless steel was used for this purpose. The author has examined cotton shirts which, after being worn for about 3 months exposed to tropical sunlight, became quite tender. Analysis showed that the damage was accompanied by the formation of oxycellulose and traces of copper were present.

Action of water

Cold water causes cotton to swell but has no chemical action on it. The swelling is accompanied by the disappearance of the natural twist which reappears on drying. Sea-water can sometimes cause degradation of the cellulose and exposure to the action of sea-water for periods of 3 to 5 weeks made both cotton and linen fabrics quite tender. This change was

accompanied by great alteration in the chemical properties, because no less than 17 per cent of the fibre became soluble in boiling 1 per cent caustic soda solution. Further investigation led to the conclusion that most of this tendering was caused by micro-organisms in the presence of oxygen. Cotton is liable to be attacked by moulds or bacteria provided that sufficient moisture is present, and that the *pH* and temperature are favourable to growth. It has been stated that cotton is not attacked unless it contains 9 per cent of moisture, after which the rate of multiplication of the micro-organisms can increase rapidly until a maximum is reached at 50 per cent water content. Most moulds are allergic to acid but can grow abundantly when the conditions are slightly alkaline and the temperature is above 21°C (70°F).

Bacterial or similar damage can be detected by the swelling test. Between 0.1 and 0.3 g of the cotton is boiled in a 1 per cent solution of sodium hydroxide. It is then **neutralized** with acetic acid and washed and steeped in 15 ml of cold 15 per cent sodium hydroxide solution to which 1.5 ml of carbon disulphide are added after a short time. After 45 minutes the fibres are mounted on a slide in water and examined under a microscope. Undamaged fibres will show the characteristic swellings and constricted zones as shown in Fig. 3.5 (b). Those which have been attacked will have partially or wholly lost their cuticle and will therefore swell uniformly and show no globular formations. The same test can be carried out using cold Schweitzer's reagent to bring about the swelling.

The action of acids on cotton

Boiling with dilute acids will ultimately hydrolyse the cellulose to glucose. Milder action by acids at lower temperatures gives rise to tendering with the formation of hydrocellulose. Cold concentrated sulphuric acid dissolves cellulose with the formation of cellulose hydrate. If this solution be poured into cold water the cellulose hydrate is precipitated in a gelatinous form. This reaction is used in the manufacture of parchment paper. Sheets of paper are immersed for a short time in concentrated sulphuric acid and then washed rapidly in cold water till free from acid. In this way the pores in the paper are covered with an impervious film of cellulose hydrate. Cold dilute solutions of mineral acids, unlike when at the boil, have no effect upon cellulose provided the acid is neutralized or washed out completely before drying. If, however, even traces of mineral acid be allowed to dry in, tendering soon becomes apparent due to the formation of hydrocellulose. As little as one part in one hundred thousand of sulphuric acid left in before drying can cause gradual deterioration during storage.

Prevention of the tendering effect of acid can only be achieved by its complete removal. This can be done with very prolonged rinsing with water, a method which tends to make an excessive demand when water supply is restricted or expensive. Neutralization with sodium carbonate

followed by shorter rinsing is therefore often to be preferred. A final rinse in sodium acetate so that a minute amount of this salt is dried in is a good safeguard, because any traces of mineral acid will become converted to acetic acid which, both because of its low degree of ionization and its volatility, is not dangerous.

Nitric acid, on account of its oxidizing action, differs from other acids in its behaviour towards cellulose. Immersion for a short time in concentrated nitric acid causes some shrinkage accompanied by a degree of increase in tensile strength and affinity for dyestuffs. Prolonged action of cold nitric acid oxidizes the cellulose to oxycellulose and finally breaks it down to oxalic acid, the reaction being greatly accelerated at higher temperatures. When nitric acid is dried into cotton it resembles other mineral acids by causing tendering on storage.

Action of alkalis on cotton

Mild alkalis, such as sodium carbonate, have no action on cotton at low temperatures nor at high temperatures in the absence of air. In the presence of oxygen, however, oxycellulose is produced gradually with consequent tendering. Dilute solutions of strong alkalis such as sodium hydroxide act in very much the same way. In the complete absence of air, cotton can be boiled with 2 per cent sodium hydroxide without the least tendering. If oxygen be present, however, oxycellulose will soon make its appearance. This can be demonstrated experimentally by boiling cotton yarn with 2 per cent sodium hydroxide to which a little manganese chloride has been added to act as an oxygen carrier. If a stream of air be drawn through the boiling liquor the yarn will become extremely tender in quite a short time.

Cellulose is affected by sodium hydroxide in a complex manner. When treated with solutions of sodium hydroxide of less than 9 per cent concentration, a proportion of the alkali is retained with some tenacity after all that which is loosely adhering has been washed away, leaving a system which corresponds roughly with the formula $(C_6H_{10}O_5)_2NaOH$. There is no change in the arrangement of the space lattice revealed by X-ray analysis, from which it is concluded that the attachment of the sodium hydroxide is confined to the amorphous portions and the surface of the crystalline regions.

When the concentration of the sodium hydroxide in which the cellulose is immersed reaches 13 per cent, a new type of space lattice begins to make its appearance which increases in predominance until the change is complete at a concentration of 19 per cent. This phenomenon is accompanied by the formation of 'alkali cellulose', $C_6H_{10}O_5 \cdot NaOH$. When the alkali is removed by immersion in acid the spatial arrangement of the glucose molecules does not return to the original state but remains within unit cells in which the dimensions 'a' and 'b' are 8.1 and 9.1 Å (0.81 and 0.91nm) instead of 8.2 Å and 7.8 Å (0.82 and 0.78nm) for native cellulose as shown

in Fig. 3.11. All regenerated rayons and mercerized cotton have this modified spatial arrangement of the glucose units and in this form it is known as cellulose II. Cellulose hydrate, when first formed by regeneration or by removal of alkali from the alkali derivative, retains within the fibre structure somewhat more water than the few molecules in the space lattice. One hydrated form corresponds with $(C_6H_{10}O_5)1\frac{1}{3}H_2O$ and another with $(C_6H_{10}O_5)\frac{1}{2}H_2O$. These are referred to as cellulose hydrate II and cellulose hydrate I respectively. Very thorough drying is needed to remove the last traces of water from hydrate I to convert it into cellulose II.

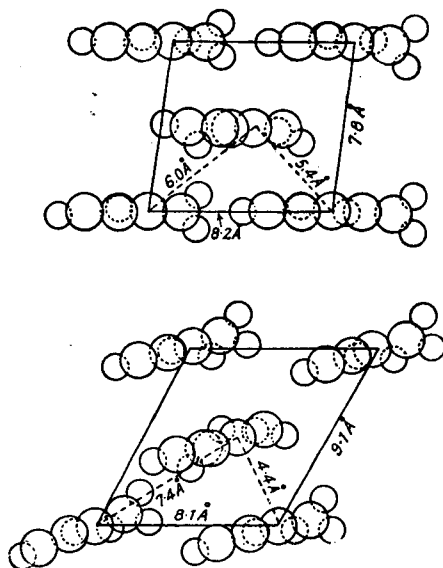

Fig. 3.11 Diagram of the crystal units of native and dispersed cellulose

(From *Introduction to bleaching*, J. T. Marsh. Courtesy Chapman and Hall)

Neale (*J. Text. Inst.*, 1929, 373; 1930, 225; 1931, 349) attributes the attraction of cellulose towards sodium ions to the formation of non-diffusible anions of the type $(C_6H_{10}O_5)^-$ or $(C_6H_9O_5.H_2O)^-$. This, it has been suggested, causes a distribution of sodium and hydroxyl ions on each side of the fibre boundary in accordance with the Donnan membrane equilibrium theory. The Donnan theory provides thermodynamic proof that 'if a solution of an electrolyte containing two diffusible ions is separated by a membrane from another solution containing a salt with a non-diffusible ion, then the equilibrium distribution of the former will not be equal on the two sides of the membrane'. This state is illustrated diagrammatically in Fig. 3.12 where, on the side marked *A* of the membrane (which in this case is the

surface of the fibre), is a colloidal phase of the sodium salt of the cellulose anion (R^-), and on the other side, marked *B*, is a solution of sodium hydroxide. When those ions which can pass through have achieved equilibrium, the solutions on each side of the membrane must be electrically neutral. Equal numbers of sodium and hydroxyl ions must therefore migrate from *B* to *A*. The concentration of sodium ions already present in *A* will reduce the sodium ions transferred from *B*. In order to maintain electrostatic neutrality the number of hydroxyl ions transferred will be reduced correspondingly.

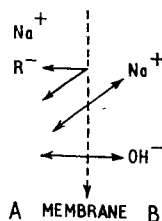

Fig. 3.12

In Fig. 3.13 the concentrations of sodium and non-diffusible (R) ions at the commencement before equilibrium is established are C_2 and the sodium and chlorine ions on the other side of the membrane C_1 .

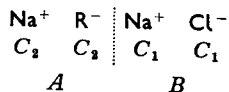

Fig. 3.13

To achieve equilibrium x chlorine ions must migrate from *B* to *A* carrying through x sodium ions also with them as shown in Fig. 3.14.

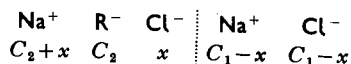

Fig. 3.14

This demonstrates clearly that the distribution favours the accumulation of sodium in the portion containing the non-diffusible ion. The same phenomenon is expressed quantitatively in Table 3.3.

Table 3.3

Initial concentration of NaR in A	Initial concentration of NaCl in B	Initial ratio NaR/NaCl	Percentage NaCl diffused from B to A	Distribution ratio NaCl between B and A at equilibrium
C_1	C_2	C_1/C_2	$100 \frac{x}{C_2}$	$\frac{C_2-x}{x}$
0.01	1	0.01	49.7	1.01
0.1	1	0.1	47.6	1.1
1	1	1	33	2.0
1	0.1	10	8.3	11.0
1	0.01	100	1.0	99.0

Mercerization

Mercer was the first to suggest that treatment of cotton with 20 per cent caustic soda might have commercial application. He observed that when the caustic soda had been removed by treatment with acid and washing, the cotton contracted in length, increased in tensile strength, and had acquired a greater affinity for dyes. What had happened was that the alkali had formed alkali cellulose, and subsequent neutralization had led to the formation of cellulose hydrate which, after loss of water, left cellulose II. The properties recorded by Mercer were not sufficiently attractive to compensate for the loss of length. In 1889, Lowe discovered that the shrinkage could be avoided if the cotton was kept under tension whilst immersed in the caustic soda. The fibre then retained its increased tensile strength and affinity for dyes, and had also acquired additional properties which were commercially desirable. It had an increased lustre, a greater

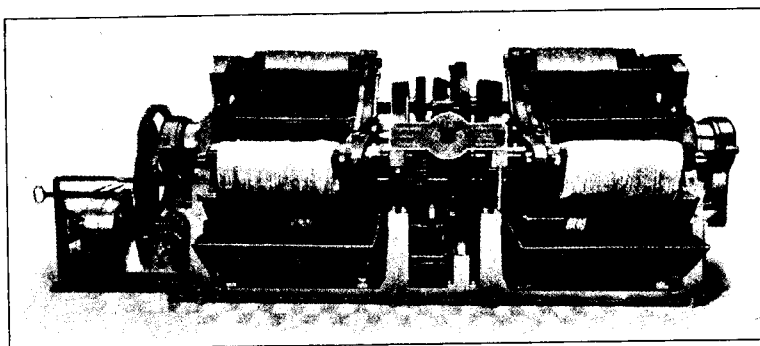

Fig. 3.15 Hank mercerizing machine

capacity to respond to mechanical finishing processes, and was softer to handle. Lowe's work laid the foundation for successful commercial mercerizing, but it was not until 1895 that the process became used extensively.

Hanks are mercerized on a machine of the type illustrated in Fig. 3.15, although there are many other designs. The hanks, which have been scoured previously, are placed over arms which apply tension. They then rotate the yarn, at the same time themselves moving in an arc to immerse the cotton in a caustic soda solution of specific gravity 1.3, equivalent to 27 per cent concentration. After a few minutes the arms move to another position, where the bulk of the alkali is rinsed out before tension is removed. A further movement accompanied by relaxation of stretch permits removal of the hanks, which are then rinsed in acetic acid and thoroughly washed with water. A mercerizing machine for open-width cloth is shown in Fig. 3.16.

There are two mangles on the left of the machine to impregnate the cloth. A series of drums over which the cloth passes provides a short dwell period

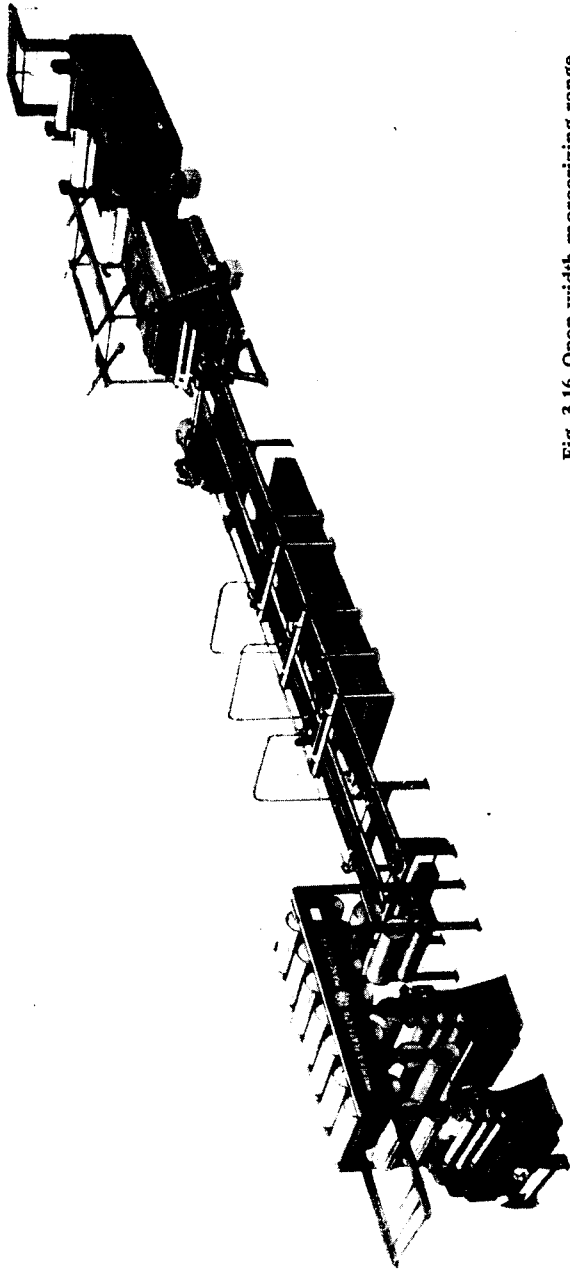

Fig. 3.16 Open-width mercerizing range
(*Courtesy of Mather and Platt*)

for the caustic soda to swell the fibres uniformly before the application of tension. The alkali is rinsed out with sprays situated over the stenter. At the delivery end of the machine the cloth passes through washing and neutralizing units.

The action of caustic soda can be used to produce pattern effects. If applied locally without tension the fibres contract and a puckered finish is produced. If a pattern is printed with a paste containing little or no water, and the cloth is then passed through water under tension, a lustrous design appears on a matt background. When dyed, the mercerized portions will be a heavier shade than the remainder.

Mercerized cotton is more easily acted upon by chemicals than ordinary cellulose. It dissolves more readily in Schweitzer's reagent and does not show the globular swellings which appear with unmercerized fibres. From this it can be concluded that the cuticle has been altered or destroyed during mercerization. Reference has already been made to the greater affinity for dyes and there is also an increased capacity to absorb water. Most of these properties are due to the somewhat less closely-packed structure of the unit cell of cellulose II.

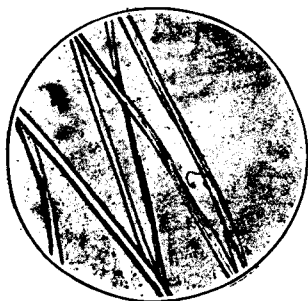

Fig. 3.17 Mercerized cotton

The process of mercerization is accompanied by important changes in the microscopic appearance of the fibre. The nature of the alteration can be followed under the microscope because when a fibre is mounted in a strong solution of sodium hydroxide it can be seen to swell and gradually untwist itself until it appears like a cylindrical tube. The microscopic appearance of mercerized cotton fibres is shown in Fig. 3.17.

Tests for mercerization

The simplest test for mercerized cotton is microscopic examination, when the degree of mercerization can be assessed approximately by counting the number of twisted and untwisted fibres. If the sample under investigation be immersed in a solution of 20 g of iodine in 100 ml of saturated potassium iodide for 3 seconds and then washed off well, mercerized cotton will be stained bluish black and unmercerized will be white.

The benzopurpurine test is useful both qualitatively and for approximate quantitative assessments. A sample is boiled for 30 minutes side by side with a similar unmercerized specimen in a 0.5 per cent solution of benzopurpurine. The specimens are then washed and dried, after which the colours are compared. Mercerized will be more deeply dyed than unmercerized cotton. By estimating the dye absorbed it is possible to obtain an

approximate measure of the degree of mercerization. Unmercerized cotton takes up 1.77 per cent of benzopurpurine, whilst when fully mercerized it absorbs 3.6 per cent.

A quick and simple test is to spot the sample with 27 to 30 per cent sodium hydroxide solution and then to dye it with benzopurpurine. If it has not been mercerized a deeper colour will appear where the spots were, but this will not be the case with mercerized cotton.

Immunized cotton

When alkali cellulose is treated with paratoluene sulphonchloride dissolved in toluene the following reaction takes place:

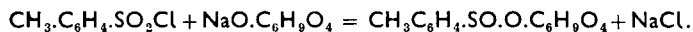

The cellulose ester thus formed is comparatively stable and has no affinity for direct dyes. Yarns treated in this way can be incorporated as an effect thread with untreated cotton, and they will remain white when direct dyes are applied. Yarns can also be dyed and then immunized afterwards. They then retain their colour unaltered when the material into which they are incorporated is dyed with substantive colours.

4 · Multicellular vegetable fibres

ALL vegetable fibres other than cotton are multicellular. They are composed of bundles of many cells held together by surface attraction. They are not attached to seeds as are cotton hairs but are usually part of the stem structure or some other tissue of the plant.

FLAX

The best known and most abundantly used multicellular fibre is flax or linen. Fabrics made from flax fibres have been used since prehistoric times. The plant still grows naturally in swampy regions between the eastern shores of the Black Sea and the Caucasus. Its cultivation may have originated from this region, but the surmise is not supported by any conclusive evidence. Flax was used in Egypt in about 2500 B.C., and the failure of the flax crop is specifically mentioned as one of the plagues in the Book of Moses. The ships of the Phoenicians and Greeks were borne across the seas by sails made of linen.

Flax is extracted from the fibrous bark of a plant belonging to the natural order LINACEAE, and the species is *Linum usitatissimum*. It is cultivated

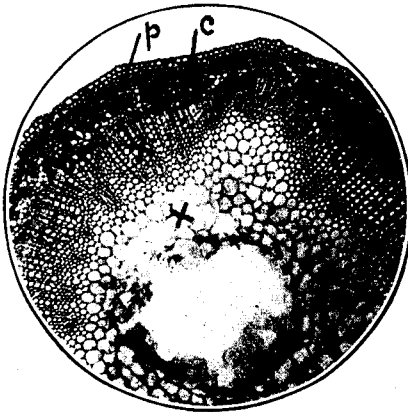

Fig. 4.1 Section of stem of flax

on a commercial scale in Russia, Belgium, Holland, England, and Ireland. The most valued variety is Courtrai flax, which is confined to Belgium. The plants, which are herbaceous, are grown each year from seed. When mature they are pulled out of the ground and allowed to wither and dry. The stalks are then separated from the leaves and seeds by rippling, in other words, drawing through the prongs of a comb. At this stage the stalks will contain about 75 per cent of fibrous flax. The seeds which have been separated are crushed to press out the linseed oil and the residue, virtually free from oil, is pressed into linseed cake which is valuable cattle food.

The microscopic view of a cross-section of a stem of *Linum usitatissimum* is shown in Fig. 4.1. The outermost layer *c* is the cuticle, or the skin of the

stem. Beneath this there are numerous layers of cells forming a soft tissue which is called the cortex. This is the live and growing region of the stem. Adjacent to the cortex there is a zone of smaller and darker cells, *p*, which is known as the phloem. This is the tissue through which the essential mineral salts extracted from the soil pass up to the leaves and flowers. The tissue marked *x* is the xylem, consisting of very large cells whose walls are composed of a modified form of cellulose known as lignocellulose or wood cellulose. The function of these cells is to give strength to the stem and to conduct water up from the roots. Between the phloem and the xylem is an actively growing tissue known as the cambium (*cb*). Situated in the phloem are bundles of fibres, *b*, which are called the bast fibres and which run throughout the whole of its length. They give support to the phloem tissues and additional strength to the stem. It is these which constitute the multicellular fibres which are ultimately spun into linen yarns.

Since the bast fibres are an integral part of the stem structure they are not directly available for spinning. They must first be separated from the other tissues by a process which is known as retting. The object of this operation is to break down the tissues of the stalk and dissolve the cementing substances such as pectates which hold the different cell structures together. There are various methods practised such as water retting, dew retting, and chemical retting.

In water retting the stalks are tied in bundles and covered with water in a tank. Putrefactive fermentation caused by bacteria soon sets in. This gradually softens the stems by the destruction of the less resisting tissues and rendering the intercellular adhesive substances soluble. When fermentation has reached the appropriate stage the fibres can be separated quite easily from the debris of the other tissues. If fermentation is allowed to proceed beyond this point the fibres themselves may become damaged, and to avoid this the progress of the retting must be observed carefully at intervals. The danger of attack extending to the fibres, together with the fact that the operation takes about 3 weeks, are serious objections, but a compensating advantage is that the cost is negligible.

Dew retting is similar in action to water retting, but slower. The stalks are spread out on grass and allowed to ferment, the necessary moisture being supplied either by dew, rain, or occasional watering. Sometimes the fermentation is started by water retting and the stalks are then taken out and laid on grass to complete the process. In this way a better colour is obtained.

Chemical retting consists of softening the tissues by boiling with dilute oxalic acid or alkali either at atmospheric or higher pressure. After treatment, the soluble bodies formed by the degradation of the less-resistant tissues are washed away. The process is considerably quicker than those relying upon natural fermentation. After retting, by whichever means, the residual tissues are passed between squeeze rollers to remove the excess liquor, and are then well washed in fresh water and dried.

The retted and dried stalks are put through a mechanical process called breaking. They are crushed by passing them through pairs of horizontal fluted rollers. The pressure breaks up the woody tissue or xylem into small fragments which are then in a condition ready to fall away, whilst the less brittle bast fibres remain unaffected. After breaking, the crude fibres are separated from the crushed debris by scutching. This may be done by simply beating the broken stalks by hand till the fragments of woody tissue are entirely removed. The operation is, however, generally carried out by machines designed to produce a similar beating effect. The scutched flax is subsequently hackled, when it undergoes a combing process which separates the fibrous strands and lays them parallel to one another. The hackled flax is then drawn and spun in a manner similar to cotton.

Microscopic structure

Flax fibres vary in length from 1 to 3 in. Each fibre is composed of a number of fibrils consisting of several cells joined together. These have an average length of about 1 in. and a diameter of from $1/1800$ to $1/1000$ in. The fibre has the appearance of a straight tube with thick walls and a narrow but distinct lumen, as shown in Figs. 4.2 and 4.3. The end of the

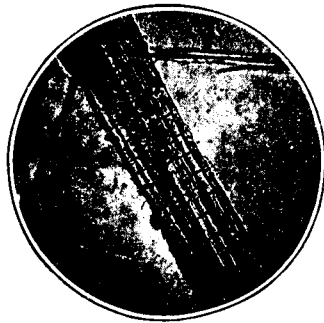

Fig. 4.2 Fibril of flax fibres



Fig. 4.3 Single flax fibres

fibre appears to be pointed and on the outer surface longitudinal striations are visible. There are many nodes or swellings to be seen and these give a jointed appearance. Where these joints occur, as well as at other points, transverse divisions across the fibre, which are placed somewhat obliquely to the longitudinal axis, can be distinguished. Both the joints and the transverse striations can be rendered more visible by mounting the fibres in iodine and sulphuric acid or zinc chloride solution. No natural twist can be seen, but there is reason to believe that the rough surface and jointed structure assist in spinning.

The cell walls are thick and swell uniformly without showing globular variation in thickness when treated with Schweitzer's reagent. From this it

can be concluded that no cuticle is present. Raw flax is brownish in colour; after bleaching it is white, soft, and lustrous. Its tensile strength is 6.5 g per denier, compared with 3.0 to 5.0 for cotton. Its suppleness and spinning power are closely connected with the presence of the natural wax. If the wax is removed completely the fibres become brittle, rough, and lustreless. This is one of the factors in favour of natural retting because chemical methods tend to remove too much wax.

The recognized regain for linen is 12 per cent and the yarn is about 20 per cent stronger when wet than dry. The count of linen yarn is based upon a hank of 300 yd, the number of such hanks weighing 1 lb denoting the count. Flax and other multicellular fibres are rendered more suitable for spinning by a process known as cottonizing. This consists of passing the fibre through specially constructed tearing and crimping machines, or of treatment with strong alkali. The object of the process is to separate the fibre into its ultimate cells which range in length from $\frac{1}{4}$ to $2\frac{1}{2}$ in. thereby giving a physical condition similar to that of cotton.

The chemical constituents of flax are the same as those of cotton, namely, cellulose, proteins, pectins, oil, wax, mineral salts, and natural colouring matter. When purified, cellulose derived from flax is identical with that of cotton. The total extent of the impurities can be as high as 25 to 30 per cent and they are mainly pectins and pectoses. Their complete removal presents some difficulty.

RAMIE

Ramie and china grass consist of the bast fibres from a species of stingless nettle belonging to the natural order URTICACEAE (subdivision *Boehmeria*). The species known as *Boehmeria* is the white-leaved ramie which has been cultivated in China from time immemorial, and *Boehmeria tenacissima* is the green-leaved variety which grows in India and Malaya. The plants are shrubs which grow to a height of 4 to 8 ft. They are hardy, grow rapidly and yield three or four crops a year.

At the right state of growth the plants are cut down and the fibrous tissues situated near the bark are pulled away by hand. This is made easier by beating the stems against rocks or battering them with wooden mallets. In the Far East the fibres are still separated manually, but machines have been designed which can replace human labour. In primitive countries the fibres are then dried and bleached in the sun, but where more advanced methods are used they are purified by boiling in alkali and then bleaching with hypochlorite.

The microscopic appearance of ramie fibres is similar to that of flax but they are coarser and have a wider lumen as illustrated in Fig. 4.4. Bleached ramie is white and lustrous and is extremely durable but lacks flexibility and elasticity. It also has a peculiar hairiness which, whilst enabling it to

be worked with wool, renders it unsuitable for garments which have to be worn next to the skin.

Ramie can be spun alone or with cotton and mercerization gives an increased lustre and a loss of hairiness. When the mercerization is carried out without tension the fibre becomes twisted and very like natural cotton in appearance (*B* in Fig. 4.5), but under full tension no twist appears and the fibre bears a closer resemblance to mercerized cotton, (Fig. 4.5 *A*).

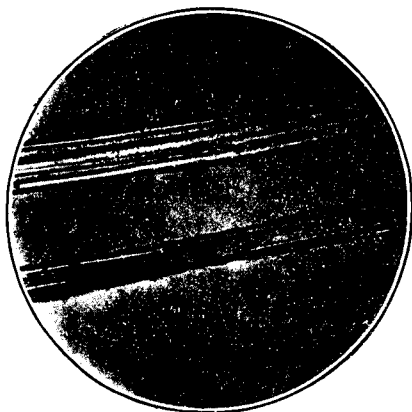

Fig. 4.4 Ramie fibres

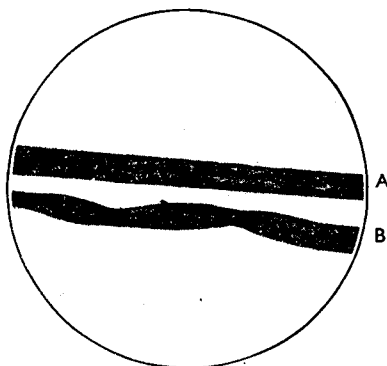

Fig. 4.5 (A) Single ramie fibre mercerized under full tension (B) Single ramie fibre mercerized without tension

Ramie is used to make ropes, strings, and fishing nets. It is also used for textiles in the East either alone or with other fibres. In China it is used for making 'grass cloth' and 'white summer cloth'. It can be bleached to a good white and dyes quite satisfactorily with all the cotton dyes.

HEMP

Hemp is derived from a plant known as *Cannabis sativa*. It has not been cultivated for its fibres for as long as flax, and it is believed to have originated in the marshy regions south-west of the Caspian Sea. It spread to India and China and later to Italy, Switzerland, and France. It is cultivated not only for the sake of its bast fibres but also on account of the seeds from which hashish is obtained. The plant is robust and grows naturally, requiring little cultivation. The stalks may reach a height of 10 ft or more. The male and female flowers are borne on separate plants. The male is cultivated purely for its fibre, apart from its function of fertilizing the female flower. In the case of the female the flowers are allowed to ripen so that the seeds can be harvested. This means that the male stalks should be gathered 2 or 3 weeks before the female ones because the bast fibres are at the best stage of development at different times in the two sexes.

Hemp is retted in water tanks in a manner similar to flax, after which the stalks are laid out to dry. The fibres are then separated either manually or mechanically by passing through fluted rollers which crush the woody tissues. At this state the hemp is softened by beating with a softwood mallet on a flat stone or a hard floor. The same effect can also be achieved when a heavy millstone, usually operated by water power, rolls over the fibres for 3 or 4 hours. Finally the fibres, which tend to stick together, are separated by combing.

Hemp is used to a large extent in making string and rope for which its marked tensile strength makes it particularly useful. It is also spun into yarns and woven into cloths. The finest varieties, such as those which are cultivated in Italy, bleach well and can be spun alone or with other fibres. The coarser types have a dark colour which prevents them from being used for textiles.

Microscopic appearance of hemp

Hemp fibres are very similar to flax, but less regular, and the articulations are not so well marked. The lumen is rather broad and easier to see than in the flax fibre and the ends of the fibres are rounded or blunt. The microscopic appearance, multiplied 75 times, is shown in Fig. 4.6. A cuticle is present and the fibre shows globular swellings like cotton when treated with Schweitzer's reagent; in this respect it differs from flax. A further distinction (FLATTERS, *J.S.D.C.*, 1920, 76) is the action of sodium hydroxide. When treated with this reagent flax swells uniformly and the lumen shows up distinctly, whilst the fibre substance becomes transparent. When hemp is mounted in caustic soda the contours appear irregular, the fibre non-transparent, and the wall of the lumen indistinct. Flax swells much more in sodium hydroxide, giving an 85 per cent increase in diameter, whilst with hemp it is only 25 per cent. Hemp fibres are remarkable for their length, ranging from 100 to 300 cm. The ultimate fibrils are 1.5 to 2 cm long and have a diameter ranging between 0.016 mm and 0.05 mm. In comparison with flax, hemp contains a greater proportion of lignocellulose, which is demonstrated by the yellow stain which appears in the presence of an aqueous solution of aniline sulphate.

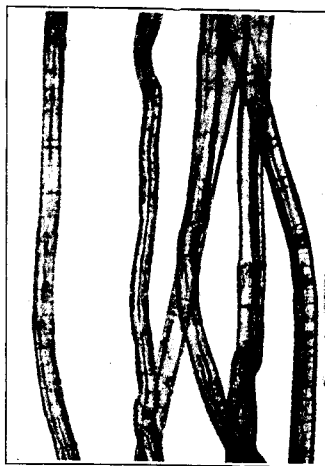

Fig. 4.6 Italian hemp fibres

JUTE

Jute fibres are obtained from the genus *Corchorus* of the order TILIACEAE. There are two species of the order cultivated for the sake of their fibres, namely *C. capsularis* and *C. olitorius*, both of which are found growing naturally throughout the tropics. Jute has been cultivated in India since time immemorial, where its stem was used as a source for fibres and its leaves as a vegetable. Large quantities of jute have been used in Dundee, where it was first spun in 1828. It proved to be eminently suitable for making sacks, and as world trade increased so grew the demand for jute bags as a cheap means of packaging.

Most of the world's supply of jute comes from Bengal, where it is cultivated in the alluvial soils of the delta regions of the Ganges and the Brahmaputra. After the ground has been prepared by ploughing, the seeds are sown between February and June according to climatic conditions. The plants grow to a height of 6 to 12 ft and the stems are harvested shortly after the flowers have appeared. They are retted by immersion in water during periods varying from 12 to 25 days. The fibres are then separated from the residue of the stem tissues by manual labour, an operation which is sometimes made easier by preliminary beating with wooden mallets to break up woody cells. After further washing the jute is dried and packed in bales for delivery to the spinning mills.

Microscopic structure

Jute fibres are similar in appearance to flax and hemp but are characterized by the irregularity of the lumen. This is caused by variations of the



Fig. 4.7 Cross-section and longitudinal view of jute ($\times 500$)

(Courtesy of 'Ciba review')

cell walls, which are thick in some places and extremely thin in others. The variation in the size of the lumen is seen in both the cross-sectional and the longitudinal microscopic views of fibres shown in Fig. 4.7 (magnification $\times 500$).

Jute fibres are very long, ranging between 150 cm and 300 cm. The individual fibrils are from 1.5 to 4 mm in length and have diameters between 0.015 and 0.002 mm. The tensile strength is not great in comparison with other fibres and the elasticity is low, but this is an advantage in sacks, because it means that they will retain their shape when loaded. Jute is brown and is not used for clothing, although it was probably used to make the 'sackcloth' referred to in the Bible.

Chemically, jute differs from the other multicellular fibres in containing a considerable proportion of lignin, which usually accompanies cellulose in woody tissues. Lignin stains yellow with an aqueous solution of aniline sulphate, or crimson red with phloroglucinol and hydrochloric acid. The latter reagent is made by dissolving 1 g of phloroglucinol in 10 ml of alcohol or methylated spirit and adding an equal volume of 10 per cent hydrochloric acid just before use. The material to be tested is soaked in the reagent and then warmed in a porcelain dish on a water-bath. The constitution of lignin has not been established. It is believed that there is some kind of linkage between the lignin and the cellulose molecules. It certainly contains methoxy and phenolic hydroxyl groups. Freudenberg, for example, has suggested that lignin derived from spruce is built up of structural units of 3:4 dihydroxy phenylpropane:

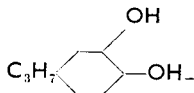

Jute is difficult to bleach, since it suffers degradation when treated with chlorine, especially in alkaline solutions. The best varieties, however, have comparatively little colour and can be dyed without bleaching. Jute differs from other vegetable fibres in having a moderately good affinity for basic dyes.

5 · Animal fibres

WOOL

WOOL is the animal fibre of outstanding importance. Its origin is characteristic of all hairs because it is a growth of the epidermis, as are horns, nails, and hoofs. The skin consists of two distinct layers, of which the outer exposed zone is the epidermis and the inner tissue is the dermis (see Fig. 5.1). The function of the epidermis is mainly protective and it consists of

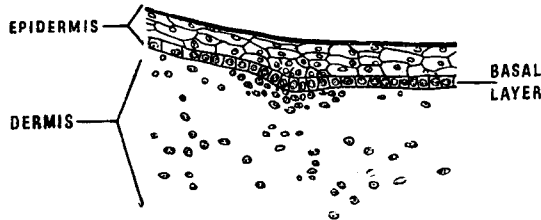

Fig. 5.1 Structure of skin
(Courtesy of International Wool Secretariat)

an outer zone of hard horny cells with several layers of cells below which are still of a hard nature but somewhat less scale-like. The basal layer (see Fig. 5.1) of the epidermis is actively growing and divides to create new epidermal cells which gradually move outwards accompanied by progressive increase in horniness. These replace the external cells lost by friction, injury, or the normal degrading effects of exposure. The dermis is looser in structure and contains the sweat and sebaceous or fat glands, and is well supplied with nerves and blood vessels.

The first stage in the growth of a hair is that a portion of the epidermis

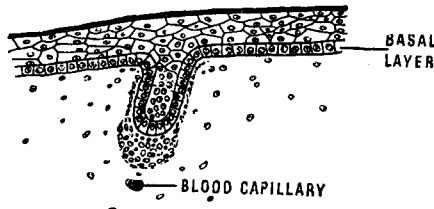

Fig. 5.2 Rudimentary wool follicle
(Courtesy of International Wool Secretariat)

turns inwards into the dermis in the form of a plug (see Fig. 5.2). The plug continues to grow downwards and begins to develop sebaceous and sweat glands as well as a dome-shaped papilla at the base as shown in Fig. 5.3.

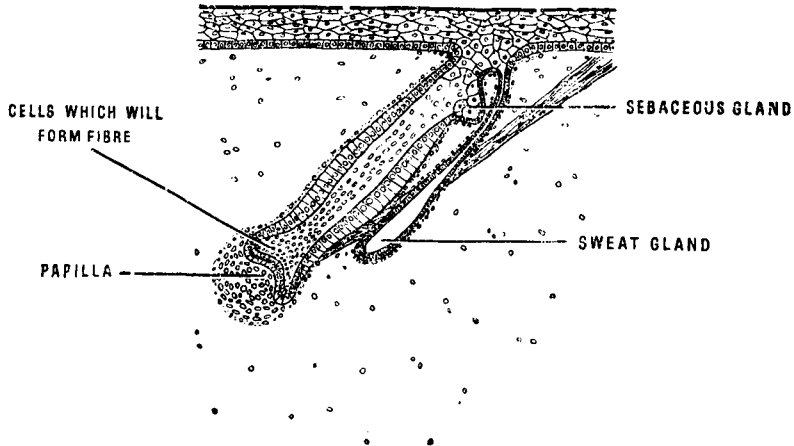

Fig. 5.3 Wool follicle with rudimentary fat and sweat glands
(Courtesy of International Wool Secretariat)

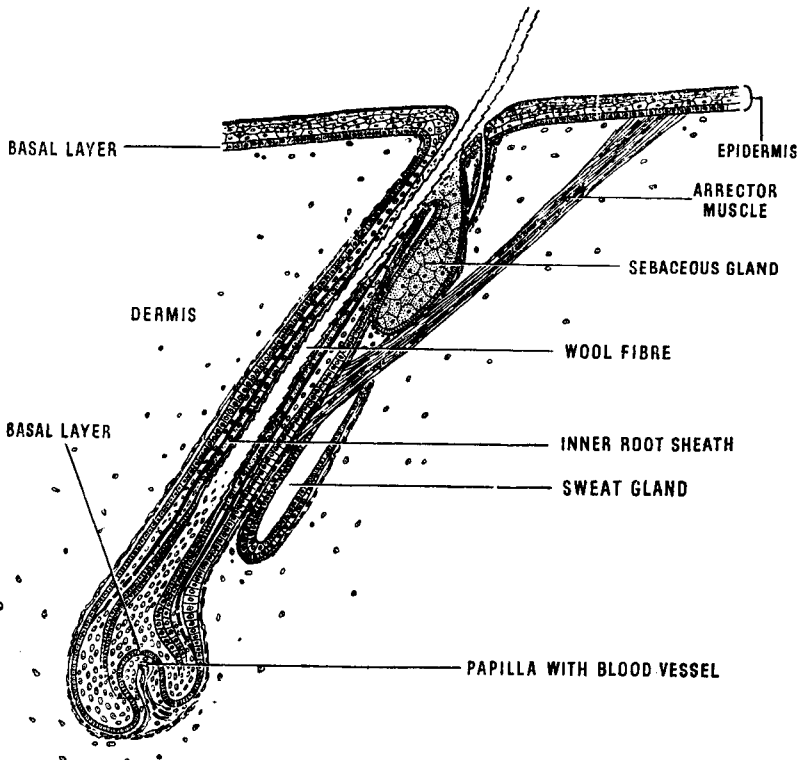

Fig. 5.4 Longitudinal section of a completely developed wool follicle (x 500)
(After Wildman)
(Courtesy of International Wool Secretariat)

This papilla in time becomes supplied with blood vessels to nourish the hair whilst it grows upwards from the bottom of the recess in the epidermis. The structure of the mature hair is shown in Fig. 5.4.

Wool has special features which distinguish it from other hairs but which render it supremely valuable as a textile fibre. These differences are of a physical nature and the basic tissues and chemical structure of all animal hairs, including wool, are similar. Hairs have a somewhat swollen

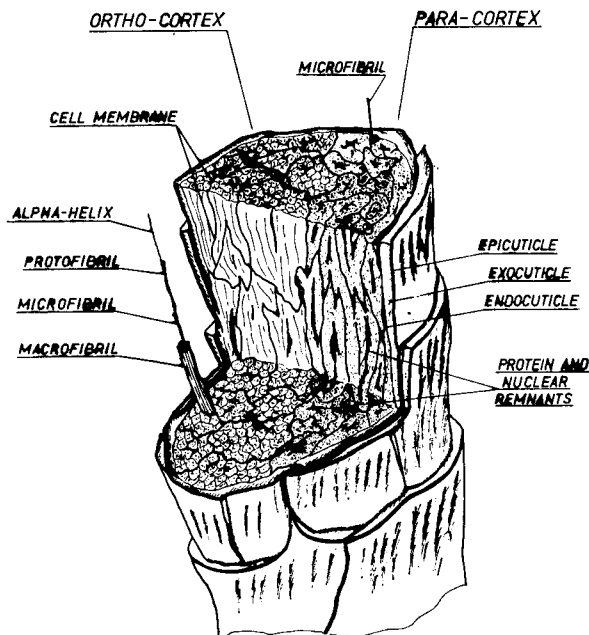

Fig. 5.5 Wool fibre

(Sikorshi et al. *J.T.I.*, 1961, 52, T.153)

root at the point of attachment to the papilla at the base, and a tip towards which they taper, ultimately becoming a fine point.

The wool fibre is complex in structure and composed essentially of three tissues, the cuticle, the cortex and the medulla. Each of these, however, is further subdivided by tissue differentiation. A purely diagrammatic illustration of the structure of a non-medullate fibre is shown in Fig. 5.5.

The cuticle is formed of thin scales of hard and horny consistency. These overlap and protrude for about one third of their length, the ends being directed towards the tip of the fibre as shown diagrammatically in Fig. 5.6. The outermost layer of these scales is a tough membrane known as the epicuticle. Beneath this is situated the exocuticle and the innermost layer is described as the endocuticle. The epi- and the exo- cuticles contain a high proportion of sulphur with many cystine cross linkages giving them a

high measure of resistance to biological and chemical attack. The endocuticle on the other hand is somewhat less resistant. There are intercellular membranes which act as a cement holding the cuticle to the adjacent tissues.

About 90 per cent of the fibre is composed of cortical cells. When wool is treated cautiously with protein-degrading enzymes or is partially disintegrated by bacterial attack, bundles of elongated cells can be distinguished (see Fig. 5.7). Further degradation releases the individual cortical cells which are spindle-shaped, and which can, by mechanical treatment, be broken down into macrofibrils which, when examined under an electron microscope, are seen to be composed of still smaller microfibrils. The tensile strength, elastic properties, and the natural colour of the wool are determined mainly by the nature of the cortical cells.

The cortical cells are not all alike in chemical reactivity nor in response to microscopical stains. The more reactive component is known as the orthocortex and the other as the paracortex. It appears that distribution of the two varieties is such as to divide the cortex longitudinally into two hemicylinders. The relative proportions of the two phases has a bearing on the crimp of the fibre.

The cortical cells are not all alike in chemical reactivity nor in response to microscopical stains. The more reactive component is known as the orthocortex and the other as the paracortex. It appears that distribution of the two varieties is such as to divide the cortex longitudinally into two hemicylinders. The relative proportions of the two phases has a bearing on the crimp of the fibre.

There is no essential difference between wool and most animal or human hairs. In Fig. 5.6 it will be observed that the scales are smaller and more numerous on hairs. In human hair the outlines are more rounded and there is no free projecting edge. The medulla also is more plainly marked than in

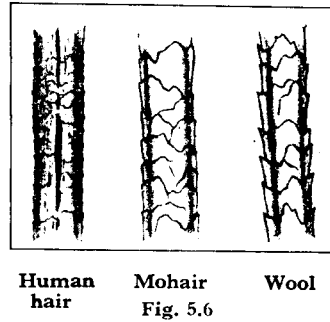

Human hair Mohair Wool
Fig. 5.6



Fig. 5.7 Wool fibres degraded by bacterial action

wool. Human and many animal hairs are deeply pigmented, making them unsuitable for textile use. All stages of development from a typical wool fibre to a hair are found in the fleece of any sheep and the quality depends upon the part of the body upon which the wool grew. When the fleece is shorn it is spread out and sorted by the wool sorter into its various grades. Fig. 5.8 (BOWMAN, *Structure of the Wool Fibre*) is a diagrammatic representation of a fleece, and the grading of the qualities obtained from it is represented by the letters, with *A* being the best. Sorting is a highly skilled occupation because it is based entirely on personal judgement.

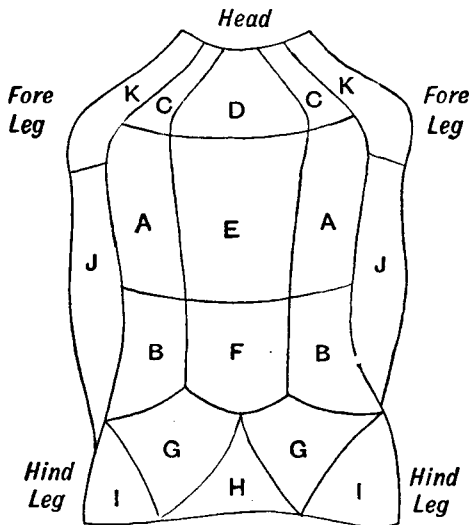

Fig. 5.8 Grades of wool in spread fleece

When wool is shorn from a living sheep it is called fleece wool, but when removed from the carcass of a dead animal it is known as skin wool. Fleece wool may be either the first shearing, which yields lamb or hog wool, or subsequent crops which are wether wool. As might be expected, hog wool is finer in texture and has the pointed upper ends of the original fibres which never appear in subsequent shearings. When the sheep dies, or is killed, its skin, together with the fleece, is soaked in milk of lime or some other depilatory agent to loosen the hair roots. The fibres then pulled out are known as skin wool. It may be somewhat harsh owing to the action of the alkali on the wool substance, and the epithelial scales may appear to have been modified when examined under the microscope.

Wool qualities

The quality of wool is expressed by a number which was intended to represent the finest single-fold count that could be spun from fibres of that particular grade. Thus:

60 quality should spin a 60/1 yarn
 48 quality should spin a 48/1 yarn.

The qualities range from 32 at the lowest end to 80 at the highest. Qualities of 60's and upwards are often referred to as Botanies. The reason is that the early immigrants to Australia settled in Botany Bay and the wool which they produced was named after this. This early Australian fibre was, at that time, of good quality, and Botany gradually became adopted as a general name for all good wools. The sheep which yielded Botany wool were no good for mutton, but before the days of refrigeration this did not matter because it was impossible to ship the meat. When, however, it did become possible for Australia to export the carcass as meat, it became highly important that a breed should be found which could give wool of adequate quality as well as an edible carcass. The result was achieved by cross-breeding, giving a sheep yielding wool which was known as cross-bred.

Fine cross-bred wools are	50's to 58's quality;
medium cross-bred wools are	46's to 48's quality;
low cross-bred wools are	32's to 44's quality.

The factors which determine quality are primarily diameter and length of fibre, but of the two the diameter is the more significant. Other attributes which are desirable are good colour and softness of handle. Wool fibres generally contain crimps varying from 27 to 30 per inch in the best qualities down to 5 to 7 in the lower grades. The wool sorter makes a subjective assessment of all these properties, but there is no perfect objective method of determining quality, and in practice mean fibre diameter has proved to be the most acceptable measurement. In the table below the generally recognized correlation between quality and fibre diameter is given.

<i>Quality</i>	<i>Average diameter in microns (10^{-4} cm)</i>	<i>Quality</i>	<i>Average diameter in microns (10^{-4} cm)</i>
80's	18.8	50's	30.5
70's	19.7	48's	32.6
64's	20.7	46's	34.0
60's	23.3	44's	36.2
58's	24.9	40's	38.7
56's	26.4	36's	39.7

The apparatus shown in Fig. 5.9 was devised by the Wool Industries Research Association for the rapid determination of the mean fibre diameter of wool samples. The instrument consists of a microscope *L* which projects an image enlarged 500 times onto the white screen *T*. The stage *S* carries a glass slide on which the sample to be measured is mounted, and illumination is provided by the lamp at *H*. The focusing and movement of the stage are controlled by the adjustment mechanisms marked *C*₁ and *C*₂. A convenient way of preparing a suitably randomized sample of the fibres is to

wind them round a pencil and then cut out a large number of short lengths with two safety-razor blades mounted in a frame which holds them 3 mm apart. As the stage is moved across the field of the microscope by C_2 , the images of a large number of segments of fibres are thrown onto the screen T and their widths are measured with a transparent ruler calibrated to read

the diameters directly in microns. It is usually considered necessary to record at least 200 readings to arrive at a reliable average. In the conditions laid down by the United States Official Standards Bureau, averages of 400 measurements are required for 70's to 80's qualities, 600 for 62's to 64's, 800 for 58's to 60's, and 1200 for 50's to 56's. The reason for this graduation is that fibre diameter is more uniform in the better qualities. Specific instructions for a standardized method of carrying out this test as well as a description of a simple device for cutting segments of equal length are given in the International Wool Textile Organization publication 8-61(E).

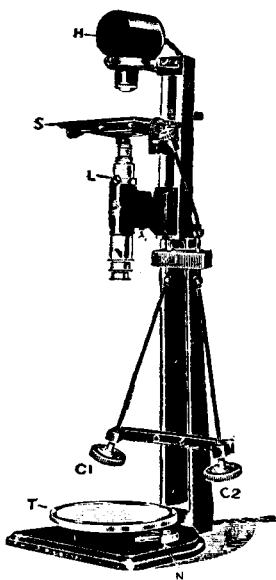

Fig. 5.9 Apparatus for measuring fibre diameter

A very quick and simple method of determining the mean fibre diameter of samples of wool fibre which is gaining increasing popularity is the air flow method. When a current of air is passed through a uniformly arranged mass of fibres the drop of pressure between the entry and emerging sides is proportional to the total surface of the fibres which, in turn, is governed by the mean fibre diameter. The general arrangement of the apparatus is shown in Fig. 5.10. It is calibrated with samples of known quality.

A laboratory specimen of the wool to be tested weighing about 8 g should be degreased with petroleum ether, from which a randomized specimen of $1.5 \text{ g} \pm 2 \text{ mg}$ is weighed out and pulled out into a long thin sliver which is fed into the constant volume chamber A . The perforated plunger is inserted and the cap is screwed down to its full extent. The air valve B is adjusted till the air flow is constant as indicated by the float in F remaining stationary at the calibration mark Y . If the level of the flow meter remains constant before and after the insertion of the sample the differences in the levels of D and Z in the manometer will be a measure of the mean fibre diameter. As an alternative the levels in the manometer can be kept constant by adjusting the valve B and the mean fibre diameter can then be ascertained from the difference in the level of the float in the flowmeter [See International Wool Textile Organization, 6-60(E)].

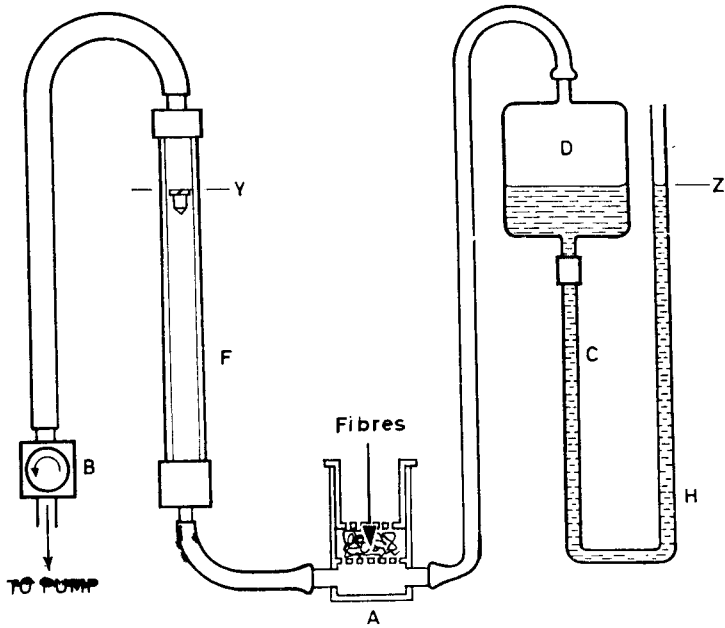

Fig. 5.10 General arrangement of apparatus

(Courtesy of International Wool Textile Organisation)

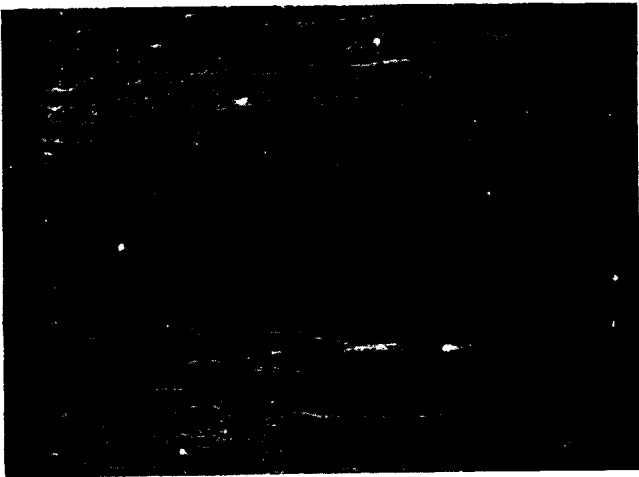

Fig. 5.11 Neps

(Courtesy of International Wool Textile Organisation)

Neps and Kemps

Neps are small bunches of entangled fibres. There is usually a compact central core with a less densely packed fringe. The diameter of the central core may be between 0.53 and 4 mm. The appearance of neps is shown in Fig. 5.11. Kemps are abnormal fibres which can be very troublesome. They are characterized by coalescence of the epithelial scales to form a

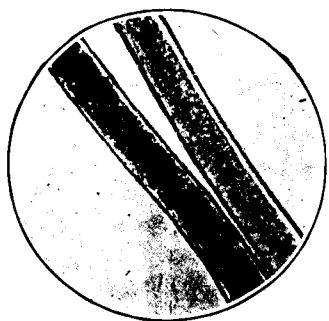

Fig. 5.12 Kemps

a dark horny sheath. This structural change often extends beyond the scales into the cortex, giving a hard fibre which is apparently composed entirely of hornlike tissue. Examples are shown in Fig. 5.12. Occasionally two or more adjacent fibres coalesce to form a flat compound kemp. It is more common to find kemps on the neck and legs than in other parts of the body, and they are also more prevalent in diseased than in healthy sheep. Kemps are objectionable because they resist penetration by the dye liquor and therefore

cause an uneven appearance in coloured materials.

Composition of raw wool

Basically wool, like all other hairs, animal horns, and finger-nails, is composed of a special protein called keratin, which differs from others on account of its high-sulphur content. Raw wool, however, may contain between 30 and 70 per cent of impurities. The amounts of pure wool yielded from the fleeces of various breeds are tabulated below.

<i>Breed</i>	<i>Pure wool (per cent)</i>
English Wensleydale	53
English Hampshire	60
Australian Merino (greasy)	40 to 45
Buenos Aires wool	40 to 45
Cape wool	35 to 55
German wool (greasy)	25

The impurities are wool fat, suint (which is dried perspiration), dirt, mineral matter, and burrs (which are dried vegetable matter). As an example, the approximate composition, per cent, of a dirty wool might be:

Keratin	33
Dirt	26
Suint	28
Fat	12
Mineral matter	1

Suint

This is soluble in water and can be isolated from the raw wool by aqueous extraction. It contains potassium salts of fatty acids, such as oleic and stearic acids, and potassium carbonate is also present. The simpler organic acids, such as acetic, lactic, butyric, valeric, and capronic acids, have also been found both in the free state and as their potassium salts. Amino acids such as leucine, glycine, and tyrosine have been detected. Suint, therefore, is a complex mixture; this might be expected because it is derived from sweat, which is known to be one of the means by which an animal discards unwanted waste products of its metabolism.

Wool fat

Most natural fats are the product of combination between glycerol and fatty acids. Wool fat, however, is derived from fatty acids and a complex monohydric alcohol, cholesterol ($C_{27}H_{45}OH$), or its isomer, ischolesterol. Strictly speaking, this is not a fat but a wax, since all true fats are compounds of glycerol. Wool fat is a yellowish wax-like substance soluble in organic solvents. It resembles other waxes, including cotton wax, in that it is difficult to saponify. When heated for a long time with alcoholic potassium hydroxide, or more rapidly when treated with a solution of potassium hydroxide in glycerol, it is split up into cholesterol and the potassium salt of the fatty acid. Wool wax has the power of absorbing large quantities of water with which it forms stable emulsions. It can, for example, be mixed with about 80 per cent of its weight of water and still retain a creamy consistency in which the two phases do not separate out. Lanoline, much used in toilet preparations, is a mixture of purified wool wax with about 20 per cent of water.

Mineral matter

The natural mineral matter in wool rarely exceeds 1.5 per cent. Its composition appears to vary to some extent according to the nature of the soil upon which the sheep graze. Bowman gives the following composition for the ash of wool,

Potassium (as K_2O)	31.1 per cent
Sodium (as Na_2O)	8.1 per cent
Lime	16.9 per cent
Alumina and iron oxide	12.3 per cent
Silica	5.8 per cent
Sulphur trioxide	20.5 per cent
Phosphorus	Trace
Chlorine	Trace

Adventitious dirt

The fibre, in its natural state, also contains a considerable amount of adventitious dirt. This is held by the adhesive action of the grease and falls away when the latter is removed during scouring. Fragments of vegetable

substance picked up from various sources are often collected when sheep scratch against bushes to relieve itching. They may be particles of straw, seed, burrs or bast fibre.

Keratin

When all impurities have been removed, keratin remains. This is prepared in a chemically pure state in the laboratory by extracting dry wool in a soxhlet with ether to remove the oil and fat, and then with alcohol to take away the soaps. The residue is next dried and immersed in warm distilled water to dissolve the suint, after which it is soaked in a 1 per cent solution of hydrochloric acid to decompose any calcium or magnesium soaps which may be present. After rinsing in distilled water the wool is dried and extracted again with ether to remove the fatty acids which have been liberated, and finally rinsed in dilute ammonia till free from acid before drying. Keratin which has been purified in this way has the following average composition.

Carbon	50 per cent
Oxygen	22 to 25 per cent
Nitrogen	16 to 17 per cent
Hydrogen	7 per cent
Sulphur	3 to 4 per cent.

Keratin belongs to the group of compounds classed as proteins which are the ultimate stage of complexity of organic matter before it becomes living tissue. A brief description of the chemistry of proteins is desirable for an understanding of the properties of animal fibres. This branch of organic chemistry has assumed profound importance because it will lead to a better understanding of the basic phenomena of life.

Proteins are giant molecules built up by the condensation of a number of comparatively simple alpha amino acids, in which the amino nitrogen is attached to the $-\text{CH}_2-$ group adjacent to the carboxyl radical, e.g. $\text{CH}_3\text{.CH}(\text{NH}_2)\text{.COOH}$ (alanine). The simplest of the α amino acids is

glycine, $\overset{\text{a}}{\text{C}}\text{H}_2(\text{NH}_2)\text{.COOH}$, two molecules of which condense as follows:

$$\text{HOOC.CH}_2\text{.NH}_2 + \text{HOOC.CH}_2(\text{NH}_2) \rightarrow \text{HOOC.CH}_2\text{.NH.CO.CH}_2\text{NH}_2 + \text{H}_2\text{O}$$

(1)

The compound (1) still contains a primary amino group which can be condensed with another molecule of glycine to give the product represented in formula (2)

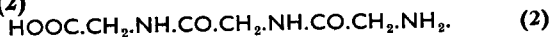

By continuing this condensation a very large molecule, known as a peptide, can be built up in which the group $-\text{NH.CO.CH}_2-$ is repeated very many times. Peptides are degradation products of proteins and therefore of a similar but somewhat less complex structure. Glycine is the simplest α amino acid, but as many as thirty others have been isolated from proteins of which four examples are:

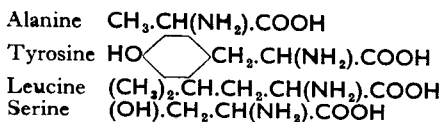

Because the amino group which condenses with the carboxyl radical of the adjacent molecule is in the α position, the whole of the remainder of the molecules in the more complex amino acids appear as side chains substituting one of the hydrogen atoms in the CH_2 component of the main skeleton. Thus an extremely simple peptide, built up out of tyrosine and leucine residues, would have the structural formula:

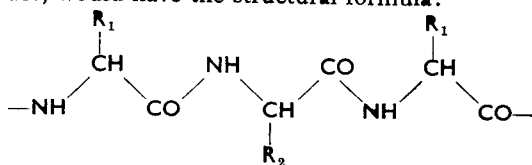

in which R_1 is the tyrosine residue ($\text{HO}-\text{C}_6\text{H}_4-\text{CH}_2-$) and R_2 the leucine residue [$(\text{CH}_3)_2.\text{CH}.\text{CH}_2-$].

By means of careful hydrolysis with acids it is possible to isolate all the amino-acid components of keratin. According to Astbury (*J. Chem. Soc.*, 1942, 337) the most probable composition is shown in Table 5.1.

Table 5.1 Amino acids in keratin

		<i>Per cent</i>
Alanine	$\text{CH}_3.\text{CH}(\text{NH}_2).\text{COOH}$	4.13
Arginine	$\text{NH}_2.\text{C}(\text{NH}_2).\text{NH}.\text{C}(\text{CH}_2)_3.\text{CH}(\text{NH}_2).\text{COOH}$	10.3
Aspartic acid	$\text{HOOC}.\text{CH}_2.\text{CH}(\text{NH}_2).\text{COOH}$	6.57
Cystine	$\text{HOOC}.\text{CH}(\text{NH}_2).\text{CH}_2.\text{S}.\text{S}.\text{CH}_2.\text{CH}(\text{NH}_2)$ <div style="margin-left: 200px;">COOH</div>	11
Glutamic acid	$\text{HOOC}.\text{CH}_2.\text{CH}_2.\text{CH}(\text{NH}_2).\text{COOH}$ <div style="margin-left: 200px;">COOH</div>	14.1
Glycine	$\text{CH}_2(\text{NH}_2).\text{COOH}$	6.5
Histidine	$\text{C}_5\text{H}_7\text{N}_2.\text{CH}_2.\text{CH}(\text{NH}_2).\text{COOH}$	0.7
Hydroxylysine	$\text{NH}_2.\text{CH}(\text{OH})(\text{CH}_2)_3.\text{CH}(\text{NH}_2)$ <div style="margin-left: 200px;">COOH</div>	0.15
Leucine	$(\text{CH}_3)_2.\text{CH}.\text{CH}_2.\text{CH}(\text{NH}_2).\text{COOH}$	11.3
Lysine	$\text{NH}_2(\text{CH}_2)_4.\text{CH}(\text{NH}_2).\text{COOH}$	2.65
Methionine	$\text{CH}_3.\text{S}.\text{CH}_2.\text{CH}_2.\text{CH}(\text{NH}_2).\text{COOH}$	0.7
Phenylalanine	$(\text{C}_6\text{H}_5).\text{CH}_2.\text{CH}(\text{NH}_2).\text{COOH}$	3.75
Proline	CH_2-CH_2 <div style="margin-left: 50px;">CH_2</div> <div style="margin-left: 100px;">$\text{CH}.\text{COOH}$</div> <div style="margin-left: 100px;">NH</div>	6.8
Serine	$(\text{OH}).\text{CH}_2.\text{CH}(\text{NH}_2).\text{COOH}$	10.3
Threonine	$\text{CH}_3.\text{CH}(\text{OH}).\text{CH}(\text{NH}_2).\text{COOH}$	6.4
Tryptophane	$\text{C}_8\text{H}_7\text{N}.\text{CH}_2.\text{CH}(\text{NH}_2).\text{COOH}$	1.8
Tyrosine	$\text{OH}-\text{C}_6\text{H}_4-\text{CH}_2.\text{CH}(\text{NH}_2).\text{COOH}$	4.65
Valine	$(\text{CH}_3)_2.\text{CH}.\text{CH}(\text{NH}_2).\text{COOH}$	4.8

It will be observed that these percentages add up to more than 100, but this is because hydrolysis adds back the water which was eliminated by condensation during the formation of the protein molecule.

Just as, in the case of cotton, the demonstration that cellulose was made up of glucose units did not explain why the polymer was fibre forming also, out of the thousands of proteins which are polymerides of amino acids, only keratin and one or two others are fibre forming. It was not until Astbury applied methods of X-ray analysis that it was established that the long-chain keratin molecules are organized in crystalline and amorphous regions. Unstretched and stretched wool fibres show different X-ray diffraction

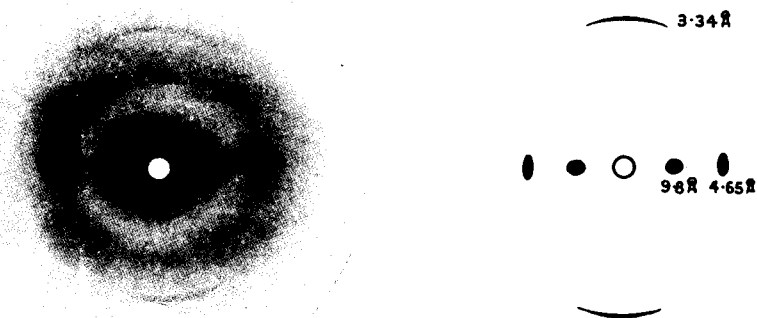
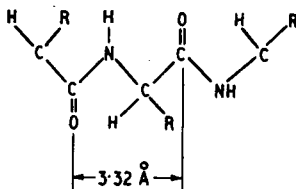

Fig. 5.13 X-ray diagram of β keratin

(Courtesy of International Wool Secretariat)

diagrams, corresponding with two forms known as α and β keratin respectively. The pattern for β keratin is shown in Fig. 5.13, indicating a repeat period in the longitudinal axis of 3.34 Å (0.334 nm). This corresponds with 3.32 Å (0.332 nm) spacing of the zigzag structure of the fully extended peptide chain.



In α keratin the longitudinal spacing is 5.14 Å (0.514 nm) as shown in Fig. 5.14. Astbury and Bell (*Nature*, 1941, 696) explained the elasticity of wool together with the alterations in the X-ray diagrams, by the existence of a fold in the peptide chain in the unstretched state. The fold must be one which shows a repeat at 5.1 Å (0.51 nm) and the α form must be half



Fig. 5.14 X-ray diagram of α keratin

(Courtesy of International Wool Secretariat)

the length of the β configuration because the fibre is capable, under some conditions, of undergoing 100 per cent extension without loss of power of elastic recovery. To explain these and other facts, Astbury and Bell (*loc. cit.*) suggested that the structure of α keratin was as shown in (A) and was capable of undergoing reversible change to (B). (For further information see ALEXANDER AND HUDSON, *Wool, its chemistry and physics*, 1st edn., pp. 362 *et seq.*)

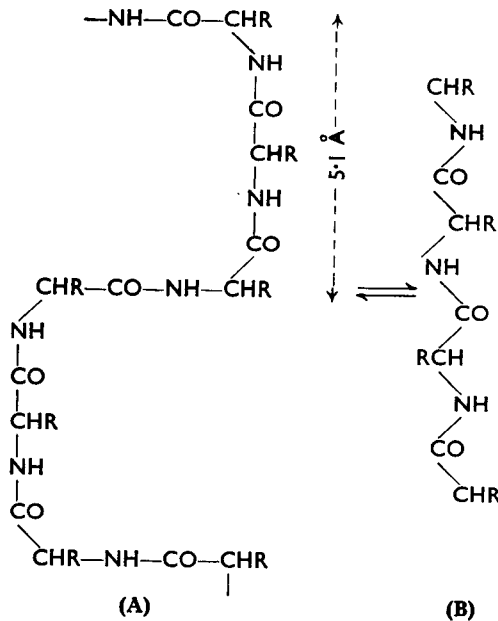

Great advances have been made in protein chemistry since the time of Astbury's pioneering work. Polyalanine, like keratin, exists in an alpha form which may be transformed into the beta configuration by stretching. It is much easier to interpret X-ray diffraction diagrams of substances of known constitution, such as polyalanine, than those obtained from the infinitely more complex keratin molecule.

The pattern yielded by the alpha form of polyalanine corresponds with

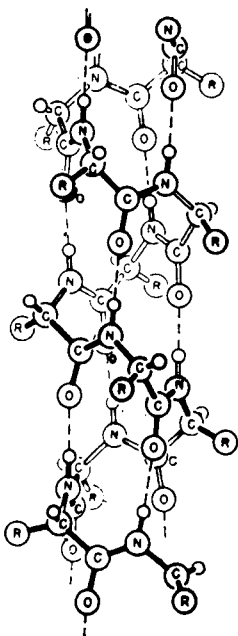

Fig. 5.15 α -keratin

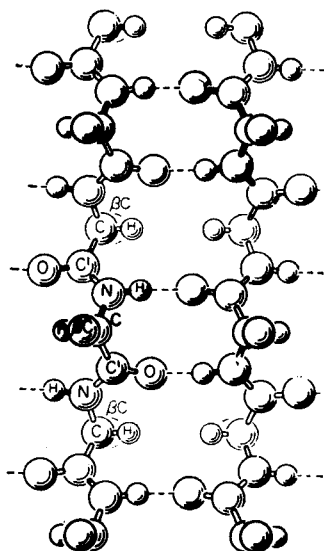

Fig. 5.16 β -keratin

(Courtesy of International Wool Secretariat)

the theoretical requirements of a helical structure as shown in Fig. 5.15 and as represented diagrammatically in Fig. 5.17. A structure of this sort would be expected to show a repeat pattern of 1.5 Å (0.15 nm) corresponding with the rise of each alpha amino acid residue. Reflections derived from this spacing have in fact been found in diffraction diagrams in hairs and in Lincoln wool. The helical structure, however, fails to account for the 5.1 Å (0.51 nm) repeat in the X-ray diffraction diagram of wool. To overcome this difficulty Crick and Rich (*Nature*, 1955, 176, 780) suggested a three strand, and Pauling and Corey, at the same time, a seven strand rope of helical molecules as shown in Fig. 5.18.

In the helical structure hydrogen bonds are formed between carbonyl and secondary amino groups in adjacent turns of the coil as shown by the dotted lines in Fig. 5.15. In the stretched beta form the hydrogen bonds

become intermolecular instead of intramolecular (see dotted lines in Fig. 5.16). Mechanical tension causes the rupture of the hydrogen bonds in the alpha helix and this may be assisted by the action of chemicals as well as by the application of heat. The rupture of these hydrogen bonds is the necessary preliminary to the uncoiling of the molecule for transformation from the alpha to the beta form.

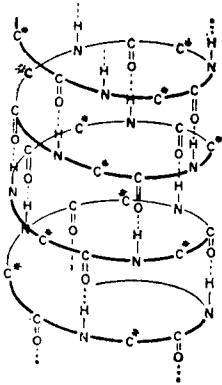

Fig. 5.17



Fig. 5.18 3 and 7 strand helical cable structures

(Courtesy of International Wool Secretariat)

Apart from hydrogen bonds there are also bonds of a chemical nature between adjacent molecular chains. Salt linkages are formed between carbonyl and primary amino groups as shown below:

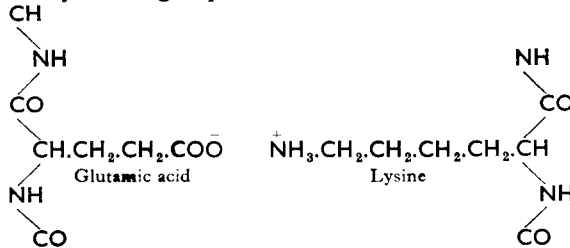

(3)

A unique feature of keratin is the existence of cystine linkages:

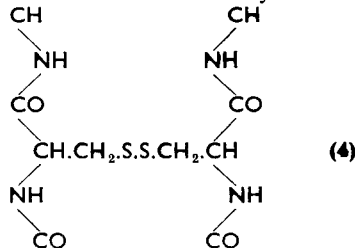

The distances by which the peptide skeletons are separated from each other in the crystalline portions is represented by the spots corresponding with 9.8 Å (0.98 nm) in Figs. 5.13 and 5.14, and it will be observed that this is the only dimension which is not altered on stretching. It is the distance separating the main chains to allow room for the side chains.

The cross-links tend to make the α fold rigid and increase the amount of work needed to stretch the fibres to the β configuration. The effect of salt linkages is demonstrated by the relationship between work required to bring about a specified extension, and pH . Salt links exist between pH 4 and pH 8 but are ruptured by excess of hydrogen or hydroxyl ions:

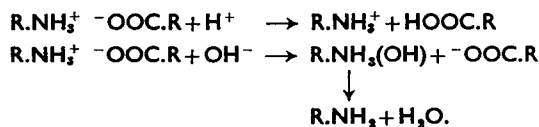

In the graph in Fig. 5.19 the reduction in the amount of work needed to stretch a wool fibre a given amount is plotted over a range of pH values. The work demanded is reduced by a substantial amount at low and high

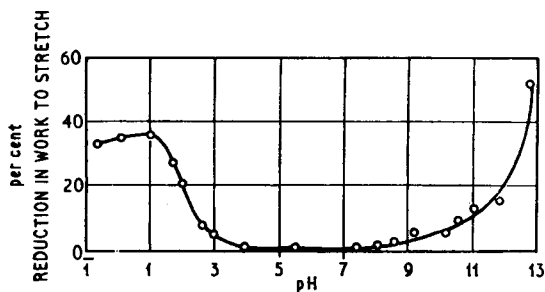
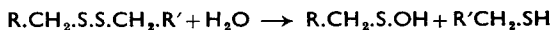

Fig. 5.19 Relationship between pH and work required for equal stretch

pH values when the salt linkages are severed (SPEAKMAN AND HIRST, *Trans. Faraday Soc.*, 1933, 148; also *S.D.C. Jubilee Issue*, 1934). In a similar way the presence of moisture reduces the binding force between the salt linkages by introducing a dielectric film between the positive and negative charges. This is clearly demonstrated in the graphs in Fig. 5.20 (ALEXANDER AND HUDSON, *Wool, its Chemistry and Physics*, 1st edn).

The cystine link also has a profound effect upon the mechanical properties of the fibre. The disulphide bond is covalent and not very sensitive to pH , but there are a number of reagents which can break it down. Water can bring about hydrolysis, especially when in the form of steam with the formation of sulphenic acid groups:



The action of alkalis on the disulphide bond is complex and is accompanied by the formation of inorganic sulphides. The bond is severed, but new cross-links are formed of the type $-CH_2.S.CH_2-$, as demonstrated by Horn, Jones, and Ringel (*J. Biol. Chem.*, 1941, 138, 141), who isolated lanthionine from alkali-treated wool.

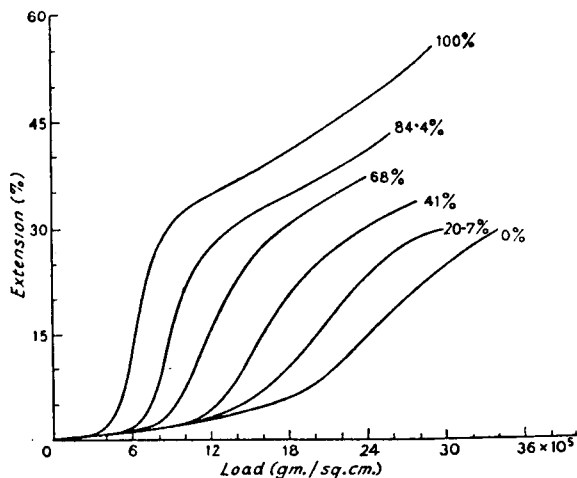
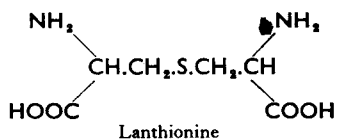
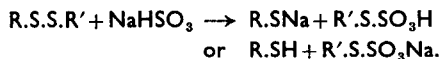

Fig. 5.20 Load-extension curve of Cotswold wool for humidities varying from 0 to 100 per cent at 25°C
(Courtesy of the Royal Society)

Cystine is attacked by sodium bisulphite according to the equation:



There is abundant evidence that oxidizing agents attack the cystine linkage, although the nature of the reaction is obscure. Hydrogen peroxide will, under certain conditions, oxidize all the sulphur with the formation of sulphuric acid or sulphates. Alexander, Hudson, and Fox (*Biochem. J.*, 1946, 50, 27) showed that peracetic acid and other peracids could oxidize all the disulphide groups. A product is obtained which, after acid hydrolysis,

yields cysteic acid $\text{NH}_2\text{CH}(\text{COOH})\text{CH}_2\text{SO}_3\text{H}$. A suggested form of the reaction is as follows:

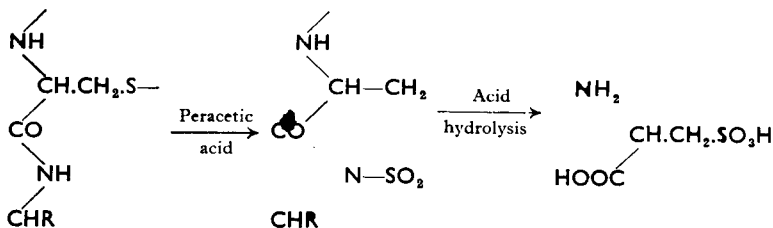

Chlorine and, to some extent, other halogens break down the cystine bonds. It is believed that the reaction is one of oxidation similar to that of peracetic acid.

The setting properties of wool and other keratin fibres arise from the rearrangement of various intermolecular cross-links. When moist wool is dried whilst still under tension it will not return to its original length. The stretch, however, is not permanent. The fibre will contract again either on prolonged standing or when immersed in hot or cold water. This temporary set is usually explained by a rearrangement of the hydrogen bonds. These bonds have sufficient power to impose new dimensions on the fibre but, owing to their relative weakness, the least disturbance, such as immersion in water, severs them and allows the fibre to return to its original condition.

If a wool fibre be immersed under tension in water at 100°C for one hour it will become distorted permanently; in other words, will have acquired a permanent set. Binding forces of a more powerful nature than hydrogen bonds must have been created. The explanation proposed by Speakman (*Nature*, 1933, 132, 930) was that the water severs the cystine linkage with the formation of sulphenic acid and sulphide radicals:

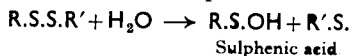

The sulphenic acid side chains then unite with primary amino groups in adjacent molecules according to the following equation:

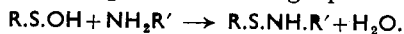

These new cross-links lock the molecules in the positions which they had taken under tension. It has been shown that primary amino groups enter into the mechanism because when they are removed by the action of nitrous acid the wool is not capable of accepting a permanent set. Thioglycollic acid or calcium thioglycollate reduce the disulphide bond as shown:

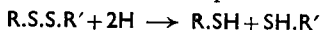

and these sulphide groups can be reoxidized with potassium bromate or a persulphate:

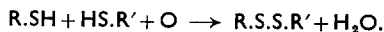

This is the basic reaction involved in the permanent setting of hair. Curl- or wave-producing forces are applied. The cystine linkages are then broken by reduction. The reducing agent is removed and they are reformed in fresh positions by the application of an oxidizing agent. Permanent pleats are produced by spraying with ammonium thioglycollate and then heat pressing under damp conditions and the Si-Ro-Set process is an example of a finish based on these reactions.

Attention must be drawn to the fact that, although there is general agreement that the first step in setting is the breakdown of hydrogen bonds and cystine links, there is not unanimity regarding the mechanism by which the new links are reformed. In addition to the reaction between sulphenic acid and amino groups it was believed that sulphenic acid groups could undergo further breakdown giving rise to aldehyde groups which, in turn, would react with amino side chains:

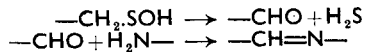

The Wool Industries Research Association disputed the validity of the sulphenic acid amino group theory because they were unable to confirm the existence of thiol groups, nor did setting bring about the anticipated reduction in primary amino groups. These observations led the Wool

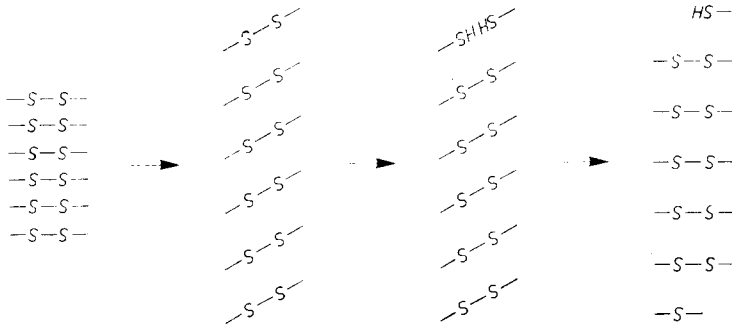

Fig. 5.21

Industries Research Association to suggest that it was the severance and rebuilding of hydrogen bonds which was the exclusive factor responsible for setting. Attempts, however, to obtain setting by reactions which were known to involve hydrogen bonds exclusively were uniformly unsuccessful. More recently Speakman and others have suggested that whilst hydrogen bond rearrangement may be a contributory factor, the formation of a few thiol groups is necessary to initiate an exchange reaction of the nature illustrated in Fig. 5.21.

When wool or hair fibres are stretched in a solution of sodium hydroxide, and the tension is released whilst they are still immersed, they will relax to

a length shorter than they were originally. This is known as supercontraction. Exposure to steam whilst under tension during periods of about one hour or more yields a permanent set, but if the period is only a few minutes supercontraction is observed when the fibre is relaxed by placing in water at 100°C. Many reagents which can rupture the disulphide bond can cause supercontraction. The keratin molecule must be potentially capable of containing more folds than are present in the α configuration. This state cannot be achieved under normal circumstances because of the restraining influence of the cross-links. Supercontraction therefore results from the breaking of these links and permitting relaxation to take place before they have had time to reform.

It was assumed that disulphide bond breakdown was a prerequisite for supercontraction. Later work by Elöd and Zahn (*Melliand Textilber*, 1949, 30, 17) and others has thrown doubt upon the assumption because phenols, formamide, and lithium bromide can all cause supercontraction, and it is well known that they have no effect upon the cystine sulphur. Lithium bromide, in particular, as well as the others, is capable of dissociating hydrogen bonds which points to the probability that the latter are involved.

Moisture in wool

Wool is very hygroscopic and can take up a greater amount of moisture than any other fibre without feeling damp. This property plays an important part in making wool a desirable material to wear next to the skin because it has a considerable capacity to absorb perspiration. Wool can retain 18 to 20 per cent of moisture and the recognized regain for scoured woollen goods is 18.25 per cent. Wool is comparatively expensive, and with an equilibrium water content of such a high order the determination of correct condition weight plays a more important part than with other fibres. The situation is complicated because the presence or absence of impurities and different finishing processes have a considerable influence upon the regain. The following have received general recognition, although, in some respects, British standards differ from those accepted internationally.

Table 5.2

	<i>British system percentage regain</i>	<i>International system percentage regain</i>
Wool waste	16	17
Tops in oil	19	19
Tops, dry combed	18.25	18.25
Noils, scoured and carbonized	16	17
Cloths (woollen and worsted)	16	17

Although it has never been recognized in commerce, oxidizing agents such as chlorine and hot pressing reduce the capacity of wool to absorb moisture. This is a factor which can contribute to losses in weight during finishing.

In spite of its capacity to absorb moisture in the form of vapour, it is extremely difficult to wet wool out in cold water. This is because the vapour can penetrate to the cortex where it is retained, but in the liquid phase water must pass through the epithelial scales which offer considerable resistance. In order to wet wool out the temperature of the water must be raised to 60°C (140°F) or, alternatively, a wetting agent must be used. The absorption of water vapour is accompanied by the liberation of considerable quantities of heat as illustrated by the following figures (ALEXANDER AND HUDSON, *Wool, its Chemistry and Physics*, 1st edn.), see Table 5.3.

Unlike cotton, which becomes stronger as the moisture content increases, wool becomes weaker.

Speakman and Cooper (*J. Text. Inst.*, 1936, **T** 183), and Speakman and Stott (*J. Text. Inst.*, 1936, **T** 186) have studied the giving up of water by wool in a dry atmosphere, or desorption, and the taking up of moisture from the atmosphere, referred to as absorption. They have shown that there is a hysteresis effect which means that the fibre will lose moisture more

Table 5.3

<i>Initial moisture content expressed as percentage of dry weight of wool</i>	<i>Heat of wetting expressed as calories per 100 g of dry weight</i>
0.0	2410
3.0	1880
6.4	1380
9.5	1010
13.1	630
15.0	470
17.8	330

rapidly in a drying atmosphere than it will take it up when conditions are favourable to absorption. This is not without significance in commerce because wool which has been dried in a hot chamber will take a long time to return to its correct condition weight.

Action of air on wool

The capacity of wool to withstand atmospheric exposure is sufficient for all practical purposes, but it must be recognized that there is a gradual deterioration. This form of degradation is known as weathering. If the goods are undyed, prolonged exposure produces a brown discoloration as well as some increase in the affinity for dyes. This can cause difficulty in the dyeing of wool which has been stored because portions to which air and light have had greater access will show up as a darker colour.

Action of acids on wool

Reference has already been made to the fact that prolonged boiling of wool with dilute acids ultimately hydrolyses the keratin to a mixture of α amino acids. As far as the requirements of dyeing and finishing are concerned, where boiling periods of about 2 hours with concentrations of acid (which rarely exceed 5 per cent of the weight of the material) are involved, the degree of hydrolysis is negligible. Nitric acid is more harmful because, even in quite dilute solutions, it produces a yellow discoloration. Wool which has already suffered partial degradation through excess of alkali in scouring or attack by micro-organisms during storage, is much less resistant to the action of acids. Organic acids have virtually no action on the fibre.

Action of alkalis on wool

Whilst wool has a good resistance to acids, the reverse is the case with alkalis. Strong alkalis such as sodium or potassium hydroxide attack and dissolve it very rapidly, especially at elevated temperatures. Ammonia, sodium carbonate, and other mild alkalis are less energetic in their action but cannot be described as entirely harmless. If wool is soaked in a cold (0° to 10°C) solution of sodium hydroxide of 82°Tw (37 per cent) for about 5 minutes and then rinsed immediately, it suffers no damage and acquires an increased affinity for dyes. Moreover, the wool does not shrink, as cotton would, and crimped effects in mixtures of the two fibres can be obtained by taking advantage of this fact. If wool is left in contact with alkali for any length of time it becomes seriously damaged. The epithelial scales are first loosened, giving access to the less resistant cortex which is rapidly broken down into soluble products, and in time the scales are also dissolved. The rate at which solution takes place depends upon the concentration of the alkali, disintegration being most rapid in a solution containing about 20 per cent of sodium hydroxide. As the temperature increases the degradation is accelerated and a 2 per cent sodium hydroxide solution will completely dissolve wool at the boil in about 5 minutes. The proteins are converted into sodium salts of simple amino acids. The sulphur forms sodium sulphide, the presence of which is indicated by the black precipitate of lead sulphide, formed with a solution of lead acetate. The presence of formaldehyde, glue, or spent sulphite liquors protect wool to a certain extent against alkali damage.

Mild alkalis have less effect, but again temperature and concentration are important factors. Sodium carbonate is used in wool scouring and small quantities of ammonia are sometimes added to a dyebath. Slight damage caused by an alkali in scouring can render the fibre less resistant to subsequent processes. Ammonia, ammonium carbonate, borax, sodium hexametaphosphate, tetrasodium pyrophosphate, and sodium triphosphate can be used at temperatures up to 60° to 70°C (140° to 158°F) with safety.

Isoelectric point

This is the state when all the acidic and basic groups in the keratin are electrostatically in equilibrium, as shown diagrammatically below :

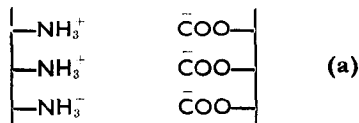

When excess of hydrogen ions are present they will be attracted by the electronegative carboxyl ions leaving a nett positive charge on the wool.

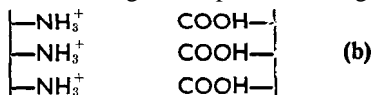

In a similar manner an excess of hydroxyl ions will result in a negative charge on the fibre by neutralizing the NH_3^+ groups.

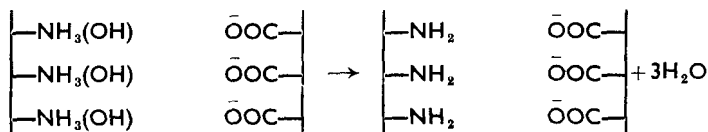

The isoelectric region of wool is between pH 4.8 and 7.

Carbonization of wool

The relative resistance of wool to acids is of importance in freeing it from burrs picked up by the sheep. If they are not removed they may cause mechanical trouble in spinning and local discoloration in the finished cloth. There are some vegetable impurities which do not absorb wool dyes and may cause light-coloured spots after dyeing. The burrs, which are composed of cellulose, are destroyed by treatment with acid and heat under conditions harmless to the wool, but which will convert the cellulose to hydrocellulose which can be pulverized and shaken out.

The first operation is acid impregnation, most commonly performed by steeping in a 5 to 7 per cent solution of sulphuric acid for a period of 2 to 3 hours. This is followed by hydro-extraction and drying at 85° to 90°C (185° to 194°F). The wool is then shaken mechanically when the hydro-cellulose falls away, after which the residual acid is either neutralized with dilute sodium carbonate or washed out with water. It is customary in these days to use continuous methods. The wool is scoured and then it passes through a lead-lined bowl where impregnation with sulphuric acid takes place. After squeezing, the wool next passes through a two-stage heating assembly. In the first stage it is dried at 50° to 60°C (122° to 140°F), and in the second it is heated for 15 to 20 minutes at 95° to 100°C (203° to 212°F). The material is next squeezed between fluted rollers to crush the

hydrocellulose, and is passed into a machine called a willey where the debris is shaken out. Finally the residual acid in the wool must be neutralized.

There are a number of other animal hairs which find limited commercial use for special purposes. They are all very similar to wool in structure except that the scales are not so clearly defined. They are all composed of keratin, but they often contain pigment which is extremely difficult to remove.

MOHAIR

Mohair comes from the Angora goat which is bred in Turkey, South Africa, and the United States. It produces cloths with outstanding resistance to wear, and is used for upholstery or, in combination with wool, for making clothing.

CASHMERE

The hair of a goat which is found in China, Northern India, Persia, and Tibet. The fleece consists of an outer coat of long coarse hair which is of little interest, but there is also an inner coat of fine soft hair which is used for the production of yarns. The fibres are of extremely small diameter and make fabrics of outstanding softness. Cashmere is only used for garments of the very highest quality.

RABBIT HAIR

Known commercially as Angora, this has been used for a long time and is highly prized for its softness. Angora is very commonly blended with wool for spinning.

SILK

Silk possesses nearly all the desirable properties of a textile fibre: strength, elasticity, softness, and affinity for dyes. It consists of the solidified viscous fluid excreted from special glands in the silkworm. It is only made on one occasion by the worm during its life-cycle for the purpose of protection whilst it is in the chrysalis state. Silk has been cultivated in China since about 2600 B.C., and it is probable that uncultivated silk had been collected and used long before this date. The Chinese endeavoured to retain the monopoly of silk cultivation and the export of eggs was a capital crime. There are many legends about how the breeding of silkworms was brought to other countries; there is the story about the Chinese princess married to Bokara, who brought the eggs with her in her headdress. In A.D. 555, Emperor Justinian persuaded two monks to visit China and bring back a supply of eggs, which they smuggled in a hollow bamboo cane. In Europe, the cultivation of silk took root in Italy, from whence it spread to southern France. It had also reached Japan through Korea in about A.D. 300. There are several varieties of worm which produce silk or silk-like threads, but

the commercially valuable fibre comes from the species *Bombyx*, and the common silkworm is *Bombyx mori*, which feeds on mulberry leaves. Some wild silk, usually called Tussur, is collected from worms such as *Antheraea mylitta* in India and *Antheraea pernyi* in China, both of which consume oak leaves.

Sericulture

This is the term applied to the cultivation of silkworms. The first essential for success is a good stock of mulberry trees. The eggs are hatched in incubating rooms which are maintained between 20° and 25°C (68° and 77°F). As the worms hatch they are transferred to frames where they are fed on chopped mulberry leaves. Plenty of fresh air and cleanliness are essential for the well-being of the worms because they are subject to many diseases, these being one of the great hazards of sericulture. Pasteur studied the causes of sickness in silkworms, and this particular work was a part of

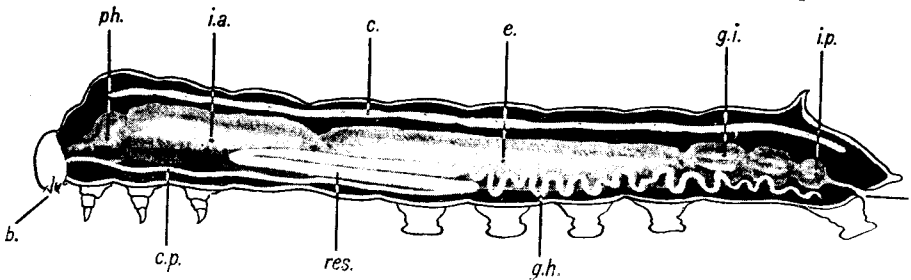

Fig. 5.22

a. = Anus o. = Mouth c. = Heart c.p. = Double glandular conduct e. = Stomach
g.h. = Secreting gland g.i. = Large intestine i.a. = Fore intestine i.p. = Rectum
ph. = Pharynx res. = Reservoir.

(Courtesy of 'Ciba Review')

his classical research which led him ultimately to recognize the existence of bacteria and their relationship with disease.

The silkworm, after hatching, eats continuously, and a thousand worms require about 85 lb of mulberry leaves to bring them to maturity. The grub grows rapidly and ultimately reaches a length of 3 to 4 in. and discards its skin four times between birth and maturity. After the fourth discard the worm stops eating. It is then placed on twigs, where it encloses itself in a cocoon of silk. At this stage great care must be taken to ensure that each worm spins its own cocoon and two or three do not get entwined with each other.

The silk is formed in two glands placed on either side of the body, the situation of one of which is shown in Fig. 5.22. When the worm is mature a considerable proportion of its body is occupied by these glands which become filled with a viscous liquid. From each gland a duct leads to a

common orifice called a spinneret, situated at the end of the lower lip. The arrangement of these organs is represented diagrammatically in

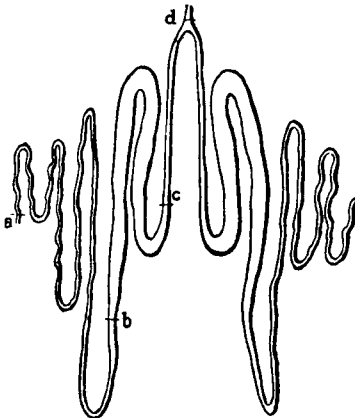
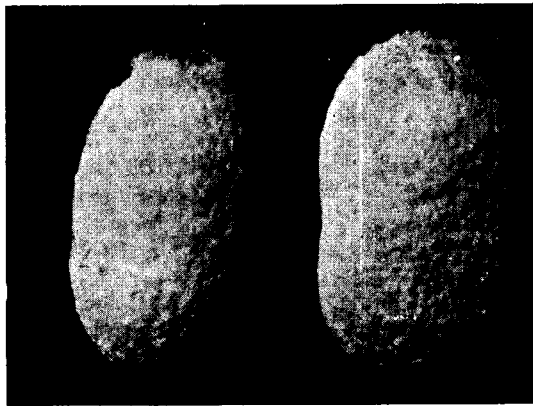

Fig. 5.23 Silk glands

Fig. 5.23. During formation of the cocoon, the worm ejects the viscous content of the glands in the form of a filament which solidifies on contact with the air.

The silkworm spins the whole of its cocoon without a stop and the silk therefore is a continuous thread. One cocoon may contain about three thousand yards of silk and about one thousand cocoons would be required to produce 4 oz of useful thread. The spinning of the cocoon takes 3 to 4 days and when it is complete the worm changes into a pupa which may be either male or female. The cocoons

producing males are somewhat smaller and more cylindrical in shape than those from which the females emerge (see Fig. 5.24). Although the two glands join at a common orifice they produce separate filaments known as



Male
cocoon

Female
cocoon

Fig. 5.24

(Courtesy of 'Ciba Review')

brins. These are surrounded and cemented together on emerging by silk gum to form a double thread which is called a bave, and which is shown in cross-section in Fig. 5.25. The filaments, which constitute 75 per cent of the bave, are composed of a protein to which the name fibroin is given

and the gum is described as sericin. The sericin and fibroin emerge from the same orifice and the explanation of how the differentiation takes place is not clear. Two glands, known as the glands of Filippi, connected with the main silk duct just before it emerges, are believed either to excrete the sericin or to play a part in its formation (see Fig. 5.26). There is uncertainty about what causes the filament to solidify. It cannot be caused by loss of water because solidification still takes place under water. It may be brought about by an enzyme, but no concrete evidence has been forthcoming. The fluid has been extracted and it has been found that it coagulates instantaneously if a trace of acid be added, and solidification is also accelerated by heating or mechanical strain. It is possible that the stress in the fluid which is set up as the fibre is ejected from the spinneret promotes the change to the solid state.

When the cocoons are ready for gathering, those which appear to be composed of the best silk are kept for breeding. The remainder are baked at a heat sufficient to kill the pupae. They are then sorted, usually into three grades, of which the best are used for organzine, the mediocre ones for

tram silk, and the lowest-grade or damaged ones for spun silk. After sorting, the cocoons are softened by soaking in warm water, when the free ends become detached and float. Several of these are assembled, passed through a guide and wound off. On cooling, the filaments stick together, forming a composite thread known as a grege. According to Loewe's patent, the unwinding of cocoons is rendered easier by previously soaking them in a dilute alkaline solution to which some soap has been added, this treatment being followed by washing in weakly acidified water. Silk obtained from a single cocoon varies in quality according to its position. The outside layer is coarse and is termed

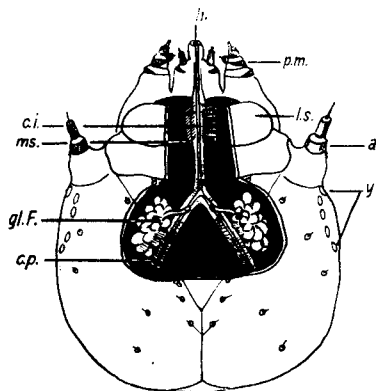

Fig. 5.26

a. = Antenna c.i. = United (or single) glandular conduct
 ms. = Muscles c.p. = Double glandular conduct
 gl.F. = Glands of Filippi
 h. = Spinneret l.s. = Upper lip
 p.m. = Mandible y. = Eyes

the floss and is collected separately, usually to be made into spun silk. The innermost layers are also poor, probably owing to increasing exhaustion of the silkworm. In the case of *Bombyx mori* the differences in quality are tabulated in Table 5.4.



Fig. 5.25 Cross-section of raw silk ($\times 1000$)

(MARSH, 'Introduction to textile bleaching')

Table 5.4

	<i>Near outside</i>	<i>Middle</i>	<i>Inside</i>
Diameter	1/790 in.	1/900 in.	1/700 in.
Elasticity	13.3	24.3	24.7
Breaking load	6.25 g	10.2 g	9.0 g

There are a number of terms which are peculiar to silk yarns and some explanation of their meanings is necessary.

Thrown silk or grege consists of two or more threads of raw silk reeled together and given a slight twist. Thrown silk is used for making organzine and tram.

Organzine, to which reference has already been made, is produced from the best cocoons. It contains two or more strands each composed of a number of greges twisted together lightly. These threads are then doubled and retwisted in the opposite direction to the original twist in the strands. Organzine is used for warp threads when high tensile strength is required.

Tram silk is usually made from cocoons of lower grade. Like organzine, it is composed of two or more strands of thrown silk lightly twisted together and then doubled. Only a light twist is subsequently given to the doubled yarn, yielding a bulkier product with less tensile strength. It is therefore eminently suitable for the weft component of woven fabrics.

Spun silk is made out of damaged cocoons and any other form of waste which is broken up and no longer in continuous filaments. It is carded like cotton and then spun. It is usually made out of waste from which the sericin has been removed, but when silk which is still in the gum is spun the yarn is known as chappe.

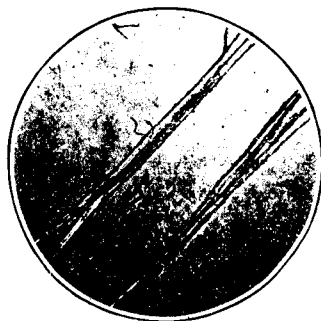

Fig. 5.27 Raw silk

When examined under the microscope, raw silk consists of what is apparently two cylindrical structureless threads. These two threads are generally stuck together by the sericin, but in places they will be found to be separated (see Fig. 5.27). A strand from a skein of raw silk which has been thrown will, of course, consist of a number of double threads. When degummed the individual silk fibres are seen as featureless and apparently homogeneous cylindrical structures (Fig. 5.28). Although the fibre has the appearance of being homogeneous it is, in fact, composed of a large num-

ber of exceedingly fine filaments or fibrils. When silk is treated with a solution of an alkali, or soap and water, and pounded in a mortar these fibrils

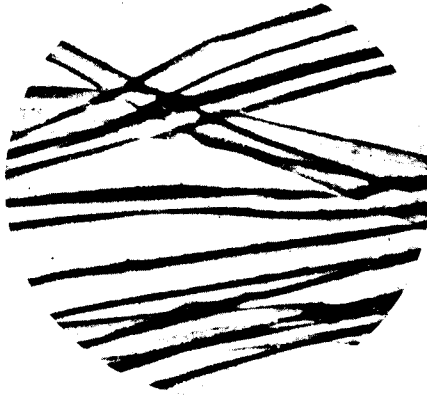

Fig. 5.28 Degummed silk fibres

(Courtesy of the Cotton, Silk and Man-made Fibres Research Association)



Fig. 5.29 Ruptured silk fibres

become detached and, with careful focusing, can be seen under the microscope (Fig. 5.29).

Composition of raw silk

Besides fibroin and sericin raw silk contains small quantities of mineral matter, traces of fat, colouring matter and water. The average composition is:

Silk gum or sericin	22-25 per cent
Silk or fibroin	62.5-67 per cent
Water	10-11 per cent
Salts, etc.	1-1.5 per cent.

Fibroin is composed of a number of α amino acids of which the most important are:

Glycine	38 per cent	$\text{CH}_2(\text{NH}_2).\text{COOH}$
Alanine	22 per cent	$\text{CH}_3.\text{CH}(\text{NH}_2).\text{COOH}$
Serine	15 per cent	$\text{HO}.\text{CH}_2.\text{CH}(\text{NH}_2).\text{COOH}$
Tyrosine	9 per cent	$\text{HO}-\text{C}_6\text{H}_4-\text{CH}_2.\text{CH}(\text{NH}_2).\text{COOH}$
Other amino acids with bulky substituents	16 per cent	

The X-ray diffraction diagram gives a repeat period of 6.95 Å (0.695 nm), which is extremely close to two amino-acid residues fully extended which would be 3.5 Å (0.35 nm) each. The structural unit which gives the pattern is probably the glycine alanine residue.

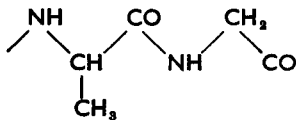

Polypeptides of low complexity, the constitution of which can be ascertained, have been obtained from fibroin by the controlled action of enzymes. Such evidence leads to the conclusion that the orientated regions consist of amino acid residues arranged in the following order.

Gly.Ala.Gly.Ala.Gly.(Ser.Gly.(Ala.Gly.)₈)Ser.Gly.Ala.Gly.Tyr.

where

Gly. = Glycine
Ala. = Alanine
Ser. = Serine
Tyr. = Tyrosine

The terminal residue coincides with the commencement of the amorphous regions, in which the condensed amino acids with bulky side chains are situated.

Sericin on hydrolysis yields essentially the same amino acids as fibroin but their relative proportions differ.

	<i>Glycine</i>	<i>Alanine</i>	<i>Tyrosine</i>	<i>Serine</i>
Fibroin per cent	30-36	18-20	7.8-10	14.7
Sericin per cent	3.5-5.8	3.7-9.2	3.18-5.7	30.1

Unfortunately sericin contains no crystalline regions so no useful information can be gained from X-ray diffraction diagrams.

Sericin can be distinguished from fibroin by staining with picocarmine. According to Denham and Dickenson (*J.S.D.C.*, 1936, 52, 94), a 0.1 per cent solution of this dye gives a deep red colour with sericin and pale yellow with fibroin. If the same test is carried out in a 0.1 per cent solution of sul-

phuric acid the colours are dark brown and yellow respectively. This test can be useful in measuring the effectiveness of a degumming process.

Heat has a destructive action on silk. A temperature of 140°C for a short time will not cause decomposition, but prolonged exposure will give rise to discoloration and loss of tensile strength. The degradation which occurs is accompanied by loss of nitrogen in the form of ammonia. Prolonged exposure to sunlight causes reduction in tensile strength, and the action is accelerated by the presence of traces of iron or copper. Mineral acids, particularly hydrochloric acid, cause an increase in the rate at which light acts upon the silk.

Detection of damage in silk

Alkalis or micro-organisms can cause the individual fibrils to become detached at the surface and project in little tufts. These can be recognized by microscopic examination. The tufts appear as a lighter shade after dyeing because they reflect the light differently, but once they have made their appearance nothing can eliminate them. Silk which is affected in this way is said to be 'lousy'. A test for lousiness which is recommended by the Cotton, Silk and Man-made Fibres Research Association is to treat the silk with a nitrous acid solution to which a small amount of copper has been added. The liquor is brought to the boil and maintained at this temperature for ten minutes, by which time lousiness will be revealed by differential staining. The measurement of the fluidity of a colloidal solution of silk in zinc chloride to determine the degree of degradation was first suggested by S. R. Trotman and Bell (*J.S.C.I.*, 1935). In a further publication by Garrett and Hewitt (*J. Text. Inst.*, 1941, T 1) an improved method is recommended. The silk is dissolved in a cupri-ethylenediamine solution which is prepared by shaking together for two hours 70 g of copper hydroxide and one litre of 8 per cent ethylenediamine which has been adjusted to pH 4.5 by the addition of acid. The undissolved cupric hydroxide is separated by filtering through asbestos mixed with kieselguhr. The copper in the filtrate is determined by titration with thiosulphate of the iodine liberated from potassium iodide, and the necessary adjustment is made to bring it to the equivalent of 5.95 to 6.05 per cent of cupric hydroxide. This solution can be kept for some months in a dark bottle in a cool place.

A specimen of silk which has been conditioned at 65 per cent R.H. at 20°C

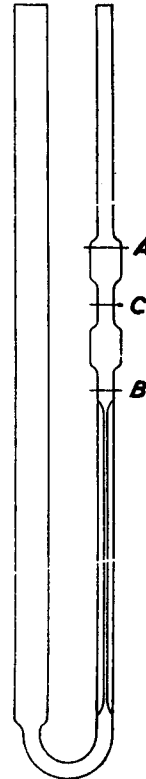

Fig. 5.30 B.C.I.R.A. silk fluidity viscometer

(68°F) weighing 193 mg is placed in a sample tube with 1.75 ml of the solvent and stirred for three minutes, after which 1.75 cc of 1.25 N acetic acid are added, over a period of one minute, with continued stirring. This serves the purpose of arresting any tendency that there may be for the ethylene diamine reagent itself to degrade the fibroin. The liquor is then centrifuged in a glass tube at 1000 r.p.m. for 5 minutes, and 3 ml of the clarified supernatant liquor are drawn off in a pipette and transferred to the specially designed viscometer shown in Fig. 5.30. The test is carried out by sucking the solution through the capillary tube till it reaches the mark *A*. The viscometer is immersed in a bath thermostatically controlled at $20^{\circ}\text{C} \pm 1^{\circ}\text{C}$ ($68^{\circ}\text{F} \pm 1.8^{\circ}\text{F}$). The solution is then allowed to flow back, and the time which is required for it to fall from *C* to *B* is recorded. The fluidity is arrived at by dividing the time expressed in seconds by the constant for the viscometer *c'*. Silk which has been degummed carefully should have a fluidity of between 6 and 8.

Action of acids

Silk is readily soluble in cold concentrated mineral acids. The solubility in cold concentrated hydrochloric acid may be made use of to determine the percentage of silk present when it is in a mixture with wool. When only traces of mineral acids are dried into silk, tenderness results and the material may gradually disintegrate into powder. Boiling with dilute acids causes some degradation and weak acids such as acetic acid should therefore be used in dyeing. Nitric acid, even in very dilute solutions, causes a yellow discoloration. When organic acids such as acetic or tartaric acid are dried into the silk they give it a peculiar handle called a 'scoop', which is sometimes produced deliberately to enhance the appeal of the material.

Action of alkalis

Cold concentrated solutions of caustic alkalis appear to have little effect when contact is short in duration and when rinsing follows immediately. Thus mixed cotton and silk fabrics may be mercerized when the contraction of the cotton gives a crimped effect. Prolonged action of cold concentrated sodium hydroxide causes the fibroin to become dissolved with ultimate breakdown into sodium salts of α amino acids. At the boil quite mildly alkaline solutions will dissolve fibroin rapidly. Lousy silk is formed more readily in the presence of alkali, but some mechanical rough handling is necessary at the same time.

Action of salts

Concentrated solutions of some salts such as zinc chloride will dissolve silk. Many others, such as sodium chloride for example, have no effect when in solution but can produce tendering during prolonged storage when

dried into the fibre. Sodium chloride has in the past, on many occasions, been the cause of serious claims for damage. It has been suggested that hydrolysis takes place in the first instance:

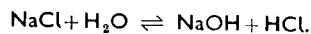

The hydrochloric acid is then oxidized to chlorine, which reacts with the silk protein. Salts of organic acids do not cause tendering on storage.

Weighting of silk

Silk is rarely used in commerce without removal of the gum which causes a loss in weight of 22 to 25 per cent. On account of its costliness there has been a strong incentive to replace this loss by causing the fibre to absorb and retain suitable organic or inorganic substances. The procedure is known as weighting. When the loss due to the removal of gum has been exactly replaced the silk is described as having been weighted to par. If, however, excess is added back the final product is above par and, as an example, 1 lb of raw silk in the gum could be degummed and then loaded until it weighed 2 lb, when it would be 100 per cent above par. More detailed information about the weighting of silk will be given in Chapter 16. Basically, the process depends upon the absorption of soluble substances from their aqueous solutions and subsequently rendering them insoluble by precipitation within the fibre by causing them to enter into chemical combination with a second soluble reagent.

Wild silks

Silks derived from moths other than *Bombyx mori*, which do not feed on mulberry leaves, are classified as Wild silks. There are many wild silks in existence but only a few have found limited commercial use. In Japan a species known as *Antheraea yama-mai* feeds on oak leaves and produces a thread which, in the past, found some uses. In India, *Antheraea mylitta* also finds nourishment from oak leaves, and *Attacus ricini* thrives on the foliage of the castor-oil plant.

The best-known wild silk is tussur, produced by *Antheraea pernyi* which thrives on a diet of oak leaves and is found in China. The worm is about $5\frac{1}{2}$ in. long when mature and makes a compact cocoon which has a brownish colour. Spinning tends to be intermittent so that the filament is more broken than that of *Bombyx mori*, and for this reason it is more suitable for spun yarns.

Tussur is coarser than cultivated silk; an outer sheath of gum is present, but this cannot be distinguished under the microscope. The brown discoloration, which seems to depend, to some extent, upon the source of food, is not confined to the gum but is distributed throughout the whole of the fibre. The cross-section is irregular, and longitudinal striations can be distinguished together with periodic constrictions.

Chemically tussur is essentially the same as silk from other sources, but it is more resistant to the action of acids, alkalis, and solvent salts, as illustrated by the following comparisons (Table 5.5).

Table 5.5

<i>Treatment</i>	<i>True silk</i>	<i>Tussur silk</i>
Boiling 1 per cent sodium hydroxide	Dissolves rapidly	Takes 30 to 50 minutes to dissolve
Cold concentrated hydrochloric acid (sp gr 1.16)	Dissolves rapidly	Dissolves very slowly
Zinc chloride solution (sp gr 1.67)	Dissolves rapidly	Dissolves slowly
Millon's reagent	Red colour	Brown colour

(To prepare Millon's reagent, dissolve mercury in an equal weight of nitric acid (1.4 sp gr) and dilute the solution to twice its volume with cold water.)

6 · Regenerated man-made fibres

THE formation of a silk thread by extrusion of an easily-coagulated fluid through a spinneret appeared to be something which might be imitated without much difficulty. The suggestion that fibres like silk could be made artificially was probably proposed, in the first place, by Hooke, who was the secretary of the Royal Society in the reign of Charles II. No practical results were obtained, however, until cellulose nitrate had been discovered and its properties became known. In 1883 Swann prepared continuous threads of cellulose nitrate by dissolving the substance in a mixture of alcohol and ether, and forcing the solution through fine orifices into a warm atmosphere where the solvent rapidly evaporated. Cellulose nitrate itself was too inflammable to be of any use, so the thread was denitrated by treatment with ammonium sulphide. This was only a pilot experiment, but in 1884 Chardonnet manufactured nitrocellulose yarn commercially and he is usually looked upon as the founder of the rayon industry.

In the early stages the starting point in the manufacture of rayons was always cellulose in one form or another. The fibres were not truly synthetic nor were they entirely man-made because cellulose had never been prepared except from natural sources. It is for this reason that these fibres, and others made from complex molecules which cannot be synthesized, are classified as regenerated man-made fibres.

Nitrocellulose or Chardonnet rayon

When cellulose is treated with a mixture of nitric and sulphuric acids, nitrates of cellulose are formed, the composition of which depends upon the conditions of the reaction. Thus with two molecules of nitric acid for each cellobiose unit a dinitrate is obtained in accordance with the following equation:

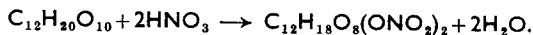

More highly nitrated celluloses are powerful explosives and are the main component of gun-cotton.

In the production of Chardonnet rayon, purified cotton or linters are treated with a mixture of nitric and sulphuric acids at a temperature not exceeding 40°C for a period of between 4 and 6 hours. The excess of acid is then run off and the nitrated cotton is washed with water until free from acid. It is subsequently hydro-extracted and pressed until it contains about 30 per cent of water. This nitrocellulose is dissolved in a mixture composed of equal volumes of alcohol and ether in a closed vessel provided with a stirring mechanism. The solution is filtered under pressure and then stored.

During storage the viscosity increases and it is important that it should always be the same before spinning if the properties of the yarn are to be constant. The changes which occur during storage are referred to as ripening or ageing, and the process is allowed to continue until the tests, which are made periodically, indicate that the specified viscosity has been achieved. It is almost impossible to avoid slight differences occurring from batch to batch, and an important factor in spinning a uniform yarn is the randomization of these variations by always mixing together several batches for a spinning charge.

The aged solution is forced by a pump through a spinning jet or spinneret. This consists of a cap made of a chemically inert metal, such as tantalum or platinum or platinum-rhodium alloy, which contains a number of small holes usually between 0.05 and 0.1 mm in diameter (see Fig. 6.1). The spinning mixture is extruded through these holes into a medium which causes it to solidify or coagulate.

In the early stages Chardonnet (*E.P.*, 1885, 6045) forced the solution

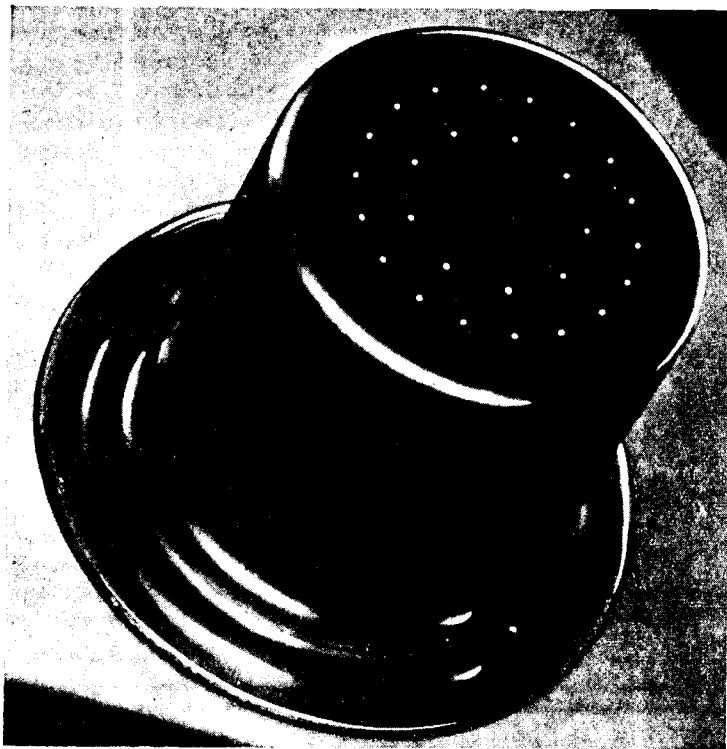

Fig. 6.1 Spinneret
(Courtesy of Courtaulds)

through fine glass jets of from two to ten thousandths of an inch in diameter into water. This extracted the alcohol and ether mixture, giving a semi-solid thread. A number of these were wound together on a spool. The mechanism is illustrated diagrammatically in Fig. 6.2. The spinning solution enters at *A*, is forced through the glass tube, coagulated in the bath containing water and wound on to a bobbin at *D*. The whole machine was enclosed and warm air was passed through to volatilize solvent retained in the semi-solid fibre and thus to complete the hardening.

Dry spinning was introduced subse-

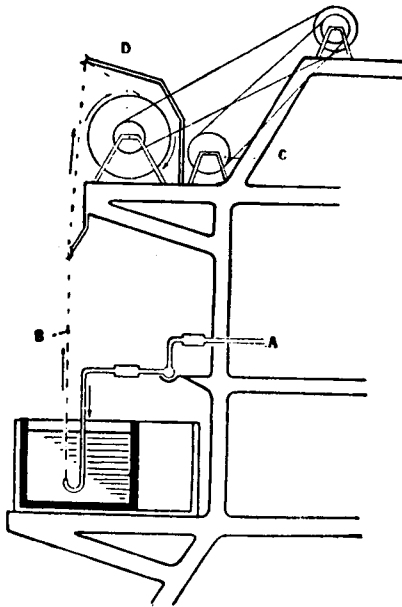

Fig. 6.2 Diagram of wet spinning process for Chardonnet rayon

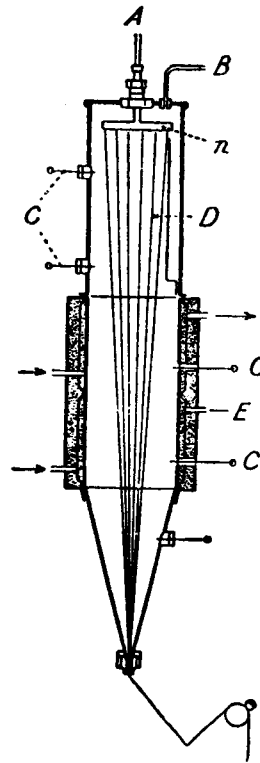

Fig. 6.3 Dry-spinning apparatus

- A* Entry of spinning solution
- B* Outlet for current of air
- C* Thermometers
- D* Filaments of rayon
- E* Hot water jacket

quently. The principle is illustrated diagrammatically in Fig. 6.3. The spinning mixture is pumped through a spinneret *n* into a chamber through which a current of hot air is circulated to evaporate the solvent, leaving a solidified thread of cellulose nitrate. The solvent is easily recovered by passing the hot air which emerges from the chamber through a condenser.

Cellulose nitrate is unsuitable for use as a textile fibre because it is dangerously inflammable. The yarn is therefore converted into cellulose by

treatment with ammonium hydrosulphide which reduces the nitro to hydroxyl groups. Finally, the colour is improved by bleaching with sodium hypochlorite or bleaching powder.

It is a long time since the manufacture of nitro-cellulose rayon came to an end because other methods proved to be economically more viable. The process is historically interesting because it was the first demonstration of the practical possibility of producing man-made fibres on a commercial scale.

Cuprammonium rayon

The manufacture of cuprammonium rayon is based upon Schweitzer's discovery that cellulose is dissolved by a solution of copper hydroxide in ammonia. Attempts to utilize this discovery for the preparation of fibres were made by Depaissis, but Pauly, in 1897, was the first to work the process on a commercial scale. His venture did not survive and it was left in abeyance until Bemberg took it up again in 1919 and succeeded because he introduced the method of stretch spinning, based on earlier work by Thiele.

Cuprammonium rayon is made from scoured and bleached cotton linters or purified wood pulp with a high α cellulose content. The cellulose is washed and then pressed until it contains about 50 per cent of water. In this state, it is placed in a mechanical mixer together with cuprammonium solution and agitated until completely dissolved, whilst the temperature is maintained at 5° C (41°F). The solution is then diluted to about 10 per cent concentration. After filtration and exposure to vacuum to remove air bubbles and dissolved gases, the solution is allowed to ripen in enclosed vessels until it is the desired viscosity. In modern practice copper carbonate is mixed intimately with the cellulose in a shredding machine and the resultant mass is then broken up and stirred for some hours with aqueous ammonia and caustic soda, when it passes into solution.

Spinning

The spinning mixture is extruded through holes varying from 0.25 to 0.75 mm in diameter. These are larger than for other rayons because they allow for the considerable amount of contraction which takes place during coagulation. The method of stretch spinning which is usually applied is illustrated diagrammatically in Fig. 6.4. The cuprammonium solution of cellulose is first precipitated in water so that solidification is sufficiently gradual to allow elongation to take place. The threads, when they come from the spinneret, pass into a glass funnel in which water is flowing in a downward direction at a velocity greater than that at which the yarn is emerging, so that the tension necessary to bring about stretching is applied at this point. The thread then passes through a vessel containing 5 per cent sulphuric acid which completes the coagulation and removes some of the

copper. Finally the yarn is wound either into hanks or on to bobbins or collected in the form of cakes in centrifugal spinning pots (see Fig. 6.9). It may be necessary to treat it again with sulphuric acid to remove any remaining traces of copper, and finally all the acid must be rinsed out.

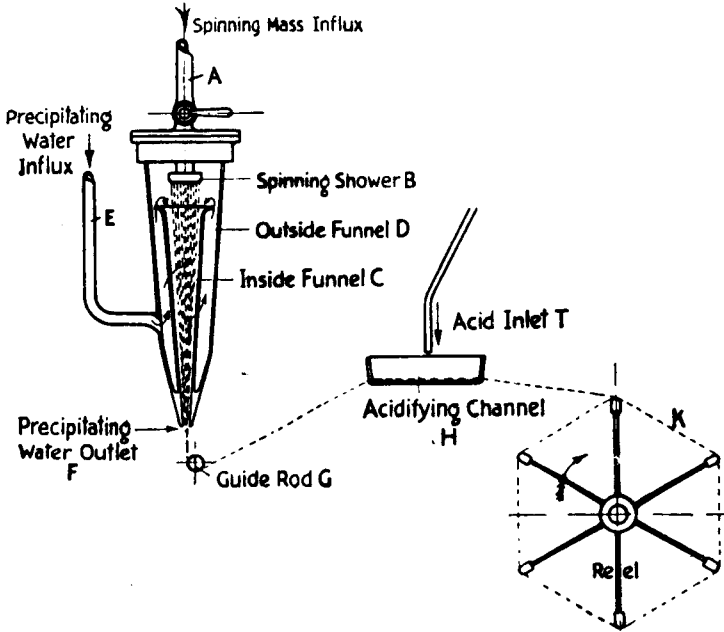

Fig. 6.4 Diagram of stretch spinning process



Fig. 6.5 Cuprammonium rayon fibre

(Courtesy of Hosiery and Allied Trades Research Association)

Cuprammonium rayon is not unlike natural silk when examined under the microscope. The fibres are cylindrical with smooth surfaces and in cross-section are generally a very close approximation to circular in outline (see Figs. 6.5 and 6.6). Cuprammonium products have a particularly pleasing

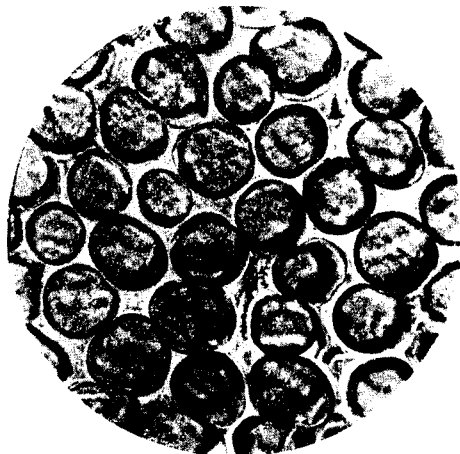
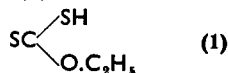

Fig. 6.6 Cross-section of cuprammonium rayon fibres
(Courtesy of Hosiery and Allied Trades Research Association)

soft silk-like handle, because the fibres are finer than other rayons. It is a regenerated cellulose so it has all the properties of cotton except that the average chain length is shorter and a larger proportion of the fibre is occupied by amorphous regions. For these reasons the rayon swells to a greater degree and its macromolecules are more accessible to chemicals in aqueous solution, so that it undergoes degradation with greater ease than natural cellulose.

Viscose rayon

Viscose was discovered by Cross and Bevan in 1892 during a programme of research on the general properties of cellulose. It is the sodium salt of cellulose xanthic acid. The acid, which does not exist in the free state, is ethyl hydrogen dithiocarbonate (1)



Cellulose xanthic acid therefore has the structure (2) and the sodium salt is represented by (3)

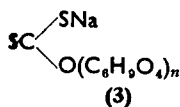
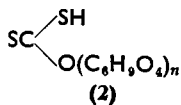

In the manufacture of rayon the sodium salt of cellulose xanthic acid is obtained by the action of carbon disulphide on alkali cellulose

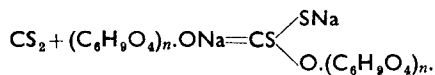

This substance forms a viscous solution in which the long-chain structure of the cellulose molecules is retained. Dilute mineral acids decompose it with the regeneration of cellulose, accompanied by the formation of carbon disulphide and sodium sulphate.



Viscose rayon may be manufactured from cotton linters but the usual starting point is wood pulp preferably derived from spruce. The crude wood chips are purified by treatment first with calcium bisulphite and then by boiling with steam under pressure for about 14 hours. This does not

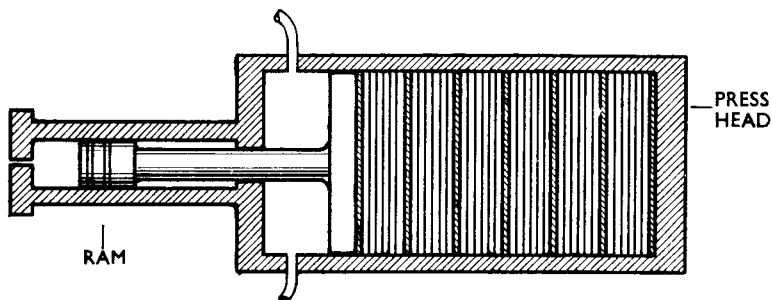

Fig. 6.7 Steeping press

affect the cellulose but renders the lignin and other impurities soluble. The residue is in the form of a pulp which may be bleached with sodium hypochlorite, after which the excess of water is squeezed out, leaving solid sheets containing 90 to 94 per cent of pure cellulose.

The alkali cellulose is obtained by treating the sheets of purified wood pulp with cold caustic soda solution of 17.5 per cent concentration. For this purpose a combined steeping vessel and press (Fig. 6.7) is generally used, so that the excess of caustic soda can be removed without handling the sheets. In the steeping part of the operation no pressure is applied by the ram, and the cellulose is allowed to remain in contact with the caustic soda solution for about 2 hours. The α cellulose is converted into alkali cellulose and the hemicelluloses are dissolved. The vessel is then drained and pressure is applied by the ram which squeezes out the excess of alkali liquor.

The sheets of alkali cellulose, in the state in which they emerge from the press, are broken up into 'crumbs' in a shredding machine consisting of a drum inside which blades with serrated edges rotate. The crumbs are removed and aged by storing in galvanized containers for 2 or 3 days, the

temperature being maintained at 22°C. During this stage some depolymerization takes place which ensures that the final viscose solution shall not have a viscosity too high for it to pass through the orifices of the spinneret. There have been recent developments, based mainly upon careful temperature control, leading to a great reduction in the time required for ageing so that this stage can be combined with shredding.

The matured crumbs are converted to xanthate by treatment with carbon disulphide. A weighed quantity of crumbs is placed in the churn (Fig. 6.8)

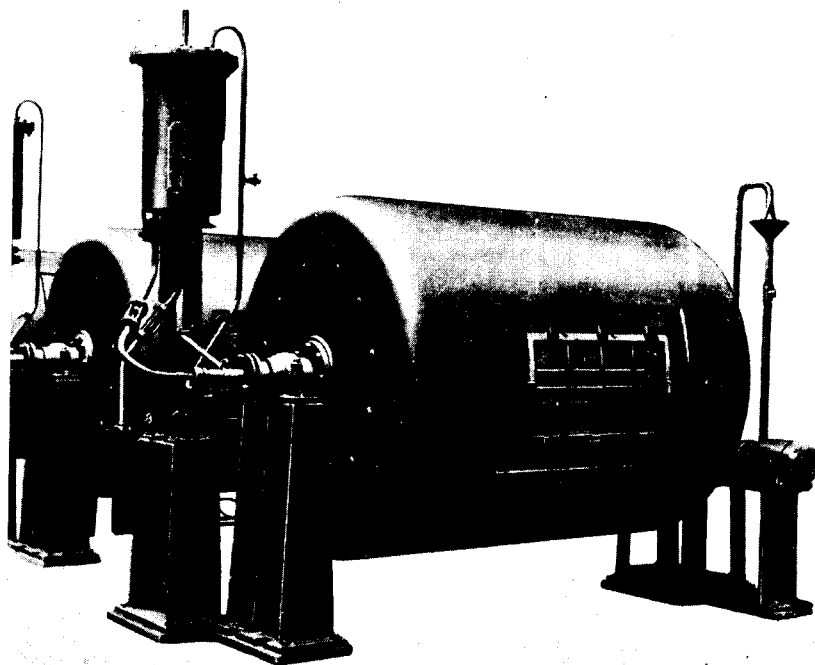

Fig. 6.8 Xanthating churns

(Courtesy of Dobson and Barlow)

and about 10 per cent of its weight of carbon disulphide is allowed to trickle in slowly from the container at the side whilst the churn rotates at about one revolution per minute. Mixing is continued for about 3 hours. The churns are water-jacketed to prevent the temperature from becoming too high. The white alkali cellulose crumbs change to a yellow colour. When the reaction is complete the excess of carbon disulphide is drawn off by evacuation. The remaining cellulose sodium xanthate is dissolved by stirring with caustic soda solution which is added until the composition is 6.5 per cent sodium hydroxide and 7.5 per cent cellulose. The preparation of this solution can

be carried out in the churn. The solution is filtered and then several batches are mixed and stored so that the right viscosity can be arrived at by a process of ripening.

The spinning is carried out by pumping the viscose through spinnerets into a solution of sulphuric acid. A variety of coagulating solutions are used. One example contains the following:

- Sulphuric acid (7 to 10 per cent)
- Sodium sulphate (15 to 22 per cent)
- Zinc sulphate (1 to 5 per cent).

Glucose or other sugars and magnesium sulphate may be added.

The greatest factor which contributed to the commercial success of the viscose process was the invention by Topham of the centrifugal collecting pot in 1902. The principle of this method is shown in Fig. 6.9. The filament (1) passes over a roller (2), then through a glass funnel (3) into a cylindrical box (4) which rotates at about 7000 revolutions per minute. The box is driven by a motor (7) and is mounted on a spindle (6). As the thread issues from the bottom of the funnel it is built up into a 'cake' on the sides of the pot by centrifugal force. The glass funnel is given an up-and-down motion by means of a camshaft (5) which distributes the thread in a spiral formation inside the box, thereby making subsequent winding easier. The thread (1) consists of several filaments, the number corresponding with the orifices in the spinneret. In passing from (2) to the final position in the pot a twist of about 2 to 2.5 turns per inch is imparted. This makes subsequent handling much easier because it gives greater strength and coherence to the thread. Spinning in the centrifugal pot reduces handling and gives a package which can be manipulated with ease in subsequent processes. Fig. 6.10 presents a simplified diagram of the method.

When the package is taken from the spinning pot a considerable amount of further purification is necessary before the yarn is commercially acceptable. The cakes are therefore mounted on the perforated spindles of a cake-washing machine on which they pass successively through a series of liquors in which purification is brought about (Fig. 6.11). In the first place they are washed with water to remove any occluded liquor or products from the coagulating bath. During precipitation traces of free sulphur and other complex sulphur-containing compounds are formed. These are removed by immersion in a solution containing sodium sulphide which, after rinsing, often leaves the yarn slightly discoloured. The colour is improved by

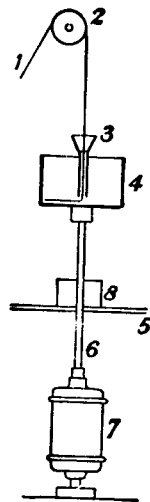

Fig. 6.9 Diagram of centrifugal spinning pot

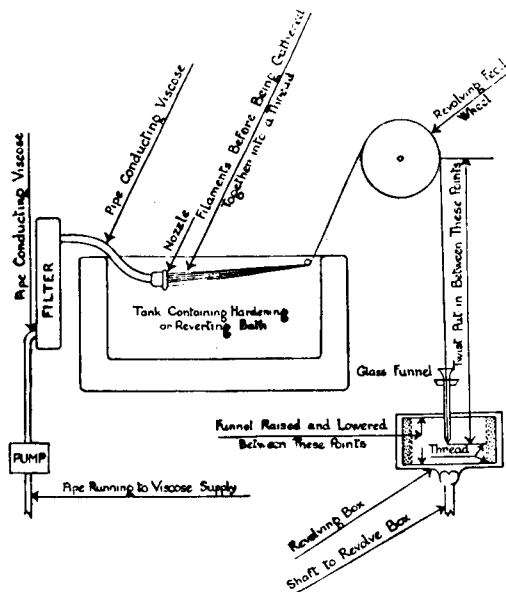

Fig. 6.10 Diagram of machine for centrifugal spinning

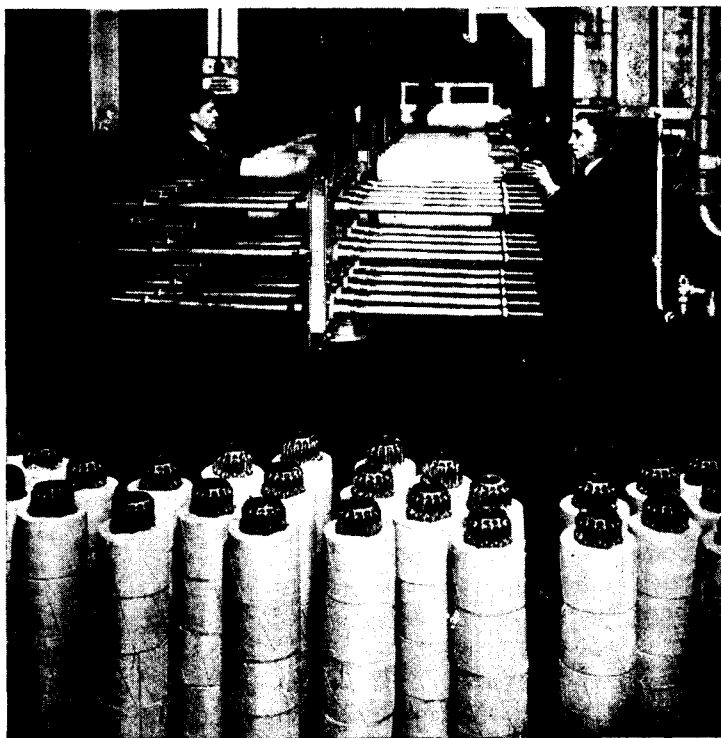

Fig. 6.11 Removal of sulphur from viscose eakes, and washing off
(Courtesy of Courtaulds)

bleaching with sodium hypochlorite, followed by treatment with dilute hydrochloric acid to destroy residual bleach liquor, and final rinsing. The need to bleach depends to a great extent upon the quality of the wood pulp and, with better selection of the raw material, it is less essential now to bleach viscose cakes.

Desulphurization was carried out because the sulphur detracted from the lustre of the yarn. Lustre is no longer looked upon as desirable. It was also thought that unremoved sulphur would oxidize gradually to sulphuric acid and cause tendering, but this has now been disproved. Neither desulphurization nor bleaching, therefore, is essential, and this has made it possible to spin, coagulate, rinse, dry, and wind onto cone or other package in one continuous operation. These considerations have been taken into account in the development of what is called the Nelson process. The semi-coagulated yarn is collected on two rollers which incline slightly towards each

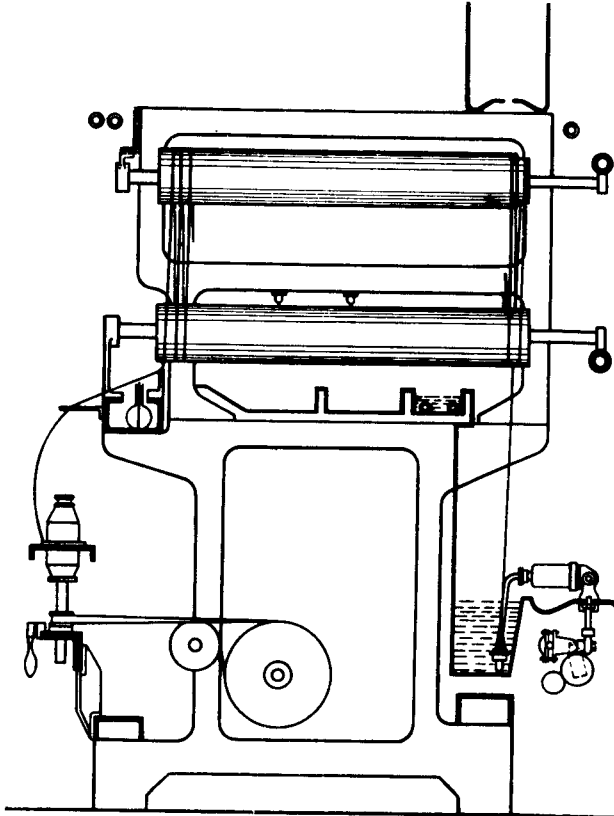

Fig. 6.12 Nelson continuous spinning machine

(Courtesy of Dobson and Barlow Ltd.)

other. This inclination carried the yarn forward through a zone where the coagulation is allowed to become complete, a second region where rinsing with water removes the residual coagulating liquor, and finally a drying phase before it is wound onto a package. Stretch can be applied to the yarn and the machine is represented diagrammatically in Fig. 6.12. In dyeing and finishing there is a slight difference between continuously-spun rayon and the older discontinuous method. When the cake is washed and purified relaxation can take place, but in the Nelson process the yarn is under tension the whole time. It is therefore liable to contract slightly during scouring or dyeing and an allowance for a shrinkage of 4 per cent should be made.

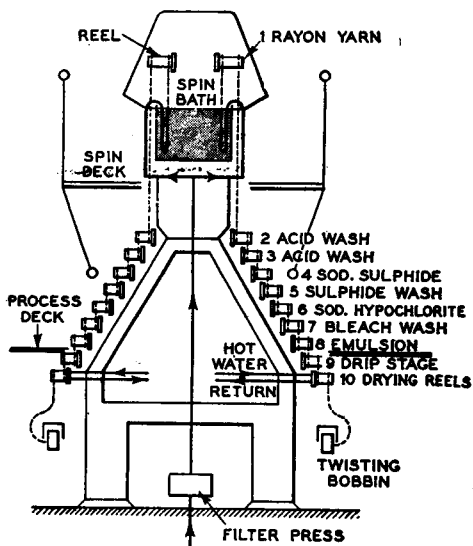

Fig. 6.13 Continuous spinning plant
(Courtesy of Courtaulds)

An alternative continuous spinning process is that of the Industrial Rayon Corporation of America. After coagulation the yarn is carried forward through rinsing, desulphurization, bleaching, and drying on advancing creels placed in rows above one another (see Fig. 6.13). When chemicals in solution are applied they are delivered through glass tubes from a stock tank over the creels and collected in trays underneath. This method finds its greatest application in the manufacture of viscose yarns for tyre cords.

A thread of viscose produced by the methods described above is very lustrous and this is looked upon as an undesirable property. Matt yarns are therefore made by adding approximately 2 per cent by weight of titanium dioxide to the viscose solution before spinning. Mass coloured yarns are finding increasing application. An insoluble finely divided pigment is in-

incorporated in the spinning mixture, thereby yielding a pre-coloured yarn. A few of the dyes or pigments which are used are:

Helidon Pink R
Indanthrene Blue RS
Fast Red G base
Dianisidine Blue
Indigo
Phthalocyanine Blue
Phthalocyanine Green
Carbon Black.

The method has many advantages over conventional dyeing, such as uniformity of shade, greater wet-fastness, and economy, because cost of handling in yarn or piece dyeing is saved. Conventional dyeing is nevertheless still preferred for very many purposes because it offers a greater range of colours and provides better versatility in execution of orders, since stock is uncommitted for shade until much later.

In viscose rayon, spun by the methods already described, the cellulose molecules are not very highly orientated and the proportion of the amorphous regions is large. The result is that the yarn has a low tenacity of only 2 g per denier when dry, and a very poor wet strength of 0.9 to 1 g per denier. In 1926 Lilienfeld observed that if the coagulating bath was composed of sulphuric acid of about 65 per cent concentration, the filaments were precipitated in a plasticized state and could be stretched before they solidified, giving a yarn with a greatly improved tensile strength. At that time it was not realized that stretching was increasing the degree of orientation by causing more of the long-chain cellulose molecules to lie side by side.

Yarn produced by the Lilienfeld process lacked sufficient elasticity to make it attractive for textile purposes but it has been used to make a particularly strong staple fibre under the name of Durafil. This fibre has a dry tenacity of 3.7 to 4.1 g per den, compared with 2.54 for conventional viscose staple and a wet tenacity of 2.73 to 3.1 compared with 1.53.

The great demand for strong regenerated cellulosic fibres in the manufacture of motor car tyres created an outlet where high elasticity was not of such importance as in the manufacture of textile materials. Very great quantities of highly orientated viscose yarns are now manufactured for this end use.

A significant advance was achieved by the development of the Tenasco process. This consisted of extruding the viscose into an acidified coagulating liquor containing zinc and sodium sulphates followed by the application of stretch to the freshly formed fibre in hot aqueous acid. Such yarns have greatly increased tensile strength at the expense of only a small reduction in extensior. at break. The most highly orientated regenerated

cellulose product is Fortisan. In its manufacture the starting point is a cellulose acetate yarn which, when plasticized with steam, can be stretched without breaking to a much greater extent than one composed of cellulose.

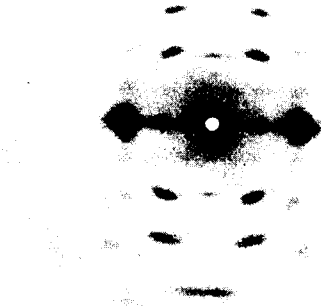

Fig. 6.14(a) X-ray diagram of Fortisan
(Courtesy of H. J. Woods)

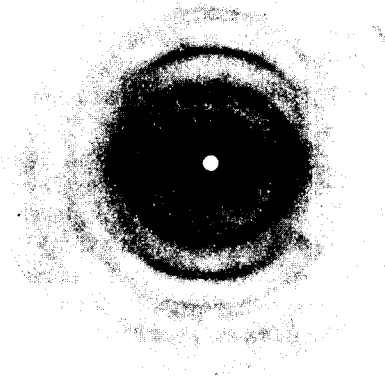

Fig. 6.14(b) X-ray diagram of viscose
(Courtesy of H. J. Woods)

The acetyl groups, however, must be removed by hydrolysis with sodium hydroxide solution because they are comparatively bulky side chains which would keep apart the orientated cellulosic molecules and prevent hydrogen bonding and Van der Waals forces from giving coherence to the structure. Fortisan has a dry strength of 8 g per denier, falling to 6.4 g when wet.

The extension is only 8 per cent, with the result that the yarn has no textile application because materials would crease so badly. It has been used for tyre cords and other industrial purposes where strength is of paramount importance.

Skin effect

The skin of an extruded fibre is more highly orientated than the core. The friction between the orifice and the emerging viscous polymer probably has a drawing effect and tends to align the molecules parallel to the longitudinal axis of the fibre. The skin tends to retard the entry of water and penetration of dye molecules. The proportion of skin to core, therefore, has a significant bearing on the strength and dyeing properties of the fibre.

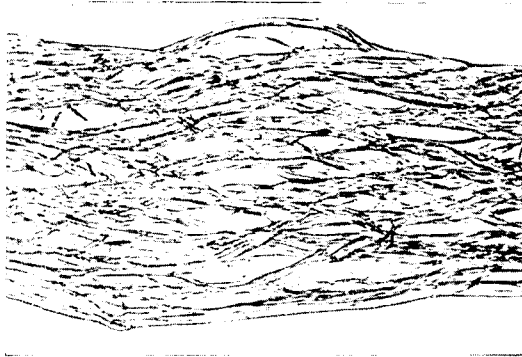

Fig. 6.15 Polynosic fibre after compression following swelling in nitric acid
(Ford, *T.I. and L.*, 1966, 135)



Fig. 6.16(a) Viscose fibres

(Courtesy of Hosiery and Allied Trades Research Association)

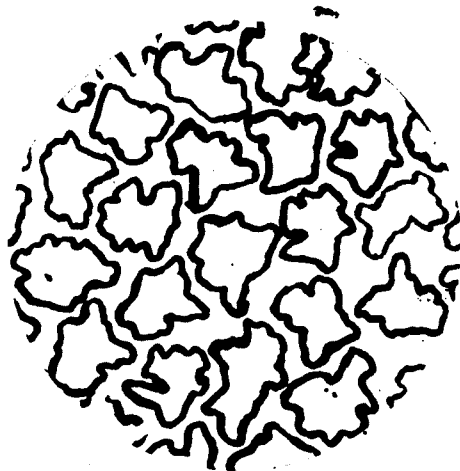

Fig. 6.16(b) Cross-sections of viscose fibres

(Courtesy of Hosiery and Allied Trades Research Association)

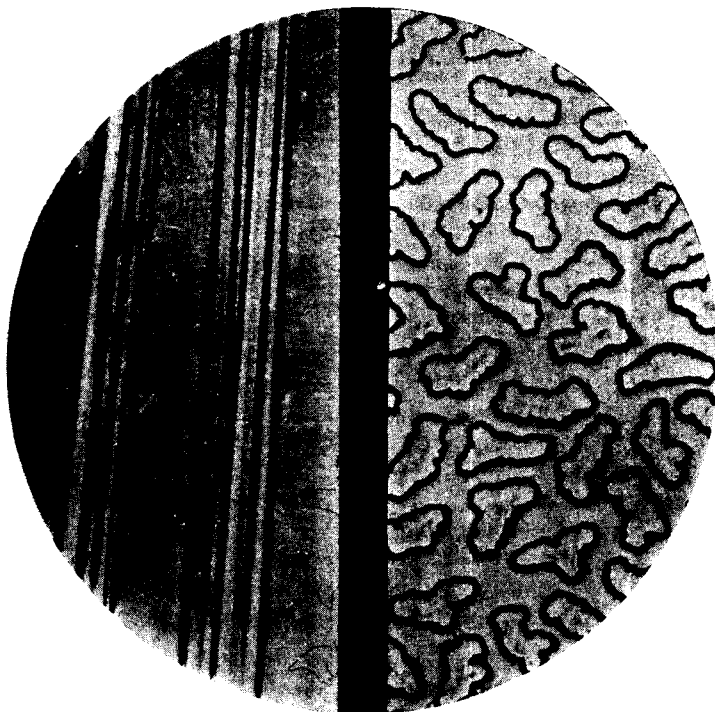

Fig. 6.17 Tenasco fibres and cross-sections

(Courtesy of Courtaulds)

Polynosic fibres

Originally the name polynosic was applied to fibres extruded by methods based on the Tachikawa patent taken out in Japan. The essentials consisted of using an unaged alkali cellulose in the preparation of the xanthate which in turn was dissolved in only water giving a viscose with a low content of sodium hydroxide. The unripened viscose was then extruded into a very dilute solution of sulphuric acid containing no salt. The term

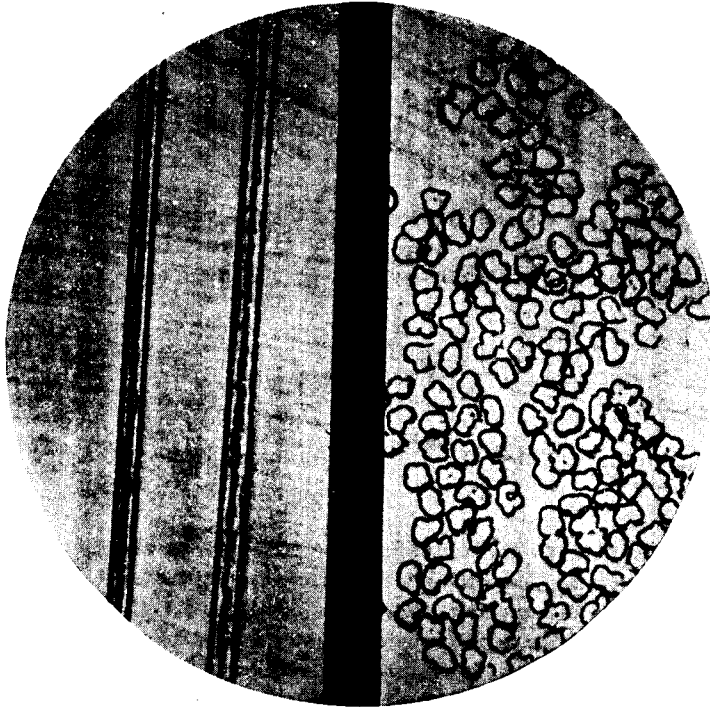

Fig. 6.18 Fortisan fibres and cross-sections
(Courtesy of Courtaulds and National Trade Press)

polynosic has now been extended to cover fibres made by other methods and according to the Textile Institute 'Terms and Definitions' they are 'regenerated cellulosic fibres that are characterized by a high initial wet modulus of elasticity and a relatively low degree of swelling in sodium hydroxide solutions'.

The early methods of spinning viscose continuous filament were based upon rapid coagulation and regeneration after extrusion. This procedure is reversed in the preparation of polynosic fibres because the coagulating liquor only decomposes the xanthate slowly so that considerable stretching

can be applied before regeneration is complete. This gives a more highly crystalline and orientated molecular arrangement.

Polynosic fibres have a fibrillar structure to which many of their properties are attributed. This feature is illustrated in Fig. 6.15 which shows a fibre magnified 400 times after compression following swelling in nitric acid.

Viscose rayon spun by normal methods has a characteristic microscopic appearance (Fig. 6.16a). In the cross-section (Fig. 6.16b) it will be seen that the surface is deeply serrated, which gives rise to clearly-defined longitudinal striations.

Tenasco has a similar appearance, but the serrations are not so well marked (Fig. 6.17). The cross-sections of Fortisan are somewhat less regular, but the fibre itself has the appearance of a smooth cylinder (Fig. 6.18).

Cellulose acetate rayons

Schutzenburger was the first to record the acetylation of cellulose. In 1869 he prepared cellulose triacetate by the substitution of the three hydroxyl groups in the glucose residue with acetyl radicals.

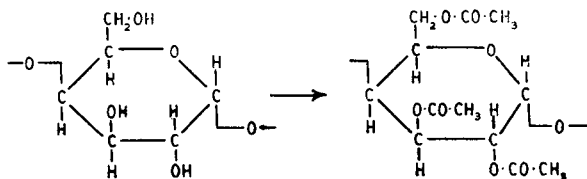

In 1894 Cross and Bevan described a commercially practical way of making the triacetate which consisted essentially of treating cellulose with acetic anhydride in the presence of sulphuric acid. In the early stages cellulose triacetate did not meet with much success in the production of fibres. It was only soluble in chloroform and carbon tetrachloride, which were expensive and dangerous solvents to employ. In 1905 Miles showed that if water was added to the solution of triacetate in acetic anhydride obtained after acetylation, partial hydrolysis took place and a product soluble in acetone could be isolated, to which the name secondary cellulose acetate was given. The 1914-18 war created a great demand for a solution of secondary cellulose acetate dissolved in acetone known as 'dope', which was used as a protective coat for the fabric wings of aeroplanes. At the end of the war the experience gained in the manufacture of acetate and the reduction in cost of acetone, acetic anhydride, and other chemicals achieved by large-scale production, made the manufacture of yarns possible.

In the preparation of secondary cellulose acetate rayon cotton linters, waste cotton or high-grade wood pulp is purified by boiling with alkali followed by hypochlorite bleaching. After purification the cellulose is dried

and mixed with acetic anhydride and glacial acetic acid together with about 1 per cent of sulphuric acid. The reaction is allowed to proceed for about 8 hours, when the whole of the cellulose will have been converted into cellulose triacetate with three acetyl groups per glucose residue. Partial hydrolysis is brought about by adding water to bring the acetic acid concentration to 95 per cent. After standing for about 20 hours, sufficient hydrolysis will have taken place to form secondary acetate with a ratio of 2.4 acetyl groups per glucose residue. The mass is then poured into a large excess of water and the acetate is precipitated, after which it is thoroughly washed and dried at a low temperature.

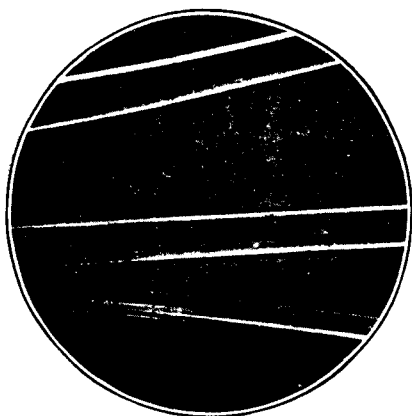

Fig. 6.19(a) Cellulose acetate fibres

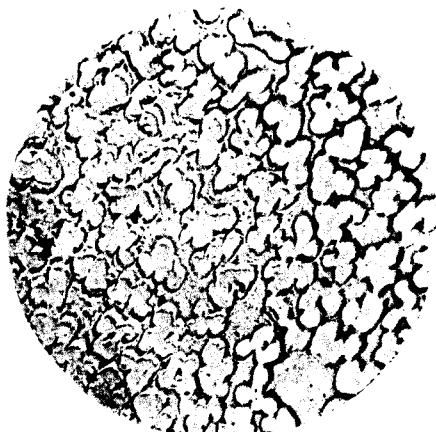

Fig. 6.19(b) Cross-sections of cellulose acetate fibres

The spinning solution is prepared by mixing a well-randomized assortment of different batches of secondary acetate with three times its weight of acetone. After stirring for about 24 hours solution will be complete and the product will be stored for the necessary time for ageing to take place. Titanium dioxide or the appropriate pigment is added if the yarn is to be dull or mass dyed. Before spinning, filtration and exposure to vacuum to remove air bubbles are necessary.

The viscous solution is forced through spinnerets into an enclosed chamber through which a stream of hot air passes in the direction opposite to that in which the yarn is moving. The acetone is evaporated, leaving a solid thread which emerges from the bottom to be wound onto a bobbin (see Fig. 6.4). The solvent is recovered from the hot air when it leaves the chamber and is available to be used again.

Secondary cellulose acetate yarns have a dry strength of 1.4 g per denier which falls to 0.9 when wet. Although the initial dry breaking-load is less than for viscose, the comparative loss on wetting is not so great because of the more hydrophobic nature of the yarn. The substitution of most of the

hydroxyl by acetyl groups in the glucose residues destroys the affinity for most of the dyes used for cellulosic fibres. The dyeing of acetate presented one of the greatest difficulties in marketing this yarn in its early days. The problem was solved by dyeing with finely divided insoluble azo or other coloured compounds retained in suspension with sulphoricinoleic acid from which the name S.R.A. colours was derived.

When examined under the microscope acetate fibres show no longitudinal striations. The cross-sections are irregular but more in the shape of lobes and the indentations are not so deep as in viscose (Fig. 6.19a and b).

Alginate yarns

Alginic acid is obtained in large quantities from seaweed. Abundant crops of seaweed are available in many parts of the world, and for some time strenuous efforts have been made to find commercial uses for them. Out of this programme of applied research the idea of making yarns from alginic acid arose. When seaweed is treated with sodium carbonate solution it disintegrates in about 24 hours, leaving a black gelatinous mass which, after filtration and purification, will give a precipitate of alginic acid on acidification.

Alginic acid resembles cellulose in composition except that the primary alcohol groups (CH_2OH) are substituted by carboxyl radicals (COOH). This

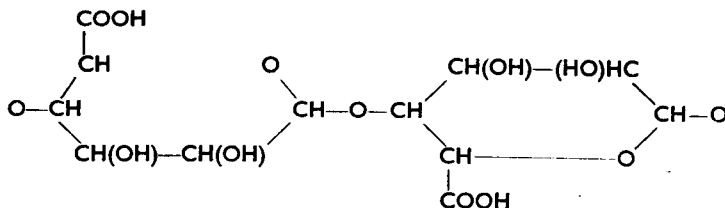

striking similarity in chemical structure naturally led to the conclusion that the substance was potentially fibre-forming. Alginic acid was first isolated by Stanford in 1860 and he placed it on the market as a thickening agent. The production of fibres resulted from the research of Speakman and others who described how to make yarns of chromium alginate. These had a green colour which could not be removed and were no use for textile purposes, but they found considerable outlet for making camouflage netting during the 1939-45 war.

Yarns made of calcium alginate are now being manufactured for certain special purposes. The purified alginic acid is dissolved in sodium carbonate solution, converting it to sodium alginate. The solution is aged until it has reached the right viscosity and then, after filtration, forced through spinnerets into a coagulating bath containing calcium chloride solution. The water-soluble sodium salt of alginic acid is precipitated as a continuous filament of insoluble calcium alginate.

In the presence of quite dilute sodium carbonate solutions the calcium salt is converted into the soluble sodium alginate. Because of this and its general lack of resistance to wearing conditions, alginate has not been used for making clothing. It has found application as a frame or a carrier in making extremely fine materials. A wool or cotton yarn of very high count is doubled or wound parallel with an alginate thread which gives support during weaving. The alginate is then dissolved in a mild alkali, leaving a fabric with a much finer texture than could be obtained otherwise. Alginate yarns also find extensive application in the hosiery trade. Socks are made in continuous lengths and have to be cut apart with scissors by hand. Unless the workers are very skilled they are liable to damage the goods. It is now common practice to introduce three or four rows of stitches of alginate between each sock, and these can be cut by an unskilled operator without risk of causing damage. The ragged edge which is left is then dissolved away in the first operation in the scouring and dyeing processes. Patterns of cotton have been embroidered on alginate cloths which, when subsequently dissolved, leave a lace-like structure.

The conversion of otherwise useless cellulosic materials into textile fibres was one of the great achievements of applied chemistry during the early part of the present century. Many attempts have been made to make regenerated protein fibres which, it was hoped, might have some of the properties of wool or silk. Experiments have been made with innumerable proteins, but only a few such as milk casein, ground-nut protein, and zein, the protein in wheat grain, have reached the stage of commercial production. Even these have not survived, mainly because it has not been possible to regenerate a protein in such a condition that it will have really satisfactory durability in wear.

Fibres such as Lanital and Fibrolane have been made from milk casein. The starting point is skimmed milk from which the casein is precipitated on acidification. After separation and purification, a solution of the casein in sodium hydroxide is prepared which is allowed to ripen until ready for spinning. The coagulating bath consists of a dilute acid to which formaldehyde is added to build methylene cross-links between adjacent molecules to reduce swelling and give better wet strength. The dry strength of Lanital is 1.2 g per denier and 0.9 to 1.1 for Fibrolane, but these fall as low as 0.6 to 0.3 when wet. Casein fibres have an affinity for most dyes but have a marked tendency to swell in hot water and the material thickens unless great care is taken. Casein fibres were usually mixed with wool in preference to being used alone.

Ardil, which was manufactured in considerable quantities, is no longer in production. It was made from proteins extracted from ground-nuts which grow prolifically in Africa. The nuts were ground into a meal and the fat was extracted with organic solvents. The meal was then suspended in water to which sufficient caustic soda had been added to bring the pH to

between 8 and 8.5. The proteins were extracted and, after filtration, precipitated from the filtrate by passing in sulphur dioxide till the pH was 4.5. In the early stages the ground-nut protein was dissolved in a concentrated solution of urea and coagulated with sodium sulphate and Glauber's salt. The urea, however, was expensive and after a time a solution of sodium hydroxide was used as the solvent. Fibres have been made from proteins extracted from the soya bean and used for making upholstery for motor cars, and Vicara is made from zein.

Tricel

Reference has already been made to the fact that the normal product of acetylation of cellulose is the triacetate which does not dissolve in acetone. Early attempts to spin were abandoned partly because of the difficulty in finding an economically satisfactory and safe solvent. Methylene dichloride has since become available on a commercial scale and has reopened the possibility of making triacetate fibres.

The synthetic fibres have a great advantage over the regenerated cellulose products because they are thermoplastic and can have permanent pleats or shapes imposed by heat setting. This property is shared by triacetate.

Tricel, which is the name of a triacetate yarn, is made by dry-spinning a solution in a mixture of alcohol and methylene dichloride. It has a regain of 4.5 which falls to between 2.5 and 3.0 after heat treatment. The tenacity when dry is 1.2 to 1.4 g per denier and 0.7 to 0.8 when wet. Its setting property and its hydrophobic nature, promoting quick drying, make it particularly suitable for 'easy-care' articles of clothing.

7 · Synthetic fibres

THE synthetic fibres differ from those classified as regenerated because the giant molecules of which they are composed are synthesized from quite simple monomers. The raw materials are not naturally occurring and are very often derived from by-products of the destructive distillation of coal or the cracking of petroleum.

In 1927 the Du Pont Company in the United States took a very far-reaching decision. They came to the conclusion that to ensure the continuing prosperity of their company they would have to commit themselves heavily to a programme of fundamental research. W. H. Carothers was persuaded to leave Harvard University and become the leader of a team of chemists working on fundamental projects of his own selection. He chose to study the properties and formation methods of macromolecules. One of his important contributions was that he established the conditions under which condensation polymerization could be expected to yield straight-chain giant molecules. When the monomers were such that condensation within the molecule would lead to the formation of cyclic compounds with five- or six-member rings, this reaction would predominate. Thus γ -hydroxy butyric acid could give a straight-chain polymer:

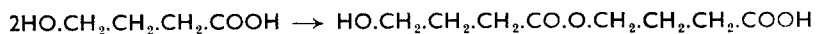

but, in fact, the following reaction is preferred:

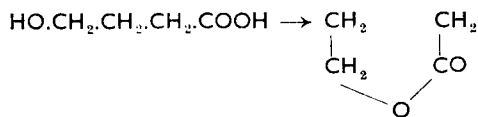

When condensation would result in rings containing seven or more members the yield is almost entirely composed of the linear polymer. The starting point for a satisfactory fibre-forming substance therefore must be one in which the condensing end groups are separated by at least five carbon atoms.

When this theory had received recognition, an intense search for appropriate monomers was set in motion. At that time the most suitable known reaction was condensation between adipic acid, $(\text{COOH}\cdot(\text{CH}_2)_4\cdot\text{COOH})$, and hexamethylene diamine, $(\text{NH}_2\cdot(\text{CH}_2)_6\cdot\text{NH}_2)$, to form what was known as a superpolyamide; subsequently placed on the market as nylon 66. The significance of 66 is that the monomers each have six carbon atoms. Nylon is a general name for all superpolyamide fibres and 66 serves as a distinc-

tion from others such as nylon 610, derived from hexamethylene diamine and sebacic acid, $(\text{COOH} \cdot (\text{CH}_2)_8 \cdot \text{COOH})$.

There was much to be done before the discovery made in the laboratory by Carothers could be operated on a commercial scale. Neither hexamethylene diamine nor adipic acid had, at that time, been manufactured in quantity, and it was necessary to find a large-scale process which would be reasonably economical. Phenol was chosen as the starting point. It is reduced to cyclohexanol by passing its vapour, mixed with hydrogen, over a catalyst:

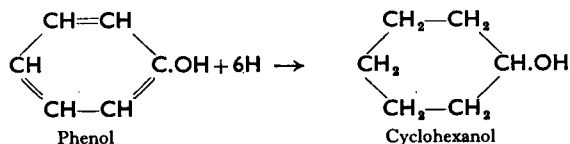

Cyclohexanol can be oxidized with nitric acid to adipic acid:

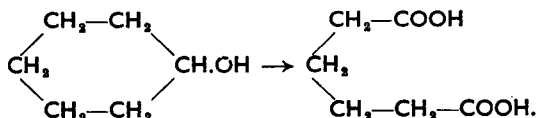

Adipic acid can also be obtained from cyclohexane extracted from petroleum, or manufactured by catalytic reduction of benzene. The cyclohexane is oxidized with air in the presence of copper or cobalt, which act as catalysts, to give a mixture of cyclohexanol and cyclohexanone, both of

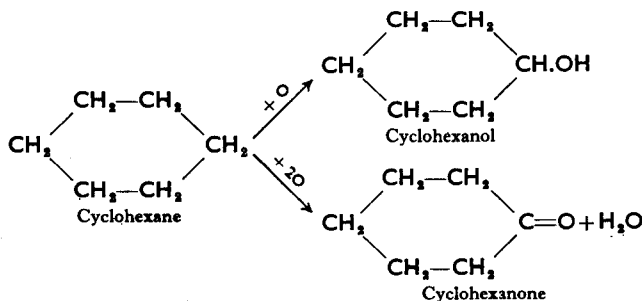

which can be further oxidized to adipic acid by the action of nitric acid in the presence of vanadium and copper.

A portion of the adipic acid is converted into hexamethylene diamine. A mixture of adipic acid and ammonia is passed over silica gel or boron phosphate at a temperature in the range of 350° to 400°C . During the course of the reaction diammonium adipate is formed which is converted to adipamide and this, in turn, loses water yielding adiponitrile:

In the nylon 66 superpolyamide molecule there are equal numbers of adipic acid and hexamethylene diamine molecules. To ensure that the components are balanced the first stage in polymerization consists of preparing hexamethylene diammonium adipate, which is commonly called nylon 66 salt.

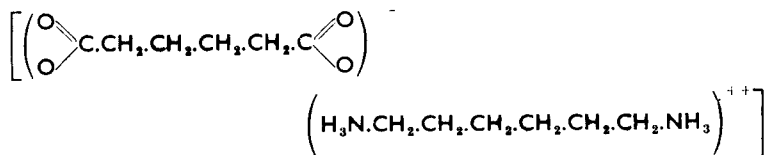

Solutions of adipic acid and hexamethylene diamine in methanol are run concurrently into a mixing vessel. The formation of the salt is accompanied by the generation of heat and the temperature must not be allowed to rise too high during mixing. The 66 salt has very low solubility in methanol and separates out as pure crystals which are centrifuged and dried.

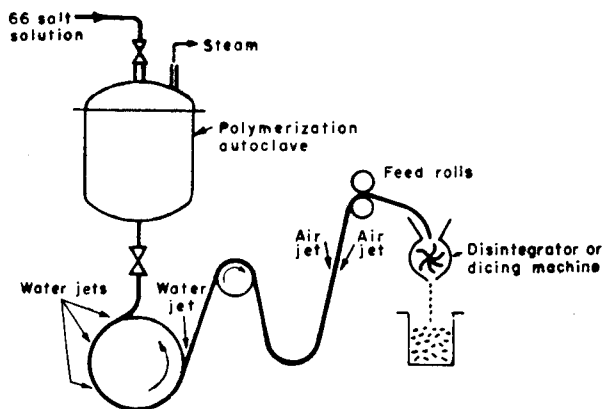

Fig. 7.1 Diagram illustrating manufacture of nylon 66 polymer
(Courtesy of 'Man-made Textile Encyclopaedia')

The polymerization is a comparatively simple process. A 60 per cent solution of the 66 salt in water is pumped into an autoclave. A small amount of acetic acid is added to block some of the amino end groups and thus control the degree of polymerization. The air is then driven out of the autoclave with a stream of steam, because traces of oxygen would cause oxidation and discoloration of the final product. The temperature of the content of the vessel is then raised to 215°C (419°F) at a pressure of 250 lb per sq in. Steam is continuously fed into the heating system for a further 2 to 3 hours, the pressure being maintained at 250 lb per sq in. by allowing the necessary amount of steam to escape from the autoclave. The pressure is then slowly reduced to one atmosphere over a period of between

1 and 2 hours, the temperature of the mixture being allowed to reach 270° to 280°C (518° to 536°F) so that the polymer, which melts at 264°C (507°F), does not solidify. The molten nylon 66 settles at the bottom of the vessel and is forced out through a slit orifice by pressurizing the autoclave with nitrogen. A tape of hot semi-solid polymer emerges which is completely solidified by spraying cold water on it as it passes over a rotating drum (Fig. 7.1). The product is then transferred to a disintegrator

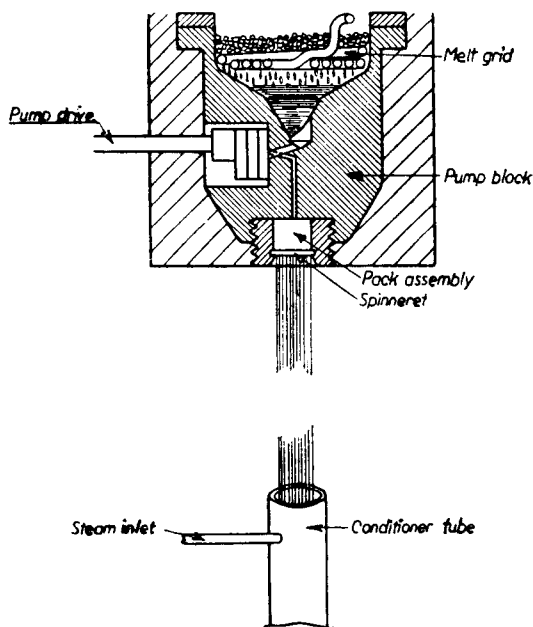

Fig. 7.2 Method of melt-spinning polyamides
(Courtesy of Elsevier)

where it is cut up into chips which are packed in airtight sealed drums and stored until required for spinning.

Nylon yarns are melt-spun, which means that the molten polymer is forced through the orifices in the spinneret and allowed to solidify by cooling. The system is illustrated in Fig. 7.2. Nylon chips fall from a hopper onto the heated melting grid which fuses them, the liquid falls into the sump below, from which the pump forces it through the spinneret. The hopper and melting chamber are filled with nitrogen to exclude oxygen, which would cause discoloration.

The filaments then descend through a cooling chamber which is enclosed so that they shall be protected against draughts. The newly solidified nylon is virtually free from moisture and there is a tendency for it to elongate slightly as it establishes equilibrium with the atmospheric humidity. If this

phenomenon occurs after winding it will lead to the formation of a loose and unsatisfactory package and, for this reason, the yarn passes through a conditioning chamber before it is wound.

A very important factor in the manufacture of nylon, as well as most of the other synthetic fibres, is drawing. Freshly-spun yarn, in which the molecules are unorientated, can be stretched to four times its original length with corresponding decrease in its diameter. The elongation is accompanied by progressive increase in orientation. In Fig. 7.3 a microscopic view of a

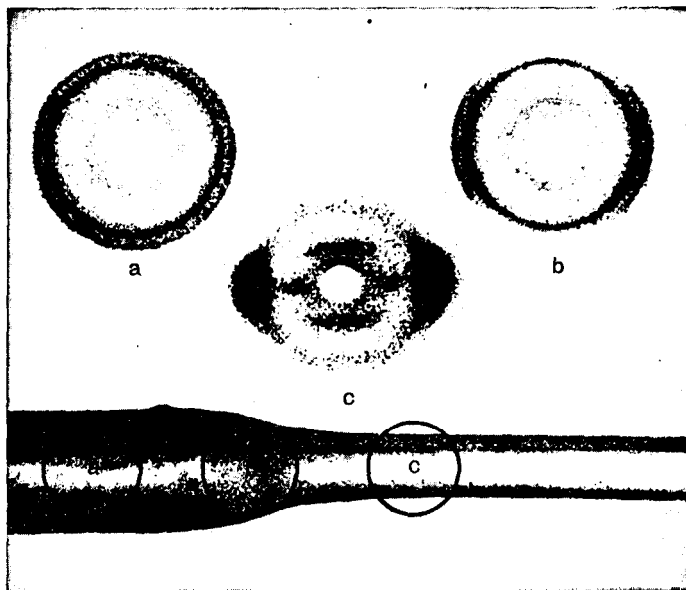

Fig. 7.3 X-ray diagrams of nylon at different stages of drawing
(Courtesy of 'Ciba Review')

filament of nylon is shown which is 'undrawn at the point marked *a*, partially drawn at *b*, and fully drawn at *c*. The X-ray diffraction diagrams at *a*, *b*, and *c* are illustrated (*Q*, *b*, and *c*) and they demonstrate clearly the relationship between drawing and orientation. The mechanical system for drawing is illustrated diagrammatically in Fig. 7.4. The yarn is supplied at a **fixed** speed by the feed roller and drawn off at a greater speed by the draw roller, the acceleration between these two points determining the amount of stretching. The point from which the tension is applied is **fixed** by the **draw** pin round which the yarn is wrapped. A number of wraps round the draw roll are necessary to prevent slippage and the separator roll is mounted on an axis slightly inclined to that of the draw roll, in order to keep the threads apart.

In the oriented fibres it has been shown that carbonyl oxygen atoms are

always opposite the NH groups in adjacent molecules. This is an arrangement which would favour the formation of hydrogen bonds (Fig. 7.5). In addition, the distance between the nitrogen and oxygen atoms is 2.8 Å

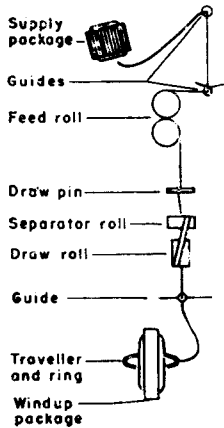

Fig. 7.4 General arrangement for drawing
(Courtesy of 'Man-made Textile Encyclopaedia')

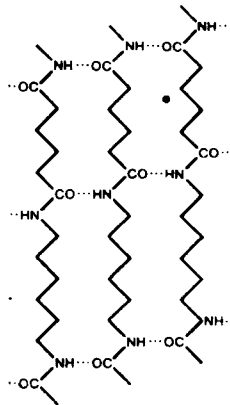

Fig. 7.5 Hydrogen bond formation in nylon 66
(Courtesy of 'Ciba Review')

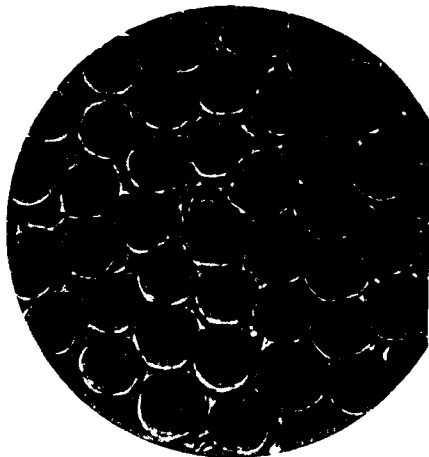

Fig. 7.6 Nylon 66 fibre and cross-sections
(Courtesy of Hosiery and Allied Trades Research Association)

(0.28 nm), indicating an attraction greater than Van der Waals forces; a spacing, in fact, equivalent to that in crystals where hydrogen bonds of this nature are known to exist.

Nylon 66 fibres have a circular cross-section and smooth rod-like surface when viewed under the microscope. In Fig. 7.6 the dark spots are caused

by titanium dioxide which has been added as a delustrant. The normal yarn has a dry breaking load of 4.5 g per denier and only loses 10 to 20 per cent of its strength when wet. The extension at breaking point is 22 to 25 per cent with a very powerful force of recovery. This property can cause some difficulties, such as the relaxation of tension during winding which can give excessively hard packages and even crush the former.

Nylon 66 is available in three forms. Nylon 100 is prepared by the methods already described and has normal affinity for acid and pre-metallized dyes. Nylon 110 is also known as 'deep dye' nylon because the introduction of additional basic groups confers an enhanced affinity for the anionic dyes, at the same time reducing what little affinity there was for cationic dyes. It has been suggested that the result is achieved by the incorporation of phenylphosphinic acid or similar compounds or, alternatively, by the addition to the polymer of N-2-aminoethyl piperazine. Nylon 120 has a good affinity for cationic dyes but none for those which are anionic, the effect being produced by the addition to the coagulating bath of compounds such as *o*-carbethoxycarboxybenzene which condenses with the amino groups (Report on Applied Chemistry S.C.I., 1966, 604).

Nylon 6, commonly known as Perlon, in which the repeating units always contain six carbon atoms, is obtained by the polymerization of caprolactam. The first stage, as with the manufacture of nylon 66, is the reduction of phenol to cyclohexanol, which is converted into cyclohexanone by oxidation. The latter reacts with hydroxylamine to form an oxime.

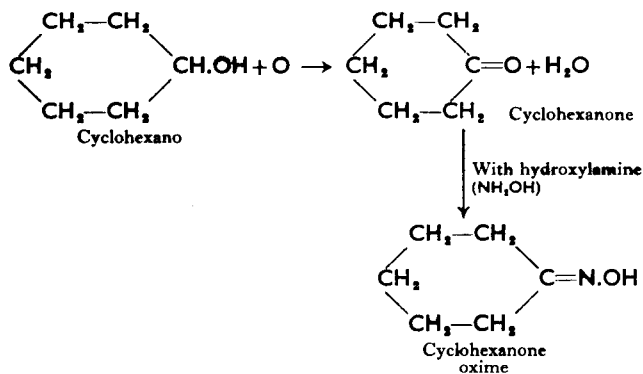

The oxime, when treated with sulphuric acid (24 per cent concentration) and subsequently neutralized, undergoes what is called the Beckmann rearrangement, by which it is converted to caprolactam.

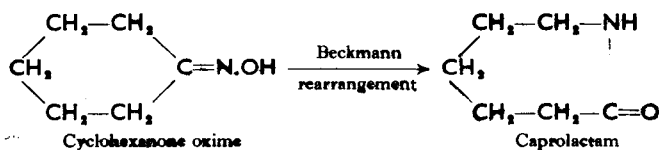

The polymerization is brought about by heating an 80 to 90 per cent aqueous solution of caprolactam in an autoclave to a temperature of 250° to 260°C (482° to 500°F). The polymer melts at 210° to 215°C (410° to 419°F) and can be withdrawn from the reaction vessel in liquid form.

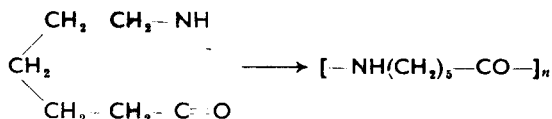

Polycaprolactam is melt-spun and the fibres are cold drawn in the manner which has already been described for nylon 66. In the orientated fibre, hydrogen bonds are formed between carbonyl and secondary amino groups in adjacent molecules, as demonstrated in Fig. 7.7. Perlon has a dry strength of 5.6 g per denier and an extension at the breaking point of 15 per cent. It melts at 215°C, compared with 250°C in the case of nylon 66, but it commences to soften at about 170°C. Nylon 6 also has a greater affinity for dyes than the 66 fibre, and the two should never be mixed together in goods which are destined to be dyed.

Rilsan, also known as nylon 11, has been manufactured in France by the self-condensation of ω amino-undecanoic acid ($\text{NH}_2-(\text{CH}_2)_{10}-\text{COOH}$). The starting point is castor oil which, when heated at 300°C (572°F) under reduced pressure, yields the unsaturated undecylenic acid, $\text{CH}_2=\text{CH}(\text{CH}_2)_8\text{COOH}$.

The reaction between hydrobromic acid and undecylenic acid yields 11 bromoundecanoic acid; the latter being converted to ω aminoundecanoic acid by the action of ammonia.

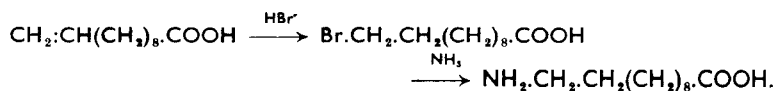

By a process of self-condensation brought about by heating to 200° to 220°C (392° to 428°F) this ω amino acid polymerizes to nylon 11.

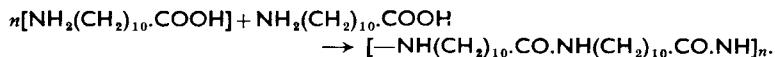

Rilsan melts at 175°C (347°F), has a poorer capacity for absorbing dyes than other nylons, and possesses a somewhat waxy handle.

Nylon 610, not used for textiles, is a copolymer of sebacic acid, $\text{COOH}(\text{CH}_2)_8\text{COOH}$, and hexamethylene diamine, which finds its outlet in the manufacture of bristles and other monofilaments. Nylon 66 + 6 is

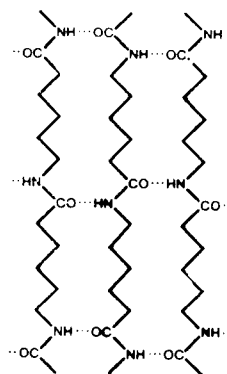

Fig. 7.7 Hydrogen bond formation in nylon 6
(Courtesy of 'Ciba Review')

known as Trelon and is made by copolymerizing nylon 66 salt and caprolactam. It melts at 238°C (460°F) and, as might be expected, has properties which are intermediate between nylon 66 and Perlon.

Nylon 7, a polymer of the lactam of hepticoic acid, is called Enant and is a Russian product. The initial raw materials are ethylene and carbon tetrachloride, which are heated in the presence of benzoyl peroxide, which acts as a catalyst, at a pressure of about 1500 lb per sq. in. when the following reaction takes place:



The compound in which n equals 3 can be separated with ease by fractional distillation and it is converted into omega-chlorohepticoic acid by hydrolysis with dilute sulphuric acid. The corresponding lactam is obtained by the action of ammonia and the latter resembles caprolactam in polymerizing into a super polyamide

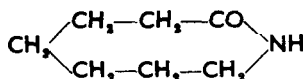

Nylon 9, which is polyaminoperlagonic acid, resembles Enant, except that n equals 8

The polyamide fibres owe many of their characteristics such as strength and comparatively low extension under load to hydrogen bonding and Van der Waals forces between well-orientated molecules. Endeavours have been made to reduce these intermolecular forces by introducing side chains, the usual method being to substitute the hydrogen atom in the NH group. What is called 1B 610 polyamide is composed of 20 per cent NN di-isobutyl, 20 per cent isobutyl, and 40 per cent of unsubstituted hexamethylene diamine copolymerized with sebacic acid (Wittbecker et al., *Ind. Eng. Chem.*, 1948, 40, 875). It possesses marked elastic properties bearing some resemblance to rubber as shown below in Table 7.1 (*Fibres from synthetic polymers*, Elsevier, p. 141).

Table 7.1

	1B 610 polyamide	Natural rubber	Nylon 66
Tenacity	1-1.7	0.15-0.35	4-5
Elongation (per cent)	250-400	600-1100	15-25
Modulus at 100 per cent extension, g/denier	0.3-0.5	0.01 S-0.025	25-35
Recovery (per cent)	95-99	100	—

Polyesters

The earliest experiments which Carothers made in the field of giant molecule synthesis were with dihydroxy straight-chain aliphatic alcohols

in which the hydroxyl groups were attached to each of the terminal carbon atoms; called $\alpha\omega$ glycols because the first and the last carbon atoms were hydroxyl substituted. They were condensed with dicarboxylic acids yielding polyesters.

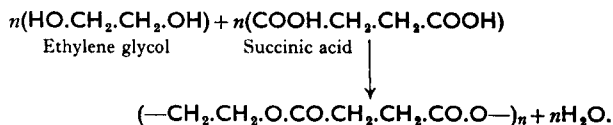

Several compounds of this nature were prepared, but none of them was suitable for spinning because the melting points were too low. It was Whinfield and Dickson, working in the laboratories of the Calico Printers'

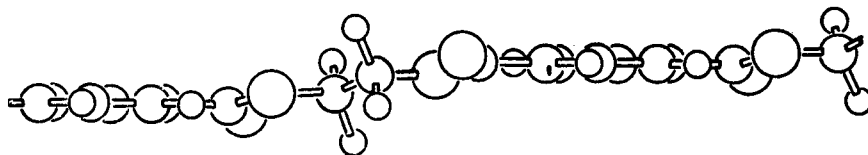

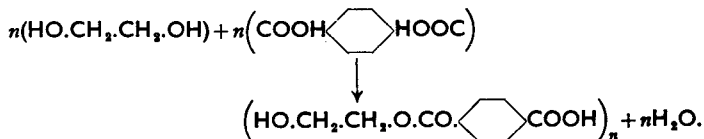

Fig. 7.8 Configuration of Terylene molecule
(Courtesy of 'Fibres from synthetic polymers', Elsevier)

Association, who were the first to appreciate that if terephthalic acid (COOH  COOH) was used instead of an aliphatic dicarboxylic acid, it would, on account of its symmetry, yield a fibre-forming polymer with a degree of intermolecular cohesion adequate to give a sufficiently high melting point. The symmetry and planar configuration of the molecules is well demonstrated in Fig. 7.8, from which it is apparent that when they are orientated so that they lie side by side, on parallel planes, there is abundant opportunity for the inter-molecular forces to hold them together.

The commercial polyester fibre known as Terylene or Dacron is the product of condensation of ethylene glycol and terephthalic acid.



Ethylene glycol was available in abundant quantities because it was derived from ethylene, a by-product in the cracking of petroleum. Ethylene, treated with chlorine water, yields ethylene chlorhydrin, which is converted to ethylene glycol when heated with a mild alkali such as sodium carbonate or calcium hydroxide.

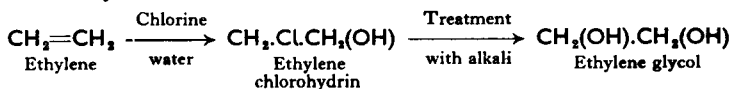

Terephthalic acid, however, was not available in commercial quantities at economically attractive prices when Whinfield and Dickson made their original discovery. After intensive efforts had been made it proved possible to purify paraxylene (CH_3  CH_3) and oxidize it to terephthalic acid on an industrial scale. Mixtures of ortho, meta, and para xylenes are obtained from cracking petroleum rich in aromatic hydrocarbons, or from the destructive distillation of coal. The orthoxylene can be removed from the mixture by distillation, leaving the meta and para isomers which, though boiling within a fraction of a degree of each other, melt at $+13.2^\circ\text{C}$ and -47.9°C respectively ($+55.8^\circ\text{F}$ and -54.4°F respectively). Paraxylene can, therefore, be obtained in a pure state by crystallization.

Terephthalic acid is prepared by oxidizing paraxylene with nitric acid



The isolation of terephthalic acid in a pure state from the products of oxidation is not easy because it cannot be distilled, nor is crystallization practical, on account of its insolubility in most solvents. It has, therefore, been found easier to esterify the crude yield after oxidation with methanol and purify the resultant dimethyl terephthalate by distillation and re-crystallization.

Polyethylene terephthalate is manufactured by mixing dimethyl terephthalate with a slight excess of ethylene glycol, heating to 150° to 210°C , and adding a suitable catalyst such as sodium or magnesium methoxide or zinc borate. Ester exchange takes place, according to the reversible reaction shown in the equation below, which goes to completion by removal of the methanol through a fractionating column.

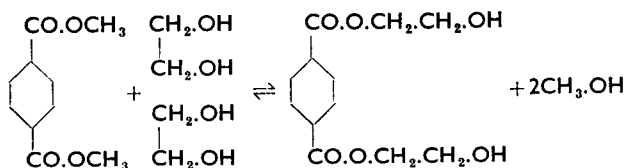

Some polymerization takes place during this reaction but only to a small extent.

The monomer is transferred to an autoclave and the temperature is raised to 280°C . Condensation takes place as shown:

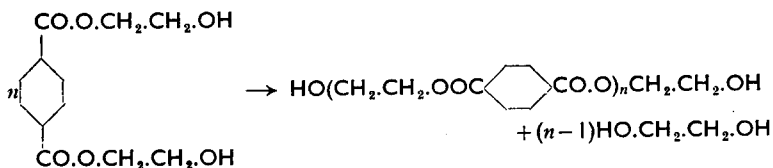

The pressure in the autoclave is reduced to below 0.1 mm Hg, which facilitates the removal of ethylene glycol. When polymerization is complete the molten product is run out of the autoclave in a thin stream, cooled, broken up into chips, and packed in sealed containers.

Fibres of polyethylene terephthalate are made by melt-spinning, taking the usual precautions to exclude oxygen from contact with the polymer whilst it is hot. The filaments, at this stage, are quite unorientated, weak, and capable of being stretched to four or five times their length. The mechanical system is illustrated diagrammatically in Fig. 7.9. The yarn, having passed through feed rollers to control its speed of delivery, passes over a hot pin which, in the first place, heats the yarn to above the second-order transition temperature and, secondly, locates the region of tension, ensuring that it shall not be applied whilst the thread is in the glass-like physical state. Passage between the beds of a hot plate maintains the temperature of the yarn as it passes to the draw roller which, by causing acceleration in its linear speed, applies the desired stretch.

Terylene, like nylon, is thermoplastic and can have permanent pleats or shapes imposed by the action of heat with or without steam. It breaks under loads of 4.2 to 4.8 g per denier and the continuous filament has an extension of 22 to 30 per cent at the breaking point. The fibre has marked crystallinity as shown by the X-ray diffraction diagram illustrated in Fig. 2.7, and by the low moisture regain of 0.4 per cent. The closely packed and highly-orientated molecules make Terylene markedly hydrophobic and difficult to dye. Modified polyester fibres are produced with an affinity for both disperse and cationic dyes.

Second order transition

As might be expected from the heterogeneous nature of their structure, synthetic fibres do not have a clearly defined melting point. Brown (*Textile Research Journal XXV*, 1955, 891) investigated the phenomenon known as second order transition, or also as the glass rubber transition. His method was to record the stiffness of the fibre which is the load required to produce 1 per cent elongation multiplied by 100 divided by the denier of the sample at various temperatures.

The stiffness temperature curve for Dacron is shown in Fig. 7.10 in which it will be observed that there is a gradual drop in the region between

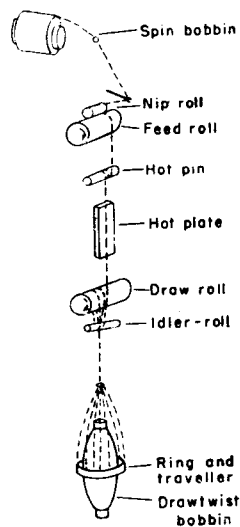

Fig. 7.9 The drawing process

(Courtesy of 'Man-made Textiles Encyclopaedia')

60 and 100°C followed by a more level portion of the curve and then a second drop at 250°C. This is explained by the loosening of the structure of the amorphous regions in the 60 to 100°C range and the melting of the crystallites at 250°C. Conventionally the abrupt melting or loss of structure

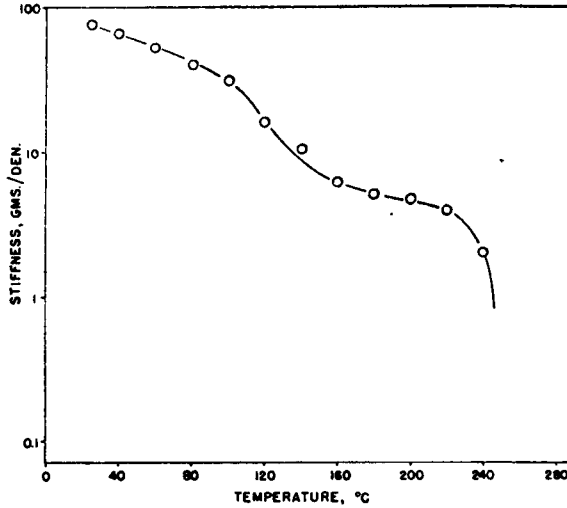

Fig. 7.10 Stiffness-temperature behaviour of Dacron
(*Textile Research Journal*, 1955, 893)

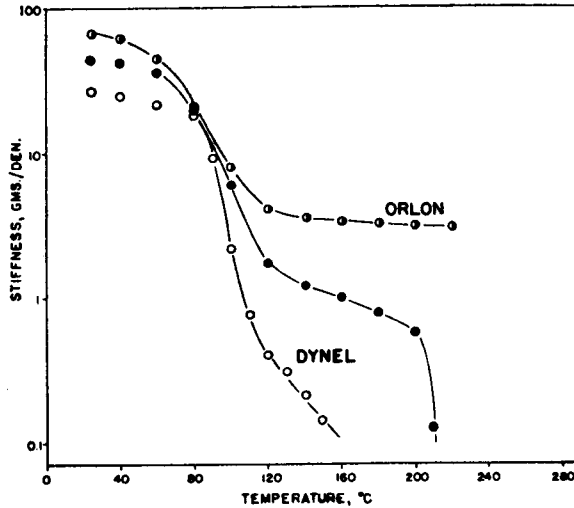

Fig. 7.11 Stiffness-temperature behaviours of Orlon, Dynel, and an experimental acrylic fibre
(*Textile Research Journal*, 1955, 894)

by a crystal is a first order transition and the less clearly defined loosening of the molecular arrangement in the amorphous zones is called the second order transition.

The significance of the amorphous regions in relation to the second order transition is shown clearly in the curves in Fig. 7.11. Orlon, the most crystalline of the three fibres shows the least reduction of stiffness with increase of temperature. Dynel, a copolymer, with the least crystallinity exhibits the greatest reduction, and lying between these two is an experimental acrylic fibre specially prepared with an intermediate degree of orientation. Second order transition temperatures are : polyethylene terephthalate (partly crystalline) 81 °C, nylon 66 (partly crystalline) 47°C, and polyacrylonitrile 81 °C.

Polyacrylonitriles

Experimental work on the polymerization of acrylonitrile : $(\text{CH}_2=\text{CH}-\text{C}\equiv\text{N})$ was commenced by Du Pont in 1940, and by 1942 small quantities of textile fibres were made available for commercial trials. Ethylene, from petroleum cracking, is converted to ethylene oxide which reacts with hydrogen cyanide in the presence of water containing diethylamine and caustic soda at 50°C, to form ethylene cyanhydrin:

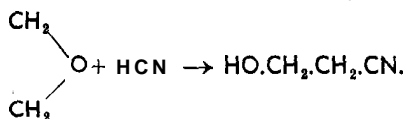

Dehydration with magnesium carbonate as a catalyst at temperatures between 170°C and 230°C converts the cyanhydrin into acrylonitrile:

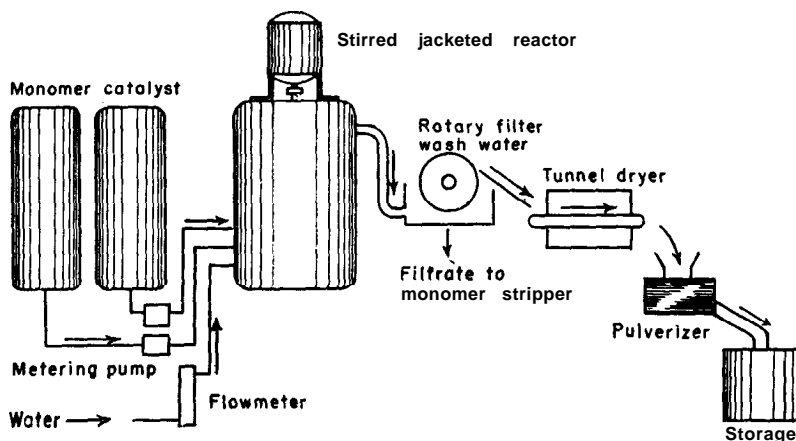
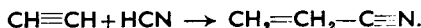

Fig. 7.12 Continuous polymerization of acrylonitrile
(Courtesy of 'Man-made Textiles Encyclopaedia')

Hydrogen cyanide can also be added directly to acetylene, the most successful method being to pass the two gases through an aqueous solution of cuprous chloride and ammonium chloride at 80°C. The dilute solution of acrylonitrile obtained in this way is concentrated by continuous distillation:



Acrylonitrile is a colourless liquid with a boiling point of 77.3°C and is sparingly soluble in water. It polymerizes readily in aqueous solution in the presence of a suitable catalyst such as benzoyl peroxide, azo-2'-2'-di-isobutyronitrile, or ferrous sulphate and hydrogen peroxide. Polymerization in water and separation of the polymer as it is formed are carried out as a continuous process; the plant lay-out is illustrated in Fig. 7.12.

The monomer, catalyst, and water are metered into the reaction vessel, provided with a stirrer. The incoming mixture displaces an equal amount through the outlet which contains the polymer in suspension. The polyacrylonitrile is separated from the liquor by the rotary suction filter and conveyed thence through a drier to a pulverizer and finally collected in a storage bin.

Melt-spinning is not practical with acrylonitriles because they decompose before they melt. Filaments must, therefore, be wet- or dry-spun from a solution, the best solvent being dimethyl formamide. Wet-spinning is preferred for staple or tow, the coagulating solution containing glycerin, calcium chloride, or other substances.

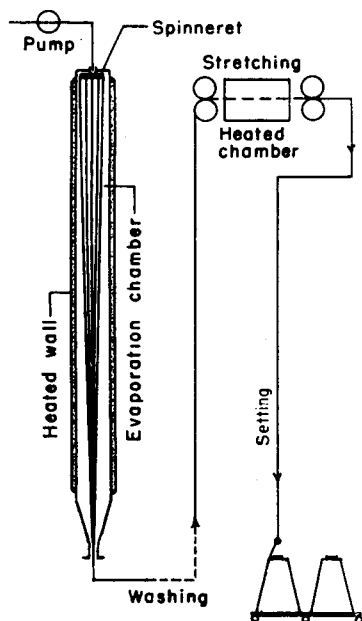

Fig. 7.13 Dry spinning acrylonitriles
(Courtesy of 'Man-made Textiles Encyclopaedia')

After rinsing till free from the coagulants, the molecules are orientated by stretching from 300 to 1000 per cent in steam at a temperature of not less than 100°C. When dry-spinning the solution is extruded through the spinneret into a chamber about 13 ft high which is heated to 400°C. A counter current of hot air or inert gas removes the solvent, which is recoverable. After washing, to remove residual traces of solvent, the yarn is drawn as it passes through a cell heated to a temperature of between 155° and 175°C (see Fig. 7.13). An important property of acrylic fibres is that when they are hot stretched to between 15 and 30 per cent the elongation is not stable and will relax in steam. If stretched and unstretched staple are spun together

and subsequently steamed, one will contract and not the other. This causes the low shrinkage component to buckle or bend outwards, giving a yarn with greatly increased loftiness. The two microphotographs in Fig. 7.14 are both of the same yarn, the one on the left before and the one on the right after bulking.



Fig. 7.14 Acrylic yarn before and after bulking

(Courtesy of 'Ciba Review')

Pure polyacrylonitrile is difficult to spin because it is insufficiently soluble in those organic solvents which are available on a commercial scale, and also because it is not easy to dye. Commercial fibres are usually copolymers containing small amounts of other monomers which introduce polar groups into the molecule. Amongst the compounds which have been used for copolymerization are methylmethacrylate, vinyl pyridine, and vinyl chloride or acetate. The side chains interrupt the regularity of the acrylonitrile skeleton, thus opening up the structure and improving accessibility to solvents and dyes. Usually the additions are small in amount and, by convention,

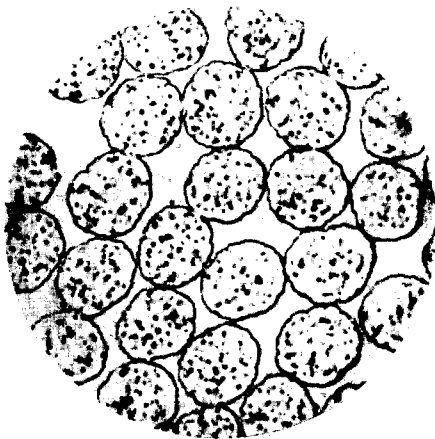

Fig. 7.15(a) Cross-section of Acrilan ($\times 500$)

(Courtesy of Chemstrand)

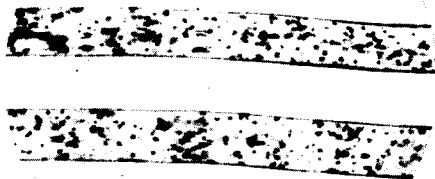

Fig. 7.15(b) Acrilan ($\times 500$)

(Courtesy of Chemstrand)

if the fibre does not contain more than 15 per cent of a foreign material it is referred to as a polyacrylonitrile or an acrylic. Modified acrylonitriles or 'Modacryls' contain more than 35 per cent, but less than 85 per cent, of acrylonitrile.

Courtelle, Orlon, and Acrilan are acrylics. Courtelle contains a small amount of a copolymer with electronegative groups to give it an improved affinity for cationic dyes. Dynel is a modified acrylic composed of 60 per cent of vinyl chloride and 40 per cent of acrylonitrile.

The acrylics have a second-order transition temperature within the range

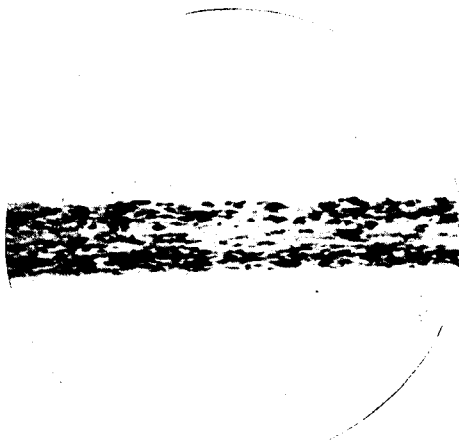

Fig. 7.16(a) Orlon 42 fibre

(Courtesy of Hosiery and Allied Trades Research Association)



Fig. 7.16(b) Orlon 42, cross-section
(Courtesy of Du Pont)

of 60°C to 120°C. They have remarkable resistance to weathering. After exposure during a period of one year polyacrylonitrile fibres only lost 20 per cent of their initial strength whilst cotton lost about 95 per cent and acetate, nylon-6 and silk lost approximately 99 per cent (*Ciba review*, no. 137). Of all the man-made fibres those derived from acrylonitrile bear the closest resemblance to wool and silk in handle. The fibres commence to soften at 225° to 250°C, a temperature range sufficiently high to cause no difficulty under all normal conditions of use. Water at temperatures lower than 60°C is without effect upon the mechanical or physical properties and there is therefore good resistance to deformation during laundering. Pleats or shapes can be imposed at temperatures above that at which the second-order transition takes place and they will be stable at temperatures below 60°C.

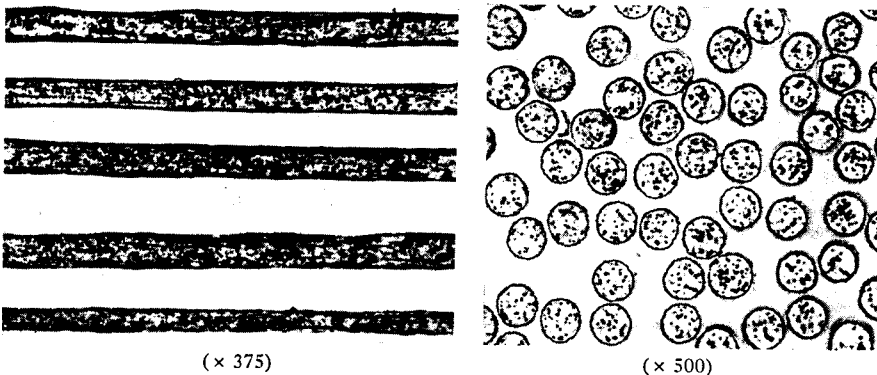

($\times 375$)

($\times 500$)

Fig. 7.17 Courtauld fibres and cross-sections

(Courtesy of Courtaulds)

Pure polyacrylonitrile fibres have high tensile strength, but the separation of the molecules by side chains in the copolymers tends to reduce tenacity. A compromise is generally accepted with a breaking strain of about 4 g per denier, and an extension at break of 30 to 40 per cent. The fibres vary considerably in the shape of their cross-sections when viewed under the microscope, although the longitudinal surface views of the fibres are all alike (Figs. 7.15, 7.16, and 7.17).

Polyvinyl fibres

Polyvinyl chloride, alcohol, acetate, and their copolymers are used to a limited extent for fibre production. They are cheap because the monomers are easily prepared from ethylene or acetylene, both of which are available in abundance. The fibres have not been used much for textiles, however, because they soften at temperatures varying between 50° and 100°C, according to the composition of the polymer.

When ethylene is chlorinated at 400°C, vinyl chloride is the main product

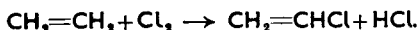

Alternatively, when acetylene and gaseous hydrogen chloride are brought into contact with a catalyst consisting of mercuric chloride deposited on charcoal at a temperature slightly below 200°C, direct addition takes place:



Vinyl acetate is made in bulk by passing acetylene into a reactor containing acetic acid and mercuric sulphate which acts as a catalyst, the temperature not being allowed to rise above 30°C.

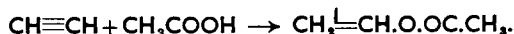

Polyvinyl alcohol is prepared by the saponification of the polyvinyl acetate.

Pure polyvinyl chloride is the composition of PCU, produced in Germany, and of Rhovyl and Thermovyl, made in France. PCU loses its mechanical stability and shrinks considerably, due to the stretched molecules resuming their original configurations, at temperatures of 75° to 80°C. It compares unfavourably, therefore, with other synthetic fibres for textile uses. It has found certain specialized applications for making fishing lines, filter cloths, and sails.

Rhovyl is a pure polyvinyl chloride fibre, dry-spun, from a solution of the polymer in acetone and carbon disulphide. It is highly orientated and has a breaking point at 3 g per denier with an extension of 12 per cent at break. It commences to shrink at 75° to 80°C. It has uses in the industrial field, for making mosquito-netting and furnishing fabrics, where the lack of dimensional stability towards heat is no disadvantage. It has also been used to some extent in textiles where its shrinkage is taken advantage of to give a very solid leather or felt-like finish. Thermovyl is a polyvinyl staple fibre which is less highly orientated than Rhovyl and has been pre-shrunk

at 100°C in the staple form. It is therefore dimensionally stable in water up to the boiling point. Its tenacity is only 0.9 g per denier but, since it is more disorientated, it has an elongation at breaking point of 150 to 180 per cent. It is rarely spun into yarns alone, but usually is mixed with wool, nylon, or cellulosic staples.

A modified polyvinyl chloride fibre which has been made in moderate quantities in Germany is Pe Ce. Vinyl chloride is polymerized and subsequently chlorinated till it contains 64 per cent of chlorine, which increases its solubility in acetone and therefore makes wet-spinning easier. Chlorination also raises the temperature at which softening commences from between 75° and 80°C to 80° and 100°C. Pe Ce fibres are spun from a 30 per cent solution of the polymer in acetone using water as the coagulant. Orientation is brought about by drawing to 300 per cent during spinning. It has a tensile strength of 2 to 2.2 g per denier and a 40 per cent elongation.

Vinyon HH is a staple fibre, a copolymer of vinyl chloride and vinyl acetate, and is dry-spun from a solution in acetone:

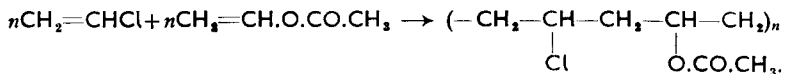

The fibre has a very low softening temperature: between 52° and 60°C. It has little textile value by itself, but has been used with other fibres as a bonding agent to make articles such as carpets or rugs.

The copolymers of vinyl chloride and acrylonitrile have been more successful in the textile field:

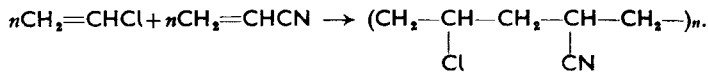

Vinyon N is a continuous-filament yarn and Dynel is a staple fibre; both are copolymers composed of 60 per cent vinyl chloride and 40 per cent acrylonitrile. These fibres are considerably more stable towards heat: commencing to shrink at 116°C, and softening in the region of 130°C when shrinkage becomes marked. Dynel finds textile application because it has adequate stability towards heat, an extremely soft handle and is cheaper than the acrylics.

Yarns which have a composition corresponding with polyvinyl alcohol, known as Vinyon, have been used with some success in Japan. The polymer is soluble in water and is therefore of no textile value. Treatment with formaldehyde, however, builds ether linkages between adjacent carbon atoms attached to hydroxyl groups as shown in the equation:

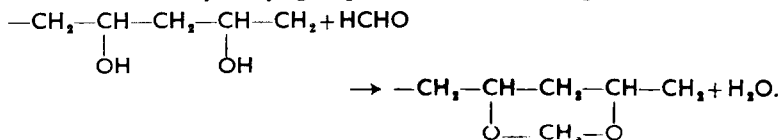

This alteration in chemical structure makes the product insoluble in water. Vinyl acetate ($\text{CH}_2\text{COOCH}:\text{CH}_2$) is dissolved in methanol and converted into polyvinyl acetate, using a peroxide as a catalyst. Caustic soda is then added to the solution in methanol when the acetate groups are converted to hydroxyl leaving polyvinyl alcohol as the end product.

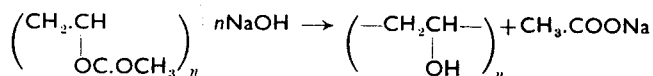

The filaments are stretched, and dried at 210° to 220°C in order to impart sufficient resistance to water to make it possible to treat them with formaldehyde and sulphuric acid, in aqueous solution, at 75°C , when about 40 per cent of the hydroxyl groups react with the formaldehyde. Vinyon withstands boiling water and softens at about 200°C . It has a dry strength of 3.2 g per denier and 2.3 g per denier when wet, with a 28 per cent elongation at break.

Perlon U, which was manufactured in Germany to a small extent, is a polyurethane. It is formed by the action of hexamethylene di-isocyanate on 1:4 butanediol. The butanediol is obtained by the action of formaldehyde on acetylene followed by reduction:

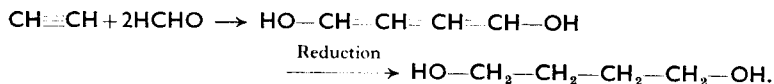

The hexamethylene di-isocyanate is prepared by dissolving hexamethylenediamine in dichlorobenzene, converting into hexamethylene diammonium carbonate by passing CO_2 into the solution and then treating with phosphene:

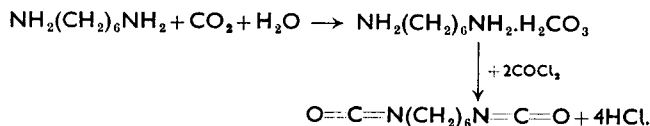

The butanediol and the di-isocyanate then copolymerize as follows:

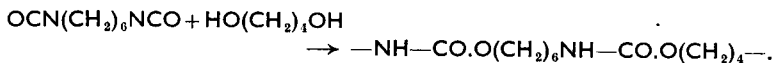

Closely related to vinyl chloride is vinylidene chloride $\text{CH}_2=\text{CCl}_2$. It can be obtained from ethylene which is readily converted into trichlorethylene by the action of chlorine.

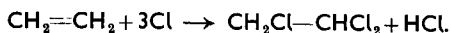

When the trichlorethylene is allowed to react with lime, chlorine is removed with the formation of vinylidene chloride in accordance with the following equation:

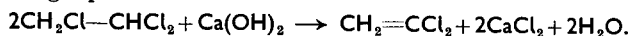

Saran is a generic name used in the United States for all fibres spun essentially from vinylidene chloride, although they are usually copolymerized with small amounts of another monomer. The most common composition is 85 to 90 per cent vinylidene chloride and 10 to 15 per cent vinyl chloride.

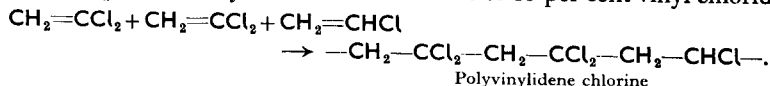

The polymerization is usually brought about in a state of emulsion from which the product is separated as an insoluble precipitate. Saran is produced as monofilaments destined to be made into car-seat covers, insect screening, outdoor furniture, awnings, and similar articles. A melt-spinning method is the usual practice in which the copolymer is extruded through the spinneret at 180°C when it solidifies as soon as it emerges from the orifice. Soon after cooling the filaments are stretched to orientate the molecules and are then wound onto bobbins. The product is very hydrophobic and, in consequence, it is difficult to dye, and colouring is usually achieved by incorporating a pigment in the spinning mixture.

Saran is cheap and has extremely high resistance to exposure to sunlight, biological attack, and other factors which enter into weathering. It softens at 115°C but loses much of its strength in water at 100°C or even lower temperatures.

Polyethylene, commonly known as polythene, was first produced commercially in 1939 by polymerization of ethylene:

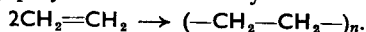

It is manufactured by heating ethylene to 200°C at a pressure of 1500 atmospheres in the presence of a trace of oxygen which acts as a catalyst. When aluminium triethyl and titanium tetrachloride are used as the catalysts the polymerization can be carried out at lower, or even at atmospheric, pressure. Polyethylene can be melt-spun into fibres, but they have not yet found significant textile application because of their wax-like handle, the complete absence of affinity for dyes, and the low softening point at 90°C and the melting point at 110° to 120°C. Monofilaments are made for electrical use on account of the excellent insulating property of the substance.

Isotactic polypropylene (see Chapter 2) is prepared with a modified Ziegler catalyst based on titanium trichloride and tetramethyl aluminium. The polymer which is fibre forming, has a melting point of 165°C. It is marketed under the names Moplin, Merkalon, and Ulstron. It has outstanding wet and dry strength, and a specific gravity of 0.91 which is lighter than any other man-made or natural fibre. There is difficulty with dyeing, but it is so inert that many additives capable of conferring affinity can be incorporated without danger of reaction during melt-spinning. The fibre possesses outstanding resistance to most chemicals and its main outlet has been for fishing nets and ropes, where great tensile strength and low weight are desirable.

Bulked and crimped yarns

On account of their thermoplastic nature it is comparatively easy to introduce a very high degree of curliness or crimp into synthetic fibres such as the polyamides and the polyesters. This treatment gives yarns with an extremely high stretch; 1 inch undergoes extension to a length of about 6 inches with complete recovery when the load is removed. There is also a great increase in bulkiness without addition to the weight which, in many

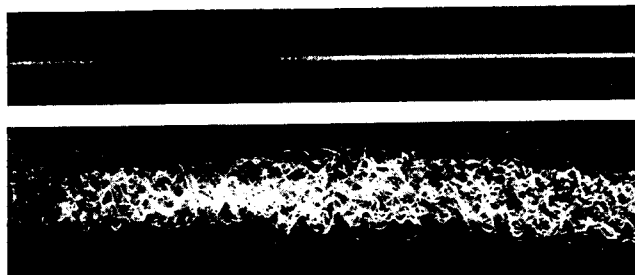

Fig. 7.18 Nylon 66 normal and bulked
(Courtesy of 'Hosiery trade journal')

cases, adds greatly to the appeal of fabrics. Fig. 7.18 shows a bulked nylon below, and the same yarn before it was crimped above.

The first successful yarns belonging to this category were made by knitting lengths of continuous filament nylon into a tubular fabric. The loops were then permanently set by steam-treating the fabric in an autoclave at a pressure of 25 lb per sq in. After this application of heat the yarn was wound back from the fabric onto a cone or other suitable package. The retained loops of the knitted structure, which were straightened out under tension, returned on relaxation, giving a mechanical system not unlike a coiled spring.

Knitting and setting, because it was not a continuous process, proved cumbersome and it was not long before improvements made their appearance. The first of these was gear-crimping, in which the thread passed between the mesh of heated gear wheels. It emerged with zigzag configurations imposed by the teeth. The method is extremely simple but has not been successful because the product did not meet requirements with regard to either bulk or stretch. Better results were obtained by giving about four times the normal amount of twist to a multi-filament yarn, winding it onto a suitable holder and steam-setting it. After heat treatment the yarn is untwisted, when the monofilaments will retain the helical configuration imposed on them in the highly twisted state as shown in Fig. 7.19. This method has now been displaced by the false-twist bulking process which is illustrated diagrammatically in Fig. 7.20. The yarn is drawn through a false-twist spindle rotating at very high speed. Twist is applied in the region

between the supply package and the spindle and heat setting takes place in this zone. Back twisting occurs spontaneously during the passage from the spindle to the final delivery roller. It is not easy to describe what takes place, but it can be illustrated by clamping a length of monofilament at two points and applying twist at the middle with thumb and forefinger. Outside the clamps the yarn is not twisted, but between them there will be equal turns per inch—of one 'hand' (say clockwise) on one side of the twisting point, and of the opposite 'hand' (anticlockwise) on the other.

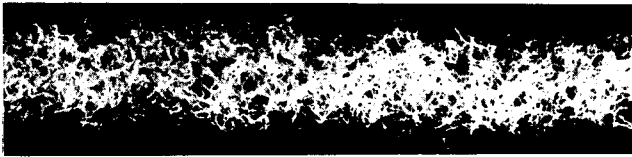

Fig. 7.19 Bulked yarn made by setting with high twist
(Courtesy of 'Hosiery trade journal')

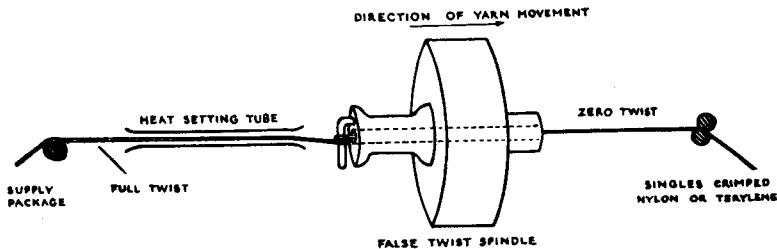

Fig. 7.20 Diagram of false twist method
(Courtesy of Hosiery and Allied Trades Research Association)

Banlon is made by application of crimp to a thermoplastic yarn whilst it is being over-fed into a heated stuffing box as illustrated in Fig. 7.21. Curled bulked yarns, marketed under the general name of Agilon, are produced by drawing the thermoplastic thread over a radiused heated edge which imposes a helical configuration on the filaments. In practice, Agilon can be produced on an ordinary winding machine by inserting the heater and radiused edge between the source of supply and the final package. Taslan products are bulked without thermosetting and therefore have no elastic properties. They are made by feeding yarn into an air chamber at a rate which is 10 to 25 per cent faster than it is withdrawn. The air current produces a cyclonic movement inside the chamber which makes loops in the individual filaments of which the yarn is composed (see Fig. 7.22).

With the exception of Taslan, all the bulked yarns which have been described are not dimensionally stable. The materials made from them lose a greater or less proportion of their area on relaxation in hot water, when equilibrium is established between the release of the elongation caused by winding, knitting or weaving tensions and the natural rigidity of the fabric.

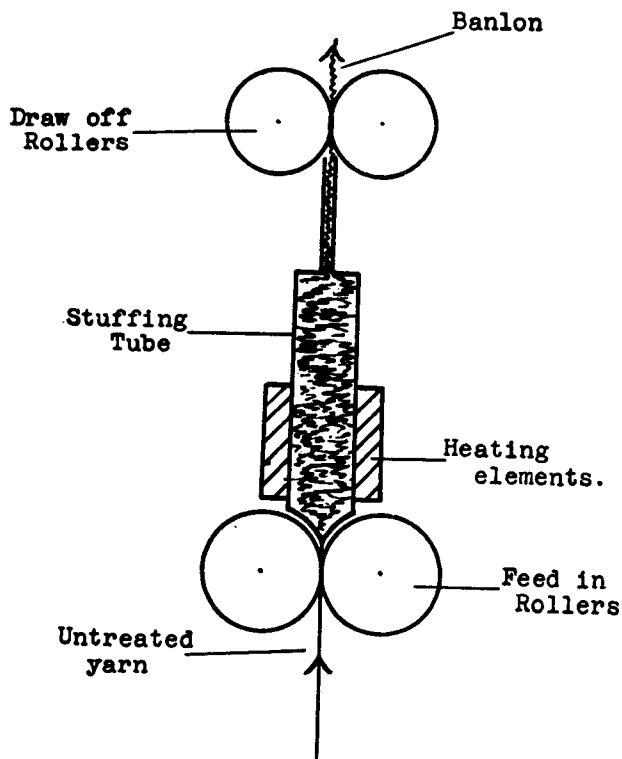

Fig. 7.21 Diagram of stuffing box for crimping

(Courtesy of Hosiery and Allied Trades Research Association)

This creates difficulties in the size control of the finished product. Crimp-lene and Astralene C are dimensionally-stabilized polyester yarns, and Astralon C is the equivalent polyamide product. They are bulked by the usual false-twist method and then wound very loosely onto packages so that there is freedom to contract. The bobbins are treated with steam under pressure, when reduction in length takes place, leaving a more closely packed yarn, which still has adequate bulk but offers greater resistance to stretching. The result is that garments or materials only have a 6 per cent relaxation shrinkage instead of about 25 per cent which is common with other crimped yarns.

The temperature to which the yarn has been exposed during crimp-setting affects both the affinity for dyes and the elastic properties. The crimp rigidity is a measure of the ability of the yarn, after knitting or weaving, to relax and simultaneously increase in bulk. Both the setting temperature and the twist during crimping will influence the crimp rigidity. This property is measured by winding 5 m of the yarn on a yarn reel and

folding the original skein into a doubled hank of half the length. A heavy weight equivalent to 0.098 g per denier is then suspended by a hook to the bottom end of the hank and the top rests in a V-shaped support rod. The hank is lowered into a tall glass measuring cylinder, the support rod resting on the rim (Fig. 7.23). The cylinder should already have been

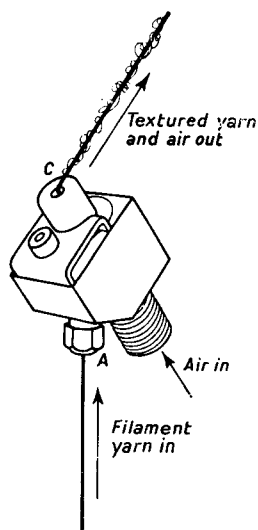

Fig. 7.22 Taslan bulking device

(Courtesy of E. I. du Pont de Nemours)

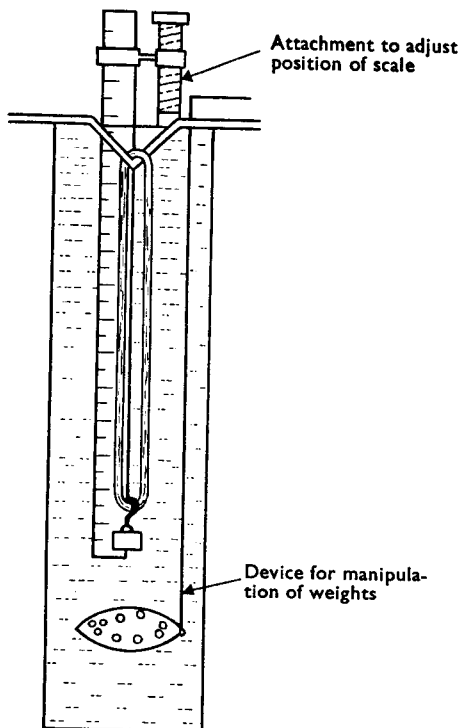

Fig. 7.23 Apparatus for determining crimp rigidity

(Courtesy of Hosiery and Allied Trades Research Association)

filled with water containing a little Teepol. After 2 minutes the length (L_1) of the hank is measured. The weight is then removed and a lighter one equivalent to 0.002 g per denier is substituted. After a further 2 minutes the length (L_2) is again measured. The crimp rigidity, expressed in terms of percentage, is $\frac{L_1 - L_2}{L_1} \times 100$. This factor can have a very significant effect upon the handle of dyed and finished garments.

Elastomeric fibres

Rubber-covered yarns have been used for a long time where high elasticity and perfect recovery are desirable. Such uses are in foundation

garments, swimwear and surgical hosiery. The disadvantages associated with natural rubber are instability to heat and light, bleaching agents, and dry cleaning. Rubber also has no affinity for dyes. Many of these objections are absent in synthetic elastic fibres to which the general description elastomers has been given.

The basic structure of the elastomers consists of alternating 'hard' crystalline regions and soft segments where the molecules are in an unorientated and collapsed form capable of considerable extension under tension. In the hard regions there is considerable intermolecular hydrogen bonding as well as cross linking in many cases. This gives rigidity and recovery properties which are absent in the soft zones (see Fig. 7.24).

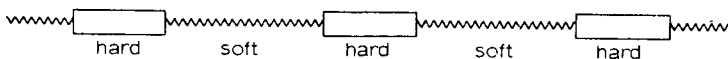
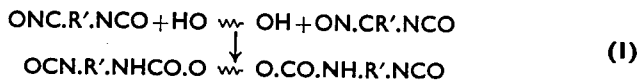

Fig. 7.24

The soft segments are composed of prepolymerized polyethers or polyesters with terminal hydroxyl groups, the molecular weights usually falling within the range of 1000 to 3000. Polyethers are obtained from propylene oxide and tetrahydrofuran. Dihydroxy alcohols and dicarboxylic acids give polyesters with hydroxyl groups at each end as follows:



These prepolymers are treated with an excess of a di-isocyanate, usually aromatic, so that a new prepolymer is formed having terminal isocyanate groups with soft segments situated between urethane groups.



The prepolymer (1) above has two reactive end groups. Further polymerization can therefore be brought about by coupling with bifunctional reagents such as diamines, diols and also water. The reaction with a diamine gives the polymer (2) which can be dissolved in dimethylformamide or dimethyl acetamide and then dry-spun to give elastomeric fibres.

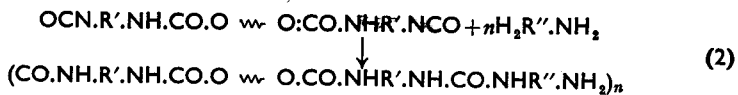

It is also possible to increase the complexity of the prepolymer during wet spinning. When extruded into an aqueous solution of a diamine a filament is formed with a tough skin and a liquid core. The skin prevents further diffusion of the diamine and the filament can be wound into a suitable package, after which the core is hardened by heating with water

for a prolonged time under pressure when the following reaction takes place:

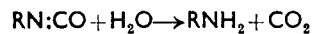

These newly formed amino groups can then react with other unconverted isocyanate groups.

8 · Water and water purification

A PLENTIFUL supply of suitable water is essential for a dyeing and bleaching plant. Before modern methods of water purification were available, the textile industries tended to congregate in areas where the natural water supply was plentiful and sufficiently pure. Water with a high degree of purity is rarely obtainable from natural sources. A knowledge of the impurities which will probably be present and how to remove them is, therefore, desirable. Supplies of water may be classified as follows:

- (i) rain water;
- (ii) surface water, which consists of rain water which has collected into streams, rivers, or lakes;
- (iii) subsoil water, which has percolated a small distance into the ground. It is collected from shallow wells or surface springs; and
- (iv) deep well waters, which have usually percolated through several strata.

Rain water

Rain, collected immediately after precipitation, is the purest of all natural waters. It may contain traces of gases dissolved out of the atmosphere, and possibly an almost infinitely small amount of finely divided solid matter derived from the air. In the neighbourhood of towns rain may collect dissolved or suspended impurities such as soot, traces of sulphur dioxide, or sulphuric acid, and other by-products of industrialization. Rain water from such sources is improved by filtration through a bed of sand. Although the collection of rain for industrial purposes does not warrant serious consideration, there are occasions when small quantities of it may be useful for special purposes. If storage is undertaken it is desirable to have some device which rejects the first few gallons which will be delivered from the collecting surface after a dry period, because they will contain all the solid matter which has been deposited from the atmosphere. Further purification, if it be desired, is easily achieved by passing the water through a filter made by filling a barrel or small tank with alternate layers of pebbles and fine sand.

Surface waters

Rain inevitably finds its way into streams, rivers, and lakes, all of which are classified as surface water. As it passes over the surface of the earth it carries with it organic matter in various stages of decomposition. It may

also dissolve a certain amount of mineral matter, depending upon the nature of the soil or rock with which it has come into contact. When it reaches a site where it can stagnate, such as a lake, it deposits the suspended matter but retains the dissolved organic and inorganic constituents. Nitrifying bacteria will in time convert the organic substances into nitrates which are not objectionable in dyeing and finishing. Surface waters, however, may receive considerable additions of dissolved mineral salts from shallow springs which feed the streams. Surface water is sometimes distinctly discoloured by colouring matter derived mainly from peat but also from other decaying vegetable sources.

Subsoil water

Water in this classification is collected from shallow springs and wells which are not much more than 50 ft deep. It is, therefore, surface water which has percolated a short distance through the soil or rock formation. It is usually free from suspended impurities because it has been filtered by its passage through the soil. It will, however, contain dissolved organic matter which was either collected whilst it was surface water or was extracted from the zone in the soil which is densely occupied by the roots of vegetation. Subsoil water is often rich in dissolved carbon dioxide, a gas abundantly present in the skin of the soil because it is a by-product of the metabolism of vegetable life. Water rich in carbon dioxide will convert insoluble calcium carbonate in any rocks with which it comes into contact into soluble calcium bicarbonate. Subsoil waters are very variable with regard to the impurities which they contain because pollution is determined by the nature of the surface on which the rain falls and the composition of the soil or strata through which the water has percolated. Analyses of four different samples of these waters drawn from different sources are given in Table 8.1 below, the results being expressed in parts per 100,000.

Table 8.1

	<i>Total solids</i>	<i>Sodium chloride</i>	<i>Total hardness</i>
Sample I	25.5	3.44	14.25
Sample II	58.0	10.8	35.0
Sample III	148.0	7.68	69.0
Sample IV	226.5	25.0	115.5

Deep well water

The deep wells are those which are bored through the subsoil into the water-bearing strata beneath. Water from such sources is generally free from organic matter because it has percolated through a considerable depth of rock and soil, and this type of impurity has been removed by filtration

or bacterial activity. The mineral content, however, may be very high because the water has had abundant opportunity to extract soluble inorganic constituents from the strata through which it has passed.

The impurities in water may be either suspended or dissolved. Filtration is necessary to remove matter held in suspension. The addition of a precipitant to the water before it is filtered greatly improves the efficiency of the process. Aluminium hydroxide forms a flocculent precipitate which retains coloured matter and colloiddally-suspended impurities. It is common practice to add aluminium sulphate, in the form of alum, to the water but, because this salt gives an acidic solution, no aluminium hydroxide will be precipitated until the pH has been adjusted to between $pH5$ and $pH7$.

Aluminium hydroxide is amphoteric and can give a negatively or positively-charged precipitate according to the pH of the water. To remove the coloured and colloidal suspended matter the aluminium hydroxide must be precipitated at that pH which will give it a charge opposite to the one borne by the impurities. It is apparent, therefore, that good purification depends upon ascertaining the optimum pH for the water in question, and maintaining accurate control during flocculation. Sodium aluminate is recommended as the alkali to precipitate the $Al(OH)_3$ (Hendry, *J.S.D.C.*, 1942, 153). The aluminate is added first to give a negatively charged flocculent precipitate. Then the alum is added, from which a positively charged aluminium hydroxide is derived, and the interaction of the positively and negatively charged precipitates gives better flocculation and, therefore, improved removal of the organic impurities.

Hydrated ferric oxide is also a coagulant. Aluminium sulphate made from bauxite rich in iron contains a considerable quantity of ferric sulphate and this mixture is known as aluminoferric. Hydrated silica, prepared by the addition of an acid or sodium bicarbonate to sodium silicate solution is also effective as a coagulant. It can be used alone or with aluminium hydroxide.

A pressure filter is shown in Fig. 8.1. The crude water enters at the top, having previously been charged with the right amount of alum and alkali. The pressure of the supply then forces the water through the filter bed composed of sand, after which it is withdrawn at the bottom through strainer tubes. The sand bed can be washed from time to time by reversing the direction of the flow and running the water, now emerging from the top, to waste.

The soluble impurities in water may be composed of a variety of substances. Soluble organic compounds, ammonium salts, nitrates and nitrites of animal or vegetable origin may be found. If they are present in considerable quantities they indicate the possibility of sewage contamination. This form of pollution is undesirable for many textile purposes because it may contain putrefactive or chromogenetic organisms which could cause discoloured spots or degradation of dressing or finishing mixtures. Sodium

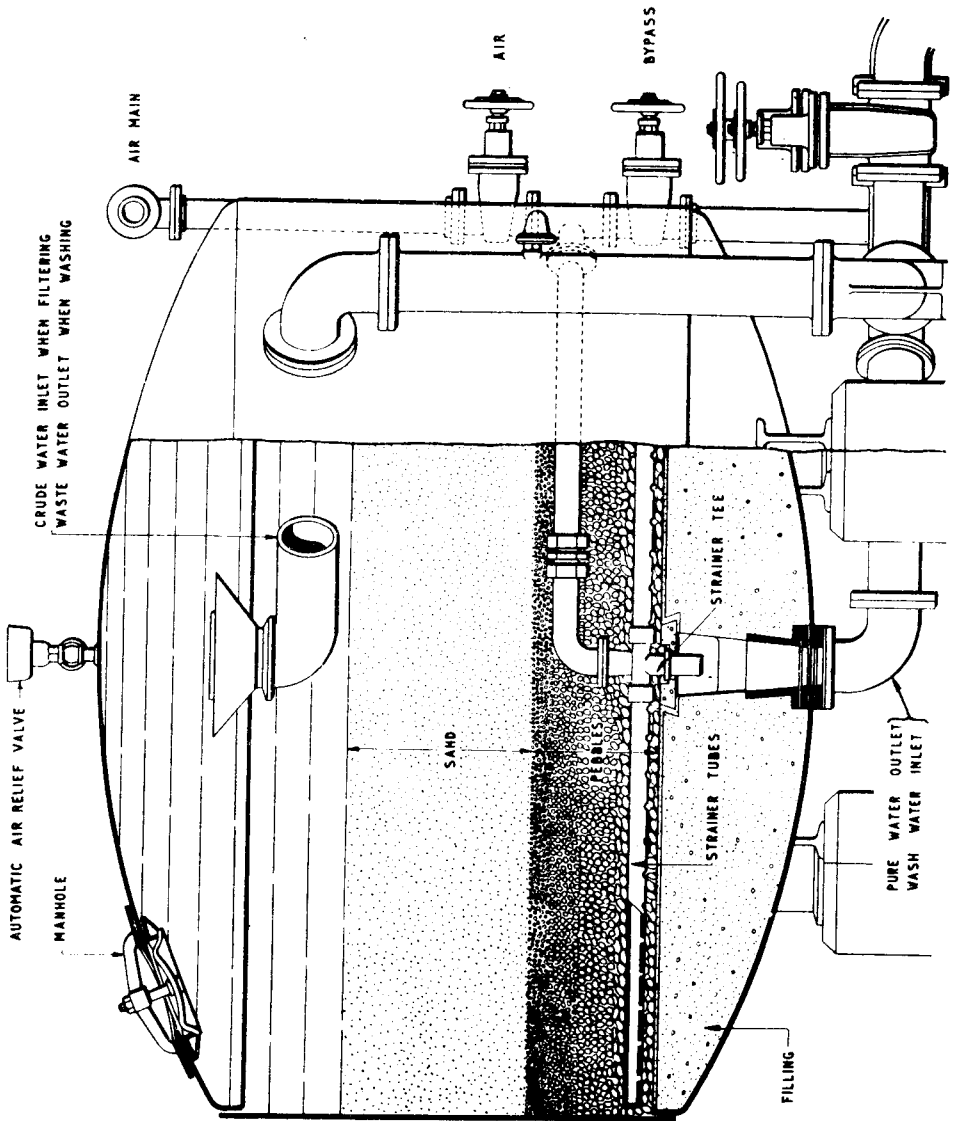

chloride can indicate sewage contamination but, itself, is harmless. Sometimes water contains iron salts in solution, an impurity which is highly undesirable, because it causes faint discoloration of whites in bleaching and a dulling of brighter shades in dyeing. Water always contains nitrogen, oxygen, and carbon dioxide in solution. The nitrogen is quite inert but the oxygen is not without influence in processes where dyes are applied in a state of reduction, and both carbon dioxide and oxygen can enter into reactions which lead to boiler corrosion.

The presence of salts of calcium or magnesium in solution can be most undesirable in many finishing processes. These salts are responsible for hardness of water and they lead to the formation of insoluble precipitates with soaps which may be deposited on the goods, causing discoloration. Calcium and magnesium compounds are commonly present as sulphates and chlorides. Bicarbonates produce what is known as 'temporary' hardness; sulphates and chlorides are the cause of 'permanent' hardness.

Temporary hardness

Calcium and magnesium carbonates are virtually insoluble in water. The carbon dioxide which is always present in natural waters will convert calcium or magnesium carbonates in the rock formations with which contact is made, into soluble bicarbonates:

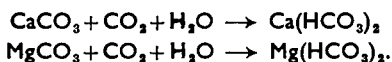

When water is boiled the bicarbonates decompose with liberation of carbon dioxide and precipitation of the insoluble carbonates which are re-formed:



Hardness caused by bicarbonates is called temporary because it disappears on boiling. It is a contributory factor in the formation of scale in boilers, which is a deposit, amongst other things, of calcium carbonate and magnesium hydroxide. The latter is formed by the decomposition, in the boiler, of magnesium carbonate:

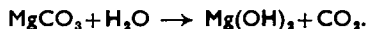

Permanent hardness

Calcium and magnesium chlorides or sulphates are soluble in water both in the presence and in the absence of carbon dioxide. Expulsion of dissolved carbon dioxide makes no difference to their solubility. They are not, therefore, precipitated when the water is boiled, but remain in solution, and therefore hardness due to these salts is called permanent hardness. Most waters contain both temporary and permanent hardness, but the proportions of the two vary widely.

Methods of expressing hardness

In stating the hardness of water it is usual to express it in terms of calcium carbonate, and this applies to both temporary and permanent hard-

ness, irrespective of whether they are due to salts of calcium or magnesium. Hardness is described quantitatively in two ways, namely, in degrees or in parts per 100,000. Degrees of hardness are the number of grains per gallon, expressed as calcium carbonate. A gallon of water contains 70,000 and one pound 7000 grains. It follows, therefore, that parts per 100,000 may be converted into grains per gallon by multiplying by 0.7 and, conversely, grains per gallon divided by 0.7 will give the hardness expressed in parts per 100,000.

Properties of hard water

The most important characteristic of hard water is its reaction with soap. If distilled or soft water be shaken with a solution of soap a lather or foam is formed immediately. If, however, a dilute solution of soap be added drop by drop to some hard water in a bottle which is stoppered and shaken after each addition, it will be found that no lather is formed at first. The water, at the same time, assumes a turbidity owing to the formation of an insoluble precipitate. Finally, after sufficient soap has been added, a lather will appear. Soaps are sodium salts of fatty acids of high molecular weight, such as sodium oleate $C_{17}H_{33}COONa$. The salts of sodium are soluble in water, but those of calcium and magnesium are not and, in hard water, the ions of these elements displace the sodium, giving precipitates of their insoluble fatty acid salts:

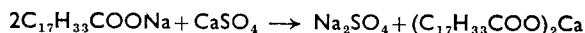

When the whole of the hardness has been changed into insoluble calcium and magnesium compounds, further addition of soap will create a lather and be available to function as a detergent. There is a wastage of 1.7 lb of soap per 1000 gallons of water for each grain per gallon of hardness.

Hard water is also objectionable because the insoluble soaps associated with its use tend to be deposited on the goods during scouring, when they give rise to faults. The soaps are somewhat sticky and adhere quite tenaciously to the materials, picking up adventitious dirt or impurities, thereby causing discoloured patches. They also form spots impervious to dye liquors, with the result that the final colour is not uniform. Some dye-stuffs form calcium compounds which are insoluble, and hard water can, therefore, cause serious interference with the application of such dyes.

Scale-forming waters

Temporary hardness is rapidly converted to calcium carbonate and magnesium hydroxide in a boiler, and in time accumulates in the form of scale on the inner surface of the shell or in the tubes. Calcium sulphate, though soluble, does not possess a high water solubility, and with the continual concentration that occurs in a boiler it crystallizes out on the heated surface. Temporary hardness forms a sludge or loosely-adhering scale, but

calcium sulphate scale is extremely hard and firmly attached. Silica is also present in most natural waters and, although the quantities are small, it leads to the formation of thin hard scales of calcium or magnesium silicate. Deposition of scale on heating surfaces reduces conductivity and interferes with heat transfer. This is not so serious in multitubular boilers with economizers where the heated area is large, but can have a significant effect upon fuel consumption in Lancashire and other simple shell boilers. The greatest danger in boilers of modern design is tube failure caused by local overheating under the scale.

The best way of preventing scale is to soften the water before it enters the boiler by methods to be described later. Sometimes the use of softened water is not practical. When boilers do not operate at very high pressure, internal treatment can be effected by adding sufficient sodium carbonate to precipitate the permanent hardness as carbonates, the temporary hardness being removed automatically at the boiling point of water. The deposit formed in this way collects as an easily-removed sludge, especially when substances such as tannins or sodium silicate are added to assist in maintaining the precipitate in a state of suspension. In high-pressure-boilers sodium carbonate is hydrolysed to sodium hydroxide, and at 200 psi about 80 per cent will be converted to caustic alkali (HENDRY, *J.S.D.C.*, 1942, 154). This is no use for removal of hardness, and sodium phosphates are therefore used which are stable and which precipitate insoluble calcium or magnesium phosphates.

Corrosion **can** be a serious cause of wear in boilers if suitable waters are not used. All feed water should be just alkaline to phenolphthalein, and sufficient caustic soda to create this degree of alkalinity should be added if necessary, using a device to introduce it continuously. Dissolved oxygen in the presence of carbon dioxide is a common cause of corrosion, especially in modern high-pressure boilers. The carbon dioxide reacts with the iron, forming ferrous carbonate which, in turn, tends to hydrolyse to ferrous hydroxide :

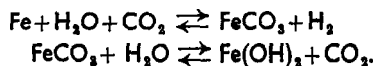

Both of these reactions are reversible and a state of equilibrium would soon be reached and the formation of ferrous hydroxide would come to an end. The oxygen, however, converts slightly-soluble ferrous into insoluble ferric hydroxide, thus removing one of the products of the reaction, disturbing the equilibrium, and allowing more iron to react with the carbon dioxide. Oxygen is removed by preheating the feed water or by a deactivating tank **in which** the water passes over iron turnings so that the corrosion can expend itself on scrap metal. Reducing agents such as sodium sulphite **or hydrazine** are also added to feed waters to remove dissolved oxygen.

Water softening

If water contains more than 5 parts per 100,000 of hardness it is generally accepted that softening is desirable. It must be borne in mind, however, that for many processes in a dyeworks hard water has no disadvantage. This applies to a greater extent now than in the past because synthetic detergents, which are stable in the presence of calcium and magnesium ions, are used to such a large extent. Softening can be quite expensive, and the use of softened water where it is unnecessary is wasteful.

Temporary hardness is removed by boiling, but this is impractical in daily use. The carbon dioxide can, however, be extracted from the bicarbonate by the action of an alkali, calcium hydroxide being the one which is commonly used. The reaction is as follows:

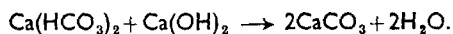

Thus the whole of the temporary hardness due to calcium is precipitated as calcium carbonate. According to the equation it follows that 100 parts of temporary hardness require 74 parts of calcium hydroxide or 56 parts of calcium oxide. The reaction follows a slightly different course with magnesium bicarbonate. The first stage is the conversion to magnesium carbonate :

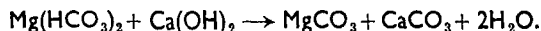

The reaction, in this case, however, does not suffice to soften the water because magnesium carbonate is sparingly soluble. A second molecule of calcium hydroxide must therefore be added to precipitate the insoluble magnesium hydroxide :

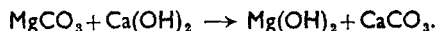

Thus, each molecule of magnesium bicarbonate present requires two of lime for complete precipitation, and every part of temporary hardness due to magnesium, expressed as calcium carbonate, requires $2 \times 56 = 112$ of quicklime (CaO). Water will often contain dissolved carbon dioxide which will combine with some of the lime added for softening:

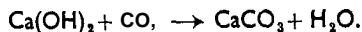

- In order to calculate the exact quantity required to remove temporary hardness, the free carbon dioxide must be known and allowed for.

Permanent hardness is removed by converting the calcium and magnesium sulphates into carbonates by the action of sodium carbonate:

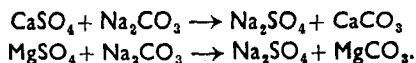

The calcium sulphate is thus removed as calcium carbonate, an equivalent quantity of sodium sulphate being left in solution. Magnesium sulphate would be converted into magnesium carbonate and this would require to

be precipitated by means of lime. If, however, enough lime be added to precipitate all the magnesium present, the magnesium sulphate is converted into calcium sulphate which, in turn, is precipitated as its carbonate:



It is apparent that in order to calculate the quantities of lime and sodium carbonate necessary for softening any given volume of hard water, we must know:

- (i) the temporary hardness;
- (ii) the hardness due to magnesium whether temporary or permanent;
- (iii) the permanent hardness; and
- (iv) the free carbon dioxide.

The calculation can then be made as in Table 8.2:

Table 8.2

<i>Caused by</i>	<i>Quicklime required*</i>	<i>Sodium carbonate required*</i>
Calcium bicarbonate	0.56	—
Magnesium bicarbonate	2×0.56	—
Magnesium sulphate	0.56	—
Calcium sulphate	—	1.06

* For each part of hardness per 100,000 of water.

If the temporary, permanent, and magnesium hardnesses are known, the following formula provides a convenient method for determining the required amounts of lime and sodium carbonate:

H_t represents temporary hardness

H_p represents permanent hardness

H_m represents hardness due to magnesium.

Then the amount of quicklime required per 100,000 gallons equals $5.6(H_t + H_m)$ lb, and dry sodium carbonate $10.6 \times H_p$ lb.

Water softeners

Water softening is carried out on an industrial scale by means of automatic apparatus. There are two kinds, namely, intermittent and continuous. In the former the water is mixed with the necessary chemicals, the precipitated hardness is allowed to settle, and the clear softened water drawn off. In the continuous form the precipitate is removed partly by gravity but chiefly by means of a filter. The essential parts of a water softener are (i) a reagent tank, (ii) a reaction tank, (iii) a precipitation tank connected generally with a filter, and (iv) a soft-water collecting tank.

The principle of their action is illustrated by the apparatus shown in Fig. 8.2. *A* is a small cistern containing a mixture of sodium hydroxide (instead of lime for experimental convenience) and sodium carbonate. This flows through a funnel into a corked reaction chamber *B*, entering at the

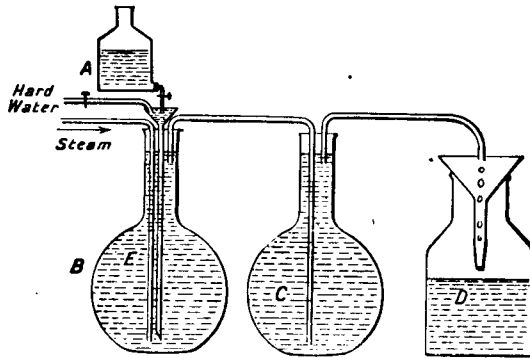

Fig. 8.2 Apparatus demonstrating principles of water softening

bottom, and at the same time becoming mixed with the hard water introduced from the main supply. The concentration of the chemicals and the rate of flow are such that in a given time the adequate quantities of the reagents are delivered to soften the water entering the reaction chamber during the same period. Through a second tube *E*, also reaching to the bottom of the flask, steam is passed to complete the mixing. A third tube, commencing just beneath the cork, leaves the flask *B* and passes to the bottom of a second corked flask *C*, which is the precipitating chamber. A second delivery tube leaves this chamber at the top, ending above a filter-paper-lined funnel leading to a storage tank *D* for the soft water.

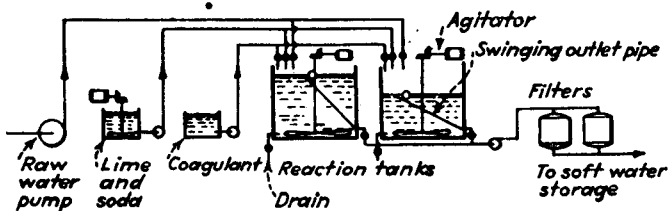

Fig. 8.3 Intermittent lime-soda softening plant

The arrangement in Fig. 8.3 (RYAN, *Water Treatment and Softening*) gives a diagrammatic representation of an intermittent lime-soda water-softening plant. The lime, soda, and coagulant are metered into the reaction tanks together with a predetermined amount of hard water. Agitation is brought

about by a large propeller. When sufficient time has elapsed for the precipitation to be complete the water passes through filters to the soft-water storage.

The principle of a simple continuous lime-soda softener is shown in Fig. 8.4 to 8.6. There are four essential features: a chemical measuring device, a reaction chamber, a settling tank, and a filter. The hard water enters through a feed pipe into one of the compartments of the tipping bucket (Fig. 8.4). When the compartment is full the centre of gravity is

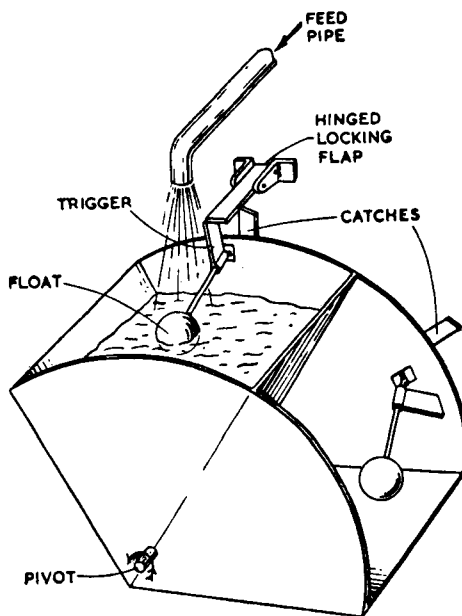

Fig. 8.4 Double-beat tipping bucket with trigger release
(Courtesy of Butterworths. From 'Industrial Water Treatment Practice' by Hamer, Jackson and Thurston)

altered, causing it to tip over and pour its contents into the softening tank (Fig. 8.5), at the same time bringing the other half of the oscillating receiver under the delivery end of the pipe. This oscillating receiver, by electrical relays, activates a dosing system which will deliver the calculated amounts of lime and soda ash for the volume of water in the bucket. The chemicals may, for example, be measured by solenoid operated double cylinders, as shown in Fig. 8.6.

The direction of the flow of the water through the softener is shown by the arrows. It emerges through a wood-wool filter, intended to catch any remaining undissolved calcium carbonate, into the soft water section from which it is withdrawn as required.

In the vertical cylindrical softener illustrated in Fig. 8.7 the water and chemicals enter at the upper end of an inverted funnel *A*, fall to the bottom,

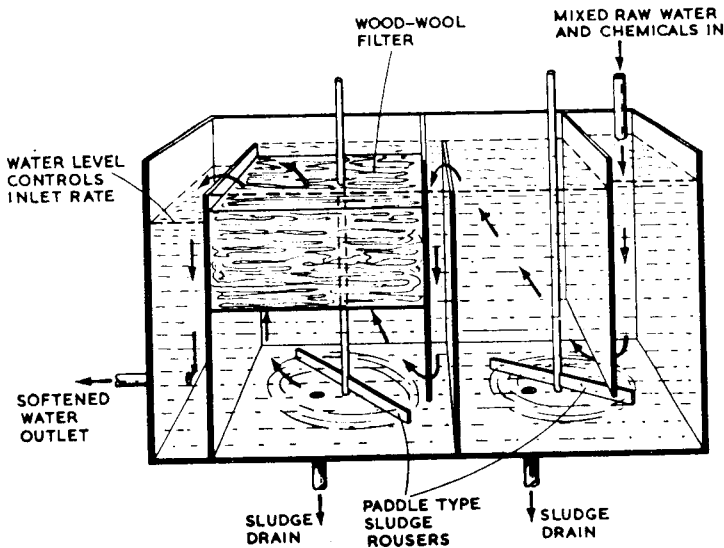

Fig. 8.5 Horizontal softening plant with sludge rousers
 (Courtesy of Butterworths. From 'Industrial Water Treatment Practice' by Hamer, Jackson and Thurston)

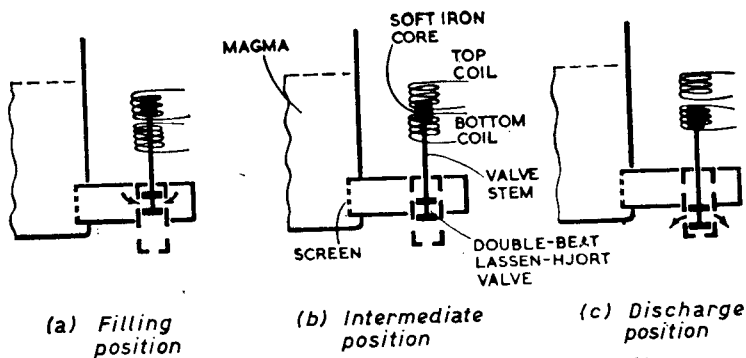

Fig. 8.6 Solenoid valve (after The Permutit Co. Ltd.)
 (Courtesy of Butterworths. From 'Industrial Water Treatment Practice' by Hamer, Jackson and Thurston)

and then rise upwards, finally passing through the filter *B* before the soft water is withdrawn at *C*.

In order to get good results with any kind of automatic water softener, it is important that the apparatus should not be worked beyond its capacity. The precipitation is not instantaneous, but gradual, and if the mixture of

hard water and chemicals passes into the apparatus too quickly it will go through the filter before precipitation is complete. The chemicals used must have a known composition and be checked by analysis. Calcium carbonate is not absolutely insoluble in water, and no process which relies upon the precipitation of this compound can therefore give a water with what is termed 'zero' hardness. A residual hardness of from 2 to 3 parts per 100,000 is the best that can be expected. It should be borne in mind

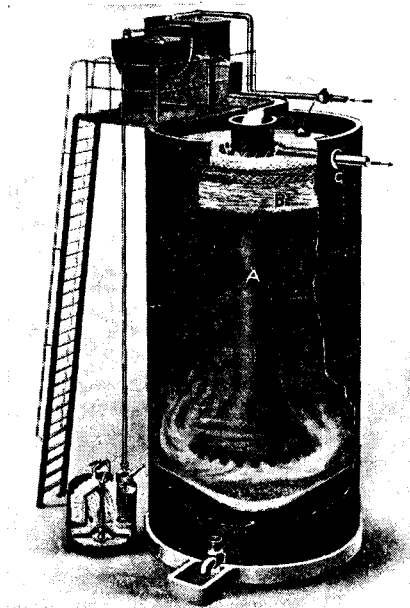
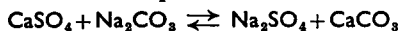

Fig. 8.7 Vertical lime-soda water-softening plant
(Courtesy of Paterson)

that when large quantities of permanent hardness have to be removed an equivalent amount of sodium sulphate is left in solution. The equation



is reversible and an excessive concentration of sodium sulphate can lead to an equilibrium with a significant quantity of unreacted calcium sulphate. With waters of high permanent-hardness content, therefore, softening by the lime-soda method will be incomplete. Magnesium hydroxide tends to form a colloidal solution which passes through the filter. This can be prevented, however, by adding 2 to 3 parts per 100,000 of sodium aluminate to the water.

Base-exchange process

This method depends upon the use of zeolite or of base-exchange complexes. The zeolites are hydrated silicates of sodium and aluminium with a

general formula $(\text{Na}_2\text{O})_x(\text{Al}_2\text{O}_3)_y(\text{SiO}_2)_z(\text{H}_2\text{O})_n$. These compounds occur naturally, or they are made artificially, and they are known as zeolites when of natural origin, or base-exchanges when prepared. When a base-exchange of the approximate composition shown above is brought into contact with ions of a bivalent metal the monovalent component is replaced according to the following equation, in which Z is an abbreviation for the $\text{Al}_2\text{O}_3\text{SiO}_2, \text{H}_2\text{O}$ part of the molecule:

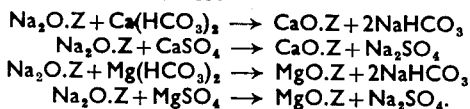

These reactions virtually go to completion, and after hard water has percolated through a bed of base-exchange it emerges with a hardness of 0.2 degree or even less. After a time the whole of the sodium in the base-exchange substance becomes replaced by calcium or magnesium; it is then said to be exhausted because it will no longer soften. It can be regenerated by treatment with a concentrated solution of sodium chloride:

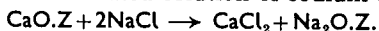

The calcium chloride and residual sodium chloride are washed away and the regenerated sodium zeolite compound can be used again. The process can be repeated almost indefinitely, subject only to the very gradual breaking down of the granules of the compound into powder.

Each water-softening unit can handle a specific volume of water before it requires regeneration. A water meter is provided which will give an indication of the approach of the exhaustion of the base-exchange. Variations in the hardness of the supply will alter the total amount of water which can be softened. Testing with soap solution is often desirable in addition to observation of the water meter. Automatic testing and regenerating equipment can now be provided. A Permutit water-softening unit is shown in Fig. 8.8. The great advantage of the base-exchange process is that it yields water of zero hardness. Temporary hardness is converted to sodium bicarbonate which, if present in excessive amount, can interfere with some dyeing processes or lead to boiler corrosion where, at high temperatures, it liberates carbon dioxide. When the source of supply is extremely hard the cost of salt is high and the lime-soda process is more economical, followed by base-exchange treatment to remove the last traces when zero hardness is required.

The sodium aluminium silicate complexes have to a great extent been replaced by resins derived from synthetic organic compounds. The first organic base-exchange material was prepared by the treatment of certain types of coal with sulphuric acid, giving a product containing sulphonic and carboxylic acid groups. These underwent the following reaction with calcium salts:

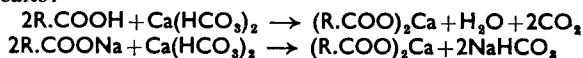

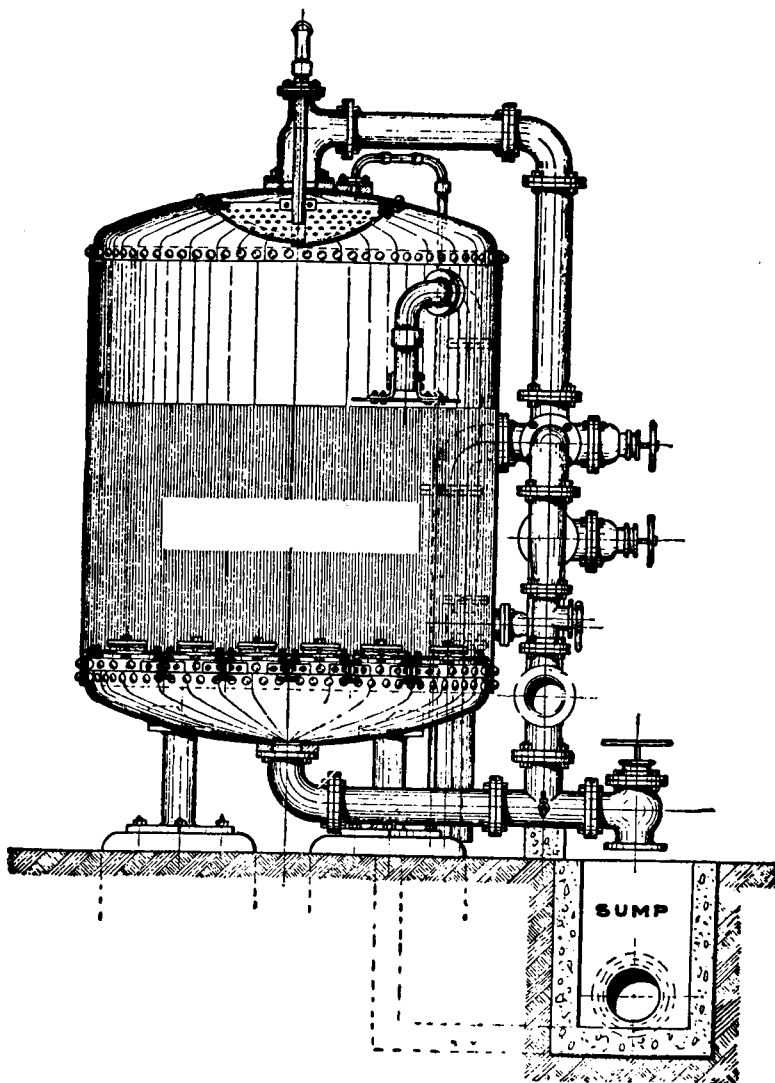
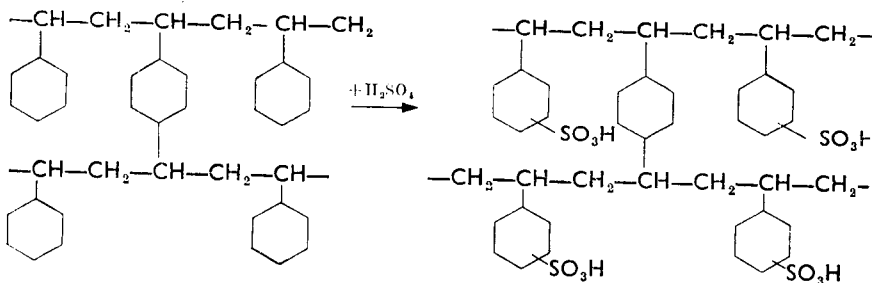

Fig. 8.8 Base-exchange water softener
(Courtesy of Permutit Ltd)

and a similar reaction takes place when carboxyl are substituted by sulphonic acid groups.

One of the most successful cation exchange resins, because of its chemical stability, is cross-linked polystyrene. It is obtained by polymerization of a suspension of styrene in water, together with a cross-linking

agent such as divinylbenzene. The polymer is produced in the form of spherical beads which are convenient for packing in the softening unit. Treatment with sulphuric acid introduces sulphonic acid groups into the cross-linked polystyrene giving, in the following manner, a product which will react with calcium salts:



Basic groups giving an anion exchange resin can be inserted by first combining with chloromethylether, in the presence of a catalyst such as aluminium chloride. The product, when treated with trimethylamine, yields a quaternary ammonium compound with basic properties such as shown below:

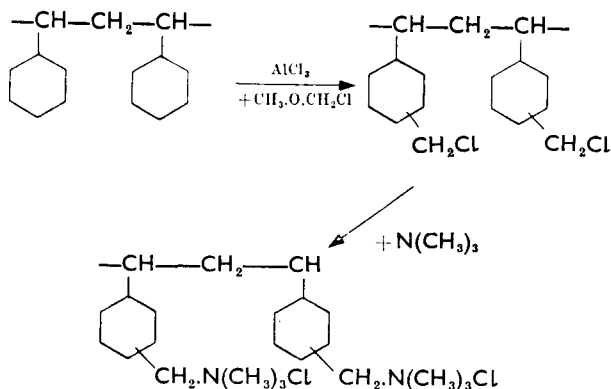

When a cation exchange resin is used a quantity of acid or sodium salts is left in the water. It is possible to obtain water free from virtually all ions by passing it successively through cation and anion exchange resins. Such treatment is more refined than is necessary for process work, but finds application for feed waters for modern high-pressure multitube boilers.

Sequestering agents

These are compounds which react with metallic ions in such a way that they become part of a complex anion. Certain phosphates possess this property, the most commonly used being sodium hexametaphosphate, also known as Calgon. The formula $\text{Na}_6\text{P}_6\text{O}_{18}$ is generally ascribed to it, although

the substance is, in fact, more complex (SUMMERSGILL, *J.S.D.C.*, 1954, 278). It is prepared by melting sodium metaphosphate and allowing it to cool rapidly to below 200°C when glass-like plates are formed. Calgon reacts with calcium or magnesium in the following way:

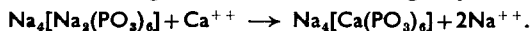

The calcium compound formed does not precipitate soaps, nor does it confer any of the other properties of hardness upon the water.

Derivatives of iminodiacetic acid, $\text{NH}(\text{CH}_2\text{COOH})_2$, are most successful sequestering agents (SUMMERSGILL, *loc. cit.*). Two compounds of this class have had commercial success, namely, nitrilo triacetic acid, $\text{N}(\text{CH}_2\text{COOH})_3$, and ethylenediaminetetra-acetic acid, $(\text{COOH}\cdot\text{CH}_2)_2\text{N}\cdot\text{CH}_2\cdot\text{CH}_2\cdot\text{N}(\text{CH}_2\text{COOH})_2$. Ethylenediaminetetra-acetic acid, often abbreviated to E.D.T.A., has virtually displaced nitrilo triacetic acid because the complexes which it makes with metallic ions are more stable. The nature of the complex molecules are shown below:

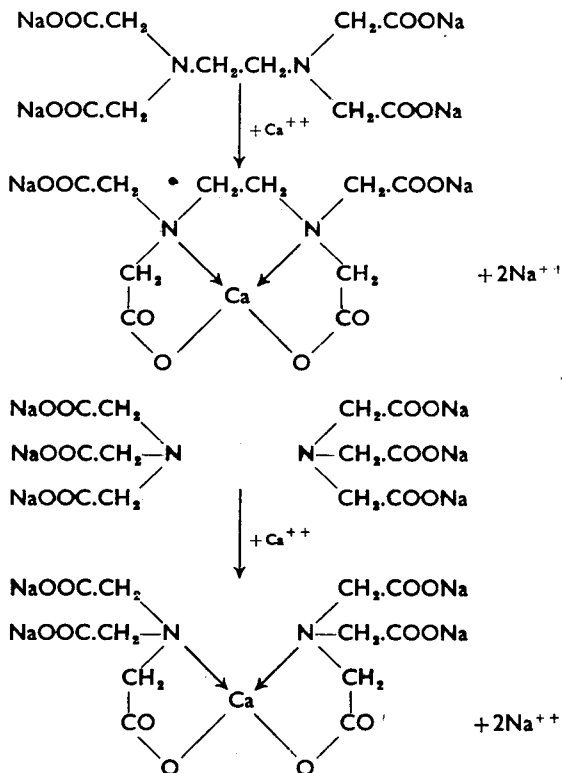

This type of ring-structure formation is referred to as chelation and is manifested by what are called chelating compounds. Sequestering agents

can be used to soften hard water. They are not a substitute for **softening** where large quantities are involved but are useful when soft water is required occasionally in small quantities. Calgon is often added to **wool-scouring** liquors, and E.D.T.A. is used with **success** in dyeing where there is a risk that traces of iron or other metallic contamination might cause flattening of the shade.

Determination of hardness

Total hardness is the factor which is most commonly required in routine testing. The simplest method is based on titration with a standard soap solution which depends upon the reaction:

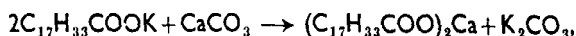

from which it follows that 2 x 282 g of oleic acid are equivalent to 100 g of calcium carbonate. Hence, 1 ml of a solution containing 5.64 g of oleic acid per litre would precipitate $\frac{100 \times 5.64}{1000 \times 2 \times 282} = 0.001$ g of hardness expressed as calcium carbonate.

To prepare a standard soap solution, about 57 g of pure oleic acid are dissolved in 300 ml of alcohol and made neutral to phenolphthalein by stirring in a concentrated solution of potassium hydroxide till a pink colour appears, which is finally discharged by the addition of just enough oleic acid. The solution is then diluted to 1 litre with a mixture of two volumes of alcohol to one volume of water. The standard solution is made by diluting 100 ml of this stock solution to 1 litre with a mixture of alcohol and water (2:1). The soap solution is standardized against calcium chloride. One gram of Iceland spar or pure calcium carbonate is dissolved in hydrochloric acid. The solution is evaporated to dryness on a water-bath, the residue dissolved in water, and again evaporated to dryness to expel the last traces of hydrochloric acid. The remaining calcium chloride is dissolved in water and made up to 1 litre. To standardize the soap, 10 ml of the calcium chloride solution are pipetted into a stoppered bottle of about 150 ml capacity, and 40 ml of distilled water are added. The soap solution is run into the bottle from a burette, at first about 1 ml at a time, the stopper being replaced after each addition and the contents of the bottle well shaken. When the first indications of a foam or lather are observed, the soap solution is added cautiously, a few drops at a time. After each addition the bottle, after shaking, is laid on its side and the lather is observed carefully. If it disappears rapidly more soap solution is required. The end point of the titration is the formation of a foam or lather which remains for at least one minute when the bottle is laid on its side. Since 10 ml of the standard calcium chloride solution equals 0.01 g of calcium carbonate, the value of the soap solution in terms of calcium carbonate can be calculated.

Soap solution is used, generally, to determine total hardness only. In

order to obtain consistent results certain points must be noted. In the first place the volume of the water tested should always be the same. Secondly, when more than 10 ml of the soap solution are required to produce a lather, the results may become inaccurate owing to the interference of insoluble calcium and magnesium soaps. When the property of the water is totally unknown a preliminary rough titration is recommended. Then a calculation can be made of the dilution of the sample with distilled water necessary to ensure that 50 ml will require about 10 ml of soap solution.

Permanent hardness may be determined in the following manner. A quantity of the water measuring 100 ml is boiled gently for 45 minutes, cooled, and made up to its original volume with cold carbon-dioxide-free water. After mixing well, the precipitated temporary hardness is removed by filtration, and the permanent hardness determined in the filtrate by titration with soap solution. The temporary hardness will be the difference between the total and the permanent hardnesses.

Soap solutions do not give results with the highest degree of accuracy but have the great advantage that, apart from the preparation of the solution, testing only requires a bottle and a burette, or even a drop bottle, and this can be carried out anywhere in the works by operators with only elementary scientific training. There are methods giving results of greater accuracy more suitable for use in laboratories. Temporary hardness may be determined by titrating 100 ml of the water with $N/10$ hydrochloric acid, using methyl orange as the indicator. The titration is usually carried out in a large porcelain evaporation dish, which makes the end point more visible, if modern electrometric titration apparatus is not available. Methyl orange is chosen because it is not sensitive to the carbon dioxide liberated during the conversion of the bicarbonates to chlorides. Bromophenol blue, which changes from yellow to bluish-purple between pH 2.8 and 4.6 can also be used. For accurate work with this indicator a comparator with a standard disc or cell showing the colour at pH 3.7 is recommended: the end point of the titration being reached when the colour matches the standard. One ml of $N/10$ hydrochloric acid is equal to 0.005 g of calcium carbonate.

Permanent hardness is estimated by evaporating 100 ml of the sample to dryness on a water-bath with a known volume of $N/10$ sodium carbonate solution. The residue is extracted with freshly boiled hot distilled water, and is separated from the insoluble residue of calcium carbonate by filtration. The filter paper is washed four times with hot distilled water and then the filtrate together with the washings are cooled and titrated with $N/10$ hydrochloric acid in the presence of methyl orange. Each ml of $N/10$ sodium carbonate which has disappeared corresponds with 0.005 g of permanent hardness expressed as calcium carbonate. (For further information see S. R. and E. R. TROTMAN, *Textile Analysis*.)

Schwarzenbach and others (*Helv. Chim. Acta.*, 29, 811) describe the use of ethylenediaminetetra-acetic acid for the determination of both tem-

- and is often abbreviated to P.V. This is also known as the chemical oxygen demand (abbreviated to C.O.D.).
- (ii) The Biochemical Oxygen Demand (abbreviated to B.O.D.) which represents the amount of organic matter oxidizable by the micro-organisms in the presence of oxygen.
 - (iii) The suspended solids.
 - (iv) Acidity or alkalinity (pH).

Chemical oxygen demand. In order to determine the permanganate value samples of the water amounting to between 10 and 100 ml according to the degree of pollution are pipetted into a stoppered bottle, and 15 ml of 25 per cent sulphuric acid and 50 ml of $N/80$ potassium permanganate are added. The volume is made up to 160 ml with distilled water and the contents maintained at $26.7^{\circ}C$ for four hours. The bottle and its contents are then rapidly cooled, potassium iodide is added and the liberated iodine is titrated with standardized sodium thiosulphate solution. Each ml of $N/80$ permanganate consumed is equivalent to 1 mg of oxygen. A permanganate value of 10 parts per million would correspond with a good effluent and the figure should not exceed 15 parts per million for water to be discharged into inland rivers or streams.

Biochemical oxygen demand. Under natural conditions the oxygen absorbed by bacteria is replaced by fresh dissolved oxygen derived from the air. The true measure of the impurity of an effluent is its ability to provide nourishment for the survival of micro-organisms. The total amount of oxygen absorbed over a period of five days at a temperature at which bacteria can breed is a very good pragmatic measure of the objectionable nature of the effluent. This is measured by estimating the biochemical oxygen demand.

Basically B.O.D. is determined by estimating the dissolved oxygen in the water both before and after incubation at $18.3^{\circ}C$ for five days. A measured quantity of the sample under investigation is diluted with well-oxygenated water so that not more than 50 per cent of the oxygen present will have been absorbed at the end of five days at $18.3^{\circ}C$. The normal procedure is that two bottles of suitable capacity are completely filled with a diluted sample and stoppered up in such a manner that there are no air bubbles. In one of the bottles the dissolved oxygen is determined at once and in the other after incubation for five days. The difference between the two results multiplied by the dilution factor gives the B.O.D.

Determination of dissolved oxygen. A stoppered bottle of about 250 ml capacity is nearly filled with the water under investigation and 1 ml of a saturated solution of manganese chloride is added, being introduced by a pipette reaching nearly to the bottom of the bottle. One ml of a 33 per cent solution of sodium hydroxide containing 10 per cent of potassium iodide is introduced in the same way. The stopper is replaced and the contents are mixed. Before replacing the stopper it is important that the

volume of water and added reagents should be sufficient to leave no air bubbles at the top. After mixing, the contents of the bottle is acidified with hydrochloric acid and the liberated iodine is titrated with centinormal sodium thiosulphate (1 ml = 0.00008 g of oxygen).

Suspended solids. The sample of water under investigation is shaken well and 250 ml are decanted before the sediment has had time to settle. This is filtered through a Gooch crucible and the residue dried and weighed.

Purification of effluents

The removal of impurities from effluents is a specialized subject and only a brief survey is justified in the present context. The permissible degree of pollution acceptable for discharge into either sewers or rivers varies from one locality to another. As a guide the old Royal Commission standard specified a maximum of 30 ppm of suspended matter and 20 ppm of B.O.D. It may well be that river authorities will require higher standards than this such as, for example, 20 ppm of suspended solids and 15 ppm of B.O.D.

Effluents from dyeworks are liable to undergo great fluctuations in temperature and composition and no purification system could deal effectively with such fluctuations. It is therefore necessary to have a preliminary storage tank in which the discharges can be mixed before feeding them at constant rate into the purification unit. During storage there will be considerable settling of the suspended matter and this can be assisted by the addition of coagulants such as ferrous, ferric and aluminium salts. It may also be necessary to add either acid or alkali to bring the pH to within the range of 5.5 to 7.

It is unusual for the suspended matter to separate completely in the storage tank and some form of filtration will be desirable. The filtrate will contain the soluble organic matter which can be converted into carbon dioxide, water and nitrates by the action of micro-organisms. To sustain the life of the micro-organisms the presence of nitrogen and phosphorous is necessary and many effluents are deficient in these elements, making the addition of some ammonium phosphate necessary.

One method of biochemical purification is to allow the water to percolate through beds of an inert material such as coke, slag or granite on which the active bacteria and protozoa can form colonies. An alternative is the activated sludge system in which the micro-organisms are cultivated in a sludge which is intimately mixed with the effluent. An abundant supply of oxygen is necessary which is provided by the large surface in contact with the air in the percolating filter system and by artificial aeration in the activated sludge process.

Synthetic detergents. Soaps are precipitated by the calcium and magnesium salt present in rivers or natural waters, but this does not apply to the synthetic detergents. The result has been that they are discharged without

modification into the rivers and have caused acute foam problems at weirs and other places where the water becomes turbulent. An investigation into the behaviour of alkyl benzene sulphonates revealed that those with branched chain substituents, unlike their straight chain equivalents, were resistant to biochemical degradation. During the last few years the elimination of the compounds containing branched chains in domestic detergents has brought about a great improvement in the foaming problem. The non-ionic surface active compounds do not undergo biochemical degradation but in themselves have no significant undesirable properties. It does appear, however, that they enhance the foaming of traces of anionic detergents.

The effluents from raw wool scouring units present a special problem because of the very high proportion of wool wax which they contain. After a dwell period in a settling tank to allow the solid dirt to sink to the bottom, the supernatant suspension of wool wax in soap is transferred to wooden vats where the pH is brought to about 3.5 by the addition of sulphuric acid. This decomposes the soap liberating free fatty acids accompanied by the breakdown of the emulsion of wool wax. The fatty acids and the wax float to the surface, together with any residual suspended matter which has not already settled out. This floating layer is skimmed off and the wool wax, which is not without commercial value, is frequently separated. An alternative is to collect the wax in a centrifugal separator. Because of their stability towards acids the synthetic detergents make the treatment of raw wool scouring effluents more difficult. It is however possible to break down the suspension when secondary alkyl sulphates are used if the liquor is cooled to about 25°C. The addition of a small proportion of soap to the synthetic detergent scouring liquor makes separation on acidification much more effective. It has also been found that there is an improvement in the removal of the wool wax from the effluent on acid cracking if aluminoferric be added before acidification.

9 · Detergents and scouring

NATURAL fibres contain oils, fats, and waxes, together with other impurities. Garments, fabrics, or yarns may contain oil and adventitious dirt collected during manufacturing. The term scouring applies to the removal of these impurities.

A brief description of the properties of oils, fats, and waxes is necessary, not only for an understanding of the chemistry of the processes by which they are removed but also for an acquaintance with the composition of soaps which are the basic scouring agents or detergents. Fats are derived from the trihydric alcohol glycerol:

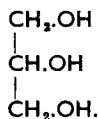

When the three hydroxyl groups are esterified with fatty acids of high molecular weight the compound which is formed is a fat. The fatty acids which are commonly found in natural products are

Palmitic acid	$\text{C}_{15}\text{H}_{31}\text{.COOH}$	(saturated)
Stearic acid	$\text{C}_{17}\text{H}_{35}\text{.COOH}$	(saturated)
Oleic acid	$\text{C}_{17}\text{H}_{33}\text{.COOH}$	(unsaturated).

The three corresponding esters or fats are: tripalmitin, tristearin, and triolein, the general structural formula being:

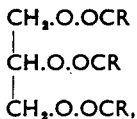

in which R may be $\text{C}_{15}\text{H}_{31}$, $\text{C}_{17}\text{H}_{35}$, or $\text{C}_{17}\text{H}_{33}$. Tripalmitin and tristearin are solid at ordinary temperature, but triolein is liquid. Most natural fats are mixtures, and whether they are solids or liquids depends upon the relative proportions of those with high and low melting points. Small quantities of other glycerides (fatty acid esters of glycerol) may also be found in fats. Butter, for example, contains tributyrin, $\text{CH}_2(\text{OOC.C}_3\text{H}_7)\text{CH}(\text{OOC.C}_3\text{H}_7)\text{.CH}_2(\text{OOC.C}_3\text{H}_7)$, and castor oil contains glycerol esterified with ricinoleic acid, $\text{C}_{17}\text{H}_{33}(\text{OH}).\text{COOH}$. Lauric and myristic acids are found in coconut oil to the extent of about 45 and 15 per cent respectively. When oils or fats are heated with a solution of sodium or potassium hydroxide they are hydrolysed into glycerol and the alkali salt of the fatty acid. The sodium or potassium salts of the fatty acids are

soaps, and this particular hydrolysis is therefore referred to as saponification.

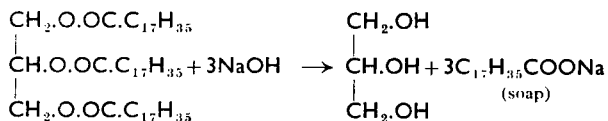

Waxes are compounds formed by the esterification of fatty acids and complex monohydric alcohols with relatively high melting points. Alcohols found in waxes are:

Cetyl alcohol	$\text{C}_{16}\text{H}_{33}\text{OH}$	M.P. 50°C	found in spermaceti wax
Messityl alcohol	$\text{C}_{30}\text{H}_{61}\text{OH}$	M.P. 88°C	found in beeswax
Ceryl alcohol	$\text{C}_{26}\text{H}_{53}\text{OH}$	M.P. 79°C	found in Chinese wax
Carnaubyl alcohol	$\text{C}_{24}\text{H}_{48}(\text{OH})_2$	M.P. 103°C	found in Carnauba wax.

Waxes are considerably more resistant to saponification than fats, and can only be hydrolysed with aqueous solutions of alkalis under pressure, or at atmospheric pressure after prolonged boiling with alcoholic potash.

Paraffin wax is not a true wax but a high-molecular-weight saturated hydrocarbon obtained from natural oil. It does not hydrolyse into simpler compounds when heated with solutions of alkalis, and it is therefore called an unsaponifiable wax.

Oils, fats, and waxes are all insoluble in water; most of them, however, dissolve in organic solvents such as chloroform, ether, petrol, benzene, or the chlorinated hydrocarbons. They also form emulsions of varying degrees of stability when shaken with water containing soap or other emulsifying agents. Fats and related substances can be removed from textiles by three methods:

- (i) by saponification when the fibre is not damaged by alkalis, as in the case of cotton;
- (ii) by emulsification with soap or some other surface active compound; and
- (iii) by extraction with an organic solvent.

Sometimes two of the methods are used simultaneously as, for example, scouring with a mixture of a detergent and an organic solvent such as toluene or a chlorinated hydrocarbon.

Palmitic and stearic acids are derivatives of the paraffin series of hydrocarbons and therefore are saturated. Oleic acid is unsaturated, having the structure represented by $\text{CH}_3(\text{CH}_2)_7\text{CH}=\text{CH}(\text{CH}_2)_7\text{COOH}$. When reduced with hydrogen in the presence of a catalyst it is converted to stearic acid. Unsaturated fatty acids are readily oxidized to dihydroxy compounds:

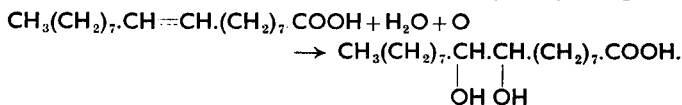

Oils containing large proportions of unsaturated fatty acids tend to become rancid on storage. Prolonged action of oxygen in the presence of moisture, especially at higher temperatures, oxidizes them through the hydroxy compounds to ketones which are not without odour.

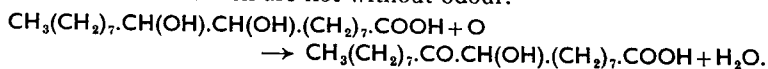

The combined effect of oxidation and saponification by enzymes can liberate glycerol and convert it to acrolein, $\text{CH}_2=\text{CH}\cdot\text{CHO}$, which is the main source of the smell associated with rancidity.

Unsaturated oils, on prolonged exposure to air, also undergo complex reactions accompanied by the development of a yellow colour and polymerization. It has been suggested that oxygen is added at the double bond to form a peroxide of the type $-\text{CH}-\text{CH}-$,



posals the first product of oxidation is a structure of the type $-\text{CH}_2-\text{CH}=\text{CH}\cdot\text{CH}-\text{CH}_2-$. Whatever the intermediate products may



be, oxidation at the double bond can lead to the formation of diketone groups

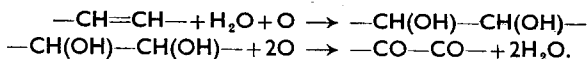

It is believed that fatty acids containing two or more carbonyl groups in pairs are responsible for the yellow discoloration which appears when unsaturated oils are exposed to the air over prolonged periods. Exposure also hardens unsaturated oils, rendering them extremely difficult to remove during scouring. There are many ways in which polymerization accompanied by hardening could take place, and one of the simplest examples is expressed as follows:

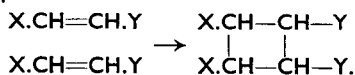

Soaps

A soap is a metallic salt of a saturated or an unsaturated higher fatty acid. There may be lead, calcium, magnesium or other metallic soaps, but in practice the only ones which are used as detergents are those containing sodium or potassium. Soap is made on a commercial scale by boiling natural oils or fats with aqueous solutions of sodium or potassium hydroxide, when the following reaction takes place:

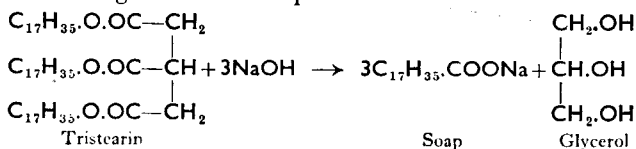

Sodium soaps are sparingly soluble in strong sodium chloride solutions. The mixture of soap and glycerol in aqueous solution obtained by saponification is therefore saturated with common salt when the soap is precipitated, and rises to the surface where it can be skimmed off. It is washed with cold water to remove occluded salt solution or excess of alkali, and is cast into cakes or bars and dried. The liquor is evaporated under reduced pressure and the glycerol is recovered by distillation; the sodium chloride crystallizes out in the still when it is available for use again. Potassium soaps are not easily separated from the glycerol because addition of sodium chloride causes precipitation of the sodium salt of the fatty acid:

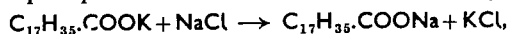

and although potassium chloride could be used it would be much too expensive in practice. The glycerol is, therefore, not separated, and its presence makes the potassium fatty acid salts into soft soaps. Oils which are used in soap manufacture are:

Cotton seed oil	Soya bean oil
Tallow	Bone fats
Coconut oil	Palm oil
Olive oil	Groundnut oil.

Stearin and olein, which are crude stearic and oleic acids obtained by hydrolysis of oils with water at about 270°C, may also be used.

Properties of soaps

Both sodium and potassium soaps are sparingly soluble in cold water but dissolve readily at higher temperatures. When a hot concentrated solution of soap is cooled, the latter does not crystallize out as an inorganic salt would, but forms a jelly which melts again on warming. This fact, supported by other physical factors, indicates that soap solutions are colloidal in nature. Soap dissolves in hot alcohol but is only sparingly soluble in other organic solvents such as acetone, ether, or petroleum. Coconut-oil and palm-oil sodium soaps require much more salt to precipitate them than others, and are therefore used as marine soaps because they will give a lather with sea water. Soaps are decomposed by acids with the liberation of free fatty acids:



If hydrochloric acid is added to an aqueous solution of soap at low temperatures until the mixture turns methyl orange red, the whole of the fatty acid present will be liberated in the form of a colloidal or flaky precipitate. If the mixture be heated the fatty acid melts and rises to the surface, forming a clear oily layer.

Aqueous solutions of soap have an alkaline reaction due to hydrolysis. In extremely dilute solutions soap ionizes:



but hydrolysis also takes place as follows:

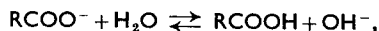

so that RCOO^- , OH^- , and Na^+ ions can be present at the same time together with RCOONa and RCOOH molecules. Soap and free fatty acid molecules can also become associated to form what are known as acid soaps:



The relative proportions of the various ions and molecules which are in equilibrium will depend upon the dilution of the solution and the nature

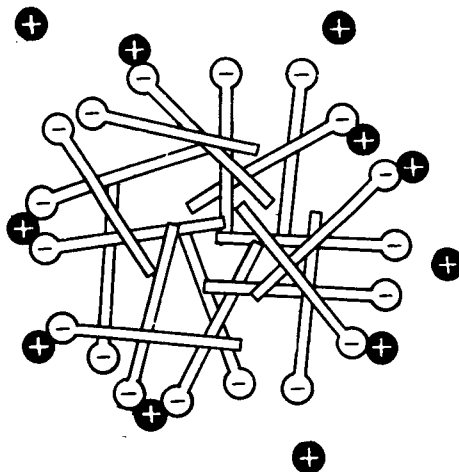

Fig. 9.1 Micelle of soap molecules
(Courtesy of NIVEN, 'Fundamentals of Detergency')

of the fatty acid combined with the alkali metal. At about 0.01N concentration ionic micelles make their appearance. These are spherical aggregates of long-chain anions with a smaller number of detached cations (gegenions) in adjacent positions, leaving a system with a nett negative charge. Such a micelle is represented diagrammatically in Fig. 9.1, the stalk-like structures with round heads symbolizing long-chain fatty acid ions with electronegative $-\text{COO}^-$ groups at the spherical end. In soap solutions of concentrations above 5 per cent there is evidence, derived from X-ray diffraction diagrams, that lamellar or sheet-like uncharged micelles replace the globular structures. They are formed of oriented RCOONa molecules arranged with all the $-\text{COONa}$ or $-\text{CH}_2$ groups occupying adjacent planes (see Fig. 9.2). A soap solution, therefore, is an extremely complicated structure and its effectiveness as a detergent will be influenced to a marked degree by the nature of the fatty acid and the conditions of temperature and concentrations in which it is to be used.

Detergency is closely bound up with surface tension, and a brief explanation of this phenomenon is therefore desirable. In Fig. 9.3 the circles represent molecules in a liquid contained in a vessel. Those in the bulk of the liquid are attracted equally in all directions by adjacent molecules.

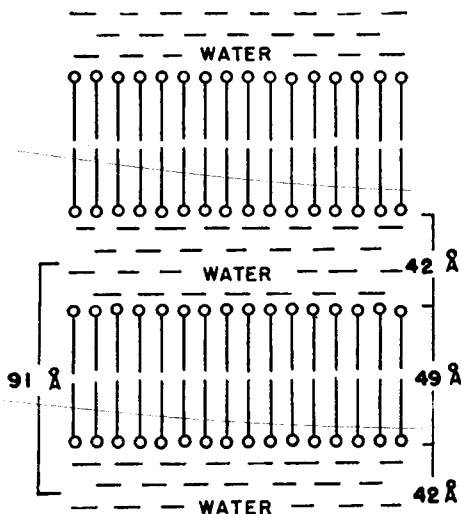

Fig. 9.2 Laminar micelles

(Courtesy of NIVEN, 'Fundamentals of Detergency')

Those which constitute the surface layer, however, are not attracted equally in all directions and the stronger lateral forces create a state of tension. A

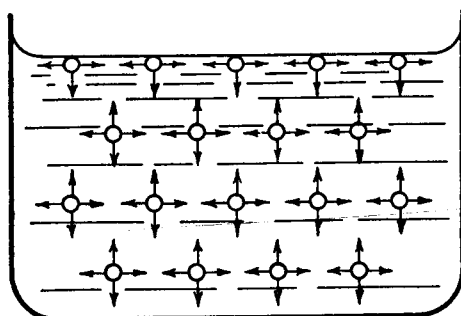

Fig. 9.3 Forces acting on molecules in a liquid

(Courtesy of NIVEN, 'Fundamentals of Detergency')

drop of liquid therefore always tends to assume a spherical shape because this gives the least surface in relation to weight that it is possible to achieve.

Molecules of soap may be looked upon as being composed of hydrophylic,

or water-seeking, heads and hydrophobic, or water-avoiding, tails:

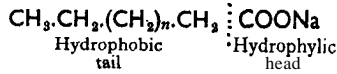

Soap is a surface-active compound, which means that in an aqueous solution the molecules will not be distributed uniformly throughout the solvent but will tend to congregate at the surface. The hydrophobic tails will be repelled by the water and soap molecules will therefore tend to arrange themselves with their hydrophilic heads immersed and their tails emerging.

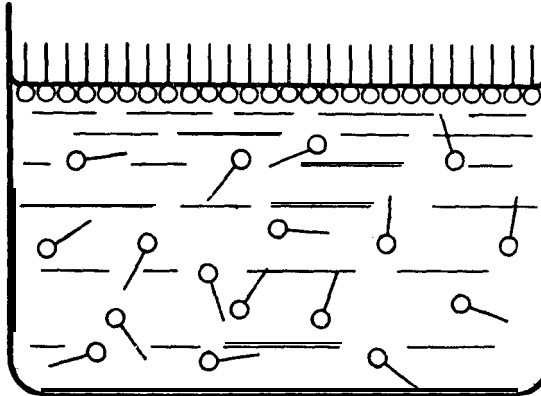

Fig. 9.4 Idealized representation of positive adsorption and selective orientation of detergent molecules in a water surface

(Courtesy of NIVEN, 'Fundamentals of Detergency')

The only place where this is possible is at the interface where a reduction in surface tension will be caused by the tendency for hydrocarbon chains to move away from the water phase, creating a force in a direction opposite to the inward pull on the water molecules. Moilliet and Collie (*Surface Activity*, Spon, London, 1951) suggest that the surface active molecule or ion can be looked upon as a bridge between the two phases making the transition between them less abrupt. Another factor to be taken into consideration is that the crowding together of molecules at the interface gives a closely packed boundary layer offering resistance to the liability of the surface to diminish in area. Soap is a surface-active compound which tends to lower surface tension at boundaries between water and air or oily substances. When the fatty acid component of the soap is of low molecular weight the hydrophilic head can pull the hydrophobic tail into the water, but as the number of carbon atoms increases this is no longer possible. The lowest number of carbon atoms necessary to manifest surface activity is 6 in the caproates ($\text{CH}_3(\text{CH}_2)_4\text{.COONa}$) but the lowest in the series, which can be classified as good detergents, are the laurates ($\text{CH}_3(\text{CH}_2)_{10}\text{.COONa}$).

Oil and water will always separate into two layers. If soap be added the paraffin tails seek the oil and the hydrophylic heads remain in the water

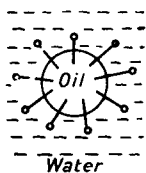

Fig. 9.5 Orientation of surface active molecules at oil drop/water interface

(see Fig. 9.5). The surface tension at the oil/water interface is high, therefore the oil will not form dispersible droplets or, in other words, emulsify because this would cause a very great increase in the interfacial surface. Soap reduces this surface tension and allows the oil to form a comparatively stable emulsion in water, a phenomenon which is the fundamental basis for the removal of oil by scouring.

The measurement of the surface tension between oil drops, textile fibres, and solutions of detergents was first described by Adam (*J.S.D.C.*, 1937, 121). The apparatus is illustrated in Fig. 9.6. The fibre is held between clips attached to a pair of adjustable arms *A* which are tightened or loosened by the screw *B*. The fibre holder is attached by means of a wire *C* to a brass ring *D* which can be rotated in a vertical plane. The whole can be lowered, by the manipulating screw

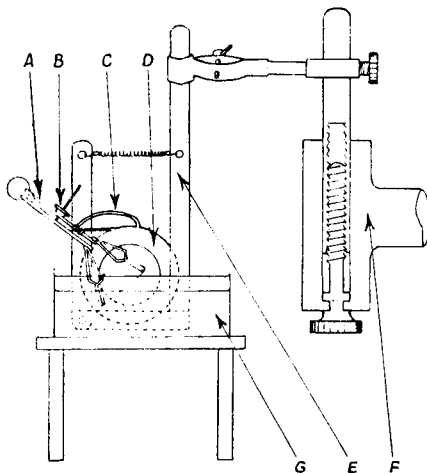

Fig. 9.6 Adam's apparatus for observation of fibre/oil interfaces

F, into a transparent glass cell so that the fibre can be studied through a horizontally mounted microscope. In this way it is possible to make visual or photographic observations of the behaviour of oil on fibres in solutions of various surface-active compounds. In Fig. 9.7 a drop of liquid resting on a solid surface is represented. Different forces will be acting upon the molecules according to the positions which they occupy in the drop. At the centre of the drop (*A*) molecules will be attracted equally in all directions. At (*B*) they will be attracted laterally and inwardly by adjacent simi-

lar molecules, and outwardly only by the highly-dispersed molecules of the atmospheric gases and traces of the substance composing the drop which have volatilized. There is, therefore, strong surface tension at this point,

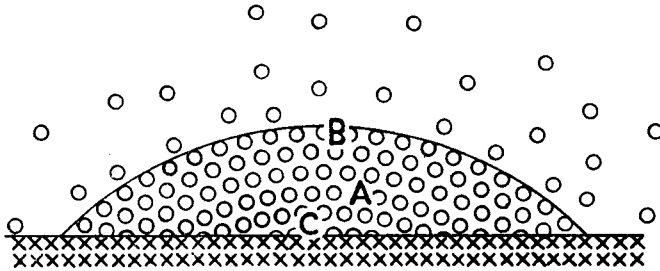

Fig. 9.7

(Courtesy of 'Hexagon digest')

tending to cause the globule to assume a spherical configuration in the direction of C; however, the surface tension is much less than towards B because the molecules of the solid substrate are creating a downward-attractive force. The resultant effect of all these forces is that the drop takes a shape which is roughly semi-spherical or even a smaller segment of a sphere.

The contact angle θ in Fig. 9.8 is measured between the surface and the

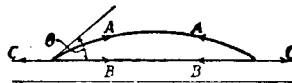

Fig. 9.8 Contact angle

tangent of the boundary of the drop at its point of contact with the surface. This angle is an expression of the resultant of:

- (i) T_1 which operates in the direction A and is the surface tension between the drop and air or, in the case of an immersed fibre, the surrounding liquid;
- (ii) $T_{1.S}$ which acts in the direction of the arrow B and is the surface tension between the fibre and the drop; and
- (iii) T_S operating in the direction C and is the surface tension between the fibre and the solution.

T_S is very high so that the area of contact between the fibre and solution will tend to contract and will encourage the oil to spread and form a lenticular deposit and θ will approach 180° .

Young's equation expresses the relationship between these forces in the following manner:

$$\cos \theta = \frac{T_S - T_{1.S}}{T_1}$$

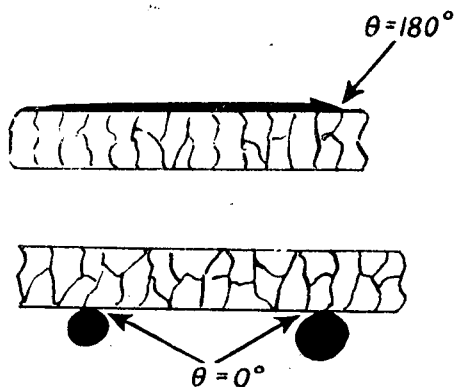

Fig. 9.9 Contact angles at oil/fibre interface
(Courtesy of ADAM, 'J.S.D.C.', 1957)

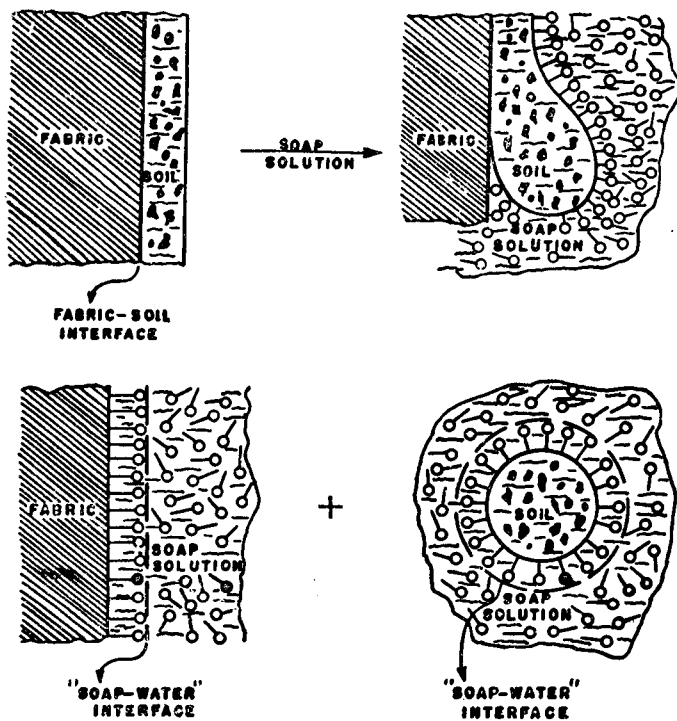

Fig. 9.10 Mechanism of detergency
(Courtesy of NIVEN, 'Fundamentals of Detergency')

For perfect wetting of the fibre, θ must be zero so that

$$\frac{T_S - T_{1,S}}{T_1} = \cos 0^\circ = 1.$$

Therefore $T_S - T_{1,S} = T_1$.

This means that if θ is less than 90° the oil will tend to spread over the fibre and adhere to it, but if θ is greater than 90° the oil will tend to form globules which are easily detached from the fibre. Extreme cases are shown in Fig. 9.9 in which, when θ is virtually equal to 180° , the oil (shown in heavy black shading) forms a firmly-held film, and when θ is practically 0° , the oil has gathered into droplets which can be detached with great ease when agitation is applied.

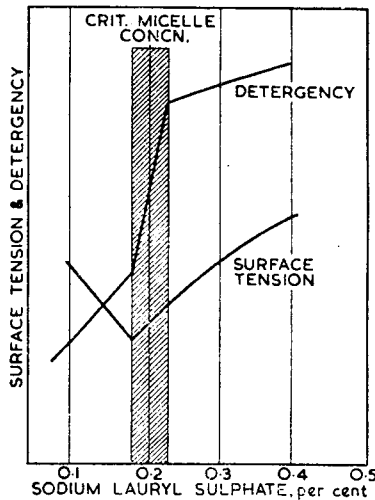

Fig. 9.11 Relationship between detergency, surface tension, and critical micelle concentration
 (Courtesy of the Society of Chemical Industry)

The effect of adding soap or other detergents is that the surface-active molecules will congregate at the oil/fibre (T_S) and even more at the oil/water ($T_{1,S}$) interfaces, thus reducing the values of $\frac{T_S - T_{1,S}}{T_1}$, which is equivalent to a decrease in θ . Adventitious dirt usually adheres to the fibre because the oil acts as an adhesive towards it. When the oil becomes dispersed as droplets the dirt falls away or is usually held in suspension within the droplets. The mechanism of the removal of soil is illustrated diagrammatically in Fig. 9.10.

It is important that the emulsion of oil and dirt should be stable, otherwise there will be redeposition on the fibre. The suspended soil particle with its sheath of oriented soap molecules assumes a nett negative charge

similar to the globular micelle of soap. Textile fibres also take up a negative charge when immersed in water. Electrostatic repulsion between the particles and the fabric probably play the major part in preventing redeposition.

The mechanism of detachment of spherical globules is undoubtedly applicable when the soil is composed essentially of non-polar mineral oil. Lawrence and others (*J.S.C.I.*, 1961, 1764, also *Surface Activity and Detergency*, Durham, Macmillan) suggest that very often the dirt is polar and that detergency then consists of penetration of soap and water into the dirt followed by dispersion. Briefly, it is suggested that at the immediate surface of the dirt particle a phase is formed in which water is in suspension in a mixture of the polar dirt and soap. This is surrounded by a membrane in which the continuous phase is water holding in suspension micelles containing molecules of soap and the polar dirt. Penetration of the surrounding solution of the detergent in water through the membrane forces out projecting cylindrical (mylenic) tubes which become dispersed in the detergent solution (see *Textile Scouring and Bleaching*, Trotman, Griffin).

A most important consideration in scouring is the 'critical concentration'. The graphs in Fig. 9.11 show how the physical properties of solutions of the surface-active compound lauryl sulphate change abruptly between 0.15 and 0.25 per cent concentration. The curve labelled 'detergency' has the most practical importance; a concentration of less than 0.15 per cent will not give the most effective scouring, and concentrations in excess of 0.25 per cent are a waste of detergent. Whilst the length of the hydrophobic tail has considerable influence on the value of the critical concentration range, the nature of the hydrophilic head seems to be comparatively unimportant.

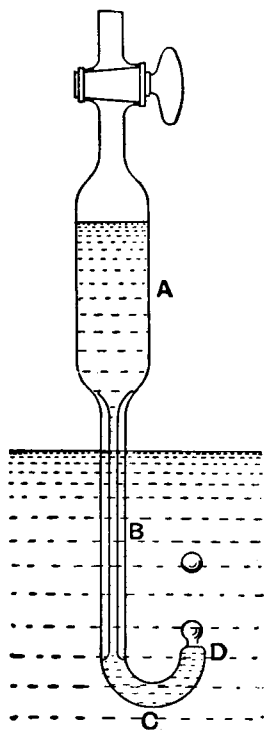

Fig. 9.12 Drop number apparatus

Measurement of emulsifying power

From the foregoing considerations it will be apparent that the lower the surface tension at the oil/water interface, the smaller will be the size of the drops of oil formed in an emulsion.

Donnan's drop-number method is a simple and convenient means of determining or comparing oil/detergent solution interfacial surface tension. The apparatus is shown in Fig. 9.12, in which a pipette *A* of about 5 ml capacity is provided with a capillary tube *B*

leading to a bend *C*. The tube terminates at *D* with an end which is ground down to a smooth flat surface. The pipette is filled with an oil, such as light petroleum, and the outlet *D* is submerged in a solution of the surface-active compound to be tested. When the tap is opened the size of the drop which issues will be determined by the difference in specific gravity between the two liquids and the surface tension acting upon the drop as it emerges. The number of drops which are formed in a unit of time is a measure of the interfacial tension, and therefore of the emulsifying power, of the solute.

If m = mass of one drop
 g = gravity
 K = constant for a given tube (for all liquids)
 R = radius of the drop (assumed to be constant)
 S = surface tension in cgs units (dynes)
 V = volume of liquid run out
 d = density of liquid
 n = number of drops

Then $m = \frac{Vd}{n}$ and $\frac{Vdg}{n} = KRS$

Hence $\frac{d}{n} = K'S$ where $K' = \frac{Vg}{R}$.

The Donnan pipette method can be very useful for comparing a number of detergents or for plotting the surface tension in relation to the concentration curve, but it fails to give all the information required because other factors such as redeposition must be taken into account in assessing the efficiency of a scouring agent.

Many endeavours have been made to specify a satisfactory test for detergent power, but none is infallible, partly because, in practice, there is so much variation in the conditions under which scouring is carried out. There are differences in the ratio of liquor to goods, the nature of the mechanical agitation, the composition of the impurities to be removed, and the resistance of different fibres to alkali and temperature which have to be taken into account in practice.

McBain, Harborne and King (*J.S.C.I.*, 1923, 373r) proposed a method for the direct determination of detergent power which depends upon the colorimetric estimation of the amount of carbon black which a solution of soap will carry through a filter paper. The effect of mechanical agitation is ignored in this test which means that it bears little relation to practice. Testing of detergency is now usually carried out by using fabrics with a known degree of artificial soil, usually composed of an animal or vegetable oil mixed with carbon black. The carbon black in the soil can be determined colorimetrically before and after scouring, or the oil can be estimated by extraction with an organic solvent. The launderometer and the Society

of Dyers and Colourists wash-wheel both scour the sample in a rotating cylindrical container with steel or rubber-covered balls. Machines have been made to simulate scouring action and a laboratory apparatus for detergency studies is described by Straw (*J.S.D.C.*, 1954, 288). For further information see *Surface Activity and Detergency*, Durham, Macmillan.

Selection of soap

A good soap should fulfil the following conditions:

- (i) It should contain at least 62 per cent of fatty acids and between 6.5 and 8.5 per cent combined alkali, expressed as Na_2O . The actual percentage of combined alkali depends upon the molecular weight of the fatty acids. A fatty acid of high molecular weight generally makes a better detergent, and a low combined alkali is desirable, as long as the fatty acid content exceeds 62 per cent.
- (ii) No free fat, unsaponifiable oil, or free alkali should be present. Free caustic alkali denotes carelessness in manufacture, but sodium carbonate or silicate are often added purposely to make the soap harder or to improve its detergent action. It is preferable to use pure soap and, if necessary, add predetermined and controlled amounts of alkali to the scouring liquor.
- (iii) Salts such as sodium chloride and sodium sulphate should only be present in small quantities. If the soap contains excess it is equivalent to an adulterant.
- (iv) Rosin soap should be absent. Rosin is a by-product in the purification of turpentine and gives a soap-like substance when boiled with sodium hydroxide. It has strong detergent power, but if left in the goods may cause loss of colour, especially when hard water is used. Rosin soap can be recognized by the following test: about 1 g of the fatty acids prepared from the soap is dissolved in acetic anhydride. The solution is poured onto a white porcelain tile, and a drop of concentrated sulphuric acid is placed near it on the tile so that as it spreads it will impinge upon the edge of the acetic anhydride solution. The appearance of a violet colour at the point of contact indicates the presence of rosin.

Titre of soap

The titre of a soap or a fat is the temperature at which its fatty acid solidifies. As a rule the melting points are not clearly defined because the fatty acids are mixtures. A few examples of titres are given below ($^{\circ}\text{C}$):

Castor oil	3	Olive oil	25
Coconut oil	29–30	Cotton seed oil	34–35
Bone fat	38–40	Tallow	40–45

In order to determine the titre, the melted dry fatty acids are poured into a test tube (about 6 cm long and 3.5 cm wide). The tube is passed through

a hole in a cork, the latter being inserted in the mouth of a bottle or boiling tube, and a thermometer is placed in the tube containing the fatty acids. The tube is allowed to stand till, as the molten fatty acids cool, a few crystals appear. The mass is then stirred once with the thermometer in such a manner as to mix the crystals with the rest of the fatty acid, but without allowing the thermometer to come into contact with the sides of the test tube. The temperature will fall for a time after stirring but will finally rise and remain stationary for a short period. The latter temperature is known as the titre.

The soaps with low titre are more soluble in water at low temperatures. Animal fibres are usually scoured at temperatures not in excess of 60°C, and therefore a low-titre soap is preferred. Olive-oil soap is the most suitable, but also the most expensive, so that soaps made from coconut or cotton-seed oils are often used. Cellulose fibres, on the other hand, can be scoured at the boil, and the lack of solubility of a high-titre soap does not matter. A high-titre product such as tallow soap is used, this being a more effective detergent.

When the mechanism of the surface activity of soap was understood it was realized that any compound with a long-chain hydrocarbon tail and a hydrophylic head should have similar properties. This reasoning led to the introduction of the so-called 'synthetic detergents' which have now to a great extent replaced soap in domestic use and even more so in the industrial field. Many of them are derived from by-products in the petroleum industry and they became well established during the 1939-45 war, when there was an acute shortage of natural fats, and an opportunity to substitute a synthetic product was welcome. They have one outstanding advantage; their calcium and magnesium compounds are not insoluble in water; on the whole, however, they are not such good detergents as soap. Some are intended to be used purely as wetting and penetrating agents and others have detergent properties. With any synthetic product, therefore, it is advisable to use it only for the purpose for which it is intended, and also to ascertain whether it is stable at high temperatures because some tend to break down at the boil.

Turkey-Red oil, although not a synthetic product, resembles them in many of its properties. It is the sulphuric acid ester of ricinoleic acid; prepared by the action of sulphuric acid on castor oil at temperatures not exceeding 35°C:

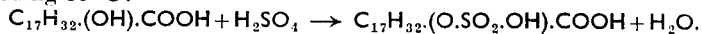

Turkey-Red oil is extremely soluble in water at all temperatures, has surface-tension reducing properties to a marked degree, is not decomposed by dilute acids, and does not form insoluble calcium and magnesium salts. It is not a very good detergent and was used essentially as a wetting and penetrating agent. Its name is derived from the fact that it was originally used as an assistant in dyeing Turkey Red.

In 1913 Reychler (*Bull. Soc. Chim. Belg.*, 1913, 27, 110) described the results of work which he had carried out with sodium salts of hexadecane sulphonic acid; demonstrating that the compound exhibited surface activity. This work was followed up by others which showed that sulphuric acid esters of higher aliphatic alcohols possessed valuable wetting and detergent properties. Not much progress was made, however, because the necessary alcohols were not then available in commercial quantities at economic prices. During the 1914-18 war Germany suffered from a shortage of fats and therefore made strenuous efforts to produce detergents from raw materials which were available, with the result that the sodium salt of diisopropylnaphthalene sulphonic acid was marketed as Nekat A. It was not a good detergent but was quite satisfactory as a wetting agent. A few years later I.G. in Germany placed Igepon A on the market. It was the sodium salt of the product obtained by the condensation of oleic acid chloride with hydroxyethane sulphonic acid:

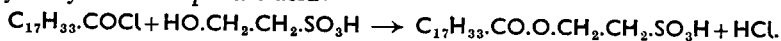

It is stable to acids and to calcium and magnesium and gives a neutral solution which has advantages in wool scouring. Igepon A undergoes hydrolysis in alkaline solutions at the boil and is therefore not suitable for cotton scouring. This disadvantage is absent from Igepon T, obtained by condensing oleic acid chloride with *n*-methyltaurine:

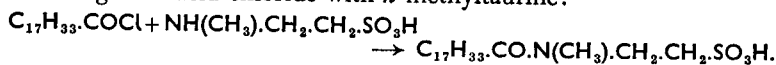

Lissapol LS, $\text{C}_{17}\text{H}_{33}\cdot\text{CO}\cdot\text{NH}\cdot\text{C}_6\text{H}_3(\text{O}\cdot\text{CH}_3)(\text{SO}_3\text{Na})$, is made by the condensation of oleic acid chloride with para-anisidine sulphonic acid, and Aerosol MA, derived from succinic acid, has the constitution shown below:

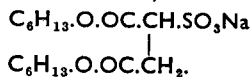

The Fischer-Tropsch synthesis of straight-chain hydrocarbons of high molecular weight by passing carbon monoxide and hydrogen over a catalyst, usually a group 8 metal capable of forming carbides such as cobalt, at high temperatures, opened the way to the synthesis of long-chain aliphatic sulphonates. The fraction containing C_{14} to C_{16} hydrocarbons, when treated with a mixture of sulphur dioxide and chlorine, gave a mixture of mono- and disulphonyl chlorides, which, when hydrolysed with sodium hydroxide, yielded the corresponding sodium salts of the sulphonic acids. These products were known as the Mersolates.

An interesting sequel to the Fischer-Tropsch synthesis is the so-called OXO reaction. Olefines derived from the Fischer-Tropsch process will react with carbon monoxide and hydrogen in the presence of cobalt carbonyl at temperatures of 110° to 150°C, under pressures of 150 to 200 atmospheres, to yield aldehydes. These can either be reduced to alcohols or oxidized to fatty acids, and they are derived from the petroleum industry

to the extent that much of the carbon monoxide is made by the controlled oxidation of natural methane, usually associated with oil beds. The C_{12} to C_{18} olefines are reduced to alcohols and esterified with sulphuric acid to form surface-active compounds of the 'sulphated alcohol' group. They are, in fact, sulphuric acid esters of high molecular weight aliphatic alcohols. Sodium dodecyl, tetra-decyl, cetyl, and oleyl sulphates are very commonly used as domestic and industrial detergents. The sulphated alcohols have the general formula $R.O.SO_2.OH$, and are a distinct class differing from sulphonated aromatic or aliphatic compounds which conform to the structure $R.SO_3H$. A few examples of this group are Lorol and Gardinol WA, which are derived from lauryl alcohol, $(C_{12}H_{26}O.SO_2.ONa)$, Lissapol C, which is sodium oleyl sulphate, $(C_{18}H_{35}O.SO_2.ONa)$, and Lissapol A is the sulphuric acid ester of cetyl alcohol, $(C_{16}H_{33}O.SO_2.ONa)$.

All the sulphonic acid and sulphuric ester wetting agents and detergents are classified as anion active compounds. When they ionize the tail or surface-active component carries a negative charge, and is, therefore, an anion:

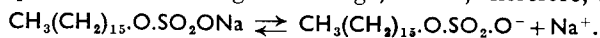

When crude petroleum is fractionally distilled there is a wax-like residue in the still. This can be fed into a cracking unit when a high yield of olefines containing between six and twenty carbon atoms is obtained. These are treated with sulphuric acid to give secondary alkyl sulphates such as Teepol:

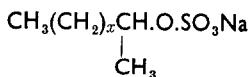

Compounds of this nature are good wetting agents and, because the side chain only contains one methyl group, they also possess good detergent properties.

The cation-active surface-active compounds, which are usually quaternary ammonium or pyridinium derivatives, form another important group of textile auxiliaries. An example is Sapamine CH, which is diethylethylene diamine condensed with oleyl chloride and converted to the corresponding hydrochloride:

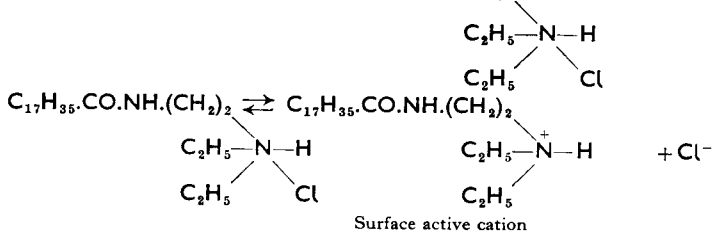
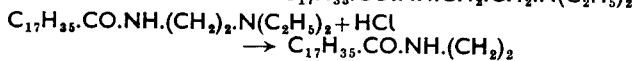
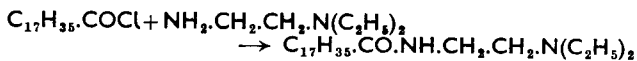

Compounds of this type are not detergents, but the cation is deposited on the surface of the fibre which assumes a negative charge in water. This fact is made use of to attach surface films to fibres to give them a softer handle, or for other purposes.

Cation-active substances are also used to increase the wet-fastness of direct dyes. An example of such a product is Fixanol C, which is cetyl pyridinium bromide:

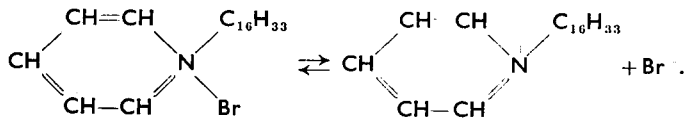

The cation is presumed to form a complex with the dyestuff anion, thus producing a new substance of greater molecular complexity and less solubility in water:

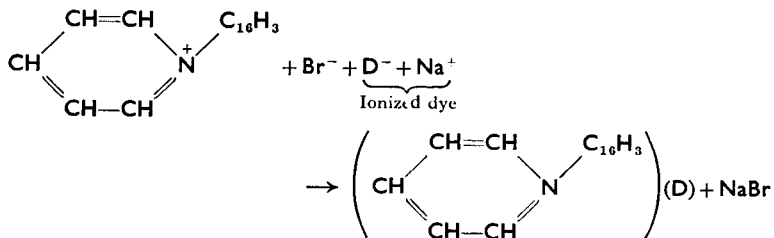

Waterproof finishes are also obtained by depositing a surface-active cation on the fibre and then causing polymerization to take place by the application of heat. Velan PF is stearamidomethyl pyridinium chloride, $\text{C}_{17}\text{H}_{35}\cdot\text{CO}\cdot\text{NH}\cdot\text{CH}_2\text{N}^+(\text{C}_6\text{H}_{10})\text{Cl}^-$. The cloth, on which Velan has been deposited, is dried and baked at 120° to 150°C when according to Davis (*J.S.D.C.*, 1947, 260) the first stage is decomposition, in the presence of water, with the formation of methylolstearamide:

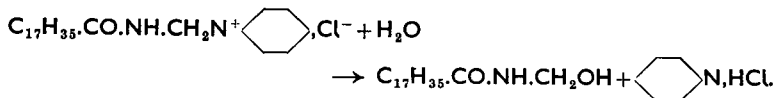

The methylolstearamide then either condenses with hydroxyl groups in the cellulose:

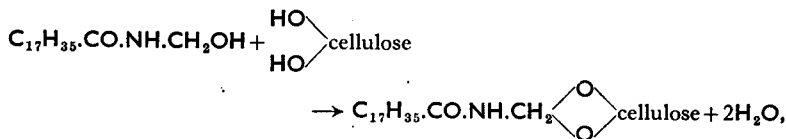

or condenses with itself to form hydrophobic compounds of the type $\text{C}_{17}\text{H}_{35}\cdot\text{CO}\cdot\text{NH}\cdot\text{CH}_2\cdot\text{O}\cdot\text{CH}_2\cdot\text{NH}\cdot\text{OC}\cdot\text{C}_{17}\text{H}_{35}$.

Cation-active cetyl trimethylammonium bromide, $\begin{array}{c} \text{C}_{16}\text{H}_{33} \\ \diagdown \\ \text{CH}_3 \\ \diagup \\ \text{N} \\ \diagdown \\ \text{CH}_3 \\ \diagup \\ \text{Br} \end{array}$ which

is the basis of Lissolamine V, is used as an assistant in stripping vat dyes. Hydrosulphite reduces the pigment to an anionic leuco compound, but the latter is reabsorbed by the cellulosic fibre so that equilibrium is established after only a small proportion of the dye has been removed. The cationic Lissolamine V combines to form an insoluble product with the anionic leuco compound, thus disturbing the equilibrium and bringing about much more effective stripping. Cetyl trimethylammonium bromide is also a stripping agent for azoic dyes. The mechanism, in this case, is somewhat obscure, but it has been suggested by Rowe and Owen (*J.S.D.C.*, 1936, 205) that a small quantity of the pigment passes into solution to form an insoluble complex with the cation-active compound, which is then decomposed by the reducing agent (hydrosulphite) also present, in such a way that the cationic substance is liberated and is again available.

The anionic and cationic surface-active compounds cannot be used together. The negatively- and positively-charged ions will unite and either precipitate or mutually destroy their effectiveness. Traces of soap which is anionic, if left in goods after scouring, will combine with a cationic reagent used in a later process to form an objectionable scum which adheres to the fibres. Dye ions are usually either anions or cations, and this must be borne in mind when they are used in conjunction with surface-active compounds. For these reasons there are many uses for non-ionic wetting agents or detergents.

Ethylene oxide will unite with any compound containing an active hydrogen atom such as an alcohol, a carboxylic acid, an amine, or an amide according to the following general equation:

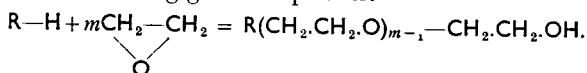

R is a hydrophobic component such as a long chain paraffin, an aromatic or an alkylated aromatic group. Since polymerization of ethylene oxide occurs in a random manner, these non-ionic surface-active compounds are not of specific composition but are a mixture of products which vary in molecular weight. An example of one of these products is Lissapol N which is obtained by the condensation of nonylphenol with ethylene oxide, having the general formula $\text{C}_{19}\text{H}_{18}.\text{C}_6\text{H}_4(\text{CH}_2.\text{CH}_2.\text{O})_n\text{CH}_2.\text{CH}_2.\text{OH}$. Another example is the condensation of stearic acid with three molecules of ethylene oxide:



The terminal hydroxyl group is sufficiently hydrophylic to give surface activity but does not convey polarity to the molecule, so that there is no ionization in aqueous solution. Many of them tend to become less soluble at temperatures approaching the boil, and are most effective cold or at the lower temperature ranges. It is probable that the formation of hydrogen bonds of the type $R.O.CH_2.CH_2 \cdots$ with the solvent help to keep them in



solution and these are severed at higher temperatures. The so-called cloud point is the temperature at which turbidity first becomes apparent and is an indication that the first of the components of the mixture has become insoluble in water.

Effect of electrolytes. The addition of electrolytes lowers the interfacial tension between synthetic surface-active detergents in solution and xylene or other oils. It is therefore logical to conclude that the addition of electrolytes would bring about an improvement in detergency and this has been demonstrated by Palmer (*J.S.C.I.*, 1941, **60**, 56) and Aickin (*J.S.D.C.* 1944, **60**, 170). The latter applied approximately 5 per cent of oil to purified wool from a solution in ethyl ether so that the distribution would be uniform. Samples were then scoured with detergent solutions containing varying quantities of electrolyte and the residual oil was determined. The results are summarized in the graph shown in Fig. 9.13.

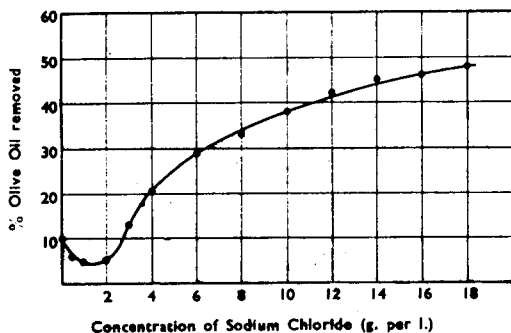

Fig. 9.13

(Aickin, *J. Soc. Dyers and Colourists*)

Low concentrations of sodium chloride, in fact, reduce detergent power but any increase above 2 g/l produces a rapid improvement. This effect is apparent with the non-ionic surface-active compounds as well as with the sodium alkyl sulphates.

The ethanolamines, though not themselves surface-active compounds, enter into combination with fatty acids to form extremely powerful deter-

gents. When ethylene oxide reacts with ammonia a mixture of mono-, di-, and triethanolamines is formed:

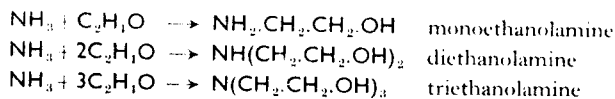

These substances are bases which will combine with fatty acids to form ethanolamine soaps:

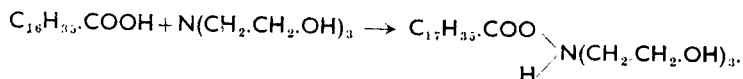

These soaps are too expensive for normal scouring but are extremely useful for special purposes such as removing obstinate oil stains.

The scouring operations in which these surface-active compounds are commonly used vary according to the nature of the fibre and the amount and composition of the impurities to be removed. In the case of cotton the cellulose of which it is composed is stable to dilute solutions of alkali at the boil. The impurities which must be removed are natural oils and waxes, proteins, pectic substances, natural colouring matter, and adventitious dirt. The basic principle of cotton scouring is to boil the goods for several hours at atmospheric, or under elevated, pressure with a 2 per cent solution of sodium hydroxide.

The goods are usually prepared for handling by making them into a continuous rope. Pieces are stitched together end to end, and hanks are either linked as shown in Fig. 9.14 or made into a continuous chain by tying



Fig. 9.14 Chain of hanked yarn

them together with bands or tapes. An alternative method of dealing with hanks is to untie the compressed 10-lb bundles in which they are delivered from the spinners and reassemble them in a looser form, using one of the hanks as a binder as shown in Fig. 9.15. In both the chains and the loose

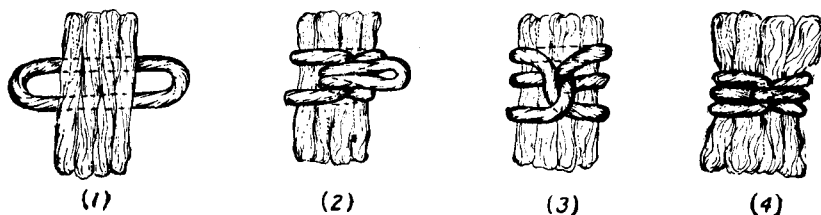

Fig. 9.15 Yarn in loose bundles

bundles the knots or folds must be kept as loose as possible so that they do not offer resistance to penetration. Small lots of hanks may be treated by twisting each one lightly into a 'noddle' (Fig. 9.16). This enables them to be handled without danger of the threads becoming entangled and causing difficulty in subsequent winding.



Fig. 9.16 Noddle of yarn

Singeing and steeping may precede scouring. The object of singeing is to remove projecting fibres and give a fabric with a smoother surface. The material passes rapidly over a row of gas burners which remove projecting hairs. The speed at which the cloth travels must be adjusted carefully so that the hairs are burned away without scorching the material. Sometimes the goods are quenched by passing them through a trough of water after they have been exposed to the flames. A singeing machine is illustrated in Fig. 9.17, in which the rows of gas burners can be seen at *C* and *C'*

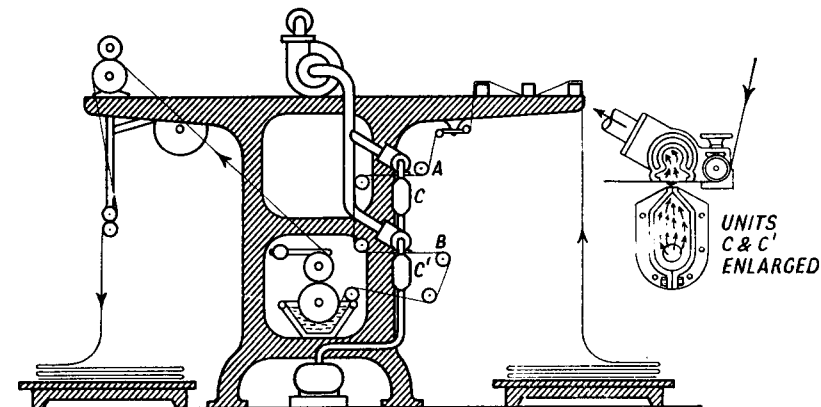

Fig. 9.17 Diagram of singeing machine

arranged so that each side of the cloth can receive treatment. The machine in the diagram is primitive but shows the basic principle more clearly than do illustrations of more sophisticated modern ones.

Steeping often, though not always, precedes scouring. When the goods contain a starch size, steeping consists of soaking with diastase or some other enzyme preparation which will convert the insoluble starch into soluble sugars or dextrins. About 1 per cent on the weight of the goods of diastase is added to the steeping liquor, and the cotton is either soaked in this solution at a temperature of 65°C for several hours or is simply impregnated with a warm solution and allowed to stand. Oxidizing agents have been used for desizing because some of them will degrade starches without having any action on cotton cellulose. Persulphates and hydrogen per-

oxide are effective but have not found general application. It has also been shown that ammonium perdisulphate and acid hydrogen permonosulphate are effective for desizing. The proposed method is to pad the cloth in the quench box immediately after singeing with a solution of the persulphate at 60 to 90°C. The cloth is then batched for several hours before washing

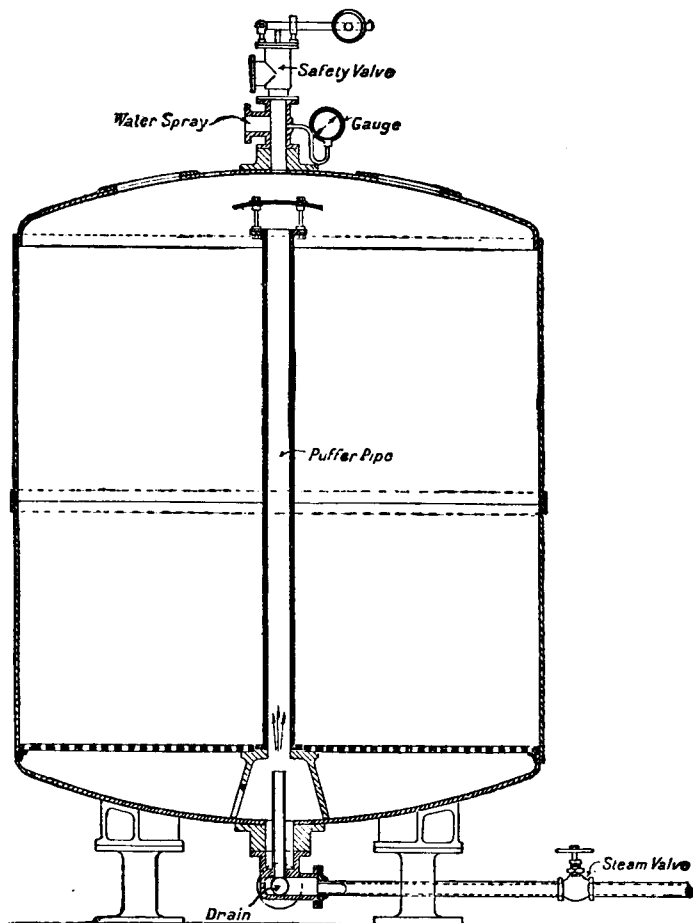

Fig. 9.18 High-pressure kier

off (Chesner, *J.S.D.C.*, 1963, 79, 140). The solubilization of starch is less than that obtained with enzymes but for many purposes it is adequate and subsequent peroxide bleaching will usually complete the removal of the size. Greater success has been achieved with sodium bromite used at pH values greater than 9. This reagent like the peroxides exhibits preferential

oxidation on the size. In practice the material may be padded cold at a pH of 10 with a solution containing not more than one gramme of active bromite per kg of fabric. This is followed by a dwell period which is usually overnight. At 50°C, with the addition of 20 g/l of sodium hydroxide and 1 g of active bromite per kg of fabric, desizing is complete in 20 minutes and under these conditions the process can be integrated into continuous scouring and bleaching ranges. When no starch has to be removed a preliminary steep in a 0.5 per cent solution of hydrochloric acid is beneficial, although it is usually omitted. It is claimed that this dissolves nearly all the mineral impurities besides opening up the fibres and rendering them more amenable to subsequent processes.

After preliminary steeping the goods are rinsed. It is very important in cotton processing that the soluble products formed at one stage should be completely removed before subjecting the goods to the next. If they are not removed they may be reprecipitated in the next process or inhibit the action of the chemicals which are used.

The actual scouring process is often referred to as kier boiling. Kiers may be either low pressure, which are open to the atmosphere, or high pressure, which are sealed and can operate at temperatures well above 100°C. An injector kier is, from the mechanical point of view, extremely simple. The process can be used for both low- and high-pressure vessels and may be taken, therefore, to illustrate the general principles of construction. Such a kier is shown diagrammatically in Fig. 9.18; it consists of a cylindrical shell with dished ends and a false bottom or iron grid about 18 inches above the base. At the top are manholes through which loading and unloading take place. These are provided with covers which can be clamped down so as to make a pressure-resisting seal. A puffer pipe ascends through the middle of the machine, at the bottom of which is a steam-operated injector (Fig. 9.19) which throws the liquor which falls below the false bottom upwards with considerable force. At the top the liquor impinges upon a spreader plate which scatters it in all directions over the surface of the load of cotton. The injector (Fig. 9.19) consists of a liquor chamber *A* with an orifice the shape of which resembles two hollow cones, one inverted above the other. Within the chamber, and placed centrally with regard to the orifice, is a conical steam nozzle. The chamber and nozzle are fed by liquor and steam pipes. On issuing from the nozzle the steam meets the incoming liquor. This produces two results; firstly, the steam, owing to its pressure, emerges with high velocity, and part of this it communicates to the liquor and, at the same time, it transfers heat to the caustic soda solution. In modern kiers the circulation is provided by a centrifugal pump and the liquor is heated in a calorifier (Fig. 9.20). This is more economical in steam consumption and the condensate from the calorifier can be returned to the boiler so that any heat which it contains can be made to serve a useful purpose.

In the actual practice of kier boiling the continuous chain, usually 2000 to 5000 lb in weight, is delivered into the kier by a mechanically-driven overhead winch. The packing or plaiting down of the chain is an exceedingly important operation, because if the density of the cotton is not uniform there will be channels of less resistance. When the liquor is circulated the whole of it will run through the channels where the resistance is not so great, and the tightly packed portions will be bypassed. It is apparent, therefore, that bad packing can lead to serious inequality in the removal of the impurities. As the chain enters the kier it may be guided manually by a skilled operative or, in larger plants, mechanical devices may be used.

Before loading, the kier is filled to between one-third and one-half of its capacity with water, and sufficient caustic soda is added to give a 2 per cent solution when the liquor is at its ultimate working level. If the cotton has not been steeped previously the solution is raised to the boil before the goods are run in, otherwise they would not wet out but would float. During loading it is often necessary to add more water so that the goods will be covered when the kier is full; allowance should be made, either initially or by subsequent additions, to maintain the concentration of the caustic soda at 2 per cent. If additions have to be made the sodium hydroxide should be very well diluted, because if it approaches 17 per cent local mercerization accompanied by serious shrinkage can occur where it comes into contact with the cotton.

When loading is completed the lid of the kier is clamped down and the steam is turned on. An escape valve, however, is left open till the liquor is boiling and steam issues out, to ensure that all the air has been expelled. Cotton, whilst being boiled with a 2 per cent caustic soda solution, must not be allowed to come into contact with atmospheric oxygen because this can lead to the formation of oxycellulose. In a closed kier, therefore, the air is expelled, and in an open one it is essential that there should always be enough liquor to cover the goods completely. When the air has been displaced the escape valve is closed and a pressurized kier is usually maintained at a temperature of 125° to 130°C for a period of about 6 hours. In an open kier the boiling period is usually 8 to 12 hours, the temperature, of course, being 100°C in this case.

When boiling is finished the release valve at the bottom is opened to run

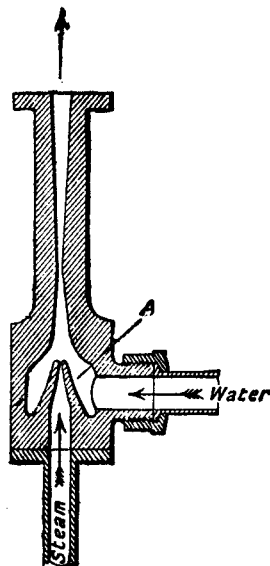

Fig. 9.19 Injector

off the hot liquor, but an equivalent amount of cold water must be allowed to run in at the same time so that the liquor level never falls below the top

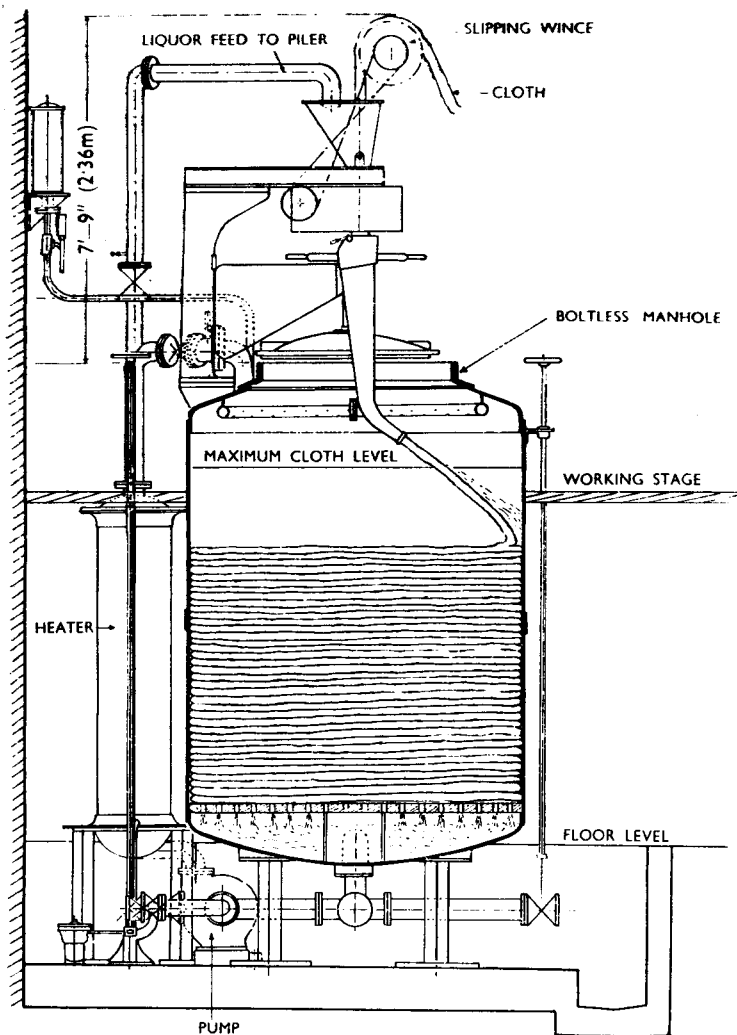

Fig. 9.20 High-pressure kier

(Courtesy of Mather and Platt)

of the cotton until the temperature has fallen to below 25°C. When cooled thus the danger of formation of oxycellulose by exposure to air no longer exists. The cotton is then washed several times with water until the rinsings

no longer give an alkaline reaction with phenolphthalein. The relationship between steam pressure and temperature is shown below in Table 9.1.

Table 9.1

<i>Pressure (lb/sq in.)</i>	<i>Temperature (°C)</i>
14.7	100
17.5	105
20.8	110
24.6	115
28.8	120
33.7	125
39.3	130
115.3	170

During the caustic soda boil all the impurities, with the exception of the colouring matter and wax, are converted to soluble substances which are washed away when the rinsing takes place. The oils and fats are converted to soaps, and these in turn emulsify the waxes. The proteins are broken up into the sodium salts of simple amino acids and the adventitious dirt falls away when the oils are removed and is held in suspension by the soap. It is necessary to use soft water during kier boiling to avoid troubles due to the precipitation of calcium and magnesium soaps.

Many assistants have been recommended to improve penetration or keep insoluble impurities in suspension. Since kiers operate well above 100°C care must be taken to select those which are stable at such temperatures; many of the non-ionic products are excluded for this reason. At one time rosin soap was favoured because of its excellent detergent power, but it was essential that there should be no hardness in the water and that there should be thorough rinsing after boiling. A mixture of pine oil and soap is often added, but during recent years the tendency has been to use the synthetic surface-active compounds. Alkyl derivatives of naphthalene sulphonic acids such as Nekal were used as penetrating agents, but they lacked detergent properties. Products such as oleyl sodium sulphate, sodium oleyl par-anisidine sulphonate and sulphonated sperm oil, mixed with pine oil, are in common use. An addition of sodium metasilicate to the kier liquor is often made, 5 lb per 100 gallons being the recommended quantity. It is claimed that silicates give an improved colour because they have a greater power of holding dirt in suspension. It is, however, most important that they should be rinsed out thoroughly, otherwise silica or insoluble silicates may be deposited in subsequent processes and give a harsh handle.

The removal of impurities is accompanied by a corresponding loss of weight. Properly alkali-boiled cotton, therefore, will lose between 5 and 7 per cent, but there will be very little, if any, loss of weight in subsequent finishing processes. Any factor which reduces the weight of yarn without

altering its length must increase count. Table 9.2 below illustrates the effect of soda boiling on counts.

Table 9.2

<i>True count before boiling</i>	<i>True count after boiling</i>
32	33.72
40	42.0
80	83.9
100	104.6
120	125.6

Continuous alkali boiling

J-boxes which are extensively used in continuous scouring and bleaching cotton goods with hydrogen peroxide will be described in the next chapter. There has been a great improvement in productivity made by the introduction of continuous high-pressure kiers such as the Vaporlok pressure vessel of Mather and Platt (Fig. 9.21) and also the Pressure-Lok unit developed in the United States. Open width cloth can pass through the vaporlok chamber continuously after impregnation with a 5 to 9 per cent solution of sodium hydroxide. It is heated to 134°C (273°F) under a

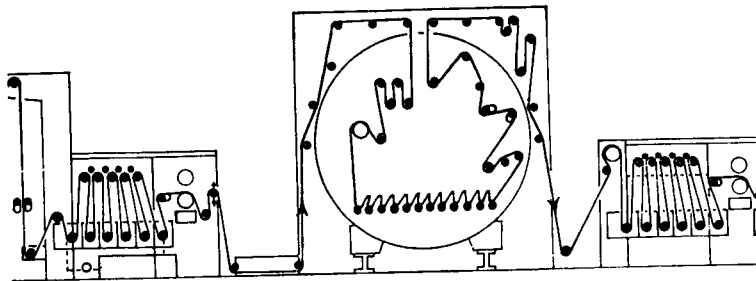

Fig. 9.21 Vaporlok unit
(Courtesy of Mather and Platt)

pressure of 30 lb per sq in, and a dwell period of 90 to 120 seconds gives sufficient degradation of the impurities for peroxide or sodium chlorite bleaching.

Scouring cotton by extraction with an organic solvent such as trichloroethylene, followed by flash evaporation, is making progress in practical application. Investigation by I.C.I. demonstrated that immersion in trichloroethylene for periods as short as 30 seconds would reduce fat and wax content to about 0.15 per cent, a figure which is within the tolerance of commercial acceptability. If the cotton is singed it is quenched with steam instead of water so that it enters the solvent extraction unit dry.

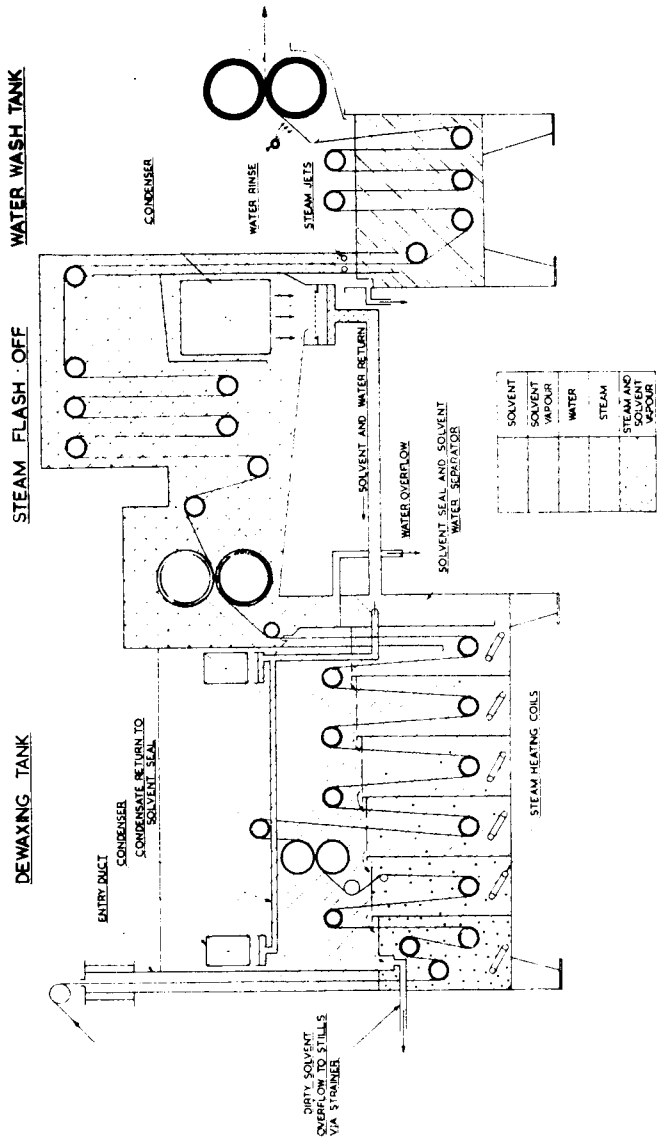

Fig. 9.22 Plant for solvent scouring
(Courtesy I.C.I.)

The plant is shown diagrammatically in Fig. 9.22. The cloth, after entering, passes through six compartments in which it is extracted with trichloroethylene. The walls separating the compartment become progressively lower towards the entry end so that the trichloroethylene, fed in at the exit end, moves continuously in a counterflow direction. After passing through a seal, the cloth is drawn through squeeze rollers and a steaming chamber where the solvent is evaporated and it finally emerges through a water seal. Wax and oil are removed but other impurities remain which may require a mild boil in alkali prior to hypochlorite bleaching but can be left to be degraded and dissolved by the alkali present in a peroxide bleaching liquor. This method of scouring has proved especially satisfactory in conjunction with peroxide bleaching in J-boxes. It has been used quite extensively for cotton and polyester mixtures.

The lime boil

This was a more complicated process than the caustic soda boil and was at one time favoured because the risk of tendering due to oxycellulose formation was less. It has now virtually been replaced by caustic soda scouring. The goods were impregnated with milk of lime, then packed in a kier, and covered with more milk of lime. The boiling was conducted in the same way as with soda. The effect was to dissolve the proteins, the saponifiable fats being converted into insoluble calcium soaps, and the pectoses and pectates into insoluble calcium pectates, both of which remained on the goods.

After boiling, the goods are washed with water, and then treated with a dilute solution of hydrochloric acid (1.5 to 2 per cent). This liberates the fatty acids from the lime soaps and pectic acid from the pectates, with the formation of calcium chloride. The goods are then rinsed to remove the calcium chloride and returned to the kier where they are boiled again with sodium carbonate and rosin or a high-titre soap. The free fatty and pectic acids are now converted into their soluble sodium salts which can be washed away with water.

Wool scouring

The scouring of wool differs from cotton in two essential respects. In the first place, raw wool contains anything from 30 to 60 per cent of wool grease, compared with 0.5 per cent of oil and wax in cotton. In the second place, wool is very rapidly degraded by alkali so that if the natural oils and fats are to be saponified the alkali must be applied with caution and at temperatures well below the boil. In practice, sodium hydroxide is never used because the slightest excess would raise the pH above the danger level, and milder alkalis such as sodium carbonate and ammonia or ammonium carbonate are preferred.

Raw wool is scoured by the counter-current method, using a machine of the type shown in Fig. 9.23. There are generally either four or five bowls, similar to the one illustrated, arranged in sequence so that the wool passes directly out of the first into the second, and so on. The machine consists essentially of a long trough provided with rakes (B), a false bottom (C), and at the exit a wringer. Below the false bottom is a spirally fluted shaft (D) which, when it rotates, carries the deposited solid dirt to the centre where there is an outlet valve through which it can be discharged.

The trough is filled with scouring liquor, containing soap and sodium carbonate, and the temperature is brought to 35° to 40°C. The rakes have a reciprocating movement which makes the wool travel forward beneath the

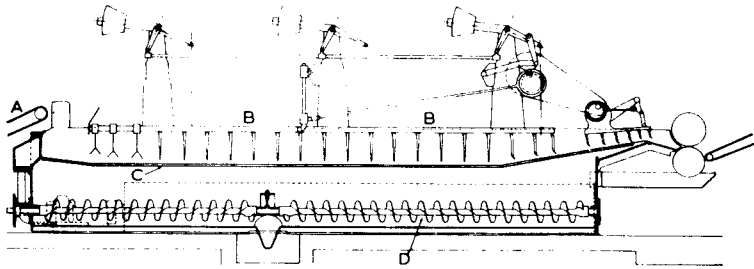

Fig. 9.23 Diagram of one bowl of a harrow machine
(Courtesy of Petrie McNaught)

surface of the liquor whilst adequate agitation is maintained to keep the dirt and emulsified grease in suspension. As the wool leaves the trough the excess of soap liquor is squeezed back by the wringers, the wool passing to a second, similar trough where it usually receives further scouring, since removal of impurities will not be complete in the first. This may be repeated two, three, or four times before the wool passes through a final trough where it is rinsed with water. The machine described is only one of many designs, but the basic principle of continuously moving the wool through a series of scouring liquors is alike in all.

The composition of the scouring liquors varies considerably according to local practice. Priestman (*Wool Spinning*, Longmans Green, London, 1924) gives the following concentrations for bowls of 1500 gallons capacity.

Concentrations of soap and alkali

	<i>Soap (per cent)</i>	<i>Alkali (sodium carbonate) (per cent)</i>
First bowl	0.80	0.27
Second bowl	0.40	—
Third bowl	0.37	—
Fourth bowl	Water only	—

Schofield (*Finishing of Wool Goods*) recommends the following:

	<i>Soap (per cent)</i>	<i>Alkali (sodium carbonate) (per cent)</i>
First bowl	0.75	0.25
Second bowl	0.50	0.1
Third bowl	0.25	0.1
Fourth bowl	Water only	—

The amount of alkali added should never be sufficient to bring the pH above 10. Scouring is carried out at 35° to 40°C and the temperature should never, under any circumstances, be allowed to exceed 60°C because of the risk of degradation of the wool keratin by the alkali. The soaps which are selected must be made from fatty acids with low melting points, because these are more soluble at lower temperatures, and also because they are more easily rinsed out. When two or more bowls are scouring in sequence the counter-flow system is generally used. As the wool emerges from a trough the wringers squeeze the excess liquor into a receptacle connected to the preceding bath. Thus there is a gradual transference of liquor from the last to the first compartment; the flow being in the opposite direction to that in which the wool is travelling. Fresh soap and alkali is fed into the last tank so that the wool which is virtually grease-free receives the most effective detergent treatment, and the dirtiest wool, which easily parts with the bulk of its grease, meets the partly-spent liquor; which is ultimately discharged from the first trough. Whilst the bulk of detergent can be fed into the last bowl some fortification of the others is usually necessary.

There has been a marked tendency for synthetic detergents to replace soap in wool scouring. This is partly because they are more soluble in water than soap and, therefore, more easily rinsed out. Compounds of the nature of oleyl sodium sulphate such as Lissapol C are very suitable. The non-ionic surface-active compounds also find more application in scouring wool than is the case with cotton. This is, to some extent, because wool is scoured at lower temperatures, at which they are more soluble. Scouring with sodium carbonate and a wetting agent such as, for example, Lissapol N (ethylene oxide, alkyl phenol condensation product) gives economical and good results because the lowering of surface tension facilitates the saponification of the fats in the raw wool, and the soaps thus formed promote emulsification of the unsaponified and unsaponifiable fats and waxes. Table 9.3 below, from I.C.I. publication Auxiliary Products No. 55, states the quantities of Lissapol N and soda ash recommended for combing wools of different fibre qualities. It should be borne in mind that these quantities only serve as an illustration. The proportion of impurities in the raw wool and the effectiveness of different machines vary so much that, in all probability, adjustments will have to be made to suit local conditions. The presence of electrolytes improves the emulsifying power of the syn-

Table 9.3 Scouring of combing wools

(i) Original charging of the bowls
(Quantities in g per litre or lb per 100 gallons)

	<i>Method</i>	<i>Temperature</i>	<i>1</i>	<i>2</i>	<i>3</i>	<i>4</i>	<i>5</i>
			<i>Over 64's</i>	<i>64's</i>	<i>56's-64's</i>	<i>Cross-breds</i>	<i>N.Z.—50's Fleece</i>
Bowl 1	Soda ash	55-60°C	3.5	2.5	2.0	2.0	1.5
	Lissapol N	(130-140°F)	1.0	0.75	0.75	0.5	0.25
Bowl 2	Electrolyte	55°C	5.0	5.0	5.0	5.0	5.0
	Lissapol N	(130°F)	1.75	1.5	1.25	1.25	0.75
Bowl 3	Lissapol N	50-55°C (120-130°F)	1.0	0.75	0.75	0.75	0.5
Bowl 4	Rinse	50°C (120°F)	Water	Water	Water	Water	Water

(ii) Additions per 1000 parts of greasy wool throughput

Bowl 1	Soda ash	10	10	10	7	4
	Lissapol N	1	1	1	1	—
Bowl 2	Lissapol N	4	4	3	3	2
Bowl 3	Lissapol N	2	1	1	1	1

thetic detergent, and sufficient salt or Glauber's salt should be added to Bowl 2 to give a concentration of 5 g per litre. Subsequent additions are not necessary because the electrolytes are not absorbed by the wool which, itself, brings some soluble electrolytes with it to Bowl 2, thus maintaining the concentration.

A method of scouring raw wool in which the detergent is forced through jets, under pressure, and impinges upon it with considerable velocity has

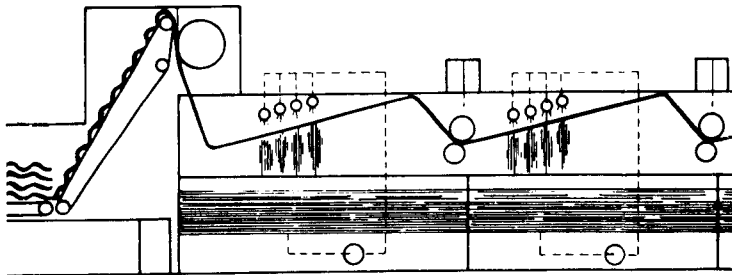

Fig. 9.24 Diagram of jet scouring machine
(Courtesy of Petrie and McNaught)

been described by Samson and Chaikin (C.I.R.T.E.L., 1965, iii, 101). A novel raw wool scouring machine based on this principle has been developed by Petrie and McNaught. The essential features are shown in Fig. 9.24. The wool is carried on a permeable conveyor under four, or more, sets of jets. The liquor is pumped from containers either below or in any other convenient situation. The great advantage is that efficient scouring is achieved with less entanglement of fibres than by any other method.

Woven piece goods and knitted wool fabrics are scoured in what is commonly known as the Whiteley type of machine (Fig. 9.25). The ends of the pieces are joined together to form an endless rope which passes between two large wooden rollers, the lower of which dips into a trough containing the soap liquor. The rope is then directed, by guide rollers, into the warm liquor at the bottom of the machine. As it is drawn up again for subsequent nips between the large rollers, the soapy liquor which it contains is wrung out into the trough so that there is continual circulation of the liquor as well as the cloth. Cloths do not contain the large quantities of impurities

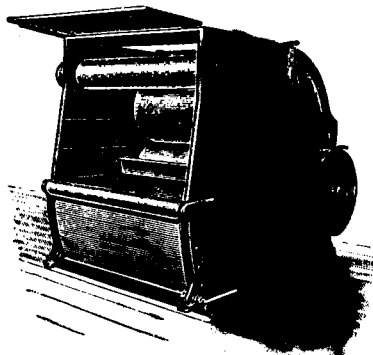

Fig. 9.25 Whiteley scouring machine

present in raw wool. There is only 1 to 5 per cent of oil added during spinning and some advantage is gained by scouring processes are therefore

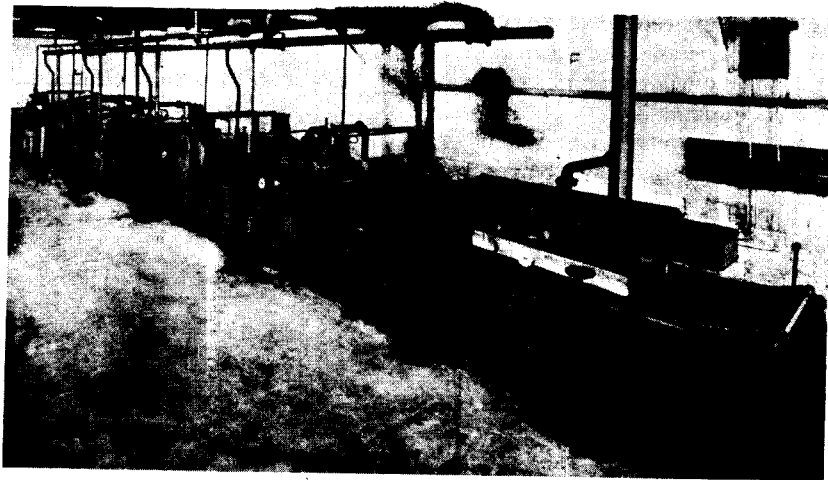

Fig. 9.26 Brattice type hank scouring machine

(Courtesy of Petrie and McNaught)

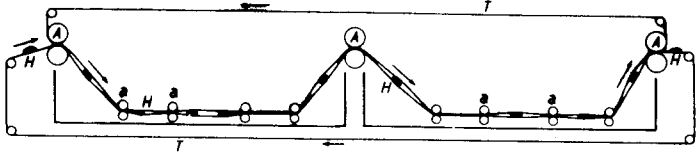

Fig. 9.27 Diagram of tape scouring machine

T	Tapes
A and a	Squeeze rollers
H	Hanks

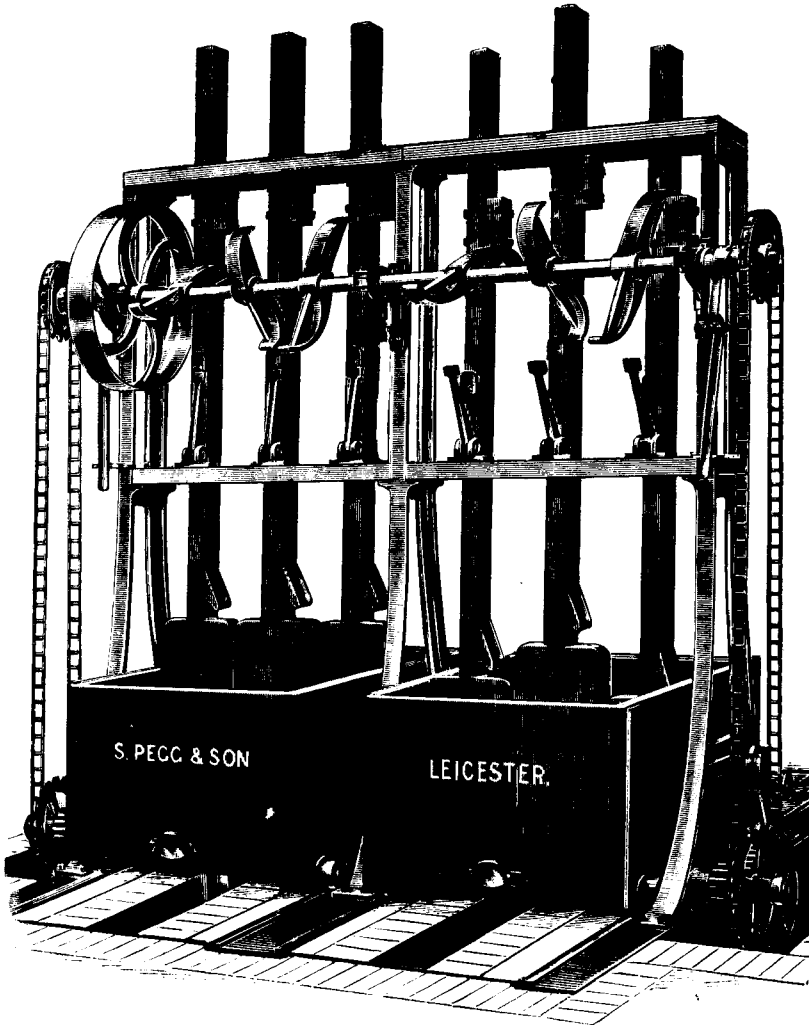

Fig. 9.28 Beater tubs

milder and a 0.5 per cent solution of soap or synthetic detergent at 40°C suffices. Soda ash is not used and if alkali is required, which is not often the case, ammonia would be preferred. It must be borne in mind that soda ash can be used with greater safety with greasy raw wool because the impurities exercise a protective action. If soap is the detergent soft water is necessary, but this can be dispensed with when synthetic surface-active products are used. During rinsing the liquor squeezed out into the trough can be run to waste, thus accelerating the removal of the retained soap.

Hanks are scoured on a brattice machine such as is illustrated in Fig. 9.26. The hanks are fed in at one end and passed on the brattices through detergent liquors in the first two bowls and rinsed with water in the last bowl. The liquor is squeezed out with mangles between each stage. The tape scouring machine (Fig. 9.27) is a simplified form of brattice. The yarn is gripped between endless tapes which carry it through the scouring and rinsing liquors. The machine gives satisfactory results and is used extensively for rug wools and hosiery and knitting yarns. Socks or garments are scoured in dollies, also called beater tubs or rotary scouring machines.

The dolly (Fig. 9.28) consists of heavy wooden 'feet' which are lifted by the cams on the shaft. When lifted to the top of the arc described by the cam, the 'foot' is released and falls, with the momentum of its own weight, onto the goods. The tub containing the load moves backwards and forwards with a reciprocating movement so that the dollying action is equally distributed in its application. The rotary scouring machine (Fig. 9.29) consists

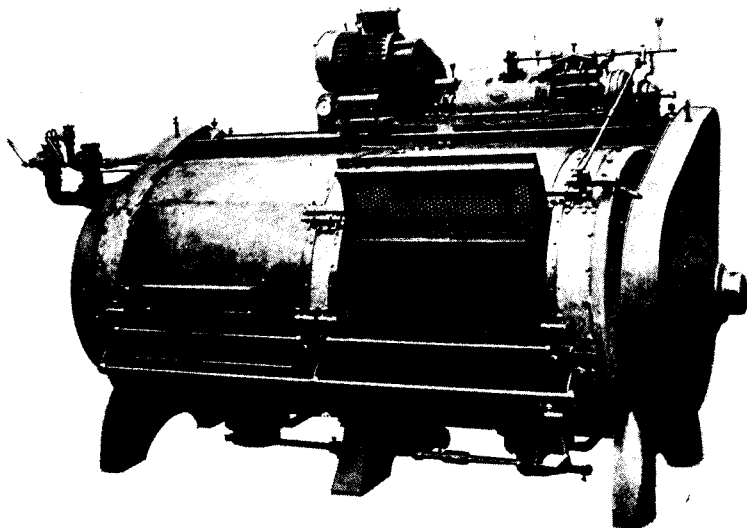

Fig. 9.29 Rotary scouring machine
(Courtesy of Manlove Alliott)

of an inner perforated drum provided with doors and internal partitions dividing it into three compartments. The drum, into which the goods are packed, rotates, with periodic alterations in direction, in an outer cylindrical vessel which contains the scouring liquor. As the inner drum rotates, the liquor flows in and out again and the goods are turned over with every rotation. Sufficient movement is therefore provided to keep the detached dirt in suspension.

Analysis of scoured wool

Methods of determining the efficiency of the scouring process are much more important in the case of wool than with cotton. Wool is so vulnerable to attack by alkali that low temperatures and mild detergent solutions have to be used, with the risk that the removal of oils and fats may be incomplete. Complete purification is not practical, and it is usually accepted in commercial practice that the scouring has been satisfactory if the wool contains less than $\frac{1}{2}$ per cent of oil.

For the determination of residual oils about 5 g of the sample are dried in an oven, weighed in a stoppered weighing bottle, and extracted in a soxhlet extractor with ether or petroleum spirit. The apparatus is illustrated in Fig. 9.30. The wool is placed in the chamber C which is then connected with a flask containing the solvent, and a reflux condenser is inserted over the top. When the flask is heated on a water-bath, the vapour of the solvent passes through the tube on the left into the condenser. As it condenses it drops into the chamber C containing the wool, where it collects till it reaches the top of the siphon tube on the right. It then runs back into the flask and the cycle recommences. As a rule, about 3 hours are required to complete extraction. The flask is then removed, the solvent evaporated off on a water-bath, and the flask with the residue are dried in an oven and weighed.

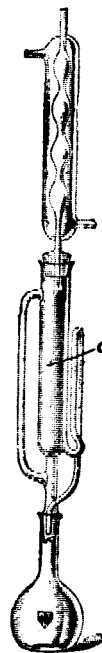

Fig. 9.30
Soxhlet
extractor

Scouring man-made fibres . . .

The man-made fibres are comparatively free from impurities and much milder methods of scouring therefore suffice. The regenerated celluloses have poor wet strength, unless they are the highly orientated varieties, and mechanical handling must be gentle. Fabrics should be scoured in stainless-steel winch machines, and not with heavy rollers such as are used for wool. The roughness of a wooden machine is liable to cause plucking of the threads by rupturing them in their weak wet state. Rayon yarns are scoured in a hank or package dyeing machine, and footwear in a paddle or rotating drum type made of smooth non-corroding metal. Regenerated rayons are scoured at 80° to 90°C with a 0.3 per cent solution

of soap or a synthetic detergent. Up to 1 per cent of the weight of the goods of sodium carbonate may be added, but this is rarely necessary.

Greater care must be taken when scouring cellulose acetates. If alkali be present and the temperature exceeds 75°C (167°F) the fibre commences to hydrolyse. The outermost layers of the fibre become converted to cellulose, which causes a reduction of lustre and an alteration in the dyeing properties. Since soap solutions themselves are slightly alkaline the temperature during scouring should, even in the absence of alkali, not exceed 85°C (185°F). The risk is less with synthetic detergents since they do not hydrolyse with the liberation of hydroxyl ions as does soap. Cellulose acetate becomes somewhat thermoplastic when in a hot wet state. If, under such conditions, it is allowed to lie in folds, especially when the weight of a pile of fabric presses on the fold, a permanent crease is liable to be formed. For this reason it is desirable to use long shallow machines with elliptical winches to prevent the formation of piles, and unduly prolonged runs in a hydro-extractor should be avoided.

Removal of alginate

Reference has already been made to the use of calcium alginate yarns as carrier threads, or for expendable welts. It is common, in finishing hosiery, to be faced with the necessity either of removing alginate as a separate operation or achieving the same thing during scouring.

Calcium alginate will dissolve in sodium hydroxide or carbonate at temperatures of 50° to 100° C. When scouring cellulose, nylon or polyester goods, alkalis can be used at high temperatures and the alginate will be dissolved. If any difficulty should be experienced, or if it is desired to scour at lower temperatures, the addition of Calgon or tetrasodium pyrophosphate assists by chelating or precipitating the calcium ions. About 2 lb per 100 gallons is usually an effective amount.

Removal of alginate from woollen goods is not quite so easy because the use of alkalis is prohibited. The goods can usually be scoured and dealginated simultaneously by treatment for about 30 minutes at 60°C (140°F) in a liquor containing a detergent and 2 lb per 100 gallons of tetrasodium pyrophosphate. It may be necessary to remove alginate from wool goods made out of dyed yarns. The addition of tetrasodium pyrophosphate increases the alkalinity of the scouring liquor and, if the colours are not of good fastness, this may lead to staining of adjacent threads. If the origin of the dyed yarn is unknown a laboratory test should be made before committing the bulk to dealgination. If there are indications that there may be staining, a preliminary soak for 30 minutes in a cold liquor containing 2 gallons of 28 to 30 per cent hydrochloric acid per 100 gallons, together with some wetting agent, can be beneficial. This converts the calcium alginate into alginic acid which can be removed with the tetrasodium pyrophosphate at 40°C (104°F) instead of 60°C.

Scouring silk

This presents special features because it is usually accompanied by the removal of the silk gum or sericin. The process is commonly referred to as 'boiling off'. Souple silk is raw silk from which about 10 per cent of the gum has been removed, and in ecru only about 4 per cent is taken away, the object being to cleanse the silk rather than to degum it. The boiling off, which depends upon the solubility of sericin in hot soap solution, with the possible addition of mild alkali, is the same for complete degumming, souple or ecru differing only in the time of treatment.

Degumming is carried out by treating the silk for 2 hours, or more if necessary, at about 95°C (203°F) in a 0.5 to 0.75 per cent solution of soap, using 3 gallons of liquor per pound of silk. Hosiery goods are packed into mesh bags and degummed in a rotary scouring type of machine, made out of metal with extremely smooth surfaces because of the tendency for the fibres to become ruptured. Hanks of yarn can be packed into bags and degummed in an annular cage forced-circulation machine, but they are also frequently hung over sticks and boiled off in an open bath, movement being provided by manual turning. The solubility of sericin in soap depends upon the alkalinity produced by hydrolysis, and for this reason the synthetic detergents are not so good. It has been demonstrated that silk can be degummed with a mixture of sodium carbonate and sodium bicarbonate, the concentration and proportions being adjusted to maintain the *pH* of the liquor at 10. Although it costs less the process has not found much favour because soap gives a better handle.

Vigorous movement, contact with rough surfaces, and exposure to mechanical stresses and strains are undesirable at all times during degumming, but especially when sodium carbonate has been added to the liquor. Under such circumstances the fibroin filament becomes ruptured, and bundles of the fibrils of which it is composed project from the surface giving 'lousy' silk.

10 · Bleaching

SCOURING generally removes all impurities except the natural colouring matters which have to be broken down by bleaching, either with an oxidizing or a reducing agent. Almost invariably the oxidizing agents give a more permanent white. When the colour is acted upon by a reducing agent, there is always the possibility that the oxygen in the air may reoxidize it to its original state.

The traditional oxidizing bleaching agent for cellulosic fibres was bleaching powder, which behaves as if it were calcium hypochlorite. For all practical purposes it has now been replaced by sodium hypochlorite, which is more convenient to handle and more constant in composition. Hydrogen peroxide, a powerful oxidizing agent, has been finding increasing application in bleaching cellulose, and there has been a notable extension of the use of sodium chlorite.

Bleaching powder is manufactured by spreading slaked lime on the floor in chambers made of material resistant to chlorine. Gaseous chlorine is introduced into the sealed chamber, in the top of which there is a glass window through which the progress of the reaction can be observed. As soon as the yellow colour of the chlorine disappears, more is introduced. This is repeated, the lime being turned occasionally with rakes between the additions of chlorine, until a permanent yellow colour appears in the gaseous phase, indicating that absorption is complete. Some fresh slaked lime is then added to absorb any occluded or residual chlorine and the powder is packed into air-tight drums. The temperature must be kept low during the reaction, otherwise there is a risk that calcium chlorate may be formed.

For a long time it was believed that bleaching powder was represented by the formula $\text{Ca}(\text{OCl})\text{Cl}$, but this conception has now been abandoned. Analytical results indicate that the composition corresponds with an equimolecular mixture of $\text{CaCl}(\text{OCl})$ and $\text{Ca}(\text{OH})_2$, but the existence of the substance $\text{CaCl}(\text{OCl})$ has never been proved conclusively. Evidence derived from X-ray diffraction diagrams suggests that bleaching powder is a mixture of calcium hypochlorite, $\text{Ca}(\text{OCl})_2 \cdot 4\text{H}_2\text{O}$, and basic calcium chloride, $\text{CaCl}_2 \cdot \text{Ca}(\text{OH})_2 \cdot \text{H}_2\text{O}$. The only chlorine which behaves as a bleaching agent is that present as hypochlorite. This is referred to as the active chlorine, and usually amounts to about 35 per cent by weight.

Bleaching powder is a white, apparently amorphous, substance. There will always be some unconverted lime so that a clear solution will not be obtained with water. On standing, the calcium hydroxide settles at the

bottom as a sludge. When bleaching powder is used it is necessary to have a comparatively large stock tank in which the solution can stand, so that the clear supernatant liquid can be withdrawn from above the sludge which has settled out. If a solution stands exposed to the air, the atmospheric carbon dioxide will react with the dissolved calcium hydroxide with the formation of a precipitate of calcium carbonate. When calcium hypochlorite is in solution in water there is a certain amount of hydrolysis, as shown in the equation:

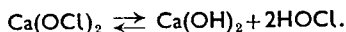

The removal of calcium hydroxide as carbonate favours the formation of free hypochlorous acid. Acids liberate hypochlorous acid:

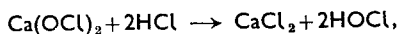

and in the presence of an excess of acid the hypochlorous acid undergoes decomposition with the liberation of free chlorine. When acidification is with hydrochloric acid the following reaction takes place:

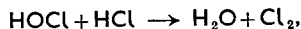

or with sulphuric acid the following series of reactions would take place:

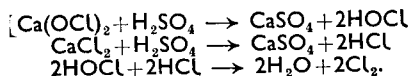

Sodium hypochlorite has virtually replaced bleaching powder. It is more constant in composition and is supplied as a concentrated solution in carboys or tanks ready for use. Chlorine is produced in large quantities as a by-product in the electrolytic manufacture of sodium hydroxide. A solution of salt is electrolysed, with the result that chlorine collects at the anode and sodium at the cathode. The sodium reacts with the water immediately to form sodium hydroxide, and the electrolytic cell is so constructed that the chlorine formed at the anode escapes before it has had an opportunity to come into contact with the sodium hydroxide.

Much sodium hypochlorite is manufactured by dissolving chlorine in a solution of sodium carbonate or sodium hydroxide:

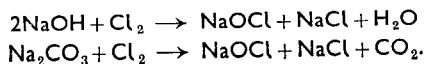

The chlorine must be admitted slowly, otherwise the temperature will rise, and sodium chlorate will be formed instead of the hypochlorite. A 3 to 4 per cent solution of sodium hydroxide should absorb 4 lb of chlorine for every 5 lb of sodium hydroxide, and 1 lb of chlorine should be required for every 3.5 lb of sodium carbonate. The consumer of hypochlorite can either purchase chlorine and make it on the site, or buy the hypochlorite. Where transport costs are high it is probably economical to buy chlorine, but

where distances are small it is customary to be supplied with sodium hypochlorite solution.

By electrolysis of a solution of sodium chloride the chlorine and sodium hydroxide can be formed in situ. They will then react immediately forming sodium hypochlorite solution. The first stage is the formation of Na^+ ions at the cathode and Cl^- ions at the anode. The sodium immediately reacts with water forming sodium hydroxide and, if the anode and cathode are sufficiently close to each other, the chlorine will react with the sodium hydroxide and the result will be a sodium hypochlorite solution. The available chlorine, however, in sodium hypochlorite solutions prepared in this manner is considerably less than that obtained by the process previously described.

Estimation of available chlorine

The composition of bleaching powder is by no means constant, and sodium hypochlorite tends to decompose on storage, especially when exposed to light and in hot weather. It is, therefore, often necessary to determine the amount of available chlorine in a delivery or a stock solution. The estimation is based upon the quantitative liberation of iodine from potassium iodide in an acidified solution, the iodine then being titrated with $\text{N}/10$ sodium thiosulphate, using starch as the indicator.

When determining available chlorine in bleaching powder, about 10 g of the sample are weighed and mixed with water in a mortar until the consistency is that of a thin cream. After allowing the mixture to stand for a few minutes the cream is decanted into a litre-graduated flask, the coarser particles remaining as a residue in the mortar. These are again ground with water and decanted, the process being repeated till the whole of the powder has been transferred to the graduated flask. The suspension is then made up to one litre with water and, after a thorough shaking, the sediment is allowed to settle. 25 ml of the clear supernatant liquid are withdrawn with a pipette, transferred to a conical flask, potassium iodide and acetic acid are added, and titration is then carried out with $\text{N}/10$ sodium thiosulphate solution, using starch as the indicator. Each millilitre of $\text{N}/10$ thiosulphate corresponds with 0.00355 g of available chlorine. Thus if 9.8 g was the

weight of bleaching powder, then $\frac{25}{1000} \times 9.8 =$ weight of bleaching powder

titrated, i.e. 0.245 g, and if it required 25 ml of thiosulphate this weight would contain 25×0.00355 g of chlorine = 0.08875 g. Therefore the per-

centage of available chlorine is $\frac{0.08875 \times 100}{0.245} = 36.2$. Decinormal sodium

thiosulphate solution is prepared by dissolving 24.8 g of pure recrystallized thiosulphate in distilled water and making up to 1 litre in a graduated flask. The solution is not very stable and should be stored in a dark place or a darkened bottle and discarded if there are signs of sulphur separating out.

The method described above is usually sufficiently accurate for routine works control, but chlorates, which are always present, will also liberate iodine from potassium iodide. A more accurate method is based on titration with a standard solution of arsenious oxide which is oxidized by the available chlorine into arsenic oxide according to the following equation:

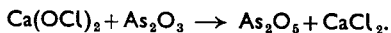

The N/10 solution of arsenious oxide is prepared by dissolving 4.95 g of arsenious oxide and 25 g of crystalline sodium carbonate in 200 ml of distilled water at the boil. When a clear solution has been formed it is cooled and made up to 1 litre with distilled water. The hypochlorite is then titrated until there is no available chlorine left. The end point is determined by using starch-iodide paper as an external indicator, and removing a drop of the solution being titrated on a glass rod and placing it upon the iodized starch paper. When the drop no longer turns the paper blue the end point has been reached. The starch-iodide paper is made by dissolving a few grams of potassium iodide in starch solution and immersing a strip of filter paper in it and subsequently drying. Each millilitre of decinormal arsenious oxide required is equivalent to 0.00355 g of chlorine.

The use of an external indicator is somewhat tedious, but the titration can be simplified by using indigo carmine. This substance is readily decolorized by the available chlorine. A measured volume of arsenious oxide solution such as 25 ml, together with a little hydrochloric acid, are placed in a titration flask and a few drops of indigo carmine solution are added. The hypochlorite is then run in from a burette until the blue colour changes to a yellowish tinge.

When titrating commercial sodium hypochlorite it is convenient to make 25 ml up to 500 ml with distilled water in a graduated flask and titrate 5 ml of this solution with N/10 thiosulphate.

Whilst sodium hypochlorite has replaced bleaching powder in areas where it is economical to deliver concentrated solutions in carboys or tanks, and where the period between production and use will not be too long, bleaching powder still has uses where transport is costly and good storing properties are important. The bleaching powder must first be brought into a state of solution. The powder is ground in a mill or rubbed through a sieve into a stone or concrete extraction tank containing water, preferably at a temperature of 24° to 27°C (75° to 80°F). The mixture is then agitated, if possible by a mechanical arrangement, for about 20 minutes, after which it is allowed to settle. The clear liquor is then drawn off the top and run into a storage tank and the sludge may be extracted once more to ensure that no available chlorine is left. Fig. 10.1 shows a typical arrangement in which the dissolving tank at the upper level has a mechanically-driven stirrer, and a sludge outlet is located at the bottom, and pipes with taps for draining off the supernatant liquor are at different levels. The storage tank for the clear

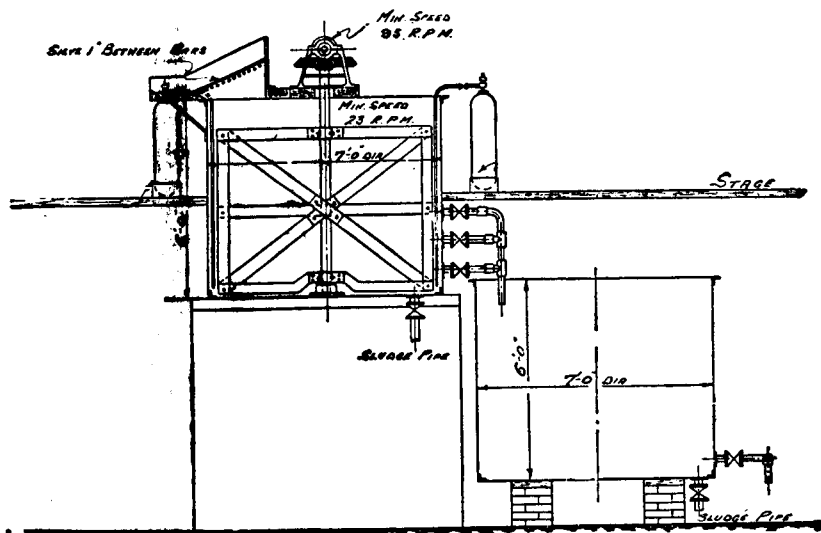

Fig. 10.1 Arrangement for preparation of bleaching powder solution

solution is below. Solutions obtained in this way will have specific gravities of 5° to 15°Tw, corresponding with available chlorine contents of 14.5 to 45.6 g per litre. The activity of the solution can be measured with a Twad-dell hydrometer, but this leaves much to be desired from the point of view of accuracy.

Table 10.1 Gravities and available chlorine in liquors used for bleaching

°Tw	sp gr	g per litre
0.3	1.0015	1
0.72	1.0036	2
1.1	1.0055	3
1.5	1.0075	4
1.8	1.0090	5
2.2	1.0110	6
2.5	1.0125	7
2.9	1.0145	8
3.1	1.0155	8.5

When cotton goods are to be bleached they are scoured or kier-boiled and then packed into a cylindrical or rectangular vessel which may be made of wood, stone, cement lining, or stainless steel. The vessel has a perforated

false bottom with an outlet to a sump below which had an equal capacity (Fig. 10.2). The liquor in the sump is made up to the desired concentration of available chlorine with bleaching powder or sodium hypochlorite solution. It is then pumped up and spread, through sprinklers, over the top of the cotton goods, through which it percolates to find its way ultimately into the sump again. The concentration of available chlorine required in the bleach liquor varies between 1 and 3 g per litre, but for most purposes good results can be obtained with 1.5 g per litre. When bleaching-powder solutions are used some device for distributing a spray over the top of the cotton is desirable, not only because it spreads the bleach but also because it affords an opportunity for atmospheric carbon dioxide to combine with the dissolved calcium hydroxide and thereby increase the activity of the solution. As was the case with kier-boiling, so with bleaching it is most important to pack the load uniformly so that it does not offer channels of reduced resistance.

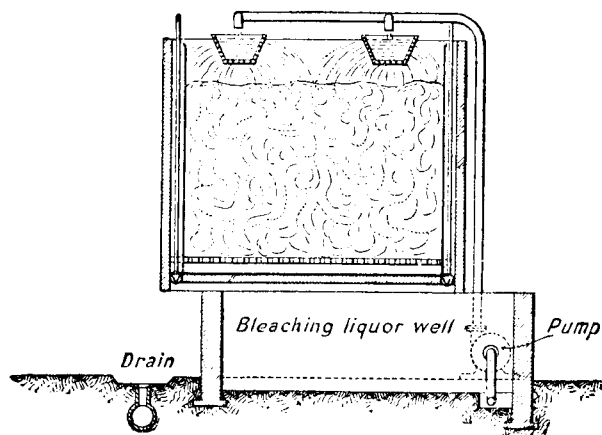

Fig. 10.2 Hypochlorite bleaching unit

Commercial sodium hypochlorite solutions generally contain 15 to 18 per cent of available chlorine. One gallon per 100 gallons of water will therefore make a bleaching liquor which contains near enough to 1.5 g per litre of available chlorine for most practical purposes. Sodium hypochlorite is quite strongly alkaline and there is no risk that the pH can fall below 10, as may happen with bleaching powder.

With bleaching powder there is a possibility that traces of calcium carbonate may be left in the cotton and will make it harsh. A rinse in a cold solution containing 0.5 per cent of the weight of the goods of hydrochloric acid to dissolve the carbonate is necessary. This treatment also removes any

iron stains which may have been picked up, and decomposes residual traces of hypochlorites, converting them into free chlorine. Although no insoluble carbonates are formed, acid treatment is frequently applied after a sodium hypochlorite bleach to remove iron stains. The proteins form chloramines which gradually decompose, causing discoloration and an odour. An 'anti-chlor' treatment will reduce the —NHCl groups and also remove any traces of free chlorine. It consists of running the goods for 15 minutes at 40°C (104°F) in a liquor containing 1 to 2 per cent of the weight of the cotton of sodium sulphite or sodium bisulphite.

Effect of pH on bleaching

The basic factor to be borne in mind when bleaching with hypochlorites is that the active component can exist in three different states.

- (i) At pH greater than 10 the hypochlorite is present as NaOCl or Ca(OCl)_2 .
- (ii) Between pH 5 and 8.5 the solution consists predominantly of hypochlorous acid.
- (iii) As the pH falls below 5 the liberation of chlorine begins to take place, and when the pH falls below 3 the whole of the hypochlorous acid has been converted into chlorine.

The subject has been studied by Ridge and Little (*J. Text. Inst.* 1942, 33T, 59). The equilibria at different pH values are governed by the reactions:



The fraction of the hypochlorite existing as free hypochlorous acid increases as the pH falls below 10 until at pH 5 it is virtually 100 per cent, see Table 10.2 (RIDGE AND LITTLE, *loc. cit.*).

Table 10.2

pH	Fraction of hypochlorite as HOCl
10.0	0.003
9.0	0.03
8.0	0.21
7.43	0.50
7.0	0.73
6.5	0.91
6.0	0.96
5.0	0.997

Then as the pH falls still lower the ratio of chlorine to hypochlorous acid increases as shown in Table 10.3.

Table 10.3

pH	Ratio $Cl_2/HOCl$
5.0	0.00045
4.0	0.0045
3.5	0.014
3.0	0.045
2.5	0.14
2.0	0.45
1.5	1.41
1.0	4.5

The fraction existing as hypochlorous acid over a range of pH values is shown clearly in the graph in Fig. 10.3. BIRTWELL, CLIBBENS AND RIDGE (*J. Text. Inst.*, 1925, 16T, 36 and *J. Text. Inst.*, 1927, 18T, 135) demonstrated that there was a remarkable acceleration in the rate of oxidation of cellulose by hypochlorite solutions between the pH range of 5 and 9. This is shown clearly in Fig. 10.4 in which the fluidities of cotton bleached for 5 hours in a hypochlorite solution containing 3 g per litre of available chlorine are plotted against the pH of the bleaching liquor. A comparison of the graphs in Figs. 10.3 and 10.4 indicates that the region of maximum degradation of the cellulose by oxidation bears a relationship to the existence of free hypochlorous acid. The determination of the pH of bleaching liquors is obviously important. It can be done electrometrically but, for

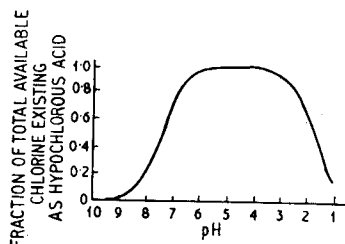

Fig. 10.3 Relationship between pH and proportion of hypochlorous acid in solution

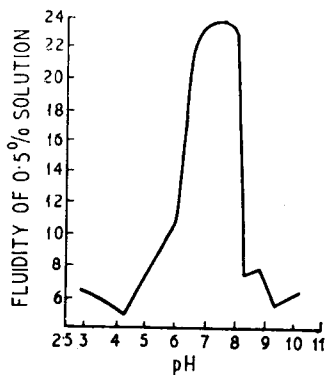

Fig. 10.4 Relationship between fluidity and pH

works control, the use of an indicator is often more convenient. Unfortunately most indicators cannot be used directly because hypochlorites bleach them. If, however, a slight excess of neutral hydrogen peroxide is added the hypochlorite will be destroyed without alteration of the pH, and there are many indicators such as universal indicator, phenolphthalein, and thymol blue which are not sensitive to traces of hydrogen peroxide.

Table 10.4 Quantities of buffer reagents

		Cotton and rayon			Linen			Jute		
		g/litre or lb/100 gal								
Available chlorine in bleach liquor		0.5	1.0	2.0	3.0	5.0	8.0	4.0	6.0	8.0
pH	Buffer reagent	Bleaching powder					Clear solutions			
11 to 12	Lime	1	1	1.5	1.5	3	3	3	4	4
11	Soda ash	4	5	7	10	14	20	15	20	25
9.5/9	Borax	1	2	3	3	4.5	6	3	4.5	6
8	Boric acid	3	4	5	5	6	8	5	6	8
8.5/7.5	Sesquicarbonate	5	5	5	8	8	8	10	10	10
7.5/6.5	Bicarbonate	5	5	5	6	8	10	10	10	10
5	Acetic acid	1	2	3	3.5	6	10	4	7	10
4	Aluminium sulphate	1.5	2.5	5	8	13	20	10	15	20
		Sodium hypochlorite								
11	Soda ash	2	5	5	5	7	10	5	10	15
10	Sesquicarbonate	2	5	5	5	7	10	5	10	15
9	Borax	1	2	3	3	5	6	3	5	6
9	*Pyrophosphate	2	3	4	4	6	8	5	8	10
	+ gallons acid	0.05	0.1	0.1	0.15	0.25	0.35	0.2	0.3	0.4
8	Boric acid	3	4	5	5	7	10	5	8	10
7.5/6.5	*Bicarbonate	5	5	5	5	8	10	5	8	10
	+ gallons acid	1	1	1.5	2	3	5	2	3	5
5	Acetic acid	1	2	3	3.5	6	10	4	7	10
5	*Calcium acetate	1	2	3	4	6	10	4	7	10
	+ Gallons acid	0.4	0.7	1.3	1.9	3.2	5.2	2	3.8	5.2
4	Aluminium sulphate	1.5	3	6	10	15	25	12	18	25

A normal liquor made up with bleaching powder will have an initial pH of 11.05, and when sodium hypochlorite is used it will be 11.55. In each case the pH falls during mangleing and with subsequent bleaches when standing baths are used. The atmospheric carbon dioxide forms insoluble calcium carbonate with bleaching powder and soluble alkaline sodium carbonate with sodium hypochlorite. The risk that the pH may fall below the

danger level of 9 is much greater with bleaching powder. The addition of a buffer which will maintain the pH in the range of 9 to 11 is to be recommended, especially when bleaching powder is used or standing baths are in operation. With bleaching powder the addition of lime ($\text{Ca}(\text{OH})_2$) in the proportion of 1 to 1.5 lb per 100 gallons (1 to 1.5 g per litre) gives an adequate measure of control. Sodium hypochlorite will be buffered between 10 and 11 by the addition of 5 g per litre of sodium carbonate, or at about pH 10 by 5 g per litre of sodium sesquicarbonate ($\text{Na}_2\text{CO}_3 \cdot \text{NaHCO}_3 \cdot 2\text{H}_2\text{O}$) made by crystallizing equimolecular quantities of Na_2CO_3 and NaHCO_3 . The quantities of buffer for different cellulosic yarns and various concentrations of available chlorine are shown in Table 10.4 (RIDGE AND LITTLE, *loc. cit.*). The buffers marked * require the addition of acid to the bleach liquor to reduce the initial pH to the value stated in column 1. The proportions of acid given relate to 100 per cent HCl, and for practical purposes should be converted to 36 per cent or 28 per cent according to which is available (RIDGE AND LITTLE, *loc. cit.*).

Activated hypochlorite solutions buffered to pH 7 with sodium bicarbonate have been used for extremely rapid bleaching. A good white can be obtained in about one-fifth of the time required at pH 10. Rapid bleaching, however, is accompanied by a serious risk of oxidation, and the process has not found widespread practical application.

Effect of temperature

A description of the effect of temperature upon hypochlorite bleaching has been given by Derry (*J.S.D.C.*, 1955, **71**, 884). Having established that there was a quantitative relationship between the oxygen consumed and the increase in fluidity, a simple method of investigating the effect of temperature was established. The conclusions are summarized in Table 10.5 (DERRY, *loc. cit.*). Several cottons were bleached to the same degree of white as shown by the reflectance factor in the right-hand column, at temperatures ranging from 20° to 60°C (68° to 140°F). For approximately equivalent increases in fluidities the time required for bleaching ranged from 360 minutes at 20°C (68°F) to 6.8 minutes at 60°C (140°F). It is

Table 10.5

Temperature °C(°F)	Duration of bleach (min)	Increase in fluidity	Reflectance factor
Unbleached	control	2.7*	0.6
20 (68)	360	2.7	0.89
30 (86)	133	2.8	0.88
40 (104)	49.4	3.2	0.89
50 (122)	18.3	3.2	0.88
60 (140)	6.8	2.7	0.87

* Original fluidity.

apparent, therefore, that it would be possible to bleach at 60°C, but the exactitude of the control demanded would be too great for practice. Bleaching at 40°C (104°F), however, is quite usual and can be carried out with great saving of time.

There are certain substances which exert a catalytic effect upon the oxidation of cellulose by hypochlorites. Traces of copper and iron are active and, if present in the cotton when it enters the bleaching bath, can cause serious tendering and even complete disintegration. Certain yellow and orange vat dyes also cause catalytic degradation of the cellulose if there is simultaneous exposure to the action of hypochlorite and sunlight. It is not uncommon, when goods containing effect threads dyed with the vat dyes in question are bleached in an uncovered bath, for those on the surface to be tendered but the others, protected from the light, to be unaffected.

Hydrogen peroxide

Hydrogen peroxide is virtually the only bleaching agent available for protein fibres and it is also used very extensively for the cellulosic fibres. It was at one time thought that its oxidizing action depended upon the fact that it readily underwent decomposition with the liberation of oxygen:

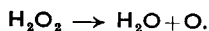

This explanation, however, is no longer tenable. There is no absolute certainty about the nature of the bleaching action but it is believed that the perhydroxyl ion is the active species. These ions are formed when hydrogen peroxide dissociates in the following manner:

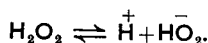

It is a well known fact that bleaching is more rapid in alkaline than in acid solutions. This may well be because the hydroxyl groups present in the alkaline liquor neutralize the hydrogen ions thereby promoting the liberation of perhydroxyl ions.

The traditional method of manufacturing hydrogen peroxide is to use barium oxide as the starting point. When heated to 400°C (752°F) in a current of air it is converted into barium peroxide:

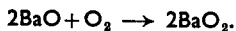

If the barium peroxide be suspended in water and a current of carbon dioxide be passed through, hydrogen peroxide is formed with the precipitation of barium carbonate:

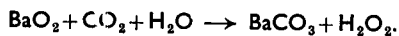

The barium carbonate can be separated by filtration and when heated loses carbon dioxide, leaving barium oxide which is available for reversion into barium peroxide. The hydrogen peroxide will be in the filtrate which can be concentrated by evaporation under reduced pressure.

The traditional method for making hydrogen peroxide was later replaced by the electrolytic process. When a saturated solution of potassium sulphate is electrolysed, with adequate cooling, hydrogen appears at the cathode, and at the anode potassium persulphate, $K_2S_2O_8$, instead of oxygen, collects as a white crystalline mass. When this is acidified with dilute sulphuric acid persulphuric acid is liberated which, on distillation, decomposes to sulphuric acid and hydrogen peroxide:

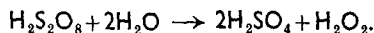

The distillate is a pure solution of hydrogen peroxide which can be concentrated further by evaporation at 35° to $40^\circ C$ (95° to $104^\circ F$) under a pressure equivalent to 13 mm.

Barium peroxide and electrolytic methods have now been superseded by a process based on the oxidation of 2-ethyl anthraquinol by atmospheric oxygen :

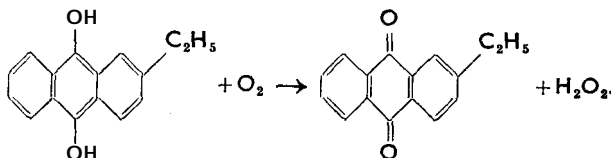

The 2-ethyl anthraquinone formed during the reaction is reduced back to 2-ethyl anthraquinol by catalytic reduction with hydrogen in the presence of palladium.

The reactions are carried out in a mixture of organic solvents, and the hydrogen peroxide is removed by aqueous extraction. An approximately 20 per cent solution is obtained which can be concentrated further by vacuum distillation (*Industrial Chemist*, January 1959, 1).

The strength of commercial hydrogen peroxide is expressed in terms of the volume of oxygen liberated by a unit of volume of the solution. Thus a 10-volume peroxide solution is one of which 1 ml is capable of liberating 10 ml of oxygen. The relationships between volume and percentage concentrations are tabulated below:

<i>Volume</i>	<i>Weight per cent</i>
3.3	1
10	3
100	27.2
110	30

The strength of a hydrogen peroxide solution can be estimated by titration with $N/10$ potassium permanganate. If the strength of the sample exceeds 5 vol it should be diluted 1 in 10, and 25 ml of the resultant solution are titrated, after acidification with sulphuric acid, with $N/10$ permanganate until a permanent pink colour makes its appearance. If the original sample

is 30 vol it is advisable to titrate 10 ml of the diluted solution and to take 5 ml for a 100-vol hydrogen peroxide. Bleaching baths are usually between 1 and 2 vol and 5 ml of the liquor itself can conveniently be titrated when:

<i>ml N/10 permanganate required</i>	<i>Volume strength of bleach liquor</i>	<i>Weight per cent</i>
8.8	1	0.3
13.2	1.5	0.45
17.6	2	0.6

The expression of strength by volume has now to a great extent fallen into disuse. It is customary to use the factor per cent of hydrogen peroxide by weight or g per 100 g, abbreviated to (w/w).

The calculations are based on the fact that 1 ml of N/10 potassium permanganate equals 0.0017 g of hydrogen peroxide, or 0.5605 ml of gaseous oxygen at NTP.

Hydrogen peroxide is a colourless liquid soluble in water in all proportions. It is reasonably stable when the pH is below 7, but tends to become more unstable as the alkalinity increases. Commercial hydrogen peroxide, therefore, is made slightly acid so that it will not lose strength during storage. The strengths supplied in bulk for processes such as bleaching are:

<i>Per cent H₂O₂ (w/w)</i>	<i>Approximate volume</i>
27.5	100
35	131
50	197

Solutions of hydrogen peroxide of more than 20 volumes cause intense irritation when they come into contact with the skin and should be washed away immediately.

Cotton is usually bleached in a 1-volume liquor at the boil. The most important factor in bleaching is to achieve the right degree of stability in the bleach liquor. If the pH be too low no perhydroxyl ions are set free and bleaching does not take place; when the liquor is too unstable the whole of the oxygen is liberated and escapes into the atmosphere before it has had time to act upon the cotton. Reference has already been made to the catalytic activity of copper and iron, and neither of these metals should enter into the construction of bleaching vats at any point. Stainless steel (F.M.B. or F.D.R. qualities) is entirely satisfactory, but stoneware, concrete-lined, or plastic-lined vessels are also used. Iron or steel vessels such as kiers can be used if a silicate cement lining is applied.

The bleaching liquor must be made alkaline, otherwise it would be too stable, but it is virtually impossible to adjust to the optimum pH with alkali alone and there is a marked tendency for the liquor to be too unstable however carefully it has been made alkaline. It is, therefore, necessary to

add a stabilizer, and of all the substances which have been tried sodium silicate is the most effective. The liquor is brought to a pH between 10.8 and 10.9 with a mixture of sodium hydroxide and sodium carbonate. If the pH is lower than this, not only will the bath be too stable but there will also be a tendency for hydrated silica to be precipitated which, if left in the goods, can cause a harsh handle. It is also undesirable to rely solely upon sodium hydroxide as the alkali because not only does a high caustic soda concentration cause precipitation of silica, but it also leads to higher fluidities. When the alkali added is expressed as the ratio $\text{Na}_2\text{O}:\text{SiO}_2$ it will be seen in the table below that as the concentration of Na_2O increases the fluidities are lower when it is brought about with a mixture of NaOH and Na_2CO_3 (LAPORTE, *Bleaching Manual*), Table 10.6.

Table 10.6

$\text{Na}_2\text{O} : \text{SiO}_2$ g/litre	Fluidities	
	NaOH	NaOH + Na_2CO_3
1 : 2	3.1	3.3
1.5 : 2	3.5	3.3
2 : 2	3.5	3.4
3 : 2	5.2	3.6
4 : 2	5.7	3.6
5 : 2	6.5	3.9

Commercial sodium silicate can be contaminated with iron and other impurities. The brands known as J.81 (I.C.I.) and Pyramid Brand sodium silicate No. 1 (J. Crosfield & Sons Ltd) are recommended because they are prepared with the required degree of purity.

When bleaching with hydrogen peroxide, it is advantageous to introduce the cotton into the liquor in an unscoured or only partially-scoured state. The impurities do not form objectionable derivatives with hydrogen peroxide as they do with hypochlorites, and they exert a useful stabilizing action. The water should have 2-5 degrees of hardness because of the stabilizing effect of traces of calcium and magnesium salts, and when the water supply is of zero hardness, 1 oz per 100 gallons (0.06 g per litre) of magnesium sulphate should be added.

The basic formula for making up a 0.3 w/w bleaching bath would be:

Sodium silicate 79° Tw	7 lb	0.7 kg
Sodium hydroxide	$\frac{1}{2}$ lb	0.05 kg
Sodium carbonate	$1\frac{3}{4}$ lb	0.175 kg
Hydrogen peroxide (35 per cent)	$\frac{3}{4}$ gallon	or 0.75 litre
or Hydrogen peroxide (50 per cent)	$\frac{1}{2}$ gallon	0.5 litre
Water to make up to	100 gallons	100 litres

(*Bleaching Manual* Lapore Industries Ltd)

A more recent recommendation to avoid the risk of the precipitation of silica is to replace at least 50 per cent of the sodium silicate normally used by trisodium phosphate (Chesner, *J.S.D.C.*, 1963, 79, 140).

Many variations of this basic formula may be found possible according to the nature of the material, the degree of white called for, and the construction of the plant. The liquor ratio for a bath made up as described above should be between 10:1 and 20:1.

Peroxide bleaching in kiers

Cloths which are peroxide-bleached in a kier are desized, if necessary, washed into the kier, hydrogen-peroxide bleached, soda-ash scalded, and washed out with water in the kier. Because liquor ratios in kiers are so very low the above recipe for a 1-volume liquor is not applicable, and the peroxide and other additions are calculated as percentages of the weight of the cloth as follows:

	<i>Per cent</i>
Sodium silicate	2-3
Caustic soda	0.3-0.8
Soda ash	0.6-1.0
Hydrogen peroxide (35 per cent)	3-5
or Hydrogen peroxide (27.5 per cent)	4-6
Wetting agent	0.1-0.5

The caustic soda should be omitted when the cloth has previously had a soda boil. The kier is filled with about one-third of the total volume of water which will be required, the temperature raised to 49°C (120°F) and the chemicals added. The cloth is then fed in and the remainder of the water added. The temperature is raised to 66° to 71°C (150° to 160°F) in not less than 30 minutes, after which steam is turned off for 10 minutes. Circulation ceases and occluded air escapes. The temperature is then raised to 82°C (180°F) and steam turned off for a further 10 minutes in case all the air has not escaped. The lid is then clamped down and the pressure raised to 20 lb/sq in., and bleaching is continued for a period of 2 to 3 hours. The pressure and temperature are governed by the stability of the peroxide liquor and, until a process is well established, checks on the peroxide concentration should be made at frequent intervals.

When bleaching cotton yarn in a package machine or a winch, better results are often obtained with a 0.6 per cent (w/w) liquor made up according to the following recipe:

Water	98 gallons	98 litres
Sodium silicate	7 lb	0.7 kg
Caustic soda	$\frac{1}{2}$ lb	0.05 kg
Soda ash	$1\frac{3}{4}$ lb	or 0.18 kg
Wetting agent	1 lb	0.1 kg
Hydrogen peroxide (35 per cent)	$1\frac{1}{2}$ gallons	1.5 litres
or Hydrogen peroxide (50 per cent)	1 gallon	1.0 litres

When using a 0.6 per cent w/w liquor it is desirable, if possible, to have a storage tank to which it can be transferred and retained for further use because the peroxide will not all be consumed. The liquor can then be regenerated for use again, the best means being to add sufficient water to restore it to its original volume, and then to ascertain the peroxide content by titration with potassium permanganate and the alkalinity with N/10 hydrochloric acid using phenolphthalein as the indicator. The necessary additions can be calculated, the alkali being added in the ratio of 5 parts of soda ash to 3 parts of caustic soda. There is a tendency for the liquor to become heavily loaded with impurities after it has been regenerated a few times, with a consequent deterioration in the colour of the bleached cotton.

When bleaching in package form, some harshness can occasionally be caused by deposition of traces of silica which cannot be washed out. A recipe with a reduced amount of sodium silicate, as shown below, may be used to lessen this risk.

Water	98 gallons	98 litres
Sodium silicate 78°Tw	3 lb	0.3 kg
Caustic soda	1 lb	0.1 kg
Soda ash	1 $\frac{3}{4}$ lb or	0.18 kg
Wetting agent	1 lb	0.1 kg
Hydrogen peroxide (35 per cent)	1 $\frac{1}{2}$ gallons	1.5 litres
or Hydrogen peroxide (50 per cent)	1 gallon	1.0 litres

When exceptionally good whites are necessary, or the fibres are particularly resistant to bleaching, the cost of hydrogen peroxide becomes excessive. In such cases good results are obtained by bleaching first with hypochlorite and then with peroxide. It is possible to reduce the hypochlorite, probably to 1 g per litre of available chlorine, placing greater reliance upon the peroxide stage to destroy the colouring matters. The peroxide has much less degrading action on the cellulose and good results are obtained with this combined bleach without excessive increase in the fluidity. If sodium sulphite or bisulphite is used as an antichlor it should be thoroughly rinsed away because it would reduce the peroxide and render it ineffective.

Sodium peroxide, Na₂O₂, is formed when sodium is burned in an atmosphere of oxygen. It was originally made by exposing molten sodium to air in shallow trays, carried on a conveyor through a furnace heated to approximately 300°C. An improved method which is now in universal use consists of a two stage oxidation:

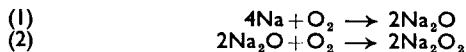

The metallic sodium is converted into sodium monoxide by oxidation in a revolving furnace to which only the theoretical quantity of oxygen is admitted. The granular sodium monoxide thus obtained is transferred to a

second oxidizing unit where it is continuously converted into sodium peroxide. It is a yellowish powder which decomposes quite rapidly on exposure to air because the moisture converts it into sodium hydroxide and oxygen:

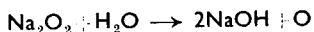

It is not without danger because, if it comes into contact with organic matter, it can bring about spontaneous combustion. When it is added to water and the temperature is kept low, hydrogen peroxide is liberated:

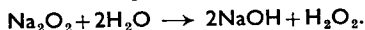

It can therefore be used as a source of hydrogen peroxide for bleaching.

To make a bleaching liquor the requisite amount of sodium peroxide is weighed out and added slowly either to the previously filled bleaching machine or into a separate tank containing 10 to 20 gallons of water, with constant stirring. Water should never under any circumstances be added to sodium peroxide. The temperature must not be allowed to rise during dissolving, otherwise there will be excessive loss of active oxygen. The skin and eyes should be protected against accidental splashes. The amounts of sodium peroxide required per 100 gallons of water to give bleach liquors of various volume strengths are tabulated below.

<i>Per cent w/w</i>	<i>Volume</i>	<i>Sodium peroxide per 100 gallons (lb)</i>
0.075	$\frac{1}{4}$	1.8
0.15	$\frac{1}{2}$	3.7
0.3	1	7.4
0.6	2	15.0
0.9	3	23.3

Sodium hydroxide will be formed, and the pH of the solution will be in the region of 11.5 to 12, at which the hydrogen peroxide will be too unstable for most purposes. It is, therefore, desirable to neutralize with sulphuric acid. For the complete neutralization 1.3 lb of 96 per cent sulphuric acid are required for each pound of sodium peroxide. Neutralization of part of the sodium hydroxide to bring the pH to 10.9 is adequate for bleaching cotton, and between 0.65 and 1 lb of 96 per cent sulphuric acid will achieve this. As with hydrogen peroxide bleaching, the addition of sodium silicate will act as a stabilizer. Various recommended formulae for making up liquors are tabulated in Table 10.7 on page 239.

The temperature is raised in stages to 95°C (203°F). The purpose of adding bicarbonate is to convert some of the caustic to carbonate alkalinity. A combined hypochlorite and sodium peroxide process is recommended for especially good whites. A preliminary bleach in a hypochlorite liquor containing 1.5 g per litre of available chlorine at 35° to 40°C (95° to 104°F) for half an hour is followed by a peroxide treatment as specified in the right-

hand column in Table 10.7 below. The quantities quoted are only to be used as guide because it will often be desirable to modify them according to circumstances.

Sodium perborate may either be a true per-salt such as $\text{NaOOBO}\cdot 4\text{H}_2\text{O}$ or a salt containing hydrogen peroxide in a form analogous to water of crystallization i.e. $\text{NaBO}_2\cdot\text{H}_2\text{O}_2\cdot 3\text{H}_2\text{O}$.

It is prepared by the action of sodium peroxide on borax:

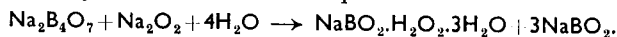

In the course of the reaction three molecules of sodium metaborate appear as a by-product. The addition of a further three molecules of hydrogen peroxide converts these as well into perborate.

Table 10.7

	<i>Kiers liquor</i> (ratio 4 : 1)	<i>Winch bleaching knitted web</i>	<i>Two-stage cotton packages oxidizing</i>		<i>After hypochlorite bleach</i>
			<i>Scour</i>	<i>Bleach</i>	
Magnesium sulphate	1½ lb	2 oz	2 oz	2 oz	2 oz
Sodium silicate J.81	90 lb	1-3 lb	3 lb	5 lb	5 lb
Sodium peroxide	72 lb	6 lb	3 lb	5 lb	4 lb
Sulphuric acid 96 per cent	78 lb	6.5 lb		5 lb	4 lb
Sodium bicarbonate	30 lb	1 lb		3 lb	2 lb
Water	1200 gal	100 gal	100 gal	100 gal	100 gal
Time	4-5 hr	2 hr	1 hr	2 hr	2 hr

Sodium percarbonate has now to a great extent replaced sodium perborate. It is an addition compound of hydrogen peroxide and sodium carbonate, $2\text{Na}_2\text{CO}_3\cdot 3\text{H}_2\text{O}_2$. A one per cent solution has a pH of 10.5, which is very suitable for bleaching. One pound dissolved in 100 gallons of water would give the equivalent of a 0.5 per cent (w/w) solution of hydrogen peroxide.

Both sodium perborate and percarbonate are used most frequently as additives to scouring liquors when a full white is not necessary, such as in improving the ground colour for dyeing pale or bright shades. Between one and two pounds of the per-compound are added, together with a detergent, and scouring is continued at the boil for one hour.

Peracetic acid finds an application, mainly in the bleaching of polyamide fibres. It is the acetyl derivative of hydrogen peroxide:

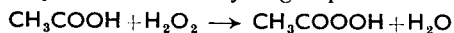

It may be obtained by mixing together acetic anhydride and 90 per cent hydrogen peroxide in the presence of a catalyst such as 1 per cent of sulphuric acid. It is now manufactured by the oxidation of acetaldehyde

to acetaldehyde monoperoacetate which is easily broken down by heat into peracetic acid and acetaldehyde, the latter being removed by distillation:

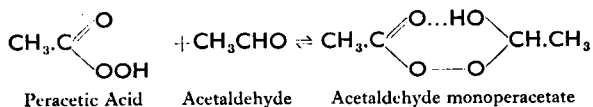

For bleaching it is customary to use a 0.3 per cent solution of commercial 40 per cent peracetic acid. The pH of the liquor is adjusted to between 6.0 and 7.5 with sodium hydroxide and bleaching is continued for one hour at 82°C (182°F).

Sodium chlorite is an addition to the range of oxidizing bleaching agents suitable for cellulose and synthetic fibres. It is a finely divided crystalline white powder obtained when chlorine peroxide reacts with sodium peroxide:

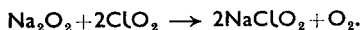

It is manufactured on a large scale from chlorine dioxide obtained from sodium chlorate:

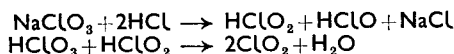

To prevent the hypochlorous acid reacting with hydrochloric acid to form free chlorine a reducing agent must be present to convert the former into hydrochloric acid.

Chlorine dioxide is dissolved in sodium hydroxide solution:



The sodium chlorate which appears as a by-product can be reduced by the addition of hydrogen peroxide:

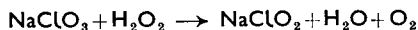

and the resultant solution is evaporated to obtain approximately 80 per cent commercial crystalline sodium chlorite.

Sodium chlorite is not a bleaching agent and must be acidified in order that chlorine dioxide can be liberated, which in acidic solutions can undergo the following reactions:

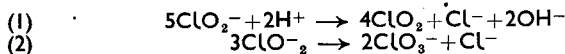

There is evidence to support the view that it is the chlorine dioxide produced in equation (1) which is the active species so far as bleaching is concerned.

For bleaching cellulosic fibres the chlorine dioxide is liberated with an organic acid. If the pH value is higher than 4.5, bleaching becomes very slow, and if below 3.0, the liberation of chlorine dioxide will be so rapid that it will be lost from the liquor before it has performed its function.

Cotton should be bleached at pH values between 3.5 and 4.0, rayons at 4.0, and synthetic fibres at 3.8 to 4. Organic acids are preferred because it would not be possible to obtain fine adjustment of pH with mineral acids. Where the goods are alkaline it is possible, in order to save cost, to bring the value down to pH 5 with sulphuric acid and to make the final adjustment with an acetic or formic acid. It is quite common to add buffers such as sodium acetate, sodium pyrophosphate, sodium dihydrogen phosphate, disodium hydrogen phosphate, or tetrasodium pyrophosphate. As a general guide it can be assumed that the following amounts of 80 per cent sodium chlorite are required:

Rayon	0.4 to 0.5 per cent on the weight of goods
Cotton	1.2 to 2 per cent on the weight of goods
Cotton and rayon blends	0.8 to 1 per cent on the weight of goods
Synthetic fibres	1 per cent on the weight of goods

Commercial sodium chlorite is normally supplied at 80 per cent strength. Its effectiveness as a bleaching agent depends, to a considerable extent, upon the liquor ratio, which implies that considerable adjustment of the quantities quoted above may be necessary. A formula for bleaching cotton in a 1:5 liquor ratio might be:

Chlorite (80 per cent)	1.4 to 1.6 per cent
Sodium pyrophosphate	0.35 per cent
Sulphuric acid	0.1 per cent
Formic acid (85 per cent)	0.5 per cent.

Practically no bleaching takes place at temperatures lower than 50°C (122°F), but there is considerable acceleration in the rate up to 90°C (194°F). In practice it is usual to enter the goods cold and raise the temperature to 90°C (194°F), at which it is maintained for periods varying from 1 to 4 hours. Boiling is not recommended because it will lead to excessive loss of chlorine dioxide with the steam. Most synthetic detergents are stable to chlorine dioxide and, when added to the liquor, they promote penetration and possibly further cleansing.

The advantages of sodium chlorite are that it gives extremely good whites and a soft handle with fluidities of the order of 3 to 3.5. It appears to be able to decompose the protein without the formation of objectionable degradation products, with the result that kier-boiling can either be eliminated or greatly reduced. It is sensitive to metallic oxides which promote catalytic oxidation, and rust or copper contamination can cause serious loss of strength or even complete disintegration. The disadvantages are that the fumes are unpleasant and can cause some distress to personnel, and may bleach any dyed textile materials which may be in the vicinity. Chlorine dioxide is highly corrosive and it will cause disintegration of wooden vessels in a short time. Fittings containing iron or copper must be excluded.

Stainless steel is attacked, but it is possible to use plant constructed out of stainless steel made with a high molybdenum content provided certain precautions are taken. One safeguard is to passify the surface at intervals by filling the machine with a nitric acid solution of 10 to 20 per cent concentration, and treating at 50° to 60°C (122° to 140°F) for about 30 minutes, or alternatively, the addition of 8 to 12 oz of sodium nitrate per 100 gallons to every bleach is effective. Stainless steel lasts quite well if a chlorite bleach is followed by a peroxide treatment since the latter assists in the maintenance of the passive surface. Polarization of the stainless steel has been pro-

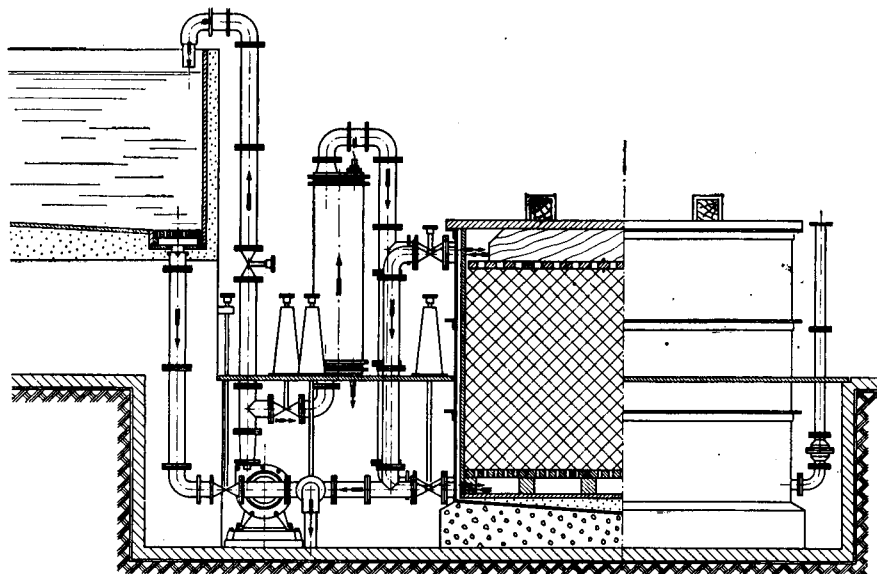

Fig. 10.5 Ceramic circulation machine for chlorite bleaching

(Courtesy of Degussa)

posed. An aluminium sheet is immersed in the chlorite solution and connected, above the liquor level, to the wall of the vessel, when the reversal of polarity causes the aluminium to dissolve in preference to the stainless steel. Ceramic plant is entirely resistant, as is titanium, and fibre-glass bonded with certain synthetic resin products may be used. Fabrics can be bleached on a winch, but the comparatively long-liquor ratio makes the cost of chlorite somewhat high and some form of kier is preferable. A ceramic circulation machine suitable for fabrics or yarn in hank is shown in Fig. 10.5, and open iron cotton-boiling kiers have often been fitted with a pump for circulation and lined with ceramic tiles. Yarn in package form can be bleached in normal pressure machines provided the precautions referred to previously are taken to protect the stainless steel.

Bleaching with a solution of sodium hypochlorite activated with sodium

chlorite has been recommended. In a strongly alkaline solution sodium chlorite and hypochlorite react to form sodium chlorate:

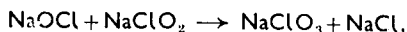

but at pH 8 to 9 or when slightly acid the following reaction predominates:

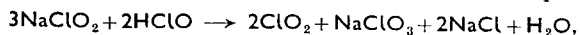

with the formation of chlorine dioxide which is available for bleaching. Since the reaction takes place at pH 8 to 9 there is no copious liberation of gaseous chlorine dioxide nor is there a corrosion problem. On the other hand, the bleaching is considerably slower and, in many cases, an acceptable white cannot be obtained within a reasonable time. The use of formaldehyde as an activator is not without interest. The cotton can be padded with a cold mixture of sodium chlorite solution and formaldehyde, also a small quantity of soda ash as a stabilizer, and stacked and covered with a polythene sheet, or packed in plastic bags, and stored overnight. The chlorine dioxide is liberated gradually over a period of many hours and by the following morning the goods will be well bleached. A double process has been described (Belg. Pat. 449.839), using a mixture of sodium chlorite and hydrogen peroxide, bleaching first under acid conditions when the chlorine dioxide operates and the peroxide is inactive, and then making the liquor alkaline so that the peroxide becomes effective. For example, a liquor of 1600 litres is loaded with 100 kg of goods and heated to 70°C (158°F). After 10 minutes at this temperature 1.6 kg of sodium chlorite, 0.4 litre of formic acid, and 1.6 litres of 130 vol hydrogen peroxide are added. The temperature is raised to 75°C (167°F) and a further 0.4 litre of formic acid is added. After running for 15 minutes the temperature is brought up to 80°C and a final 0.4 litre of formic acid is put in. If the pH is not 3.3 at this stage it should be adjusted accordingly. The temperature is then raised to 90°C (194°F), at which it is maintained for 30 minutes, after which it is cooled to 70°C (158°F), and 3.2 kg of caustic soda are added, the pH being brought to 9. The temperature is again raised to the boil and boiling continued for 45 minutes.

Continuous bleaching

There has always been a strong incentive to design machines to bleach cotton woven and knitted fabrics continuously on account of the large quantities which are processed. The earliest device was the Gantt piler (Fig. 10.6) which was a wooden box constructed in the shape of a letter J with a series of rollers in the bend. The cloth entered at the top and was folded with a piling device. It was withdrawn at the lower end of the J. The box, when filled, stores a considerable weight of material, so that the time during which it takes to pass through may be of the order of 60 to 90 minutes, or possibly even longer. The cloth is padded with desizing or bleaching agent and then passes continuously

through the box at a speed regulated to give a 'dwell period' adequate for the requirement of the process. Gantt pilers never proved successful for the thorough alkali boil required for hypochlorite bleaching. Completely continuous processing did not make great progress until hydrogen peroxide and sodium chlorite became available, both of which are oxidizing bleaching agents which give good results without being preceded by a prolonged alkali boil.

Modern continuous processing is based upon the J box, which is a refinement of the original Gantt piler, as can be seen in the diagram in Fig. 10.7. The cloth passes into an impregnator, where it is padded with caustic soda or the bleaching agent, and then through a heater tube in which it is heated to 90°–100°C. The hot material next passes over a plaiter, which piles it in the J box from which it emerges after a dwell period which is usually 60 to 90 minutes. The J box is well insulated to retain the heat, and lined with stainless steel for hydrogen peroxide bleaching or with a ceramic, titanium,

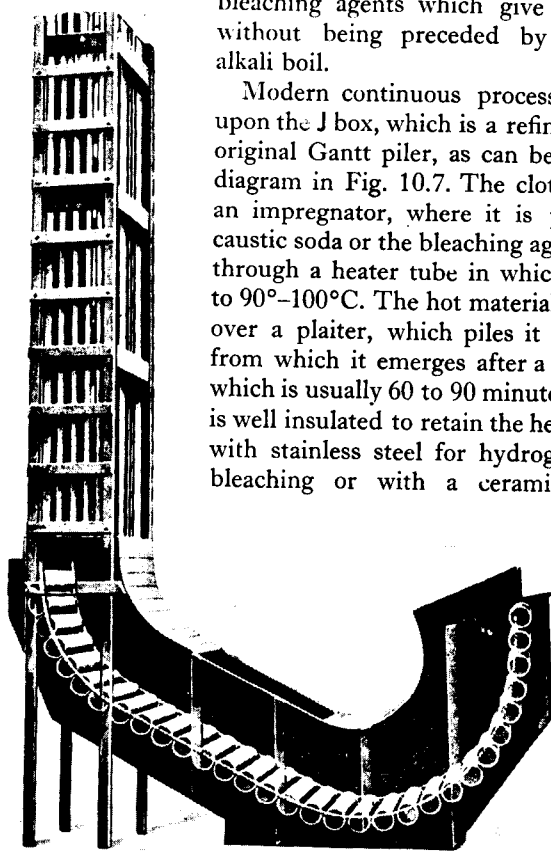

Fig. 10.6 Gantt piler

(Courtesy of Hunt and Moscrop)

or a fibre-glass reinforced polymer for processes in which sodium chlorite is used. An extremely simple continuous bleaching unit suitable for knitted fabrics and materials made out of synthetic fibres when a comparatively mild scour suffices is shown in Fig. 10.8. This serves to illustrate the general principle underlying the construction of all plant of this type.

A plant lay-out scheme for caustic soda scouring and hydrogen peroxide bleaching is shown in Fig. 10.9 (SKELLY, *J.S.D.C.*, 1956, 72, 9). The cloth

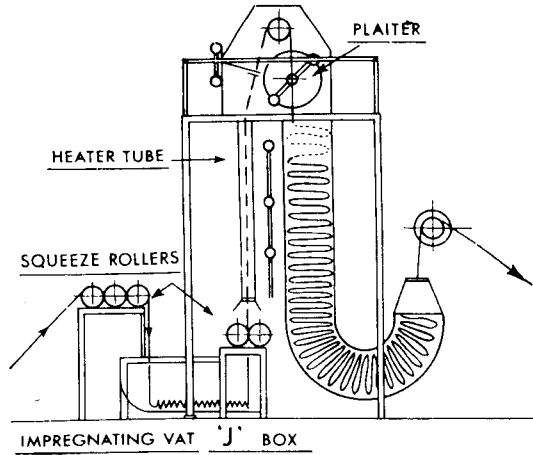

Fig. 10.7

(Courtesy of Dorsyd Industries)

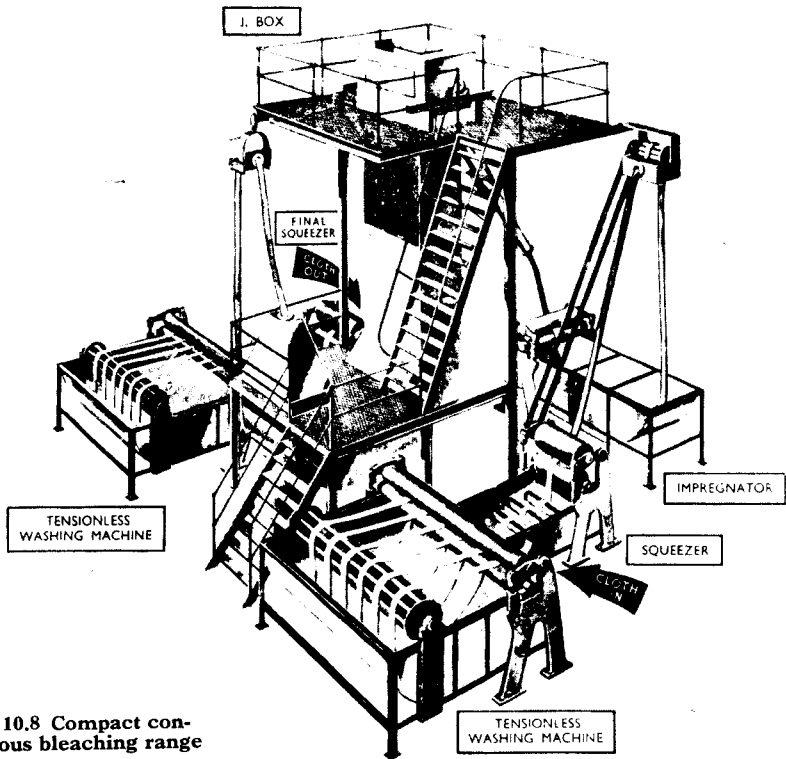

Fig. 10.8 Compact continuous bleaching range

(Courtesy of Sir James Farmer Norton)

is washed and saturated in open width and piled in the J box in twistless rope form. A guide to the sequence of operations is:

- (i) Pad with 4 per cent caustic soda at 71°C (160°F);
- (ii) steam in J box for at least 60 minutes at 93°–99°C (200°–210°F);
- (iii) hot wash and cool;
- (iv) pad with hydrogen peroxide (0.8 to 1.2 vol) at 37.8°C (100°F);
- (v) steam for 60 minutes at 93°–99°C (200°–210°F); and
- (vi) wash off in hot water.

There are many other plants for continuous bleaching either in rope form or open width, and for further information the following sources should be consulted: J. K. SKELLY, *J.S.D.C.*, 1956, 72, 7, N. F. CROWDER and W. A. S. WHITE, *J.S.D.C.*, 1955, 71, 764, and *Textile Scouring and Bleaching*, E. R. TROTMAN, Griffin, London.

Sodium chlorite, because of its quick action and ability to bleach cotton which has not been caustic boiled, is well suited for continuous processes. It is used to an increasing extent for bleaching knitted fabrics, and it is claimed that there is substantial economy in the consumption of chlorite, especially in comparison with treatment in a winch. Man-made fibres require quantities of about 0.15 to 0.2 per cent of sodium chlorite on the weight of the goods. With regard to cotton there appears to be little information, but it is probable that between 1 and 1.5 per cent of sodium chlorite is required. It is also necessary to add an activator to bring the pH to between 3.5 and 4 either before or during the dwell period in the J box.

Pad-roll methods, although not continuous, are convenient, especially when the quantities to be bleached are less. The principle is shown diagrammatically in Fig. 10.10. The cloth passes, in open width, through an

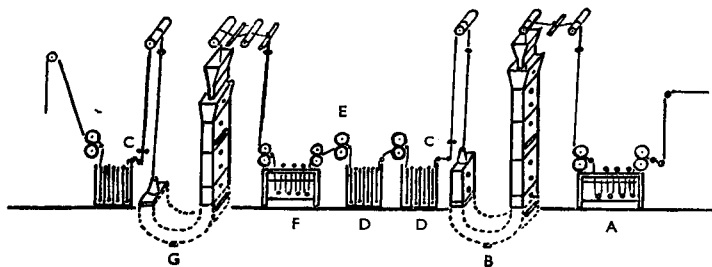

Fig. 10.9 Plant for continuous bleaching with hydrogen peroxide

(Courtesy of SKELLY, *J.S.D.C.*, 1956)

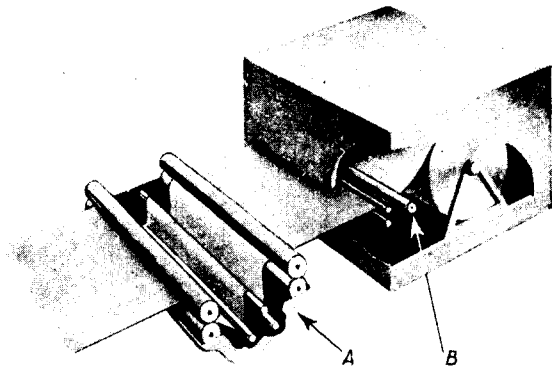

Fig. 10.10 Pad-roll machine
(Courtesy of 'Silk and Rayon Record')

impregnator *A* between two perforated pipes *B* which direct steam onto it to heat the material, and then to a rolling device. The whole is enclosed in an insulated box so that the roll will remain hot for several hours. A typical process specification would be to pad with a liquor containing, per 100 gallons:

Sodium silicate	25 lb
Caustic soda	5 lb
Trisodium phosphate	13 lb
Soda ash	6 lb
Wetting agents	up to 10 lb
Hydrogen peroxide (35 per cent)	4 gallons

(LAPORTE, *Bleaching Manual*)

The cloth is saturated at a temperature of 38°C (100°F), and it retains 80 to 100 per cent of its weight of liquor. The temperature of the batch is raised to 76°C (170°F) and stored for between 2 and 3 hours. The method does not give a full white but is useful as a preparation for printing or dyeing pale or bright shades. A cold padding process which yields a white adequate for many purposes is to pass the goods through a solution made up as below:

Water	96 gallons
Sodium silicate (78°Tw)	20 lb
Caustic soda	5 lb
Soda ash	5 lb
Wetting agent	2 lb
Hydrogen peroxide (35 per cent)	3 $\frac{3}{4}$ gallons

(Recommended by B. Laporte)

The cloth is squeezed till it retains 80 to 100 per cent of its weight of the liquor and then stacked and covered with polythene sheets and allowed to stand overnight. The next morning the fabric is rinsed thoroughly with plenty of clean water.

Pad-roll methods also give good results with sodium chlorite. A cold solution of sodium chlorite containing a phosphate as a buffer and an acid is used. The impregnating solution is made up with 5 to 20 g per litre of sodium chlorite (80 per cent), 5 g per litre of wetting agent, 30 g per litre of disodium hydrogen phosphate, and sufficient acetic or formic acid to bring the pH to 3·8. Alternatively a special activator such as Activator N of Messrs Degussa can be used. This gives a cold solution with a pH of 10 to 11 but becomes acid when the temperature is raised to 95°C (203°F). A padding liquor would be made with:

	Water	50 gallons
Sodium chlorite (80 per cent)		9 lb
	Activator N	2½ lb

The padded cloth, in each case, is heated with steam jets, rolled and stored in chambers resistant to chlorine dioxide for periods varying between 2 and 6 hours at temperatures between 60° and 100°C (140° and 212°F).

Bleaching wool

The basic method is to bleach with hydrogen peroxide. Sodium or calcium hypochlorite must never be used because they discolour and damage the fibre. Bleaching is carried out with 1, 1·5, or 2 volume peroxide liquors adjusted to pH 8 to 9 with a mild alkali at temperatures between 49°C (120°F) and 54°C (130°F) according to circumstances. A very common practice is to leave the goods in a standing bath overnight, take them out the next morning and fortify the liquor for the next batch. The plant may be made of stainless steel, wood, stoneware or concrete, but there must be no copper or iron which cause rapid catalytic decomposition of the peroxide. Since standing baths are used the goods, when they are taken out, carry with them a substantial amount of hydrogen peroxide which could be used again, and a mangle or draining board is desirable to avoid such wastage.

The traditional method of making a bleach liquor for wool is as follows:

	Water	97 gallons
Sodium silicate (78°Tw)		7 lb
	Soda ash	2 lb
	Wetting agent	1 lb
Hydrogen peroxide (35 per cent)		2¼ gallons
Hydrogen peroxide (50 per cent)		1½ gallons
	(pH adjusted to 9)	

When bleaching in a standing bath overnight the starting temperature may be 54°C (130°F) to allow for cooling, and there must be some means of

ensuring that the wool remains completely submerged the whole time because gaseous oxygen may become trapped in local pockets and increase the buoyancy of the batch. When bleaching in a machine where movement is provided, the temperature can be controlled the whole time and it is then maintained at 49°C (120°F). Under such circumstances the time can be reduced to between 3 and 5 hours. When liquor ratios are short, such as in a package machine, where they may be of the order of 10:1 or 8:1, it is sometimes advantageous to discard the peroxide solution after bleaching. In such cases the stabilizer (sodium silicate) may be omitted and the pH adjusted to 10 with ammonia so that the bulk of the oxygen will be consumed.

The traditional recipe quoted above is very often modified in practice. The peroxide concentration quoted is equivalent to a 0.9 per cent w/w liquor, but it is often possible to bleach satisfactorily with 0.3–0.6 per cent w/w liquors. Sodium silicate has disadvantages because it tends to cause harshness, especially if goods containing residual traces which have not been rinsed out are subsequently acidified. A product referred to as Stabilizer C (Laporte) (a mixture of sodium oxalate and sodium pyrophosphate) may be substituted for alkali and silicate, or alternatively sodium pyrophosphate alone may be preferred. Adjustment to the desired pH with ammonia alone is possible and may be useful when rapid liberation of the oxygen is required. Sometimes woollen goods are entered into a bleaching liquor in an acid condition, especially if they have previously received an unshrinkable treatment. Under such circumstances great care must be taken to ensure that the bath is alkaline, and tests should be made at intervals after the commencement of bleaching because the neutralization of the acid may be quite slow. It may be desirable to bring the liquor to a stable pH of 7 by the use of ammonia to neutralize the acid, and make the final adjustments by the addition of the appropriate amount of stabilizer.

When bleaching is complete the wool must be rinsed thoroughly and then treated in a liquor containing $\frac{1}{2}$ per cent of acetic acid (80 per cent) on the weight of the goods, or more if necessary, to neutralize the alkalinity left over from the bleaching bath. The acidification is usually accompanied by some improvement in the colour, particularly because, to some extent, it prevents slight loss of colour which may occur during drying.

Catalysts can be extremely dangerous in the peroxide bleaching of protein fibres. Contact with iron or copper in the form of the metals, their oxides or their salts, causes greatly accelerated local liberation of oxygen accompanied by serious tendering. Gross contamination usually reveals itself before it has caused far-reaching damage. It is not uncommon, however, for microscopically small particles of catalyst to be distributed throughout the goods. If they are not removed before entry into the peroxide solution they either cause a number of pinholes, visible immediately after bleaching, or are responsible for partial degradation which only becomes

apparent during wear. In hot weather wool is liable to become infected with micro-organisms of which certain varieties appear to form an enzyme which decomposes hydrogen peroxide causing very rapid evolution of oxygen and absence of bleaching. Rescoring will usually remove the source of the trouble.

Bleaching with hydrogen peroxide, unless the alkalinity and temperature are properly controlled, can cause degradation of the protein. This is not necessarily revealed by immediate loss of tensile strength or elasticity but causes a lack of resistance to subsequent processes or to repeated washing. The degree of deterioration is measured by alkali solubility. In the test described by Smith and Harris (*Am. Dyes. Rep.*, 1936, 25, 542) the weighed sample is treated for 60 minutes at 65°C (149°F) with a volume of N/10 sodium hydroxide sufficient to give a liquor ratio of 100:1. The sample is then separated by filtration on a Gooch crucible or sintered glass funnel, washed with 2 litres of water, dried, and weighed. The alkali solubility is the percentage loss calculated on the dry weight. Undamaged wool has an alkali solubility, determined in this manner, of 12 to 13 per cent, and values of over 18 per cent indicate definite damage. Fibres which have already suffered some degradation by attack by micro-organisms, excessively severe scouring, or unshrinkable treatment have less resistance to peroxide bleaching. The following sources may be consulted for further information. Lees and Elsworth (*J.S.D.C.*, 1952, 68, 207) and I.W.T.O. Technical Committee Report, 1960.

There are occasions when bleaching with hydrogen peroxide at a pH lower than 7 is desirable, especially when the goods contain coloured effect threads which are not of outstanding fastness to alkali. The white obtained with an acid bleach is inferior but suffices for many purposes. The usual procedure is to saturate the material with the liquor, after which it may or may not stand for periods of up to 24 hours before drying. The greater part of the bleaching takes place during drying. Traces of peroxide may remain in the wool for as long as 14 days, but this is no disadvantage except that it should not exceed 0.05 per cent in goods to be dyed, and must be removed by rinsing if in excess of this amount. The impregnating liquor is made up of the following proportions:

Water	98 gallons	98 litres
Formic acid (85 per cent)	1 pint	0.12 litre
Hydrogen peroxide (35 per cent)	1½ gallons	or 1.5 litres
or Hydrogen peroxide (50 per cent)	1 gallon	1.0 litre

The pH of the liquor is adjusted to 4.0 to 4.5 by further addition of formic acid or sodium carbonate according to which is necessary.

Wool can also be bleached with sodium peroxide, using sulphuric acid to neutralize the excess of sodium hydroxide. The liquor is made up of the following:

Magnesium sulphate	2 oz
Sodium silicate J.81	3 lb
Sodium peroxide	15 lb
Sulphuric acid (96 per cent)	19½ lb
Water	100 gallons

Before use the pH should be tested and adjusted to 9 if necessary. The goods are entered at 50°C (120°F) and bleached for 4 to 5 hours or overnight, and rinsing and neutralization of residual alkali with acetic acid follow.

The oldest method of bleaching wool, now virtually fallen into disuse, is with sulphur dioxide. Sulphur occurs naturally in volcanic regions and there is evidence that the Romans bleached wool by stretching it over beehive-shaped lattice frames in the centre of which was placed a small pot of burning sulphur. Illustrations of this operation being carried out appear in murals on a building, devoted to scouring and dyeing, excavated at Pompeii.

Bleaching with sulphur dioxide

This was carried out extensively in this country until 1940 when, owing to the scarcity of sulphur, it fell out of use and it is doubtful whether it has been revived to any great extent. It did, however, give an adequate bleach for lower quality goods, was extremely cheap, and only required simple equipment. The process was known as stoving because the wool was exposed to sulphur dioxide in what was called a stove.

The stove consisted of a chamber about 8 ft high, 4 to 4½ ft wide, and about 10 ft long. It was provided with rails on which wooden poles could rest. Moistened wool goods were hung over these poles and a cast-iron pot containing 5 to 7 lb of sulphur was placed in the chamber and ignited. The door was closed, making the chamber airtight, with the exception of a few small holes to permit the entrance of just sufficient air to support combustion of the sulphur. The goods were allowed to remain in the stove for a period of 8 hours or, more frequently, overnight. The sulphur dioxide was then evacuated through a duct connected with a fan and the wool was taken out and rinsed in water or, preferably, in a liquor containing 2 per cent on the weight of the material of sodium sulphite to partially or completely remove retained sulphur dioxide. Sodium sulphite forms sodium bisulphite:

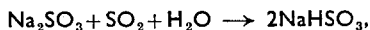

and its use is preferable to sodium carbonate because slight excess of alkali can spoil the colour. If removal is inadequate the sulphur dioxide may be oxidized to sulphuric acid or may, itself, cause irritation to the skin of the wearer.

The stoves could be constructed of wood, glazed bricks held together with acid resisting cement, or of blue bricks. It was advisable that the roof should be insulated, otherwise drops of water saturated with sulphur

dioxide became oxidized to sulphuric acid, and, when they fell on the goods, caused holes. The wool should also be free from particles of dirt containing iron because these become solubilized and spread, making large brown stains.

The outstanding disadvantage of stoving was that the white was not permanent when exposed to sun and air. After some time, the wool reverted to approximately its original colour. An extremely clear white can be obtained by bleaching with hydrogen peroxide first and stoving afterwards, but the sequence must never be reversed, otherwise the peroxide would be consumed in oxidizing the residual sulphur dioxide to sulphuric acid. A slight improvement in shade results from 'wet stoving', when the goods are immersed in a sodium sulphite solution to which sufficient acetic or mineral acid has been added to liberate sulphur dioxide. Pale dyeings can often be made brighter by stoving or 'wet stoving' provided the dyes are fast to sulphur dioxide; the Rhodamines and Acid Rhodamines responding particularly well.

Sodium dithionite

Sodium dithionite is also known as sodium hydrosulphite. It is a stable white powder with strong reducing properties. The first stage in its manufacture is to pass sulphur dioxide through an aqueous suspension of zinc dust when the following reaction takes place:



The resultant solution is treated with either sodium hydroxide or sodium carbonate, when the zinc is precipitated leaving a solution of sodium dithionite, which may be freed from insoluble impurities by filtration and, on the addition of a mixture of common salt and alcohol, needle shaped crystals of $\text{Na}_2\text{S}_2\text{O}_4 \cdot 2\text{H}_2\text{O}$ separate out. It is a reducing agent because, under suitable conditions, it oxidizes to sodium bisulphate with the liberation of hydrogen:

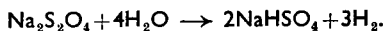

On storage, or in aqueous solution, sodium hydrosulphite tends to decompose, forming a mixture of substances including sodium sulphide, sodium thiosulphate, sodium bisulphite, and free sulphur. In the solid state these changes can sometimes occur spontaneously with considerable violence. In solution, the addition of acid causes these changes to take place, but in the presence of alkali the solution is much more stable. When exposed to air under conditions favourable to slow oxidation, sodium metabisulphite is formed:

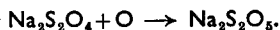

When treated with formaldehyde, a comparatively stable addition compound is formed, $\text{Na}_2\text{S}_2\text{O}_4 \cdot 2\text{CH}_2\text{O}$ (known as sodium sulphonylate formaldehyde). Its aqueous solution has little reducing power, but when acetic acid is added it decomposes slowly on warming, with the formation of

hydrosulphurous acid. Since decomposition is complete only at boiling point, the reducing action can be developed very gradually.

Wool can be bleached with sodium hydrosulphite or its derivatives, but in practice they do not find much application, partly because they tend to impart a harsh handle. They are used as stripping agents to remove dyes when this is necessary.

Bleaching silk

The fibre must be degummed before bleaching, and the addition of a small amount of hydrogen peroxide to the soap liquor assists in removal of the gum and brings about a slight preliminary improvement in colour. The silk is bleached in a 0.6 per cent w/w solution made as follows:

Hydrogen peroxide (50 per cent)	1 gallon
or Hydrogen peroxide (35 per cent)	1½ gallons
Sodium silicate (78°Tw)	4 lb 11 oz
Soda ash	1 lb 5 oz
Wetting agent	1 lb
Water	98 gallons
or alternatively	
	Water 98 gallons
Hydrogen peroxide (35 per cent)	1½ gallons
or Hydrogen peroxide (50 per cent)	1 gallon
Stabilizer C	4 lb

The temperature of the liquor is raised to 71°C (160°F), which is higher than for wool, and there should be circulation of the liquor or movement of the goods. Bleaching is generally complete in 2 to 4 hours.

Tussur and other wild silks require special treatment. Tussur silk, in particular, is so difficult to bleach that it is commonly used in its natural fawn colour. Bleaching in a 0.6 per cent w/w solution at 70°C (158°F) for 6 hours will give a fairly good white without excessive loss of tensile strength. The colour is improved by after-treatment in a liquor containing 2 g per litre of sodium hydrosulphite at 100°C. Silk can be bleached by stoving with sulphur dioxide, but the method has now virtually fallen into disuse. Treatment with sulphur dioxide after a peroxide bleach is sometimes used for exceptionally good whites.

Bleaching man-made fibres

The methods used for the cellulosic regenerated fibres are the same as those for cotton, with the exception that there is less colouring matter to remove and the severity of the process can be decreased. Thus 1 g per litre of available chlorine will always be sufficient and bleaching must be carried out cold with sodium hypochlorite. A 0.15 to 0.3 per cent w/w hydrogen peroxide liquor is used and approximately ½ lb per 100 lb of sodium chlorite would be required. The amount of alkali must be reduced when bleaching

acetate fibres because of the danger of hydrolysis of the acetyl groups. The use of Stabilizer C is recommended for acetate because it maintains the correct alkalinity. Bleaching should be carried out at 66°C (150°F) for 1 hour with:

Water	98 gallons
Hydrogen peroxide (35 per cent)	3 pints
or Hydrogen peroxide (50 per cent)	2 pints
Wetting agent	1 lb
Stabilizer C	2 lb

There are reasons also for preferring the use of peracetic acid because this can be applied in a liquor which is virtually neutral. The bath is made up in the following proportions:

Water	98 gallons	98 litres
Sodium hexametaphosphate	0.5 lb	or 0.05 kg
Peracetic acid (36/40 per cent)	3 lb	or 0.3 kg
Wetting agent	1 lb	0.1 kg

The pH is adjusted to 6.5, the goods are entered, the temperature is raised to 66°C (150°F) and bleaching continued for 1 hour.

Superpolyamides are sometimes yellowed during preliminary heat setting and some bleaching is necessary. Neither sodium hypochlorite nor hydrogen peroxide is recommended because they both cause some loss of strength. Bleaching is carried out with peracetic acid by the method described above. Sodium chlorite is also used extensively. A solution is made up containing 0.5 to 1 g per litre of chlorite and the pH is brought to 3.8 to 4 with acetic or formic acid, and treatment is continued for 30 to 60 minutes at 85 to 90°C (185° to 194°F) (CROWDER AND WHITE, *J.S.D.C.*, 1955, 71, 774).

Polyester fibres are not often bleached, but when this is necessary a 1 g per litre sodium chlorite solution is brought to pH 2 to 3 with nitric acid and treatment is continued at 96°C (205°F) for 20 minutes or longer if necessary (CROWDER and WHITE, *loc. cit.*).

Polyacrylonitriles are for very many purposes sufficiently white but when, however, this is not the case, the goods should be scoured first and it must be borne in mind that boiling in alkaline solutions causes discoloration. The operation is therefore carried out with a non-ionic detergent in a neutral or slightly acid liquor at 80°C (170°F) for a period of 30 minutes. A recommended method of bleaching is to make up a liquor containing:

- 1.5 lb per 100 gallons (1.5 g/l) of sodium chlorite
- 2 lb per 100 gallons (2 g/l) of oxalic acid
(this should bring the pH to 3.5 to 4)
- 4 lb. per 100 gallons (4 g/l) of sodium nitrate
(to protect stainless steel equipment)

The temperature is raised to 88°C (190°F) at which it is maintained for one hour. An alternative method is to bleach at 93°C (200°F) for 30 minutes in a liquor containing:

- 0.4 to 1 g/l of sodium chlorite
- 0.4 g/l of phosphoric acid (this should give a pH of 2.5)
- 5 g/l of a non-ionic dispersing agent

and, if desired, a fluorescent brightening agent may be added.

The combined nitrogen in the polyacrylonitrile fibres tends to retain chlorine and dechlorination for twenty minutes at 60°C (140°F) in a solution containing 1.5 lb per 100 gallons of sodium sulphite is necessary.

Bleaching elastomeric fibres

These, by themselves, rarely need bleaching, but they are almost invariably found in fabrics containing other fibres which do require bleaching. It can be taken as a general rule that when elastomeric yarns are present neither sodium chlorite nor hypochlorite can be used but there is no danger associated with hydrogen peroxide.

Fluorescent brightening agents

Certain organic compounds possess the property of fluorescence. This means that they can absorb light at a shorter wavelength and re-emit it at a longer one. Thus a substance can absorb invisible ultra-violet rays and re-emit them within the visible spectrum. This phenomenon is demonstrated in the absorption and emission curves shown in Fig. 10.11, bearing in mind that the eye is sensitive to light ranging from 400 μ to 700 μ . A surface, therefore, containing a fluorescent compound can emit more than the total amount of daylight which falls on it, giving an intensely brilliant white. The effect is only operative when the incident rays contain a significant proportion of ultra-violet light, and is therefore less apparent under artificial illumination.

The first experiments were made with Aesculin, a glucoside of aesculetin (3) found in horse chestnuts (KRAIS, *Melliand Textilber.*, 1929, 10, 468). It was observed that it brought about a marked improvement in whiteness. Aesculin, however, never became a commercial success because it had not sufficient affinity for cellulosic or

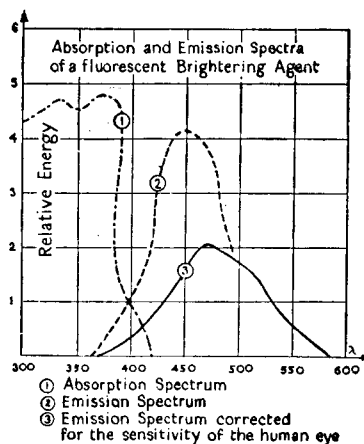
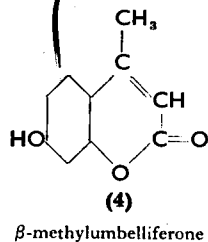
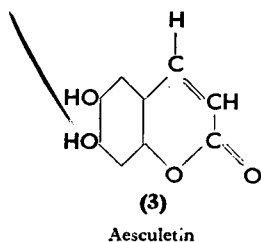

Fig. 10.11

(Courtesy of Hosiery and Allied Trades Research Association)

other fibres. Ten years later Meyer (*Brit. Pat. 522672*) claimed protection for the use of β -methylumbelliferone (4) for whitening textiles:



Shortly afterwards I.G. in Germany and Lever Brothers in Britain filed patents describing the use of derivatives of diaminostilbenedisulphonic acid (5):

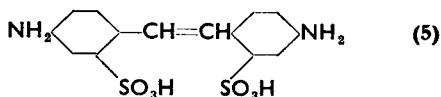

This discovery laid the foundation for real progress because these compounds had a good affinity for cellulose. Amongst the earliest were Blanphor R (C.I. FLUORESCENT BRIGHTENING AGENT 30) (6):

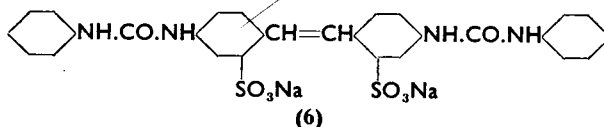

and Tinopal BV (7) (C.I. FLUORESCENT BRIGHTENING AGENT 1)

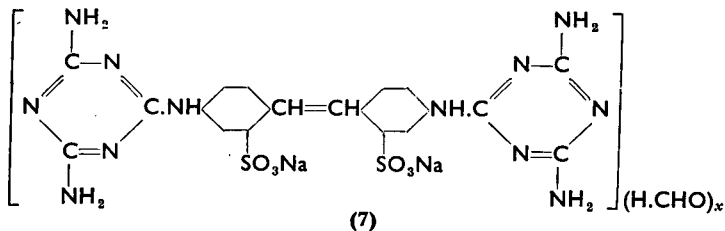

is obtained by treating the sodium salt of 4:4' diamino-2:2'-stilbenedisulphonic acid with cyanuric chloride, then reacting with ammonia and finally heating with aqueous formaldehyde. Fluorescent brightening agents based on structure (7) are decomposed by hypochlorites and there is a demand for those which are sufficiently stable to be applied simultaneously in the bleaching liquor. This object has been achieved by the preparation of compounds containing triazinyl rings as in (8):

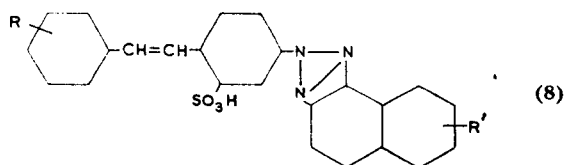

Both (6) and (7), and many others of analogous constitution, are substantive only to cellulose. Blancophor WT (9) (C.I. FLUORESCENT BRIGHTENING AGENT 48) was the first compound specifically claimed to have an affinity for protein fibres when applied from a weakly acid bath:

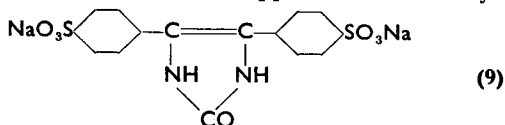

Other products suitable for protein fibres are derivatives of aminocoumarin (10):

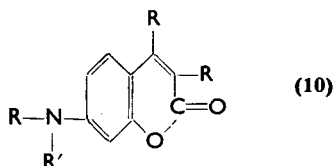

Fluorescent brightening agents with affinity for both cellulosic and protein fibres, suitable for fabrics containing mixtures of the two, have been prepared with structures based on (11):

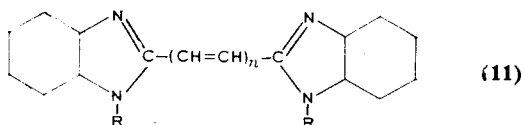

Polyamides can, as a rule, be brightened with those products suitable for protein fibres. They have, however, an affinity for insoluble dispersions of organic compounds and, because of their hydrophobic nature, it is on derivatives of this type that can be applied to polyesters. Water-insoluble fluorescent brightening agents, in the form of dispersions, are based, one example, on compounds derived from (12) which are favoured because of their comparatively good light-fastness:

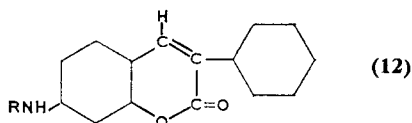

Polyacrylonitriles contain anionic groups giving them an affinity

cationic fluorescent brightening agents such as, for example, products derived from (13)



Most fluorescent brightening agents are applied to cellulosic fibres at temperatures between 40° and 50° C in quantities varying from 0.05 to 0.5 per cent. Better exhaustion is obtained when 5 lb per 100 gallons of common salt are added. In the case of animal fibres quantities of fluorescent brightening agents ranging from 0.25 to 2.5 per cent are applied at 40° to 50° C with 5 per cent of formic acid (85 per cent) or acetic acid (80 per cent), and similar instructions would be appropriate for polyamide fibres.

In most cases the light-fastness of fluorescent brightening agents is not good. On protein and cellulosic fibres it is usually between 1 and 2, and reaches 3 in a few cases. Fastness to washing is also only moderate. It should be borne in mind, however, that modern detergents almost invariably have a fluorescent brightening agent incorporated, with the result that any loss of the original content is replaced. On polyamide fibres there are selected products with light-fastness of 4, on polyesters 7, and for polyacrylonitriles 4 to 5.

When optical bleaching agents on wool fade as the result of exposure to light a pronounced brown discoloration is frequently developed. It has been suggested that this is caused by decomposition products of the fluorescent compounds. Graham and Statham (*J.S.D.C.*, 1956, **72**, 434) observed that the degree of discoloration depended upon the quantity of fluorescent agent present and was greater on bleached than unbleached wool. Nylon and filter paper impregnated with the same agents faded without production of brown discoloration, and for this and other reasons it was suggested that the basic cause of the development of the brown colour is the photochemical liberation and oxidation of tryptophane in the keratin, activated by the fluorescent substance.

Fluorescent brightening agents are no substitute for bleaching but improve the white and also allow reduction in the amount of bleaching agent required, thus diminishing the risk of increasing fluidity or degradation of proteins. They are frequently applied after bleaching, but the following, amongst others, are stable to hypochlorites and can be added to the bleach liquor.

C.I. FLUORESCENT BRIGHTENING AGENT				15
C.I.	"	"	"	16
C.I.	"	"	"	18
C.I.	"	"	"	24
C.I.	"	"	"	26

There are also products such as C.I. FLUORESCENT BRIGHTENING AGENTS 38, 56, and 58 which will be absorbed by protein fibres in neutral or weakly alkaline solutions, and can be added to peroxide liquors. Fluorescent brightening agents find extensive application in dyeing clear bright shades on all fibres. They are particularly useful in the case of wool, because bleaching prior to dyeing does not give such a good white base as with cellulose or synthetic fibres.

11 · Unshrinkable and other finishes

WHEN wool, in a wet state, is submitted to any form of mechanical action which applies alternate compression and relaxation to it, it felts. The phenomenon consists of individual fibres packing themselves closer and closer together, until what was originally a comparatively soft structure becomes a hard mass of interlocking fibres. This increase in density is naturally accompanied by a decrease in area or volume, commonly described as shrinkage. Felting gives both desirable and undesirable properties to wool: valuable because it makes it possible to close up the texture and increase the bulkiness and rigidity of a cloth, but objectionable in garments which are washed frequently and shrink.

There is no doubt that felting is related to the phenomenon defined as the Directional frictional effect (D.F.E.) of wool fibres which is connected with the structure of the epithelial scales. The coefficient of friction is greater when the movement of a fibre in relation to another surface is in the direction of the tip, than when it is in the direction of the root.

The so-called 'violin bow' method of measuring the D.F.E. of wool fibres was described by Speakman and Stott (*J. Text. Inst.*, 1931, 22T,



Fig. 11.1 'Violin bow' for determination of D.F.E.

339). Fifty fibres are arranged so that they all point in the same direction and are then stretched over two bars and held in position by a clamping device (Fig. 11.1). This bow is placed upon a piece of wool velvet attached to a board, the inclination of which, in relation to the horizontal, can be varied at will. The angle at which slipping occurs is measured. If θ^1 and θ^2 are the angles when the orientated fibres move in the tip and the root directions respectively, then the D.F.E. (or coefficient of scaliness as it was originally called) is $\frac{\tan \theta^1 - \tan \theta^2}{\tan \theta^2} \times 100$. The degree of difference in friction between root-first and tip-first movement is indicated by the following example:

Angle of inclination for root-first movement 13°

Angle of inclination for tip-first movement 19°

Lipson and Howard (*J.S.D.C.*, 1946, 62, 29) describe a method of measuring D.F.E. of individual fibres. The sample, F (Fig. 11.2), is suspended over an 8-mm diameter rod, R , turned on a lathe from cattle horn. The solution, the effect of which on friction is under investigation, drips over the bulb of a thermometer, T , onto the fibre as it passes over the

rod, and finally to a collecting vessel through the tube, *E*. The hooks, *H*, each weighing 0.1 g, are attached to the ends of the fibre with shellac. Weights, *W*, consisting of pieces of wire are added to one hook until, when observed with a microscope, movement of the fibre just commences. The procedure can again be carried out by adding weights to either end of the fibre, thus measuring the friction in both directions. The weight W_1 promoting movement is the sum of the weights of the hook, the shellac, and the added wires, whilst the weight opposing movement W_2 is that of the hook plus the shellac.

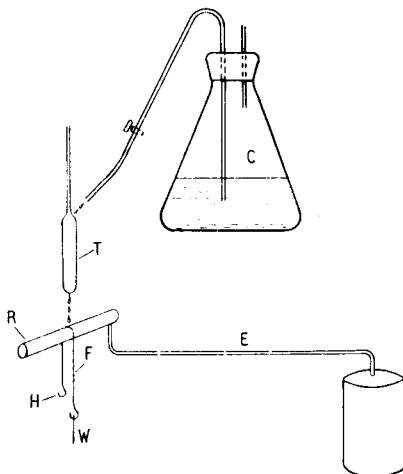

Fig. 11.2 Lipson and Howard's method for determination of D.F.E.

The coefficient of friction equals $0.736 \times \log_{10} \frac{W_1}{W_2}$ and Lipson and Howard express the D.F.E. as $\mu_2 - \mu_1$ when μ_1 is the coefficient of friction in the tip to root direction and μ_2 the reverse. Other methods of determining D.F.E. are described by Speakman, Chamberlain, and Menkart (*J. Text. Inst.*, 1945, 36r, 91), Martin and Mittlemann (*J. Text. Inst.*, 1946, 37 T, 269) and Bohm (*J.S.D.C.*, 1945, 61, 278). The relationship between D.F.E. and shrinkage is illustrated by the following figures quoted from Alexander (*J.S.D.C.*, 1950, 66, 353):

Treatment	Shrinkage in milling stocks	D.F.E.	
		Violin bow	Lipson method
None	25.1 per cent	31.0	0.23
4 per cent Cl ₂ at pH 2	1.8 per cent	1.0	0.60

It is accepted, not without reservations (Martin, *J.S.D.C.*, 1944, 63, 277) that the D.F.E. is caused by the scale structure. The scales produced

the tip so that movement with the tip leading is 'against the grain' and 'with the grain' is in the reverse direction (see Fig. 11.3).

Shrinkage is caused by the combined effects of D.F.E. and fibre movement promoted by the elasticity of the wool. When alternating compression and relaxation are applied the compressive force packs fibres more tightly together and, on relaxation, the D.F.E. prevents many of them from reverting to their original positions. The part which the natural elasticity of the

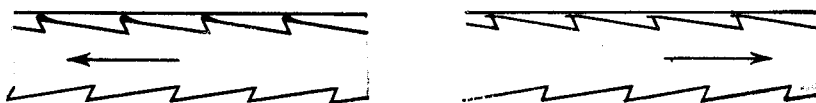

Fig. 11.3 Diagram demonstrating directional frictional effect of projecting scales
(Courtesy of International Wool Secretariat)

fibre plays has been demonstrated by Menkart and Speakman (*Nature*, 1945, 156, 143), who reported that increasing the rigidity of the fibre by building additional cross-links with benzoquinone or mercuric acetate reduced the tendency to shrink without affecting the D.F.E. There is some doubt about the nature of the movements which the fibres make. Examination of felted wool shows that they form complex entanglements and

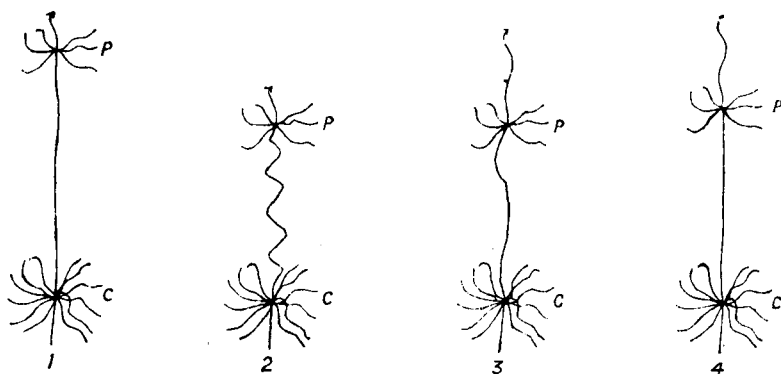

Fig. 11.4 Shorter's theory of felting

Shorter in 1923 suggested that individual fibres became entangled with others at several points, and unidirectional movement drew them together. In Fig. 11.4 a fibre with its tip pointing in the direction of the arrow is involved in two entanglements at P and C (1). When a compressive force is applied (2) the D.F.E. causes the fibre to travel towards the root through C (3), and on relaxation the D.F.E. again operates, preventing travel in the reverse direction, with the final result (4) that the entangle-

ments are closer together. The cumulative effect of repeated occurrence of this type of movement is to lock the fibres into a more compact mass causing felting. Martin (*J.S.D.C.*, 1944, **60**, 325) recorded experiments in which the D.F.E. was virtually removed, either from the tips or the roots, by immersing the ends of bundles of fibres in bromine water and subsequently treating them with the enzyme papain. The results demonstrated that tip treatment had virtually no effect on shrinkage, but when the root was modified the reduction in shrinkage was most significant. Based on these observations, Martin proposed a mechanism for felting illustrated diagrammatically in Fig. 11.5. *a* represents a number of fibres, approximately parallel as they would be in a yarn, in the initial stage. The arrows represent the root ends of three other fibres which, as *b*, *c*, and *d* show, thread themselves through the mass which has become entangled and

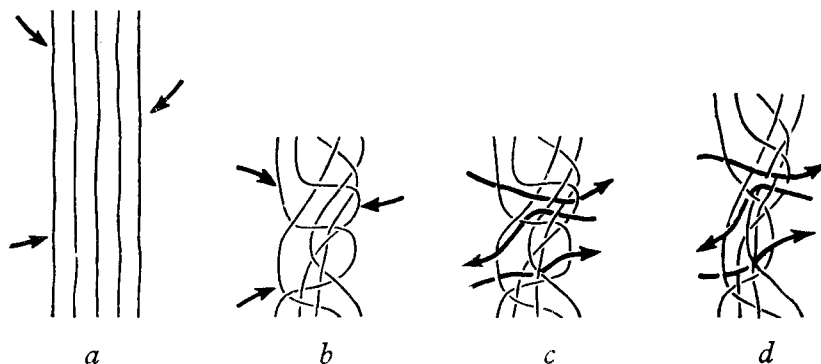
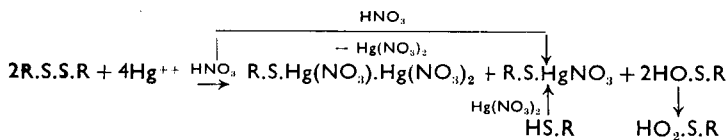

Fig. 11.5 Martin's theory of felting
(*Courtesy of International Wool Secretariat*)

buckled by compressive force. When compression is removed (*d*) the fibres represented by the heavy arrows lock the compressed structure together so that it does not return to its original condition. Since the root forces its way through the mass, dragging the tip after it, hardening of the root or softening of the tip should promote shrinkage. It has been shown experimentally (MENKART AND SPEAKMAN, *Nature*, 1947, **159**, 640) that stiffening the roots by building additional cross-links with mercuric acetate promotes felting. For making felt high shrinkage is desirable but the hardening of root ends could not be carried out as a commercial operation. Softening the tips, a process known as carroting, is commonly practised. Rabbit pelts, the hairs from which are to be converted to felt, are treated with a solution of mercuric nitrate in nitric acid in such a manner that the tips only become impregnated. The fur is then dried in a stove, when breakdown of cystine linkages takes place accompanied by softening of the zone affected. The reaction is complex. Robinson and Robinson (*J.S.D.C.*,

1961, 77, 361) suggest, by analogy with reactions with dialkyl sulphides, the following reaction scheme:



Speakman, Chamberlain, and Fairhead (*J. Text. Inst.*, 1941, 32T, 98) drew attention to the fact that carotting is exceptionally effective with rabbit hairs because they have a bulbous swelling near the tip, which must be softened before there is freedom for the D.F.E. to promote irreversible movement in the root direction.

Effect of pH on milling

When a given amount of alternating compression and relaxation is applied to wool, the degree of shrinkage is found to be lowest between pH 4 and 8, and to increase rapidly on either side of this range (graph in Fig. 11.6). The curve bears a close relationship to that expressing the percentage reduction in work required to stretch wool fibres at various pH values (see Fig. 5.19, Chap. 5). As has already been explained in Chapter 5, it is between pH 4 and 8 that the adjacent polypeptide chains are believed to be bound together by salt linkages, making the structure more rigid and less disposed to expand and contract. This, and the effect of building additional cross-links, to be discussed later, lead to the conclusion that the elasticity of the wool assists in the movement which must occur before the D.F.E. can lock fibres in their new positions. It is necessary that the wool should be damp before it will felt because the moisture, by interposing a dielectric film between the positive and negative charges in the salt linkages, reduces the work needed for deformation.

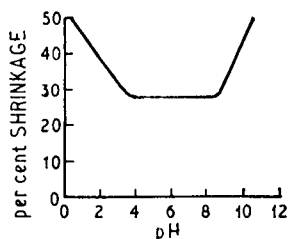

Fig. 11.6 Relationship between shrinkage and pH

Felting of wool is very commonly used to improve the properties of woollen garments or materials. The products of the loom or the knitting machine are lacking in rigidity, full of interstices, and unattractive in appearance. Felting, or milling as the process is called, closes the interstices and gives a product with greater weight per unit of area, and an improved handle.

There is reason to believe, from evidence derived from the excavations at Pompeii, that the Romans milled woollen cloths by placing them in a bowl and stamping on them with their feet to give alternate compression and relaxation. It is probable that an infusion of wood ashes was used to bring the pH out of the range of salt linkage formation.

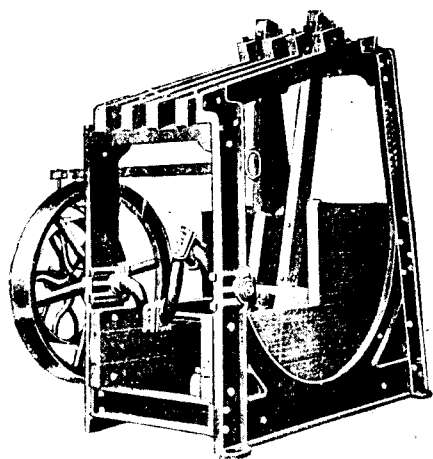

Fig. 11.7 Fulling mill

The machine known as the Fulling mill or Scotch mill (Fig. 11.7) has been used for a long time. It consists, essentially, of two hammers made to beat the cloth or knitted goods which are contained in a curved bowl. The heads of the hammers are serrated in such a manner that, whilst they are pounding the load, they are also turning it over. The material is scoured and then hydroextracted, after which it is put in the mill with sufficient soap to create a good lather. Soap is a good promoter of felting, not only because it is slightly alkaline, but as it also appears to ease the movement of the fibres in relation to each other. The milling is continued until, in the judgement of the miller, the right amount of thickening has taken place. Scotch mills are mainly used for garments. Cloth or knitted web is treated in a soap solution in a Kilburn mill or rotary milling machine (Fig. 11.8). The cloth, which is made into an endless chain by joining the two ends together, passes through a pair of heavily loaded squeezing rollers into a spout where compression takes place. The spout is rectangular in cross-section and the top side is pivoted at one end and free at the other. The amount of compression applied to the fabric can be controlled by application of weights to the pivoted top. On emerging from the spout, relaxation takes place so that the required alternation of compression and relaxation is applied.

A more recent development, particularly suitable for knit-goods, is the Böwe milling and finishing machine. This consists essentially of a rotating

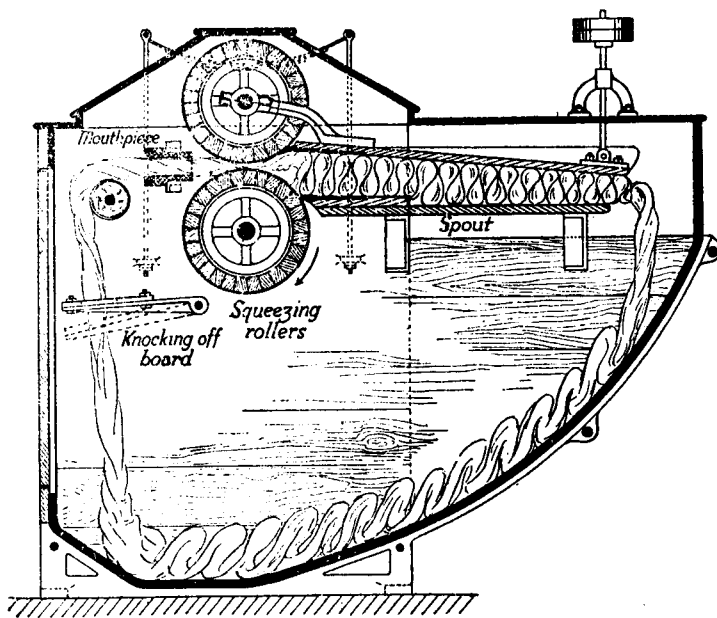

Fig. 11.8 Scouring and fulling machine for cloth or fabric

perforated drum in which the oily contamination is removed by immersion in perchlorethylene. With this solvent there is no swelling of the fibre and the shape of the garments remains unaffected. If milling is called for, an accurately measured quantity of water, in the form of a finely divided dispersion, together with a suitable auxiliary, can be added to the solvent. The additions and the time cycles are automatically programmed, which plays an important part in ensuring highly reproducible results.

Felting and the shrinkage which accompanies it are undesirable in garments which are washed frequently such as underwear or socks. There are several shrink-resist finishes which can be applied to wool. Theoretical considerations lead to the conclusion that there are two ways in which the liability of wool to shrink might be reduced. In the first place the surface might be modified so that the D.F.E. is decreased and, secondly, the fibre might be made more rigid so that it does not expand and contract so easily. Some work which has been done on the latter method will be described later since it is of greater theoretical than practical significance. The oldest method of modifying the surface is based upon the use of chlorine. Mercer was the first to record the observation that the action of chlorine on wool is to increase its lustre and to give it a greater affinity for dyes. For a long time wool cloth to be printed was treated with chlorine to help in the absorption of the colour from the rollers, and it was not realized that it was being made unshrinkable at the same time. It was not until the beginning

of the present century that a few practical men, working entirely empirically, invented processes for making shrink-resistant wool by the action of alkali metal hypochlorites in the presence of strong acids.

By about 1920 the chlorination of wool to make it unshrinkable was a well-established commercial process but based on practical experience with no scientific understanding of what was taking place. Whilst the garments



Fig. 11.9

- A. Normal wool fibre
- B. Scales partially attacked by wet chlorination
- C. Scales completely removed (chlorzyme process)

(Courtesy of Wool Industries Research Association)

were, indeed, being made unshrinkable, there was a tendency for chlorination to reduce the wearing properties to such an extent that the useful life was too short. It was at about this time that S. R. Trotman made a proper scientific study of the effects of the action of chlorine on wool. Microscopic examination of the fibres revealed that in many cases their scales had been removed and this was invariably accompanied by serious deterioration in wearing power (Fig. 11.9). S. R. Trotman described the damaged fibre test

in which no less than 200 fibres, plucked from various places in the sample, were examined under the microscope, and those on which no scales could be seen were classified as damaged, but those which still possessed vestigial markings of scales were placed in the undamaged category. It was found that complaints of bad wearing were always associated with damaged fibre counts of about 75 to 80 per cent. If the conditions could be controlled so that the damaged fibres were in the region of 50 per cent, it was considered that a satisfactory compromise between unshrinkability and diminished resistance to wear had been achieved.

Botany wool shrinks more readily than crossbred and therefore requires stronger chlorination. Slackly woven or knitted materials are more prone to shrink and felt than those with more solid structure and, in consequence, the amount of chlorine required in every case is different. It is apparent, therefore, that no general formula can be laid down for the application of chlorine to wool, and the best proportions for each material must be found by practical trials. As a general guide it can be stated that between 1 and 2 per cent (on the weight of the goods) of available chlorine will be required, and a quantity of 28°Tw hydrochloric acid, equivalent to 2½ times the volume of hypochlorite, should be added to liberate the chlorine. This is more acid than would be required on theoretical grounds, but it has been found, in practice, that there is a tendency for wool to yellow, and this is counteracted by increasing the proportion of acid. If sulphuric acid (96 per cent) is used, an amount equivalent to 0.38 of the volume of hypochlorite is required, but since slight excess of acid does not matter, a quantity equal in volume to half the hypochlorite would constitute a good practical working basis.

The available chlorine in sodium hypochlorite varies. Good results in chlorination depend upon scrupulous attention to detail. Therefore each carboy of hypochlorite should be standardized before use, and any stock tank should be tested daily. The available chlorine is estimated by titration with N/10 sodium thiosulphate as described in Chapter 10. A convenient routine is to dilute 25 ml of the hypochlorite to 500 ml in a graduated flask and then titrate 5 ml of the resultant solution with thiosulphate. The g per litre of available chlorine

$$= \frac{\text{ml thiosulphate} \times 0.00355}{5} \times 20,000$$

or $\text{ml N/10 thiosulphate} \times 14.2$

and the volume of hypochlorite needed for a 1 per cent treatment of 100 lb of wool

$$= \frac{454.3}{\text{g/l concentration of hypochlorite}}$$

or $\frac{454.3 \times 0.2204}{\text{g/l available chlorine}}$

Footwear and garments are chlorinated in mangle machines, fabrics in

winchers or Whiteley scouring machines, and yarn in package or hussong machines. The absorption of chlorine is extremely rapid and, unless the chemicals are added gradually, there will be over-chlorination in some parts and under-treatment in others. The liquor is made up with the appropriate amount of acid and, if desired, some penetrating agent stable to chlorine, after which the previously-scoured goods are entered. The hypochlorite is then added in several portions or, preferably, run in continuously through a drip-feed device, for a period of 40 minutes. The greatest practical degree of movement of goods and liquor in relation to each other is maintained the whole time. When the addition of hypochlorite is complete the machine should be allowed to run for a further 10 minutes so that any remaining chlorine can be absorbed. It has been claimed that the reaction can be carried out with greater uniformity using a two-bath process. The scoured woollen goods are first run for half an hour in a cold liquor containing the acid and a surface-active agent to assist penetration. The absorption of the acid is slow and therefore uniform. The liquor is then run off, the machine refilled, and the appropriate quantity of sodium hypochlorite is added gradually. Chlorine will be liberated *in situ* where the acid is situated, and since this is evenly distributed there should be a consistent degree of unshrinkability throughout the whole charge. There is a risk that the pH may become too high in the two-bath process, with the result that there will be some deterioration in the colour. Unshrinkable finishes are always carried out in cold liquors.

When the liquor is exhausted it is run off and the machine is refilled with water. The wool contains a considerable amount of acid and loosely combined chlorine, giving an objectionable smell. Treatment for 15 minutes either cold or at 45°C (113°F) with 2 per cent (of the weight of the goods) of either sodium sulphite or bisulphite removes the residual chlorine and, also, reacts with the excess of mineral acid, converting it to sulphurous acid. This is easily removed by rinsing and subsequent drying. Chlorinated wool tends to have a harsh handle and this is corrected by the final application of a cationic softening agent.

The unshrinkable processes described in the previous paragraphs have a tendency to make the material look lean. It is often found to be necessary, therefore, to give a little more mill to goods which are to be chlorinated. The process also increases the affinity of wool for dyes and makes the absorption, in many cases, so rapid that it is much more difficult to achieve level shades. The fastness to washing and wet processes of practically all dyes is reduced when they are applied to wool which is chlorinated either before or after dyeing. The easy-levelling wool dyes have so little fastness on unshrinkable wool that they are almost worthless on goods exposed to frequent washing. The faster dyes, which are intrinsically less level-dyeing, are therefore called for, but their successful application can be extremely difficult.

Speakman *et al.* (*Nature*, 1938, **142**, 1035) observed that chlorine and all other compounds capable of producing unshrinkability by surface modification could react with the disulphide bonds. Confirmation was forthcoming in further experiments by Speakman and Neish (*Nature*, 1945, **45**, 46), who converted the disulphide links to lanthionine bonds: $(R.CH_2.S.CH_2.R_1)$ by treatment with $N/10$ sodium hydroxide when the normal methods of producing unshrinkability became considerably less effective. Hypochlorite solutions make wool unshrinkable at pH values lower than 8.5, but become less effective when the alkalinity increases above this because the cystine links become converted to lanthionine. It was believed that disulphide breakdown was accompanied by a softening of the keratin of the scales, making them more rubber-like in structure. The effect was most marked at the projecting tips which were mainly responsible for D.F.E.

Although this was a good working hypothesis, later discoveries indicated that it was an over-simplification. Based on the assumption that any chemical capable of severing the disulphide bond should cause unshrinkability, numerous efforts have been made to substitute chlorine by some compound which is slower in its reaction, or to create conditions under which the attack on the cystine linkages is confined to the outermost layers of the scales. The earliest of these experiments were made by S. R. Trotman *et al.*, who showed that, by treating wool with hypochlorous acid instead of chlorine, it was possible to make it unshrinkable with very little damage to the fibres. The reaction was much slower and the results were therefore considerably more uniform. The hypochlorous acid was produced by the action of boric acid on sodium or calcium hypochlorite. In practice, bleaching powder was used because the cost of the boric acid required to neutralize the high alkali content of commercial sodium hypochlorite was excessive. The process was not successful, however, because the wool was slightly discoloured and could never be bleached to a really pure white.

Meunier and Latraille, nearly fifty years ago, reported that when wool was exposed to gaseous chlorine 4.4 per cent of chlorine was taken up with the formation of sulphur chloride and chloramines of the type $R.NH.Cl$. After the retained chlorine has been removed with a dechlorinating agent it was found that the tendency for the wool to shrink was greatly diminished. From this basis the process which was frequently referred to as 'dry chlorination' was developed by the Wool Industries Research Association. Their method consisted, essentially, of treating wool containing a standard quantity of moisture with a specified weight of chlorine metered through a chloronome or other measuring device. A cylinder of chlorine gas is attached to a chloronome which has two very delicate pressure-reducing valves which can be adjusted to allow any predetermined volume of gas to pass through in a unit of time. The amount of chlorine

presented to the charge of wool, therefore, is determined by the period during which the valve of the cylinder is allowed to remain open. The wool must be brought to standard moisture content before treatment by exposure in a humidity-controlled atmosphere, because, in the absence of moisture, no unshrinkability is produced, and in the presence of excess of moisture, over-chlorination takes place. The conditioned goods are packed into an ebonite-lined cylindrical steel autoclave about 3 ft in diameter and 4 ft in length, with a perforated ebonite pipe through the centre for delivery of the chlorine, and two perforated pipes at the circumference through which the gas is extracted. A pump recirculates the chlorine through the central tube. One end of the autoclave opens on a hinge and through this the charge is entered, after which the door is closed and an air-tight seal is made by tightening clamping screws. The pump which circulates the gas is next used to evacuate all the air from the chamber, because it was found that unless this was done penetration was incomplete. After evacuation the goods are subjected to the action of gaseous chlorine for 1 hour, at the end of which the residual gas is extracted and either passed through an absorption tower or ejected into the atmosphere in such a way that it is well dispersed before it can be inhaled by humans or animals. The goods are removed from the autoclave and dechlorinated with a sulphite, and softened with a cationic softening agent. The process gives results which are more uniform than wet chlorination, but the necessity to condition before chlorination is space consuming, and the 24- to 48-hour dwell period in the controlled humidity chambers presents a difficulty in organizing flow through a factory. An interesting modification of the process, which dispenses with the use of a vacuum, thereby making a significant reduction in the cost of the plant, is described by Norden and Bainbridge (*J.S.D.C.*, 1968, **84**, 36). The wool is packed into a reaction chamber and air containing a controlled amount of chlorine is circulated through the wool by means of a fan in a closed circuit. The chlorine is introduced gradually into the circulating flow of air. So long as the regain of the wool is less than 16 per cent uniform results are obtained. Attention is drawn to the fact that low regains of the order of 6.5 per cent, which are desirable for dry chlorination, are best obtained by ascertaining how much the temperature of the ambient air must be raised to be in equilibrium with wool containing the desired amount of moisture. A considerable volume of air at this temperature can very quickly be passed through the mass of the material to be treated with chlorine, and a uniform moisture content is rapidly achieved. Since the introduction of 'dry chlorination' there have been so many improvements in wet processes that the former has lost much of its comparative advantage.

The first important practical advance in the wet process was introduced by Edwards and Clayton (Brit. Pat. 537671). The principle underlying this method consists of presenting the chlorine to the wool whilst it is in an

unswollen or slightly swollen state. This is achieved by controlling the pH at about 4, which is on the acid side, to avoid discoloration, but within the range of the isoelectric point. To achieve this an organic acid is used, preferably one possessing potential reducing properties (such as formic acid), in the presence of a sodium salt which exercises a buffering effect (such as sodium formate). According to the patent, anti-oxidants such as urea, thiourea, or thioglycol can be used with advantage. It is preferable, if possible, to carry out chlorination at temperatures between 5°C and 10°C (41°F and 50°F) because this has the effect of reducing the swelling of the fibre. Solid carbon dioxide has been used to keep the temperature of the liquor down. It is claimed that the results are better if the fibre is covered with a hydrophobic film, such as traces of oil or a small amount of residual natural wool grease. Scouring may therefore be omitted, provided the goods are thoroughly wetted out. The oil retards the entry of the chlorine molecules into the fibre and thus contributes towards greater uniformity of penetration. The treatment with chlorine is followed by the usual dechlorination and softening.

The absorption of chlorine can also be retarded by the addition of a low molecular-weight, soluble melamine polymer in the form of one of the Melafix products (Ciba). When added to a chlorinating liquor they have the property of combining with the chlorine and then releasing it very slowly to the wool. The goods are scoured first, preferably with a detergent other than soap. If bleaching with hydrogen peroxide is necessary this should be carried out before the unshrinkable process.

Melafix DM is described as a water-soluble organic nitrogen compound capable of combining with a high volume of chlorine liberated from sodium hypochlorite solutions which have been acidified. It will, in fact, enter into loose combination with 80 per cent of the chlorine normally present in chlorinating liquors. With Melafix, between 2 and 3.5 per cent of chlorine on the weight of the wool will be required and the quantities of Melafix DM to be added are given below:

<i>Available chlorine based on weight of wool (per cent)</i>	<i>Quantity of Melafix DM regardless of liquor ratio (per cent)</i>
2	2.2
2.5	2.75
3	3.3
3.5	3.85

The rate of chlorination can be controlled by raising the temperature within the range of 20 to 35°C, the time required being 1½ hours at the higher temperature. At 20°C the reaction can alternatively be accelerated

by the addition, after one hour, of sufficient sodium bromide to give a 0.2 g/l concentration.

The liquor is made up containing the appropriate amount of Melafix DM and sufficient hydrochloric or sulphuric acid to bring the pH to between 1.8 and 2.0. After this solution has been allowed to circulate for between 10 and 15 minutes the sodium hypochlorite is added gradually over a period of 45 to 60 minutes, and at no time should the pH be allowed to rise higher than 3. The absorption of the chlorine by the wool can be completed in $1\frac{1}{2}$ hours at $35^{\circ}C$, after which dechlorination with 1 per cent of sodium bisulphite (powder) is necessary. Finally it will usually be desirable to soften the goods with a cationic softening agent. Melafix S is applied in a similar manner but its aqueous solution is cationic and combines softening properties with its chlorine buffering activity.

Wolsey and Alexander (Brit. Pat. 586020, 1947) describe a method of making wool shrink-resistant by treating it for a period of a few minutes in a solution of potassium permanganate at a pH of less than 2. This is followed by treatment with a sodium bisulphite solution to remove the brown stain caused by the deposition of manganese oxides. The details quoted in the patent are as follows:

50 lb of grey wool socks were scoured with soap, rinsed and treated in 70 gallons of water containing 1 lb of potassium permanganate and 7 lb of concentrated sulphuric acid at $20^{\circ}C$ ($68^{\circ}F$) for a period of 1 to 2 minutes. After rinsing well, the socks were treated in a mixture of 70 gallons of water and 1 gallon of 25 per cent aqueous solution of sodium bisulphite at $20^{\circ}C$ ($68^{\circ}F$) for 5 minutes. The handle is improved by a final rinse followed by treatment with aqueous soap and ammonia.

Two years before the publication of the Wolsey, Alexander patent, Raynes and Stevenson (Brit. Pat. 569730; *J.S.D.C.*, 1945, 102) described how wool could be rendered shrink-resistant by treatment, first with a dilute aqueous permanganate solution, and then with a nitrogen-containing chloro compound in which the chlorine is attached to the nitrogen or, preferably, with an alkali metal or alkaline earth hypochlorite or hypobromite. A particular example which is quoted is as follows: 'The wool is treated at $40^{\circ}C$ ($104^{\circ}F$) for one hour in a 0.1 per cent solution of potassium permanganate at pH 5. After one rinse it is transferred to a liquor, to which the appropriate amount of hypochlorite has been added, and treatment is continued without the application of any heat for 20 minutes. The goods are subsequently run through sodium bisulphite to remove the discoloration caused by the permanganate, and are softened if necessary.'

A later simplification specified the treatment of the wool with permanganate and hypochlorite simultaneously. It had been realized for some time that the action of hypochlorite was less severe when the pH was higher than 7 than when the application was in acid solutions. It was, however, not

possible to make use of this knowledge because of the yellow discoloration of the wool. When the Stevenson, Raynes process was used, the presence of potassium permanganate protected the colour at pH values as high as 8.5 to 10. The wool treated in this way has an exceedingly good handle and is slightly whiter after the process than it was before. It can also be dyed without the risk of the unlevelness which usually accompanied the older conventional finishes. In some of the methods described in the patent specification, the addition of certain salts is recommended. For example, 100 parts by weight of wool are treated in the following solution: potassium permanganate—2 parts, chlorine added as sodium hypochlorite—4 parts, calcium chloride—7 parts, zinc sulphate—3 parts, wetting agent— $\frac{1}{2}$ part, and water—2500 parts. The solution has a pH of 8.2 and the goods are treated until the liquor is exhausted, after which the colour and residual chlorine are removed with sodium bisulphite. In another example a liquor having a pH of 11 is recommended, which is made up with $1\frac{1}{2}$ lb of potassium permanganate, $2\frac{1}{2}$ lb of chlorine as sodium hypochlorite, 10 lb of calcium chloride, $\frac{1}{2}$ lb of wetting agent, and 250 gallons of water per 100 lb of wool.

Dichloroisocyanuric acid

The sodium salt of dichloroisocyanuric acid is now used extensively as a chlorinating agent for rendering wool unshrinkable. This compound undergoes hydrolysis in the presence of water in such a manner that the equilibrium mixture yields only a low concentration of active chlorine, derived from the hypochlorous acid liberated, at any one time:

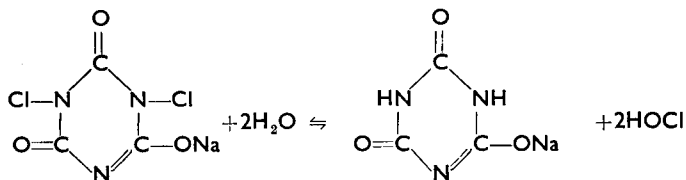

The result is that the transfer of chlorine to the wool is slow and the treatment therefore is uniform.

The sodium salt of dichloroisocyanuric acid contains, for all practical purposes, 62 per cent of available chlorine, and quantities varying between 2 and 3 per cent on the weight of the wool are usually necessary to produce good commercial shrink resistance. The rate of chlorination can be controlled either by temperature or by pH .

Control by pH

The scoured goods are put into the machine filled with water at ambient temperature together with 10 per cent of Glauber's salt and the required

amount of the dichloroisocyanuric acid product. The pH is adjusted to 6 with formic acid and after 20 minutes a further quantity of formic acid is added to reduce the pH to 5, and then, after another 30 minutes the pH is brought down to 4. After 40 minutes the available chlorine has virtually been absorbed and the liquor is run off, any residual chlorine being removed in a fresh liquor with 3 per cent of sodium bisulphite.

Control by temperature

In this case the machine is filled with cold water and approximately 1 per cent on the weight of the goods of acetic acid is added. The goods are then entered and after running for five minutes the pH is adjusted to between 4.5 and 5 by further addition of acetic acid if this is necessary. The dichloroisocyanuric acid sodium salt is then dissolved and added, and the liquor is kept at room temperature for 10 minutes, after which it is raised to 30°C at which it is maintained until a sample of the liquor, withdrawn from the machine, gives only a pale yellow coloration on the addition of a few drops of potassium iodide solution.

All the processes which have been described rely on the breakdown of disulphide bonds with oxidizing agents. It was only natural, therefore, that other oxidizing agents should be tried, and hydrogen peroxide was one of the first which suggested itself. P. W. Cunliffe *et al.* (Brit. Pat. 614966, 1949) describe how the felting of wool can be reduced by treating it with a peroxide or a peroxy derivative after it has been impregnated with a compound of copper, nickel, silver, or mercury. The amount of metal present should not be greater than 0.001 per cent of the weight of the wool in the case of copper or nickel, or 0.3 per cent of silver and 0.5 per cent of mercury. Wool treated in this way is shrink-resistant, suffers little loss of strength, has a good handle, and can be dyed without difficulty. If cellulose fibres are present, nickel is preferred as the activating metal because copper tends to cause degradation of the cellulose. A later patent by Stevenson and Partridge (Brit. Pat. 692258, 1953) describes the use of permonosulphuric acid to make wool shrink-resistant. Treatment with a solution of permonosulphuric acid at a pH of less than 2 in the presence of not more than 10 per cent (by weight) of sulphuric acid, is a method which is recommended.

Alexander, Carter, and Hudson (*J.S.D.C.*, 1949, 152) drew attention to the fact that permanganate-treated wool shrinks as much as an untreated specimen when acid milled, but is unshrinkable when conditions are alkaline. It was also found that such wool would not felt in a washing machine if the pH was above 7, but did so rapidly when the pH was below 7, and even when alkaline it shrank in a mill where it was subjected to violent compression and agitation. With chlorine the scales are removed or loosened so that they fall away, but this is not the case with permanganate. An interesting example of the influence of mechanical factors on

permanganate-treated wool is revealed in the figures tabulated below (ALEXANDER *J.S.D.C.*, 1950, **66**, 353).

Treatment	D.F.E.	
	Violin-bow method	Lipson method
Untreated	31.0	0.23
0.5 per cent KMnO ₄ at pH 2	1.8	0.17

This demonstrates that permanganate brings about a great reduction in the D.F.E. when measured by the violin-bow method, but a much less significant change when using the Lipson technique. Alexander *et al.* suggest that permanganate does not loosen the scales but only seals the projecting tips to the fibre. This gives a smooth surface and, in consequence, reduces D.F.E. in the violin bow where the fibres are static. In the Lipson test, on the other hand, the fibre is subjected to greater mechanical influence as it passes over the rod and this breaks the seal, permits the scale tips to project, and thus restores the D.F.E. Milling differs from treatment by washing machine because the pounding action detaches the scale tips. The degraded protein, which seals the scales, also becomes brittle when the wool is acid and no longer possesses adhesive properties. The Stevenson, Raynes method neither loosens the scales nor gives a D.F.E. which is sensitive to mechanical effects. It is, therefore, assumed that this process does not gum the tips but removes them completely. Alexander, Carter, and Earland (*J.S.D.C.*, 1951, **67**, 23) show that peracetic acid breaks down disulphide bonds without necessarily altering the D.F.E. or producing unshrinkability. They concluded that not only is it necessary, when making wool unshrinkable, to break down the disulphide bonds, but the keratin molecule must also be attacked at some other point, and they suggest that this may be at the tyrosine residue.

From the foregoing considerations it is obvious that, to impart shrink resistance, only the surfaces of the scales need to be modified. Any conditions which restrict the action to the outermost layers are desirable. A number of processes using organic solvents which did not penetrate into the fibre as readily as water were therefore developed. Their use has not become widespread because solvent-recovery plant was costly and there was always an inevitable loss of expensive solvent. The first process of this nature was described in Brit. Pat. 464503 (1935) by Hall, Hicking, and Pentecost, who treated wool with sulphuryl chloride dissolved in white spirit. The reaction was very sensitive to the moisture content of the fibre, which had to be brought to a standard amount (9 to 10 per cent) by conditioning. Elliott and Speakman (*J.C.S.*, 1944, 161) showed that in the presence of moisture the sulphuryl chloride was capable of acting as an oxidizing agent:

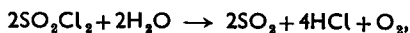

and when experiments were made to study the action of sulphuryl chloride on dibenzyl disulphide the first reaction was as follows:

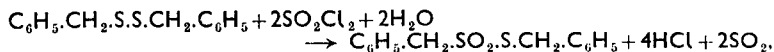

and the second stage was rupture of the disulphide bond:

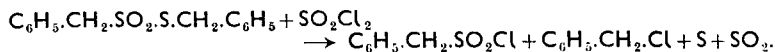

It is reasonable to assume that cystine will behave in a similar manner.

The process was exploited commercially as the Dry Sol finish. It achieved limited success but was ultimately discarded because sulphuryl chloride was an extremely difficult chemical to handle.

When wool is treated with caustic soda of 38 per cent concentration it is not dissolved, but something not unlike mercerization takes place, and a measure of shrink-resistance is produced. In practice it is impossible to treat wool with concentrated caustic soda because it cannot be rinsed out without passing through a stage where a more dilute solution will cause serious disintegration.

At about the same time Freney and Lipson (*Nature*, 1940, **145**, 25) and Tootal, Broadhurst Lee and Co., together with Hall and Wood (Brit. Pat. 538428, 1939) realized that it was possible to produce shrink-resistance by superficial action on the scales. They presented caustic soda to the wool in an organic solvent which, because of its molecular weight, could not penetrate into the fibre as readily as water.

In the Freney and Lipson method the wool was treated with caustic soda dissolved in alcohol. The amount of moisture in the wool had a great influence on the degree of unshrinkability obtained, and also upon the extent of the degradation of the keratin molecules. A moisture content of 8 per cent was recommended as the most suitable for practical working conditions. According to the instructions in the patent, the conditioned wool was treated with 7 per cent of sodium hydroxide dissolved in 95 per cent alcohol at 25°C (77°F) for 2 minutes. There was a tendency for the temperature to rise during the reaction, and some means of cooling was necessary so that it did not exceed 30°C. In a later patent it was claimed that potassium hydroxide gave better results. After treatment the alkali was removed by steeping in an alcoholic solution of sulphuric acid. Methyl alcohol is an expensive solvent and, in spite of the fact that it can be recovered and is available again, this imposed a limitation on the commercial success of the process.

In Brit. Pat. 538396 (1939) Tootal, Broadhurst Lee & Co., together with Hall and Wood, suggested the substitution of white spirit for alcohol as the organic solvent, with the addition of a small amount of propylene glycol to bring the alkali into solution. An example which is quoted is the treatment of 8½ lb of wool was scoured, dried, and conditioned to a moisture content of 12½ per cent of moisture. It was then steeped for 1 hour at 75°C (165°F)

in 6.7 gallons of a liquor composed of 6 gallons of white spirit and 0.7 gallon of *n*-butyl alcoholic solution of sodium hydroxide (6 lb of sodium hydroxide in 10 gallons of butyl alcohol). After immersion the goods were removed, centrifuged, and plunged into 8 gallons of cold water containing 0.2 gallon of sulphuric acid. A modification of this method was covered by a patent taken out by the Bleachers' Association in conjunction with Parker, Farrington, Stubbs, and Speakman (Brit. Pat. 539057, 1940) which recommends the use of sodium sulphide dissolved in isopropyl alcohol. The advantage of the method is that it can be used with wool and cotton mixtures where sodium hydroxide causes some modification of the cellulosic component.

The more important methods of reducing the shrinkability of wool by chemical attack at the disulphide bonds have been described. Experiments have been made with practically every other compound known to react with disulphide bonds, amongst which are fluorine, bromine, hypobromous acid, and ozone. Many of them have given shrink-resistance but are of no real interest on account of practical difficulties. Some success has resulted from disulphide bond breakdown with enzymes. S. R. Trotman, in 1925, first drew attention to the fact that the action of proteolytic enzymes on wool fibres was similar to that of chlorine or hypochlorous acid. In 1938 Phillips and Middlebrook (Brit. Pat. 513919) claimed that non-shrink finish was given to wool by treatment with an enzyme such as trypsin or papain in the presence of an accelerator capable of reducing the disulphide bonds in the fibre to thiol groups. With an enzyme of vegetable origin such as papain, sodium bisulphite was a suitable accelerator, sufficient sodium carbonate being added to bring the pH to 6.7 when the reaction proceeds rapidly. A further refinement was the perzyme process in which the wool was first bleached with hydrogen peroxide at pH 10.5 and subsequently treated with papain and sodium bisulphite. A wool fibre with absolute unshrinkability was obtained by the chlorzyme method, in which gaseous chlorination was followed by enzyme treatment.

Apart from chemical modification of the keratin, there are methods of altering the mechanical properties which render wool shrink-resistant by increasing the work required to bring about alternate extension and relaxation of the fibre. In 1909 Meunier (Fr. Pat. 418797) treated wool with benzoquinone and demonstrated that this gave it greater dimensional and chemical stability. The discovery was entirely empirical, however, because it was not realized, at that time, that additional cross-links between adjacent polypeptide chains had been created. This form of treatment has never had practical importance because it discolours the wool and, unless the benzoquinone is removed completely, there is a risk that it might induce dermatitis. Speakman and Barr (*J.S.D.C.*, 1944, 60, 335) built additional cross-links by treating wool with *N*/10 solutions of mercuric acetate in *N*/10 acetic acid at 25°C (77°F) for 1 hour. The untreated control

shrank 41.2 per cent and the treated specimen 11.6 per cent. This provided a clear demonstration that an addition to the number of cross-links, with the consequent increase in the rigidity of the fibre, would reduce the tendency to shrink. This experiment, however, was only of theoretical interest because the wool was heavily discoloured. Barr and Speakman (*loc. cit.*) examined more critically the work of Meunier on the action of benzoquinone. The mechanism of the formation of cross-links is illustrated in the following equation:

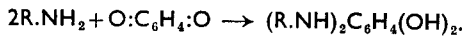

By exposing wool to the action of a 1 per cent solution of benzoquinone for 48 hours, its shrinkage, expressed as a percentage of area, could be reduced from 44.2 per cent to 16.9 per cent. These experiments were of no commercial significance, but they have provided interesting confirmation of the hypothesis that the elasticity of the wool fibre is an important factor in the mechanism of shrinkage.

It has been recorded in many places that wool very heavily loaded with dyestuffs is partially unshrinkable, and S. R. Trotman reported this observation with particular reference to stockings dyed with Logwood Black. He also showed that loading wool with hydroxides of tin, chromium, zinc, or titanium reduced shrinkage. The reason for these effects was not understood at the time, but Barr and Speakman (*J.S.D.C.*, 1944, 238) exposed wool to ethylene sulphide vapour in an endeavour to build new cross-links. Their object was not achieved but, in the course of their experiments, they found that they could make wool unshrinkable by treating it at 50°C (122°F) with a mixture of the vapours of water and ethylene sulphide. The results of an examination of the physical properties of the fibres showed that the ethylene sulphide had entered the unoccupied spaces, there it had polymerized, and this had made the fibre into a rigid structure, no longer capable of elastic recovery after stretching. This explanation of what took place clarified the observations of S. R. Trotman referred to previously. Speakman and Barr also observed that, in the case of human hair, about 21 per cent by weight of the polymer could be deposited within the fibre without increasing its volume. From the relative densities of the hair and the polymer it was calculated that the unoccupied space amounted to 21.3 per cent.

Many experiments have been made to modify the shrinkage properties of wool by the application of polymers, but the purpose has generally been to deposit a film on the surface of the fibre so that the D.F.E. will be removed. Alexander (*J.S.D.C.*, 1950, 66, 349) attributes the unshrinkability brought about by the application of polymers to 'spot welding' rather than alteration of the surface or masking of the scales; the fibres are glued together in the yarn and thus their movement is restricted.

Leuchs (*Ber.*, 1906, 57, 398) recorded that, in the presence of water,

anhydrocarboxy glycine would polymerize to form a substance similar to the main chain of polypeptides:

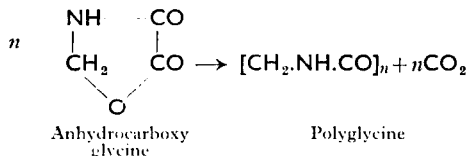

Baldwin, Barr, and Speakman (*J.S.D.C.*, 1946, **62**, 4) realized that polyglycine should be a polymer disposed to become anchored on the surface of the wool, because the structural similarity should afford abundant opportunity for hydrogen bonding. By treating wool for 6 hours at 50°C with 5 per cent of anhydrocarboxy glycine dissolved in ethyl acetate, to which 2½ per cent by weight of water had been added to initiate polymerization, it was possible to make wool unshrinkable. The polymer was sufficiently firmly attached to the fibre, but the process was too costly to be commercially attractive. Barr, Capp, and Speakman (*J.S.D.C.*, 1946, **62**, 338) published a description of an extension to this work in which they treated wool with di-isocyanates. The primary intention was to build additional cross-links but, using metaphenylene di-isocyanate only, a negligible quantity of cross-links were formed. The wool was, however, made unshrinkable and it was assumed that a film of polymer was formed which masked the scale structure or, according to views expressed later, 'spot welded' the fibres. Similar results were obtained by polymerizing methylmethacrylate on wool (SPEAKMAN AND BARR, Brit. Pat. 559787).

There have been a great number of attempts to make wool resistant to shrinkage by masking the scales with a deposit of an insoluble polymer. Probably the earliest process to achieve a measure of commercial success was based on melamine which is produced by the trimerization of cyanamide:

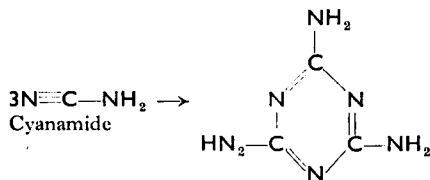

Melamine will react with formaldehyde to form methylol melamines.

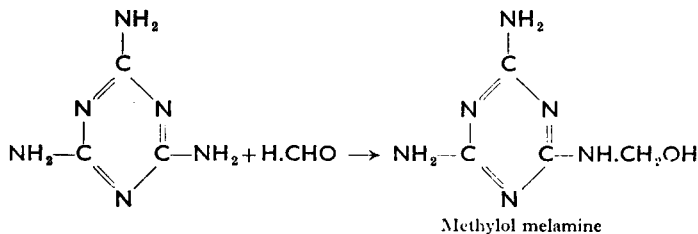

The methylol melamines when heated undergo condensation polymerization. In practice, methylated methylol melamines, obtained by the action of methanol in the presence of a little acetic acid, are preferred as the monomers. The compound is soluble in water, and the wool is padded with a 10 to 15 per cent solution, and about 5 per cent of a catalyst such as diammonium hydrogen phosphate, after which it is dried at 94° to 110°C (200° to 230°F). Polymerization is brought about by heating to temperatures above 110°C (230°F). An adequate measure of unshrinkability was obtained, but the rather harsh handle of the wool was a factor which prevented use of the method.

Both Neish and Speakman (*Nature*, 1945, 156, 176) and Wolsey and Alexander (Brit. Pat. 594901, 1947), showed that wool could be made unshrinkable by depositing upon it a silicon polymer. Alexander (*J.S.D.C.*, 1950, 66, 349) considers that this is the only example of true masking of the scales with no 'spot welding' involved. The process is described in detail by Alexander, Carter, and Earland (*J.S.D.C.*, 1949, 65, 107). The wool was treated with a substance of the general formula $R.R'.SiCl_2$ in an organic solvent such as carbon tetrachloride. The experiments were carried out with dimethyl silicon dichloride. The goods were immersed in the solution, hydroextracted, and then soaked in water at room temperature and dried, when the silicon compound was deposited on the surface of the fibres as an insoluble polymer.

Considerable progress was made by the introduction of interfacial graft polymerization. This depends essentially on impregnating the wool with a

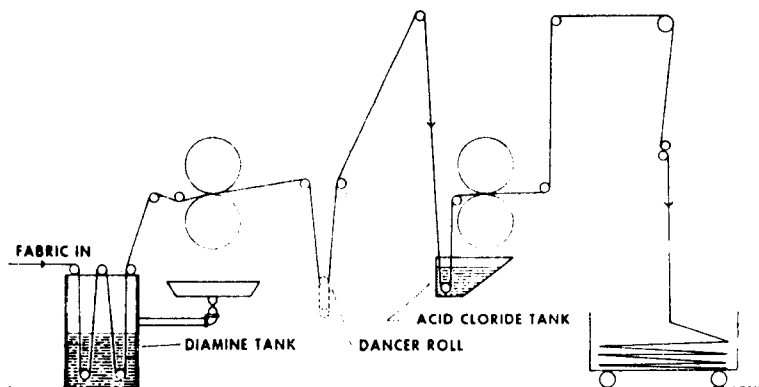
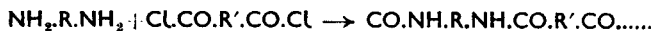

Fig. 11.10 Diagram of graft polymerization plant

(Courtesy of American Dyestuff Reporter)

diamine in a aqueous solution and then transferring it to a liquor containing a diacyl chloride dissolved in a water-immiscible solvent. The result is that a polymer (a polyamide) is formed at the interface between the aqueous and non-aqueous phases situated at the surface of the fibre:



The best results have been obtained by using hexamethylenediamine in the first stage and sebacyl chloride in the second (see Fig. 11.10).

The primary amino groups in the side chains of the proteins will react with acid chlorides. There is evidence to show that whilst interfacial polymerization takes place the following reaction occurs simultaneously:

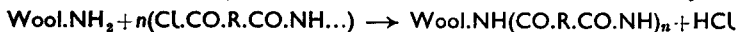

Thus graft polymerization takes place anchoring the film to the fibre. See also *Amer. Dyestuff Reporter*, 1963, 52, 160, *Wool Science Review*, 1964, No. 26, and *Textile Research Journal*, 1964, 925.

Practically all unshrinkable treatments tend to make wool rather harsh and after-treatment with softening agents is desirable. These are usually cation-active substances (see Chapter 9), the effective ion of which is deposited on the negatively-charged fibres. When these ions are of such a nature that they will tend to reduce friction, they will lubricate the surface of the fibre and produce a soft handle. A typical example, and probably the fore-runner of all the others, is Sapamine KW:

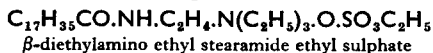

Another example is Cirrasol OD, which is cetyltrimethyl ammonium bromide, $\text{C}_{16}\text{H}_{35}\text{N}(\text{CH}_3)_3\text{Br}$. Some of the cation-active softening agents tend to reduce light-fastness, and this should be taken into account in selecting the dye. These softening agents are usually applied from a liquor made slightly acidic with acetic acid.

Assessment of unshrinkable wools

The two factors which have to be taken into account are the unshrinkability and the amount of damage to the fibres.

With regard to shrinkage, a differentiation between felting shrinkage and relaxation must be made. Relaxation is the recovery of the original dimensions due to the removal of stretch applied in boarding or pressing or other mechanical finishing operations occurring when a sample is immersed in water.

Unshrinkable finishes are applied, in the main, to knitted goods, the shrinkage testing of which is described in B.S. 1955 : 1953, *Shrinkage of knitted fabrics and garments containing wool*. When the specimen to be tested is cut from a piece of fabric its width should not exceed its length and its area should not be less than 100 sq in. Fabrics should be of double thickness, the free edges being sewn together with sewing cotton. An area on the specimen is marked with indelible ink or knots of fast-dyed sewing cotton in the directions of the courses and the wales, the marks being not less than 2.5 cm (1 in.) from the edges, and there should be at least three marking points along each side.

To determine relaxation shrinkage the samples are soaked for at least

2 hours at 35° to 37°C (95° to 98°F) or overnight, starting at 40°C (104°F), in 20 times their weight of a freshly prepared solution containing 0.3 per cent of sodium sesquicarbonate, ($\text{Na}_2\text{CO}_3 \cdot \text{NaHCO}_3 \cdot 2\text{H}_2\text{O}$), and 0.05 per cent of a sodium alkyl sulphate using water of zero hardness. After soaking, the specimen is rinsed twice in water of zero hardness with as little agitation as possible, and transferred, without distortion, to a tray containing just sufficient water of zero hardness to cover the specimen when lying flat without restraint. The specimen is measured when still under the water whilst it is as nearly as possible in a completely relaxed state. When it has been immersed for only 2 hours, soaking for further half-hour periods should be repeated till the dimensions show no further alteration. Relaxation is expressed as percentages of the original length and width which have been lost.

There are two alternative ways in which the milling shrinkage can be determined. A horizontal rotating-drum washing machine may be used (see Fig. 9.29, Chapter 9) provided with a reversing mechanism. The cage should be provided with an internal baffle and must be 18 in. in diameter. The speed of rotation should be 21 rpm and the direction must be reversed after each 4 or 5 revolutions. The load in the machine should be equal to 2½ lb of air-dry fabric per cubic foot of cage space and, if necessary, the load can be made up with wool fabric rendered unfeltable by chlorination or some other unshrinkable treatment. The liquor ratio is 12.5:1 and during the test the machine is run continuously at 35° to 37°C (95° to 98°F) for the specified time, which differs according to circumstances. The sample, after milling, is measured under water in a tray, in the manner already described. The milling shrinkage is the percentage loss of width and length in relation to the relaxed dimensions.

As an alternative the test may be carried out in the laboratory scale-milling machine described in B.S. 1955 : 1953 (Fig. 11.11). The excess liquor is removed from the specimen, after determination of relaxation shrinkage, by passing the fabric through the rubber-covered rollers of a hand wringer, or in a hydroextractor, until the liquor retained is 55 to 60 per cent of the dry weight of the sample. The load is then wetted with 40 g of freshly prepared 5 per cent solution of sodium oleate. The sample is subsequently milled under the specified conditions and afterwards rinsed and measured under water in a tray.

Milling shrinkage may also be tested in a wash wheel (Fig. 11.12). The relaxed sample is passed through a wringer and soaked in a freshly prepared 10 per cent solution of sodium oleate at 35° to 37°C, after which it is again passed through the wringer until the weight of solution retained is 50 to 70 per cent of the weight of the air-dry specimen. The sample is next placed in a cylinder of the wash wheel described below, and the machine is allowed to rotate for 2½ hours, after which it is rinsed and measured under water as in the relaxation test.

The wash wheel consists of a number of stainless-steel cylindrical con-

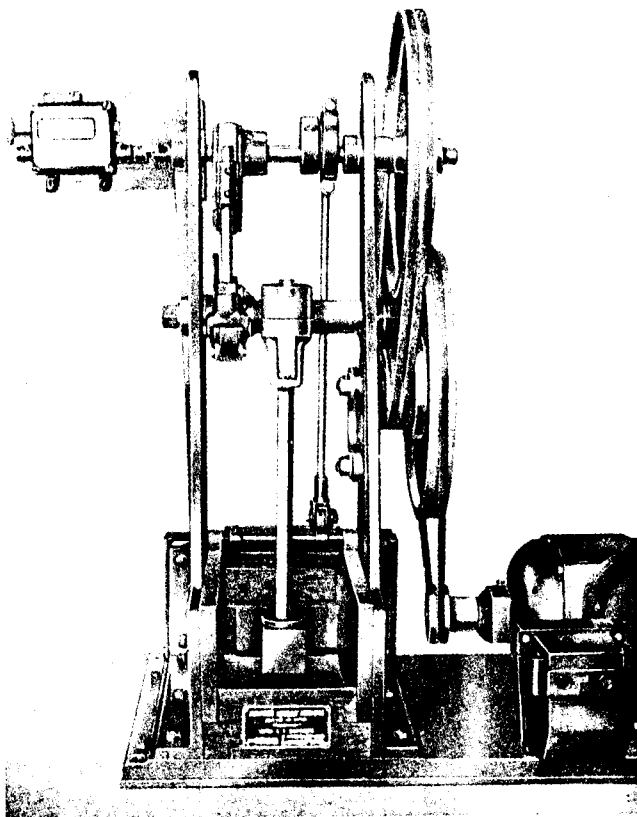

Fig. 11.11 Laboratory milling machine

(Photograph from B.S. 1955 : 1953 'Method of determining the shrinkage of knitted fabrics and garments containing wool' is reproduced by permission of the British Standards Institution, 2 Park St., London, W.1.)

tainers onto which the lids can be firmly clamped. The cylinders have an internal diameter of 26 cm and a volume of 2 litres, and they are mounted on a wheel with a horizontal axle so that they can rotate in a bath which is kept at 35° to 37°C. The wheel revolves at 32 to 34 rpm, altering the direction of rotation after every 5 revolutions. Steel balls of $\frac{3}{4}$ in. diameter coated with $\frac{1}{8}$ -in. vulcanized rubber are placed in the cylinder with the sample, the number of balls being determined as follows:

For specimens weighing 35 g	7 balls
” ” ” 30 g	6 balls
” ” ” 25 g	5 balls
” ” ” 20 g	4 balls
” ” ” 15 g	3 balls

Most of the unshrinkable processes used in practice involve a greater or lesser breakdown of the protein molecules in the scale tissue. If this degradation is not under proper control there is a risk of serious loss of wearing

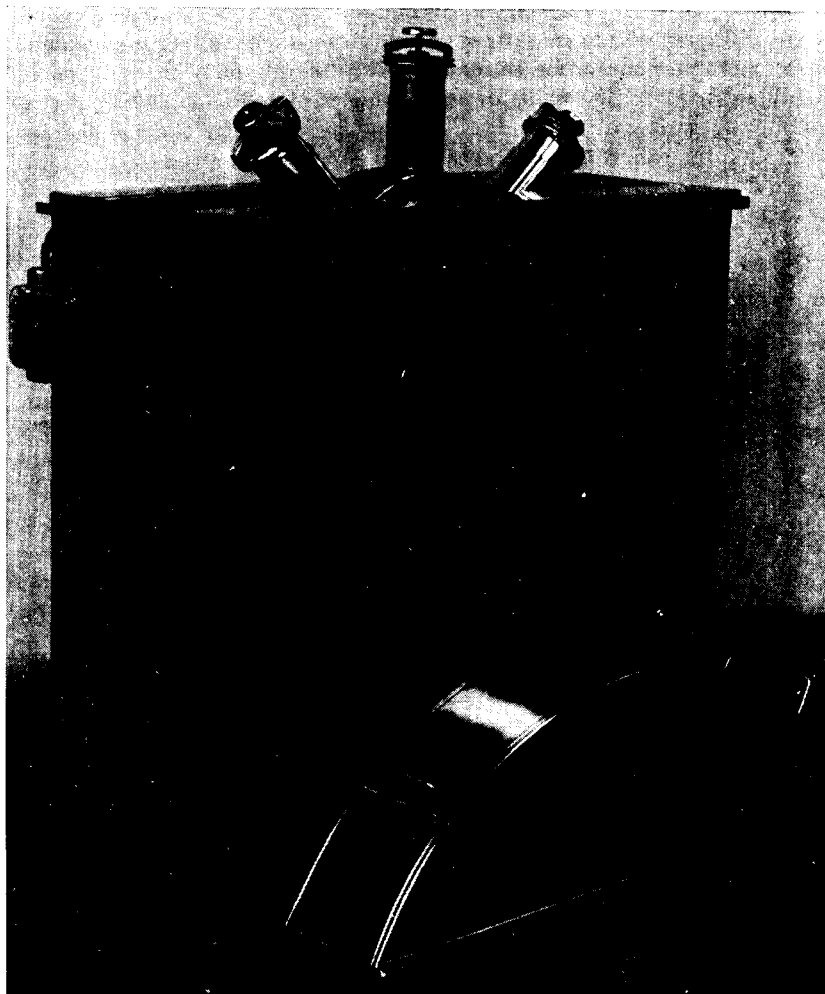

Fig. 11.12 Wash wheel
(Courtesy of Calico Printers' Association)

power. There are a variety of ways in which the extent of the attack can be measured. The original damaged fibre count devised by S. R. Trotman has already been mentioned. This was based upon a subjective assessment and did not detect the finer degrees of degradation. The alkali solubility

determination described in Chapter 10 was of a more quantitative nature, but methods depending upon staining have been developed subsequently.

The acid dye Kiton Red G (C.I. ACID RED 1) stains damaged fibres more deeply than those which are unaffected (TROTMAN, BELL, AND SAUNDERSON, *J.S.C.I.*, 1934, 53T, 265). This observation was developed by Phillips (*J.S.D.C.*, 1942, 58, 245), who recommends the following procedure. A 1 g representative sample of fibres taken from the fabric is agitated in a mechanical shaker for 60 minutes with 100 ml of a solution prepared by dissolving 0.615 g of anhydrous Kiton Red G containing 94.8 per cent of pure dyestuff and 100 ml of 0.1N hydrochloric acid in 2 litres of distilled water. At the end of this period the wool is removed, rinsed till free from loose dyestuff, and dried. The dyed sample is then wound spirally round a wooden pencil, and a longitudinal cut is made along it by means of a

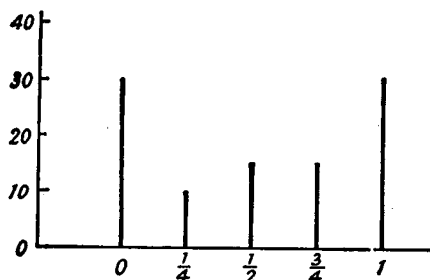

Fig. 11.13 Distribution diagram of a Kiton Red test

cutter consisting of two safety-razor blades clamped together in such a manner that an incision made with it removes a large number of fibre samples of uniform length (approximately 0.3 mm). The fibre cuttings between the blades are scraped into a drop of B.P. paraffin on a microscopic slide, well mixed, and covered with a cover glass. They are then examined, using an 8-mm objective and a $\times 6$ eyepiece. By means of a travelling stage the slide is traversed systematically till 100 fibre sections have been examined, each being assigned to one of five classes according to whether they are coloured white, light pink, pink, pink-red, or deep red. These classes are designated respectively 0, $\frac{1}{4}$, $\frac{1}{2}$, $\frac{3}{4}$, and 1. The results obtained are set out diagrammatically as in Fig. 11.13, which corresponds with the figures in the table.

Degree of damage	Percentage of fibres
0	30
$\frac{1}{4}$	10
$\frac{1}{2}$	15
$\frac{3}{4}$	15
1	30

Whewell and Woods (*J.S.D.C.*, 1944, 60, 148) state that most tests are not sufficiently sensitive to reveal very small modifications in the wool proteins. To be able to detect such changes is important because they may confer upon the fibre a predisposition to suffer greater degradation in subsequent processes or exposures during wear. With very slightly damaged

fibres only the tips of the scales are stained with Methylene Blue, and the area coloured by the dye increases as the damage becomes progressively greater. The wool is immersed in a dilute solution of Methylene Blue (0.4 g microscopic stain per litre) for 1 minute and washed in water for 5 minutes and finally dried. The stained fibres are cut into short lengths of about 1 mm, mounted in liquid paraffin and examined under a magnification of about $\times 200$. The fibres are graded into five classes:

<i>Class</i>	<i>Appearance</i>
0	No staining.
1	Stains are extending down scale for not more than $\frac{1}{4}$ of the maximum scale length.
2	Showing staining more extensive than in Class 1 but not extending over the whole scale surface, i.e. blotchiness.
3	Complete staining of scales but scale edges still well marked.
4	Heavy general staining, scales not clearly visible.

The result of the examination is expressed as the mean score, which is the sum of the percentage per group multiplied by the respective group numbers and divided by 100. For example, the following count: group 0 = 49 per cent, group 1 = 38 per cent, group 2 = 13 per cent, and groups 3 and 4 = 0 per cent, would give a mean score of $\frac{38 + (13 \times 2)}{100} = 0.64$.

The test is extremely sensitive and will even detect mechanical damage. Its use was recommended mainly for assessing susceptibility to chemical damage, and it was therefore necessary to bring about a controlled limited amount of attack before staining. This was done by extraction in alcohol and ether followed by treatment in 100 ml of sodium hypochlorite solution containing 0.12 per cent of available chlorine at pH 10 for 15 minutes at 20°C (68°F).

The Pauly test consists essentially of treating wool with diazotized sulphanilic acid which couples with the tyrosine and histidine residues to form a brown-coloured product. These residues are found only in the cortex and are absent from the cuticle so that the degree of staining is a measure of the breakdown of the scales. A modification of the Pauly test was recommended by Rimington (*J. Text. Inst.*, 1930, 21t, 237). The reagents required are:

Sodium sulphanilate	10 per cent solution
Sodium hydroxide	10 per cent solution
Sodium carbonate	9 per cent solution
Sodium nitrite	8 per cent solution
Concentrated hydrochloric acid	
Naphthalene Leather Brown BS	0.1 per cent solution

A weighed quantity of the wool is wetted with 15 ml of the sodium carbonate solution in a test tube, whilst 10 ml of sodium sulphanilate and 5 ml

of sodium nitrite solutions are mixed in a separate test tube. 2 ml of hydrochloric acid are added to the first test tube, which is allowed to stand for 1 minute, after which the sulphanilate/nitrite mixture is added. After standing for 1 minute the wool is removed and rinsed with water. It is then treated with 4 ml of sodium hydroxide solution and heated for 5 minutes in boiling water. The dissolved wool is transferred to a graduated flask and made up to 25 ml with water. The colour is compared with the Naphthalene Leather Brown BS solution which represents 100 units of damage. Edwards (*J. Text. Inst.*, 1933, **24**, 1) suggests that the matching of the colour is more reliable when 292.5 ml of a 0.1 per cent solution of Polar Brilliant Red is added to 1 litre of the Naphthalene Leather Brown BS.

Lees and Elsworth (*International Textile Wool Conference*, 1955) drew attention to the fact that wool which has been submitted to an alkaline treatment has a lowered alkali solubility. To avoid this source of error the urea bisulphite test was proposed. Alkali treated wool has a lower solubility in the urea bisulphite reagent, and treatment under acid conditions brings about an increased solubility. These facts make it possible to arrive at an historical deduction of the nature of the cause of any degradation.

About 0.5 g (dry weight) of the wool is immersed in 50 ml of a solution containing 50 g of urea and 3 g of sodium metabisulphite per 100 ml. The flask containing the wool and the solution is maintained at $66 \pm 1^\circ\text{C}$ for one hour after which the wool is separated from the solution by filtration in a Gooch crucible. After washing three times with a 3 per cent urea solution and six times with distilled water the specimen is dried and weighed and the alteration, in relation to the original weight, is determined (for detailed information see *Textile Scouring and Bleaching*, E. R. Trotman, Griffin, London).

Crease-resistant finishes

Cellulosic fibres do not shrink but, unlike wool, their inherent disadvantage is that fabrics made out of them crease badly. Crease-resistant finishes, therefore, rank equally in importance with unshrinkable processes in making cotton or rayon materials more acceptable for many purposes. Protein fibres probably resist creasing because molecules are bound together by primary chemical bonds, and these pull the fibre back to its original shape and position, after the application of considerable highly-localized force of a nature to make a crease. The weaker Van der Waals forces and hydrogen bonds in the cellulosic fibre are incapable of pulling the fibre back to its original form. Fibres containing a high proportion of amorphous regions are markedly prone to crease because of the absence of intermolecular binding forces. With more orientation, as would be expected, crease resistance becomes greater but, surprisingly, in the most highly-orientated regenerated celluloses creasing again becomes pronounced. It is believed that this phenomenon is connected with the fact

that the majority of the molecules are fully stretched and, in this state, they are prone to slip, producing plastic flow with resultant decrease in resistance to creasing.

These considerations led to the conclusion that if the amorphous regions could be filled with some other molecules which would be retained permanently, the fibre would become more rigid and slippage of molecules would be, to a great extent, prohibited. The problem was to find molecules small enough to enter, which could then be polymerized so that they could not migrate out again. The first crease-resistant cellulosic fabric was made by impregnation with phenol and formaldehyde and polymerizing by heating under alkaline conditions, when a three-dimensional network was formed (1). This method was interesting because it demonstrated the way in which

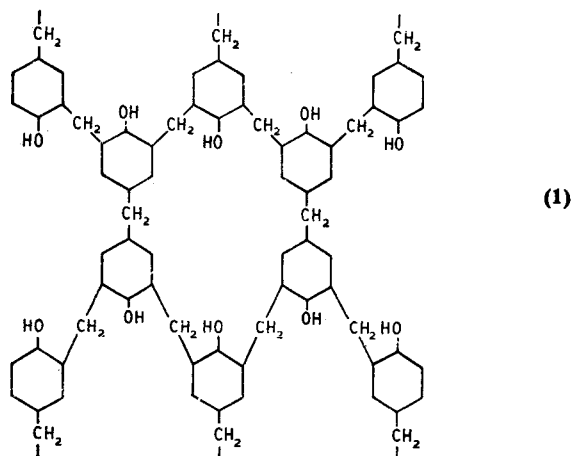

the problem should be tackled, but it was not practical because of the discoloration which it caused. The second process described by Tootal, Broadhurst Lee & Co., Foulds, Marsh, and Wood (Brit. Pat. 291473, 1928) used urea and formaldehyde, which gave a polymer of which the following is an idealized formula:

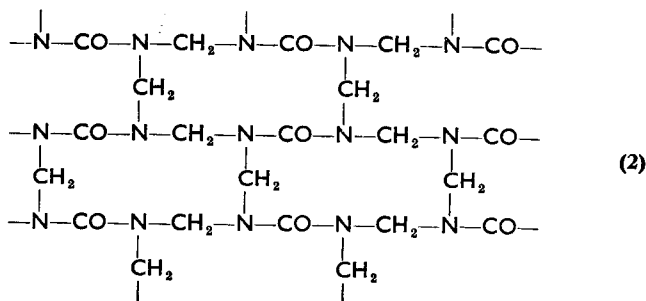

The fabric is impregnated with a solution containing 20 parts of 40 per cent formaldehyde, 10 parts of urea, 5 parts of boric acid, and 60 parts of water. Impregnation is carried out at ordinary temperature and, after squeezing, the material is dried and heated to 130°C for 30 minutes to complete polymerization. Finally any unpolymerized reagents are removed by washing in boiling soap.

Since the original Tootal patent there has been much research on alteration of the properties of cellulosic materials by the formation of polymers *in situ*. The original formaldehyde urea method for the crease-resistant finish is probably still the most commonly used. Dimethylol-urea is now used as the monomer instead of a mixture of urea and formaldehyde. It is the product of the reaction of one molecule of urea with two molecules of formaldehyde:

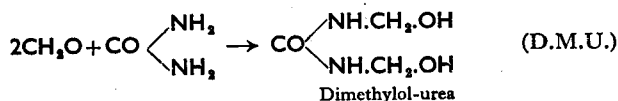

The advantage of dimethylol-urea is that the correct quantities of formaldehyde and urea are available in a pre-prepared state. It also ensures that, on polymerization, there will be an extremely high yield of the completely cross-linked product shown in (2) which is free from amino or imino groups. Methylol ureas, however, are comparatively unstable, and for this reason there is a tendency to prefer the more stable methyl esters, such as shown in (3), which condense with the elimination of methyl alcohol:

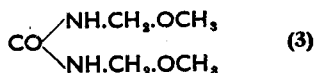

Dimethylol cyclic ethylene urea (4) dimethylol methyl triazone (5) and trimethylol melamine methyl ester (6) are also used.

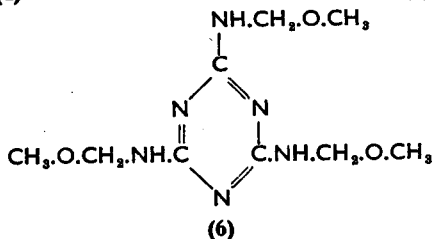
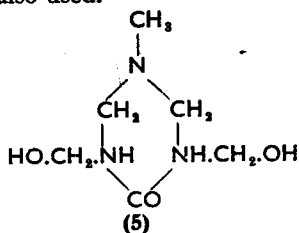
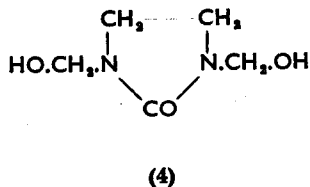

Resin finishes were originally developed for their crease-resistant properties but, according to Marsh (*J.S.D.C.*, 1960, 76, 23), they impart many other desirable properties such as:

- (i) smooth drying properties after laundering;
- (ii) durable effects which may be imparted by intermediate mechanical treatment;
- (iii) reduced laundry shrinkage;
- (iv) increased dry tensile strength and greatly increased wet tensile strength of rayon;
- (v) improved fastness to washing and rubbing of most dyes;
- (vi) decreased water imbibition and more rapid drying;
- (vii) improved handle and drape;
- (viii) increased weight;
- (ix) increased resistance to distortion and improved retention of garment shape;
- (x) improved resistance to slippage and fraying;
- (xi) vehicle for modern flameproofing agents;
- (xii) increased resistance to photo degradation and weathering; and
- (xiii) increased resistance to rotting.

The quick-drying and crease-shedding properties of the synthetic yarns made domestic laundering much easier and eliminated the need for ironing. This created a demand for cellulosic goods with similar characteristics, and this was met by the so-called 'easy-care' finishes. It will be apparent from the properties listed under (i), (vi), and (ix) that crease-resistant finishes can be adapted for 'drip-dry' or 'wash-and-wear' products. Mercerization or, better still, tension-free treatment with caustic soda before padding opens up the structure of the fibre and facilitates the entry of the pre-condensate.

Urea or melamine and formaldehyde resins are not entirely satisfactory for 'easy-care' finishes. They are not sufficiently resistant to washing, and the polymers contain secondary amino groups which react with hypochlorite to form chloramines:

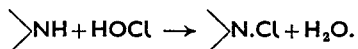

The chloramines decompose on storage with the accompanying appearance of a yellow discoloration, and under the influence of ironing they give rise to hydrochloric acid which causes loss of strength:

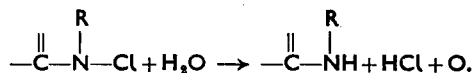

Since hypochlorites are often used in domestic washing the presence of imino groups is to be avoided. Compounds of the type dimethylol ethylene urea (4), tetramethylol acetylene diurea (7), diurethane (8), and epoxy

Cross-linking

Crease resistance and dimensional stability are imparted both by polymer formation within the fibre and by building cross-links between adjacent cellulose chains. It has been known for a long time that formaldehyde will react with cellulose.

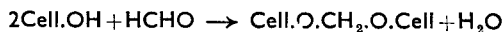

When impregnated with an acidified solution of formaldehyde and dried and heated the strength of regenerated cellulose fibres is increased by something of the order of 29 per cent, but there is a corresponding decrease in extension at break of 15.5 per cent. Treatment with formaldehyde has been used to a limited extent to give dimensional stability to rayon fabrics but the stronger treatment necessary to give crease resistance makes the product too brittle.

It is generally accepted that the action of formaldehyde is to build cross-links (Marsh, *J.S.D.C.* 1959, 75, 244). Formaldehyde and other cross-linking reagents can be applied in aqueous solution to cellulosic fibres in a swollen state. The result is that creases are not formed during immersion in water but there is only poor dry crease recovery. This is the basis of the 'drip-dry' finish in which the garments, after washing, must be hung up so that they are virtually free from creases whilst they are drying. The explanation of the difference between wet and dry crease resistance suggested by Marsh (*loc. cit.*) is illustrated diagrammatically in Fig. 11.14.

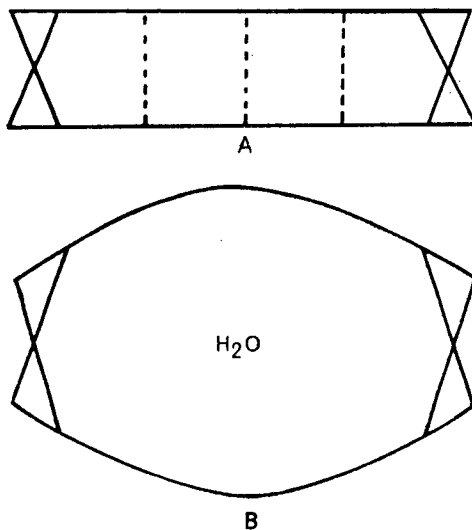
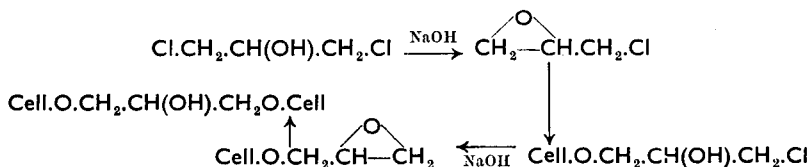

Fig. 11.14

(A) illustrates the effect of building cross-links (X) in a dry fibre where the molecular chains can also be bound together by hydrogen bonds (dotted

lines). The heat treatment has, in fact, brought the molecules closer together and promoted the formation of additional hydrogen bonds. A more rigid structure is therefore formed which does not swell readily on re-immersion in water. When cross-links are built in aqueous solution the fibre is distended (B) so that hydrogen bonds cannot be formed, nor are they re-formed to the same extent during subsequent drying.

Formaldehyde as a cross-linking agent has never achieved much success because of the brittleness and loss of strength which accompanies its use. Better results have been obtained with 1.3.dichloro.2.propanol which, in the presence of alkali, probably builds cross-links through the following series of reactions.



Divinyl sulphone is also a useful cross-linking reagent:



The substance itself, however, is toxic and lachrymatory, but the addition product which it forms with sodium thiosulphate has no objectionable properties and is equally effective:

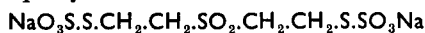

Flameproof or fire-resistant finishes

Cellulosic materials can constitute a serious fire hazard. Specifications, therefore, may demand flame-retarding treatment. Flame resistance is tested by the method described in British Standards Handbook, No. 11, page 306. The apparatus illustrated in Fig. 11.15 is used. The sample is placed on the specimen platform which stands at an angle of 45°. The platform is in the form of a ladder so that the specimen is accessible to air from all directions, the material being secured at top and bottom with drawing pins. The igniting source is a micro-burner using butane gas. A weighted cotton thread is mounted horizontally across the specimen holder 5 in. from the point of ignition. If in six successive tests the flame does not reach the cotton thread the material is rated 'flame resistance less than 100.' When the flame does sever the cotton thread the flammability resistance rating is $2.5 \times t$, when t is the time in seconds for the flame to travel the marked 5 inches.

The inclined plane test is not recommended for fabrics with high flame resistance, and the vertical strip test is preferred (B.S.2963, 1958). The test specimen should be 6 ft long and 1.5 in wide. This is hung vertically by means of a clip from a rectangular frame which is 6 ft 6 in. high and

1 ft wide. Horizontal wires cross the frame 11 in. and 61 in. below the clip. The air supply to a bunsen burner is cut off and the gas supply adjusted to give a luminous flame $1\frac{1}{2}$ in in length. The burner is then placed so that the base of the flame is 1 in below the lower edge of the specimen. The bunsen burner is removed 12 seconds after its application to the base of the specimen. If the flame goes out before its bottom edge has passed the lower marker wire six times in succession the material is graded *Flame not propagated*. If the flame is propagated to the upper marker wire the flame resistance is $2 \times t$, when t is the time in seconds for the lower edge of the flame to pass from the bottom to the upper marker wire. [See also *J.T.I.*, 1965, P. 39].

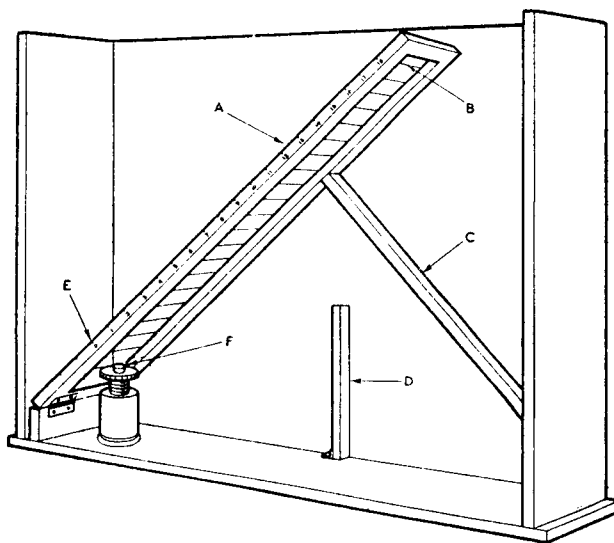

Fig. 11.15 Flameproof and smoulder-proof apparatus

Key:

- A—Specimen platform supported at an angle of 45 degrees, internal width $6\frac{1}{2}$ in.
- B—21 Nichrome wires (28 s.w.g.) at 1-in. centres
- C—Movable support
- D—Extra support if special angle slope is required
- E—Zero mark
- F—Ignition cup on screw head $\frac{1}{32}$ in. thick, $\frac{11}{16}$ in. external diameter, $\frac{3}{8}$ in. high, mounted on cork, placed 1 in. below the third (zero) wire

(Courtesy of GARNER, 'Textile Laboratory Manual')

Nearly all successful flame-resistant finishes depend upon the application of compounds containing phosphorus to the cellulose. Not much is known about the combustion of cellulose, but it has been established that it breaks down into a solid carbonaceous char accompanied by the formation of volatile liquids, gases, and tarry substances. Anything which reduces the formation of volatile products of combustion will retard the rate of propagation

of the flame. Examination of charred residues of cellulose treated with phosphorus compounds shows that phosphoric acids are present. It has been suggested that, at the temperature of the flame, the oxides of phosphorus have the property of combining with any water which is formed, thereby restricting the production of gaseous compounds.

Some tragic accidents due to wearing flannelette directed attention to the need for flameproof finishes at the beginning of the present century. In 1903 and again in 1913 patents were granted to W. H. Perkin protecting the use of sodium stannate and sodium aluminate. Temporary fire-proofing may be achieved by soaking the goods in a 10 per cent solution of a variety of salts such as ammonium chloride, ammonium phosphate, sodium phosphate, or sodium borate. The salts were then dried in, but such treatment was not very effective because the salts were dissolved the first time that the goods were washed and it had an adverse effect upon the handle. Perkin's method gave a more permanent finish. The material was first soaked in a solution of sodium stannate, squeezed, dried, and then immersed in a solution of ammonium sulphate, after which it was rinsed and dried again. The treatment left a deposit of insoluble tin oxide on the fibre which had some degree of fastness to water. The method did not find much application and has now been replaced by better processes.

Several commercial flame-resistant finishes are based on esterification of the cellulose with phosphoric acid (PERFECT, *J.S.D.C.*, 1958, 74, 829):

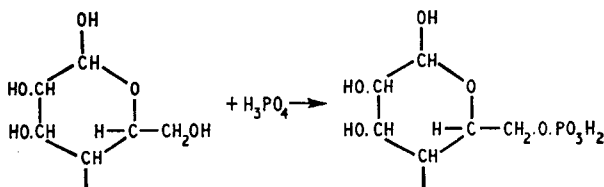

Esterification of cellulose with phosphoric acid yields a product which is not inflammable, but is of no use because the loss of tensile strength is excessive. The loss of strength is avoided if the esterification is carried out in the presence of urea (Brit. Pat. 604197) or cyanamide (Brit. Pat. 634690). The treated fabrics, however, are rather brittle and the flame-resisting effect does not stand up to repeated washings.

Tetrakis-hydroxymethylphosphonium chloride is obtained by the action of phosphine on formaldehyde and hydrochloric acid in solution:

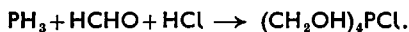

For convenience, it is usually referred to as THPC. Reeves and Guthrie (*Dyer* III., 1954, 567) reported that fire resistance of good fastness to washing could be obtained by applying THPC together with urea and methylol melamine. An example quoted by Perfect (*loc. cit.*) is as follows:

Two solutions are made up, (a) and (b):

- (a) 1868 g THPC dissolved in 1800 ml water together with 388 g of triethanolamine,
- (b) 1069 g of trimethylol melamine and 1114 g of urea dissolved in 5062 ml of water.

The two solutions are mixed and padded onto the cloth under conditions which give a 70 per cent take-up. The fabric is dried and baked at 142°C (288°F) for 4½ minutes and then washed well to remove any unreacted residual substances.

The Proban finish is of a similar nature and consists of padding with a solution which, to quote an example, is made up as follows: 15.8 per cent THPC, 9.5 per cent methylol melamine, 3.0 per cent triethanolamine, 9.9 per cent urea. The cloth, after impregnation, is dried and baked at 140° to 160°C (284° to 320°F). The fastness to washing of this finish is due to the fact that the phosphorus is contained within a polymer deposited in the fibre of the general structure:

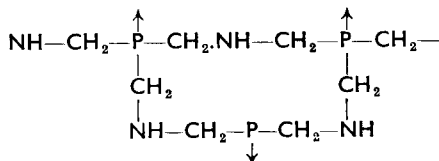

More recently it has been found that THPC will react with ammonia to give an insoluble polymer and this has resulted in a simplification of the Proban finish. After padding with THPC the cotton is exposed to ammonia gas followed by immersion in aqueous ammonia. No heat setting is necessary and there is some improvement in wet crease-recovery, suggesting that there is a degree of cross-linking.

The Erifon (U.S. Pat. 2570566) and Titanox (U.S. Pat. 2658000) processes depend upon padding with an acidified solution of antimony and titanium oxychlorides (WARD, *J.S.D.C.*, 1955, 71, 569), and subsequently treating with a 15 per cent sodium carbonate solution. A compound of the type shown below is formed:

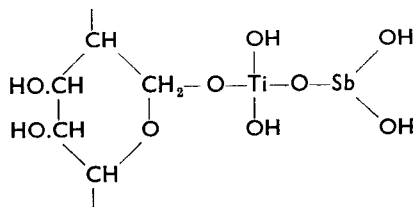

Read and Heighway-Bury (*J.S.D.C.*, 1958, 74, 823) describe the impregnation of cellulose with an emulsion composed essentially of antimony

oxide and polyvinyl chloride in a state of partial polymerization. As an example of a padding solution the following is quoted:

	<i>Parts by weight</i>
Chlorinated paraffin (cereclor 2)	362
Diocetyl phthalate	362
Sodium carboxymethylcellulose (2 per cent solution)	100
Emulsifying agent	16
Water	600
Antimony oxide	364
Polyvinyl chloride latex	1500
Silicone antifoam	1

The purpose of the chlorinated paraffin is to give a softer handle. The padded fabric is dried and then heated to 120° to 140°C (248° to 284°F) for about 2 to 4 minutes, which brings about further polymerization of the polyvinyl chloride, which has the effect of fixing the antimony oxide.

The use of triallyl phosphate together with bromoform and a small amount of polyvinyl alcohol as the components of a phosphorus-containing polymer which is formed on heat curing, has been recommended (FRICK, WEAVER, AND REID, *Text. Res. J.*, 1955, 25, 100). These components may also be used in conjunction with THPC (Reid *et al.*, *Text. Res. J.*, 1956, 26, 41). Trisaziridinylphosphine oxide (APO), obtained by the action of phosphoryl chloride on ethylene imine, has been used to co-polymerize with THPC:

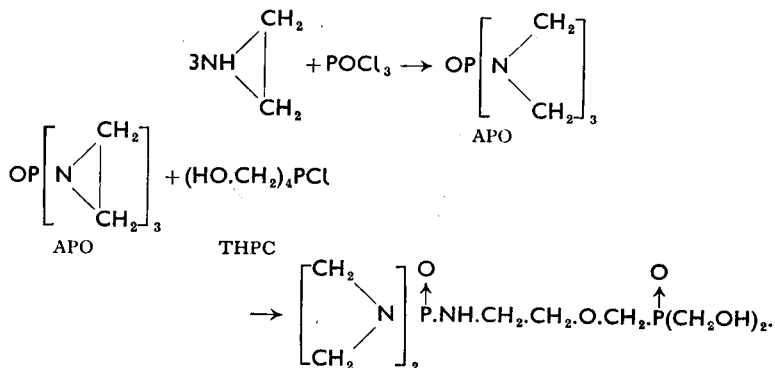

Waterproof finishes

A distinction must be made between waterproof clothing which is generally rubberized or made of synthetic polymers such as polyvinyl chloride, and water-repellent materials which give limited but adequate protection for most purposes.

A very simple but not very permanent water-repellent finish is obtained by depositing wax from an emulsion. Waxol PA (I.C.I.), for instance, is a

stabilized emulsion of paraffin wax, and the recommended treatment is by a two-bath process in which the wax is applied first and the cloth is subsequently transferred to a liquor containing a metallic salt such as aluminium sulphate. Insoluble soaps have found extensive use in making water-repellent materials. In practice, aluminium soap is most favoured. The fabric is soaked, first in a soap solution and, after squeezing, in a bath containing alum. It is then dried and hot pressed to melt the aluminium soap so that it will be evenly spread and will adhere firmly. As an example, the first liquor might well be a 0.2 per cent soap solution, and the precipitating bath might contain a 0.1 per cent solution of aluminium acetate.

A great advance was made by the introduction of pyridinium compounds containing a long-chain aliphatic radical which could be split off on heat curing. The earliest of this range of products was Velan PF which is stearamido-methyl pyridinium chloride, $(C_{17}H_{35}.CO.NH.CH_2.N) Cl^-$, con-



taining an active cation which is deposited on the fibre. The impregnated material is dried and heated to a temperature between 120° and 150°C (248° to 302°F). It is believed that during heating the pyridine and hydrochloric acid split off and the residual stearamide methylol group unites with the cellulose, the hydrophobic paraffin chains being oriented outwards (DAVIS, *J.S.D.C.*, 1947, 260; see Chap. 9):

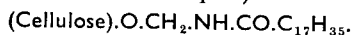

Some sodium acetate or other buffer should be added to the padding solution to reduce the potential degrading action of the hydrochloric acid which is liberated.

The latest development is the use of silicones for water-repellent finishes. Linear dimethyl polysiloxane:

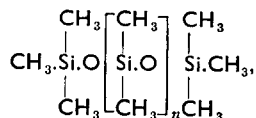

is powerfully hydrophobic, but the polymer is only formed at temperatures of 200° to 250°C (392° to 482°F) (MADARAS, *J.S.D.C.*, 1958, 74, 835), which are too high for textile applications. To overcome this difficulty methyl hydrogen silicones, which can be cured at 150°C (302°F), have been introduced:

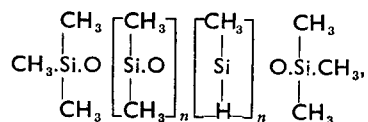

but these suffer from the disadvantage that they have an adverse effect upon the handle. A mixture of the fully methylated silicones and the methyl

hydrogen compounds has given the most successful results. The polymerization takes place in a shorter time and at a lower temperature when metallic compounds such as zinc octate, or preferably butyl titanate, are added to act as hardening agents or catalysts.

Application from an organic solvent using a catalyst which promotes polymerization at normal temperature is an extremely simple operation. A suitable silicone (containing no SiH bonds) is selected and dissolved in white spirit with butyl titanate and padded or sprayed onto the material, which is then dried on any conventional drying machine, after which storage of about 48 hours at normal temperature is necessary for the polymerization to complete. The padding solution will not keep for more than 12 hours.

The use of organic solvents in a factory often presents difficulties such as the need to take stringent fire precautions. For this reason silicone emulsions are available, supplied with a catalyst which must be mixed just before use because, as soon as it is present, the mixture has only a short useful life. When the catalyst is an organic derivative of titanium it is possible to complete the treatment with cold curing, and this method is especially suitable for protein fibres. The goods, previously wetted out, are immersed in a bath with sufficient water to give a liquor ratio of 30:1, and the pH is adjusted to between 4 and 6. The diluted emulsion is added and the machine is allowed to run with sufficient agitation for 30 to 35 minutes. The goods are then hydroextracted, dried by conventional means, and stored because, in the cold, a further 10 to 14 days will be necessary for the polymerization to be complete.

Silicone and other water-repellent treatments also confer stain resistance on the materials to which they have been applied.

Moth-proof finishes

The protection of wool against moths is desirable and probably more important in warmer climates. There are a number of organic substances capable of making the fibre poisonous or unpalatable to the moth grubs which cause the damage. The earliest of this series of products was Eulan BL:

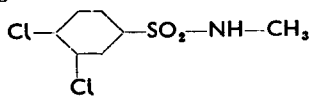

and D.D.T. is a contact poison:

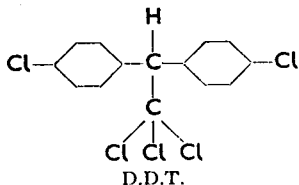

but they are both insoluble in water and have to be applied from organic

solvents. The first water-soluble compound which could be fixed on wool by boiling in a dilute acid solution was Eulan N:

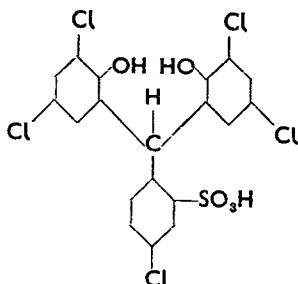

and this was followed by Lanoc CN, probably of similar constitution, and then by Mitin FF:

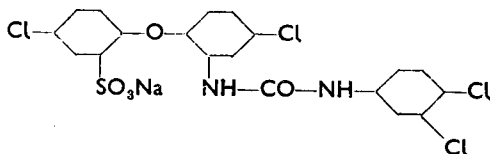

Mitin FF

Two per cent of Eulan N gives protection. It has no effect upon the colour of the wool, will exhaust from a neutral bath but does so better from one which is acid, and is absorbed more completely at the boil. It does not interfere with dyeing and can be added to the dyebath. The application of Mitin FF is similar.

An interesting aspect is that moths only thrive on keratin which contains disulphide bonds. If these are ruptured by reduction with sodium hydro-sulphite and thioglycolic acid and new links are built by methods such as joining primary amino groups with glyoxal, the wool is immune from attack by moths.

Anti-mildew agents

Both protein and cellulosic fibres are liable to be attacked by mildew. The conditions favourable to the growth of fungi are a high relative humidity (90 to 100 per cent), temperatures between 25° and 35°C (77° to 95°F) and a pH range between 4 and 7.5. The optimum pH range varies with different species and those which attack protein fibres prefer pH 6 to 7.5, whilst the varieties found on cellulosic fibres frequently thrive under more acid conditions. The greater the purity of a cellulosic fibre, the more immune it is from attack. Traces of protein or other impurities supplement the diet and encourage the use of the cellulose as the main source of carbon. Sized cotton containing starch is particularly vulnerable, and rayons, because of their purity, are much less frequently infected.

The characteristic musty smell of mildew will usually be apparent before damage has occurred, and scouring, followed by the application of an anti-mildew agent at this stage, can save the goods from being spoiled. Mildew causes brown or coloured spots, usually before serious breakdown of the fibre substance has taken place. Cellulosic materials can be cleared of the discoloration by bleaching with hypochlorite, frequently before serious loss of strength has arisen. The removal of the stains on protein fibres is not so easy because the use of hypochlorite is not permitted and they do not respond well to peroxide.

Many substances will prevent the growth of mildew. Zinc, copper, and mercury salts, phenols, chlorophenols, and phenylphenols have been used. Zinc chloride is very effective and was used extensively in the past, but it was not without objections, such as a tendency to cause tendering, particularly during singeing. The British Cotton Industry Research Association found that salicylanilide:

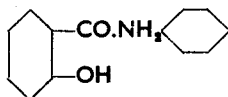

was extremely good and the product was marketed under the name of Shirlan. The compound is insoluble in water but is mixed, either as a fine powder or as a paste, with the size or other finish. When sizing is not practised the Shirlan can be dissolved in ammonia and the cotton impregnated with the solution. On drying, the ammonia is driven off and a deposit of the salicylanilide remains. Shirlan NA is a water-soluble sodium salt suitable for addition to water used to condition yarns, and is used for both cellulosic and wool goods. The addition of an anionic surface active compound to the solution assists penetration.

12. Introduction to chemical constitution and colour, theory of dyeing, and classification of dyes

DYESTUFFS give colour to the material onto which they have been anchored, by selectively retaining some of the wavelengths out of the light falling upon the surface. If, therefore, a dye absorbs strongly at the red end of the spectrum the light which is reflected will be of a bluish hue.

Table 12.1

<i>Wavelength of light absorbed</i>		<i>Absorbed light</i>	<i>Visible colour</i>
SI (nm)	Å		
400-435	4000-4350	Violet	Yellowish-green
435-480	4350-4800	Blue	Yellow
480-490	4800-4900	Greenish-blue	Orange
490-500	4900-5000	Bluish-green	Red
500-560	5000-5600	Green	Purple
560-580	5600-5800	Yellowish-green	Violet
580-595	5800-5950	Yellow	Blue
595-605	5950-6050	Orange	Greenish-blue
605-750	6050-7500	Red	Bluish-green

Only a limited number of organic molecules possess this property of absorbing light selectively. Ever since about 1860 intense interest has been displayed in investigations to discover which aspects of molecular structure are responsible for colour.

In 1868 Graebe and Liebermann recorded the observation that reducing agents almost invariably destroyed the colour of organic compounds. They therefore concluded that colour was associated with unsaturation, which showed a remarkable degree of insight because now, nearly a century later, colour is still attributed, amongst other things, to unsaturation. In 1876 Witt suggested that groups such as nitro, nitroso, azo, and carbonyl conferred upon a substance the potentiality of becoming coloured. To these groups he gave the name chromophores. In order, however, that the potentially coloured substance should become a useful dye, the molecule should contain, in addition to the chromophore, amino, substituted amino, hydroxyl, sulphonic or carboxyl groups which were called auxochromes.

Not only do the auxochromes, in many cases, supplement the chromophore in the production of colour, but they also render the molecule soluble in water and assist in giving it an affinity towards the fibres.

Witt's chromophores did not explain all the phenomena of colour. In particular, tetramethyl-*p*-amino triphenyl carbinol (1):

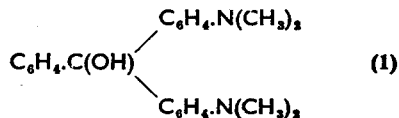

is colourless, but its hydrochloride is an intensely vivid green colour. In 1888 H. E. Armstrong proposed what became known as the quinonoid theory of colour. He postulated that the quinone ring (2):

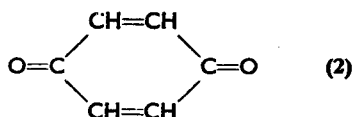

was a chromophore, and this view was supported by the fact that all known quinones were coloured, but became colourless when reduced to the benzenoid type of structure (3):

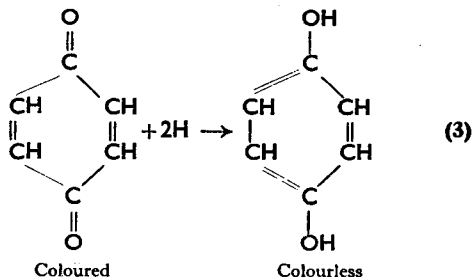

When colourless tetramethyl amino triphenylcarbinol (4) is treated with hydrochloric acid there is loss of water with the formation of the structure shown in (5):

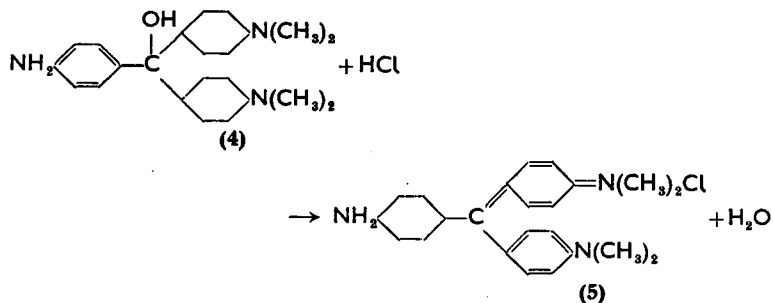

which has a quinonoid ring and is highly coloured. It has been found that many other dyes could undergo isomeric change, or could by simple rearrangement be assigned structures containing a quinonoid component.

The quinonoid theory, however, was not entirely satisfactory because, for example, di-iminoquinone is colourless. An interesting observation was made by Gomberg in 1899 when he demonstrated the existence of triphenyl methyl, which is a yellow colour. This radical contained one trivalent carbon atom, and 'isolated unsaturated atoms' were added to the list of chromophores.

All these theories are now only of historical interest because developments in spectroscopic techniques and the application of the quantum theory and wave mechanics are throwing an entirely new light upon our understanding of the causes of colour. In the first place, spectroscopy has shown that all organic compounds, whether they contain chromophores or not, absorb radiation. The fact that some are coloured is purely fortuitous because it so happens that their strong absorption bands lie within the narrow range of radiation to which the human eye is sensitive. Colour, therefore, is only a special aspect of a general phenomenon.

Molecules can exist at a number of different energy levels, but under normal conditions of temperature and pressure, they will be at the lowest, which is known as the ground state. They can absorb radiant energy and be brought to higher energy levels, when they are described as being in an excited state. Energy can only be absorbed when the quantity presented conforms exactly with the amount demanded by the molecule to bring it to its higher level and the quantity is defined as follows:

$$\Delta_E = hv$$

when Δ_E is the difference between the energy levels of the two states,
 h is the quantum constant,
 v is the frequency of the absorbed radiation.

If a compound is to be coloured, v must be within the range of visible light. To determine the relationship between chemical constitution and colour it is therefore necessary to find out what causes molecules to absorb light within the range to which the human eye is sensitive.

Visible light falls within a comparatively narrow band of wavelengths somewhere near the middle of the total range of the electromagnetic radiations, as can be seen by referring to Fig. 26.1. The energy of the radiation varies as the frequency, which is inversely proportional to the wavelength. The energy content of visible light is, in terms of molecular activity, not great. Colour will therefore be manifested by those compounds with molecules in which Δ_E between the ground and the excited state is comparatively small and is, in fact, of the order of 40–70 kcal/mol.

Resonance

In 1935 Bury (*J. Amer. Chem. Soc.*, 1935, 57, 2115) drew attention to the fact that the majority of dyes could be regarded as resonance hybrids. Many organic compounds can exist in alternative states with regard to the distribution of valencies within the molecule. The simplest example is benzene as shown in (6) and (7).

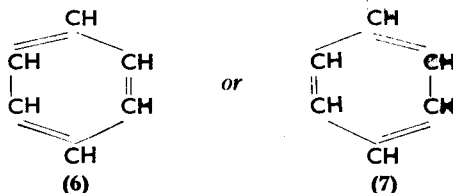

Whilst no difference can be detected between the chemical properties of the two forms, the physical characteristics indicate that benzene does not actually exist as (6) or (7) but as a resonance hybrid of the two, a condition described as a mesomeric state. The energy of the mesomeric state is less than that of either of the conventional formulae (6) or (7), the difference being known as the resonance energy.

Bury (*loc. cit.*) showed that the base of Malachite Green (8) is colourless because resonance is restricted to redistribution of valencies within the benzene rings (8) and (9):

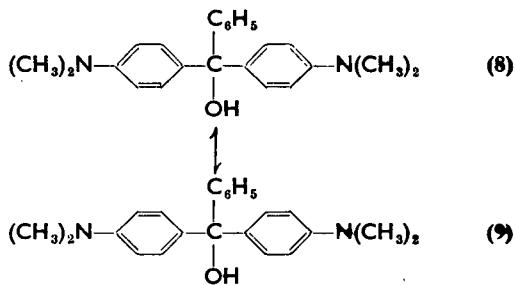

involving little change in structure. On acidification the free ion of the triphenyl methane dye is able to exist in two resonating forms involving greater electronic redistribution within the molecule, accompanied by the appearance of the characteristic colour of Malachite Green (10) and (11).

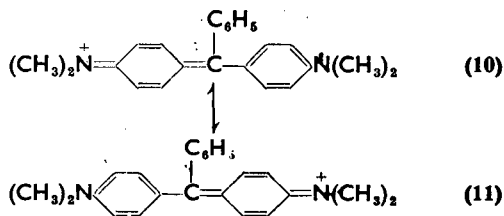

Another simple example of the connexion between resonance and colour is shown by the indicator methyl orange, and at the same time the mode of action of the azo group chromophore is demonstrated. In the presence of alkali it exists in the form (12),

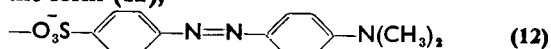

in which resonance is restricted to valency changes within the benzene rings. The addition of acid creates an excess of hydrogen ions converting the molecule to (13), which is highly coloured because resonance between (13) and (14) is possible, involving a more significant redistribution of valencies.

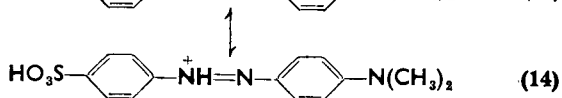
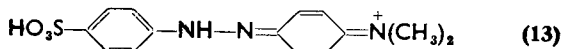

An exhaustive study of the relationship between resonance and colour was made by Booker *et al.* (*Rev. Mod. Phys.*, 1942, 275 *et seq.*). The basis from which they started was that a simple cyanine dye would be a resonance hybrid of (15) and (16)

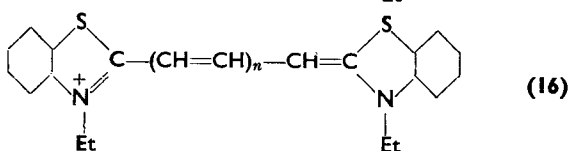
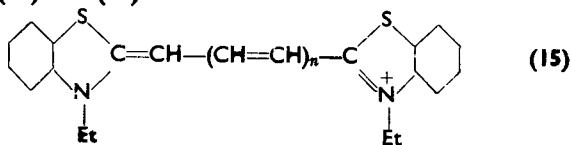

and because it is symmetrical with regard to the end groups, there is no preferential position for the positively charged nitrogen atom, and the charge can oscillate from one end to the other with the minimum of

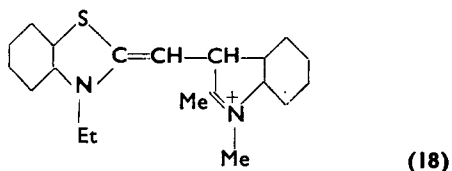
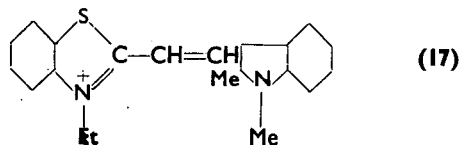

resistance. If however, one end group, such as the benzthiazole in (17) is more basic than the other, the former will have the greater attraction for the positive charge with the result that (17) is more stable than (18).

The effect of the unbalanced molecule is demonstrated by a study of the wavelengths (λ) at maximum absorption, as illustrated in Fig. 12.1. If

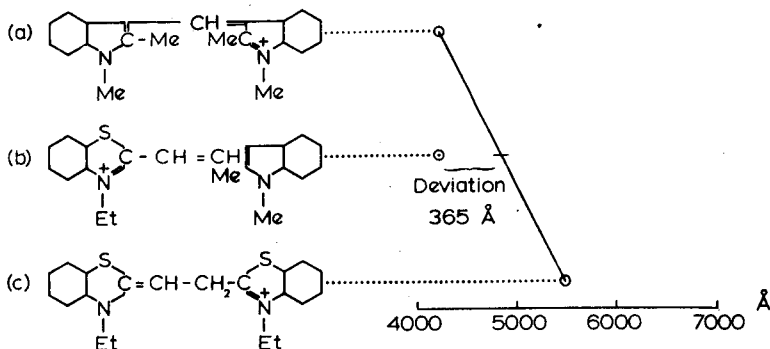
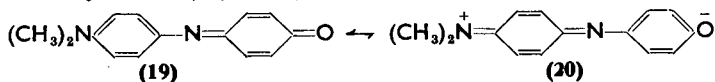

Fig. 12.1

the benzthiazole and indole rings were equally basic, it has been shown that λ_{\max} of the asymmetrical compound (b) should be half-way between those of the corresponding symmetrical dyes (a) and (c) in Fig. 12.1. In fact, however, on account of the lack of balance, more energy than represented by the mean is needed to bring about the resonance of the structures shown in (b) and consequently ΔE and the frequency are both greater, resulting in absorption at a wavelength of 365Å (36.5 nm) shorter than the calculated value.

A further interesting confirmation of these theoretical considerations was provided by the behaviour of Phenol Blue. The compound establishes a resonance hybrid of (19) and (20) in which (20) is a zwitterion, in other



words, an ion bearing both positive and negative charges. In this case the zwitterion is very much less stable than the unionized molecule because, as would be expected, the positive and negative charges in (20) would tend to neutralize each other by reversion to (19). An increase in the dielectric constant of the solvent would impede the freedom of movement of the charges and thereby lead to greater stability of the zwitterion. The result is that energy levels of the two resonating classical formulae become closer to each other. Experimental evidence has shown the anticipated relationship between bathochromic effect and progressive increase in the dielectric constant of the solvent. It is also possible to synthesize substances in which the

The small Greek letters are used to specify the nature of the orbital, and the subscript indicates the nature of the symmetry about a plane at right-angles to that of the molecule.

π electrons

The carbon atom, in its ground state, has two electrons in the $1s$, two in the $2s$, one in the $2p_x$ and one in the $2p_y$ orbitals (also expressed as

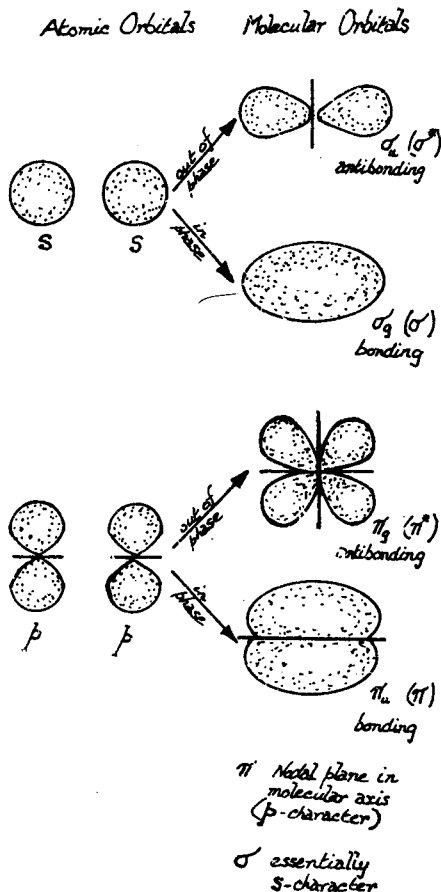

Fig. 12.2 Combination of simple atomic orbitals to form molecular orbitals (L.C.A.O.)

(Coates, *J.S.D.C.*, 1967, 83, 95)

$1s^2, 2s^2, 2p_x^1, 2p_y^1$, in which the superscripts represent the number of electrons in each orbital). This structure, however, has only two orbitals with single electrons, and molecules such as CF_2 and CH_2 have, in fact,

been recognized as extremely transitory components appearing during certain reactions. A very small amount of energy can convert the carbon atom from its ground to an alternative state by one of the $2s$ electrons becoming transferred to the p_z orbital giving $1s^2, 2s^1, 2p_x^1, 2p_y^1, 2p_z^1$.

There are now four orbitals with only one electron in each, giving the tetravalent form in which carbon normally reacts. These new orbitals although not all of the same type behave as if they were identical and are therefore called hybrid orbitals, see (C) in Fig. 12.3. Since they are formed by mixing one $2s$ and three $2p$ orbitals they are described as $2sp^3$ hybrids.

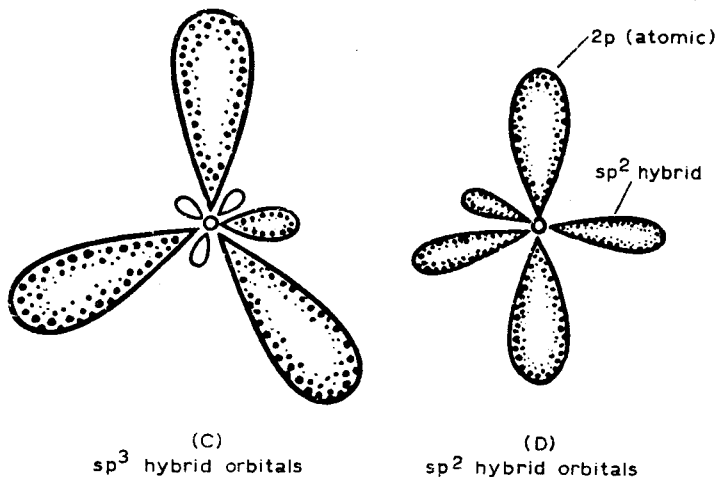
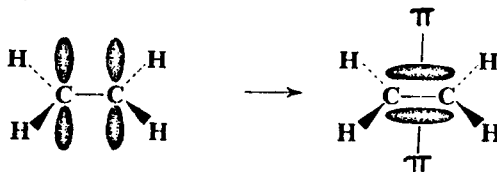

Fig. 12.3

In unsaturated compounds another type of hybridization makes its appearance, and is known as an sp^2 hybrid. In this case the carbon atom retains one p atomic orbital containing a single electron which lies above and below the plane of the three sp^2 hybrids, see (D) in Fig. 12.3. In ethylene, two sp^2 orbitals are combined with hydrogen and one in each carbon atom forms a mutual link. This leaves the molecule with two $2p$ orbitals which unite to form a π orbital (see Fig. 12.4).

Fig. 12.4 Formation of π orbitals

In a molecule containing a system of conjugated double bonds the π electrons form a cloud extending over the whole length of the chain of carbon atoms (see Fig. 12.5).



Fig. 12.5 Diagrammatic representation of π electrons in a conjugated system

Lengthening of the conjugated chains increases the number and decreases the energy gaps between the π orbitals. Therefore, the longer the $\text{CH}_2=\text{CH}=\text{CH}_2$ chain, the less energy will be required to excite the electrons and the longer will be the wavelength of the absorbed light, and the bluer the reflected colour. This is confirmed by many examples, and the behaviour of the carbocyanine dye (25) may be quoted:

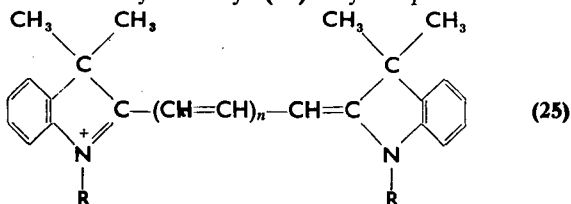

As n increases there is a clearly-defined shift of the light absorbed towards red, with a corresponding relative increase in the proportion of blue reflected. Thus:

When $n = 0$ the colour is yellow

When $n = 1$ the colour is red

When $n = 2$ the colour is blue

When $n = 3$ the colour is green

(Compare this with Table 12.1)

Hamer *et al.* (*Proc. Roy. Soc., London*, 1936, A154, 73, and 1937, A163, 138) have shown that when the value of n in compound (26) is increased

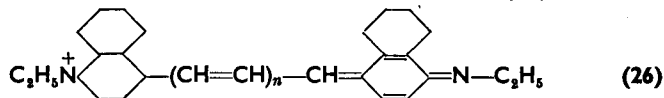

the decrease in the frequency of the radiation absorbed shows a linear correlation (Fig. 12.6).

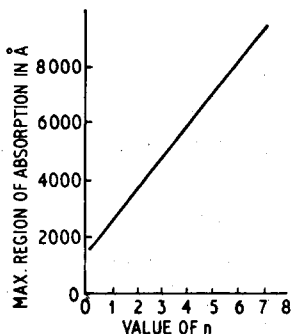

Fig. 12.6 Relationship between maximum absorption and number of $(\text{CH}=\text{CH})$ groups in formula (26)

(Courtesy of VENKATARAMAN, 'Chemistry of Synthetic Dyes')

The energy levels of the various π orbitals shown in Fig. 12.7 indicate how increasing the number of double bonds in polyolefines decreases the gap between the lowest permitted energy differentials.

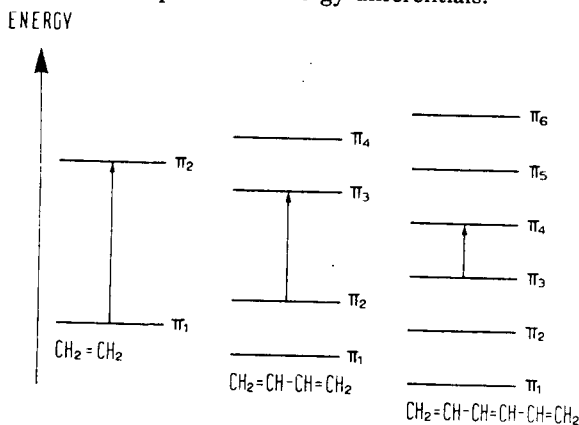

Fig. 12.7 Effect of conjugation on energy relationships
(Coates, *J.S.D.C.*, 1967, 83, 101)

In a conjugated unsaturated chain containing many carbon atoms it is believed that the π electrons behave as if they oscillate from one end of the chain to the other. Theoretical considerations lead to the conclusion that, if this is the case, the square of the wavelength should vary in a linear manner with the number of units in the polyolefinic chain. This relationship is referred to as the λ square rule and there is abundant experimental evidence confirming its validity. On the other hand, when there is resonance between two ionic end groups, as in the cyanines, λ_{max} should increase in direct proportion to the length of the chain which separates them and this, again, has been confirmed by observation as shown, for example, in Fig. 12.6.

Azo groups

The difference in colour between an azo derivative and its ethylenic analogue is normally small. The azo chromophore is particularly important because of the versatility of the coupling reaction and the ease with which it can be adapted to industrial processes.

The nitrogen atoms in the azo groups have pairs of electrons which undergo the $n \rightarrow \pi^*$ transition. If a carbon atom is replaced by a more electronegative nitrogen atom, the energies of all the π molecular orbitals are lowered. This has little effect upon the value of λ_{max} because the energies of both occupied and unoccupied molecular orbitals are lowered proportionally. The electron localized in the n orbit, however, has not had its energy altered and therefore ΔE for the $n \rightarrow \pi^*$ transition will be less, thus increasing absorption in the lower energy range, resulting in a bathochromic shift.

Bathochromic effect = Shift of absorbed light to longer wavelength
 Hypsochromic effect = Shift of absorbed light to shorter wavelength

Free electron model

When considering the relationship between colour and molecular structure of conjugated unsaturated systems a useful simplification can be made by assuming that all the electrons can move with perfect freedom in an imaginary box which has the length of the conjugated chain, and within which there is a field of uniform potential energy. This is illustrated diagrammatically in Fig. 12.8 in which the black spots represent a hypothetical conjugated system in which the carbon atoms are equally spaced. The potential energies of the electrons will vary proportionally as their distances from the positive nuclei. The imaginary box or well is indicated by the dotted lines.

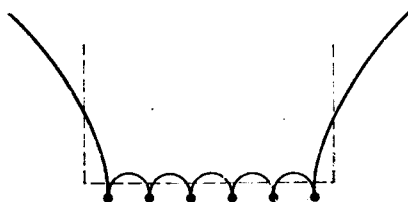

Fig. 12.8

The wave functions of the electrons may be looked upon as standing waves terminating at each end of the box and possessing $n-1$ nodes, as illustrated in Fig. 12.9. The energies of the wave functions are expressed in equation (A)

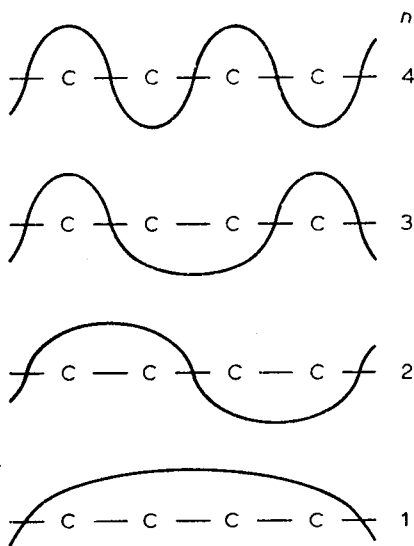

Fig. 12.9

$$E_n = n^2 \frac{h^2}{8mL^2} \quad (\mathbf{A})$$

in which:

E_n = energy level corresponding with n

L = the length of the box

n = a quantum number which must be an integer such as 1,2,3 or 4

m = the mass of the electron

h = Planck's constant.

In the ground state the orbitals with the lowest energy levels will be occupied, each accommodating two of the π electrons. If the number of π electrons is N , they will occupy $N/2$ energy levels and the lowest unoccupied level will be $N/2 + 1$. From equation (A) the difference in energy between the highest occupied and the lowest unoccupied levels will be:

$$\Delta_E = hv = (n_2 - n_1)^2 \frac{h^2}{8mL^2}$$

But $N + 1$ can be substituted for $(n_2 - n_1)^2$ thus:

$$\Delta_E = \frac{h^2}{8mL^2}(N + 1)$$

and $L = Nl$ when l is the known distance between atoms. Since each C atom contributes one π electron, therefore N = number of C atoms. Equation (A) then becomes

$$\Delta_E = \frac{h^2}{8m(Nl)^2}(N + 1)$$

and, since all the factors on the right-hand side of the equation are known, quantities Δ_E , and hence λ_{\max} , can be calculated, because

$$\Delta_E = hv = \frac{hc}{\lambda}$$

when c = velocity of light.

The effect of uniting two chromophore-containing groups within one molecule merits consideration because of the important part which it plays in dyestuff manufacture. When two molecular units containing chromophores are joined by saturated groups such as CH_2 or $-\text{CH}_2-\text{CH}_2-$, the linkage acts as an insulator, creating a barrier preventing transfer of electrons between the two resonating components. Thus, with regard to light absorption, each part acts separately. If the linked units are identical there is virtually no alteration of shade but only an increase in the intensity. Thus (27) and (28) absorb at 2630 and 2670 Å (263 and 267 nm) respectively,

but (27) has twice the intensity of (28) (PIPER AND BODE, *J.A.C.S.*, 1935, 57, 135):

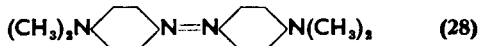
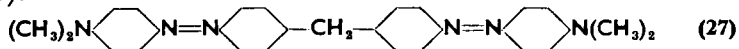

On the other hand, the identical chromophore-bearing units in (29):

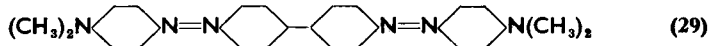

are united by an unsaturated structure forming an unbroken cloud of π electrons, and the absorption is governed by the oscillations of the molecule as a whole. In fact, (29) absorbs light of lower frequency than (27) or (28). These effects are much used in adding to the range of shades of classes of dyes. Green azo dyes, for instance, are often made by linking blue and yellow chromophore-containing units with an insulating bridge.

Molecular geometry has a significant influence upon colour because it appears that radiation can only be absorbed when it is in the same plane as the molecular orbital which is involved. Some simple substances containing highly-conjugated double bonds which will crystallize such as diphenyl octatetrene (30) have had their structures determined by X-ray

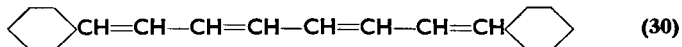

analysis. It is evident that the molecule lies essentially in one plane and, therefore, there can be only one direction for the orbit of the π electrons. The measurement of the amount of absorption when light polarized in different planes falls upon the crystals of this substance, shows that there is maximum absorption when the electric vector of the light is approximately along the axis of the molecule.

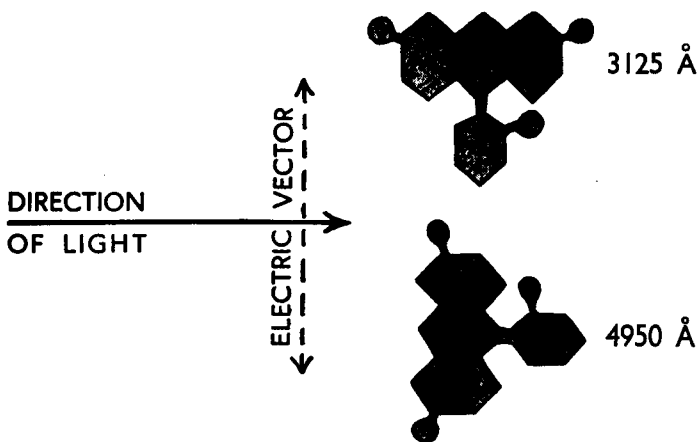
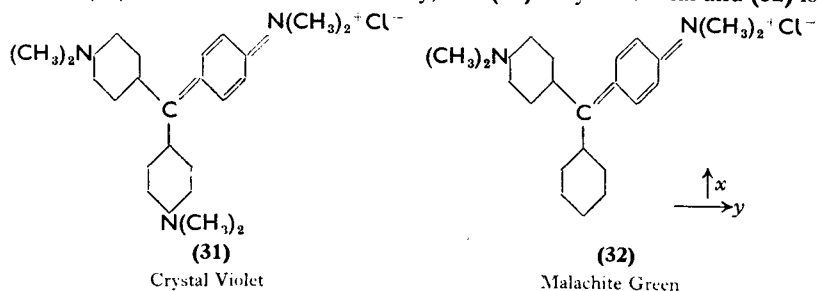

Fig. 12.10 Directional light absorption by the Uranin ion
(Courtesy of 'Fibre Science')

A simple example of the significance of molecular geometry in a dye is shown by Uranin, formerly known as Fluorescein (C.I. ACID YELLOW 73). Structural considerations lead to the conclusion that there will be two orbital planes corresponding with the positions shown in Fig. 12.10 (BOWEN, *T.I. Fibre Science*, 139). Light is absorbed at 4950 Å (495 nm) in the visible region and re-emitted as fluorescence at a slightly longer wavelength. It can be shown, with a polarimeter, that when the position of the molecule is fixed by attachment to the fibre, emission is on a vector parallel to that of the absorbed light. Absorption also takes place in the ultra-violet region at 3125 Å (312.5 nm), and this radiation is re-emitted on the same wavelength as that absorbed at 4950 Å (495 nm); in this case, however, not on a parallel vector but on one at right-angles to that of the absorbed ultra-violet radiation. There must, therefore, be absorption on two vectors at right-angles to each other. The ions of Crystal Violet (31) and Malachite Green (32) resemble each other closely, but (31) is symmetrical and (32) is



not. There is only one absorption band at 5900 Å (590 nm) for Crystal Violet, but two are displayed at 6250 Å and 4230 Å (625 nm and 423 nm)

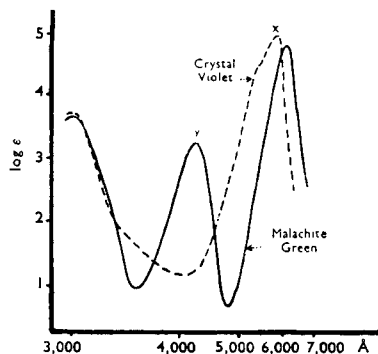

Fig. 12.11 Absorption curves for Malachite Green and Crystal Violet

in the case of Malachite Green (Fig. 12.11), corresponding with vectors in the directions x and y . Thus evidence of the significance of the molecule's geometry is not lacking.

Introduction to the theory of dyeing

The forces which anchor dyestuff molecules to textile fibres are complex and the study of them has attracted many investigators. The process consists of three stages which are:

1. Migration of the dye from the solution to the interface accompanied by adsorption on the surface of the fibre.
2. Diffusion of the dye from the surface towards the centre of the fibre.
3. The anchoring of the dye molecules by covalent or hydrogen bonds, or other forces of a physical nature.

The assembly of dye molecules at the fibre surface (stage 1) is governed, in the main, by three influences. Firstly electro-potential forces, secondly temperature, and thirdly agitation.

All textile fibres, when immersed in water or aqueous solutions, acquire an electric potential, often referred to as the zeta potential. Its direct measurement has been made by Neale and others (*Trans. Farad. Soc.*, 1946, **42**, 473, and 1946, **42**, 478). Cotton and cellulosic fibres bear a negative charge when immersed in neutral solutions, and the protein fibres are positively charged when the *pH* values of the aqueous phase are below the isoelectric point, and negatively charged when the *pH* is higher.

Most dyes, when in solution, are either in molecular and partially ionized state, or exist in the form of ionic micelles similar to those of soap, as described in Chapter 9. Increase of temperature tends to break down micelles into less aggregated units. In the case of the acid and the direct dyes the chromophore-containing ions bear negative charges. These will be repelled by the zeta potential of the cellulosic fibres, but attracted by protein fibres when the aqueous phase is acidic.

The covalent and hydrogen bond forces which anchor the dye to the fibre are of short range, of the order of 1 Å to 5 Å (0.1 to 0.5 nm). The electrostatic forces, however, have a range of about 100 Å (10 nm). Where there is mutual repulsion between the fibre and the dye ion, an extremely long time would be necessary before the inherent vibration of the molecules in the solution would have brought sufficient of them within the field of the short range forces for exhaustion to have proceeded to equilibrium. The problem, therefore, is to accelerate the migration to the surface of the fibre. This is achieved by increase of temperature which promotes vibrational activity, and also by the addition of electrolytes which counteract the effect of the negative zeta potential.

Protein fibres are usually dyed with acid dyes under conditions where there will be mutual attraction between the fibre and the dye ion. The problem, therefore, is to retard the sequence of events. The mechanism of dyeing protein fibres with acid dyes is extremely complex, but it is believed that faster moving anions from the added acid temporarily occupy the electro-positive sites in the fibre, and they are replaced at a retarded rate

by the dye anions which cannot travel so quickly. More detailed accounts of the practical application of these factors will be given in chapters 15 and 16.

The effect of agitation is only apparent when the amount of dye in the solution is limited. Under such conditions the diffusion into the fibre (stage 2) could be more rapid than the assembly at the surface, and agitation will then become a significant factor. This has been demonstrated by Alexander and Hudson (*Textile Research Journal*, 1950, 20, 481) and is shown in Fig. 12.12 in which curve I represents the effect of agitation on the rate of adsorption of C.I. Acid Orange 7 by wool from a solution containing 500 mg/l. In this case, owing to the high concentration, there is always an abundance of dyestuff molecules in the vicinity of the fibre and agitation has little effect upon the time of half-dyeing. Curve II, however, corresponds to a concentration of 125 mg/l and under such conditions there can be a dearth of dye molecules available at the surface of the fibre; agitation can then bring about a much greater decrease in the time of half-dyeing.

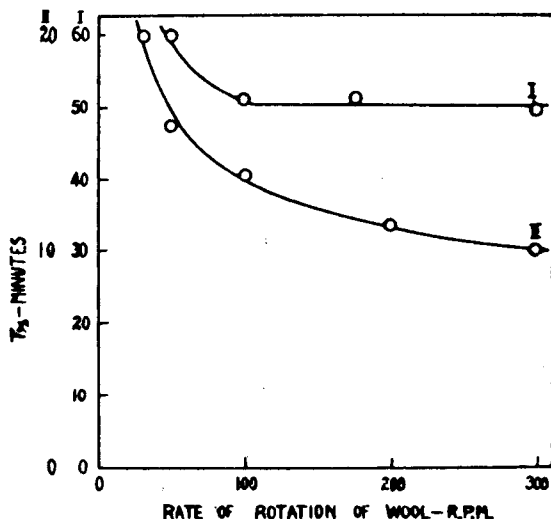

Fig. 12.12 Effect of stirring the wool on t_{50} at 25°C for dye concentrations of 500 mg/l (I) and 125 mg/l (II)

(*Textile Research Journal*, 1950, 20, 481)

The second part of stage 2 is the diffusion of the dye molecules towards the centre of the fibre and this is governed by Fick's law which is expressed by the equation

$$\frac{ds}{dt} = -D \frac{dc}{dx}$$

in which ds is the amount of solute diffusing across unit area during the time interval dt ; c is the concentration at a point x and D is the diffusion

coefficient, namely the amount of solute diffusing in unit time across unit area under unit concentration gradient. D is therefore a measure of the ability of the dye to diffuse and also of the permeability of the fibre. The smaller the dye molecule the more readily will it diffuse, and the more porous the fine structure of the fibre the easier will be the passage of the molecules of the dye. As a rough approximation, the size of azo dye molecules may be looked upon as being of the order of 15 to 30 Å (1.5 to 3 nm) in one plane and 10 to 15 Å (1 to 1.5 nm) in the other. The size of the pores in the fibres is not known with certainty but estimates in the wet state are from 30 to 100 Å (3 to 10 nm) in cotton, and of the order of 40 Å (4 nm) in wool under similar conditions. The rate of diffusion into the fibre is obviously dependent upon the concentration of dye molecules in the interfacial layer and, as explained above, this can under certain conditions be influenced by the degree of agitation.

With very few exceptions one or more of the following factors are responsible for the anchoring of the dye molecules to the fibre (stage 3):

- (a) Ionic (or salt) links,
- (b) Hydrogen bonds,
- (c) Covalent bonds,
- (d) Physical forces.

Ionic links. These only exist in the case of the protein fibres which are amphoteric substances. At their isoelectric point salt linkages exist between adjacent carboxyl and amino groups. The addition of further hydrogen ions causes neutralization of the negatively charged COO^- groups leaving net positive charges on the NH_3^+ groups. Practically all the dyes used for protein fibres are anionic and are therefore available to form an ionic link with the NH_3^+ groups.

Hydrogen bonds. The nature of hydrogen bonds has already been referred to in Chapter 2. Most dyes contain hydroxyl, amino, or azo groups, all of which are capable of forming hydrogen bonds with the hydroxyl groups of a cellulosic substrate. It was at one time thought that hydrogen-bond formation provided a full explanation of the nature of the affinity of the fibre for the dye. It is now believed, however, that this is an over-simplification and, whilst hydrogen bonds undoubtedly do play a part, there are many other factors which must be taken into account.

Covalent bonds. The covalent bond between carbon atoms in most organic compounds is very stable. It has been realized for a long time that great wet fastness would be obtained if dye molecules could be anchored to textile fibres by covalent bonds. During the last decade this has been achieved with the aid of certain reactive groups such as cyanuryl chloride, trichloropyrimidyl, sulphonethanolamide sulphuric acid ester, and vinyl sulphone.

Physical forces. Dyes with long paraffin chains or with a marked planar

configuration are very strongly retained by textile fibres. This cannot be explained by bond formation because there are not enough groups which could participate. Carbolan Crimson provides an illustration. When it has been adsorbed by the wool it is held with very great tenacity, giving excellent wet fastness, but this is not the case with Azogeranine, which has the same structure excepting that it does not possess a long paraffin chain.

There is also no lack of evidence that, in many cases, increasing molecular weight, without increase in groups capable of bonding, brings about greater adsorption at equilibrium and decreased rate of desorption.

Meggy (*J.S.D.C.*, 1950, **66**, 510) drew attention to the importance of non-polar or physical forces. He suggested that, although hydroxyl, amino, azo, and carbonyl groups might be responsible for attachment by hydrogen bonds to the fibre, this explanation is to a great extent discounted because the co-ordinating power of these groups is satisfied by chelation within the dye molecule as shown in (33) and (34):

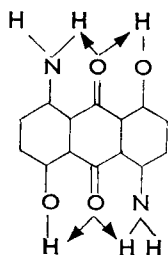

(33)

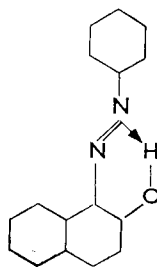

(34)

On the other hand, increasing the number of aromatic rings or unbranched aliphatic chains makes a much greater increase in affinity than does the introduction of additional potential bond-forming groups. The unbranched aliphatic chains, in particular, cannot form hydrogen bonds and cannot exert any great attraction attributable to physical forces. It was therefore suggested that another phenomenon, other than the four listed above, must be a significant factor.

The surface activity of the alkyl chain amphiphile is due to the attraction of the water molecules for each other, forcing the paraffin chains to the surface and then squeezing them out of the aqueous phase. Most dyes are composed of water-soluble groups attached to insoluble organic structures. The creation of a water-hydrocarbon interface requires the expenditure of energy to separate the water molecules by breaking down the hydrogen bonds. If, therefore, the dye molecules can be removed there will be a decrease in the free energy of the system. Thus the establishment of equilibrium will require the transfer of the dye to the fibre. These considerations do not exclude bond formation and the operation of other

forces but are suggested as an explanation of the mechanism governing the initial adsorption.

Thermodynamic considerations

Initially the free energy of the solution is greater than that of the fibre phase. This difference in free energy is the driving force which will bring about transfer of the dye to the fibre till a state of equilibrium is reached when the free energy in the liquid and solid phases are equal.

Since the establishment of equilibrium involves a decrease in the total free energy of the system, heat is given out during dyeing. In fact, therefore, the total amount of dye taken up at equilibrium is less at higher than at lower temperatures. The time required to obtain equilibrium, however, is very long at low but quite rapid at higher temperatures. In practice, therefore, some decrease in the theoretically possible degree of exhaustion must be accepted in the interest of economy in process time. This is well illustrated in the curves in Fig. 12.13, showing rate of dyeing isotherms with 5 per cent of Dispersol Fast Red R150 at 40, 50, 60, 70, and 95 degrees centigrade. It is apparent that to obtain adequate exhaustion within one hour, a temperature of at least 70°C is necessary.

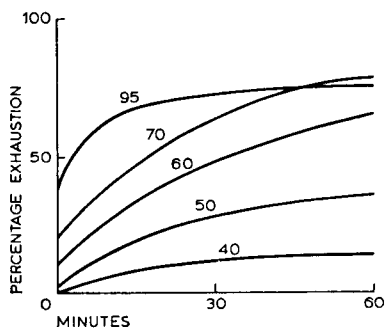

Fig. 12.13 Rate of dyeing isotherms for Dispersol Fast Red R on Nylon

(After VICKERSTAFF, 'Physical Chemistry of Dyeing', OLIVER AND BOYD)

The effect of temperature is to activate the molecular vibrations of the solute until it exceeds the critical energy necessary for it to make the journey from the solution to the fibre. The number of molecules which will be able to diffuse will be governed by their concentration in the solution and the exponential term $e^{-E/RT}$, in which E is the difference in energy between activated molecules and the remainder of those in solution, R is the gas constant and T is the absolute temperature. Hence the following equation is derived

$$D_t = D_0 e^{-E/RT}$$

where D_t is the observed diffusion coefficient at the temperature t and D_0 is a constant.

The introduction of logarithms into the above equation gives

$$\ln D_t = \ln D_0 - \frac{E}{RT}$$

or to convert from natural logarithms to \log_{10}

$$\ln D_t = \text{Log } D_0 - \frac{2.3E}{RT}$$

From this it can be concluded that if the log of the diffusion coefficient at different temperatures is plotted against the reciprocal of the absolute temperature, the points should lie on a straight line. This has, in fact, been confirmed by Garvie, Griffiths, and Neale, and from the slope of the line it is possible to calculate the activation energy.

Thermal activation is only the first stage in the dyeing process. From the foregoing observations it is clear that the driving force in the transfer of the dye from the solution to the fibre is the difference in free energy between the two phases. This is more conveniently expressed in the form of the chemical potential μ which is defined as the change of free energy per g mol when a very small quantity of dye is added to the solution, all other variables being kept constant. The determination of μ as defined above is not easy so chemical potentials are expressed by reference to the standard potential μ^0 . The standard potential is derived from the basic equation, applicable to an ideal solution, namely:

$$\mu = A + RT \ln C$$

where A is a constant which is a function of temperature and pressure, but is independent of the composition of the solute. R is the gas constant, T is the absolute temperature and C is the molar concentration of the solute. Because a dissolved dye will not correspond, on account of molecular aggregation and other factors, with an ideal solution, the factor f must be introduced so that

$$\mu = A + RT \ln [D]f$$

in which f is the factor needed to correct departure from an ideal solution and $[D]$ is the dyestuff concentration. At infinite dilution the behaviour will be that of an ideal solution, so that when $D = 0$ the value of f will be 1. If $[D]f$, for the sake of simplicity, is replaced by the activity a of the dye, then

$$\mu = A + RT \ln a \quad (\text{A})$$

This equation, however, is not much practical help, mainly on account of the difficulty in determining A . For this reason the concept of the standard chemical potential (designated μ^0) is introduced and is used as a basis against which changes in μ can be measured. This does not make it

possible to arrive at an absolute value of μ , but provides a method by which relative chemical potentials of different dye systems can be compared, and the effect of alterations in the conditions can be measured.

If a^0 represents the activity of the dye in the standard state, then equation (A) becomes

$$\mu^0 = A + RT \ln a^0 \quad (\text{B})$$

and after subtracting (B) from (A) the result is:

$$\begin{aligned} \mu - \mu^0 &= RT \ln a - RT \ln a^0 \\ \text{or} \quad \mu &= \mu^0 + RT \ln a/a^0 \end{aligned} \quad (\text{C})$$

The definition of the standard state, however, is the chemical potential at the specified temperature, at infinite dilution, when the value of a^0 becomes 1 and this makes it possible to rewrite equation (C) in the following form:

$$\mu = \mu^0 + RT \ln a \quad (\text{D})$$

There are only a few instances where the activity of a substance can be measured by direct means, but when this has been possible it has been shown that in dilute solutions as an approximation $a = [D]$ when $[D]$ is the molarity (gramme molecules per litre) or, in the case of the fibre, moles of dye per kg. It is therefore permissible to substitute $[D]$, an easily determined quantity, for a so that (D) becomes

$$\mu = \mu^0 + RT \ln [D]$$

What is of importance in the definition of the behaviour of a dye is the difference in chemical potential between the fibre and the solution phases, or in other words, a measure of the driving force governing the transfer of the dye molecules to the fibre. If μ_s and μ_s^0 represent the chemical potentials of the dye in the solution and μ_f and μ_f^0 of those in the fibre phase, then:

$$\begin{aligned} \mu_s &= \mu_s^0 + RT \ln [D]_s \\ \mu_f &= \mu_f^0 + RT \ln [D]_f \end{aligned}$$

But at equilibrium $\mu_s = \mu_f$ and, signifying the difference in standard potential between the two phases by $\Delta\mu^0$, it follows that:

$$-(\mu_f^0 - \mu_s^0) = -\Delta\mu^0 = RT \ln [D]_f - RT \ln [D]_s$$

or, in a simpler form:

$$-\Delta\mu^0 = RT \ln \frac{[D]_f}{[D]_s}$$

and all the terms on the right hand side of the equation are known or are ascertainable.

It will be noticed that $\Delta\mu^0$ is in the negative. When conditions favour transfer of the dye from solution to fibre there is a decrease in the chemical potential between the two phases. By convention it is considered preferable

to express $\Delta\mu^0$ as positive when dyeing actually occurs, and negative when desorption takes place, and this is achieved by prefixing $\Delta\mu^0$ with a negative sign.

Heat of dyeing

The heat of dyeing is a measure of the strength of the bonds by which the dye is held to the fibre. Since the transfer of dye from the solution to the fibre involves a decrease in the free energy of the system, heat is given out and the heat of dyeing, therefore, is a negative quantity. The converse is, of course, also true, namely that the migration of dye from the fibre to the liquid phase is accompanied by absorption of heat. Thus an increase of temperature favours desorption and consequently decreases the concentration of the dye molecules in the fibre at equilibrium. It is extremely difficult to make a direct calorimetric measurement of the heat of dyeing because the thermal changes are so small. Nevertheless Derbyshire (*Hexagon Digest* No. 21) describes a technique by which it is possible to do this.

The heat of dyeing is ΔH^0 and can be calculated if $\Delta\mu_1^0$ and $\Delta\mu_2^0$ at the two temperatures T_1 and T_2 are known from the equation

$$\Delta H^0 = \left(\frac{\Delta\mu_1^0}{T_1} - \frac{\Delta\mu_2^0}{T_2} \right) / \left(\frac{1}{T_1} - \frac{1}{T_2} \right)$$

The determination of μ^0 is not easy because of the difficulty of precise expression of the concentration of the dye in the fibre. If therefore this is expressed as $fn[D]_f$ when fn = an unknown function then:

$$-\Delta\mu^0 = RT \ln \frac{fn[D]_f}{[D]_s}$$

and it follows that:

$$\Delta H^0 = \frac{R(T' - T)}{T \cdot T'} \ln \frac{fn[D]_f \cdot [D]_s'}{fn[D]_f' \cdot [D]_s}$$

If the conditions are adjusted so that the concentration of the dye in the fibre is the same at both temperatures $\frac{[D]_f'}{[D]_f}$ becomes unity, and

$$\Delta H^0 = \frac{R(T' - T)}{T \cdot T'} \ln \frac{[D]_s'}{[D]_s}$$

D_s and D_s' are ascertained with ease and all the other factors are known.

Adsorption isotherms

There is much useful information to be gained from adsorption isotherms. These are the curves obtained by plotting the dye adsorbed by the

fibre against the concentration of the dye in the liquor at constant temperature. The curves fall, essentially, into three categories, each characteristic of a different phenomenon which may be involved in dyeing.

The simplest is the partition of a solute between two immiscible solvents. In this case $[D]_f/[D]_s = K$, where K is the partition coefficient. This equilibrium is often referred to as the Nernst distribution. When $[D]_f$ is plotted against $[D]_s$ at constant temperature the curve is a straight line which terminates at the point when both the fibre and the dye bath are saturated. There are slight deviations from the linearity of the curve, particularly as the solutions become more concentrated. This system is probably exhibited in its ideal form when dyeing cellulose acetate rayon from an alcoholic dye solution, but it is also essentially true in the case of the application of disperse dyes in aqueous suspension to cellulose acetate, because the dyes are all soluble in water to a very limited extent and the undissolved particles act as a reservoir to maintain the concentration of the solution. The curve for this isotherm is shown in Fig. 12.14.

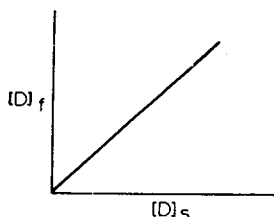

Fig. 12.14 Nernst Isotherm

A second type of isotherm is obtained where there are a definite number of sites within the fibre which can enter into combination with the dye, Na_2D , the state of affairs which exists with the protein fibres. If it is assumed that the cations present in solution are independently adsorbed by the carboxyl groups, and the anions by the amino groups, then

$$-\Delta\mu^0 = RT \ln \left[\frac{\theta_D}{1-\theta_D} \right] \left[\frac{\theta_{Na}}{1-\theta_{Na}} \right]^z - RT \ln [Na]_s^z [D]_s$$

when, in this case, Na is the cation. If, however, it is assumed that the fibre contains an equal number of positive and negative sites, and the dye is derived from a monobasic acid, the equation becomes

$$-\Delta\mu^0 = 2RT \ln \left[\frac{\theta}{1-\theta} \right] - 2RT \ln [D]_s$$

where θ is the fraction of sites in the fibre which are occupied. In this case when $[D]_s$ is plotted against $[D]_f$, the curve becomes parallel with the $[D]_s$ axis when all the sites are occupied, as shown in Fig. 12.15. This is known as the Langmuir equilibrium.

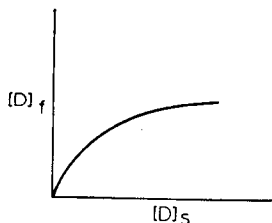

Fig. 12.15 Langmuir equilibrium

Thirdly there is the Freundlich equilibrium applicable to the adsorption of direct and vat dyes by cellulosic fibres. In this case the attachment is not at specific sites so that there is no stoichiometric limiting factor. If attachment is brought about by hydrogen bonds and physical forces the limitation is the available surface within the pores. In this case, therefore, adsorption is rapid at first because the sites are easily accessible but becomes slower as the dye molecules have to seek out the more remote points of attachment. The $[D]_f/[D]_s$ curve, therefore, is not a straight line nor does it reach a point at which it becomes parallel with the horizontal axis, as shown in Fig. 12.16.

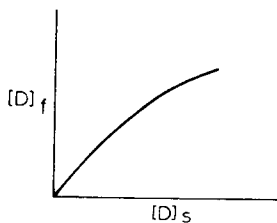

Fig. 12.16 Freundlich isotherm

Kinetics of dye adsorption

The thermodynamic considerations deal with the end results of the chemical potential after equilibrium has been established. To the practical dyer it is much more important to have information about the rate at which equilibrium is being established under different conditions. Rate-of-dyeing graphs are prepared by plotting the amount of dye adsorbed on one co-ordinate, and time on the other. If the observations are carried to complete exhaustion the curve is asymptotic and the end point is approached so gradually that its accurate determination is extremely difficult. For this reason the time of half dyeing ($t_{\frac{1}{2}}$) is used because, at this point, the slope of the curve is comparatively steep and the time can be ascertained with accuracy.

In order to obtain $t_{\frac{1}{2}}$, exhaustion at equilibrium must first be determined. This can be done by allowing the dyeing at the prescribed temperature to proceed for a very long time (overnight) or, alternatively, by plotting a

rate-of-dyeing curve and observing the point at which it becomes virtually parallel with the time axis (Fig. 12.17).

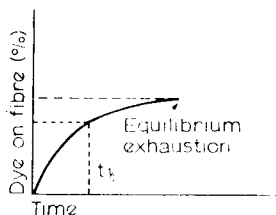

Fig. 12.17

Boulton and Reading (*J.S.D.C.*, 1934, 50, 385) recommend that the time should be plotted as log seconds, because the curve makes an asymptotic approach to both zero and equilibrium exhaustions with the result that the portion which is significant for ascertaining t_1 is straight and easy to interpret (Fig. 12.18).

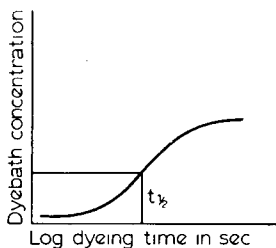

Fig. 12.18

Boulton and Reading propose that, in order that the factor t_1 should bear a greater relationship to practical dyeing, an amount of electrolyte should be added for each dye which would be sufficient to bring about an equilibrium exhaustion in a 40:1 liquor ratio of 50 per cent of the dye in the solution. Colorimetric assessments are easier at 50 per cent exhaustion than in the higher regions of over 80 per cent where residual impurities in the dye have a disproportionate effect upon the colour. The time of half dyeing, therefore, is the point at which 25 per cent of the total dye originally present has been adsorbed. A distinction must be made between the *strike*, which is the adsorption of the dye molecules on the surface of the fibre, and can in many cases be extremely rapid, and the actual diffusion from the surface to within the fibre. The factor which plays the greatest part in determining dyeing properties is the second and this can be masked by the rapidity of the strike. In order to avoid this the dye bath concentrations should be such that the attraction of the fibre and the final exhaustion are not very high. This is an important reason for adjusting the liquor so that, at equilibrium, exhaustion is when 50 per cent of the dye has been adsorbed.

Half-time of dyeing gives valuable information about dyeing properties

in practice. If equilibrium is achieved in a comparatively short time, the distribution will be even throughout the batch within the normal process time. When, however, equilibrium is only reached very slowly it is doubtful whether, under commercial conditions, it will be practical to allow sufficient time in the dyebath. Valuable information is also provided about the selection of dyes when more than one is necessary in order to produce the required shade. Obviously it is desirable, as far as is possible, to choose those with about the same half-dyeing time.

Classification of dyes

Dyes are classified according to their chemical constitution, or on the basis of their dyeing properties. There is little correlation between the two methods. Thus members of the great group classified constitutionally as azo dyes are found amongst several of the classes based on application.

The practical dyer is primarily interested in classification according to application. The constitutional groups will therefore only be classified briefly (see *Colour Index*, Vol. 3).

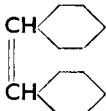
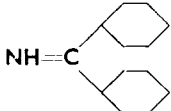
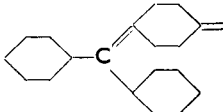
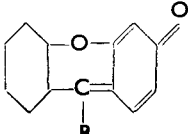
<i>Group</i>	<i>Typical structural unit</i>
Nitroso	$\text{R.NOH} \rightleftharpoons \text{R} \begin{array}{l} \text{N.OH} \\ \text{//} \\ \text{O} \end{array}$
Nitro	R.NO_2
Monazo	$\text{R.N=N.R}'$
Disazo	$\text{R.N=N.R}'\text{.N=N.R}''$
Trisazo	$\text{R.N=N.R}'\text{.N=N.R}''\text{.N=N.R}'''$
Polyazo	$\text{R.N=N.R}'\text{.N=N.R}''\text{.N=N.R}'''\text{.N=N.R}''''$
Stilbene	
Diphenyl methane	
Triaryl methane	
Xanthene	

Group

Typical structural unit

Acridine

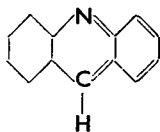

Quinoline

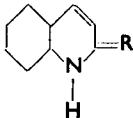

Methine

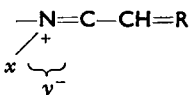

Thiazole

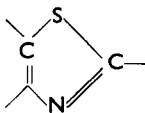

Indamine

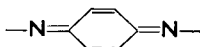

Indophenol

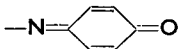

Azine

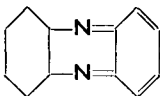

Oxazine

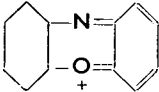

Thiazine

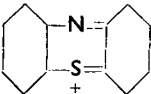

Sulphur

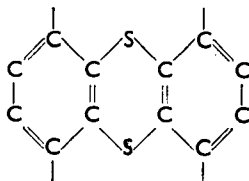
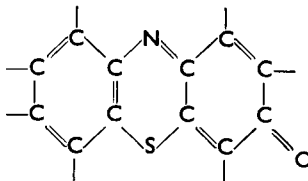
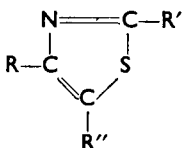

Lactone

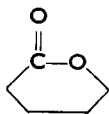

Aminoquinones
(usually)

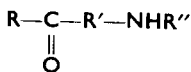
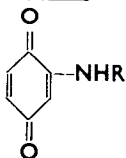

Hydroxyketone
(usually)

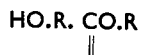
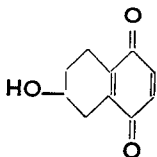

Indigoid

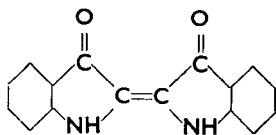

Anthraquinone

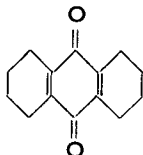

Phthalocyanine

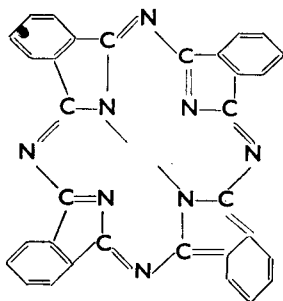

Chloro- and Di-
chloro-Triazinyl

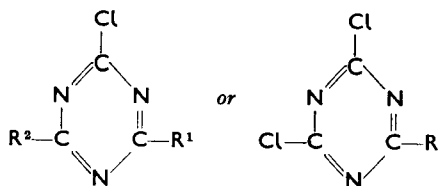

Remazol

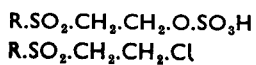

CLASSIFICATION ACCORDING TO APPLICATION

Basic dyes

These are usually hydrochlorides or salts of organic bases. The chromophore is found in the cation and they are therefore sometimes called the cationic dyes.

Acid dyes

These are sodium salts, usually of sulphonic acids, but in a few cases, carboxylic acids. Most of them have no affinity for cellulosic fibres although there are exceptions. They are used mainly for protein and polyamide fibres.

Direct dyes

They resemble acid dyes in being sodium salts of sulphonic acids and are almost invariably azo compounds. They have a direct affinity for cellulosic fibres. Direct dyes are also frequently referred to as substantive dyes. Although they will dye protein fibres they are not used for this purpose except in special circumstances. The distinction between acid and direct dyes is often ill defined. C.I. DIRECT RED 37, for example, may be applied as a direct dye to cellulose or as an acid dye to protein fibres.

Mordant dyes

The group includes many natural and synthetic dyes, the latter usually being obtained from anthracene. They have no natural affinity for textiles but are applied to cellulosic or protein fibres which have been mordanted previously with a metallic oxide. The acid mordant dyes are a special class of dyes applied to wool or polyamide fibres as if they were acid dyes, and then given very high wet-fastness by subsequent mordanting.

Sulphur dyes

The members of this group are complex organic compounds containing sulphur. They are used to dye cheap shades of high wet-fastness on cellulosic fibres. The colours, however, lack brightness.

Azoic dyes

These are insoluble pigments built up within the fibre by padding with a soluble coupling component and then treating with a diazotized base. They are used for dyeing colours on cellulosic fibres when comparatively good wet-fastness combined with brightness of shade is required at a reasonable cost. Although they have been applied to protein fibres it is doubtful whether they are really suitable.

Vat dyes

These are insoluble in water but can be converted into soluble leuco compounds by the action of sodium hydroxide and a reducing agent such as

sodium hydrosulphite. Cellulose has an affinity for these leuco compounds which, when absorbed by the fibre, are subsequently oxidized to the insoluble pigment. They possess extremely good fastness but are expensive.

Disperse dyes

Hydrophobic fibres, such as secondary or tertiary cellulose acetate, and the synthetic fibres will often dye better with insoluble dyes than those which are dissolved in water. The disperse dyes are suspensions of finely-divided organic compounds with very slight aqueous solubility.

Reactive dyes

This class has appeared more recently. The dyes can enter into chemical combination with cellulose and, therefore, give excellent wet-fastness. They are, in many cases, dyed from a cold liquor and adapt themselves well to the requirements of continuous dyeing.

Fastness classifications

In the chapters which follow, dealing with the properties and application of dyes, there will be frequent reference to fastness. Dyes are rarely equally fast to all influences and it is not uncommon for a dyestuff to be of good fastness in one respect, such as washing, but to leave much to be desired, for example, with regard to light. Fastnesses are expressed in terms of numerical scales. For all properties other than light the 1-5 scale is used, the numbers corresponding with the following graduations:

Alteration of shade during prescribed test

- Grade 5 Shade unaltered;
- Grade 4 Very slight loss in depth or alteration;
- Grade 3 Appreciable loss or alteration;
- Grade 2 Distinct loss or alteration;
- Grade 1 Great loss or much altered.

Staining of adjacent materials

- Grade 5 No staining of adjacent white;
- Grade 4 Very slight staining of adjacent white;
- Grade 3 Appreciable staining of adjacent white;
- Grade 2 Deep staining of adjacent white;
- Grade 1 Adjacent white dyed deeply.

Light-fastness

- Grade 8 Maximum fastness;
- Grade 7 Excellent fastness;
- Grade 6 Very good fastness;
- Grade 5 Good fastness;
- Grade 4 Fair fastness;

Grade 3 Moderate fastness;

Grade 2 Slight fastness;

Grade 1 Poor fastness.

These tables will assist in understanding references to fastness properties which will appear in the following text, but a detailed description of the methods of testing will be given in Chapter 25.

13 · Dyeing machines

THE basic requirements of a dyeing machine may be summarized into the following essentials:

- (i) That it shall provide sufficient movement for the liquor to penetrate uniformly into every part of the goods.
- (ii) Although the movement must be sufficient to bring about penetration it must not be so vigorous that it will damage finer materials or cause milling of woollen goods.
- (iii) The machine must be constructed of a material which will withstand prolonged boiling with acid or alkaline solutions.
- (iv) The heating arrangements must be such that a comparatively uniform temperature will be maintained throughout the liquor.
- (v) There should be some means of adding the concentrated dyestuff solution in such a way that it becomes well diluted before it comes into contact with the goods.
- (vi) All moving parts and electric motors should be protected against the corrosive action of steam and acidic atmospheric conditions.

Other features which are desirable, if not absolutely essential, are:

- (a) The largest possible outlet and water-inlet valves, because a considerable proportion of the dyeing cycle is taken up with filling and emptying, especially when several rinses are required.
- (b) A closed steam coil through which cold water can also be circulated. This makes it possible to dye without alteration of liquor ratio due to condensation of steam. It also allows the liquor to be cooled before the addition of dyes for shading, encouraging, in many cases, the use of faster colours for final matching.
- (c) Some automatic temperature-control device, preferably designed to regulate the rate at which the liquor is brought to the boil or to any other predetermined maximum temperature.

Clouds of steam rising from a number of open vessels in a confined space can create a very moisture-laden atmosphere. For this reason, as well as for others, totally enclosed dyeing machines are preferable. The contribution which they make towards a cleaner atmosphere leads to less corrosion of the structure and fittings in the dyehouse, with a consequent decrease in the risk of stains. Protection of the goods and liquor against exposure to the atmosphere during dyeing conserves heat, and therefore leads to a saving in steam consumption.

Uniform penetration and level dyeing depend upon both mechanical and chemical factors. It is, of course, vitally important that there should be adequate movement of goods and liquor in relation to each other. It must never be forgotten, however, that the perfect machine will not give level dyeing unless the proper precautions are taken with regard to the addition of chemicals and control of temperature. In the present context only the mechanical aspects of level dyeing will be dealt with. Agitation is obtained either by moving the goods through the liquor, or by forcing the liquor through the material, or by a combination of both. It must be borne in mind that forcing liquor through static goods causes virtually no milling of wool.

Materials used in construction

At one time all dyeing machines were made of wood, a material which was open to objection, because the acids and dyes absorbed in its pores were liable to come out in succeeding dyeings and upset recipes. Although practically all machines are now made of stainless steel, wood, on account of its cheapness, is still not without advantages for certain purposes such as bleaching, or as a standing bath for blacks or any other shade in such frequent demand that a machine can be reserved for it permanently.

Normal chemical-resistant stainless steel, often referred to as 18/8, contains considerable quantities of chromium and nickel and has the following composition:

Carbon,	not more than	0.15 per cent
Chromium,	„ „ „	18.0 per cent
Nickel,	„ „ „	8.0 per cent
Tungsten,	„ „ „	0.5 to 1.0 per cent

but improved resistance to acids is obtained by incorporating 2.5 to 4.0 per cent of molybdenum, and stainless steel of the following composition is now generally used for dyeing machinery:

Carbon,	not more than	0.07 per cent
Chromium,	„ „ „	18.0 per cent
Nickel,	„ „ „	8.0 per cent
Molybdenum,	„ „ „	2.5 to 4.0 per cent

Although more expensive than stainless steel, titanium possesses even greater resistance to chemical attack, especially to oxidizing agents such as chlorine dioxide, and it is coming into use for special purposes. At present it finds its greatest application in plant for bleaching with hypochlorite or sodium chlorite, and for making impeller pumps for handling particularly corrosive chemicals.

Machines for dyeing loose stock and tops

Loose stock consists of wool or cotton fibres still in the randomized state in which they are after sorting or baling. In the case of man-made staple fibre the corresponding state is tow. A commonly-used machine is the

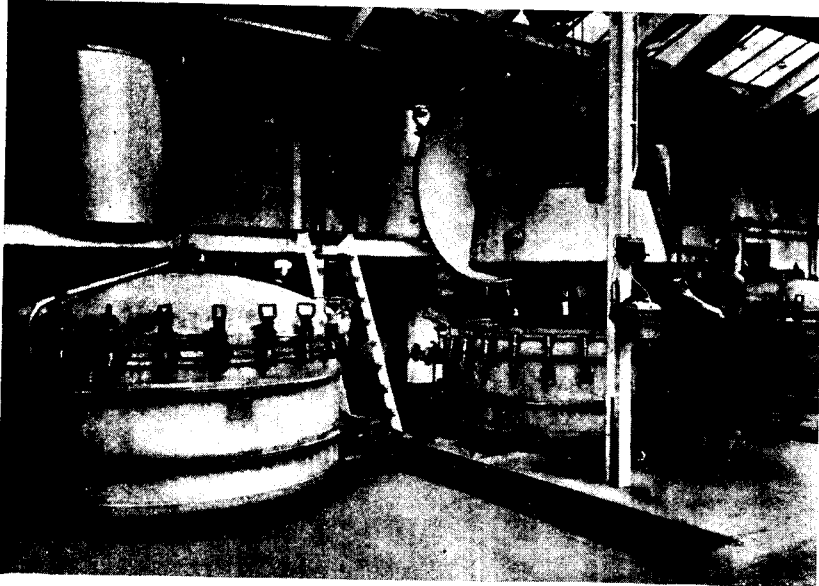

Fig. 13.1(a) Conical pan loose stock dyeing machine

(Courtesy of Longclose)

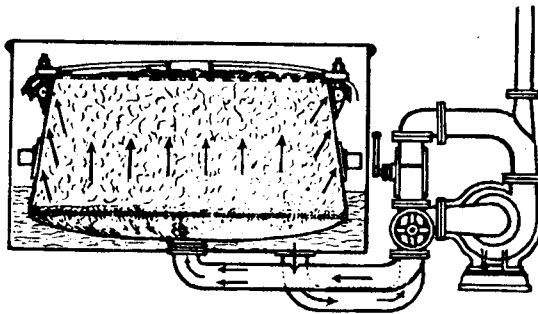

Fig. 13.1(b) Flow diagram for conical pan machine

conical pan with forced circulation (see Fig. 13.1). The loose stock is packed into the container in which it is retained by a lid which can be held down with a number of screw-threaded clamps. A flange at the bottom of the container fits into a seating through which the dye liquor is circulated by a centrifugal pump, and the direction of flow can be altered by a two-way

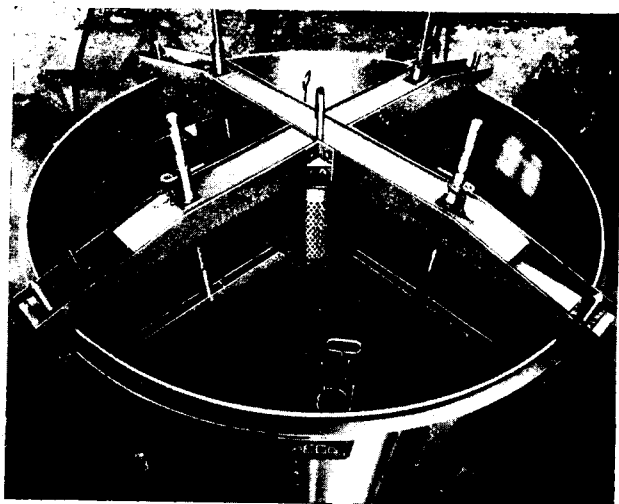

Fig. 13.2 Loose stock dyeing machine
(Courtesy of Samuel Pegg)

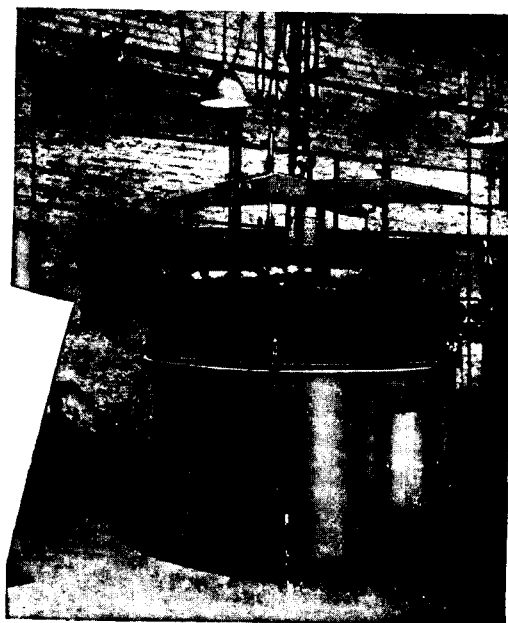

Fig. 13.3 Loose stock dyeing machine
(Courtesy of Samuel Pegg)

valve. The sides of the container slope inwards so that, as the flow of the liquor pushes the mass upwards, it becomes more compressed and automatically closes up channels of least resistance to the passage of the liquor. A gantry and travelling hoist are necessary to lift the container in and out. An alternative method of handling loose stock is used in the Pegg machine illustrated in Fig. 13.2 and 13.3. The machine consists of an outer vat in which a steam pipe for heating is situated, and which also has built into it twin propellers attached to a common shaft. The loose stock is held between a perforated false bottom and a similar top which can, by means of clamping screws, compress the load into a tight mass. The top, false bottom and perforated central tube lift out as one unit for unloading, and a stainless-steel lid is provided to make the system totally enclosed. The design makes it possible to use a short liquor ratio with associated economy in use of steam, water, and chemicals, and the direction of the flow can be reversed at intervals to assist in uniform penetration of the dye liquor. A similar method of handling loose stock can be adapted to high-pressure machines when application of the dye at temperatures above 100°C has advantages. Loose stock may also be packed into an annular cage and compressed into a mass of uniform density by a bonnet, which can be screwed down onto the load (see Fig. 13.4). Such cages fit into all types of pressure machines designed for dyeing yarn in package form.

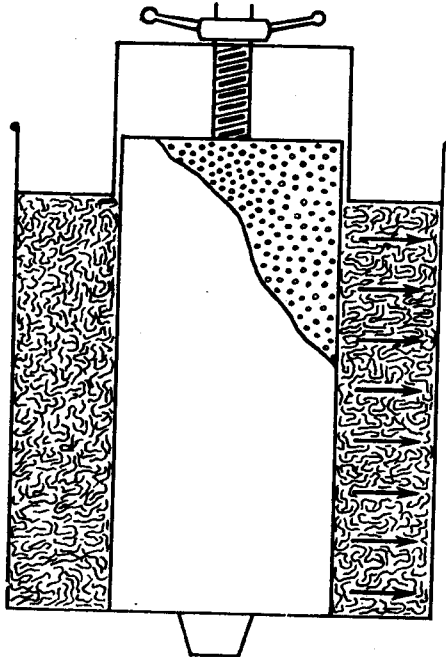

Fig. 13.4 Annular cage for dyeing loose stock

The continuous dyeing of rayon staple with reactive or direct dyes is described by Cheetham (*J.S.D.C.*, 1960, 76, 95). The essential features of one possible system are illustrated diagrammatically in Fig. 13.5. The staple

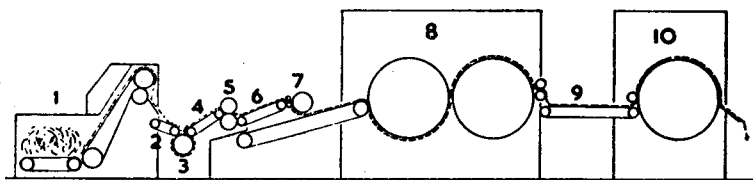

Fig. 13.5 Diagram of plant for continuous dyeing of rayon staple
(Fleissner system)

is fed into a hopper at (1), conveyed by a belt (2) to the unit (3), where it is dyed. The Fleissner dyeing machine (see Fig. 13.6) consists of a tank in which a large-diameter drum, covered with a fine mesh, rotates. A pump

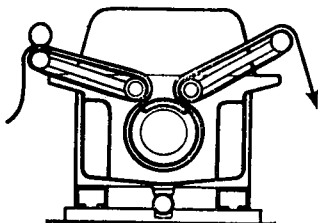

Fig. 13.6 Fleissner dyeing unit (3)
in Figure 13.5

withdraws the liquor from the inside of the drum and discharges it into the dye-tank. This action not only sucks the liquor through the staple but also ensures that the latter adheres closely to the circumference of the drum during its passage through the dyeing unit. The lap of tow is then carried on a conveyor belt (4), to a squeeze roller (5), is opened at (7), and dried over rotating drums (8), employing a principle similar to the dye-

ing unit, the hot air being sucked from the inside of the mesh-covered drum so that the material adheres to the surface. Finally the lap passes over a cylinder (10), through which a current of cold air is sucked.

Sliver is presented to the dyer as 'slubbing' when it has been wound into hanks and is dyed in the hank dyeing machines, to be described later, or it is wound into 'tops' which are loose balls about 1 ft in diameter. A top-dyeing machine (Longclose) is illustrated in Fig. 13.7*a*. The tops are packed into the perforated cans (Fig. 13.7*b*) and the lids are fixed in position. The bottoms of the cans rest on a seating through which the dye liquor can be forced upwards by the centrifugal pump at the side of the machine, or in the reverse direction by altering the flow.

Hank-dyeing machinery

The traditional machine is the Hussong, illustrated in its simplest form in Fig. 13.8. It consists essentially of a frame carrying poles on which the hanks are hung and which can, when loaded, be lowered by a hoist on a gantry, into the rectangular vessel containing the dye liquor. The liquor is circulated by means of an impeller, separated from the yarn by a division



Fig. 13.7(a) High-temperature machine for dyeing tops
(Courtesy of Longclose)

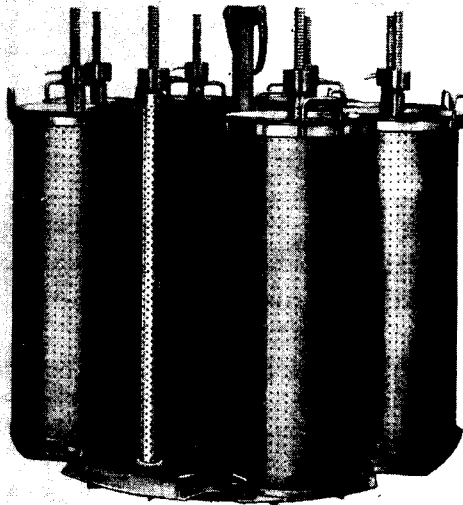

Fig. 13.7(b) Cans for dyeing tops
(Courtesy of Longclose)

with a grid below the false bottom. The holes in the perforated false bottom are so arranged that there are more at the end remote from the impeller than adjacent to it, in order to distribute the flow uniformly. The false bottom also serves to separate the steam pipe from the load. The impeller rotates in opposite directions alternately so that the circulation is either from below the false bottom upwards, and back into the impeller compartment over the top, or in the reverse way. The packing of the yarn on the

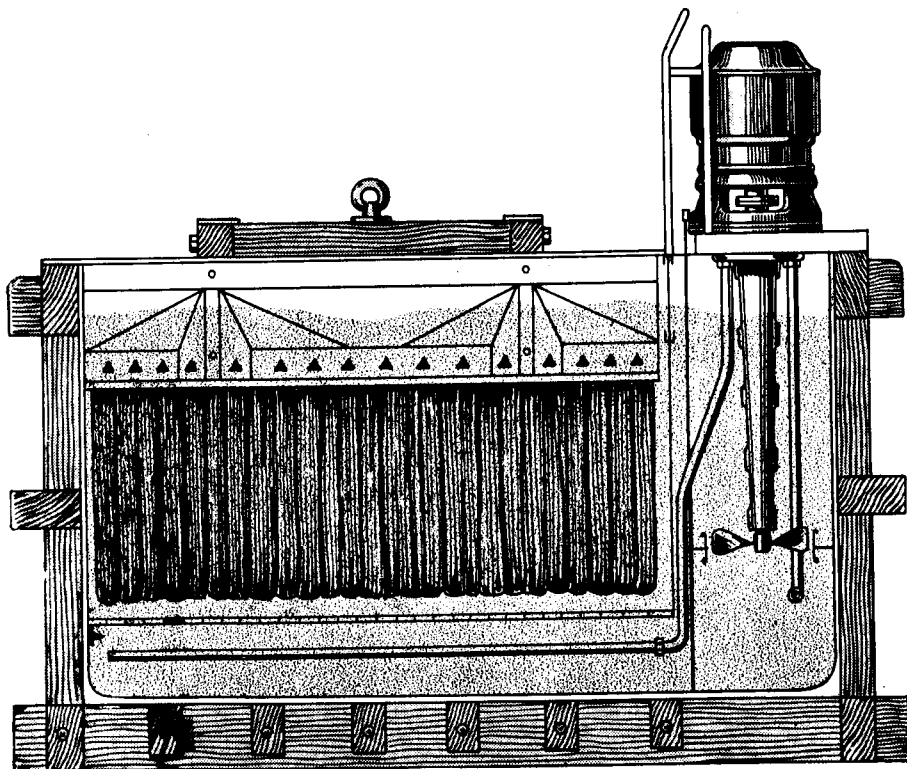

Fig. 13.8 Sectional view of Hussong machine

(Courtesy of Samuel Pegg)

poles is an important factor if the best results are to be obtained from this machine, because the flow of the liquor will tend to take the course of least resistance. It is a common practice to make the loading of the hanks somewhat denser at the ends than in the middle of the poles, because the circulation tends to be more powerful at the sides of the machine. Level dyeing can depend very much upon the skill and experience of the operator. There is an adjustable weir at the bottom of the impeller compartment which regulates the volume of the flow. During dyeing the direction of the

flow must be altered from time to time. When the current is in the downward direction the liquor does not come into sufficiently intimate contact with the portions of the hank resting upon the pole, and this would lead to lighter marks unless the yarn is lifted whilst the flow is upwards. In practice the upward direction is used for the greater proportion of the dyeing

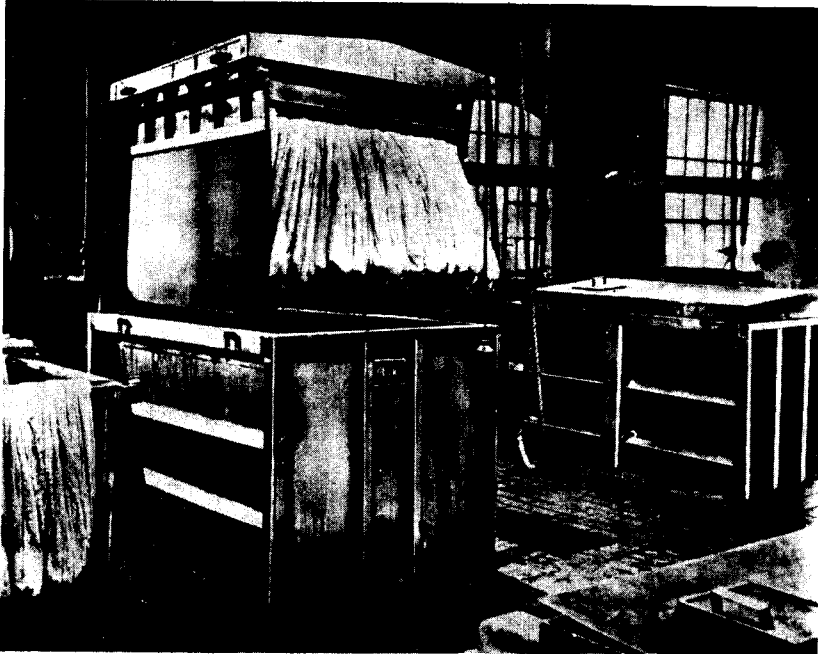

Fig. 13.9 Hanks packed on frame of pulsator machine before dyeing
(Courtesy of Samuel Pegg)

cycle because it presses the yarn into a compact mass against the perforated top of the pole frame, and the liquor, by penetrating through, is compelled to come into uniform contact with every part.

An improvement on the conventional Hussong is the Pegg Pulsator hank-dyeing machine (Fig. 13.9). The reversal of the flow in the original machine disturbed the hanks and made winding more difficult, and also caused some felting or matting in the case of wool. In the Pulsator, the hanks are packed more closely so that the upward flow is not needed to create a tight mass of homogeneous density. General penetration, as well as access of dye liquor to the point of contact between hank and pole, is assisted by an automatically controlled unidirectional pulsating flow. The flow is downward the whole time so that the hanks remain stationary and are held at their full length throughout the dyeing cycle, with the result that they emerge in good condition for winding as shown in Fig. 13.10.

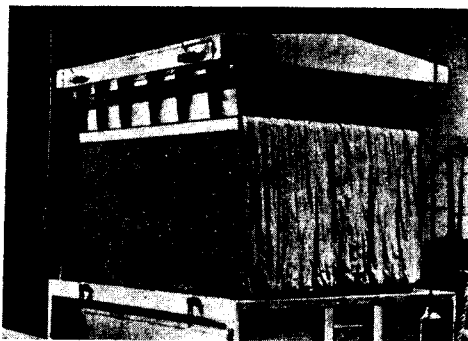

Fig. 13.10 Hanks after dyeing in pulsator machine

(Courtesy of Samuel Pegg)

If desired, it is possible to work the machine with an alternating direction of flow. A great advantage is that the liquor ratio, with this improved design is much lower with consequent saving in steam, water, and chemical costs.

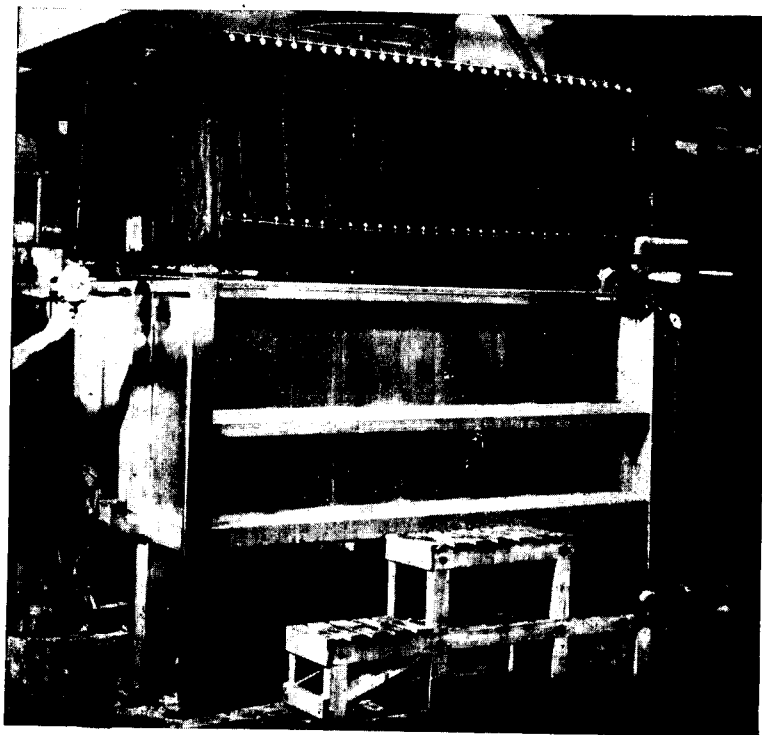

Fig. 13.11 GSH hank-dyeing machine

(Courtesy of Samuel Pegg)

A further improvement is the Pegg GSH hank-dyeing machine (Fig. 13.11). The hank poles, situated at the top and bottom of the carrier frame, are perforated tubes through which the dye liquor circulates in one direction only. Dyeing times can be reduced because of the better accessibility of the yarn to the liquor, and the hanks are stationary so that they remain in excellent condition for winding. The machine is particularly suitable for acrylic yarns as it provides the loftiness associated with hank dyeing together with acceptable uniformity of shade. The circulating system makes it possible to cool synthetic fibres, and particularly the polyacrylonitriles quickly and thoroughly when dyeing is finished. Hanks can also be dyed in package dyeing machines which will be described later in this chapter. They are loaded onto a frame such as is shown in Fig. 13.12. The top arms are perforated and the liquor is circulated, by a pump, up the central

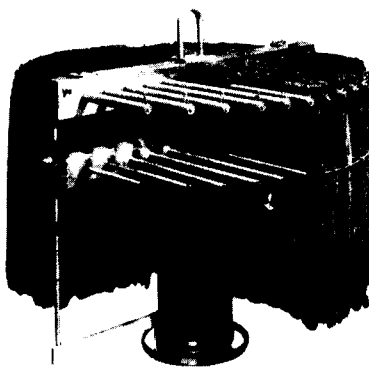

Fig. 13.12 Hank frame
(Courtesy of Samuel Pegg)

column and through the perforations. The lower arms can be used to hold the hanks in position at the bottom to prevent any movement which might cause entanglement.

Yarn in hank form can also be dyed very successfully in the annular-cage type of forced circulation machine (see Fig. 13.4) which gives good results with cotton, rayon, and mock cakes of textured nylon. Wool, on the other hand, does not pack down very well and cannot be dyed in this way with much success.

There has been a very marked tendency to dye yarn in package form instead of in hanks. Hank-reeling is a comparatively expensive process, the plant requires much space, and the yarn must always be wound onto a bobbin, cone, or pirn at a later stage. This second winding from hank after dyeing is also slow and relatively costly from the point of view of wages. The yarn, if it be singlefold, can be wound from cop or ring tube onto a

cheese, dyed in this form, and then rewound with high-speed machinery onto cone. A doubled yarn usually has to be coned by the spinner before delivery to the dyer, because it is not practical to transport it on the bobbins on which it is collected in the doubling machine. Nevertheless, it is appreciably more economical for the spinner to cone the yarn than to reel it into hanks.

The yarn, before dyeing, can be wound onto perforated stainless-steel cones or cheese formers (Fig. 13.13). The view is held by some dyers that it is preferable to wind onto cheeses because, on account of their uniform diameter, they tend to give more level dyeing. The spiral-spring type of

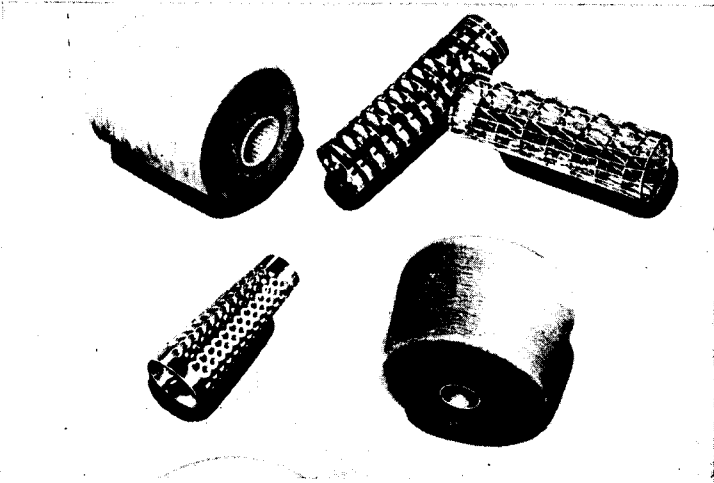

Fig. 13.13 Perforated cone and springs for package dyeing

(Courtesy of Samuel Pegg)

cheese holder is covered with a sheet of porous paper to make manipulation during winding, and the removal of any residue of unwound yarn, easier. The winding machine should yield a soft cheese so that there is not too much obstruction to the flow of the liquor. There is a tendency for penetration to be inadequate near the shoulders of a cheese, and this can be avoided by a special attachment on the machine which gives softer winding at these critical points.

The cheeses, cones, or other packages are loaded onto the perforated vertical tubes of the carriers (Fig. 13.14(a) and (b)) which drop into a seating in the dye vessel, connected to a centrifugal pump which circulates the liquor in a manner illustrated diagrammatically in Fig. 13.15. When the dye vessel is open to the atmosphere it is only practical to have circulation from inside to outside, because centrifugal pumps are less efficient when used as

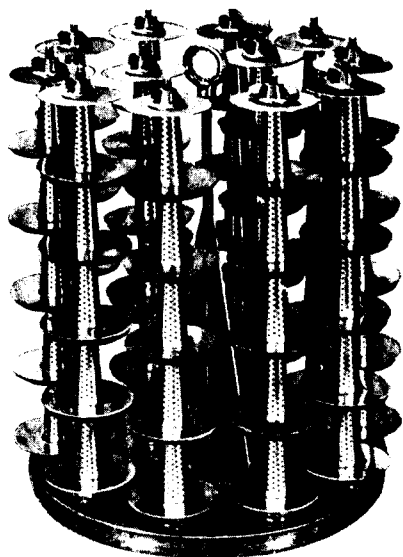

Fig. 13.14(a) Frame for dyeing cones
(Courtesy of Samuel Pegg)



Fig. 13.14(b) Frame loaded with cheeses
(Courtesy of Samuel Pegg)

instruments of suction than when creating flow by pressure. The purposes for which open machines can be used are limited because penetration is obviously better if the flow can be reversed periodically. There is another important factor which must be taken into account. If the internal and external diameters of a cheese are 1.75 in. and 6 in. and the length 5.5 in., then the surface areas will be 13.22 sq in. on the inside and 156.4 sq in. outside. It can readily be appreciated that if the same volume of liquor be presented in the same time to the two areas, the smaller one would take up significantly more dye per unit weight of yarn than the larger. This does not matter with dyes which migrate very easily because maldistribution is adjusted during boiling, but it renders a machine with only unidirectional flow useless for less easily-levelling colours.

In order to obtain a two-way flow the dye vessel must be closed and capable of withstanding pressures of up to 20 lb per sq in. Such a machine designed to operate

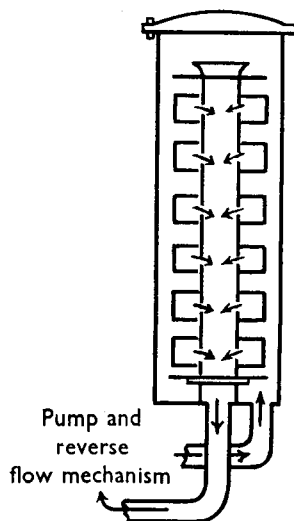

Fig. 13.15 Diagrammatic illustration of cheese dyeing
(I.C.I. publication)

at 100°C or, above atmospheric pressure to 130°C, is illustrated in Fig. 13.16. The cylindrical dyeing vessel is provided with a hinged lid which, when closed, makes a pressure-resisting seal. Before the lid is clamped down the frame carrying the cheeses or cones (Figs. 13.14a and 13.14b) is lowered into position, when it rests on a seating which is connected to the circulating pump below. The liquor is forced through the perforated pipes on which the packages are mounted as shown in Fig. 13.15. Attached to the pump is a reversing valve, usually altering the direction of the flow at predetermined intervals by a mechanically operated device.

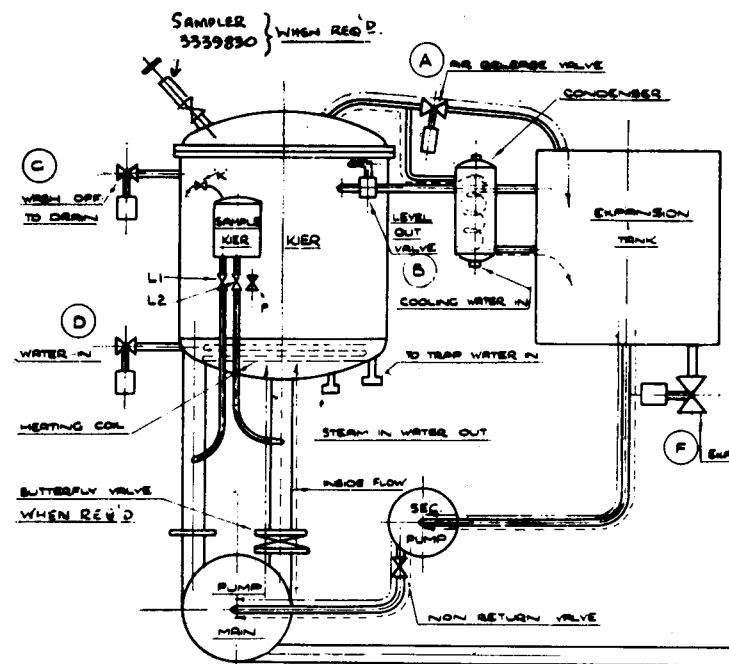

Fig. 13.16 Package dyeing machine

(Courtesy of Samuel Pegg)

An overflow pipe delivers a small amount of the circulating liquor into the open expansion tank at the side. This is necessary because, under working conditions, the pressurized compartment must be completely filled with dye liquor and some accommodation for the increase in volume which accompanies the rise in temperature is therefore essential. It also provides a convenient point at which dyes and chemicals can be added. At the commencement of dyeing the flow should always be from outside to inside and, after a few minutes, the intermittent reversal in direction may be set in motion.

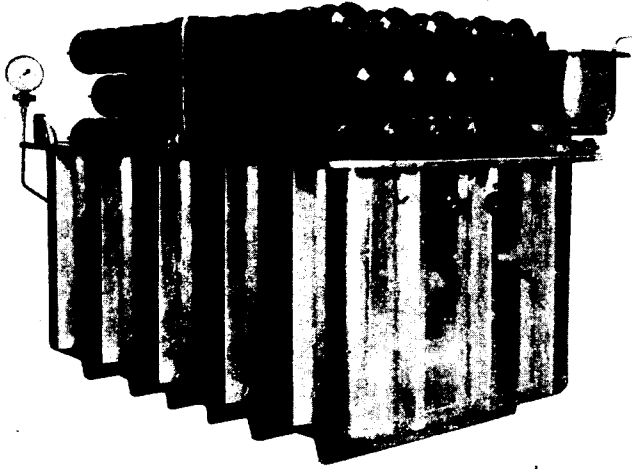

Fig. 13.17 Open cake dyeing machine
(Courtesy of Longclose)

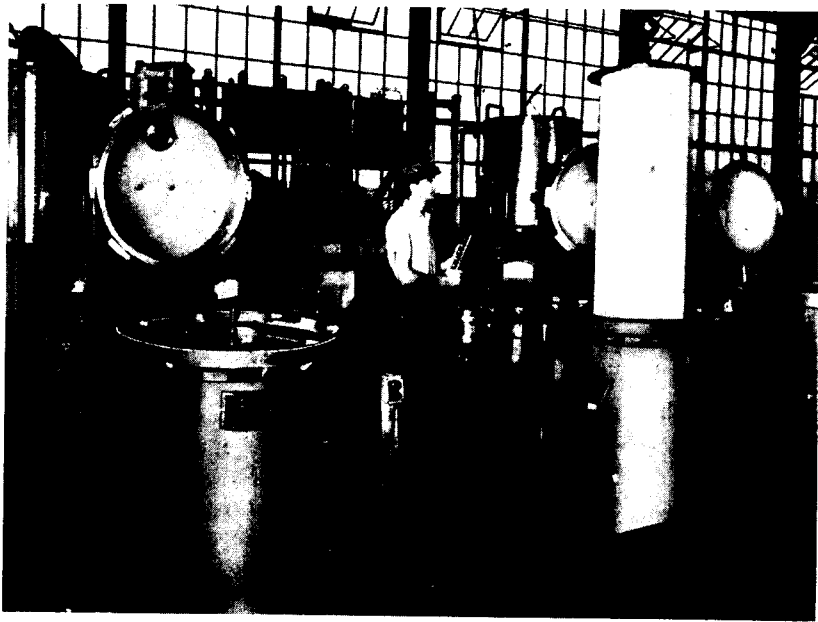

Fig. 13.18 High-pressure beam dyeing machines
(Courtesy of Longclose)

The arrival of hydrophobic synthetic fibres created interest in dyeing, under pressure, at temperatures above 100°C. The machine illustrated in Fig. 13.16 has a secondary pump which is brought into operation to create a static high pressure in the dye vessel when it is desired to apply the dyes at temperatures above 100°C. A constant elevated pressure cannot be maintained satisfactorily by the main pump alone because it would vary according to the density of the winding of the packages and other factors, including the speed of the motor. The secondary pump extracts extra dye liquor from the expansion tank and introduces it into the pressure vessel in such a manner that a static pressure is maintained.

A simplified open vessel with one-way flow was designed by Courtaulds for dyeing rayon cakes from the spinning pot (Fig. 13.17). The cakes are loaded onto horizontal perforated tubes with their open ends fixed into a central box; this has a seating at its base fitting onto a recess in the dye vat

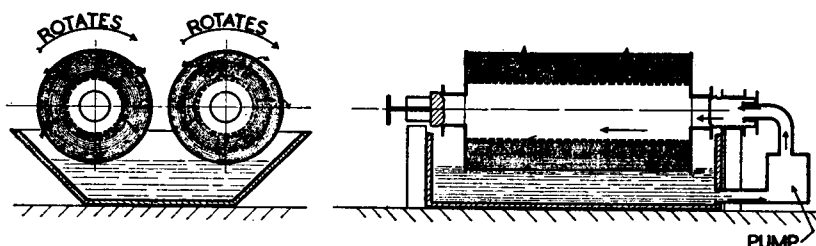

Fig. 13.19 Open beam dyeing machine

at which the dye liquor enters from the centrifugal pump. It is now, however, customary to dye cakes in a pressurized machine in which temperatures above 100°C can be used. Much yarn is dyed in the form of beams, either at 100°C (212°F) or at higher temperatures. The design of the machine is essentially the same as for packages (Fig. 13.18) except that the dye vessel may be deeper and narrower to accommodate the beam and maintain a low liquor ratio. Beams are also dyed in very simple open machines using one-way flow only (Fig. 13.19), in which the scope of the work that can be done successfully is naturally limited, but there is a great saving in the cost of the plant.

Another method is winding and dyeing what are known as 'rockets', extremely large packages weighing up to 9 lb in the case of cotton and 5½ lb for wool, having the shape shown in Fig. 13.20. The package is self-supporting, except for the conical base, and fits over the perforated tubes on the carrier of the cheese-dyeing machine. The advantages of the rocket are less handling, a softer and more uniform package to penetrate and, because of the high crossing ratio, a much easier wind-off after dyeing.

Although not practised as much as other forms of package dyeing, there

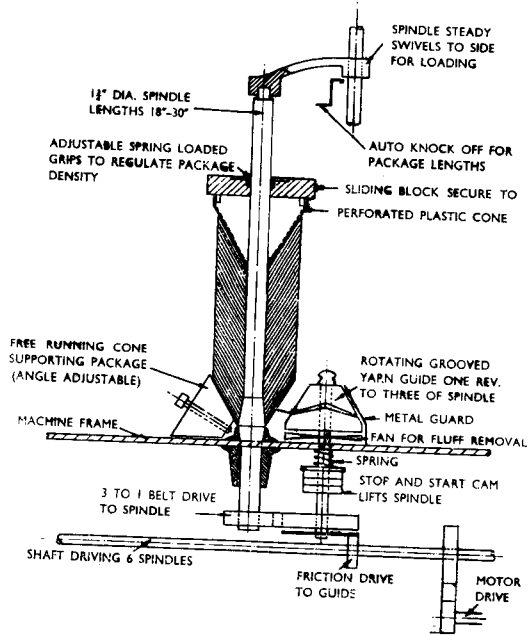

Fig. 13.20 Diagram of mechanism for winding rockets
 (Courtesy of WHITTAKER, 'J.S.D.C.', 1961, 77, 691)

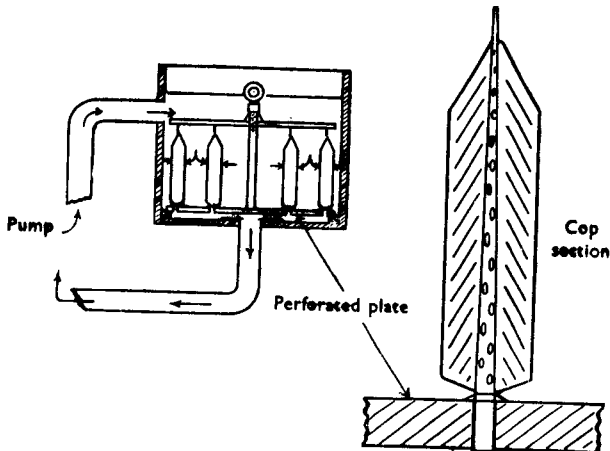

Fig. 13.21 Diagram of cop dyeing machine
 (I.C.I. publication)

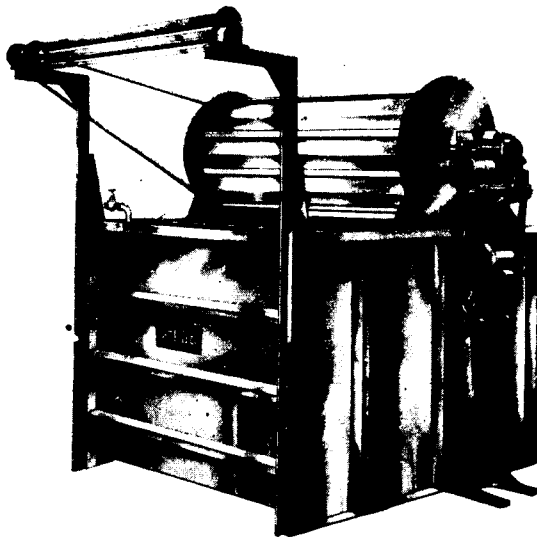

Fig. 13.22 Winch dyeing machine
(Courtesy of Samuel Pegg)

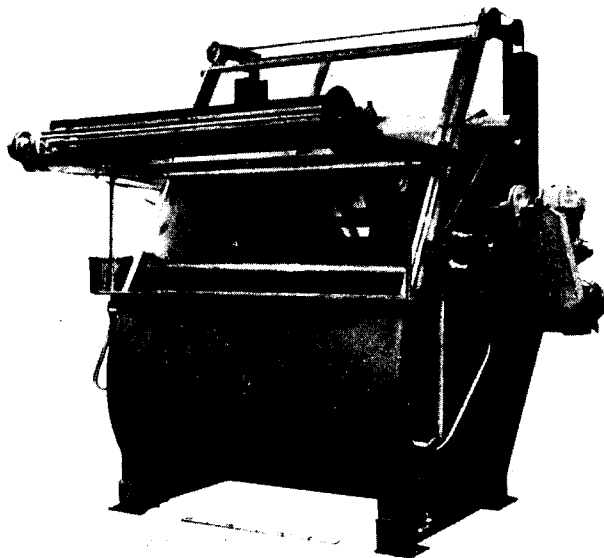

Fig. 13.23 Enclosed fabric dyeing machine
(Courtesy of Freeman Taylor Machines)

are machines designed to treat the cops as they come from the spinning machine, thereby saving a winding or hanking operation. The cops, of which only the bottom portion is wound on a paper tube, are fitted over hollow perforated spindles in such a manner that the holes are covered completely by the cop. The bases of the spindles are sunk into a plate which is lowered and clamped down onto a seating so that the pump either sucks or pushes the dye liquor through the cops, as illustrated in Fig. 13.21.

Fabric dyeing

Knitted fabrics are commonly dyed in rope form in winch machines or sometimes on beams, but woven cloth is more often dyed in open width on jigs. A simple open winch machine is illustrated in Fig. 13.22. The fabric, made into endless chains, is rotated through the liquor by passing over the large drum, and a small driven roller is mounted above the front of the machine to assist in unloading. Up to 12 or even more pieces or chains would be dyed side by side at the same time, being kept apart by dividing fingers situated below a small, idle, guide roller in the front of the dyeing machine, but not visible in the illustration. There is a perforated baffle plate about 6 to 9 in. from the front, making a compartment inaccessible to the fabric, which houses the steam heating pipe and provides a suitable place for the addition of dyes and chemicals. Most winch machines are now totally enclosed, such as that illustrated in Fig. 13.23, but some interlocking device to open up a vent to allow the steam to escape before the front is opened, is essential.

A fault with winch machines is the tendency for the temperature to vary in different parts, particularly in the open type where the fabric loses heat during its passage through the air and cools the liquor at the back when it re-enters. This deficiency is remedied by the incorporation of an external calorifier and pump to give forced circulation of the dye liquor.

The speed of the winch should be adjusted according to the nature of the material to be dyed. Naturally the greater the amount of movement the more uniform will be the dyeing. With wool fabrics, however, excessive movement can cause undesirable felting or shrinkage and a slow speed is preferred. It is under such circumstances that the forced circulation with an external pump has much in its favour. With cotton and rayon fabrics fast-running machines are used, except when the materials are so delicate that they would suffer damage.

As the cloth or web falls into the liquor from the winch at the back of the machine, it tends to bunch up and lie in a heap for a short time. This is no disadvantage with wool or cotton materials, but tends to cause serious creases in acetate rayons and other thermoplastic fibres. To overcome this a long shallow machine with an elliptical winch has been designed (Fig. 13.24). The elliptical shape of the roller folds the material in wide layers which are free from random creases as it falls into the dye liquor. The

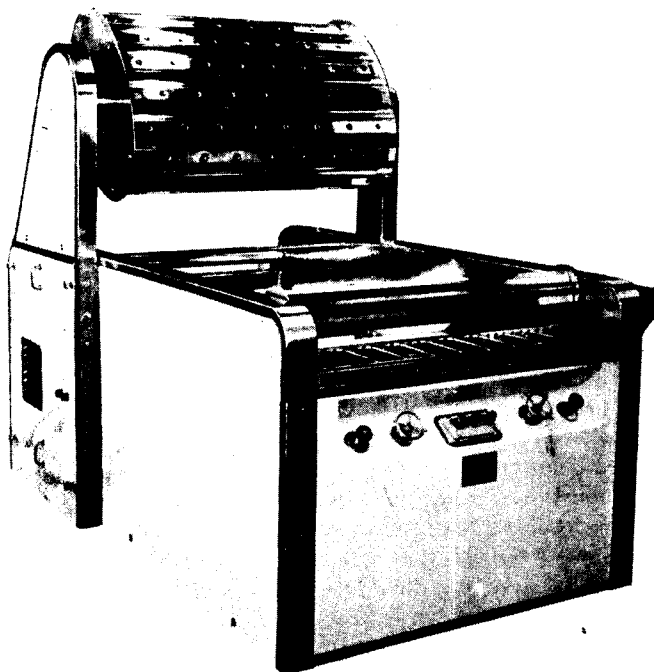

Fig. 13.24 Elliptical winch fabric dyeing machine
(Courtesy of Leemetals)

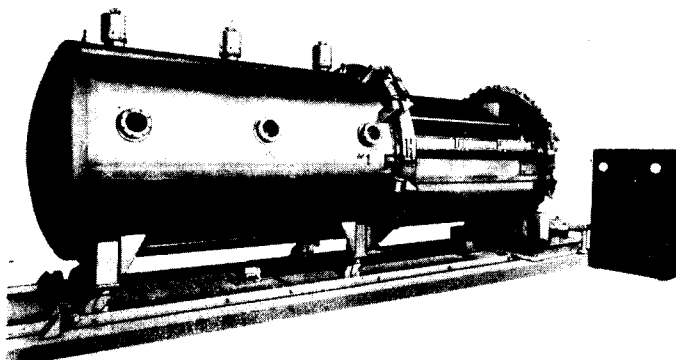

Fig. 13.25 High pressure winch
(Courtesy of Samuel Pegg)

shallowness of the tank means that there is no great weight of water pressing on the fabric to make creases permanent.

High pressure winch dyeing machines for polyester fabrics have been developed. As an example the one designed by Samuel Pegg is shown in Fig. 13.25. The dyebath is essentially a normal winch dyeing machine and

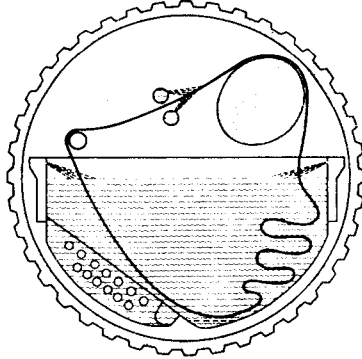

Fig. 13.26 Arrangement of jets in high pressure winch machine
(Courtesy of Samuel Pegg)

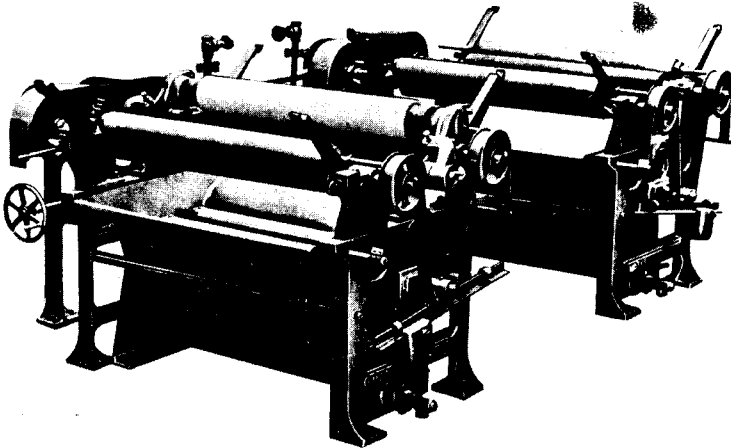

Fig. 13.27 Jigs
(Courtesy of Mather and Platt)

a kier, on a track, can be pushed into position so that the dyebath is totally enclosed in a pressure-resisting container. The same machine can, if desired, be operated at atmospheric pressure when it is not enclosed. It is also possible to improve productivity by having two winches for one kier so that loading, scouring and washing off can be done at atmospheric pressure on one whilst dyeing is in progress in the other. A system of internal sprays helps in uniformity of dyeing and the avoidance of creases (see Fig. 13.26).

Woven woollen pieces are almost always dyed on winch machines, but for cotton and rayon goods the jig is used. This is particularly suitable for cellulosic fibres because the dyes generally do not exhaust well and the jig works with an exceedingly low liquor ratio. The machine is illustrated in

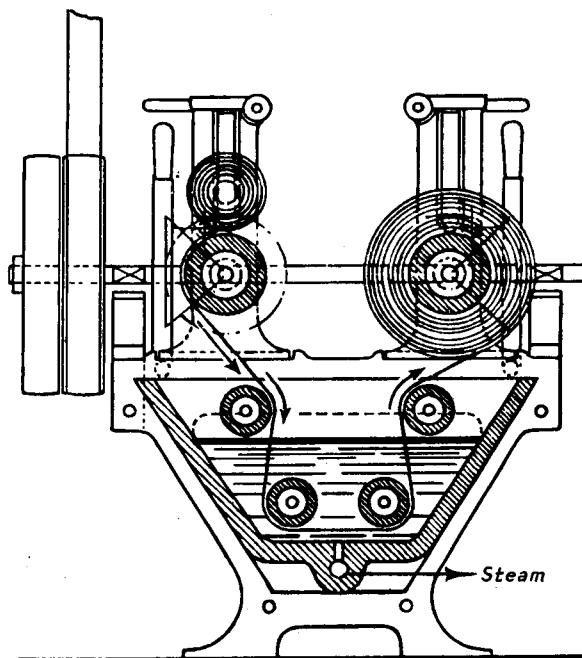

Fig. 13.28 Diagram of jig

Fig. 13.27 and the principle on which it works is shown diagrammatically in Fig. 13.28. The material is wound, in open width, over rollers standing above a shallow trough containing the dye liquor. The rollers, by rotating in clockwise and anticlockwise directions alternately, pull the cloth backward and forward through the dye liquor, complete immersion being ensured by guide rollers at the bottom of the tank. Only a few yards of the

piece are immersed in the dye bath at any one time, making it possible to work with an exceedingly short liquor. The reversal of the direction of rotation of the rolls is controlled automatically. High-pressure jigs are made for dyeing polyesters and other fibres where temperatures above 100°C (212°F) yield improved exhaustion. The usual practice is to enclose a jig or corresponding type of dyeing machine in a pressure-withstanding chamber as illustrated in Fig. 13.29. End-opening pressure vessels are also made, into which jigs can be run in and out on rails, connecting up with an external

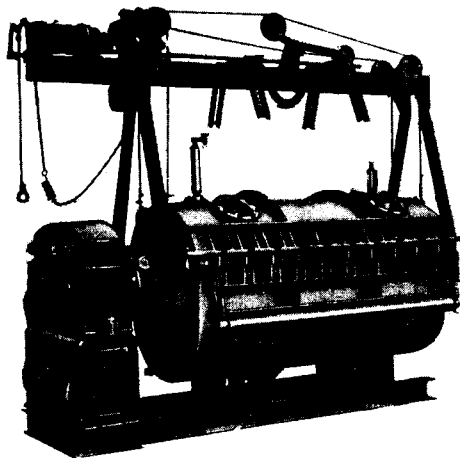

Fig. 13.29 High-temperature jig dyeing machine

(Courtesy of F. Smith (Whitworth))

driving mechanism when pushed into the right position in the autoclave. This arrangement makes it possible to be loading up a second jig whilst the first is dyeing.

The dyeing of open-width fabrics in the form of beams has become common practice during recent years. The method has been found particularly suitable for open-width warp-knitted materials, and is probably simpler than using jigs enclosed in pressure vessels for dyeing at temperatures above 100°C. The vertical and the open-beam dyeing machines have already been described, but a design with a horizontal pressure vessel is often preferred for open-width fabrics (Fig. 13.30). The systems are basically the same as those described for high-temperature yarn package-dyeing machines, and the fact that the fabric remains stationary in the autoclave simplifies the construction and operation of the machine.

Continuous-dyeing methods are finding increasing application to woven

cloths. The sequences of operations are described in later chapters, but they all depend upon impregnation with padding mangles, which may appropriately be described at this stage. The basic mechanism is illustrated in

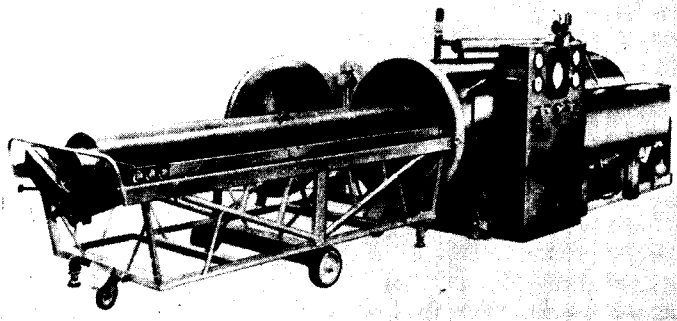

Fig. 13.30 Horizontal beam dyeing machine, high pressure
(Courtesy of Samuel Pegg)

Fig. 13.31a and 13.31b. The cloth is drawn through a tank containing a concentrated dye solution, which must be fortified continuously to compensate for the quantity taken away by the fabric. It then passes through two heavy squeeze rollers which are mounted and actuated so that they

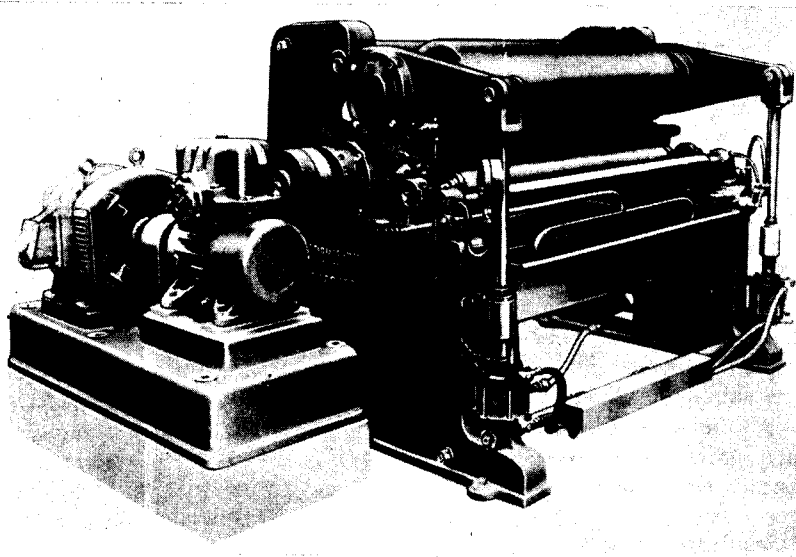
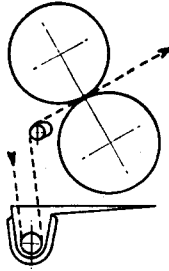

Fig. 13.31(a) Padding mangle
(Courtesy of Sir James Farmer Norton)



2 BOWL INCLINED DYE OR CHEMICAL PAD

Fig. 13.31(b) Diagram of padding mangle
 (Courtesy of Sir James Farmer Norton)

give a uniform squeeze over the whole width. They should also be adjustable so that the percentage of liquor left in the cloth can, within practical limits, be predetermined. The calculations of the dye-solution concentrations are governed by the degrees of expression.

Machines for dyeing footwear and garments

The traditional and commonest machine in general use is the Gorrie or oval-type paddle, illustrated in its simplest form in Fig. 13.32. The goods are rotated by the paddle round a central island which has perforated sides

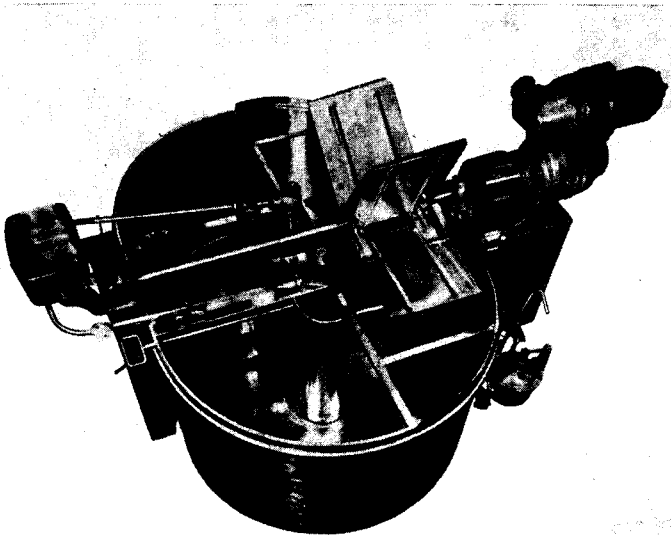

Fig. 13.32 Oval paddle dyeing machine
 (Courtesy of Samuel Pegg)

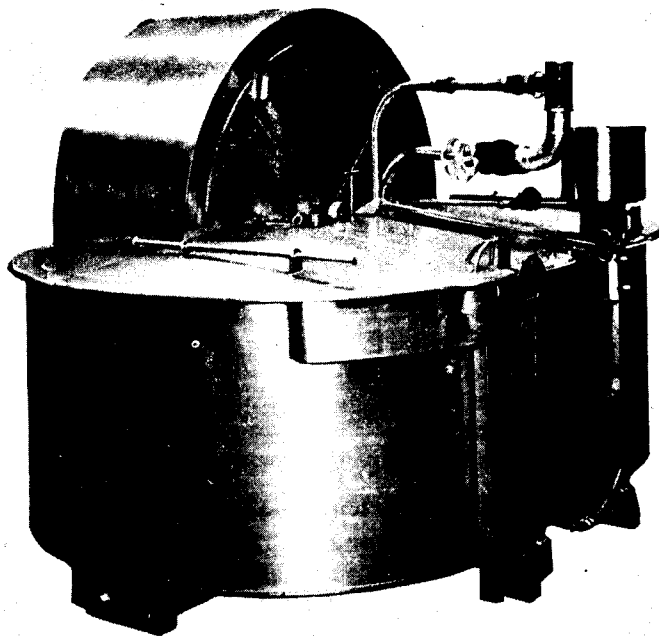

Fig. 13.33 Gridflow paddle dyeing machine
(Courtesy of Freeman Taylor Machines)

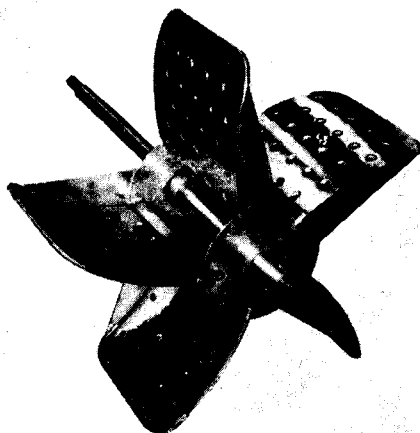

Fig. 13.34 Perforated paddle for gridflow machine
(Courtesy of Freeman Taylor Machines)

separating the goods from the water space within the island. This makes provision for running the liquor off without the garments being discharged through the outlet, and it also serves for the addition of dyes and chemicals. There are two heating pipes in the bottom with holes arranged so that the live steam emerges in the same direction as the flow of the liquor in order to lift goods off the bottom to keep them in circulation. An open machine is illustrated for the purpose of showing the working principle, but modern ones are covered with a hood to make them totally enclosed except when loading and unloading. The Gridflow paddle machine (Freeman Taylor Machines Ltd., Fig. 13.33) is totally enclosed and incorporates perforated paddle blades (Fig. 13.34). Footwear is generally packed in mesh bags for dyeing, and the holes in the blades cause a current of dye liquor to pass through the bag during the period of contact. A simpler machine is the overhead paddle (Fig. 13.35) which relies not only on the paddle for circulation but also on the curved sides of the tank deflecting the flow imparted by live steam emerging from the heating pipes. These machines are cheap to construct but more difficult to unload, and suffer from the

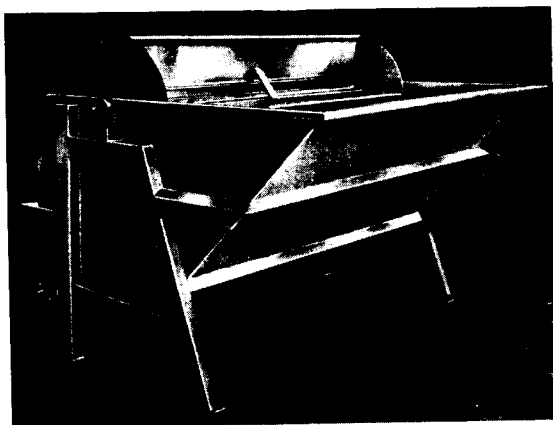

Fig. 13.35 Overhead paddle

(Courtesy of Alfred Horrocks)

disadvantage that the circulation of the goods practically ceases if the steam has to be turned off. Sometimes compressed air or an air intake venturi tube is connected to the steam inlet to promote circulation if it becomes necessary to cool the liquor.

Silk hosiery is frequently dyed in a rotating-drum type of machine (Fig. 13.36) which consists of an inner perforated drum with doors. The goods are packed into the drum, the surface of which, for silk stockings, must be polished to the highest degree of smoothness. The least roughness or slightest scratch on the metal causes damaged goods through plucked

threads. There is an outer case forming a vessel in which the perforated drum rotates. A reversing mechanism causes the drum to make a certain number of rotations in one direction and an equal number in the other.

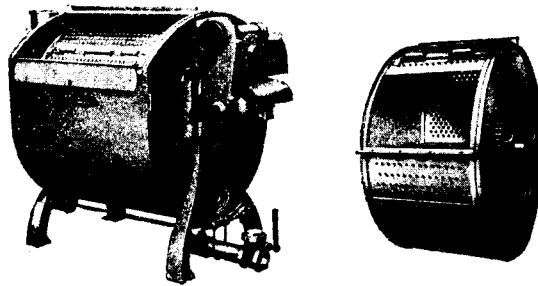

Fig. 13.36 Rotating drum machine for dyeing hose
(Courtesy of Samuel Pegg)

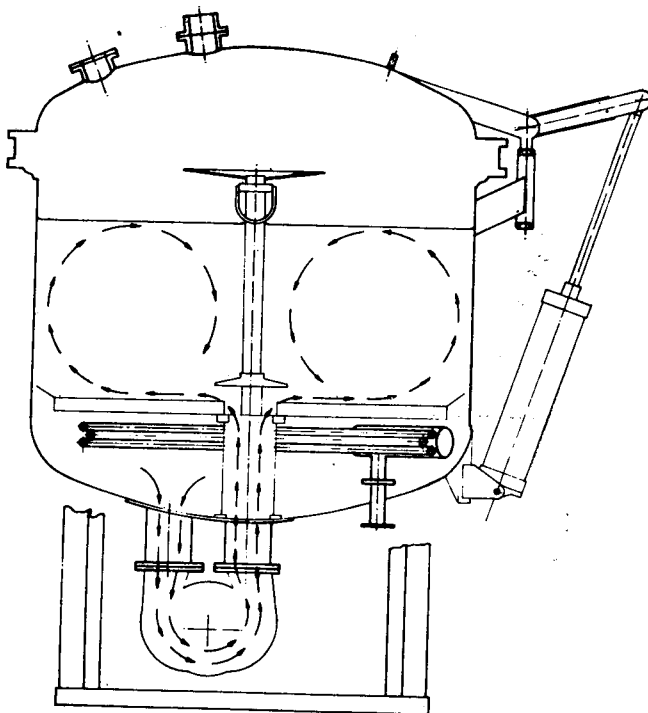

Fig. 13.37 Toroid machine
(Courtesy of Samuel Pegg)

A recent development is the Toroid machine of Samuel Pegg for dyeing garments under pressurized conditions at temperatures up to 140°C (284°F). This is especially useful for dyeing garments containing polyester fibres. The pump circulates the dye liquor in at the bottom, and it impinges upon a spreader plate which deflects the flow round the sides of the cylindrical outer vessel. It then flows over the top of the annular cage, containing the goods, from which the pump withdraws the liquor through a central perforated pipe. A swirling action is imparted to the dyebath which keeps the goods in constant movement (Fig. 13.37).

During recent years great progress has been made in continuous dyeing and finishing of hose. There are several types of machine in use, but a description of the Pegg Twin Operator Dye Boarder will provide a suitable example. As is apparent in the illustration (Fig. 13.38), the autoclave, in which all operations are carried out automatically, lifts vertically for charging with hose on metal boards, and then falls onto a seating to form a pressure-resisting seal.

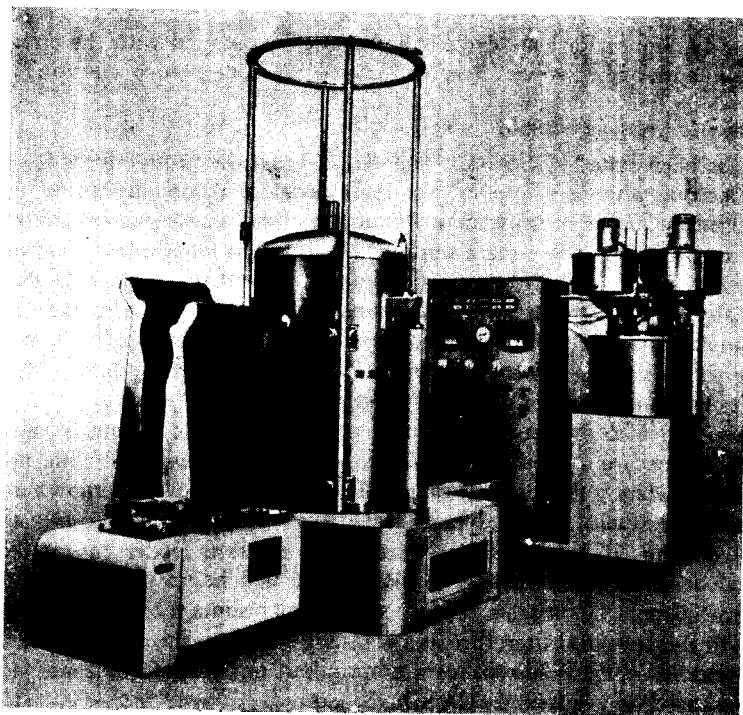

Fig. 13.38 Dye boarder
(Courtesy of Samuel Pegg)

The machine has been designed to provide an output of about 200 dozen pairs from two operatives in an eight-hour shift. The forms are arranged in four separate rows of 36, and it is therefore possible to process four different sizes simultaneously. All the movements are fully automatic and the sequence and duration of operations is easily adjustable to cater for a wide variety of requirements. A typical sequence would be as follows:

- (i) The hose are preboarded with live steam.
- (ii) Steam is exhausted from the retort.
- (iii) The dye liquor and chemicals are introduced.
- (iv) The dye liquor is recirculated for a predetermined period of time.
- (v) The dye liquor is discharged from the retort.
- (vi) Live steam is admitted for postboarding.
- (vii) The steam is exhausted from the retort.
- (viii) Air is circulated through the heater and over the hose forms for drying, all humid air being discharged.
- (ix) The retort is raised on completion of the cycle, and the form carriages automatically come into the correct position for the next cycle.

The dye liquor for each cycle is automatically charged with the appropriate quantity of dissolved dyes and chemicals from a stock solution.

Automatic process control

It has been stated (*J.S.D.C.*, 1968, 84, 66) that the productivity of one man looking after a group of five high pressure dyeing machines was increased by 37 per cent by the introduction of automatic process control. The reason is that there are a number of occasions when more than one operation should be carried out simultaneously and this cannot be done manually. Another factor is the human inability to move and react mentally with instantaneous speed. Many more examples could be quoted to demonstrate the advantage of the elimination of human memory and manual manipulation in the operation of dyeing processes.

There are, of course, a number of ways in which water and steam valves can be opened or closed in accordance with a predetermined time programme. In batch dyeing the weight of the material must be known and the necessary quantities of dyes and chemicals must be weighed out and dissolved and, if necessary, pre-heated in separate feeder tanks. The valves connecting them with the main vessel will be opened at the programmed times. An ultimate refinement, to which some reference has been made in the technical literature, is a scanning device at the delivery end of a continuous range. This makes a tristimulus analysis of the shade and applies corrections automatically when required.

One of the simplest and most commonly used forms of automation is

temperature control. There are various ways in which this can be achieved and a compressed air mechanism provides an example of a commonly used instrument. The basic principle is illustrated in Fig. 13.39 in which compressed air enters at *A*. When the nozzle *B* is open the air escapes at this point and the pneumatically controlled steam valve *C* is open allowing the

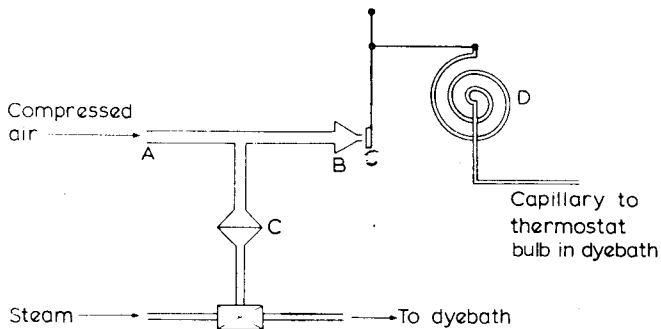

Fig. 13.39 Temperature control

steam to enter the dyebath. As the temperature rises the fluid contained in the thermostat bulb immersed in the dyebath expands and, through the connecting capillary, causes the bourdon tube *D* to operate a mechanism which closes *B* with the clapper. Thus the pressure on the pneumatically controlled valve is increased with the result that the supply of steam is either cut off or diminished.

Conversely, as the temperature falls, the clapper ceases to seal the nozzle and more steam can pass into the dyebath. This, of course, is only a simple thermostat designed to maintain a constant temperature.

A very important factor in dyeing is to control the rate of rise of temperature. If the nozzle remains stationary the steam valve will be fully open until the specified temperature is reached and then it closes. If it is desired to retard the rate at which the temperature is increased, a slow rotary movement can be given to the nozzle in the same direction as the clapper is being moved by the bourdon as the temperature rises. A friction drive, such as is illustrated in Fig. 13.40 can give, within limits, an infinitely variable speed of rotation to the nozzle, making possible a wide range of different rates of rise of temperature. These are usually calibrated on the panel of the instrument in degrees per minute. What has been described is the basic principles but it must be emphasized that modern instruments have many refinements.

The Celcon automatic dye cycle controller has been developed by Courtaulds Engineering Ltd. The various operations in the process cycle

are programmed on a punched card. There is a gain in reliability because there is no movement of the card and the impulses are given by feelers which penetrate at the perforations to make the necessary contacts.

The instruction cards are of two categories. There is the semi-permanent information which is programmed by the insertion of plugs in a patchboard. Such instructions are those which are generally applicable to the type of machine. Examples are times allotted to major functions in the

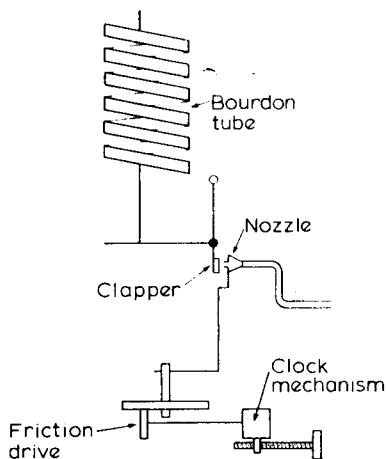

Fig. 13.40 Control of rate of rise of temperature

cycle, and control of flow direction. There are also four alternative temperature gradients controlled by the patchboard, any one of which may be chosen. Secondly there are the sub-routines controlled by easily prepared punched cards which are suitable for filing. The sub-routines deal with factors such as the delivery of dyes and chemicals from the dispense tanks at appropriate times and temperatures and also with special factors peculiar to the individual machine.

Control is exercised by binary logic gates. These will prevent steps from being set in motion until the conditions under which they should become operative have been established. Thus, for example, the chemical dispense tanks cannot be opened until a specified temperature has been reached, irrespective of the time called for in the programme.

There are a series of lights on the visual panel of which the green ones indicate normal running. Yellow lights show that attention is necessary, as, for example, when a dispense tank has inadvertently not been filled and the machine will then wait until the required action has been taken. Finally there are red lights which show that there is something seriously amiss such as lack of steam or an electrical breakdown.

A modern tendency is to assemble all the dispense tanks in the drug store and the control panels in the dyehouse management office; owing to the separation of the dyeing machines from the other two functions it is desirable to have some signalling system between the sections so that each participant knows what stage has been reached in the cycle.

14. Basic dyes

THE basic dyes are historically interesting because Perkin's mauve (see Chapter 1) belonged to this class, as do Magenta and Malachite Green which were amongst the earliest synthetic dyes.

Chemical nature of basic dyes

This class owes its name to the fact that the dyes ionize and the coloured component always constitutes the cation. For this reason there is now a tendency to refer to them as the *cationic dyes*. The dye bases usually have a general formula of the type $\text{R}-\text{C}_6\text{H}_4-\text{NH}_2$ which is capable of salt formation



as shown:

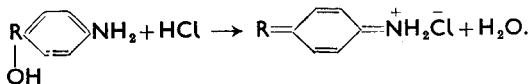

The base, containing no quinonoid chromophore, is colourless and the colour only appears on salt formation. Basic dyes as they appear on the market are salts, usually the chlorides but sometimes oxalates or even double salts with zinc chloride.

Classification of basic dyes

There are many dyes belonging to this class and they vary considerably in chemical structure. The more important groups are described below.

Group 1

Derivatives of triphenyl methane:

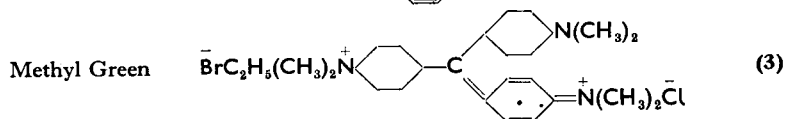
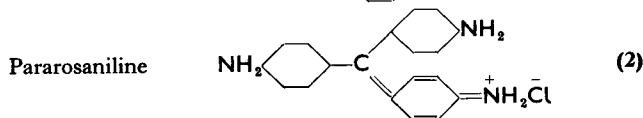
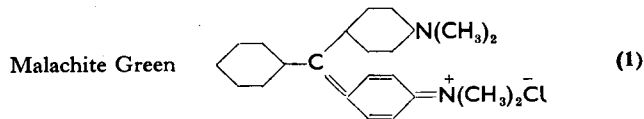

Other triphenyl methane basic dyes of almost classical interest are:

Para Rosaniline	C.I. BASIC RED 9
Fuchsine	C.I. BASIC VIOLET 14
New Magenta	C.I. BASIC VIOLET 2
Crystal Violet	C.I. BASIC VIOLET 3

Group 2

Derivatives of thiazine of which the best known example is Methylene Blue (4):

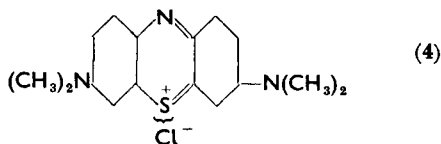

Other examples are:

Methylene Green	C.I. BASIC GREEN 5
New Methylene Blue H	C.I. BASIC BLUE 25
New Methylene Blue A	C.I. BASIC BLUE 24

Group 3

Basic dyes which contain the oxazine group of which Meldola Blue (5) was the first to be prepared:

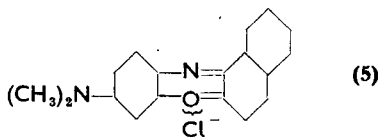

Another oxazine basic dye is

Nile Blue	C.I. BASIC BLUE 12
-----------	--------------------

Group 4

The azines, of which one of the simplest is Neutral Red (C.I. BASIC RED 5), formula (6):

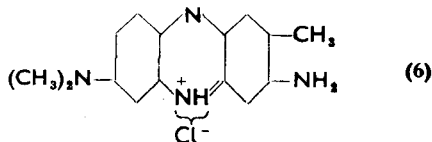

Other members of the group are:

Methylene Violet	C.I. BASIC VIOLET 5
Safranine	C.I. BASIC RED 2
Mauve or Mauveine	(W. H. Perkin, 1856)

Group 5

The xanthene dyes constitute an important class of which Rhodamine B (7) is probably the best known example:

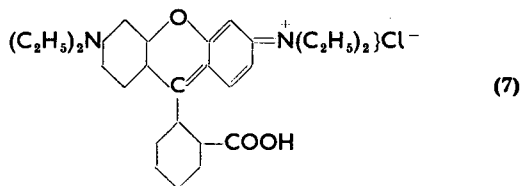

Some other xanthene basic dyes are:

Rhodamine 3G	C.I. BASIC RED 3
Rhodamine 3GO	C.I. BASIC RED 4

Group 6

Basic dyes containing azo groups such as Bismarck Brown (8):

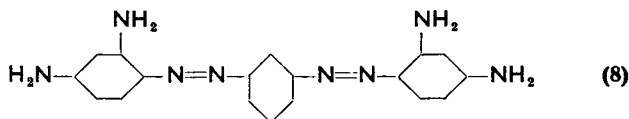

which is prepared by dissolving 3 molecular equivalents of meta-phenylenediamine in hydrochloric acid and adding 2 molecular proportions of nitrous acid. One molecule becomes diazotized at both its amino groups and then couples with two unchanged meta-phenylenediamine molecules.

Because of their poor fastness to light, the use of basic dyes had virtually been discontinued until it was found that they would dye the acrylic fibres and give bright clear shades of good light fastness. It has been suggested that the explanation lies in the fact that the fibre is so hydrophobic that the moisture and oxygen which are known to participate in fading cannot gain access.

Most of the basic dyes used for the polyacrylonitriles belong to the more recently developed azo and anthraquinone groups, as well as the methines. An example of an azo dye is:

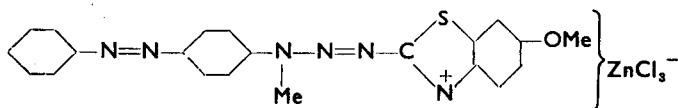

which yields a yellowish orange colour. In many cases the primary amino groups are attached to heterocyclic rings and do not diazotise with ease and they are therefore prepared by oxidation of hydrazines.

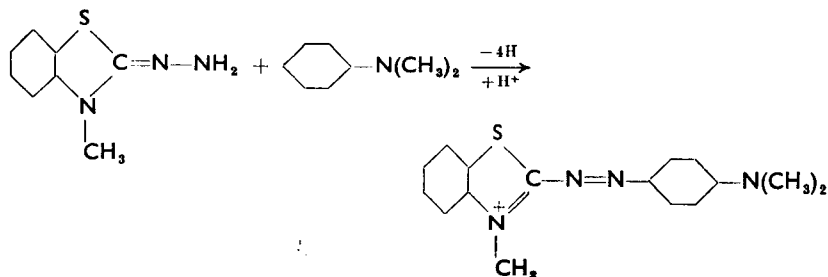

A typical methine basic dye is, for example, C.I.S166 which has the structural formula:

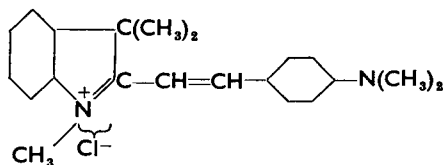

and an example of a significant group of basic dyes based on anthraquinone which are used for the polyacrylonitriles is:

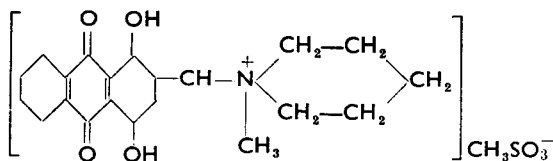

There are other basic dyes not included in the foregoing list, but they are of little practical importance.

Properties of basic dyes

The outstanding characteristic of the basic dyes is the brilliance and intensity of their colours. Some of the shades are of such clarity of hue that no other class can compare with them. The intensity is illustrated by a comparison of the dyeing properties of magenta, which is a basic dye, and acid magenta, which has the same molecular structure but has been converted into an acid dye by sulphonation. Whilst 5 per cent of the latter is required to produce a full shade on wool, only 2 to 3 per cent of basic magenta is necessary. The basic dyes are readily soluble in alcohol or methylated spirit. They are not, as a rule, so easily dissolved in water and, unless care

is taken when dissolving them, they are liable to form a sticky mass which can be very difficult to bring into solution. Some of them, such as Auramine (C.I. BASIC YELLOW 2), are decomposed by boiling water and must be applied at temperatures of 60° to 65°C (140° to 150°F). Even the more stable ones tend to undergo slight decomposition with flattening of the shade on prolonged boiling. When a basic dye is treated with an alkali it is decomposed with the liberation of the dye base which is colourless:

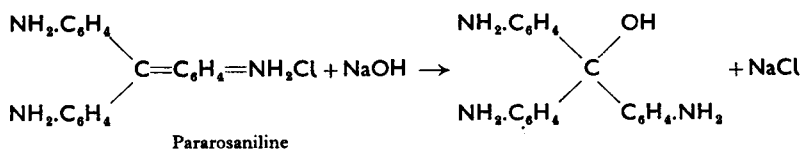

Many of the dye bases are sparingly soluble in water. Thus if sodium hydroxide is added to a solution of Methylene Blue, and the mixture allowed to stand for some time, a flocculent precipitate of the base will appear. Thus water containing alkali or temporary hardness should not be used with basic dyes without neutralizing first with acetic acid. Softened water generally contains sodium carbonate or calcium hydroxide and should be neutralized. The dye bases are soluble in ether and can be isolated by shaking a solution from which they have been precipitated with the solvent in a separating funnel.

Basic dyes, being cationic, can, under certain conditions, be precipitated by direct or acid dyes which are anionic. The two, therefore, cannot be used together except at very low concentrations. Advantage can be taken of this mutual precipitation because the direct dye acts as a mordant when on dyed cellulosic materials and, therefore, basic dyes can be used for after-treatment to brighten shades.

The basic dyes are of poor fastness to light and vary with regard to washing fastness from poor to moderate. Some examples on wool are tabulated below to provide general conception of their fastnesses.

Table 14.1

Dye	Light		Washing	
	Wool	Cotton	Wool	Cotton
Auramine	1-2	1-2	1-2	3
Chrysophenine	1	1	1-2	1-2
Chrysoidine	1-2	1-2	1-2	1
Rhodamine 6GB	1-2	1-2	3-4	1
Rhodamine S	1-2	1-2	2-3	1
Methyl Violet	1	1	4	2
Crystal Violet	1	1	2	1-2
Victoria Blue	1	1	2	2

An important property of basic dyes is that, without exception, they will combine with tannic acid to form an insoluble compound, provided mineral acid is absent. This precipitate is formed when a solution containing tannic acid and sodium acetate is added to one of the dye. The purpose of the sodium acetate is to react with the hydrochloric acid liberated from the dye-stuff, and to maintain a *pH* favourable to the formation of the tannic acid-dye complex. This property has an important application in practical dyeing. Cellulosic fibres, unlike those composed of proteins, have no affinity for basic dyes. They can, however, be mordanted with insoluble double salts of tannic acid to give them an affinity. The wet-fastness of basic dyes on protein fibres can also be improved by back tanning. This consists of after-treating the dyed material with tannic acid in order to form the insoluble complex, thereby reducing the tendency to migrate. The process, however, has the disadvantage that it tends to flatten the shades.

When treated with reducing agents most basic dyes are converted to colourless compounds with comparative ease, as is illustrated in the case of pararosaniline:

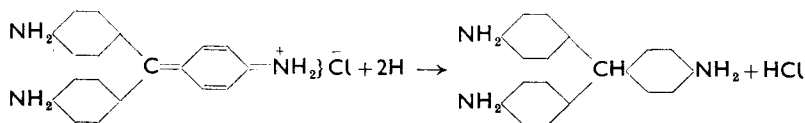

The product of reduction is usually very easily reoxidized to the dye, often even on exposure to air. An exception, however, is when the basic dye contains an azo group. The reducing agent then breaks the molecule down, at the azo linkage, into two components which cannot be reunited in their original form by oxidation.

Nature of affinity

Cellulosic fibres have, for all practical purposes, no affinity for basic dyes. A few such as Auramine (C.I. BASIC YELLOW 2), Magenta (C.I. BASIC VIOLET 14), and Methyl Violet (C.I. BASIC VIOLET 1) have some affinity for cotton, but the wet-fastness leaves very much to be desired. In the case of the protein fibre there is substantial evidence that the affinity is of a chemical nature. The reaction is essentially one of salt formation as shown:

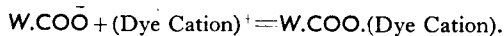

Where *W* represents the wool molecule. Not much work has been done on the adsorption of basic dyes by animal fibres, but Glenz and Beckmann (*Melliand Textilber.*, 1957, **38**, pp. 296, 783, and 1152) have studied the exhaustion isotherms of basic dyes with polyacrylonitrile fibres. The curves which are obtained correspond with the Langmuir type of equilibrium, except that they are steeper in the initial stage. It is believed that this is because the dye cations are adsorbed extremely rapidly at the

surface on account of the electrostatic attraction attributable to the negative zeta potential. On heating, the dye ions penetrate into the fibre where they attach themselves to the acidic sites. The isotherms provide evidence that the adsorption of basic dyes by polyacrylonitriles, and presumably also by protein fibres, is essentially a stoichiometric chemical reaction.

Dissolving basic dyes

Owing to the relative insolubility and tendency to tar, special precautions are necessary when dissolving basic dyes. The dyestuff is first made into a paste with about its own weight of 30 per cent acetic acid. Sufficient boiling water is then added with constant stirring to dissolve the dye, bearing in mind that the temperature of the water must not exceed 60°C (140°F) with Auramine. It is sometimes advantageous to use methylated spirit instead of acetic acid to assist in preparing a satisfactory solution. If synthetic surface-active products are used they must be non-ionic or possibly cationic, because those which are anionic will precipitate the dye.

Assistants

The basic dyes have such a great affinity for the protein fibres that the presence of a retarding agent is often desirable. From 1 to 2 per cent of acetic acid on the weight of the goods is most frequently used for the purpose. The excess of hydrogen ions in the liquor counteracts the attraction of the electronegative sites in the fibre and slows down the rate of adsorption of the dye ions. When acid has been used, the addition of a small amount of alkali may be necessary towards the end of the dyeing to complete exhaustion. Since basic dyes are adsorbed in a neutral or alkaline bath, soap may be used as an assistant instead of acetic acid; from 10 to 15 per cent on the weight of the goods is required. When dyeing with soap, soft water is essential.

Application of basic dyes to silk

Silk is often dyed with basic dyes in a 'broken' degumming liquor, prepared in the following manner: A dyebath is made up containing 25 gallons of boiled-off liquor diluted to 100 gallons with soft water. Acetic acid is then stirred in until the reaction to litmus paper is just acid. This neutralizes alkali and also liberates fatty acids from the soap which rise to the surface and must be skimmed off before the dyeing commences.

Dyeing in a broken degumming liquor

The bath is raised, without any additions, to 37·8°C (100°F) and the silk is entered and wetted out. It is then lifted and the strained dye solution is added and well mixed by stirring. The silk is returned to the bath and kept in motion for the next 20 minutes. The temperature is then raised slowly to 82°C (180°F) at which it is kept for half an hour. With auramine the

temperature should not be allowed to rise above 75°C (167°F). Owing to the great affinity which silk has for basic dyes, this method may sometimes give uneven results. For this reason a slower process of dyeing may be preferred. The dyestuff solution is divided into three equal portions. One part is added to the bath and the silk is worked in it cold for 20 minutes, after which it is lifted out and the second portion of dye is added. The load is put back and the temperature is raised to 37.8°C (100°F), at which temperature dyeing is continued for a further 20 minutes. Finally the silk is again taken out, the remainder of the dye is added, the goods are re-entered and the temperature is raised slowly to 82°C (180°F). After dyeing, the goods are rinsed, hydro-extracted and dried. Scrooping with tartaric acid or acetic acid is then applied, if desired. Sometimes hydro-extraction follows a final immersion in a suspension in soap of 2½ lb of olive oil for 100 lb of silk to give a brighter finish.

Dyeing in a neutral soap bath

The first necessity is a supply of soft water. Ten to fifteen per cent of olive oil soap is added to the bath. The silk is entered at 60°C (140°F) and worked in the liquor until it is thoroughly wetted out. It is then lifted and a portion of the dye is added. The temperature is brought to 82°C (180°F) over a period of 1 hour, during which time the remainder of the dye is added in several small portions. The goods are lifted out before each addition.

Dyeing in a liquor acidified with acetic acid

This method may be used with practically all the basic dyes because, as has been explained, the acetic acid acts as a retarding agent. The bath should contain 8 oz of acetic acid for every 100 gallons of water. The goods are entered cold and the temperature is raised gradually to 82°C (180°F). The dyestuff solution is added in portions during the dyeing operation. The methods which have been described refer essentially to dyeing hanks by hand over poles because this is probably the only form now in which silk is dyed with basic dyes. If piece goods are dyed in modern machines the details of the procedure, such as lifting out, would be varied according to circumstances.

After-treatment

The fastness of basic dyes can be improved by after-treatment with tannic acid, in order to convert the dyestuff into its comparatively insoluble tannic acid salt. The wet-fastness is further improved by the action of an antimony salt which forms an even more insoluble dye-tannic acid-antimony complex. The most convenient antimony compound to use is 'tartar emetic', which is a popular name for potassium antimony tartrate, $2(\text{K}(\text{SbO})_2 \cdot \text{C}_4\text{H}_4\text{O}_6) \cdot \text{H}_2\text{O}$. The treatment is carried out in the following manner: the dyed goods are worked in a bath containing 1 per cent of

their weight of tannic acid for 20 minutes at 60°C (140°F), or alternatively, they may be left in a cold bath overnight. They are then squeezed and transferred to a cold or lukewarm liquor containing a quantity of tartar emetic equivalent to half of the weight of tannic acid used. In this they are worked about for 30 minutes, after which they are rinsed thoroughly and dried.

Dyeing wool with basic dyes

A bath is made up containing 1 to 3 per cent of 40 per cent acetic acid on the weight of the wool. The dye solution, after being strained through a filter, is added, and the goods, which have previously been scoured, are entered. The dyebath is slowly raised to the boil and dyeing is continued for $\frac{1}{2}$ to $\frac{3}{4}$ hour. In the case of Auramine the temperature must not exceed 75°C (167°F). The basic dyes quoted below can be dyed with 2 to 4 per cent of sulphuric acid. This means that they can be applied in combination with acid dyes, provided they are dissolved and added to the dyebath separately so that the two strong solutions never come together. If this should happen, a precipitate could be formed by union of the positive and negative dye ions. Basic dyes which have found some application to wool are:

Rhodamine B	C.I. BASIC VIOLET 10
Rhodamine G	C.I. BASIC RED 8
Victoria Blue B	C.I. BASIC BLUE 2G
Victoria Blue R	C.I. BASIC BLUE 11

Many basic dyes, on wool, are fast to stoving with sulphur dioxide. When they are applied on peroxide-bleached goods and subsequently stoved it is possible to obtain exceedingly bright pale colours. It must, however, be borne in mind that the light-fastness will only be of the order of 1. The clearest shades are obtained by dyeing at 40°C (104°F) for half an hour in a liquor containing 1 to 2 lb of soap per 100 gallons. The following dyes can be applied from a lukewarm soap bath and will withstand stoving:

Rhodamine 6G	C.I. BASIC RED 1
Rhodamine B	C.I. BASIC VIOLET 10
Victoria Blue R	C.I. BASIC BLUE 11

As an alternative to stoving, fluorescent brightening agents may be applied as an after-treatment.

Application of basic dyes to cellulosic fibres

Cellulose has no acidic groups and, therefore, no affinity for basic dyes, and the fibres must be mordanted before dyeing. Basic dyes are, however, very rarely if ever applied to cotton these days, and only a very brief description of the method is needed.

The traditional process was to mordant the cotton with tannic acid. A liquor is made containing a quantity of tannic acid equal to twice the weight

of the dye to be applied. The goods are then entered and the liquor is raised to the boil, when the steam is turned off and the load is allowed to remain in a cooling liquor for a period of not less than 2 hours or, more often, overnight, the reason being that the greatest absorption of tannic acid by the cellulose takes place during cooling. The goods are then taken out and squeezed and the tannic acid is fixed by treatment with tartar emetic. The material is agitated in a cold aqueous solution containing tartar emetic equal to half of the weight of tannic acid used, for a period of 30 minutes, after which fixation is complete and rinsing and hydro-extraction are necessary before dyeing.

Tannic acid mordanted cellulose has a very marked affinity for basic dyes and the dyeing must, therefore, be conducted with great care. The solution of the dyestuff should be divided into three portions. The dye liquor is made up of one portion together with 1 to 2 per cent of 40 per cent acetic acid on the weight of the goods. The load is entered cold and worked for 15 minutes, after which the second portion of the dye is added and the temperature is raised to 37.8°C (100°F). Finally, after 20 minutes at this temperature the last portion of the dye solution is added and the temperature brought up to 71°C (160°F). When dyeing is complete the wet-fastness can be improved with back tanning, by placing the goods in a liquor containing 1 oz per 10 gallons of tannic acid. After immersion, cold, for 30 minutes the material is squeezed or hydro-extracted and transferred to a solution containing $\frac{1}{2}$ oz of tartar emetic per 10 gallons. Although back tanning increases wet-fastness it sometimes alters the shade.

Dyeing with synthetic mordants

Mordanting with tannic acid followed by tartar emetic treatment prior to dyeing is a slow and tedious operation. Synthetic mordants with a direct affinity for cellulose therefore offer a substantial advantage. Such mordants have been prepared by heating phenol with sulphur and a trace of an iron compound. The substances are of complex composition and their constitution has not been established. Some of those which have been in use are known by the names of Katanol, Katanol O, Resistone, and Tanninol BM. These synthetic mordants are not as sensitive to traces of iron or certain other metals as tannic acid, and the dyeings also possess slightly better wet-fastness. The usual method of application is to paste the compound with a little sodium carbonate in cold water, and then add boiling water till the whole has dissolved. The cellulose is then mordanted by immersion for 1 to 2 hours at temperatures between 60° and 90°C (140° and 194°F), according to which of the products is used. With Tanninol BM the addition of 20 per cent of sodium chloride is recommended to assist exhaustion. The goods are then rinsed and dyed with the basic dye at temperatures of 38° to 43°C (100° to 110°F).

15. Acid dyes

THE acid dyestuffs are so called because, in the first place, the original members of the class were applied in a bath containing mineral or organic acid, and, secondly, because they were nearly all sodium salts of organic acids and the anion is the active coloured component. Most of the acid dyes are sulphonic acid salts, but there are a few containing carboxyl groups. They are invariably manufactured as sodium salts, because the free dye acids are more difficult to isolate and they are hygroscopic, which makes them difficult to pack and store. The acid dyes have a direct affinity towards protein fibres and are the main class used in wool dyeing. Most of them will not exhaust on cellulosic fibres but, since they resemble the direct dyes in chemical constitution, there are quite a number which dye cellulose quite well. Polyamide fibres also have an affinity for acid dyes.

The first acid dye was made by Nicholson in 1862, when he sulphonated aniline blue; it was known at that time as Bleu de Lyons (Chapter 1). Other basic dyes were subsequently sulphonated to convert them into acid dyes, making them more easily applicable to wool than the parent basic dyes. Acid Magenta (C.I. ACID VIOLET 19), formula (1), is obtained by the sulphonation of magenta:

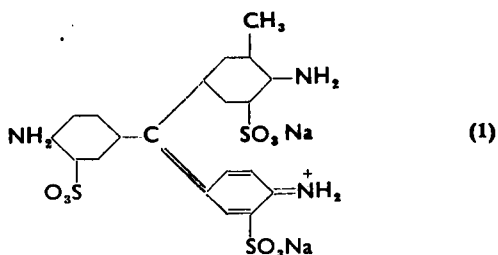

The first acid dye containing an azo group appeared in 1876. It was prepared by coupling diazotized sulphanilic acid with β -naphthol, and was known as Orange II (C.I. ACID ORANGE 7), formula (2):

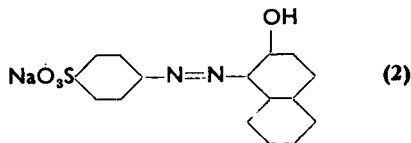

This was the forerunner of the very large group of azo acid dyes.

The acid dyes may be classified, according to chemical constitution, into the following main groups:

Group 1

Derivatives of triphenyl methane. This is the oldest class of which Nicholson's blue was the first example. Of comparatively simple structure is Xylene Blue VS (C.I. ACID BLUE 1), formula (3):

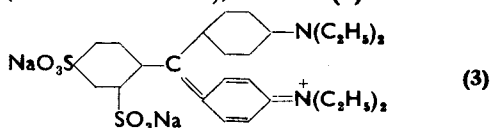

Others belonging to this group are:

Merantine Blue V	C.I. ACID BLUE 3
Kiton Blue A	C.I. ACID BLUE 5
Xylene Fast Green A	C.I. ACID GREEN 7
Lissamine Green SF	C.I. ACID GREEN 5

Group 2

Closely related to the triphenyl methane dyes are those derived from xanthene, formula (4), of which the best known example is Lissamine Rhodamine B (C.I. ACID RED 52), formula (5):

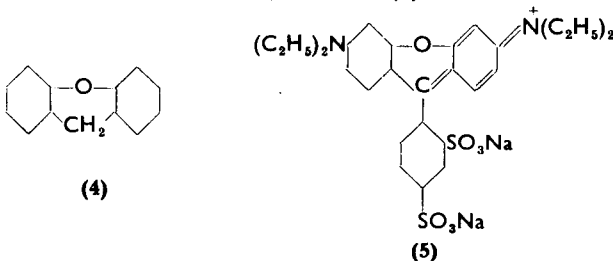

Other xanthene acid dyes are:

Coomassie Violet 2R	C.I. ACID VIOLET 9
Xylene Red B	C.I. ACID RED 52
Lissamine Rhodamine G	C.I. ACID RED 50

Group 3

Nitro dyes are nitrated aromatic compounds which dye protein fibres and are classified as acid dyes. Naphthol Yellow (C.I. ACID YELLOW 1), formula (6), is an example:

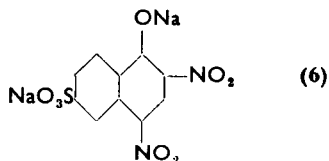

Picric acid, formula (7):

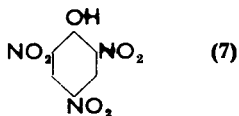

also behaves as a yellow acid dye, probably because the three nitro groups make such a highly conjugated system that the hydroxyl group assumes acidic properties.

Group 4

The discovery of the diazo reaction by Griess in 1858 was quickly followed by the appearance of a very large number of acid dyes containing one or more azo groups. A very simple monazo dye is Azo Geranine 2G (C.I. ACID RED 1), formula (8):

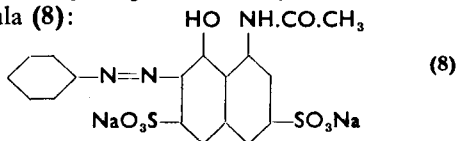

A bisazo dye is Cloth Red 2B (C.I. ACID RED 115), formula (9):

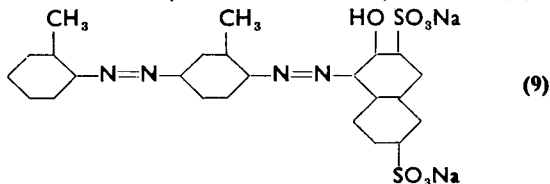

There are not many trisazo members of this class because, as the number of azo groups within the molecule increases, the shades tend to become darker and flatter.

Group 5

The pyrazolone azo dyes constitute an important group which arise from Ziegler's discovery in 1884 that a yellow dye, known as Tartrazine, was obtained by heating phenylhydrazine-*p*-sulphonic acid with dihydroxy tartaric acid:

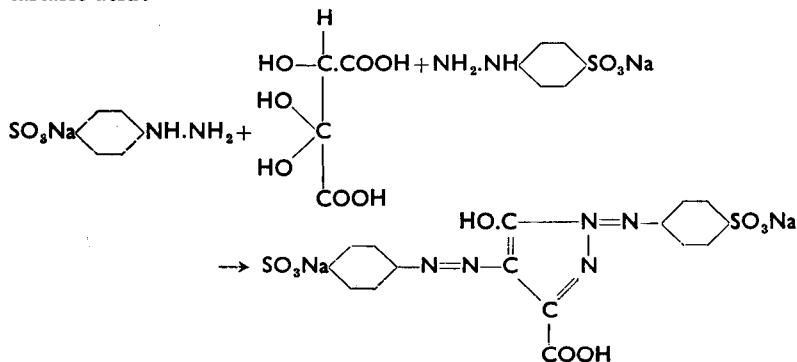

Other examples are:

Fast Light Yellow BG	C.I. ACID YELLOW 13
Flavazine	C.I. ACID YELLOW 41
Kiton Yellow S	C.I. ACID YELLOW 27
Xylene Light Yellow 2GL	C.I. ACID YELLOW 17

The characteristic of these dyes is comparatively good light-fastness combined with ease of application.

Group 6

Acid dyes derived from anthraquinone commenced to appear in 1890 and have proved valuable on account of their greater fastness. Solway Blue B (C.I. ACID BLUE 45), formula (10):

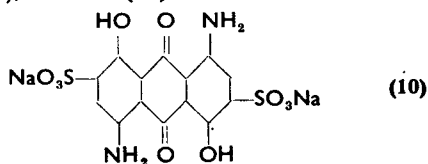

is an example and it is prepared by sulphonating dihydroxyanthraquinone, nitrating the resultant sulphonic acid, and reducing the nitro to amino groups. A few other anthraquinone acid dyes are:

Alizarine Light Blue SE	C.I. ACID BLUE 43
Alizarine Light Red R	C.I. ACID RED 80
Polar Brilliant Blue GAW	C.I. ACID BLUE 127

Group 7

This consists of the phthalocyanine dyes, an example of this group being Coomassie Turquoise Blue 3G. This is a trisulphonated derivative of copper phthalocyanine. It dyes wool a very bright greenish blue shade. Its fastness to light is better than the triphenylmethane acid dyes which alone will give comparable shades.

Many of the acid dyes containing azo and sulphonic groups are closely related, structurally, to the direct cotton colours and there is no clear dividing line between those suitable for protein fibres and those which will dye cellulose well. Chloramine Red B (C.I. DIRECT RED 39), for instance, is a direct colour which will dye wool equally effectively. Some of the acid dyes with a marked affinity towards cellulosic fibres are:

Naphthalene Black D	C.I. ACID BLACK 7
Coomassie Brilliant Blue R	C.I. ACID BLUE 83
Coomassie Green T	C.I. ACID GREEN 19
Coomassie Fast Grey G	C.I. ACID BLACK 48
Coomassie Navy Blue G	C.I. ACID BLUE 118
Viscolan Black B	C.I. ACID BLACK 29
Sulphonine Red 3B	C.I. ACID RED 134

Effect of acids

The most significant assistant in the application of these dyes is the acid added to the dyebath. Many acid dyes will not exhaust on wool at all unless the dyebath has been acidified. If, for example, wool is boiled gently for half an hour with 5 per cent of Acid Magenta, it is only faintly stained. When 4 to 5 per cent of sulphuric acid is also added, however, the wool is dyed a heavy shade, and exhaustion is virtually complete. Some experiments reported by Lister (*J.S.D.C.*, 1949, 98) show the relationship between acid and exhaustion of Azo Rhodine 2G (C.I. ACID RED 1) and Xylene Fast Yellow P (C.I. ACID YELLOW 61) on purified wool.

Table 15.1

<i>Sulphuric or acetic acid in dyebath per cent on weight of wool</i>	<i>Percentage exhaustion in 5 minutes</i>	
	<i>Azo Rhodine 2G (H₂SO₄)</i>	<i>Xylene Fast Yellow P (CH₃COOH)</i>
0.0	31	57
0.2	39	62
0.4	39	69
0.6	50	71
0.8	57	72
1.0	80	75

These figures are also interesting because they show the nature of the relationship between amounts of acids and the adsorbing capacity of wool for acid dyes. Not only is the total amount of dye adsorbed influenced by the amount of acid, but the rate of exhaustion is also dependent upon acidity.

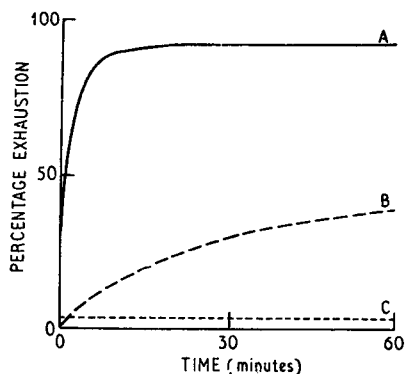
**Fig. 15.1** Effect of acids on exhaustion of acid dyes

This is illustrated in the exhaustion curves for Solway Blue BS, Fig. 15.1,

in which curves *A*, *B*, and *C* were dyed with 3 per cent of sulphuric acid, with 3 per cent of acetic acid, and with no acid, respectively (VICKERSTAFF, *Physical Chemistry of Dyeing*, p. 348).

Glauber's salt ($\text{Na}_2\text{SO}_4 \cdot 10\text{H}_2\text{O}$)

This is used as a levelling agent with many acid dyes. The effect of Glauber's salt on the distribution of Disulphine Blue V between the fibre and the solution is shown in Table 15.2 (VICKERSTAFF, *loc. cit.*).

Table 15.2

<i>Glauber's salt concentration</i>	<i>Ratio of dye in liquor/dye on fibre</i>
0.000	3.2
0.003N	4.8
0.016N	7.0
0.030N	12.8

The retarding action of sodium sulphate or other salts, however, is only effective at low *pH* values. With every dye there is a critical *pH*, above which electrolytes have the reverse effect and promote exhaustion. If, for example, Solway Green G is dyed in a neutral liquor, an increase in the amount of sodium chloride present leads to greater exhaustion as shown:

<i>Percentage of salt on weight of wool</i>	<i>Percentage exhaustion of Solway Green G</i>
0	28
1.2	32
6	37
30	48

When dyed in an acid dyebath the salt acts as a retarding agent.

From the point of view of application the acid dyes fall into three groups:

Class 1

Dyes requiring strong acid, such as sulphuric acid, to be added to the dyebath to bring the *pH* to 2 to 3 for satisfactory exhaustion. Level dyeing is assisted if, for compound shades, dyes exhausting as nearly as possible at the same *pH* are chosen. These dyes are often referred to as the molecularly-dispersed acid dyes, because of their state when in solution. Also, because of their good dyeing properties, they are known as the level-dyeing

acid dyes. As a group their light-fastness is generally quite good but their wet-fastness is not entirely satisfactory, as shown in Table 15.3.

Table 15.3

Dye	C.I. number	Light-fastness	Wash-fastness effect on dyeing S.D.C. Test 3, 1950
Lissamine Fast Yellow 2G	ACID YELLOW 17	6-7	2
Tartrazine	ACID YELLOW 23	4	2
Naphthalene Fast Orange 2G	ACID ORANGE 10	4-5	1
Azo Geranine 2G	ACID RED 1	5	3
Lissamine Fast Red BG	ACID RED 37	5-6	2
Solway Purple R	ACID VIOLET 43	5	1
Solway Blue BN	ACID BLUE 45	5-6	2

Many molecularly dispersed acid dyes have better wet-fastnesses than those in the few examples quoted, but the comparatively good light-fastness, coupled with a tendency to inadequate wet-fastness, is illustrated in Table 15.3. When selecting dyes for a shade requiring two or more colours, it is important to avoid including one which is markedly more fugitive than the others, so that the fading or loss of colour will be on tone. A brown shade consisting of blue and yellow dyes which are adequate but a red which is not, will turn green on washing. This change in the nature of the colour is much more objectionable than an equal loss of depth of all of the three components.

Class 2

Acid dyes applied from a weakly acid liquor in which the pH range is between 5.2 and 6.2. Glauber's salt should not be used with these dyes because, when the pH is above 4.7 the addition of electrolytes may accelerate instead of retarding exhaustion. It is customary to apply these dyes with acetic acid. The following relationship between the percentage of 80 per cent acetic acid on the weight of goods, gives an approximate guide to the pH value of the dye liquor under normal works conditions. It must only be used as a rough guide because much will depend upon liquor ratio and, above all, the alkalinity or acidity of the goods entering the dyebath.

Percentage acetic acid (80 per cent)	pH value
0.5	6.5-7
1.0	5.3-5.5
1.5	5.0-5.3
2.0	4.7-5.0
2.5	4.4-4.7

These dyes are less level dyeing and more prone to form colloidal solutions

than the molecularly-dispersed group. A few typical examples with their light- and wash-fastnesses are shown in Table 15.4.

Table 15.4

<i>Dye</i>	<i>C.I. number</i>	<i>Light-fastness</i>	<i>Wash-fastness change of shade S.D.C. Test 3, 1950</i>
Xylene Fast Yellow P	ACID YELLOW 61	5-6	4
Xylene Fast Red P	ACID RED 118	5-6	4
Alizarine Fast Blue 2BG	ACID BLUE 82	5-6	3
Erio Anthracene Brilliant Blue BFF	ACID BLUE 129	5-6	2-3
Alizarine Fast Grey G	ACID BLACK 50	4-5	3

Class 3

These acid dyes, applied from a neutral liquor, are colloiddally dispersed in solution at lower temperatures, although it is probable that the majority of them assume a state of molecular dispersion at temperatures near the boil. They are not level-dyeing and their application demands a considerable measure of care. They are often referred to as the 'fast acid dyes' or the 'acid milling dyes' because, originally, they were used in cloths which were to be milled. They are also sometimes called the neutral dyeing acid dyes. They possess good light- and wet-fastnesses as shown in Table 15.5.

Table 15.5

<i>Dye</i>	<i>C.I. number</i>	<i>Light-fastness</i>	<i>Wash-fastness S.D.C. Test 3, 1950</i>
Coomassie Yellow R	ACID YELLOW 42	4-5	4-5
Coomassie Fast Orange R	ACID ORANGE 33	4-5	4
Acid Milling Red G	ACID RED 97	4	3
Sulphonine Red RS	ACID RED 99	5	3-4
Xylene Milling Blue GL	ACID BLUE 102	4	3
Coomassie Navy Blue GN	ACID BLUE 120	5	3-4
Coomassie Fast Black B	ACID BLACK 24	6	3-4

A special group, linked with the fast acid dyes in their properties, are the Carbolan colours. These are usually comparatively simple azo dyes of the level-dyeing type in which the molecular weight has been increased by

attaching an alkyl side chain, e.g., Carbolan Green G (C.I. ACID GREEN 27), formula (11):

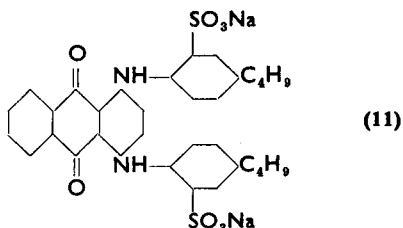

Relationship between structure and wet-fastness

The first serious contribution to an understanding of the relationship between structure and fastness was made by Speakman and Clegg (*J.S.D.C.*, 1934, 349). They concluded that the higher the molecular weight of an acid dye, the greater would be the tendency for it to form molecular aggregates. This increase in molecular weight is associated with the properties of the neutral-dyeing acid dyes. Increasing the number of sulphonic acid groups, on the other hand, favoured molecular dispersion in solution. This generalization did not explain all the facts, and further progress was made when it was realized that the shape of the molecule, as well as its size, was an important factor. The planar configuration of azo dyes derived from benzidine not only confers an affinity for cotton, but also gives to acid dyes higher wet-fastness than would be expected from molecular weight considerations alone. It is probable that there is greater opportunity for hydrogen bonds and Van der Waals forces to come into play when the molecule can present a comparatively flat surface to the fibre.

It has been suggested by Derbyshire (*Hexagon Digest*, No. 21) that adsorption is influenced by polar and Van der Waals forces in the manner illustrated in a purely diagrammatic manner as shown in Fig. 15.2. If

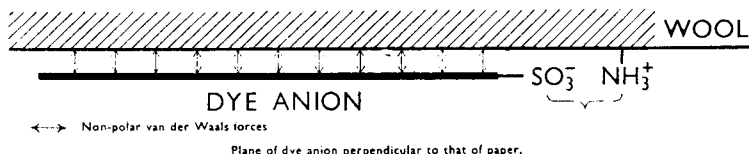
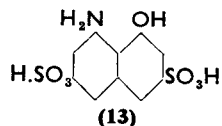
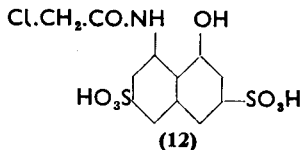

Fig. 15.2 Dye adsorption by non-polar Van der Waals' forces
(Courtesy I.C.I. *Hexagon Digest*, No. 21)

such a form of attachment does, in fact, exist it is obvious that planar structure will have a very significant influence on the fastness of acid dyes.

Efforts have been made to combine greater wet-fastness with the ease of application of the molecularly-dispersed acid dyes. Dyes of low molecular weight are improved by introducing an ω -chloroacetyl amino group (KNIGHT, *J.S.D.C.*, 1950, 66, 37). Thus the wet-fastness of Azo Geranine

2G is considerably better if ω -chloroacetyl H acid, formula (12), is used as a coupling component instead of H acid, formula (13).



Improved resistance to washing and wet treatment has also been obtained by introducing an $\text{SO}_2\text{.NH.CH}_2\text{.CH}_2\text{Cl}$ group into the molecule (KNIGHT, *loc. cit.*).

Theory of dyeing

There is abundant evidence to show that the basic mechanism in dyeing protein fibres with acid dyes is salt formation with amino groups, although there are several secondary effects which have sometimes confused the picture. Reduced to its simplest terms, the protein fibre may be regarded as a matrix studded with —NH_3^+ groups which attract the negatively charged dye anions:

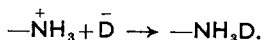

Steinhardt and Harris (*J. Res. N.B.S.*, 1940, 24, 335) studied the quantitative behaviour of wool towards acids and alkalis. They showed that wool had a definite maximum acid-binding capacity, irrespective of the acid, equivalent to 0.82 millimol per g, although this figure is now regarded as being somewhere within the range of 0.8 to 0.9. Wool, when immersed in an excess of free dye acids until equilibrium has been established, does absorb quantities which approximate to 0.8 to 0.85 millimol per g in those containing one sulphonic acid group and, as would be expected, half of this amount when the acid is dibasic. The adsorption isotherm for wool with Solway Blue B is shown in Fig. 15.3 and corresponds with the curve typical of a dye adsorbed at specific sites. The saturation values for Solway Blue B are 0.94 mg and 0.72 milli-equivalents per g of fibre at pH 1.35 and pH 1.6 respectively; reasonably close agreement with the combining power of wool of between 0 and 0.9 milli-equivalents per g. If the primary amino groups provide the sites at which the dye anions are attached, the removal of them by diazotization followed by boiling should reduce the affinity. In the past there has been much confusion because various workers reported that deamination did not alter the affinity significantly. Speakman and St

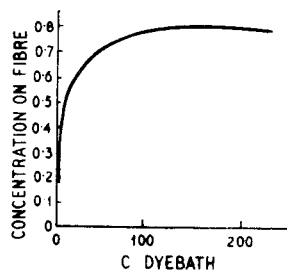

Fig. 15.3 Adsorption isotherm for Solway Blue B at pH 1.6
(Courtesy of SKINNER and VICKERSTAFF, 'J.S.D.C.', 1945)

(*J.S.D.C.*, 1934, 50, 342) showed that it was very difficult to remove the primary amino groups from wool completely, and previous workers had also failed to do so. When they applied drastic conditions to bring about deamination they were able to demonstrate a decreased affinity for acid dyes and, conversely, an increased affinity for basic dyes on account of the liberation of more carboxyl groups.

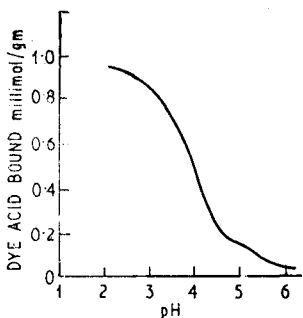

Fig. 15.4 General relationship between pH and adsorption of dye acids by wool

The function of acid in the dye bath requires examination. Casual consideration would suggest that its purpose is to liberate dye acid so that it can combine with the basic groups. This simple explanation does not suffice, because the quantity required to bring about maximum exhaustion exceeds the amount necessary to liberate the dye acid. It has also been demonstrated on many occasions that the fixation of the pure dye acid on the wool is governed by the pH value (see Table 15.1). This is also illustrated in the curve shown in Fig. 15.4 which shows the capacity of wool to adsorb dye acids at different pH values (STEINHARDT, FUGITT, AND HARRIS). Within its isoelectric range the wool fibre contains salt links of the type



These are electrically neutral. The presence of hydrogen ions leaves a net positive charge,



and therefore a system capable of attracting the dye anions:

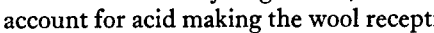

This explanation of the function of hydrogen ions, created when the liquor is acidified, could account for acid making the wool receptive to dye anions, but it fails to answer the question as to what has happened to the anions of the added acid. The system wool, dye ions, hydrogen ions, and chlorine ions was studied by Elöd (*Trans. Farad. Soc.*, 1933, 29, 327) in a dye bath in which hydrochloric acid was used. The findings are summarized in graphical form in Fig. 15.5 (VICKERSTAFF, *Physical Chemistry of Dyeing*). It is apparent from curves B and C that in the initial stages there is rapid adsorption of both H and Cl ions. The Cl ions are more mobile than the dye anions, and it is to be expected that they would reach the positively-charged sites in the fibre first:

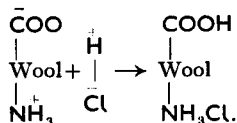

It is obvious, however, from curves *B* and *C* that there is subsequently a gradual replacement of chlorine by dye ions in the fibre. It is not easy to understand why the slower-moving dye ions should succeed in replacing the chlorine. It has been suggested that when they reach the sites their electrostatic attraction is enhanced by other forces, such as hydrogen bonds and Van der Waals forces, giving, in total, a binding force greater than that of the chlorine. There is some confirmation of the existence of such secondary attraction because acid dyes with planar structural configuration have greater wet-fastness.

The preceding explanation suffices for the molecularly-dispersed dyes, but fails to account for the dyeing properties of the acid dyes applied from neutral liquors. Neutral-dyeing acid dyes give the Freundlich isotherm, namely, the curve corresponding with adsorption due to physical surface forces (see Fig. 12.16, Chap. 12). As a rule the fast acid dyes have larger molecules and, also, a high degree of planarity so that they present abundant opportunities for hydrogen bonding and Van der Waals forces to come into play. Derbyshire (*Hexagon Digest*, No. 21) suggests that the non-polar forces are the more important in retaining the dye on the fibre. If this is so it will explain the observation of Speakman and Clegg that fastness was proportional to molecular weight.

Action of electrolytes

The retarding effect of sodium sulphate in the application of molecularly-dispersed dyes has already been referred to. It must be emphasized that the effect is only apparent when dyeing at low *pH* values, and in neutral solutions the presence of electrolytes accelerates adsorption. The explanation which is usually accepted is that when the concentration of anions in the liquor is increased, there is more competition for the positive sites on the fibre:

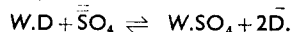

That the equilibrium is reversible, is demonstrated by the fact that dyed wool is boiled in a strong solution of sodium sulphate, a large proportion of the dye will be extracted from the fibre. In the case of the acid dyes which are applied in neutral or faintly alkaline liquors, the effect of electrolytes is reversed and they promote exhaustion. It has been suggested that the wool is negatively charged, thus tending to repel the negatively charged anions. The presence of electrolytes reduces the neg-

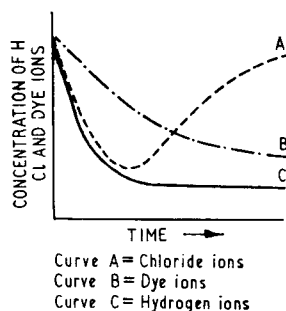

Fig. 15.5 Diagrammatic representation of Elöd's experiment on rate of adsorption of ions by wool in an acid dye bath

(Courtesy of VICKERSTAFF, 'The Physical Chemistry of Dyeing')

potential of the fibre, making easier the approach of the dye ion to within the zone of influence of the retaining forces.

Effect of temperature

The rate of adsorption of acid dyes is influenced to a great extent by temperature. There is practically no transfer to the fibre with any of them below 39°C (102°F). From this temperature upwards the rate of adsorption increases, but each dye has its own range over which adsorption is at its maximum. In the case of the acid milling dyes there is, as a rule, practically no dyeing below 60°C (140°F), but there is often a critical period at about 70°C (158°F), where the transfer from dye liquor to the fibre is extremely rapid. It is important, in bulk dyeing, that particular care should be taken to ensure that the rate of rise of temperature is slow over the critical phase.

Application of acid dyes

The acid dyes are relatively easy to dissolve, but care is necessary to avoid the possibility of undissolved particles becoming deposited on the goods. Some of the fast acid dyes can be a little troublesome to bring into solution. The requisite amount of dyestuff is made into a smooth paste, preferably with a small amount of an anionic or non-ionic wetting agent, and sufficient boiling water is added to dissolve it completely. It is advisable to strain the dye solution before adding it to the dyebath. When dyeing heavy shades it is often necessary to dissolve several pounds of colour and, in such cases, preparing the solution in a separate vessel and straining can take a long time. It is better to run about 2 ft of water into the bottom of the machine, add the dye, turn on the steam and boil vigorously for a few minutes, after which the dyebath is filled up with cold water before the goods are entered.

The wool must be well scoured before dyeing. For pale shades it is often necessary to bleach with hydrogen peroxide. Unshrinkable finishes based on hypochlorites and hydrochloric acid are usually applied after dyeing because the treated wool has an increased affinity for most dyes, and chlorination tends to be irregular, giving rise to uneven dyeing. There are many unshrinkable processes which exercise a more uniform action on the fibres and can be applied before dyeing. When the goods have passed through any process in which they are acidified before they are dyed, it is extremely important that the acid should be well neutralized. Provided that there is no residual soap, as is always the case when synthetic detergents are used, the acid dyes can, with one or two exceptions, be applied, using water of moderate hardness without softening. The exceptions are a limited number of dyes, mostly in the neutral-dyeing group, which form insoluble calcium or magnesium salts.

There are many different ways in which the acid dyes are applied, the variations being designed, in the main, to create conditions giving liquors with a range of pH values to suit the type of dye.

Method 1 The bath is made up containing:

10 to 20 per cent on the weight of goods of Glauber's salt crystals
 2 to 4 per cent " " " " " " Sulphuric acid 168°Tw
 (98 per cent)

or

2 to 4 per cent " " " " " " Formic acid (85 per cent)

The temperature is raised to 40°C (105°F) so that the wool will wet out readily. The goods are then entered and it is desirable to run them in this liquor for 10 to 20 minutes so that any local variations in pH value which they may contain, can be equalized. The dissolved dye is then added and the liquor is raised to the boil over a period of 45 minutes, and is maintained at the boil for $\frac{3}{4}$ to 1 hour when dyeing should be complete. It has been found that with the molecularly-dispersed acid dyes, better results are obtained if the temperature is raised slowly to 50°–60°C (120°–140°F) and held at this till all the dye has been exhausted. The liquor is then rapidly raised to the boil, at which temperature dyeing is continued for a further $\frac{3}{4}$ to 1 hour to allow levelling of the shade through migration. If further additions are necessary to bring the shade to the pattern, this can be done at the boil provided that suitable dyes, often referred to as 'salting colours', are selected.

These dyes however, because they are extremely level dyeing, do not possess good wet-fastness. For this reason, when the shade is being dyed with faster colours, it is undesirable for correction of tone to use more than a very small proportion of the dyes that can be added at the boil. Additions of less level-dyeing dyestuffs should only be made after the dye liquor has been cooled to 60°C (140°F) and a closed coil heating system, through which cold water can also be run, is of great assistance because it makes it possible to alter the temperature of the dyebath at will without affecting liquor ratio, or the concentration of acid and other assistants.

Method 2 The dye liquor is made up with 10 to 15 per cent of Glauber's salt crystals and 3 to 5 per cent of acetic acid (30 per cent). The temperature is raised to 40°C (105°F) and the goods are entered and, if possible, run for 10 to 20 minutes to equalize their pH. The dye is then added and the liquor is raised to the boil over a period of 45 minutes. Boiling is continued, and after 40 to 45 minutes exhaustion may be completed by slowly adding a further 1 to 3 per cent of acetic acid (30 per cent), 1 per cent of sulphuric acid 168°Tw (98 per cent), or 1 per cent of formic acid (85 per cent). This method would be used for dyes of the type in Table 15.5 and, if further additions of dyestuffs of this class are necessary to correct the shade, the liquor should be cooled.

Method 3 The liquor is made up with a quantity of ammonium acetate or ammonium sulphate equivalent to 2 to 4 per cent on the weight of the

wool. The goods are entered at 40°C (105°F) and run for a period before the liquor is raised to the boil over a period of $\frac{3}{4}$ hour. Boiling is continued for $\frac{3}{4}$ to 1 hour. The method is used in the application of neutral-dyeing acid dyes of the type included in Table 15.5. It will be observed that no Glauber's salt is added to the liquor, because the dyeing is conducted in the pH range where electrolytes increase the rate of adsorption instead of acting as retarding agents. The function of the ammonium sulphate is to assist exhaustion by bringing about a slow liberation of acid at a uniform rate. Ammonium salts hydrolyse in water to a limited extent:

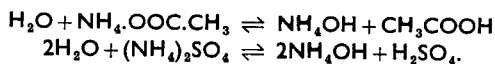

The ammonium hydroxide, at the boil, decomposes with the liberation of ammonia which is evolved with the steam leaving the acid.

The behaviour of ammonium salts in boiling aqueous solution has been studied by Peryman (*J.S.D.C.*, 1955, 71, 165) and his investigation suggests that the foregoing explanation is an over-simplification. There is a shift of pH values towards the acid region as the temperature rises from cold to 100°C, without the loss of any ammonia as shown in the figures below:

Composition of solution	pH at room temperature	pH at 40°C	pH at 60°C	pH at 80°C	pH at 100°C
					by extrapolation
(NH ₄) ₂ SO ₄ 6 g/litre	5.49	5.34	5.20	5.03	4.9
CH ₃ COONH ₄ 3.5 g/litre	6.96	6.77	6.60	6.38	6.2
NH ₄ Cl 5.4 g/litre	5.27	5.02	4.79	4.5	4.3

Ammonium sulphate is a salt readily available on a commercial scale. Ammonium acetate, however, is very deliquescent and is more often prepared, as required, in the following manner. The necessary amount of acetic acid is well diluted with water in a bucket or other suitable vessel. Ammonia, diluted with its own volume of water, is then poured into the acid slowly with constant stirring until litmus or any other indicator just gives an alkaline reaction. The solution of ammonium acetate, prepared in this manner, is added directly to the dyebath.

The use of ammonium phosphates or phosphoric acid for adjustment of the pH value of the dyebaths has been recommended (E. I. NOBLE, *Textile J. of Australia*, 1944, 19, 71). It is claimed that, because of the buffering action of phosphates, phosphoric acid neutralizes variations in alkalinity remaining after scouring, more effectively than do other acids. Scoured wool is usually alkaline and, with dyes other than the most levelling, it is extremely important that the acid in the dyebath should bring the whole of the load to a state of uniform pH value before any adsorption of dye takes

place. The buffering effect of phosphates gives more gradual and therefore more uniform transition from alkalinity to acidity, as illustrated by the series of progressively more alkaline salts formed, in contrast with the more abrupt change with other acids:

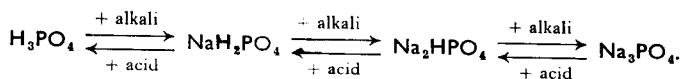

When this acid is substituted for others

2.0 per cent of 75 per cent phosphoric acid equals

1 per cent sulphuric acid

1.6 per cent of 75 per cent phosphoric acid equals

1 per cent formic acid (85 per cent)

0.8 per cent of 75 per cent phosphoric acid equals

1 per cent acetic acid (80 per cent).

A further refinement which is now commonly used is to commence dyeing with 2 to 5 per cent of ammonium phosphate, or an ammonium hydrogen phosphate, so that the liberation of phosphoric acid shall be gradual.

Migration

The molecularly-dispersed acid dyes give level shades because they migrate in a boiling liquor. This means that molecules attached to the fibre are constantly becoming unattached and being refixed on another site. There is, therefore, a perpetual movement of the dye within the fibres so that, in time, complete randomization takes place and the distribution is uniform. This phenomenon is known as migration and can be demonstrated by boiling a piece of white wool with a dyed sample in a liquor containing the customary dyebath quantities of acid and electrolyte. There will be considerable transfer of colour from the dyed to the undyed wool and, if the dye is one rated good for migration, the two pieces will, in time, be the same shade. With migrating dyes it does not matter if the initial adsorption of colour is irregular because boiling will correct this.

In 1928 C. M. Whittaker first drew attention to the importance to the practical dyer of information about migrating power, rate of exhaustion in relation to temperature, and salt sensitivity of direct cotton dyes. Whittaker and those who collaborated with him did invaluable work on the classification of direct dyes in accordance with their dyeing properties. There was, however, a time lag before a similar approach was made to wool dyeing, and one of the earliest publications is that of Ris, Stocker, and Thommen. These authors collected observations from which they made curves relating exhaustion with time and temperature, and others showing migration and rate of exhaustion of 'salting on' colours in an acidified boiling dyebath.

The information for the exhaustion curves related to time and temperature were arrived at in the following way. The dyeing was commenced at

40°C (105°F) and continued at this temperature for 15 minutes. Heat was then applied so that the temperature of the liquor rose by 1°C (1.8°F) every minute, reaching the boil in 60 minutes, making a total time of 75 minutes from the commencement of the test. The dyeing was continued at the boil for a further 60 minutes. Eight dyeings were made under these conditions in eight separate beakers. One dyeing was removed from a beaker every

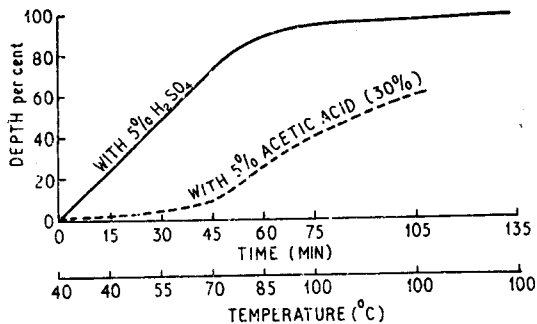

Fig. 15.6 Effect of acids on exhaustion of Erio Anthracene Brilliant Blue 4GL

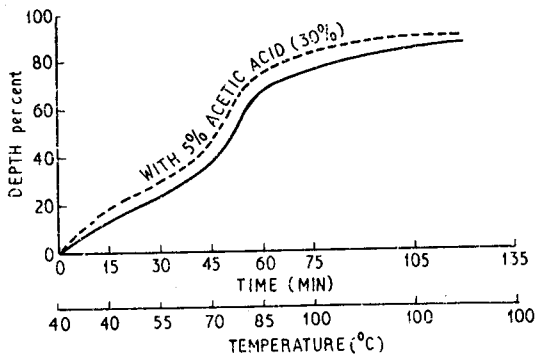

Fig. 15.7 Effect of acetic acid on exhaustion of Polar Yellow R

15 minutes until the liquid boiled after which they were removed at 30-minute intervals. The amount of dye adsorbed was assessed by comparing the colour of the material with standard dyeings. Graphs for Erio Anthracene Brilliant Blue 4GL (C.I. ACID BLUE 23), which is extremely level-dyeing, and for Polar Yellow R (C.I. ACID ORANGE 63), are shown above in Fig. 15.6 and 15.7. With Erio Anthracene Brilliant Blue 4GL the curve shows adsorption at a steady rate until, after 60 minutes, it is complete, when the temperature has reached 85°C (185°F) (with sulphuric acid). With acetic acid the dye is taken up much more slowly and exhaustion only reaches 80 per cent after 135 minutes. Polar Yellow R cannot be dyed

with sulphuric acid, but with acetic acid practically the whole of the dye is taken up between the temperatures of 55° and 85°C (131° and 185°F). In the case of Polar Brilliant Blue GAW (C.I. ACID BLUE 127) exhaustion proceeds from 30 per cent to 70 per cent between 70° and 85°C (158° and 185°F). These facts demonstrate the importance of controlling the rate at which the temperature increases over its critical range when applying the fast acid dyes.

Migration is a factor which must be taken into account in selecting the best dyes for the purpose. The test used by Ris *et al.* was to boil three dyed pieces with undyed material of equal weight in three separate beakers. A blank dye liquor was used, containing all the additions except the dye-stuff. The samples were withdrawn from the three beakers in turn at intervals of 30, 60 and 90 minutes, and the amount of colour on the dyed and undyed samples assessed. From this information curves of the type shown in Fig. 15.8 and 15.9 are obtained. In each case the loss of depth of

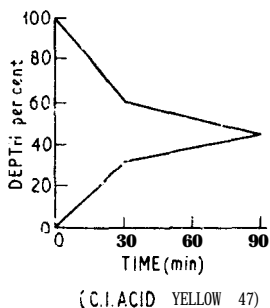

Fig. 15.8 Migration curve at 100°C

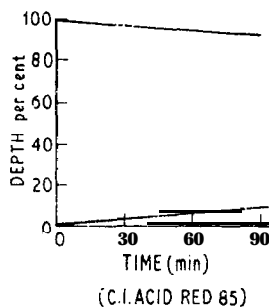

Fig. 15.9 Migration curve at 100°C

the dyed specimen is recorded in the top curve, and the bottom one represents the colour adsorbed by the white sample. In the case of Erio Flavine 4G, after 30 minutes about one-third of the dye had been transferred, after 60 minutes about 40 per cent, and at the end of 90 minutes the two pieces were virtually the same shade. This is an example of a dye with excellent migrating power, and it is obvious that extreme lack of uniformity of dye distribution in the early stages of a dyeing will be corrected by prolonged boiling. In the case of Polar Red G, on the other hand, there is practically no migration, therefore the two curves show very little sign of approaching each other. In this case migration is bad and extreme care must be taken in the dyeing to ensure that adsorption of the dye is uniform.

The description of the effect of temperature on the adsorption of acid dyes appears to lead to the conclusion that the best results will be obtained if the dyebath is allowed to come from 40°C (105°F) to the boil very slowly, Goodall (*J.S.D.C.*, 54, 47) disputed the universal validity of this assumption. He considered the behaviour of acid dyes of the three types already

referred to, namely, (*a*) those molecularly dispersed at low temperatures, (*b*) those colloiddally dispersed at low temperatures but in molecular dispersion at higher temperatures, and (*c*) dyes colloiddally dispersed at both low and high temperatures. Those of class (*a*) are level-dyeing and possess good migrating property because the comparatively small dye anion can pass into and out of the fibre easily. The dyes of class (*b*) possess good levelling properties at high temperatures, and those of (*c*), owing to the large size of the colloiddal aggregate, do not pass into and out of the fibre easily at any temperature. They have a marked tendency towards unlevel dyeing, but possess good wet-fastness.

There is marked increase in the rate of swelling of the wool above 40°C (105°F), and this increases the accessibility of the fibre to large molecules or aggregates. Furthermore, the smaller the dyestuff aggregate the more readily will it migrate and establish equilibrium throughout the mass of the material. It was suggested by Goodall that, with dyes of class (*c*), and possibly to a lesser extent with those of class (*b*), the conditions under which they are applied should be such that their state of aggregation approaches as closely as possible to that of those which are molecularly dispersed; also, the fibres should be in a swollen state to assist in freedom of movement. This involved entering the goods into a dyebath which was virtually at the boil and excluding the use of Glauber's salt, the effect of which is to encourage aggregation. The method recommended for practical use was to raise the liquor to the boil, add ammonium sulphate (usually 3 per cent) and 0.2 to 0.5 per cent of ammonia (sp gr 0.880). Turn the steam off and enter the goods when there was a drop in the temperature, usually to between 88° and 90°C (190° and 194°F), at which the goods are run for 10 minutes before steam is turned on again to raise to the boil. Dyeing was continued at the boil for 1 hour and, as a result of a number of bulk trials which had been made, it was claimed that very satisfactory results could be obtained in practice.

Dyebath assistants

Apart from acids and Glauber's salt, probably the oldest levelling assistant used with acid dyes was pyridine. A property of pyridine is that it possesses a very powerful solvent action on acid dyes, and, for this reason, has a tendency to break down aggregates. Its levelling power may be attributed to both its solvent action, which not only encourages molecular dispersion, but at the same time makes the aqueous phase more attractive to the dye, and also to the fact that it is a base which combines with the free acid and liberates it slowly at the boil by hydrolysis and volatilization of the pyridine. In the latter respect its behaviour is very similar to that of ammonia. Pyridine has now been replaced by a variety of surface-active compounds. One of the earliest to appear was Calcolene Oil HS, a highly sulphonated oil, and it was recommended that $\frac{1}{2}$ lb per 100 gallons should be added to the

dyebath when goods were difficult to penetrate. There are now a great number of surface-active compounds, mostly sulphonic acids or sulphuric acid esters of long-chain alkyl compounds, which are used to assist penetration. A few examples are:

Lissapol C	Oleyl sodium sulphate
Lissapol LS	Sodium oleyl <i>p</i> -anisidine sulphonate
Albatex PO	Anionic surface-active compound.

Non-ionic surface-active compounds have also been recommended, provided that they are stable in boiling water. By reducing surface tension both the anionic and non-ionic compounds assist in the penetration of water, which is the vehicle for carrying the dyestuff into the fibre. They also may, to some extent, break up the aggregates of those dyes which are in a colloidal state, and there may be some competition between the ions of the dye and those of the anion active assistant for the positively charged sites. A more recent development has been the introduction of restraining agents possessing both cationic and non-ionic components within the same molecule. Dispersol CWL, for example, is described as an aqueous solution of an ethylene oxide condensate possessing cationic properties. These products have a general formula corresponding with:

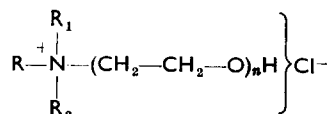

The nitrogen assumes cationic properties and forms a complex with the dye anion. The non-ionic ethylene oxide condensate portion of the molecule keeps the addition product in a state of solution. The wool has no affinity for the dye anion which is complexed with the nitrogen atom at low temperatures. As the liquor becomes hotter the dye anions are gradually released. Not only does it follow that the dye becomes available at a steady and slow rate, but also the release takes place at higher temperatures when the fibre is more swollen and the dye aggregates are broken down.

There are quite a number of water-soluble esters, such as ethyl formate, diethyl tartrate, and ethyl lactate, which hydrolyse in a boiling dye liquor with the liberation of the organic acid and the alcohol, most of which distils away in the steam. The use of such esters in the application of acid dyes to wool has been described by Hannay and Major (*J.S.D.C.*, 1953, 69, 195). The only ester which found practical application was ethyl lactate, which was marketed as 'Estrocon'. The method was particularly successful in dyeing yarn in package form with fast milling or Carbolan colours. The bath was made up with 0.5 to 1 per cent of ammonia, and between 1 and 2.5 per cent of ethyl lactate, according to the depth of the shade and the dyestuff. The ammonia brought the pH value to between 8 and 9, thereby

retarding the initial rate of strike. As the temperature increased the ammonia volatilized and the lactic acid was liberated gradually. There is no doubt that the method did give very good results with dyes normally difficult for levelling, but it did not find widespread use, possibly on account of the comparatively high cost of the ester.

When dyeing with the molecularly-dispersed acid dyes most shades can be matched with a very limited number of colours such as:

Solway Blue PFN

Kiton Fast Yellow 2GL C.I. ACID YELLOW 17

Lissamine Fast Red BG C.I. ACID RED 37.

Particularly bright pinks require Lissamine Rhodamine G (C.I. ACID RED 50) or Lissamine Rhodamine B (C.I. ACID RED 52), and for extremely vivid yellows Lissamine Flavine FF (C.I. ACID YELLOW 7) is used. Most of the dyes in this group can be used in combination with each other in shades where mixtures are necessary for matching. With the fast acid dyes it is not so easy to match shades with mixtures. Their tendency is towards uneven adsorption, and if the distribution of two or more components is not uniform, the differences in tone of the colour are much more apparent than equivalent differences in depth. The best results are, therefore, obtained by selecting a self-colour which matches the pattern or, if this is impossible, one which is so close that only a very small proportion of another dye is necessary.

Levelling uneven dyeings

From time to time a dyeing may be unsatisfactory from the point of view of levelness, and it becomes necessary to take steps to correct the fault. This is not difficult with the molecularly-dispersed acid dyes because, on account of their good migrating properties, continued boiling in the same liquor is often effective. It must, however, be borne in mind that wool felts if it is boiled for too long, and over-milling can be as undesirable as variations in shade. Boiling in a fresh liquor with 20 per cent of Glauber's salt and no acid will strip some of the colour, and this can be exhausted again by cautious addition of acid or, preferably, an ammonium salt. If treatment with Glauber's salt is not successful, more of the colour can be stripped by boiling with $\frac{1}{2}$ per cent of ammonia, or in a liquor containing 2 to 5 lb of pyridine per 100 gallons. Another method is to boil with 3 to 5 per cent of a cationic-non-ionic mixture such as Tinegal W or Lyogen SMK. When sufficient colour has been removed by any of these compounds the wool is rinsed and redyed.

There are occasions when it is necessary to strip the colour completely. This is done with sulphonylate-formaldehyde products such as Formosul, or with sodium dithionite. Sulphonylate-formaldehyde should be applied in conjunction with formic or acetic acid, the quantities used being 2 to 4 per cent on the weight of the wool of Formosul, with 1.5 to 2.5 per

cent of formic acid (85 per cent) or 3 to 5 per cent of acetic acid (30 per cent). When using Formosul there is no action until the liquor nearly reaches the boil. Sodium dithionite is used in a neutral liquor and is effective at a lower temperature but tends to give less regular results. Treatment with these powerful reducing agents may leave the wool with a harsh handle and application of a cationic softening agent may be desirable.

Many of the unshrinkable finishes based on chlorine or other oxidizing agents reduce the wet-fastness of acid dyes. A few examples of the nature of the effect are quoted from I.C.I. Dyehouse Technical Information Publication No. 536 for dyeings on wool rendered unshrinkable by the combined peracetic acid and sodium hypochlorite method of the Wool Industries Research Association (Table 15.6). Only effect on shade has been recorded because alterations with regard to staining of adjacent fibres are insignificant.

Table 15.6

Dye	C.I. number	Wash-fastness	
		Untreated	Treated
Lissamine Flavine FF	ACID YELLOW 7	3-4	2
Lissamine Fast Yellow 2G	ACID YELLOW 17	3-4	2
Naphthalene Orange G	ACID ORANGE 7	2	1
Croceine Scarlet 3B	ACID RED 73	4-5	3
Lissamine Fast Red BG	ACID RED 37	3-4	2
Ultralan Yellow R	ACID YELLOW 99	4	4
Coomassie Yellow 7G	ACID YELLOW 44	4	4
Ultralan Red B	ACID RED 212	4	4
Coomassie Milling Scarlet 5B	ACID RED 89	4-5	4-5

The washing test applied to the first five was that of the I.S.O. (Mechanical Mild Wash at 40°C (104°F) for 30 minutes) and for the remainder the S.D.C. No. 2 test (50°C (122°F) for 45 minutes). The figures show that there is a loss of fastness of 1 to 2 gradings with the level-dyeing acid dyes, but none with the premetallized or fast acid dyes. Different unshrinkable finishes would not give exactly the same results but they could be expected to be of the same order. Shrink-resisting processes are usually applied to goods which are washed frequently, and it follows that the use of the molecularly-dispersed acid dyes is undesirable.

Wool which has had an unshrinkable treatment with chlorine usually has an increased affinity for many acid dyes, and also tends to give unlevel results. Townend (*J.S.D.C.*, 1945, **61**, 147) showed that the greater the number of sulphonic acid groups in the molecule, the more marked would be the tendency for variations in degree of chlorination to affect the uniformity of the shade. In a further publication by Townend and Simpson (*J.S.D.C.*, 1946, **62**, 47) it was recorded that a similar state of affairs applied to

variations in affinity caused by carbonization. Thus a mordant dye of the type of Solochrome Red D (C.I. MORDANT RED 14), formula (14) is most level dyeing and Naphthalene Scarlet 4R (C.I. ACID RED 18), formula (15) is most unlevel dyeing.

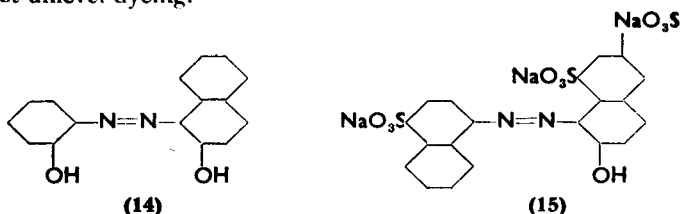

The greater affinity which chlorinated wool has for many acid dyes has been used for obtaining two-colour effects on yarns or garments made out of mixtures of untreated and treated fibres. Careful selection of dyes is necessary for good results. Those which exhaust only slowly on wool tend to give a better contrast.

Since the appearance of hydrophobic synthetic fibres, much attention has been devoted to dyeing at temperatures above 100°C (212°F). In the case of acid dyes on wool the only method which has, until the present, received attention is yarn package dyeing described by Coutie, Lemin, and Sagar (*J.S.D.C.*, 1955, 71, 433). It is known that many acid dyes tend to hydrolyse on prolonged boiling, and this is exaggerated at temperatures above 100°C (212°F). Wool keratin also gives rise to degradation products with reducing properties when boiled in a dyebath. It is to counteract this effect that it is common practice to add $\frac{1}{2}$ per cent of potassium or sodium dichromate when using dyes such as:

Coomassie Navy Blue 2RN	C.I. ACID BLUE 113
Coomassie Navy Blue G	C.I. ACID BLUE 118
Coomassie Fast Black B	C.I. ACID BLACK 24.

The outstanding advantage of high-temperature dyeing is the greater rate of levelling with the consequent reduction in dyeing time. The rate of half-levelling is the time taken for undyed wool to accept from the dyed sample in the same blank liquor, half of the amount of colour which would be transferred to it when equilibrium has been established. Expressed in another way:

$$t_{\frac{1}{2}} = \frac{t}{x}(F-x).$$

When $t_{\frac{1}{2}}$ = $\frac{1}{2}$ time of levelling in minutes.

F = percentage of colour absorbed by undyed sample at equilibrium.

x = percentage of dye absorbed by undyed sample after a time t , expressed in minutes.

The relationship between time of half-levelling and temperature are quoted

from Coutie *et al.* (*loc. cit.*) in Table 15.7, and they demonstrate clearly the accelerated levelling and consequent reduction in time required for dyeing.

It must, however, be emphasized that at 120°C (248°F) there is significant degradation of the wool which becomes more marked in strongly-acid or neutral-to-alkaline liquors. Wool should never be dyed, therefore, above 110°C (230°F), at which temperature the duration of the operation must not exceed 60 minutes, and many dyers prefer to work at 105°C (221°F). In order to establish the best conditions to avoid degradation the pH value should be within the limits of 3 to 6.5.

The use of organic solvents to assist in the dyeing of wool was suggested by Peters and Stevens (*J.S.D.C.*, 1956, **72**, 100) because it resulted in accelerated exhaustion at lower temperatures. Thus, in the presence of

Table 15.7

Dyeing (1 per cent)	Dyeing method (per cent)	Time of half-levelling in minutes		
		95°C	110°C	120°C
Coomassie Fast Grey 3GS (C.I. ACID BLACK 8)	3 Acetic acid (30 per cent)	56.5	17.8	4.5
Coomassie Fast Grey 3GS	10 Glauber's salt			
Carbolan Crimson 3BS (C.I. ACID RED 139)	40 Glauber's salt	25.1	3.7	1.8
Carbolan Crimson 3BS	3 Ammonium acetate	51	20.2	5.0
Carbolan Brilliant Green 5GS (C.I. ACID GREEN 28)	40 Glauber's salt	34	11.8	3.7
Carbolan Brilliant Green 5GS	3 Ammonium acetate	181.5	29.6	5.7
Carbolan Brilliant Green 5GS	40 Glauber's salt	104.5	10.3	2.1

n-butyl alcohol the premetallized dye Irgalan Grey BL exhausted completely in 30 minutes at 60°C (140°F). The mechanism of the phenomenon has been explained by Alexander and Stacey (*J.S.D.C.*, 1956, **72**, 241) by the assumption that the solvent breaks down hydrogen bonds, thereby preventing the formation of dye aggregates in the dye liquor. Peters and Stevens (*loc. cit.*), on the other hand, express the view that the solvent is adsorbed at the fibre/water interface, and there it acts as a conductor for the dye molecules in which they are more soluble than in water. The influence of solvents and their commercial application is reviewed in greater detail by Beal, Dickinson, and Bellhouse (*J.S.D.C.*, 1960, **70**, 333), who conclude that benzyl alcohol is the most suitable compound to use, and, although it is expensive, its use is practical in machines where the liquor ratio is comparatively short and storage of the dye liquor for re-use is possible. The exhaustion is so complete that, at the end of the dyeing, there is no difficulty in using it again.

Based on this work the so-called Irga-solvent process for wool has been covered by a patent taken out by Geigy. The recommended method of application is to make up a liquor containing 2 per cent by volume of benzyl alcohol, with the appropriate amounts of dyeing assistants (usually ammonium sulphate, ammonium acetate, or acetic acid) in the reserve tank, raise it to 70°C (158°F) and circulate it through the goods for 15 minutes. The liquor is then pumped back to the reserve tank, unless there is an expansion tank as in the cheese dyeing machine, and the dye is added. The liquor is next circulated through the goods for 5 minutes and then raised to 80° to 90°C (176° to 194°F) according to circumstances, and dyeing is continued at this temperature for 20 to 30 minutes. Penetration is greatly improved, and the shorter process time and somewhat lower temperature effects an economy in steam.

An analogous development based on coacervation has been developed by Ciba (*Ciba Review*, 1961/1). An aqueous coacervation system is composed of two phases, each containing varying amounts of water, unlike most organic solvent and water mixtures in which neither phase contains a significant proportion of the other. The phase known as the coacervate is a concentrated aqueous solution of an organic product such as, for example, a condensate of an alkylamine with a fatty acid, and the other phase known as the equilibrium mixture contains a much greater proportion of water. In continuous methods for wool dyeing, the material is padded with a liquor made up with Cibaphasol C, sufficient to give a final concentration of 40 g per litre. The dye is added and well stirred in, and then sodium alginate is mixed in as a thickener to maintain the stability of the phases. The amount of thickener required depends upon the depth of the shade and the nature of the machine to be used for padding, and can vary from 50 to 300 g per litre of a stock solution containing 25 g of sodium alginate per litre. The dye will be dissolved almost entirely in the coacervate or 'oil' phase. Glauber's salt, or acetic acid, is then added and the wool is padded. It is found that the aqueous phase is absorbed into the fibre and the dye containing coacervate forms an almost homogeneous surface film. The padded material passes into a chamber where it is steamed for a period of 10 to 20 minutes and finally it is washed off to remove unfixed dye, sodium alginate, and Cibaphasol C.

Many efforts not depending upon coacervation have been made to devise continuous dyeing sequences for wool. It is only in top, sliver, or tow dyeing, however, that any measure of success has been achieved. Continuous dyeing processes for wool in these forms were described by W. Beal (*J.S.D.C.*, 1967, 83, 3). A process has been developed by Geigy in conjunction with ILMA, the machine builder, in which the loose stock is padded with approximately its own weight of the dye liquor and it then passes into a steaming chamber through which it is conveyed on a stainless steel brattice. The time required for steaming may vary between ten

and thirty minutes, after which the material is washed off and dried. Success depends upon assistants developed by Geigy such as Irgapadol F for use with anionic dyes and Irgapadol A for use with cationic dyes. These products:

- (a) act as wetting agents;
 - (b) are good solvents for dyes;
 - (c) have good stability towards acids even over long periods;
 - (d) form a uniform paste with the thickening agent and the dye;
 - (e) assist in the formation of an even film on each fibre;
 - (f) assist in the fixing of the dye and are easily removed in washing off.
- The pad liquor also contains a thickener.

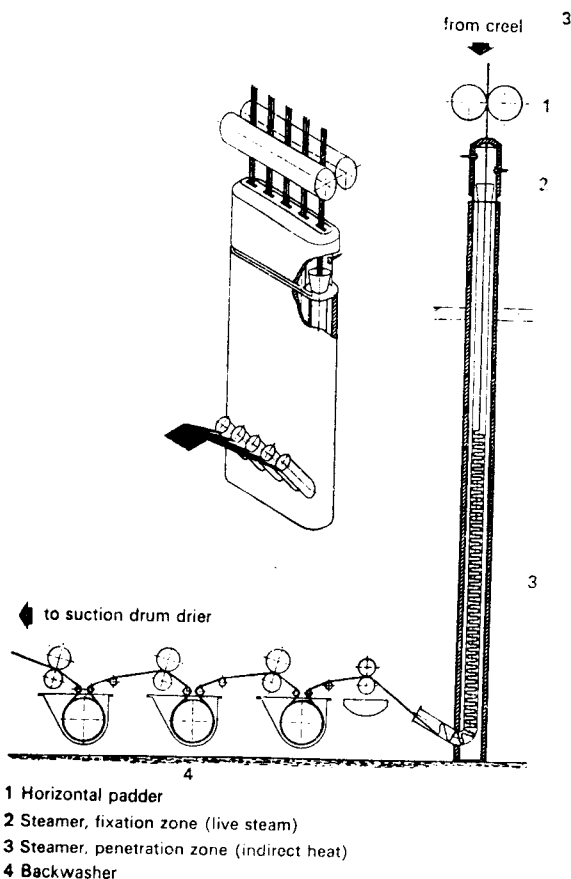

Fig. 15.10 ILMA vertical continuous dyeing range for wool tops and acrylic tow

(BEAL *J.S.D.C.*, 1967, 83, 3)

An alternative method is the ILMA vertical steaming range which takes the form of a tube similar to a J-box. The padded fibres on entering the vertical heating unit are first subjected to live steam and then remain for a dwell period varying from ten to thirty minutes in a zone of the steamer where the temperature is maintained by indirect heat (Fig. 15.10).

Application of acid dyes to silk

Although silk has an affinity for acid dyes the colours tend to be less fast than on wool. Silk will exert its affinity for acid dyes at lower temperatures than is the case with wool, and dyeing is usually commenced at 40°C (105°F) and the temperature is not allowed to rise above 85°C (185°F). It is rarely necessary to exceed this temperature and boiling is to be avoided, if possible, because it is not without deleterious effect upon the tensile strength and lustre of the fibre.

Silk is protected during dyeing by the addition of up to 10 gallons of 'boiled off' liquor per 100 gallons of water. If the dyes require acid the liquor is broken with sulphuric acid as described in the previous chapter, and in the case of a neutral-dyeing colour acetic acid is substituted. Sometimes neutral-dyeing acid dyes are applied from a soap liquor containing 10 to 20 per cent of Glauber's salt.

16 · The direct dyes

THE direct dyes, also known as the substantive colours, differ from the basic and acid dyes because cellulosic fibres have a strong affinity for them. Many of them will also dye the protein fibres and, as was explained in the previous chapter, the majority are sulphonated azo compounds very similar to the acid dyes in constitution, there being no clear demarcation between the two classes. Selected substantive dyes can be used to give solid shades on wool and cotton mixtures.

The discovery of Congo Red by Böttiger has been referred to in Chapter 1. This was the first direct dye, and its discovery was quickly followed by the preparation of many similar colours, opening a new era in cotton dyeing. Before 1884 cellulosic fibres could only be dyed on a mordant or by means of indigo and a limited number of other naturally-occurring vat dyes. Both of these methods were troublesome and expensive. Cotton was made in large quantities in the last century for markets where cheapness was a most important consideration. The direct dyes were inexpensive and easy to apply and, although of indifferent wet-fastness, their use spread with great rapidity because they fulfilled an outstanding demand. New members with improved fastness are still being added to this class.

Chemical constitution of direct dyes

Most of the colours belonging to this class are sulphonated azo compounds. A simple monazo direct dye is Diazamine Scarlet B (C.I. DIRECT RED 118), formula (1):

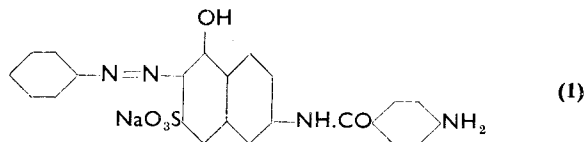

and the original Congo Red (C.I. DIRECT RED 28), formula (2):

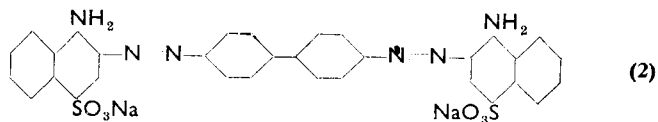

was a bisazo compound prepared by coupling benzidine diazotized at both amino groups with 2 molecules of naphthionic acid. Diazo Brown 3RNA.CF (C.I. DIRECT BROWN 138), formula (3):

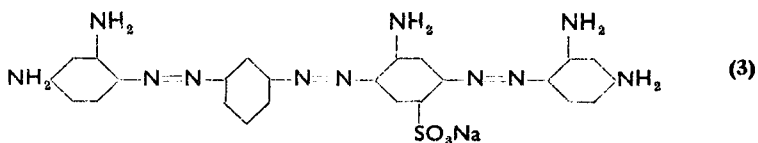

is a trisazo direct dye of comparatively simple structure and a polyazo or tetrakis azo member of the class is Chlorazol Brown GM (C.I. DIRECT BROWN 44), formula (4):

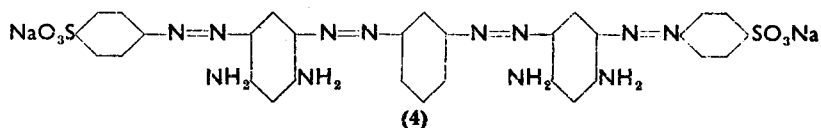

An important group of the direct dyes is those derived from stilbene, formula (5), such as Diphenyl Chrysoine G (C.I. DIRECT YELLOW 19), formula (6):

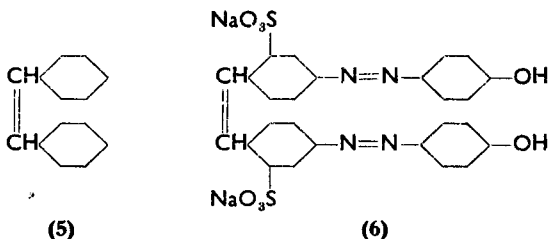

In 1887 Green prepared Primuline, formula (7), which was the first of the Thiazole direct dyes.

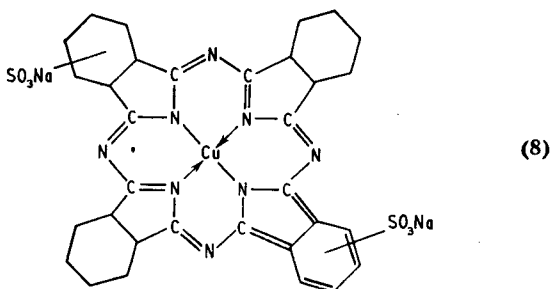
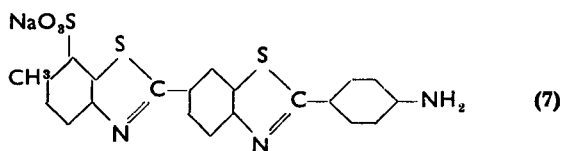

The latest class to be added to the substantive dyes is those based on phthalocyanine. Durazol Blue 8G (C.I. DIRECT BLUE 86), formula (8), is an extremely bright greenish blue with good light-fastness but poor wash-fastness.

Theory of dyeing

The nature of the affinity of cellulose for direct dyes could not be explained with any degree of satisfaction until comparatively recently. Cellulose has no polar groups capable of forming salt linkages, so the assumption was that the binding forces were purely physical. On the other hand, there was clear evidence that the hydroxyl groups played a significant part, because when cotton was acetylated its affinity for direct dyes was removed, but it was restored when the acetyl groups were hydrolysed.

The majority of the direct dyes are bisazo compounds, and the earliest constructive suggestion was made by Meyer in 1928. He expressed the view that substantivity was connected with extended linear molecular structure of the dye so that it could align itself on the surface of the fibre (PETERS, *Hexagon digest*, No. 8). In formula (9) the molecule is linear in the direction of A---B, and is substantive whilst the bisazo compound, formula (10), has no such configuration and is non-substantive. Very many similar examples could be quoted.

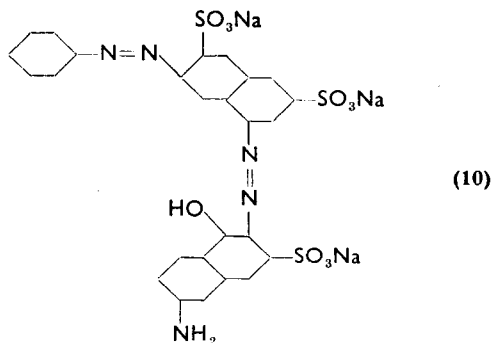
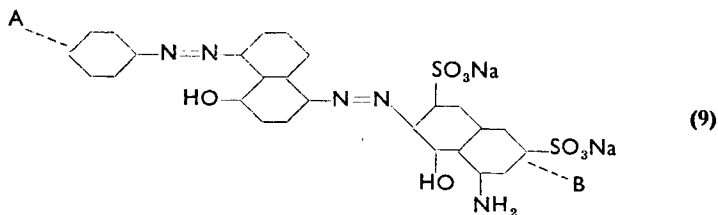

Azo and other groups can give to a molecule the possibility of cis, trans isomerism. The simplest example is azobenzene, where formula (11) represents the trans and (12) the cis isomer.

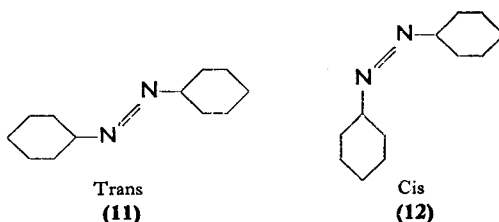

When this conception is applied to the molecules of azo dyes it is apparent that the trans form can be linear but the cis cannot. It would, therefore, appear that only the trans isomer is substantive, but commercial dyes are equilibrium mixtures and it is believed that the cis is transformed to the trans configuration as the latter is adsorbed by the fibre.

Further contributions to the theory of the relationship between structure and substantivity were made by Hodgson (*J.S.D.C.*, 1933, **49**, 213) and Hodgson and Marsden (*J.S.D.C.*, 1944, **60**, 210), who postulated that not only must the molecule be linear but the benzene nuclei must be coplanar. An example which is quoted is that compounds of the type, formula (13), where the benzene nuclei are free to rotate and therefore not coplanar, making the substance non-substantive, whilst those conforming with the general formula (14) have the nuclei locked in coplanar positions and are substantive.

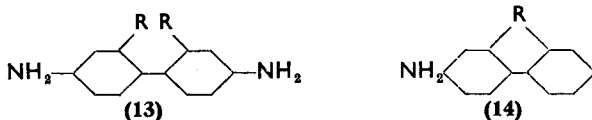

Benzopurpurine 4B, formula (15), is coplanar and highly substantive, but the isomeric compound, formula (16), has two methyl groups in such positions that they prevent the two benzene nuclei from lying in the same plane, and the affinity of cellulose for the substance is therefore low.

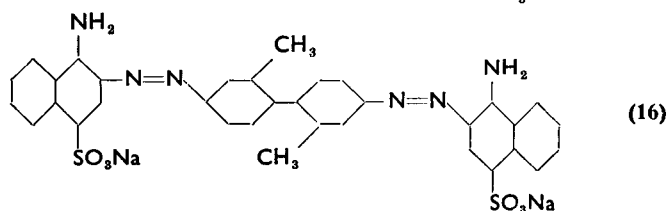
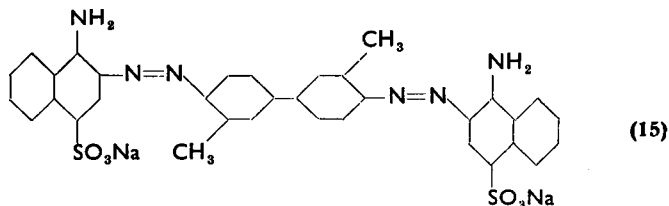

Schirm (*J.S.D.C.*, 1936, **52**, 70) attributed substantivity to a system of conjugated double bonds. Lead (*J.S.D.C.*, 1957, **73**, 464) suggested that the affinity might be due to the interaction between electrons in an extended conjugated system and the hydrogen atoms of the hydroxyl groups of the cellulose.

Cellulose contains hydroxyl groups capable of entering into hydrogen bond formation with groups such as —OH , —NH_2 , and —N=N— in the dyestuff molecule. The bonding hydrogen atoms may be contained in the cellulose as in formula (18) or, alternatively, a hydrogen atom in the dye molecule may bond with the oxygen in the cellulosic hydroxyl group, formula (17):

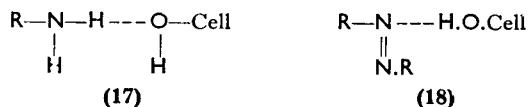

Paine and Rose, by constructing molecular models of direct dyes, showed that in many instances good substantivity was associated with spacing of potential hydrogen bonding groups approximately 10.8 \AA (1.08 nm) apart. This spacing corresponds with the repeat period of hydroxyl groups in cellulose occupying similar positions in relation to the plane of the main chain, as shown in formula (19).

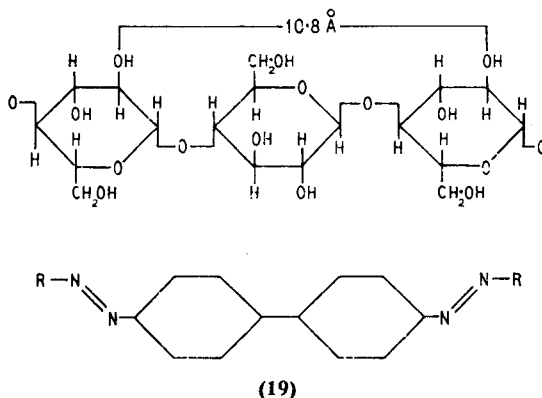

It was at one time thought that this conception afforded a satisfactory explanation of the substantivity of direct dyes, but for a number of reasons the theory is no longer considered valid. It has been demonstrated that there are many direct dyes with good substantivity in which the bonding groups are not situated at the 10.8 \AA (1.08 nm) spacing. It was therefore suggested that hydrogen bonds could be formed at many sites, not necessarily corresponding with the repeat distance of the cellobiose unit.

Peters and Sumner (*J.S.D.C.*, 1955, **71**, 130) pointed out that attachment

by hydrogen bonds could not be the only explanation of the substantivity of many of the vat dyes, because their molecules were not linear, nor did they contain hydrogen bonding groups. The attachment of the dye to the fibre must therefore be brought about by Van der Waals forces. They did not, nevertheless, exclude the significance of hydrogen bonds because they demonstrated that the presence of bonding groups within the molecule of the dye enhances substantivity. Substances such as stilbene-4-sulphonic acid are substantive although they possess no hydrogen bond forming groups (Lead and Ward loc. cit).

The discussion was taken a stage further by Giles and Hassan (*J.S.D.C.*, 1958, 74, 846), who concluded that the water molecules form a water-cellulose chain complex, and prevent the dye from approaching close enough to the cellulose for the formation of hydrogen bonds. It was therefore assumed that the attraction for the dye must be of the nature of non-polar Van der Waals forces. Lead (*J.S.D.C.*, 1959, 75, 195) draws attention to the correlation between an extended conjugated system of π electrons and substantivity. Planarity, which would be the only requisite for Van der Waals forces to be effective, does not explain the lack of substantivity of many planar compounds. It is suggested that the extended π electron system may form an intermediate layer between the cellulose on one side and the associated water molecules on the other side, because interaction can occur between the delocalized π electrons of the dye molecule and the hydroxyl groups on either side.

Some reference was made in Chapter 12 to the directional absorption of polarized light by dye molecules. If the molecules of substantive dyes are attached to cellulose chains, as has been suggested, they should be predominantly orientated parallel to the fibre axis and should exhibit dichroism. Preston (*J.S.D.C.*, 1931, 47, 312) showed that when cellulose was dyed with Congo Red and other direct dyes, the light absorption attributable to the dye was greater when the direction of vibration of polarized light was along the axis of the fibre than when it was in the transverse direction. Furthermore, dichroism was more marked when the cellulose molecules in the fibre were known to be highly orientated. These observations lead to the conclusion that the dye molecules are adsorbed alongside the cellulose chains orientated in parallel with the fibre axis. It follows therefore that the essential mechanism is fixation at the surface of the crystalline regions and that the dye molecules reach this point of attachment by access through the amorphous zones.

The adsorption isotherm for Chrysophenine G, which is shown in Fig. 16.1 and is typical of that obtained with most direct dyes, corresponds with the Freundlich equilibrium. This indicates that with the direct dyes opportunity for hydrogen bonding and Van der Waals forces to bind the dye are, for practical purposes, almost unlimited. The limitation which is imposed is the available surface for attachment, but this does not terminate

abruptly because, as the accessible areas become crowded the more inaccessible ones gradually have to be occupied. Thus there is a state of affairs intermediate between partition between two immiscible solvents and a stoichiometric reaction. Direct dyes conform to the Freundlich equation, as is apparent from the isotherm for Chrysophenine G at 60°C (140°F), see Fig. 16.1.

No explanation based on the assumption that there is some form of dye-fibre bonding has proved to be entirely satisfactory. Pfeil *et al.* (*Angew*

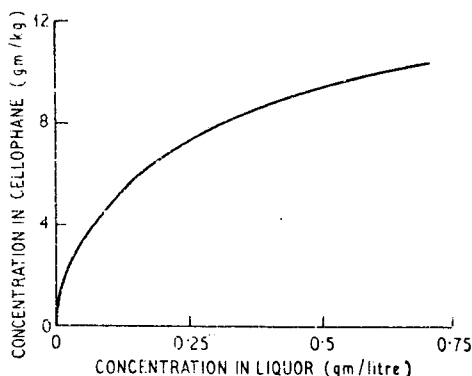

Fig. 16.1 Isotherm for Chrysophenine G

(Courtesy of VICKERSTAFF, 'The Physical Chemistry of Dyeing')

Chem., 1963, 75, 407) suggested that spectral absorption curves indicated that direct dyes were in a state of aggregation in cellulose which would be too great for entry. It was therefore suggested that the dyes enter the fibre in a molecularly dispersed state and then become aggregated to such a size that they cannot easily migrate out again. Planar structure in the dye molecule makes penetration of the dye between the cellulose chains easier and promotes the tendency towards aggregation.

Action of electrolytes

The addition of electrolytes to the dye liquor tends to promote exhaustion of direct dyes, although the effect varies considerably with different dyestuffs. This is shown in Fig. 16.2, where the percentage exhaustions with different quantities of anhydrous Glauber's salt are plotted (LEMIN, VICKERS, AND VICKERSTAFF, *J.S.D.C.*, 1946, 62, 147). Dye *A* is not very sensitive to salt, but dye *B* is affected to a very marked degree. The exhaustion of some fifty direct dyes with various quantities of sodium sulphate was examined and recorded by Vickerstaff *et al.* (*loc. cit.*). Cellulosic fibres assume a negative charge when immersed in water. This has the effect of repelling the similarly charged ion of the substantive dye. Electrolytes reduce or extinguish the charge on the fibre, thus facilitating the approach

of the dye ion to within the range at which hydrogen bonding or Van der Waals forces can become effective.

The more electronegative charges there are on the dye ion the greater will be the repulsion exercised by the fibre. It would, therefore, be expected

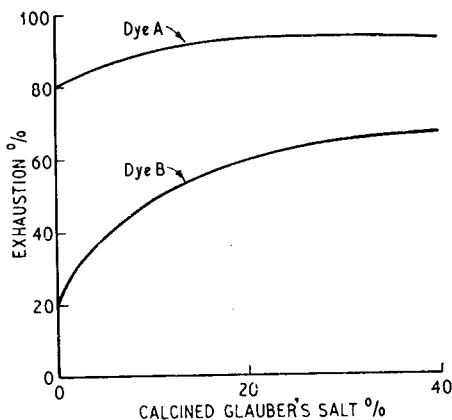
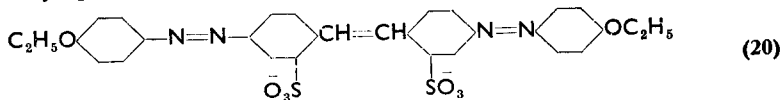
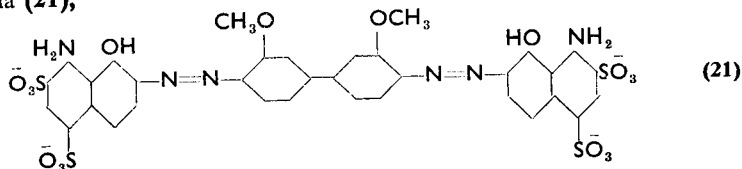

Fig. 16.2 Effect of addition of electrolyte on exhaustion of direct dyes

that the effectiveness of electrolytes in promoting exhaustion would vary directly with the number of sulphonic groups in the molecule. The anion of Chrysofenine G (C.I. DIRECT YELLOW 12), formula (20),



has two charges, and this colour will dye cotton quite deeply without the addition of electrolytes. Chlorazol Sky Blue FF (C.I. DIRECT BLUE 1), formula (21),



with four sulphonic acid groups in the molecule, only stains the cellulose until an electrolyte has been added, after which it exhausts quite well.

Effect of temperature

As has already been explained, when dealing with the theory of dyeing, increase of temperature decreases the amount of dye adsorbed by the fibre at equilibrium. By increasing the kinetic energy of the molecules it does,

however, hasten the speed at which equilibrium is attained at the temperature in question. Temperatures of maximum exhaustion are shown in Table 16.1.

Table 16.1

Dye	C.I. number	Temperature of maximum exhaustion (°C)
Chrysophenine	DIRECT YELLOW 12	40-60
Direct Fast Yellow 3G	DIRECT YELLOW 6	100
Diphenyl Red BS	DIRECT RED 37	60
Chlorazol Fast Helio 2RK	DIRECT VIOLET 7	20-60
Trisulphon Violet B	DIRECT VIOLET 22	40-60
Chlorazol Black BH	DIRECT BLUE 2	60-80
Trisulphon Fast Blue B	DIRECT BLUE 26	100

As the temperature rises the rate at which equilibrium is attained increases until it reaches a maximum. Affinity, however, decreases with rise of temperature. The curves in Fig. 16.3 show exhaustions after dyeing, without electrolyte, for successive 15 minute periods at 20, 40, 60, 80, and 100°C, allowing 5 minute intervals for raising the temperature between each point plotted on the temperature co-ordinate. In most cases equilibrium is attained well within the 85 minutes allowed for raising to the boil. In such cases the affinity and the depth of the shade decrease at the higher temperatures.

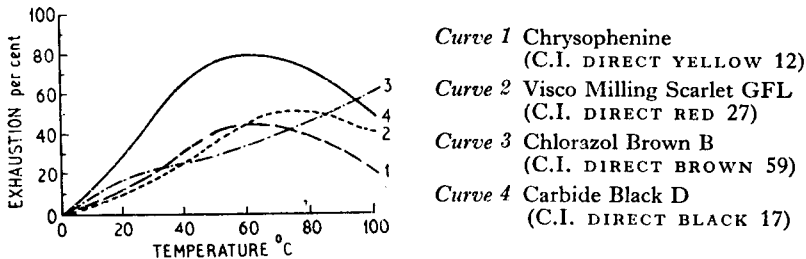

Fig. 16.3 Effect of temperature on exhaustion of some direct dyes

This causes a change in shade when a boiling liquor cools and can often turn a dyeing matched at the boil off shade if the temperature is allowed to fall.

Effect of liquor ratio

A study of the isotherm in Fig. 16.1 shows that percentage exhaustion continues to increase as the concentration of dye in the liquor becomes greater. Dyeing in a short-liquor ratio, therefore, is an important factor in economizing in dyestuff consumption. When producing heavy shades the

amount of dye which is necessary can become very great if the machine is one which requires a high ratio of water to goods. With shades which are frequently repeated, such as black, it is advisable to have a reserve tank in which the liquor can be stored for re-use after fortification with a comparatively small amount of dye. Recipes with direct dyes will only give good repetition if it is possible to keep the liquor ratio constant.

Effect of pH value

Direct dyes are almost invariably applied from a neutral solution. No advantage is gained by the addition of acid and there is a possibility that it may alter the shade. Mild alkali has a retarding effect upon the rate of adsorption, and up to 3 per cent of soda ash is sometimes added either to counteract hardness in the water or, in a few cases, such as with Benzopurpurine 4B (C.I. DIRECT RED 2) and Chlorazol Orange PO (C.I. DIRECT ORANGE 1), to improve the solubility.

Fastness

The direct dyes do not possess good fastness to washing nor to other wet processes such as scouring or dealgination. They cannot be used on yarns incorporated in wool goods which are to be cross-dyed. The light-fastness of some can only be rated as moderate, but many are quite good. A few examples have been selected to illustrate the general order of fastness, see Table 16.2.

Table 16.2

Dye	C.I. number	Wash-fastness S.D.C. No. 3	Light-fastness S.D.C. 1 per cent shade
Chlorazol Yellow 6G	DIRECT YELLOW 8	2	2
Diphenyl Red BS	DIRECT RED 37	1-2	2
Direct Fast Scarlet 3BS	DIRECT RED 39	2	2
Solar Violet 3R	DIRECT VIOLET 7	1	4
Diphenyl Brilliant Blue 5B	DIRECT BLUE 25	4	6-7
Solophenyl Yellow BRL	DIRECT YELLOW 29	4	6-7
Durazol Red 2B	DIRECT RED 81	1	4
Solophenyl Yellow GFL	DIRECT YELLOW 50	3	6
Solar Red 2BL	DIRECT RED 79	4	6
Diphenyl Brown CB	DIRECT BROWN 57	3	3

The dyeing properties of the direct dyes have received more attention than those of any other group because regenerated cellulose rayons varied considerably in physical properties in their early days, and some direct dyes covered up the irregularities better than others. This led to an exhaustive endeavour to find a basis on which selection could be made. An early suggestion was Whittaker's capillary test, which graded dyes according to the

height above the surface of the liquid a suspended viscose thread was stained. The higher the stained zone rose the less was the power of the dye to cover up irregularities. This was followed by the temperature range test in which 8 equal skeins were dyed in 8 dyebaths each containing 2 per cent of soap, 10 per cent of anhydrous Glauber's salt, and 0.5 per cent of dye. The hanks were dyed for 30 minutes at 20°, 30°, 40°, 50°, 60°, 70°, 80°, and 90°C. Some dyes, as has already been explained, show maximum adsorption of colour at comparatively low temperatures and others near the boil. Those dyes which exert the greatest affinity at low temperatures give the more uniform shades.

Boulton and Reading (*J.S.D.C.*, 1934, 53, 81 and 1938, 84, 268) used the time of half-dyeing, already referred to in Chapter 12, as a numerical expression of the capacity of a dye to give uniform shades on regenerated cellulosic fibres. Three typical logarithmic curves showing extremes of rates of half-dyeing are shown in Fig. 16.4 (Boulton and Reading *loc. cit.*).

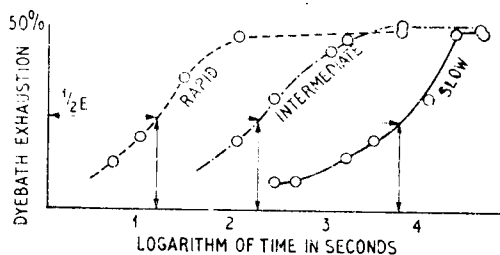

Fig. 16.4 Curves showing rate of dyeing for typical direct dyes

The curve marked *Rapid* is for Diazo Brilliant Orange GR, the *Intermediate* one is for Benzo Viscose Blue 3GFL, and that labelled *Slow* is for Solar Yellow 2R, and the exhaustion times are given below:

Dye	E	$\frac{1}{2}E$	Time of attaining $\frac{1}{2}E$	
			Log sec	min
Diazo Brilliant Orange GR	49.8	24.9	1.12	0.22
Benzo Viscose Blue 3GFL	51.7	25.9	2.58	6.3
Solar Yellow 2R	49.8	24.9	3.71	85.5

(E = equilibrium exhaustion)

In commercial dyeing there is never time to allow all dyes to reach equilibrium because this may take several hours. Those which can approach most closely to equilibrium within the time which can normally be permitted will be the most level dyeing. Boulton (*J.S.D.C.*, 1938, 54, 268) has published a list of direct dyes and their half-dyeing times.

In 1946, Lemin, Vickers, and Vickerstaff (*J.S.D.C.*, 1946, 62, 132) published the results of further work on the dyeing properties of direct dyes, and extended their observations to the behaviour of mixtures of dyes. They

found that there was cause to doubt the validity of the assumption that the rate of dyeing of single dyes may be used as a guide for the selection of compatible mixtures. They therefore suggested that the classification of dyeing properties which would be of most assistance to the practical dyer would be to divide them into three groups. This proposal was essentially the same as had previously been made by Whittaker (*J.S.D.C.*, 1942, 58, 253).

Class A (self-levelling)

Dyes which migrate well and therefore have high levelling power. They may dye unevenly at first but further boiling will bring about even distribution.

Class B (salt controllable)

Dyes of poor levelling power where exhaustion must be brought about by controlled salt addition. If these dyes are not taken up uniformly in the initial stages it is extremely difficult to correct the unevenness.

Class C (temperature controllable)

Dyes which are not self-levelling and are highly sensitive to salt. The exhaustion of these dyes cannot adequately be controlled by addition of salt alone and they require additional control by temperature.

Shortly after this classification was suggested, the report of the Committee appointed by the Society of Dyers and Colourists to discuss the properties of direct cotton dyes was published (*J.S.D.C.*, 1946, 62, 281). They recommended the recognition of the three classes referred to by Lemin *et al.* (*loc. cit.*), and concluded that two tests would provide a satisfactory basis for assigning any dyestuff to its proper class. Those which passed the first test for migration would fall into Class *A* and those which failed would be classified *B* or *C* by the second salt controllability test.

The migration test is carried out in the following manner:

A hank of yarn is dyed with the dye under examination in a 1 per cent shade, the amount of dye being in terms of the standard brand.

The dyebath is prepared with the appropriate amount of dye in distilled water, to which is added 20 per cent of common salt (on the weight of the yarn) and is used at a liquor-to-goods ratio of 30 to 1. The bath is brought to the boiling point, the dry hank entered and dyeing carried out by boiling gently for 30 minutes. The dyed hank, which should be uniformly dyed, is squeezed to remove surplus liquor and is then dried.

Migration test The dried hank and an equal weight of undyed bleached yarn (from the same batch as that used for the dyeing) are treated in a bath composed of distilled water to which has been added 10 per cent of common salt (on total weight of yarn) at a liquor-to-goods ratio of 30 : 1 for 30

minutes at the boil. The hanks are then squeezed to remove surplus liquor, dried, and compared.

A standard dyed with any one of the following should be put through the migration test at the same time:

Chlorazol Rose BS	C.I. DIRECT RED 31
Chlorantine Fast Yellow SL	C.I. DIRECT YELLOW 50
Solar Brilliant Blue A	C.I. DIRECT BLUE 67.

If it is found that the equality of shade between the hanks under test is closer or equal to the standard, the dye belongs to Class *A*. If not, it is either Class *B* or Class *C*, and must be classified by the salt controllability test which is carried out in the following manner:

Three dyebaths are prepared with the appropriate amount of dye to give a 1 per cent shade (calculated in terms of the standard brand) using distilled water and a liquor ratio of 30 : 1. To the dyebaths are added 0.6 per cent, 0.8 per cent, and 1 per cent of common salt respectively, and three separate dyeings are made, boiling gently for 30 minutes. Each hank is then removed and squeezed, the surplus liquor being returned to the dyebaths.

To each of the three dyebaths is then added sufficient common salt to bring the total concentration to 20 per cent, and a second dry hank of yarn is entered and dyed by boiling gently for 30 minutes. The three pairs of hanks are dried and compared.

If all the first dyeings are lighter than the corresponding second dyeings, or if any one of the first dyeings is of the same depth as the corresponding second dyeings, the dye is placed in Class *B*. On the other hand, if all the first dyeings are darker than the corresponding second dyeings, the dye is placed in Class *C*.

The following dyes have been selected as standards for the salt controllability test:

Chlorazol Fast Scarlet 8B	C.I. DIRECT RED 28
Direct Blue BT	C.I. DIRECT BLUE 8
Direct Violet N	C.I. DIRECT VIOLET 1

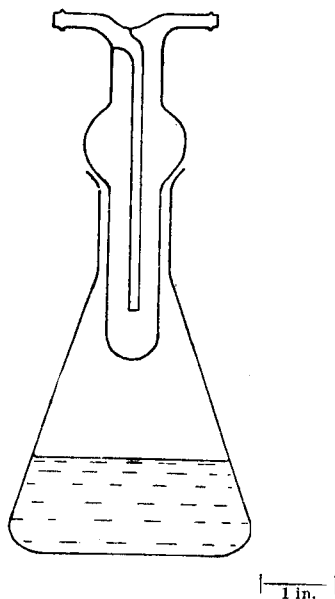

Fig. 16.5 Apparatus for dyeing and migration tests at constant liquor ratio
(J.S.D.C., 1915)

In order that the liquor ratio may remain constant, the dyeings and the migration tests should be carried out in conical flasks with a reflux condenser, or a simple device such as is shown in Fig. 16.5 has proved very useful. The classification of many of the direct dyes is given in the Colour Index of the Society of Dyers and Colourists, and it is now usual to give this information in the dyestuff manufacturers' catalogues.

Application of direct dyes

Class A dyes

The dyestuff is pasted with cold water with an anionic or a non-ionic wetting agent and sufficient boiling water is added, with constant stirring, to bring it into solution. It is then added to the dye liquor through a strainer. When several pounds of dye are required it is better to boil them up in one to two feet of water in the bottom of the dyeing machine, and then make up to working level with cold water. Soft water is preferable but not essential for many of the direct dyes. There are some, however, which are precipitated by hardness in water, and in such cases if a soft supply is not available addition of Calgon, a sequestering agent, or 1 to 3 per cent of the weight of the cotton of soda ash is of assistance. Sodium chloride is then added to the liquor in about the following proportions:

For pale	shades	5	per	cent	of	the	weight	of	the	goods
„	medium	„	10	„	„	„	„	„	„	„
„	heavy	„	20	„	„	„	„	„	„	„

If desired, Glauber's salt crystals can be substituted when, to allow for the water of crystallization, two pounds are required to replace each pound of common salt.

The cotton or cellulosic goods, after thorough scouring or keir boiling, are entered into the dye bath at 40° to 50°C (100° to 122°F) and the liquid is raised to the boil over a period of 30 to 40 minutes, after which dyeing is continued for $\frac{3}{4}$ to 1 hour. At the end of this time the distribution of the colour should be uniform, but if it is not any defects can be cured by further boiling.

Class B dyes

The dye liquor is made up in a manner similar to that described for Class A but the salt is omitted. It is added gradually during the period that the liquor is coming to the boil, and, if desired, the addition may be continued after the boil is reached. If the salt can be dissolved in a separate vessel and added through a drip feed, this method is greatly to be preferred. Surface-active compounds, of which Lyogen DK is an example, can be added to the dyebath with Class B dyes to reduce sensitivity to salt and exercise further control over the rate of exhaustion.

Class C dyes

In the application of these it is essential that the dyeing should commence at a low temperature and no electrolyte is added to the dyebath at the commencement. The temperature is raised to boiling point very slowly and dyeing is then continued for a further $\frac{3}{4}$ to 1 hour. There is often a comparatively narrow temperature range over which exhaustion is most rapid, and it is during this period that control is most important. As an illustration a few Class C dyes are quoted in Table 16.3 together with the range of maximum exhaustion.

Table 16.3

<i>Dye</i>	<i>C.I. number</i>	<i>Temperature range (°C)</i>	<i>Range of exhaustion per cent</i>
Chloramine Yellow 2G	DIRECT YELLOW 28	0-60	0-92
Chlorazol Fast Orange R	DIRECT ORANGE 26	0-40	0-85
Benzopurpurine 10B	DIRECT RED 7	0-40	0-90
Trisulphon Violet 2B	DIRECT VIOLET 13	0-20	0-75
Trisulphon Brown B	DIRECT BROWN 31	0-60	0-80
Chlorazol Black GF	DIRECT BLACK 22	0-100	0-90

Electrolytes required to complete exhaustion should be added in portions after the liquor has reached the boil.

When more than one dye is necessary to match a shade it is undesirable to mix members of different classes. Thus a salt-sensitive dye should not be used with one which requires a large amount of electrolyte to bring about exhaustion. In addition, even when using mixtures of dyes of the same class, it is desirable, as a general rule, that they should possess approximately similar rates of exhaustion, and curves relating temperature to percentage of dye taken up by the fibre provide a useful guide for the dyer. In

Table 16.4

<i>Dye</i>	<i>C.I. number</i>
Trisulphon Yellow 3G	DIRECT YELLOW 6
Chlorazol Yellow G	DIRECT YELLOW 11
Diphenyl Fast Red 5BL	DIRECT RED 81
Chlorantine Fast Red 7BLN	DIRECT RED 80
Chlorantine Fast Yellow RLSW	DIRECT YELLOW 50
Solar Orange 4GA	DIRECT ORANGE 34
Solophenyl Fast Blue Green BL	DIRECT GREEN 27
Solophenyl Brilliant Blue BL	DIRECT BLUE 106
Chlorantine Fast Violet 2RLL	DIRECT RED 83
Solar Yellow R	DIRECT YELLOW 37

particular, care should be taken in selection for jig dyeing because there can be a marked difference in temperature between the selvages and the middle of the piece.

There are a limited number of direct dyes (Table 16.4) which have a slow rate of adsorption and a high rate of migration, and these are most useful for shading when it is desirable to make additions at higher temperatures.

After-treatments of direct dyes

The lack of wet-fastness of direct dyes is undesirable for many purposes, particularly for materials which will be expected to withstand washing. Many methods have been used to increase the molecular weight of the dye, after it has been adsorbed by the fibre, to render it less soluble in water and therefore more fast to wet treatments. If the molecule is too great it will not enter the fibre or, if it could, the dye would be extremely uneven-dyeing. It is therefore necessary that the preliminary deposition should be achieved with a soluble and comparatively small molecule, and the reaction rendering it less soluble should be carried out *in situ*.

The oldest method of improving fastness by an *in situ* reaction was discovered by A. G. Green in 1887. He prepared Primuline, (22), which was a yellow substantive dye but possessed only poor fastness to both light and washing. It will be observed that the molecule contains a primary amino group directly attached to an aromatic nucleus. This group can be diazotized when the dye is on the fibre by treatment in a cold solution containing sodium nitrite and excess of hydrochloric acid to yield the compound shown in (23), which can then be caused to couple with various phenols or

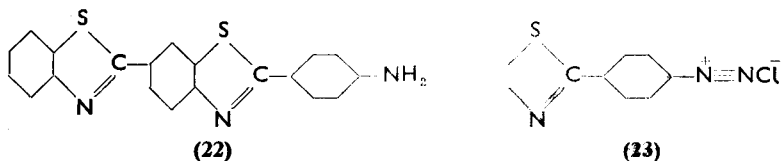

aromatic amines to new azo dyes *in situ* on the fibre which are of substantially improved wet-fastness. As would be expected, the addition of another chromophore to the molecule causes a complete alteration in shade. The hue of cellulose dyed with Primuline is greenish yellow, but when coupled with:

phenol	the hue is changed to reddish yellow;
phenylmethylpyrazolone	„ „ „ „ „ reddish yellow;
β -naphthol	„ „ „ „ „ red;
resorcine	„ „ „ „ „ dull reddish orange; and
<i>m</i> -phenylenediamine	„ „ „ „ „ dull red.

The effect upon fastness, graded by tests indicated, is shown in Table 16.5.

Table 16.5

<i>Developer</i>	<i>Wash-fastness (Deutsche normen)</i>	<i>Light-fastness (Normal dyeing)</i>
(Undeveloped Primuline)	2	1
Developed with β -naphthol	4	1
„ „ resorcine	3	1
„ „ <i>m</i> -phenylenediamine	4	1
„ „ phenol	4	1
„ „ phenyl methyl pyrazolone	4	3

There are many dyes which can be diazotized and developed, a few examples of which are:

C.I. DIRECT YELLOWS 64 and 65
 C.I. DIRECT REDS 136, 155 and 127
 C.I. DIRECT GREEN 52
 C.I. DIRECT BLUES 2 and 20

Amongst the developers which are commonly used to couple with the diazotized dyes are:

β -naphthol,
 metaphenylenediamine,
 phenol,
 resorcinol,
 phenylmethylpyrazolone,
 N-phenyl phenylenediamine,
m-toluylenediamine,
 toluene-2 : 4-diamine,
m-phenylenediamine,
 aminodiphenylamine (Fast Blue Developer P).

Method of application

The direct dye is applied in the manner already described according to whether it belongs to Class *A*, *B*, or *C*. After dyeing the goods are rinsed to remove all free colour and then diazotized in a fresh liquor either in another machine or in the same one. In order to ensure complete diazotization the following conditions must be fulfilled:

(a) The bath must contain sufficient free nitrous acid to react with the whole of the dyestuff, and the only way to ensure this is to have a slight excess.

(b) The temperature of the bath must be kept low to prevent decomposition of the diazonium compound which may occur as shown in the following equation:

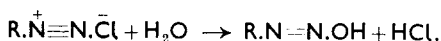

Nitrous acid is not available as a commercial product and is prepared, as required, by dissolving sodium nitrite in water and adding dilute hydrochloric acid or sulphuric acid:



In order that diazotization may take place a second molecule of acid will be required as shown in the equation:

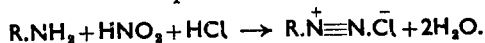

There must, therefore, be at least two molecules of acid for each one of sodium nitrite. The recommended quantities of nitrite and acid, in relation to depth of shade, are shown in Table 16.6.

Table 16.6

Percentage of dyestuff	Composition of diazotizing bath		
	Percentage of sodium nitrite	Percentage of hydrochloric acid 32°Tw (31.5 per cent)	Percentage of sulphuric acid 168°Tw (93.3 per cent)
0.5	1.0	3.0	2.0
1.0	1.5	3.75	2.5
1.5	1.5	4.5	3.0
2.0	1.75	5.25	3.5
3.0	2.0	6.0	4.0
4.0	2.5	7.5	5.0
5.0	3.0	7.5	5.0

The goods are run in a cold liquor containing the appropriate quantities of nitrite and acid for 30 minutes. There must only be a short interval between diazotization and coupling because the diazonium compound is not very stable and is particularly liable to decompose if exposed to strong sunlight.

The developers fall into four classes:

- (i) phenolic compounds which are dissolved in sodium hydroxide;
- (ii) amines which are dissolved in sodium carbonate such as *m*-phenylenediamine and *m*-toluylenediamine
- (iii) diphenylamine compounds such as Fast Blue Developer P which are dissolved in about half of their weight of hydrochloric acid (32°Tw or 31.5 per cent); and
- (iv) a few sulphonic acid compounds such as β -naphthol sulphonic acid which are soluble in water.

In Table 16.7 methods of dissolving a few of the commoner developers are summarized:

Table 16.7

<i>a</i> - and <i>β</i> - Naphthol	<i>Phenol</i>	<i>Resorcinol</i>	<i>m</i> -Phenylene- diamine	<i>m</i> -Toluylene- diamine
1½ lb is stirred into 1 gal of boiling water containing 1½ lb of caustic soda of 76°Tw, and made up to 4 gal with boiling water	1½ lb is stirred into 1 gal of boiling water containing ¾ lb of caustic soda of 76°Tw, and made up to 4 gal with boiling water	1½ lb is stirred into 1 gal of boiling water containing ¾ lb of caustic soda of 76°Tw, and made up to 4 gal with boiling water	1½ lb is dissolved in 4 gal of boiling water containing 8 oz of soda-ash	1½ lb is dissolved in 4 gal of boiling water containing 8 oz of soda-ash

From 1 to 1.5 per cent of the developer is usually required. The developing bath must contain sufficient developer to enter into combination with the whole of the diazotized dye, and an excess can cause no harm, so long as it is rinsed out when the process is complete. Developing is carried out in a cold liquor for a period of 20 minutes and is followed by rinsing. Some of the diazotized direct dye may migrate out of the fibre during developing and unite with the coupling compound in the aqueous phase, becoming deposited in an insoluble state on the surface of the fibre. This causes poor rubbing fastness which can be avoided to a great extent by a final scour in soap at 50°C (122°F).

Exact matching of shade is not easy because of the profound change of colour brought about by coupling. These dyes do not, therefore, find extensive application for very exact matching, but are commonly used for dyeing navy blues and blacks of moderate fastness at a low cost. The washing fastnesses (S.D.C. No. 3 test) are quoted below, the figures in brackets representing the corresponding fastness of the direct dye before it has been diazotized and developed.

Table 16.8

<i>Dye</i>	<i>C.I. number</i>	<i>Wash-fastness</i>
Diazo Fast Yellow 3GLL	DIRECT YELLOW 64	4 (3)
Chlorazol Orange TR	DIRECT ORANGE 10	4-5 (2)
Diazophenyl Red LN	DIRECT RED 126	4
Rosanthere Fast Bordeaux 2BL	DIRECT RED 127	2-3
Diazamine Blue G	DIRECT BLUE 120	4
Diazamine Fast Green GL	DIRECT GREEN 52	3
Chlorazol Black BH	DIRECT BLUE 2	3 (2)
Chlorazol Black JH	DIRECT BLUE 20	3-4 (4)

Coupling with diazonium salts

In producing the developed colours, the direct dyestuff is diazotized on the fibre, and the diazonium compound couples with a suitable developer. With the coupled dyes the process is reversed. The cotton is dyed with a direct dye containing an amino or hydroxyl group and the dyed fibre is then treated with a solution of a diazotized base. An example is Benzo Para Deep Brown G (C.I. DIRECT BROWN 152), (24),

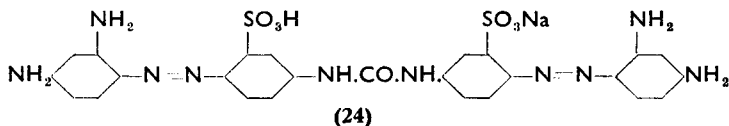

which, after it has been coupled with diazotized paranitroaniline, gives a reddish-brown shade with a light-fastness of 3 and a wash-fastness of 3-4. A few direct dyes which respond to this treatment are shown in Table 16.9.

Table 16.9

Dye	C.I. number	Wash-fastness	
		Uncoupled	Coupled
Diphenyl Orange GG	DIRECT ORANGE 6	2	2-3
Chlorazol Orange TR	DIRECT ORANGE 10	2	4-5
Direct Red O	DIRECT RED 33	3	4
Carbide Black ER	DIRECT BLACK 4	1-2	2-3

Paranitroaniline, which is the only base used for coupling, is a yellow crystalline substance, (25).

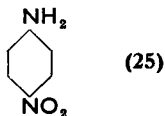

The diazotization of this primary amine is somewhat complicated by the fact that its hydrochloride is insoluble in cold water and, of course, the operation cannot be carried out at a high temperature. In order, therefore, to diazotize the base, its hydrochloride must be precipitated in the form of minute crystals, and these are treated with nitrous acid solution. The crystals must be small so that they offer a great surface area, because, if they are larger, the reaction is so slow that some unchanged paranitroaniline may remain. The procedure is to stir 2 lb of the base with 5 pints of hydrochloric acid (32°Tw or 31.5 per cent concentration) mixed with 5 pints of boiling water. The mixture is boiled, with stirring, until the base has completely dissolved. Six gallons of cold water are then added with constant vigorous

stirring. This causes the precipitation of the paranitroaniline hydrochloride in extremely small crystals. The mixture is cooled to 15.6°C (60°F). In hot weather 5 lb of ice may be added. When the temperature reaches 60°F, but not before, 1 lb 2 oz of sodium nitrite is added in one lot, and the mixture well stirred. The solution is now diluted with water to 10 gallons, when it will contain 2 per cent of paranitroaniline as its diazonium salt. The solution is not very stable, but it may be kept for 2 or 3 days in a stone or wooden vessel, covered to protect it from the action of light, the temperature being kept below 60°F by the addition of ice if necessary.

The dyed cotton requires the equivalent of 0.75 to 1 per cent of the weight of the goods of diazotized paranitroaniline. Coupling will be completed after running in a cold liquor for $\frac{1}{2}$ hour. When the process is finished any uncoupled base should be removed by thorough rinsing, and finally a scour in soap solution is necessary to remove any loose colour.

After-treatment with Formaldehyde

There are a few direct dyes of which the wet-fastness can be improved somewhat by treatment with formaldehyde. The exact reaction which takes place has not been established, but there can be little doubt that dye molecules are linked together by formation of methylene bridges. Fierz-David (*Kunstliche Organische Farbstoffe*) has suggested that reactions of the type shown in the equation below take place. The method of treatment is to

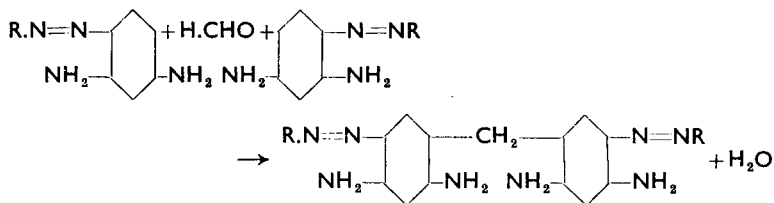

rinse the dyed cellulosic material and then run in a liquor containing 2 to 3 per cent of formaldehyde (40 per cent) and 1 per cent of acetic acid (30 per cent) at 70°–80°C (160°–180°F) for 30 minutes.

Some examples, together with the improvement in wash-fastness achieved by formaldehyde treatment, are tabulated below:

Dye	C.I. number	Wash-fastness S.D.C. No. 3 test	
		Untreated	Treated
Chlorazol Black LF	DIRECT BLACK 4	2	3
Chlorantine Fast Black 2G	DIRECT BLACK 22	2-3	3-4
Direct Black E	DIRECT BLACK 38	2	3

After-treatment with metallic salts

There are many direct dyes of which the wet-fastness is improved by after-treatment with a copper salt such as copper sulphate or, alternatively, specially prepared mixtures of copper salts and cationic resin-fixing agents. Some of the dyes which have been specifically developed for this treatment are the Cuprofix, the Cuprophenyl, and the Coprantine colours, as well as many others not necessarily classified in distinctive groups. Examples of mixtures of copper salts and cationic products for after-treatment are Resofix C and Coprantex B.

The present practice of copper after-treatment owes its origin to the discovery in 1915 that some of the *oo'* dihydroxy direct dyes would form complexes with copper. The hue of the new derivative was usually somewhat duller, but both the light- and the wet-fastnesses were improved. An example is Sirius Super Green BTL in which the ethoxy and hydroxyl groups are in the *oo'* positions as shown below:

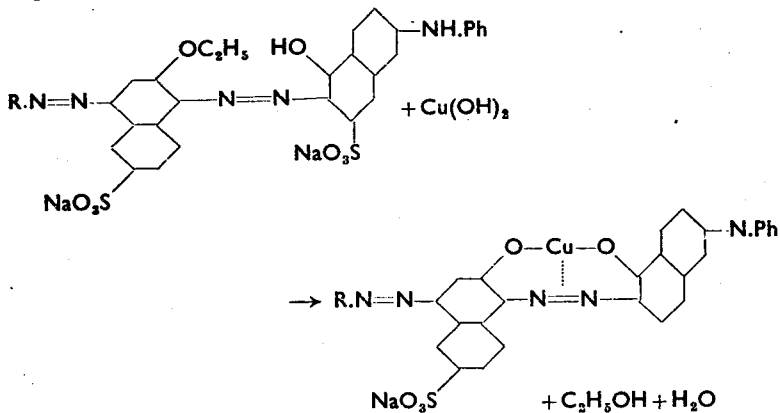

Very shortly afterwards it was found that it was not necessary to dye with the copper complex because the latter could be formed on the fibre by treatment with a copper salt after dyeing with dyes containing the following structural units:

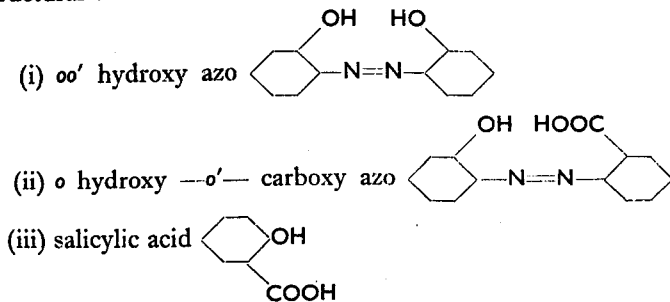

(iv) the hydroxyl may be substituted by methoxy ($-\text{O}\cdot\text{CH}_3$) or ethoxy ($\text{O}\cdot\text{C}_2\text{H}_5$) groups.

The dyed goods are rinsed and treated in a fresh bath containing 1 to 3 per cent of acetic acid (30 per cent) and 1 to 3 per cent of crystalline copper sulphate, according to the depth of the shade, at 70°C (158°F) for 20 to 30 minutes. A few copper after-treated dyes are quoted in Table 16.10 to illustrate their general fastness properties.

Table 16.10

Dye	C.I. number	S.D.C.		S.D.C. Light- fastness
		Wash-fastness		
		Untreated	Treated	
Cuprophenyl Navy Blue				
BL	DIRECT BLUE 156	4	4-5	5-6
Copper Blue G	DIRECT BLUE 8	2	2-3	4-5
Cuprofix Navy Blue CGBL	DIRECT BLUE 156	4	4-5	5
Coprantine Grey G	DIRECT BLACK 51	2	3	4

It must be borne in mind that the presence of traces of copper cause accelerated degradation of rubber on storage. Copper after-treated dyes are therefore unsuitable for yarns to cover, or fabrics containing, rubber threads.

Treatment with potassium bichromate with or without copper sulphate

There are direct dyes the wash-fastnesses of which are improved by after-treatment with potassium bichromate in the following manner. Immerse for 20 to 30 minutes at 60° to 80°C (140° to 180°F) in a solution containing 1 to 3 per cent of potassium or sodium bichromate and 1 to 2 per cent of acetic acid (30 per cent). Fastness to light as well as washing is sometimes improved by substituting 1 to 2 per cent of bichromate, 1-2 per cent of copper sulphate, and 2-4 per cent of 30 per cent acetic acid.

Cationic fixing agents

Some of these are products known as Fixanol C, Sandofix WE, Lyofix EW, and Tinofix. They are cationic surface-active compounds which unite with the dye anion, producing a more complex molecule which has better wet-fastness. The use of these compounds does, however, tend to reduce light-fastness. The chemical constitution of Fixanol C and the nature of its action are described in Chapter 9.

The method of application is usually to treat the dyed cellulosic material with 1 to 3 per cent of the fixing agent at 70°C (160°F) for a period of 15 to 20 minutes. The quantity which is necessary will depend upon the depth of the shade but also on the concentration of the product. A small amount

of formic or acetic acid is often necessary to assist in bringing the cationic product into solution (see R. GILL, *J.S.D.C.*, 1955, 71, 380).

Application of direct dyes above 100°C

Butterworth (*J.S.D.C.*, 1953, 69, 362) reported upon a comprehensive study of the effects of dyeing cellulosic fibres, with special reference to viscose, at temperatures above 100°C. The work was carried out with viscose rayon cakes because they presented the greatest levelling problems. High-temperature dyeing improves migrating powers of Class *B* and *C* dyes, to a great extent in the absence of electrolytes, but to a lesser degree when they are present. It is therefore recommended that the dye should be applied and given opportunity to become uniformly distributed at the high temperature before the addition of the salt, which should be made in portions and at intervals or by a drip feed. At temperatures of 95° (203°F) to 100°C it often requires 4 to 6 hours boiling with Class *B* and *C* dyes to reach a satisfactory degree of levelness in continuous filament rayon cakes, but the time can be reduced to 1 to 1½ hours at 120°C (248°F).

It is known that there is a tendency for direct dyes to decompose when boiled for a long time owing to reducing action of the cellulose, especially when conditions are slightly alkaline. This effect is more pronounced at temperatures above 100°C and can interfere seriously with successful dyeing. Butterworth (*loc. cit.*) examined a large number of substantive dyes and classified them into three groups.

Group 1

Dyes which are stable at high temperatures, 120° to 130°C (248° to 266°F), under more or less neutral conditions and also show considerable resistance under alkaline conditions.

Group 2

Dyes not unduly affected by high temperatures in the absence of alkali, but completely destroyed under alkaline conditions.

Group 3

Dyes decomposed under both neutral and alkaline conditions.

When applying dyes of *Group 2* it is, of course, important to avoid the possibility of the liquor becoming alkaline. This may present difficulty sometimes because alkalis can be introduced inadvertently with the dye, with softened water, or may be present in the goods. It is therefore advisable that the dye liquor should be buffered with sufficient ammonium sulphate to give an initial concentration of 1 lb per 100 gallons. It must be borne in mind that this is equivalent to adding an electrolyte, a factor to be taken into account when using Class *B* dyes. Dispersol VL is also of assistance and is stable at the temperatures under consideration.

Classification of some direct dyes for high temperature dyeing

	<i>Group 1</i>	<i>Group 2</i>	<i>Group 3</i>
C.I. DIRECT YELLOWS	28, 46, 29, 44	11, 8, 12	
C.I. DIRECT ORANGES	1	48, 37, 23	26, 12
C.I. DIRECT BROWNS	1A	59, 3	
C.I. DIRECT REDS	27	1, 76	80, 81, 79
C.I. DIRECT BLUES	86	10, 6, 28, 20, 66, 67, 40	138, 2
C.I. DIRECT GREENS		8, 38	
C.I. DIRECT BLACKS		4	51

Many of the direct dyes pass the temperature of maximum exhaustion below 100°C, and even at the normal boiling point adsorption has become diminished. This phenomenon is more marked at temperatures above 100°C and, after the dye has been levelled at the elevated temperature, it is often advisable to cool back to 85° to 90°C (185° to 194°F) to obtain the best value from the dyes.

Stripping direct dyes

Unless they have been after-treated the stripping of direct dyes is in most cases easy. The colour can usually be removed by boiling with sodium hydrosulphite, by bleaching with a solution of sodium hypochlorite containing 1.5 to 2 g per litre of available chlorine, or by boiling with 1 to 2 per cent of sodium chlorite which has been brought to a pH between 3 and 4 with formic or acetic acid. When a cationic fixing agent has been used the latter must be removed, not only to liberate the dye, but also because it would act as a mordant for an anionic dye if the goods have to be redyed. The effect of this would be that the affinity would be so great that the dye would be taken up unevenly. The stripping of the cation active component is brought about by boiling for 30 minutes with 2 per cent of the weight of the goods of formic acid.

If a copper after-treated dyeing is too heavy it can be stripped partially by boiling in a liquor containing 1 to 3 g per litre of ethylenediamine-tetra-acetic acid, an anion-active detergent, and 1 g per litre of sodium carbonate. This treatment removes the copper, and when the shade has been brought down to the desired depth it must be recoppered. If a complete strip is necessary the copper is removed by treatment for 30 minutes at 90°C (194°F) with 1 to 3 per cent of ethylenediaminetetra-acetic acid, followed by treatment at 80°C (176°F) with a solution containing 3 to 5 g per litre of sodium carbonate and 2 to 3 g per litre of sodium hydrosulphite.

17 · Mordant dyes

THE mordant dyes are capable of combining with metallic oxides to form insoluble coloured lakes. Many of the old natural dyes such as Alizarin, Logwood, Weld, and Fustic were dyed on fibres which had previously been impregnated, or mordanted, with hydroxides of chromium, tin, or aluminium. Some of these natural products were replaced by their synthetic equivalents and, after the structure of Alizarin had been determined, the range was increased by the addition of many analogous substances derived from anthraquinone.

Mordanting depends upon the fact that a number of metallic elements can act as acceptors to electron donors to form co-ordinate bonds. In the covalent bond each participant contributes one electron but co-ordination depends upon one atom or radical with one or more lone pairs of electrons, often referred to as ligands, donating one or more of these lone pairs to the acceptor which has empty orbitals of appropriate energy available. In structural formulae it is not an uncommon practice to use the arrow \rightarrow pointing from the donor to the acceptor to signify co-ordination.

Since chromium is the most commonly used mordant the principle of co-ordination will be illustrated with this element. In metallic chromium the 1s, 2s, 2p, 3s, and 3p orbitals are filled with pairs of electrons, as in the argon atom, but the 4s and 3d orbitals are only partially filled as shown:

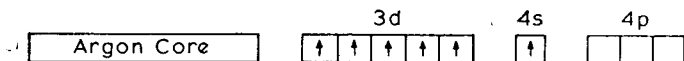

In the trivalent chromium ion the 4s and two of the 3d electrons are lost, leaving an equivalent net positive charge.

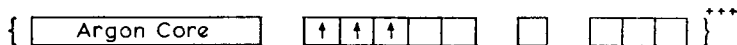

Co-ordinate links are formed by some, or all, of the vacant 3d, 4s and 4p orbitals accepting lone pairs from donors, 6 and 4 pairs being commonest. The simplest illustration of mordant action is seen in the behaviour of the chromium ion towards alizarin. The chromium combines with three of the hydroxyl groups in the 1 position forming salt linkages, as does sodium with phenol in sodium phenate. The adjacent quinonoid oxygen then donates a pair of electrons yielding a co-ordinate bond. The complex therefore consists of three alizarin molecules attached to one chromium atom by three ionic, and also by three co-ordinate, bonds. This would

involve a somewhat cumbersome structural formula so, for simplicity, either of the following methods have been used:

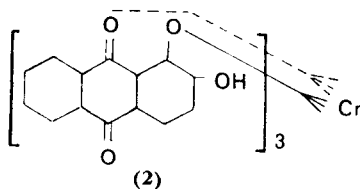
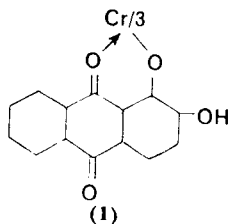

In (1) Cr/3 indicates that there are three alizarin molecules attached to the chromium and in (2) the co-ordinate bonds are shown as dotted lines. The large complex molecule which is formed from the three alizarin molecules is obviously less water-soluble, when on the fibre, and therefore possesses greater wet fastness.

Natural mordant dyes

There was a time when few naturally-occurring dyes were of greater importance than madder because of its extensive use for dyeing bright red shades. The best madder red was dyed in Turkey and, from this, the name Turkey Red ultimately became a general term for all comparatively fast dyeings in this colour. The active mordant dye in madder is Alizarin, extracted from the root of the plant which was cultivated extensively in southern Europe, the Middle East, and Asia. It was demonstrated by Graebe and Liebermann in 1868 that Alizarin was 1 : 2 dihydroxyanthraquinone, (3):

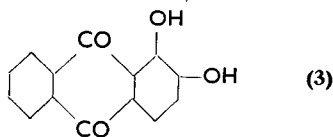

They synthesized the substance from dibromoanthraquinone, but the method did not prove commercially successful. In 1869 Perkin took out a patent covering the preparation of Alizarin by sulphonating anthraquinone and fusing the product with sodium hydroxide; the yield was subsequently improved by the addition of an oxidizing agent such as sodium chlorate or potassium nitrate during the fusion with alkali. Another mordant dye associated with Alizarin which was found in madder was 1 : 2 : 4 trihydroxyanthraquinone, known as Purpurin, (4).

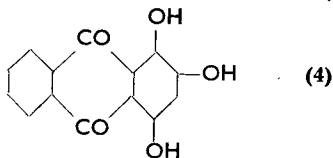

It is now made synthetically and dyes wool a bluish red on an aluminium mordant.

Alizarin crystallizes as dark red prisms which melt at 289° to 290°C (552° to 554°F). It is insoluble in water but dissolves in sodium hydroxide, giving a violet solution of sodium alizerate:

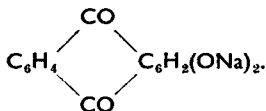

Alizarin is what is known as a polygenetic mordant dye because it develops a variety of colours on different mordants as shown in Table 17.1.

Table 17.1

Mordant	Colour
Aluminium	Red
Tin	Pink
Iron	Brown
Chromium	Puce brown
Copper	Yellowish brown

Dyeing Turkey Red with Alizarin was a complicated process but, nevertheless, was used extensively because it was the only method by which cotton goods could be dyed a bright red of reasonable fastness at a moderate cost. The procedure is described by Cain, Thorpe, and Linstead (*The Synthetic Dyestuffs*, p. 410). The scoured cotton is worked in a 10 per cent solution of Turkey Red oil (sulphonated ricinoleic acid) and, when saturated, it is squeezed and dried at a temperature between 40° and 50°C (104° and 122°F). This operation is repeated twice and the cotton goods are then worked in a liquor containing aluminium acetate, wrung out, and dried at 40° to 50°C, after which the operation is repeated. The cotton is next treated at 30° to 40°C (86° to 104°F) in a liquor containing 6 lb of ground chalk per 100 gallons of water, and afterwards dyed with 15 per cent of Alizarin paste (20 per cent strength). The goods are entered at 20° to 25°C (68° to 77°F) and worked about at this temperature for 20 minutes. The bath is then brought to 60°C (140°F) over a period of 30 minutes, and dyeing is continued for 1 hour. The cotton is subsequently wrung out and dried, exposed to steam at atmospheric pressure for 2 hours, and finally brightened by washing well in a hot soap solution.

Alizarin was formerly dyed on wool mordanted with aluminium or chromium. The aluminium mordant was deposited by immersing the goods in a 6 to 10 per cent solution of alum, to which 5 to 8 per cent of potassium hydrogen tartrate had been added. The wool was entered into the cold

liquor and the temperature was raised gradually to the boiling point, where it was maintained for 30 minutes. After washing off, the process was completed by dyeing with 10 per cent of Alizarin paste and 4 per cent of calcium acetate. Wool was also mordanted with chrome by boiling in a liquor containing 3 per cent of bichromate and 1 per cent of sulphuric acid.

Cochineal consists of the dried powdered bodies of the female species of the insect *Coccus cacti*, gathered from plants of the prickly-pear family growing in Central and South America, Mexico, and the East and West Indies. The component which is the mordant dye is known as carminic acid, (5),

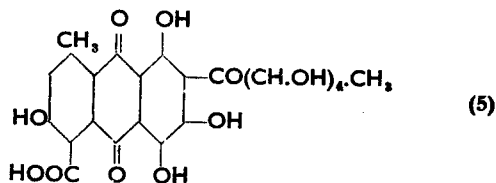

and is soluble in water, giving a scarlet red solution that becomes violet on the addition of alkali. It gives a range of shades on different mordants.

<i>Mordant</i>	<i>Colour</i>
Chromium	Purple
Aluminium	Crimson
Tin	Scarlet
Iron	Purple

It was used mainly for dyeing wool and silk scarlet for such purposes as hunting coats or uniforms, because the brightness of the colour accompanied by good light-fastness made it supremely suitable for such purposes. The wool was mordanted with 6 per cent of stannous chloride and 6 per cent of oxalic acid, and then dyed with 20 per cent of cochineal.

A naturally-occurring mordant dye, used extensively until a few years ago, and now probably the only one still in use, is logwood. It yields a navy blue or a black, with what is called a good bloom, when dyed on chrome mordanted wool. Until the advent of acid mordant dyes, which will be described later, it was the only dyestuff with which wool could be dyed black with any measure of fastness.

Logwood is extracted from campeachy wood, obtained from trees growing in South America, although the best varieties come from Honduras and Jamaica. Formerly the dyer purchased either the wood itself in the form of chips or an extract. Freshly-cut campeachy wood is colourless, the potential colouring matter being present in the form of a glucoside. When the chips are moistened and allowed to ferment the glucoside decomposes into glucose and a substance is formed called haematoxylin, $C_{16}H_{14}O_8 \cdot 3H_2O$, which is still colourless, and has the constitution shown in (6) (LALOR AND

MARTIN, *J.S.D.C.*, 1959, 75, 513). When haematoxylin is exposed to air or treated with an oxidizing agent, haematein, (7), is formed which yields

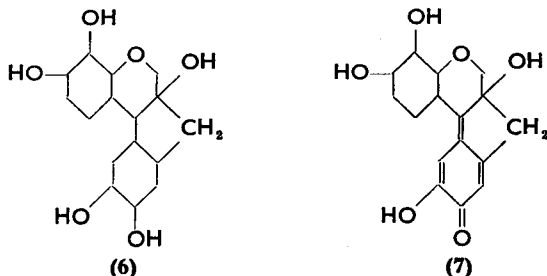

reddish-brown crystals, and it is this substance which is the active mordant dye. When dyeing with logwood either haematein or haematoxylin may be used, but there must be sufficient oxidizing agent in the dyebath to convert the latter to haematein. The so-called oxidizing mordant, which is acidified dichromate, is used. The chromic acid liberated oxidizes the haematoxylin whilst the wool is mordanted at the same time with Cr_2O_3 produced by reduction of the dichromate by the fibre.

The use of logwood chips or haematoxylin was discarded long ago. Only haematein has been used in more recent times, usually in the form of crystals but sometimes as an extract. Whilst haematein gives various shades on different mordants, the blues and blacks dyed on chrome are the only ones of importance. The wool is mordanted by boiling for 30 minutes with 3 per cent of potassium bichromate (sodium bichromate may be substituted) and 1 per cent of sulphuric acid. Although the chromium is in the hexavalent state in the bichromate the wool reduces it to Cr_2O_3 or $\text{Cr}(\text{OH})_3$, both of which contain trivalent chromium. After mordanting, the goods are rinsed and transferred to a fresh liquor, where they are dyed with 4 to 6 per cent of haematein crystals, after which they are rinsed and scoured with soap or a synthetic detergent at 60°C (140°F) to remove any loosely adhering colour lake. Fastness is improved by back chroming, when the dyed goods are treated at 82.2°C (180°F) in a bath containing 1 per cent of bichromate, which presents to any haematein which has not formed the insoluble lake a further opportunity to do so.

Wool dyed black or navy with logwood has very good wash-fastness, but it has a tendency to take on a greenish hue after prolonged exposure to light. This was, to some extent, inhibited by the addition of a red or violet dye. Logwood on wool can be detected by boiling in 5 per cent hydrochloric acid. Most of the colour is extracted, giving a red solution which becomes violet on neutralization.

Logwood was occasionally used for cotton when it was dyed on an iron mordant fixed with tannic acid. The dyeing of cellulosic fibres with logwood has been discarded long ago and is now only of historical interest.

Dyeing silk with haematein had a wide application, especially because it could be combined with a substantial degree of weighting. The silk was soaked in a tannic acid solution at 40° to 45°C (104° to 113°F) and, after squeezing, transferred to a bath containing ferrous sulphate or some other iron salt. Such treatment usually added 20 to 30 per cent to the weight, and the operation could be repeated time after time until, it was claimed, fifteen repetitions would give a 400 per cent increase to the weight of the silk. After mordanting, the goods were dyed with 5 to 6 per cent of haematein crystals which was followed by soaping. Lyons Black was dyed with logwood on mordanted silk and weighted by successive immersions in iron nitrate, sodium carbonate, and potassium ferrocyanide solutions.

Acid mordant dyes

Nietzki (*J.S.D.C.*, 1889, 5, 175) discovered that if a salicylic acid unit was present in a dyestuff, as in Alizarine Yellow 2G, (8),

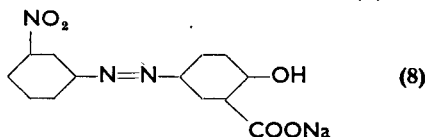

the colour could be rendered faster to washing if, after dyeing in the ordinary way, it was boiled with potassium dichromate to convert it into a chromium complex. The observation, however, received little attention at the time and no progress was made until, in 1904, Sandmeyer and Hagenbach discovered that *o*:*o'*:dihydroxy azo dyes could co-ordinate so easily with chromium that they could be dyed as acid dyes and mordanted by after-treatment with potassium or sodium dichromate. One of the simplest of these dyes, still in common use, is Eriochrome Black T, (C.I. MORDANT BLACK 11), shown in (9), and another example is Solochrome Orange M (C.I. MORDANT ORANGE 1), (10). These dyestuffs are known as the acid

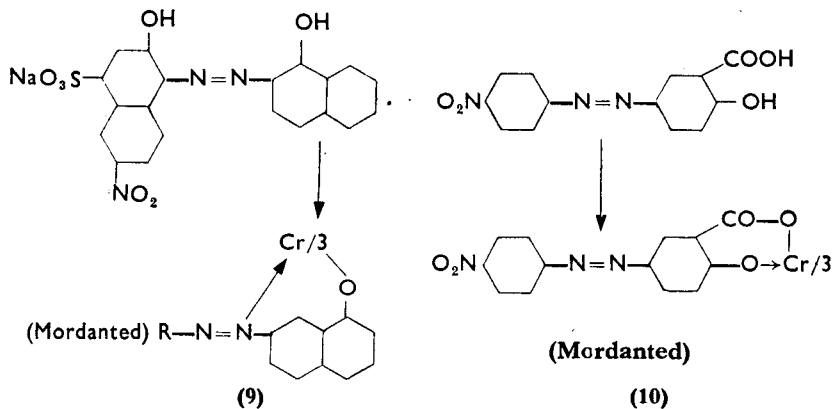

mordant dyes and are used very extensively for wool, and also for dyeing polyamide fibres. They have exceedingly good wet-fastness and most of them possess satisfactory light-fastness. These properties make them particularly suitable for goods which have to be washed frequently, such as men's socks. The fastnesses of a few typical examples are shown in Table 17.2.

Table 17.2

Dye	C.I. number	Wash-fastness S.D.C. No. 3	Light-fastness (S.D.C. Test)
Solochrome Flavine G	MORDANT YELLOW 5	5	6
Omega Chrome Yellow ME	MORDANT YELLOW 30	5	6
Chrome Fast Orange R	MORDANT ORANGE 10	5	5-6
Solochrome Red B	MORDANT RED 9	5	6-7
Eriochrome Azurole B	MORDANT BLUE 1	5	4
Eriochrome Black T	MORDANT BLACK 11	5	7

The commonest method of application is to dye in an acid dyebath and, when exhaustion is complete, add the appropriate amount of dichromate to the liquor and continue boiling for a further 30 minutes. Most of the acid mordant dyes contain two sulphonic acid groups and are of comparatively low molecular weight, so that they are molecularly dispersed in solution and have good levelling properties. They therefore present the opportunity to produce dyeings of good fastness at a comparatively low dyestuff cost without risk of spoilages due to bad penetration. There are, on the other hand, two disadvantages. The shades are all rather dull and matching is troublesome because after-chroming usually brings about a considerable change of colour.

The usual method of dyeing is to make up the dyebath with between 2 and 5 per cent of acetic acid (40 per cent) and 10 per cent of crystalline Glauber's salt. Some surface-active penetrating agent can be added if desired. The temperature of the bath is raised to 50° to 60°C (120° to 140°F) and the goods are entered. The liquor is then brought to the boil during a period of 30 minutes, when 1 to 2 per cent of sulphuric or formic acid may be added to complete exhaustion, and boiling is continued for a further 20 to 30 minutes. When the dyebath is exhausted and boiling has been continued for long enough for the colour to be level, the temperature is allowed to drop slightly and a quantity of potassium or sodium dichromate equal to half of the weight of the dye used, is added. The amount of dichromate, however, should never exceed 2 per cent on account of the risk of damaging the wool, and it should never be less than 0.25 per cent. Chroming is continued at the boil for 30 to 45 minutes. It is extremely important to make certain that the goods are dyed uniformly before the

dichromate is added, because there will be no further migration afterwards. The dye liquor must also be virtually exhausted before mordanting, because if dye remains in solution it will be precipitated on the surface of the fibres in the form of its insoluble lake, and cause lack of fastness to rubbing.

There is sometimes an advantage in dyeing acid mordant colours with formic instead of sulphuric acid. This applies particularly in cases where the goods are mixtures of wool and cellulosic fibres because traces of sulphuric acid not rinsed out can cause tendering of the cellulose; formic acid is less dangerous because it volatilizes. When using some of the less level dyes, or when the goods are difficult to penetrate, it is advisable to make up the dyebath with 10 per cent of Glauber's salt and 3 to 5 per cent of ammonium sulphate, raise to the boil and complete exhaustion by adding 1 per cent of sulphuric or formic acid after boiling for $\frac{3}{4}$ hour.

The shades can be brightened by the addition of acid dyes at the commencement of the dyeing, but their presence will diminish the wet-fastness. The dyes must be unaffected by dichromate and such that can be dyed satisfactorily at the pH necessary to exhaust the acid mordant dye. Some recommended dyes are given below.

C.I. ACID YELLOWS	51, 78
C.I. ACID ORANGE	47
C.I. ACID REDS	127, 133, 129, 131, 120, 85, 123, 125, 121
C.I. ACID BLUES	13, 59, 102, 12, 83, 90, 126, 129, 82, 150
C.I. ACID VIOLET	17
C.I. ACID GREENS	7, 9, 16, 2, 25.

If a correction to the shade is necessary and the standard of fastness is to be maintained, the most convenient procedure is to cool the liquor to 60°C (140°F) and add sufficient sodium acetate to convert any free sulphuric to acetic acid, and then correct with an acid mordant or a premetallized dye. If the amount of dye required is not great the wool will already contain sufficient Cr_2O_3 to combine with the acid mordant dye. A few dyes suitable for shading are shown below.

C.I. MORDANT YELLOWS	5, 17
C.I. MORDANT ORANGES	5, 10
C.I. MORDANT BROWNS	33, 52
C.I. MORDANT REDS	7, 19, 33, 5
C.I. MORDANT BLUE	1
C.I. MORDANT GREEN	35
C.I. MORDANT BLACKS	38, 40, 13.

It is also possible to shade with a limited number of acid dyes (see below) which are not affected by dichromate. They are less fast and their use is undesirable if more than a small proportion is required. It is again advisable

to cool the dyebath to 60°C (140°F) and to add sodium acetate to convert sulphuric to acetic acid. Many of the colours indicated below are quite bright and are useful to correct a shade which is too flat.

C.I. ACID YELLOW	51
C.I. ACID ORANGE	47
C.I. ACID BROWN	27
C.I. ACID REDS	85, 133, 123
C.I. ACID VIOLETS	9, 17
C.I. ACID BLUES	5, 126, 98, 59, 90
C.I. ACID GREENS	9, 25
C.I. ACID BLACK	50.

The metachrome or chromate method

There are a certain number of acid mordant dyes which can be dyed and mordanted simultaneously, using what is commonly called the metachrome mordant. This consists of one part of sodium or potassium dichromate with two parts of ammonium sulphate. The procedure which is recommended is to treat the scoured wool for about 20 minutes at 40°C (105°F) in a bath containing 2 to 5 per cent of metachrome mordant, 5 to 10 per cent of Glauber's salt crystals and, if desired, $\frac{1}{4}$ to $\frac{1}{2}$ lb per 100 gallons of a surface-active penetrating agent. After running at 40°C (105°F) for 20 minutes the dissolved dye is added and the liquor is brought to the boil over a period of $\frac{3}{4}$ hour and retained at this temperature for a further 1 to 1 $\frac{1}{2}$ hours. When dyeing heavy shades it is advisable to complete exhaustion by adding $\frac{1}{2}$ to 1 per cent of acetic acid (40 per cent) or half the amount of formic acid (85 per cent), 30 minutes before the dyeing is finished. Ammonium acetate may be substituted for ammonium sulphate in the metachrome-mordant mixture when using colours known to be unlevel dyeing.

The advantages of the metachrome, also known as the synchromate process, are that: the dyeing is carried out in one stage which means greater production from the plant; matching is easier because the final shade is produced during the dyeing; and allowance does not have to be made for the changes which are caused by after-chroming. The disadvantages are that the range of shades is limited and, if the dyeing is unlevel, it is almost impossible to correct it.

An exhaustive investigation of the acid mordant dyes was made by Stevens, Rowe, and Speakman (*J.S.D.C.*, 1943, 59, 165) with a view to ascertaining why some responded to the metachrome-mordant method and others did not. In the first place they examined the behaviour of wool towards the mordant in the absence of the dye. It was found that, after boiling for 6 hours, 99.7 per cent of the chromium in the dyebath had been adsorbed by the wool and about 42 per cent of the total ammonia had been evolved, leaving the liquor with a pH of 5.02. They suggested that the first

stage in a series of reactions was that the bichromate hydrolysed and the chromic acid which was liberated combined with the wool:

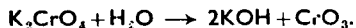

The liquor did not become alkaline, however, because the potassium hydroxide which was liberated reacted with the ammonium sulphate:

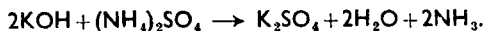

The CrO_3 subsequently became reduced to Cr_2O_3 by the wool. The conclusion which was reached was that dyes not responding to the process will not exhaust unless the pH is low, whilst all those which develop a good affinity between pH 5 and pH 7 can be applied by the metachrome method.

It is obvious that considerable advantages would accrue if it were possible to solubilize the chromium lake so that it could be applied to wool by the normal dyeing methods. Developments in this direction arose from the discovery of Bohn in 1912 that it was possible to make soluble chromium complexes of azo mordant dyes containing a salicylic acid residue. In 1915 Ciba were responsible for a great advance in the field of metal complex or premetalized dyes when they brought out the Neolan range of dyes. They are, for the most part, based on the *o*:*o'*:dihydroxyl azo structure such as Neolan Blue B, (11). At the same time the German I.G. produced a similar range called the Palatine Fast dyes of which Palatine Blue GGN, (12), is an example. They are classified as 1:1 metal complex dyes because they

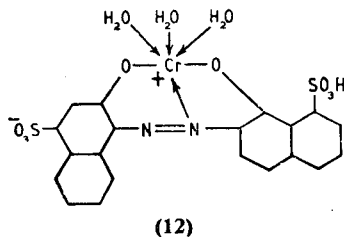
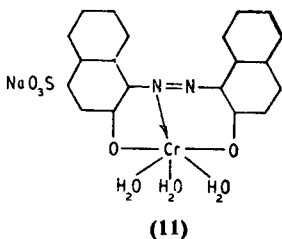

contain only one dye molecule for each metallic atom. The sulphonic acid groups render them soluble but they have to be applied from an acid dye-bath containing 5 to 8 per cent of sulphuric acid. They are quicker to apply and easier to match because there is no after-treatment causing alteration of colour. Some of the colours are brighter than the acid mordant dyes, although they do not compare with the level dyeing and fast acid dyes. Their wet-fastness is slightly lower than that of the acid mordant dyes, but still very good, as shown in Table 17.3. It was shown by Ender and Muller (*Melliand Textilber.*, 1938, 19, 181) that the fastness of the Palatine Fast dyes could be attributed to the formation of a co-ordinate valency link between the dye and the wool keratin.

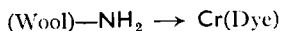

Table 17.3

Dye	C.I. number	Fastness (I.S.O.)	
		Light	Washing (alteration)
Neolan Pink BA	ACID RED 186	5-6	4-5
Neolan Blue 2R	ACID BLUE 154	5-6	4
Neolan Red 3B	ACID RED 191	5	4
Neolan Yellow G	ACID YELLOW 98	5	4
Neolan Violet 3R	ACID VIOLET 56	6	4

Method of application

The method of dyeing which was used in the earlier times after the introduction of this class was to scour the wool and then to run it in a dye-bath containing 8 per cent (of the weight of the wool) of sulphuric acid, and 10 to 20 per cent of Glauber's salt at 60°C (140°F) for 15 minutes. The dyestuff, which had previously been dissolved, was then added through a strainer, after which the liquor was raised from 60°C (140°F) to the boil over a period of 30 minutes, and boiling was continued for 1 to 1½ hours.

An investigation carried out by Rattee (*J.S.D.C.*, 1953, 69, 288) showed that the 1 : 1 metal complex dyes could be applied satisfactorily from a dyebath containing only 5 per cent of sulphuric acid on the weight of the goods. It was suggested that there are three factors involved in the adsorption of these dyes by wool:

- (1) Affinity of the sulphonic acid groups for the ionized basic sites in the fibre.
- (2) Affinity of the positively charged chromium for the acidic groups in the wool.
- (3) Formation of co-ordinate compounds between the fibre and the dye.

As the pH falls from the level of 7, factor 2 diminishes in importance. Further decrease in the pH brings about increased rate of exhaustion owing to the activity of the ionized basic groups in the wool (factor (1)) until a maximum is reached between pH 2 and pH 3. Finally, below this peak in the rate of exhaustion the adsorption diminishes; but it is only during this phase that any appreciable degree of levelling takes place. It is also at this stage that the secondary amino groups become ionized and are therefore no longer available for complex formation. It is, however, not desirable to have to rely on such a low pH for levelling because it tends to bring about some hydrolysis of the keratin.

Neolan Salt P, an anionic product, Palatine Fast Salt O, a fatty acid ethylene oxide condensate, and Dispersol A, an aliphatic ethylene oxide condensate, have been recommended as assistants capable of permitting

level dyeing to be obtained with reduced quantities of acid. According to Rattee (*loc. cit.*) the value of these assistants has been disputed. Lissapol N (ethylene oxide nonyl phenol condensate) is claimed to be a somewhat better levelling agent and it is recommended that dyeing should be carried out with 2 per cent of Lissamine N, 5 per cent of sulphuric acid, and 20 per cent of Glauber's salt on the weight of the wool. It is probable that the non-ionic surface active compound forms a complex with the dye, with a corresponding increase in particle size. These particles are absorbed at the liquid/fibre interface. Adsorption within the fibre, however, can only occur after the breakdown of the complex, which is a slower process and leads to more uniform distribution of the dye.

The amount of acid required with the Neolan dyes does not depend entirely upon the weight of the load but also upon liquor ratio. The wool itself absorbs 4 per cent of acid at the boil and there should be sufficient left in the dyebath to maintain the pH between 2.0 and 2.4. When dyeing without Neolan Salt P, a general rule to be observed is to use 4 per cent of sulphuric acid (168°Tw, 93.5 per cent) of the weight of the load, plus an additional 11 oz per 100 gallons of liquor (0.7 g per litre). With heavy shades, however, this may be increased to 1 lb per 100 gallons (1 g per litre). It is recommended that boiling should be continued for at least 1½ hours but should not under any circumstances exceed 3 hours.

Shading can be carried out only with the more level-dyeing Neolan colours. Steam should be turned off before the addition is made and the liquor should be brought to the boil for a further 20 to 30 minutes.

In Chapter 15 some reference was made to the fact that tone and tone dyeings can be produced on mixtures of chlorinated and unchlorinated wools with selected dyes. The Neolan dyes are particularly suitable for this effect. The dyeing is carried out with 4 per cent of formic acid (85 per cent) instead of sulphuric acid or, alternatively, with 8 per cent of ammonium sulphate. The result of this method of dyeing is sometimes referred to as the Camieau effect.

The Neolan and Palatine dyes were the first of the commercially successful premetallized colours, and they were solubilized by the incorporation of one or more sulphonic acid groups. More recently the 2 : 1 premetallized dyes have appeared as the Cibalan, Irgalan, and Lanasyne ranges. The significance of the prefix 2 : 1 is that they contain two dye molecules for each atom of the metallic element. The simplest 2 : 1 complex which may be used to illustrate the general structure is that of 2 : 2'-dihydroxy azobenzene, (13) (SCHETTY, *J.S.D.C.*, 1955, 71, 705). It will be noticed that one hydroxyl group has formed a co-ordinate link with the chromium, which resonates with the others, leaving a net negatively charged complex capable of attracting any univalent cation.

The substance (13) is soluble in water, brownish-red in colour, exhausts well from a neutral bath on wool, but gives a dyeing of not particularly

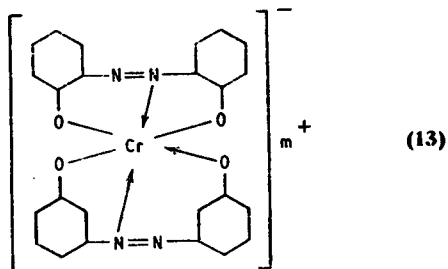

good wet-fastness. The fastness to washing increases with molecular weight which is of the order of 600 in the commercial 2 : 1 metal complex dyes. Water solubility, however, decreases with increase in molecular weight, and the introduction of sulphonic acid groups, whilst making the molecule more soluble, also decreases its affinity in the region of pH 6 to 7. It increases the tendency to give 'skittery' shades, caused by the emphasis of variations in affinity from one fibre to another. It was, therefore, found to be preferable to confer solubility upon the complex molecule by the incorporation of sulphonamoyl ($-\text{SO}_2\text{NH}_2$) and methyl sulphonyl ($-\text{SO}_3\text{CH}_3$) groups, as in Perlon Fast Orange RRS (C.I. number 18875) and Irgalan Brown Violet DL (C.I. ACID VIOLET 78), which are built up from the basic structures shown in (14) and (15).

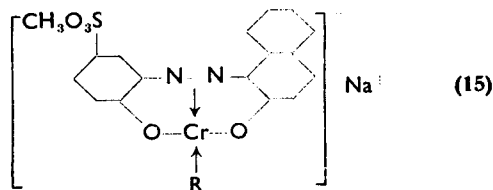
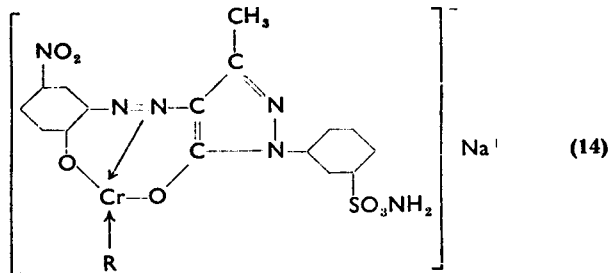

The 2 : 1 complex dyes can be applied from a neutral or faintly-acid liquor, and the prolonged boiling for levelling which is required by the 1 : 1 premetallized dyes is not necessary. The fact that they can be dyed at or near neutrality means that the fast acid dyes can either be applied concurrently or as shading colours, which is impossible with the Neolans on account of the high acidity of the dyebath. Their successful application

depends upon careful control of pH values and a slow and uniform rate of temperature increase from zero to the boil, because these dyes have no migrating power. Their application is assisted by the fact that the curve relating temperature to exhaustion has a steady gradient right up to the boil.

Method of application

The dyebath is made up with 2 to 5 per cent of ammonium acetate, or 2 to 3 per cent of ammonium sulphate. The pH value of the fibre becomes lower with the sulphate than with the acetate, although in both cases the pH value of the liquor may remain the same. For this reason ammonium acetate is often preferred. The scoured wool is treated for 10 minutes at $50^{\circ}C$ ($122^{\circ}F$) in this liquor so that it can acquire a uniform pH value. The dyestuff, previously dissolved, is then added to the dyebath through a strainer, and the liquor is brought to the boil over a period of $\frac{3}{4}$ hour and dyeing is continued at the boil for $\frac{1}{2}$ to 1 hour. Very little migration takes place at the boil and, if desired, it is often possible to cut this period down. The use of Glauber's salt is not recommended because it has no levelling effect, but Tinegal W, Lyogen SMK, and the non-ionic product Cibalan Salt S are of assistance. If, in spite of all precautions, levelling difficulties are experienced, it is advisable, when the temperature has reached $85^{\circ}C$ ($185^{\circ}F$), to hold it at this for 15 minutes before proceeding to the boil.

The 2 : 1 metal-complex dyes can be dyed together with fast acid dyes which exhaust at the same pH range of 6 to 7, and the following are a few which possess comparable dyeing and fastness properties:

- C.I. ACID RED 143
- C.I. ACID VIOLET 48
- C.I. ACID BLUES 126, 80
- C.I. ACID GREEN 40

Procilan dyes

The Procilan dyes are 2:1 metal complexes containing groups which form stable chemical links with the wool fibre. This confers even better wet fastness than is associated with the normal 2:1 metal complex dyes. This property makes them especially useful for dyeing wool which has received an unshrinkable finish and which is intended for garments requiring frequent washing. The application of the Procilan dyes will be described in Chapter 22.

18. Azoic dyes

REFERENCE was made in Chapter 16 to A. G. Green's discovery that Primuline can be diazotized on the fibre, then coupled with an aromatic hydroxyl or amino compound to give a new dye of greater wet-fastness. A logical sequence to this conception was to create an insoluble azo pigment within the fibre by coupling the two components *in situ*.

The oldest application of this method was in the dyeing of Para Red, which will only be described briefly, because it is now merely historically interesting. The early direct dyes had poor wet-fastness and fast reds were still dyed with Alizarin, so that Para Red was a welcome substitute because it was quicker and cheaper in its application.

Para Red derived its name from the fact that it was produced by coupling diazotized paranitroaniline with β -naphthol. The cotton was first scoured thoroughly with caustic soda or sodium carbonate to render it readily permeable. It was then padded with a solution containing $2\frac{1}{4}$ to $2\frac{1}{2}$ lb of β -naphthol, an equal weight of caustic soda at 75°Tw (26 per cent), and 5 to 7 lb of Turkey Red oil per 100 lb. Cloth was impregnated on a jig and hanks were immersed in the solution manually and then passed through a squeeze roller. Cellulose is not substantive towards the sodium salt of β -naphthol and temporary fixation is obtained by drying. The material is then transferred to a liquor containing $1\frac{1}{4}$ lb of paranitroaniline diazonium chloride per pound of β -naphthol in the cotton, the diazotization having been carried out in the manner described in Chapter 16. After coupling, the goods are washed off in soap and water at 60°C (140°F) to remove any of the insoluble pigment which has been deposited on the surface of the fibres.

Nitrosamine Red was a stabilized diazonium derivative of *p*-nitroaniline which simplified the application. It was prepared by the action of sodium hydroxide on the diazonium chloride:

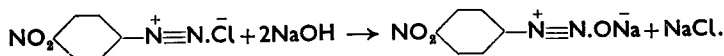

This sodium derivative is quite stable, and when treated with hydrochloric acid is converted into the diazonium chloride:

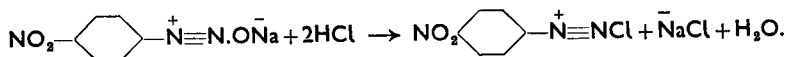

Para Red was outstandingly the most important azoic colour, but some-

times Dianisidine Blue was dyed by padding cotton with β -naphthol and coupling it with diazotized dianisidine, (1):

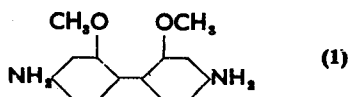

The original colour, when coupled, was violet, but after treatment with a copper salt it changed to blue.

The great disadvantage of Para Red and the other contemporary azoic dyes was the absence of affinity of the naphthol for cellulose. The intermediate drying was time-consuming but, also, was a frequent source of trouble because the β -naphthol migrated, causing unevenness in the final shade. In 1912 a great advance was made when the Griesheim Elektron A.G. of Frankfurt-am-Main introduced the Naphthol AS series, of which the parent substance was the anilide of β -hydroxynaphthoic acid, (2):

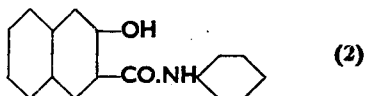

The importance of these derivatives is that they are substantive to cellulose, and drying after padding is no longer necessary. There is also less risk of poor fastness to rubbing because the Naphthol AS derivatives do not migrate into the liquor during coupling to form suspended insoluble pigment which is deposited on the surface of the fibres.

The success which these azoic dyes ultimately achieved only came after a considerable effort in applied research, and a short historical account is not without interest. Originally the Griesheim Elektron A.G. were making a red pigment by coupling metanitro-orthotoluidine with β -hydroxynaphthoic acid which was used in printing inks, (3):

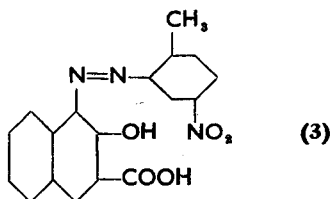

It was not entirely satisfactory, however, because it turned brown in the presence of an excess of linseed oil and alumina, which were used in the preparation of the inks. It was established that the carboxyl group in the naphthoic acid was the cause of the trouble, and blocking the acid group

by converting it into its anilide gave a more satisfactory product. A range of pigments for printing inks was subsequently made by coupling different diazotized amines with the anilide of β -hydroxynaphthoic acid or its substitution derivatives.

At the same time β -hydroxynaphthoic acid was being used, to some extent, in the textile industry for printing because, when coupled with diazotized dianisidine, (4), below, it gave a blue not dissimilar to indigo.

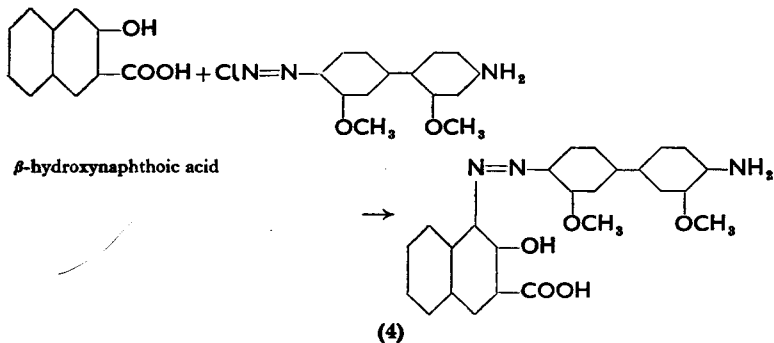

It had one serious deficiency: it lacked fastness to acids, and investigation showed again that the cause of the trouble was the carboxyl group. Equally attractive blue shades possessing better acid-fastness could be obtained if the anilide of β -hydroxynaphthoic acid was used instead of the unsubstituted acid. In the early stages this anilide was applied to the cotton as if it were β -naphthol and the goods were squeezed and dried before coupling. After the compound had been in use for some time it was realized that it was substantive towards cellulose and the drying was not necessary. This cleared the way for a great stride forward in the development of azoic dyes. The elimination of drying simplified the process and the risk of migration of the padded naphthol before coupling was reduced, which meant that dyeings would be more level. There was also less danger of lack of rubbing fastness, because the mutual affinity of the cellulose and the anilide of β -hydroxynaphthoic acid prevented migration of the latter into the

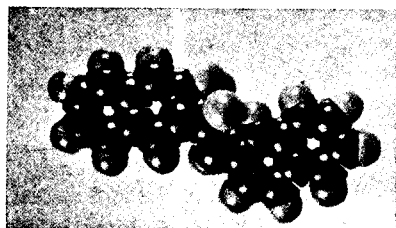

Naphthol AS-SW

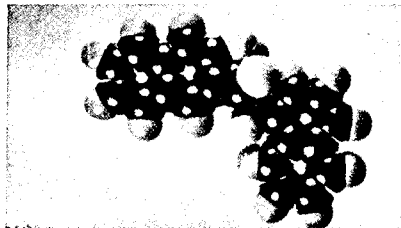

Naphthol AS-BO

Fig. 18.1

coupling solution, and this reduced the risk of surface deposition of insoluble pigment.

This important development was soon followed by the appearance of many other substances based upon β -hydroxynaphthoic acid anilide which were capable of coupling with diazonium salts, of which a few examples are:

Naphthol AS.BS
(C.I. AZOIC COUPLING
COMPONENT 17)

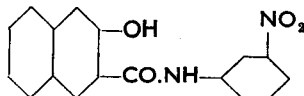

Naphthol AS.AN
(C.I. AZOIC COUPLING
COMPONENT 27)

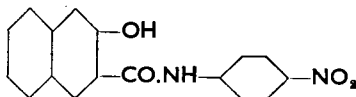

Naphthol AS.OL (Brenthol FR)
(C.I. AZOIC COUPLING
COMPONENT 20)

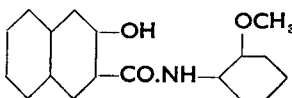

Later additions to the range were not always derived from the anilide of β -hydroxynaphthoic acid. It was found that other molecular structures were substantive to cellulose and also capable of coupling with diazotized bases. These requirements were fulfilled, for example, by aryl amides of acetylacetic acid such as is illustrated in Naphthol AS.G (C.I. AZOIC COUPLING COMPONENT 5), (5), where the coupling takes place at the $-\text{CH}_2-$ groups.

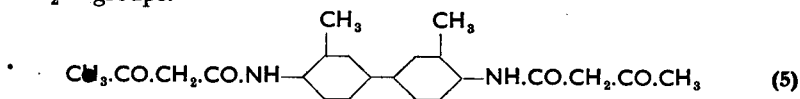

The factors which influence the substantivity of these anilides is discussed by Zitscher (*J.S.D.C.*, 1954, 70, 531). The original Naphthol AS was only just sufficiently substantive to make it serviceable, and exhaustion at equilibrium was only 12 per cent. Analogous structural characteristics confer similar affinity on coupling components to those which are significant in direct dyes. A linear molecular structure, the presence of aromatic nuclei able to arrange themselves in coplanar positions, and the existence of hydrogen bond-forming groups are requisites. This is illustrated by the molecular models of Naphthol AS.SW which is linear and has an exhaustion potential of 45 per cent, and Naphthol AS.BO which is angular and only exhausts to the extent of 25 per cent (ZITSCHER, *loc. cit.*) (Fig. 18.1).

There are 52 azoic coupling components now listed in the Colour Index, and 50 bases which can be diazotized and coupled with the former. The earliest bases were comparatively simple aromatic amines such as:

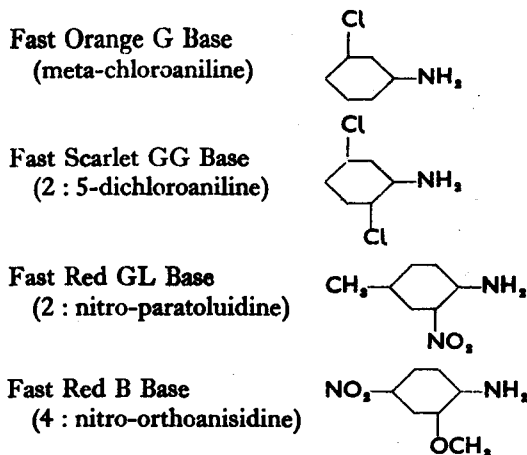

The light-fastness of the pigment is improved when electronegative groups such as $-\text{NO}_2$, $-\text{CN}$, $-\text{SO}_3\text{H}$, or $-\text{CO. OR}$ are introduced into the molecule of the base, as shown in Fast Bordeaux BD Base, (6), and Fast Scarlet LG Base, (7).

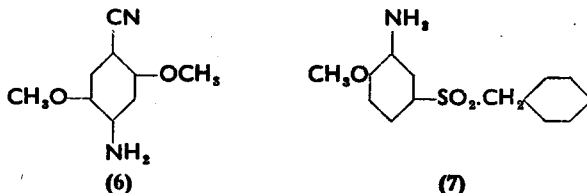

The introduction of a trifluoromethyl group into the molecule of an aromatic amine gives improved light-fastness coupled with brightness of shade to the pigment, as demonstrated by Fast Scarlet VD Salt, (8). Derivatives of mono acetylated paraphenylenediamine such as Fast Blue BB Base, (9), are particularly useful for blue shades.

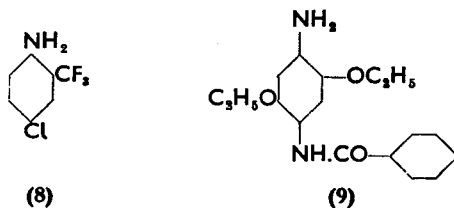

In the past green has presented a difficulty in the azoic range and yellow and blue components have been mixed with results which have not been entirely satisfactory. Recently, however, progress in the solution of the problem has been made by condensing the sulphuryl chloride derivative of

phthalocyanine with paranitroaniline and subsequently reducing the nitro to an amino group. Thus a base is formed capable of being diazotized and coupled with selected β -hydroxynaphthoic acid compounds.

The diazotization of amines is somewhat troublesome and stock solutions cannot be stored for long because of their lack of stability. There was, therefore, a great demand for stabilized diazonium salts which, when dissolved in water, would immediately be ready for use. Such products are usually marketed under the name of Fast Salts such as Fast Red Salt RL, Fast Blue Salt BB, the Brentamine Fast Salts, etc. The earliest of these were the so-called anti-diazotates.

A diazonium chloride will react with silver hydroxide to give, in the first place, a diazonium hydroxide but this readily undergoes isomeric change, forming derivatives of the weakly acidic diazoic acid. The acid itself cannot be isolated but the alkali diazotate exists in two forms, namely the syn- and the anti-isomers.

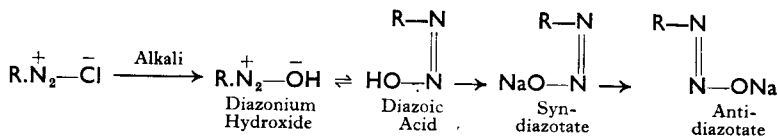

The syn-diazotate very rapidly undergoes transformation when warmed or in the presence of excess of alkali to the anti-diazotate which is much more stable and can be isolated in a solid form suitable for storage.

When potassium anti-diazotate is acidified it is converted to the unstable diazotate acid which immediately undergoes transformation to the corresponding nitrosamine, (10).



If, however, the alkali metal anti-diazotate is in the presence of a coupling component when it is acidified, the diazonium salt which is formed immediately couples with the other component:

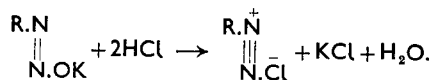

It is therefore possible to pad cellulosic fibres with a mixture of a naphthol and a diazotate, and there will be no reaction but, on acidification, coupling will take place. Mixtures of this nature do not find application in dyeing but have a certain amount of use in printing, for which purpose they are marketed as the Rapid Fast dyes. The Rapidogen dyes which are used exclusively for printing, contain a diazo compound stabilized by combination with primary or secondary amines containing water-solubilizing groups.

An example is 2 : 5 dimethoxy-phenyl diazonium chloride, reacted with sarcosine, (11). These compounds are mixed with the naphthol, printed, and then coupling is brought about either by acidification or by steaming.

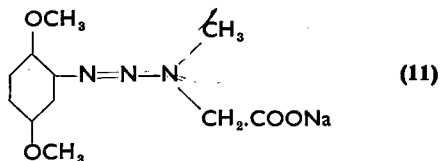

In piece, yarn, or garment dyeing a two-stage method consisting of application of the Naphthol first followed by coupling with a Fast Salt is preferred. The Fast Salts are diazotized bases stabilized by formation of double salts with compounds such as zinc chloride, aluminium chloride, alkyl sulphates, benzene sulphonic acid, and 1 : 5 naphthalene disulphonic acid.

Application

Dyeing with β -hydroxynaphthoic acid derivatives or similar compounds is a two-stage process except when using the Rapid Fast or the Rapidogen dyes. The first stage consists of impregnating the cellulose with the Naphthol compound also referred to as the coupling component. This can be carried out, in the case of yarn, in hank form in open becks or on the roller type of machine, or alternatively in package form. With fabrics the jig, the winch, or the padding mangle are suitable. The depth of the shade will depend upon the amount of Naphthol adsorbed by the fibre, and this is governed by the substantivity, a factor that varies considerably. The substantivity of the members of the Naphthol AS series is low compared with good exhausting dyes; machines operating with a low liquor ratio are therefore to be preferred. In most cases the amount which is adsorbed diminishes as temperature rises, and the operation is therefore carried out at 25° to 30°C (77° to 86°F). Brenthol DA is an exception because it has good substantivity and poor solubility at low temperatures. After impregnation the goods should be hydroextracted or squeezed thoroughly, to avoid carrying over retained liquor into the coupling bath where it would cause surface deposition of the pigment and poor rubbing fastness.

The sodium salts of the coupling components are usually somewhat unstable towards exposure to air, especially when in a wet state. If the impregnated goods lie about for any period the decomposition will not occur uniformly and the final result will be patchy. The stability of many of the coupling components is improved by the presence of formaldehyde, but its use must be restricted because there are compounds, such as Brenthol AT (C.I. AZOIC COUPLING COMPONENT 5), where the presence of formaldehyde will prevent coupling. The addition of formaldehyde is also undesirable when the goods are to be dried before coupling, or when the dyed

material is destined for discharge printing. The quantity of formaldehyde required varies slightly for different products but is usually about 1 litre per kilo or $\frac{3}{4}$ pint per lb of the naphthol derivative.

The Naphthol AS compounds or equivalent Brenthols (I.C.I.) are not soluble in water, but must be converted to their sodium salts before they can be brought into solution. They should be pasted with a little soft water together with a wetting or dispersing agent, and the recommended quantity of boiling water is then added with constant stirring, after which the mixture is brought to the boil again. The necessary quantity of caustic soda is well stirred in at the boil and the solution then allowed to cool to between 40° and 50°C (104° to 122°F) and the formaldehyde is added in those cases where its use is recommended. A variation in the procedure is necessary for some coupling compounds such as:

Naphthol AS.SW	C.I. AZOIC COUPLING COMPONENT 7
Brenthol DA	C.I. AZOIC COUPLING COMPONENT 3
Brenthol GB	C.I. AZOIC COUPLING COMPONENT 13

With these, the product is pasted with the dispersing agent and caustic soda. The formation of the smooth paste is assisted by standing the vessel in hot water, or allowing it to dwell overnight, and then boiling water is added with stirring and the whole is then boiled for several minutes.

The quantities of sodium hydroxide required by various coupling components are shown in Table 18.1.

Table 18.1

	<i>Azoic coupling component number</i>	<i>Pints caustic soda (62° Tw, 27.8 per cent), per lb</i>	<i>Litres caustic soda (62° Tw, 27.8 per cent), per kg</i>
Naphthol AS.BO	4	2½	2.75
Brenthol AS	2	1½	1.5
Naphthol AS.G	5	2¼	3
Brenthol BA	6	2½	3
Brenthol BB	10	1¼	1.5
Naphthol AS.SW	7	3½	4.4
Brenthol BT	15	½	0.6
Brenthol CT	8	1½	2
Naphthol AS.BR	3	2	2.5
Brenthol FO	19	2	2.5
Brenthol FR	20	1¼	1.5
Naphthol AS.SG	13	¾	1
Brenthol OT	18	1¼	1.5
Brenthol PA	11	2	2.5

An alternative method of dissolving coupling components, without the application of heat, is with the aid of methylated spirit. The necessary amount of the coupling component is placed in a container which should, if possible, be tall to reduce evaporation. The component is stirred with the recommended amount of methylated spirit and the caustic soda is added. When a paste of uniform consistency has been formed cold water is added with constant stirring. A clear solution should be obtained in this manner which will be ready for introduction into the dyebath after the addition of formaldehyde, when required. When dissolving cold no dispersing agent is employed in pasting but it is added to the dyebath.

The amount of sodium hydroxide necessary is greater than the theoretical weight required to convert the naphthol derivative into its sodium salt. There must be a minimum concentration in terms of grams per litre in the dyebath which varies according to the depth of shade and the individual characteristics of the coupling components. It is customary to add the alkali in two stages: firstly when pasting, and secondly to the water used to dilute the paste. Sometimes one addition will also have to be made to the dyebath because caustic soda concentrations should never fall below those quoted in Table 18.2 (*The Dyeing of Cotton with Brenthol Dyes, I.C.I.*).

Table 18.2

Caustic soda (62°Tw., 27.8 per cent)

Brenthol	Full shades		Medium shades		Pale shades	
	Per litre	Per 100 gal	Per litre	Per 100 gal	Per litre	Per 100 gal
AN.DA AS.FO BA.FR BB.MA BN.MN BT.OT CT.PA GB RB LTR AT	10 cc	8 pints	7.5 cc	6 pints	5 cc	4 pints
	15 cc	12 pints	12 cc	10 pints	7.5 cc	6 pints
	7.5 cc	6 pints	7.5 cc	6 pints	3 cc	2½ pints

The substantivity of the coupling components derived from β -hydroxynaphthoic acid is not very good, and it is improved by the addition of common salt. With the majority the best results are obtained from liquors containing 20 g per litre, or 20 lb per 100 gallons, of common salt, but with Brenthol AT (AZOIC COUPLING COMPONENT 5) 15 g per litre (15 lb per

100 gallons) should be used, and with Brenthol BN (AZOIC COUPLING COMPONENT 7) 10 g per litre (10 lb per 100 gallons).

Brenthol DA	C.I. AZOIC COUPLING COMPONENT 3
Brenthol GB	C.I. AZOIC COUPLING COMPONENT 13

possess good substantivity. Their solubility, however, is low and the use of salt is not recommended.

The lack of substantivity of many of the coupling components makes the use of standing baths desirable if this is practical, particularly when conditions make working with a long liquor ratio inevitable. After a time the liquor in a standing bath will become cloudy and, when this stage is reached, it should be discarded. Most of the components have good or adequate stability during storage, but Brenthol BN (C.I. AZOIC COUPLING COMPONENT 7) and Brenthol DA (C.I. AZOIC COUPLING COMPONENT 3) are only fairly good. The stability of Brenthol GB (C.I. AZOIC COUPLING COMPONENT 13) is so poor that its solution cannot be kept for more than 12 hours.

It must be borne in mind that the final shade is governed by the amount of coupling component which has been adsorbed. Since it is colourless it is not possible to make a visual assessment at the end of the impregnation. The only way of ensuring that the ultimate shade will be correct is to take scrupulous care in the preparation and control of the impregnating liquor. With regard to time, equilibrium exhaustion is reached in 20 to 30 minutes, irrespective of liquor ratio. The sensitivity to temperature is not very great but, nevertheless, this factor requires control because deviations of 10° to 15°C can have a marked effect. With the exception of Brenthol DA (C.I. AZOIC COUPLING COMPONENT 3) the greatest adsorption occurs between 20° and 25°C (68° and 77°F). The salt which is added to the dye liquor must be controlled in terms of g per litre or lb per 100 gallons, since it is the concentration and not the percentage of the weight of the cellulose which is significant. The customary procedure is to make the common salt concentration up to 20 g per litre or 20 lb per 100 gallons. It must also be emphasized that different forms of cellulose vary greatly in their affinities for the coupling components. An approximate comparison assigning an arbitrary figure of 100 to cotton is given below:

Linen	70
Cotton	100
Mercerized cotton	119

No figure is available for regenerated rayons, but it would probably be slightly higher than for mercerized cotton.

There is not a linear relationship between liquor ratio and substantivity, the relative exhaustion being somewhat greater in dilute than in concentrated solutions. For this reason exhaustion curves plotted for various

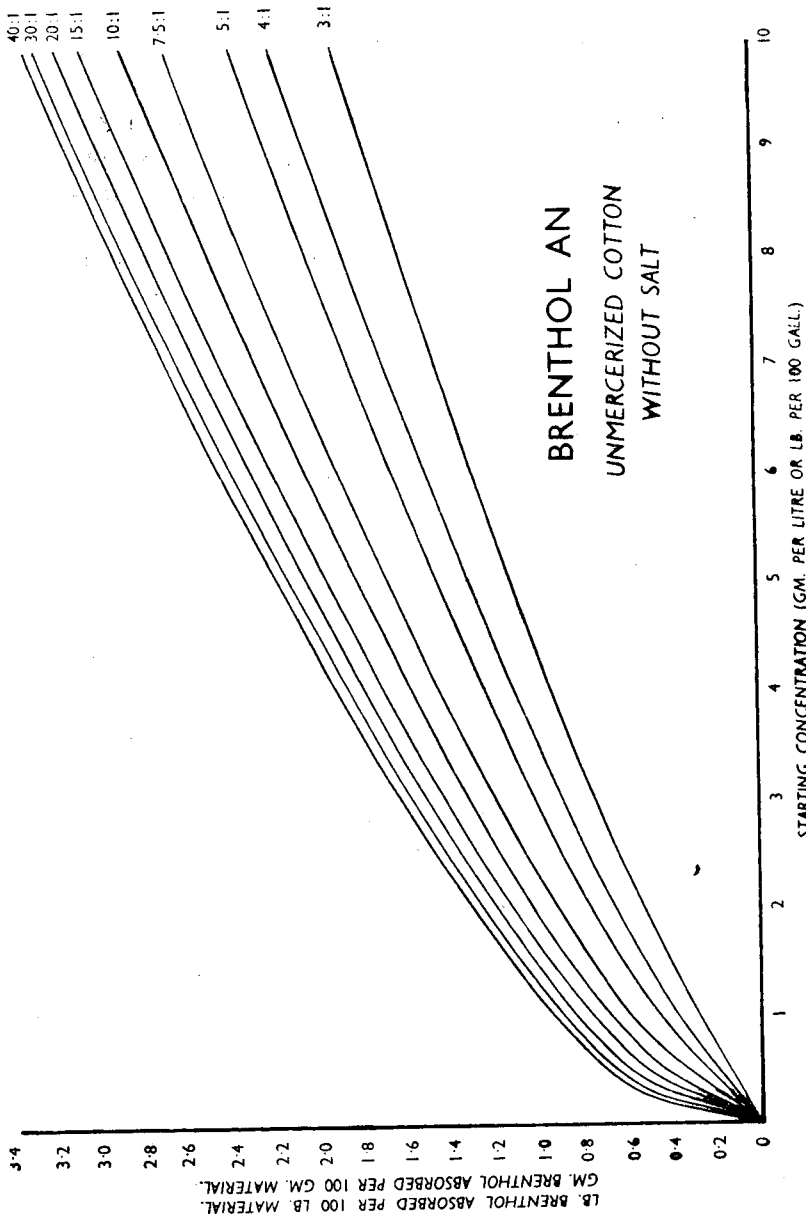

Fig. 18.2 No. 1 Brenthol AN—Unmercerized cotton (without salt)
(I.C.I. Publication)

liquor ratios (see Fig. 18.2) are extremely useful (*Dyeing Cotton with Brenthol Dyestuffs*, I.C.I. Publication). If, for example, it be assumed that the desired shade had previously been matched, either in bulk or in a laboratory, with a 2.2 g solution of Brenthol AN (C.I. AZOIC COUPLING COMPONENT 4) using no salt in a 20 : 1 liquor ratio on unmercerized cotton, then, if it should be desired to dye 100 lb of the same yarn in 100 gallons of water, the requisite amount of Brenthol AN could be ascertained in the following manner. Reference to the 20 : 1 curve in Fig. 18.2 shows that 100 lb of cotton would have absorbed 1 lb 4 oz of the Brenthol from a 2.2 g per litre (or 2.2 lb per 100 gallons) solution. If, therefore, 100 lb are to be dyed in 100 gallons, the liquor ratio will be 10 : 1 and the appropriate curve shows that the concentration of the liquor will have to be 2 lb 13 oz of Brenthol AN for the cotton to absorb 1 lb 4 oz at equilibrium. When using standing baths it is essential to have accurate information of the amount of coupling component required to fortify the liquor for each dyeing. The amount of component absorbed by the previous charge can be ascertained from the curves (see Fig. 18.2) because the concentration of the liquor should have been recorded and the weight of cotton is known. The amount of liquor lost can be measured with the aid of a calibrated dipstick. If the bath be brought up to its original volume with fresh water, the amount of coupling component required to restore it to its original concentration will be the weight absorbed by the cotton. To this must be added the quantity of coupling component in the volume of liquor lost at the concentration existing at the conclusion of the impregnation.

Before impregnation the cotton must be kier boiled or very well scoured in boiling sodium hydroxide or carbonate. Since the coupling component is applied at 20° to 25°C (68° to 77°F) the goods must be highly absorbent, which calls for especially good scouring. If pale bright shades are required cotton should be bleached before dyeing, but this is rarely necessary for deeper colours because of the intrinsic brightness of the azoic dyes.

Cotton hanks can be impregnated by hand in an open bath, moving and turning them in the liquor for 30 minutes at a temperature of 25°C (77°F). Because manual methods are slow, formaldehyde should always be added. At the end of the operation the hanks are hydroextracted, but if the yarn is of extremely fine count and the minimum of handling is essential, the excess liquor in such cases may be removed by rinsing in a solution of 25 to 50 g per litre (25 to 50 lb per 100 gallons) of common salt and sufficient caustic soda to give a concentration equivalent to half of that of the original impregnating liquor. In the past a very common way of padding hanks was the so-called tub-dip method, which is probably still used in some places. A stock padding solution is made up and 5 gallons are poured into a suitable small tank. The hanks, in 2-lb lots, are dipped in by hand and worked for $\frac{3}{4}$ to 1 minute and are then stored till a sufficient quantity to be hydroextracted has accumulated. After each immersion the liquor is

brought back to its original level from the stock tank to keep a constant ratio. On account of the time which elapses between impregnation and coupling in this method it is essential to use formaldehyde in the preparation of the stock solution.

Hanks can also be treated with the coupling component on the horizontal rotating-arm machine and in the Hussong, although in the latter it is often difficult to get a liquor ratio which is low enough for economical working. Considerable quantities of cotton yarn are dyed with azoic colours in package machines when the low liquor ratio is a great advantage. Most thorough precautions must, however, be taken to prevent the possibility of precipitation of the pigment because it is virtually impossible to wash it out once it has become deposited on the yarn. Cotton or rayon packages should be well scoured to give good adsorption, but caustic soda should not be used because it encourages swelling and the formation of hard packages which are difficult to penetrate. Naphthol derivatives with high substantivity are to be preferred because they are less liable to migrate into the liquor during coupling. Turkey Red oil should not be added to assist in dissolving or penetration because it may form a precipitate with some of the salts which are used to stabilize the diazotized bases. Impregnation is carried out at 25°C (77°F), and 20 lb per 100 gallons of common salt are usually added. Before coupling the cheeses are taken out and hydroextracted, unless the machine is supplied with compressed air to force excess liquor out. Whichever method is used, the weight of cotton plus moisture should not exceed $1\frac{1}{2}$ times the dry weight, this being the measure of good hydroextraction. It is preferable to diazotize the base, particularly for heavy shades, because the metallic salts in the stabilized diazonium compounds may cause precipitates.

Piece goods are impregnated in a jig or a padding mangle where the customary low liquor ratios assist in economical working. The treatment of knitted tubular fabrics is more difficult because processes must be carried out on a winch where liquor ratios must be about 20 : 1 to 30 : 1. The application of azoic colours to knitted fabric is discussed by Wiltshire (*J.S.D.C.*, 1954, 70, 41). It is recommended that only the most substantive naphthol derivatives should be used and salt and formaldehyde must always be added. Hydroextraction before coupling is recommended and, because fabrics are especially sensitive to irregular atmospheric action, it is advisable to put them in bags soaked in the impregnating mixture before they are packed into the centrifuge. Developing of knitted web in a winch machine is also difficult because a large proportion of the load is liable to remain static for considerable periods, during which the coupling component can migrate out before it has reacted with the diazonium compound. It is, therefore, most important to devise conditions which will ensure that the diazotized base will have access to every portion of the fabric as quickly as possible. Delay can be avoided if the ends of the pieces are already sewn

up in the truck before running into **the dyebath** and, if it is Practical to do so, **the web should be opened out by hand** as it enters. Full particulars are given by **Wiltshire** in the paper already quoted.

Coupling

The second stage in the synthesis of **the** insoluble pigment within the fibre consists of coupling with the **diazonium** salt. The various Fast **Bases** are aromatic primary **amines** which have to be **diazotized** with sodium nitrite and hydrochloric acid. The **diazotization** should **be** carried out in vessels free from metals, other than stainless steel, because most metallic compounds promote catalytic decomposition. Under normal circumstances the temperature should not rise above **18°C (64.4°F)**, but it is possible to allow it to reach **24°C (75.2°F)** without serious consequences. The base is dissolved in hydrochloric acid and boiling water; this solution is diluted with cold water **and** then cooled to **18°C**. The sodium nitrite, previously dissolved in water, is added with constant stirring. An excess of both hydrochloric and nitrous acids are necessary to ensure complete **diazotization**, and this **can** be safeguarded by testing for acid at intervals and for free nitrous acid by the blue **colour** which it gives with starch iodide paper. The solutions of diazotized bases are **sufficiently** stable for all normal practical purposes provided that the temperature is kept below **20°C (68°F)**. There are some which can be stored, in the absence of light, for as long as 1 to 2 weeks, and the stability will be improved by adjusting the **pH** to between 5 and 6.5. Decomposition is generally accompanied by turbidity and the formation of a scum, indicating that the solution should be discarded.

Whilst excess of hydrochloric acid is necessary to ensure that **diazotization** will be complete, coupling will not take place if the **pH** is too low. Sodium acetate is therefore added to the liquor to convert free hydrochloric into acetic acid, after which the **pH** should be about 4.5. Coupling will also be retarded if the liquor becomes alkaline, and this can occur easily on account of the sodium hydroxide which may be left in the cotton after it has been impregnated with the naphthol derivative. Excess of alkali can be neutralized by adding acetic acid, sodium bicarbonate, or aluminium **sulphate**. Aluminium sulphate should not be used in a package-dyeing machine because it gives rise to a certain amount of precipitated aluminium hydroxide and this will be retained by filtration. Some loss of lustre of mercerized cotton can also be caused by aluminium sulphate.

The actual coupling is carried out in a liquor, the temperature of which should not exceed **20°C (68°F)**. In order to prevent the migration of the coupling component into the liquor before the reaction has taken place, 25 g per litre (25 lb per 100 gallons) of common salt are added. In many cases the coupling is quite slow, which is unfortunate, because it allows more time for the naphthol derivative to migrate. To make the reaction as rapid as possible the concentration of the diazotized base should at no time

fall below 0.5 g per litre (8 oz per 100 gallons). The addition of an assistant such as a sulphated fatty alcohol or an ethylene oxide condensate tends to improve the speed of the reaction and also to keep in suspension any pigment formed in the liquor. The presence of such a surface-active compound is particularly important in a package machine where deposition of insoluble pigment on the surface of the fibres can present considerable difficulty in its removal.

The Fast Salts are stabilized diazonium compounds which have only to be dissolved in water and they are ready to use for coupling. The method of dissolving which is recommended is to use 5 litres of water for 1 kilo of Fast Salt, or 4 pints for 1 lb, together with an amount of about 10 to 20 ml of a wetting and dispersing agent. The water should not be hotter than 30°C (86°F) and the Fast Salt is sprinkled in slowly with constant stirring. If solution is not complete, standing for 5 to 10 minutes should be effective, after which the appropriate quantity is added to the dyebath through a strainer. It will, in many cases, be necessary to add sodium acetate or a compound to buffer excess of alkali. The necessary quantities will be quoted in the dyestuff manufacturer's instructions.

There is considerable variation in the rate at which coupling takes place with different bases and Fast Salts, and the rate of reaction can be controlled by the pH (HUCKEL, *J.S.D.C.*, 1958, 74, 640). The diazo coupling components are divided into four groups according to their coupling energies, related to which are different pH ranges at which the reaction will be most rapid.

Group 1

High coupling energy. Optimum pH range 4-5. No buffer necessary to maintain pH, but an alkali-binding agent is essential.

- (a) *Rapid coupling rate* *C.I. Azoic Diazo Components* 6, 7, 3, 37, 9.
- (b) *Medium coupling rate* *C.I. Azoic Diazo Components* 44, 2, 18, 16, 12, 13, 34, 8, 36.
- (c) *Stow coupling rate* *C. I. Azoic Diazo Components*, 19, 50, 5, 4, 38, 49, 17, 1, 27, 21.

Group 2

Medium coupling energy. Optimum pH range 5.5-6.5. Acetic acid/sodium acetate buffered.

- (a) *Rapid coupling* *C.I. Azoic Diazo Components* 46, 30.
- (b) *Medium coupling rate* *C.I. Azoic Diazo Components* 26, 33, 29, 39, 32, 11, 10.
- (c) *Slow coupling rate* *C.I. Azoic Diazo Components* 31, 42, 25.

Group 3

Low Coupling energy. Optimum pH range 6–7. The bath should be neutralized with sodium bicarbonate then buffered with mono- and disodium phosphate buffer mixture; i.e. for 20 : 1 liquor ratio 2 g per litre Na_2HPO_3 and 4 g per litre NaH_2PO_4 , and double and four times these quantities for 10 : 1 and 5 : 1 liquor ratios respectively.

- (a) *Rapid coupling rate* C.I. Azoic Diazo Component 43.
- (b) *Medium coupling rate* C.I. Azoic Diazo Components 41, 20, 24, 45.
- (c) *Slow coupling rate* C.I. Azoic Diazo Component 15.

Group 4

Very low coupling energy. Optimum pH range 7–8.2.

- (b) *Medium coupling rate* C.I. Azoic Diazo Components 35, 22.
- (c) *Slow coupling rate* C.I. Azoic Diazo Components 47, 48.

There has been a constant search for some chemical group which could be attached to the azo pigment to make it soluble in water, and which could be detached when it is in the fibre, leaving behind an insoluble azo compound. Such products were the Neocotones produced by Ciba which were solubilized by attaching a meta-sulphobenzoyl radical to the carboxyl or —CO.NH— groups in the azo compound. These dyes, however, are no longer being made.

Washing off

Reference has been made previously to the fact that there is a risk of insoluble pigment becoming formed in the liquor during coupling and being deposited on the surface of the fibre, thereby causing poor rubbing-fastness. This always happens to a greater or less extent and is more pronounced in heavy shades. Cotton yarns dyed with azoic colours are very often used for effect threads and lack of rubbing-fastness can cause staining of adjacent areas during scouring, bleaching, or other finishing operations. Discolorations caused in this manner can be extremely difficult to remove. All azoic dyeings are therefore, as a final operation, washed well with soap or some synthetic dispersing agent in a machine giving adequate agitation or squeezing to dislodge the adhering particles. A liquor containing 2 lb of soap, or 2 pints of Lissapol N, or 10 oz of Lissapol C paste, with 2 lb of soda ash is effective. Scouring should be for a period never less than 15 minutes at the boil if possible or at the highest temperature that the dye will stand without effect upon the shade. To obtain really good fastness with heavy shades a more elaborate washing off is necessary. The material is first treated in a liquor containing $2\frac{1}{2}$ pints of hydrochloric acid per 100 gallons at 30° to 40°C (86° to 104°F) for 10 minutes to remove any

by-products which may have been formed in the coupling process. After rinsing twice the goods are scoured in the manner already described and finally rinsed in successive lots of fresh water until the water is colourless.

Blinding

Azoic dyes sometimes cause a matt or delustrated effect, particularly on regenerated cellulose rayon, referred to as blinding. The phenomenon occurs more frequently with heavy shades, but the effect cannot be related to any molecular structural features of the coupling and azoic components. Microscopic examination shows that blinding is apparent when the pigment ceases to be distributed with uniform density throughout the cellulose but becomes aggregated into particles.

Blinding is never apparent immediately after coupling but develops on standing, or more frequently during wet treatment at high temperatures such as in the washing-off process. This is not surprising because aggregation must be preceded by molecular mobility which, in turn, is related to temperature. In lustrous yarns such as rayons, blinding produces both a matt effect and a change of shade, but in non-lustrous cotton there is only an alteration of the colour.

Blinding can occur in the cold as, for example, was the case when regenerated cellulose rayon dyed with Brenthol BA (C.I. AZOIC COUPLING COMPONENT 6) and Brentamine Fast Orange GC (C.I. DIAZO COMPONENT 2) was allowed to stand in cold water for 64 hours (see HENDERSON AND SOKOL, *Hexagon digest*, No. 12). On the other hand, a dyeing with Brenthol AN (C.I. AZOIC COUPLING COMPONENT 4) and Brentamine Fast Orange GR (C.I. DIAZO COMPONENT 6) was unaffected after boiling in neutral soap for 30 minutes, but showed the effect after 4 hours. Blinding is more liable to occur under the influence of heat in alkaline solutions and, if it is known that the dye is susceptible, the final washing off should be conducted in the absence of alkali at 60°C (140°F) instead of at the boil. Table 18.3 from *Hexagon digest* (I.C.I.) No. 12 shows the range of Brenthol/Base combinations and their liability to blind. Further information about the subject was published by Rowe (*J.S.D.C.*, 1926, 207).

Application of azoic dyes to protein fibres

Some attention has been paid to the dyeing of silk and wool with azoic dyes, but the subject is now of little practical importance because equally good results can be obtained with Fast Acid or Carbolan dyes by simpler methods.

Dyeing wool with azoic dyes is described by Everest and Wallwork (Brit. Pat. 283838, 1928; *J.S.D.C.*, 1934, 50, 37; *J.S.D.C.*, 1928, 119). Because proteins are degraded by strong alkalis, sodium hydroxide cannot be used in the impregnation of the fibre with the naphthol derivative, and Everest and Wallwork substituted a suspension of the coupling component in a

Table 18.3 Brenthol combinations which give rise to blinding

Azotic Coupling Component → Azotic Diazo Component ↓	4	2	5	6	10	7	15	8	3	19	20	13	12	24	17	18	11	25	
44																			
2	BVH	BVH																	
6	BVH	BVH																	
12	BVH	BVH																	
3																			
13	BH	BH																	
36	BH	BH																	
5	BVH	BVH																	
37	BH	BH																	
8	BH	BH																	
9																			
22																			
10																			
34	BH	BH																	
11	BH	BH																	
42	BVH	BVH																	
39	BH	BH																	
1	BH	BH																	
4	BVH	BVH																	
41																			
48																			
20																			
35																			
38																			

BM = Blinds in medium depth shades } when soaped at 95°C (205°F) in a neutral bath for ½ hour.
 BH = Blinds in heavy shades
 BVH = Blinds in very heavy shades

* Blinds even when soaped at 60°C (140°F) in a neutral bath for ½ hour.

871

liquor containing soap and soda ash for wool and mild alkali and glycerine in the case of silk. After impregnation the colours are developed with the diazo component in the manner already described for cellulosic fibres. The following details are quoted from the patent: 'For 20 lb of wool 3 lb of soap and 12 lb of soda ash are dissolved in 30 gallons of water and the solution boiled until it is clear, after which 1 lb 3 oz of Naphthol JW15 are made into a smooth paste with a little of the soap liquor and then mixed with the remainder by passing through a sieve. The mixture is then boiled for 5 minutes and made up to 60 gallons with water. The wool is entered at 50°C (122°F), worked about for 30 minutes and squeezed or hydroextracted. It is then passed, without delay, into a coupling bath which is made up in the usual way and should give an acid reaction when tested with Congo Red. After 30 minutes in the coupling bath the wool is removed, rinsed with cold water, soaped for 10 minutes at 50°C (122°F), rinsed with cold water and dried.'

The application of azo dyes to proteins is complicated by the fact that the diazo compound can enter into combination with the fibre itself (EVEREST AND WALLWORK, *J.S.D.C.*, 1934, **50**, 37). The only practical application which has any significance is in a limited field of dyeing wool and cellulosic unions. It was extremely difficult to dye cellulose in a bright red shade of good wet-fastness with any dyestuff other than an azoic, and it was sometimes necessary to use these dyes on a union containing wool. The recent appearance of the reactive dyes will not be without some bearing on the necessity for resorting to this method and the subject will receive more attention in Chapter 24.

Stripping azoic dyes

Removal of the dye is brought about most effectively by sodium hydro-sulphite in the presence of a cation-active substance such as Lissolamine A (Cetyl trimethyl ammonium bromide). The goods are treated at the boil for about 15 minutes in a liquor made up with: 2 per cent of Lissolamine A, 12 per cent of caustic soda 72°Tw (32.5 per cent) and the temperature is then dropped to just below the boil and 5 to 6 per cent of sodium hydro-sulphite is added. After a further 30 to 45 minutes, the liquor is run off and stripping is completed by bleaching with sodium hypochlorite.

19 · Sulphur dyes

THE characteristic feature of the dyes of this class is that they all contain sulphur linkages within their molecules. They are usually insoluble in water, but dissolve in a solution of sodium sulphide to which sodium carbonate may or may not be added. The sodium sulphide acts as a reducing agent, severing the sulphur linkage and breaking down the molecules into simpler components which are soluble in water and substantive towards cellulose.

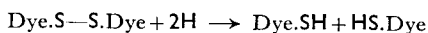

The thiols, containing the SH groups, are readily oxidized in the fibre to the original insoluble sulphur dye, giving a colour with very good wet-fastness.

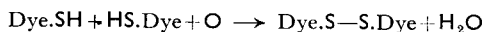

The first sulphur dye was made in 1873 by heating sawdust with sulphur and caustic soda. This substance was adsorbed from an alkaline liquor by cotton and subsequent oxidation with potassium dichromate produced a brown shade of quite good wet-fastness. This particular colour, however, never achieved commercial success and the real pioneer of sulphur dyes was Vidal, who, in 1893, produced the Vidal Blacks by fusing paraphenylenediamine, or para-aminophenol, with sodium sulphide and sulphur. It was necessary to oxidize the Vidal Blacks on the fibre with potassium dichromate to develop the black. In 1897 Kalischer prepared Immedial Black FF by heating 2 : 4-dinitro-4'-hydroxy diphenylamine with sodium polysulphide and it met with great success because it was not necessary to oxidize it with dichromate. These discoveries were followed by the addition of many new members to the class of the sulphur dyes prepared by the action of sulphur and alkalis, under the influence of heat, upon a variety of phenols, amines, nitro compounds, and quinoneimines. Methods of preparation, however, were empirical and nothing was known about the chemical constitution of the dyes. All that could be asserted with certainty was that their constitution was complex and they all contained sulphur, a proportion of which was held in a comparatively loose state of combination, because most of them evolved hydrogen sulphide when treated with relatively strong reducing agents such as stannous chloride and hydrochloric acid.

Sulphur dyes can be detected by the evolution of hydrogen sulphide when treated with reducing agents. A little of the dyestuff or dyed material

is placed in a test tube, together with some stannous chloride and hydrochloric acid. The top of the tube is covered over with a piece of filter paper, in the centre of which a drop of lead acetate solution is placed with the aid of a glass rod. The contents of the tube are heated gently until they begin to boil. In the presence of hydrogen sulphide the paper becomes black due to the formation of lead sulphide.

Some knowledge of the structure of the very complex molecules of the sulphur dyes is being accumulated gradually. It has, for example, been established that one of the reactions which takes place when sulphur is heated with *para*-toluidine is the formation of dehydrothio-toluidine:

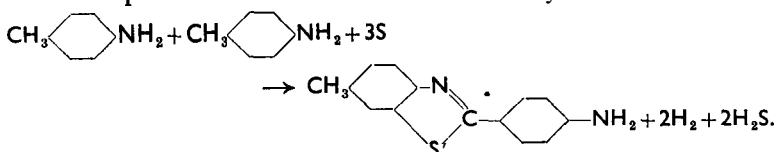

The dehydrothio-toluidine can react with another molecule of toluidine, a process which may be repeated until quite a complex molecule has been built up:

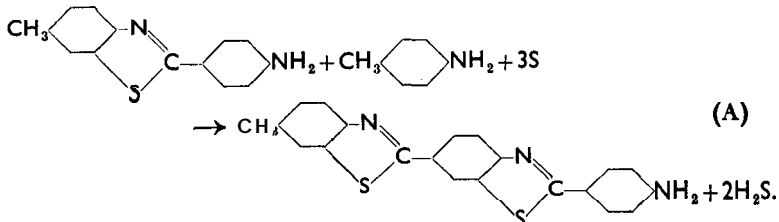

It has also been established that indophenol reacts with sodium polysulphide to form a thiazone:

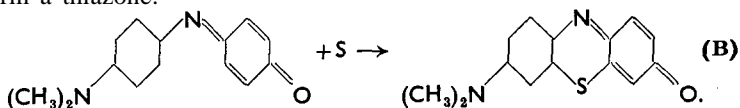

It is believed that the reactions indicated in equations (A) and (B) both play an important part in the formation of sulphur dyes. When a mixture of benzidine ($\text{NH}_2\text{C}_6\text{H}_4\text{C}_6\text{H}_4\text{NH}_2$) and dehydrothio-toluidine is heated with sulphur or sodium polysulphide a yellow sulphur dye known as Immedial Yellow GG is obtained. The dye is a disulphide, but degradation products have been isolated which show that it is built up from units of the structure

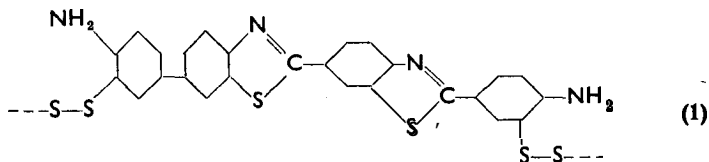

shown in (1), a compound which, itself, shows the dyeing properties characteristic of Immedial Yellow GG.

When one part of toluene-2 : 4-diamine is baked with 2 to 4 parts of sulphur at a temperature between 190° and 250°C (374° to 482°F) for 15 to 24 hours, and the crude product is extracted with aqueous caustic soda or sodium sulphide, a sulphur dye known as Immedial Orange C (C.I. SULPHUR ORANGE 1) is extracted. The dye, when heated with an alkali, yields an ortho-aminothiol which can be isolated in a pure state in the form of its lactam after it has been treated with chloracetic acid, and it has been established that it has the structure shown in (2),

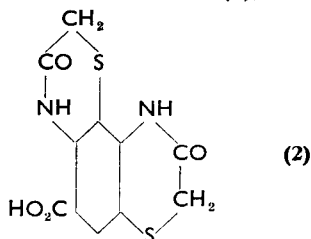

from which it may be concluded that Immedial Orange C is the polythiazole, (3),

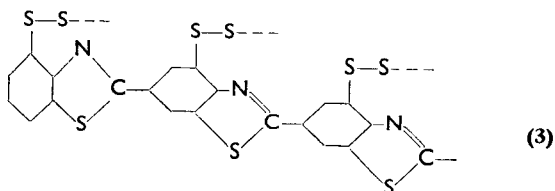

When 4 : hydroxy : 4' : methyl diphenyl, (4), is heated with sulphur it produces the same sulphur dye that is formed by the action of sulphur on the thiazone, (5),

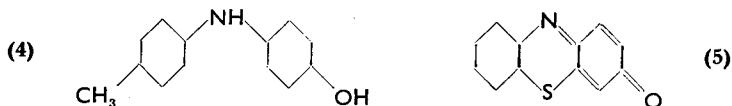

which leads to the assumption that the dye is composed of several units of the structure shown in formula (5), linked together by sulphur atoms. In the past it was assumed that these links were invariably disulphide bonds which reduced to mercaptans (R.SH), but it has been demonstrated that compounds of the type of formula (6) have no affinity for cellulose. It is, therefore, believed that —S— linkages of the type shown in formula (7)

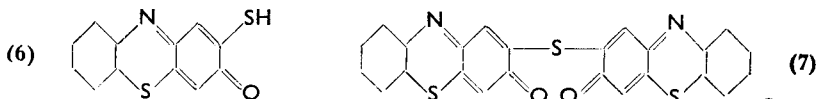

exist as well as the disulphide bonds. The single sulphur atom bridges survive reduction with sodium sulphide and it is known that cellulose has an affinity for such compounds.

Zerweck and Ritter prepared a compound with the constitution of formula (8) and found that it was not substantive towards cellulose and had none of

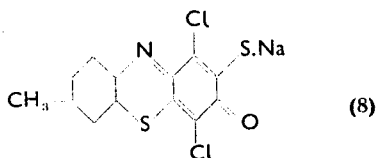

the properties of sulphur dyes. It rapidly underwent polymerization with the elimination of hydrochloric acid and formed substances of the type of formula (9),

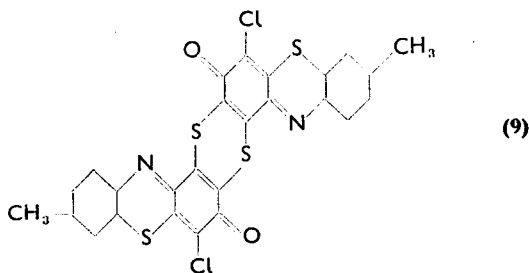

which possessed the characteristics of sulphur dyes.

General properties of sulphur dyes

The sulphur dyes are cheap and easy to apply. Their wet-fastness is good and the light-fastness satisfactory, as shown in Table 19.1. They therefore provide a cheap method of dyeing cellulosic fibres with a wet-fastness better than the direct dyes. Some of the yellows have only poor light-fastness, such as Thional Yellow G (C.I. SULPHUR YELLOW 2), which is rated as 2. The sulphur dyes all have poor fastness to chlorine and are no use for effect

Table 19.1

Dye	C.I. number	Light-fastness (S.D.C.)	Wash-fastness (S.D.C. alteration of shade)
Thional Yellow 2G	SULPHUR YELLOW 4	4	4-5
Thionol Orange R	SULPHUR ORANGE 1	3	4-5
Thional Red Brown 5R	SULPHUR RED 1	3	4
Thionol Bordeaux BR	SULPHUR RED 6	3-4	3-4
Pyrogene Blue V	SULPHUR BLUE 1	5	4
Eclipse Black Brown BS	SULPHUR BROWN 5	4	4
Pyrogene Deep Black B	SULPHUR BLACK 1	6-7	5

threads in merchandise which must be bleached with hypochlorite, but they will withstand the conditions in an acid dye bath and can be incorporated in woollen goods intended for subsequent dyeing. As will be referred to later, however, there are after-treatments which improve the fastness of these dyes.

In their reduced state their dyeing properties resemble in many respects those of the direct dyes. They exhaust better in the presence of electrolytes and vary considerably with regard to the temperatures at which maximum exhaustion takes place. They are decomposed by acids, usually with the liberation of hydrogen sulphide and the precipitation of insoluble decomposition products. On exposure to air, or when acted upon by mild oxidizing agents, a portion of the sulphur is oxidized to sulphuric acid.

The sulphur dyes resemble the vat dyes in that they are insoluble in water but reduce to a soluble form which readily reverts to the original state on oxidation. In many cases this reversible change is accompanied by an alteration of colour. Sodium sulphide is the reducing agent commonly used, but in some cases sodium hydrosulphite may be substituted, making it possible to dye selected vat and sulphur dyes together.

On account of the readiness with which both the sulphur dyes and the alkali sulphides liberate hydrogen sulphide, the use of metal dye vessels, other than stainless steel, can be dangerous. Machines composed of copper or containing this metal in the form of fittings should never be used. Most metallic sulphides are insoluble and black or dark in colour and will stain the goods and flatten the shade.

Dissolving sulphur dyes

The dyestuff is pasted with soda ash and sodium sulphide. Two pounds of soda ash will be required for every 100 gallons contained in the dyeing machine at its working level. The quantity of sodium sulphide is usually twice the weight of the dye, but this is not always the case, as shown in Table 19.2.

Table 19.2

<i>Dye</i>	<i>C.I. number</i>	<i>Weight of sodium sulphide required</i>
Thionol Yellow YN	SULPHUR YELLOW 2	$1\frac{1}{2} \times$ weight of dye
Pyrogene Yellow Brown RS	SULPHUR BROWN 10	$\frac{1}{2} \times$ " " "
Thionol Dark Brown D	SULPHUR BROWN 14	$\frac{1}{2} \times$ " " "
Thionol Dark Brown B	SULPHUR BROWN 5	$\frac{1}{2} \times$ " " "
Thionol Red Brown 5R	SULPHUR RED 1	$\frac{3}{4} \times$ " " "
Eclipse Brilliant Blue 2RL	SULPHUR BLUE 10	$\frac{3}{4} \times$ " " "
Thionone Indigo 2G	SULPHUR BLUE 13	$1-1\frac{1}{2} \times$ " " "
Thionol Direct Blue RLS	SULPHUR BLUE 4	$\frac{1}{2}-\frac{3}{4} \times$ " " "

Boiling water is then added to the paste until it has all dissolved and, if

necessary, it is boiled up again. If circumstances permit it is desirable to strain the dissolved dye before it is added to the dyebath because the sulphur dyes are liable to contain more insoluble impurities than other classes. When dyeing heavy shades and blacks, straining is not always practical because of the large weights of dyestuff required, and in such cases the colour must be dissolved in one or two feet of water in the bottom of the machine.

The dyebath is made up with dyestuff and from 5 to 25 per cent of the weight of the goods of common salt or 10 to 50 per cent of crystalline Glauber's salt, the actual amount varying according to the depth of shade. The salt may be added at the commencement, but if there is any risk of unlevel dyeing it is preferable to add it after the temperature has reached 100°C, and then in several portions. The addition of a surface-active penetrating agent is recommended. With most sulphur dyes the liquor is brought to the boil and dyeing continued at that temperature for 30 minutes. The steam is then turned off and the application continued in a cooling liquor for a further $\frac{1}{2}$ hour. There are some sulphur dyes, however, which exhaust best at 70° to 75°C (158° to 167°F).

The sulphur dyes do not give very good exhaustion, especially in heavy shades. A machine with a low liquor ratio is therefore preferable. It is common practice to keep a standing bath for blacks. For dyes subsequent to the first, between $\frac{1}{2}$ and $\frac{3}{4}$ of the original quantities of dye, sodium sulphide, and sodium carbonate are added, but when the specific gravity of the liquor exceeds 10°Tw (1.05 sp gr), it should be discarded or diluted. Free sulphur sometimes makes its appearance in the dyebath. When this happens sodium sulphite should be added till it disappears, through conversion to sodium thiosulphate:

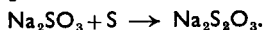

This precaution is necessary to prevent the sulphur becoming sticky and adhering to the goods, forming light-coloured patches.

On account of the readiness with which the reduced dye oxidizes in the presence of air it is desirable that the application should be in a machine in which the goods are totally immersed the whole of the time. When yarn is dyed by hand, bent sticks are used, see Fig. 19.1.



Fig. 19.1 Bent stick for dyeing hanks with sulphur dyes

It is also important that retained liquor should be rinsed out immediately after dyeing, to prevent deposition of the insoluble product of oxidation on the surface of the fibres.

After-treatment with peroxide

Some of the sulphur dyes oxidize only slowly and it may be inconvenient to have to wait for the true shade to develop. There are also certain blues which give a brighter tone when after-treated with hydrogen peroxide, of which the following are examples:

Thionol Sky Blue 6B	C.I. SULPHUR BLUE 13
Thional Dark Blue B	C.I. SULPHUR BLUE 7
Thionol Navy Blue RM	C.I. SULPHUR BLUE 4
Thional Dark Blue V	C.I. SULPHUR BLUE 1

The method of after-treatment is to run the rinsed goods in a liquor containing 1 to 2 per cent of sodium percarbonate, or 1 to 2 per cent of 100-vol hydrogen peroxide and a little ammonia, for 15 minutes at 40°C (105°F). An alternative procedure is to run them, after rinsing, in a solution of sodium perborate of 0.5 to 1 g per litre (8 oz to 1 lb per 100 gallons) concentration, at 40° to 50°C (105° to 120°F), for 20 minutes.

After-treatment with metallic salts

Sulphur dyes are after-treated with copper sulphate or, more commonly, with copper sulphate together with potassium or sodium dichromate and acetic acid. The treatment improves light-fastness and, in some cases, wash-fastness, to a small extent. When copper sulphate alone is used the process consists of running, after rinsing, at 70°C (160°F) for 20 to 30 minutes in a liquor containing

1-2 per cent (on weight of goods) copper sulphate (crystals)
 1-2 per cent (,, ,, ,,) acetic acid (60 per cent),

and when dichromate is incorporated the time and temperature are the same, but the liquor contains

1-1½ per cent (on weight of goods) of dichromate
 ½-1 per cent (,, ,, ,,) of copper sulphate
 1-2 per cent (,, ,, ,,) of acetic acid (60 per cent)

A few examples of the effect on light-fastness of the latter treatment are quoted in Table 19.3.

Table 19.3

<i>Dye</i>	<i>C.I. number</i>	<i>Light-fastness</i>	
		<i>Untreated</i>	<i>After-treated</i>
Thional Yellow 2G	SULPHUR YELLOW 4	3	5
Pyrogene Orange O	SULPHUR ORANGE 1	3	5
Thionol Bordeaux BR	SULPHUR RED 6	3-4	4-5
Thional Dark Blue B	SULPHUR BLUE 7	4-5	5-6

Sulphur-dyed cotton fabrics are commonly used for lining boots and other goods made of rubber and, when intended for the purpose, should not be after-treated with copper salts. It is also undesirable to use copper on materials which have been dyed with sulphur blacks because it can cause catalytic oxidation of the sulphur, converting it to sulphuric acid which degrades the cellulose.

Sulphur blacks may show a tendency to have a 'bronze' appearance. Many factors can contribute towards this effect, such as an excessively heavy dyeing, exposure of the goods to air whilst they are being dyed, failure to remove excess of dye liquor immediately after dyeing, or insufficient sodium sulphide in the dyebath. The bronziness can often be removed by after-treatment in a bath containing a dilute solution of sodium sulphide (0.1 per cent) at 30°C (86°F), which removes some of the excess of dyestuff from the surface of the goods. Blacks are also improved by after-treatment in a liquor containing soap and olive oil. A bath is made up with 2 to 5 lb of olive-oil soap per 100 gallons, together with 1 to 2 lb of olive oil and 1 to 2 lb of soda ash. The goods are treated for $\frac{1}{4}$ to $\frac{1}{2}$ hour at 60°C (140°F) and then taken out and hydroextracted and dried without rinsing.

Sulphur dyes cannot be applied to protein fibres by normal methods on account of the strongly alkaline nature of the dye liquors. Wool is never dyed with these dyestuffs, but a reasonably fast black was obtained on wool and cotton unions by adding 5 per cent on the weight of the goods of a protective colloid such as glue or boiled starch.

Vidal and other sulphur blacks have been used for dyeing fast shades on pure silk by the method patented by Lodge and Evans. The process is based on the fact that Vidal Black can be converted into its leuco compound, which is soluble in ammonium sulphide, by the action of sulphites or bisulphites. In practice the leuco compound is prepared and dissolved in sodium sulphide, which is then converted into ammonium sulphide by the addition of ammonium sulphate.

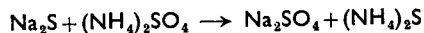

A dye liquor made up in this way has such a low alkalinity that there is no risk of damage to the fibre. As an example, one part of Vidal Black would be boiled for 5 to 10 minutes with 2 parts of sodium sulphite and 10 parts of water. One part of sodium sulphide is then added and the mixture kept hot, but below the boil, until the dye has dissolved completely. The whole is then strained into the dyebath and 2 parts of ammonium sulphate are added. The cotton component in unions with either silk or wool can be dyed at 40° to 50°C (104° to 122°F), but to dye the protein fibre also the liquor should be heated to 80°C (176°F).

Sulphur dyes and in particular the black shades are liable to cause tendering of cellulose, on storage. The cause is the gradual oxidation of a portion of the sulphur to sulphuric acid. The work of Zänker and others on this

phenomenon is summarized by Whittaker and Wilcock (*Dyeing with Coal Tar Dyestuffs*, 5th Edn, p. 31). They made a prolonged investigation of the causes and prevention of tendering with sulphur dyes. The sulphur is present in three forms:

- (i) Free sulphur which can be extracted with carbon disulphide.
- (ii) Loosely-combined sulphur oxidizable on exposure to air.
- (iii) Firmly-combined sulphur only attacked by strong oxidizing agents which break down the whole molecule.

The loosely combined sulphur amounts to about 20 to 25 per cent of the total.

It is often desirable to determine the liability of a batch of dyed cotton to tender on storage, for which the following test has been recommended. A piece of the sample is heated side by side with an undyed piece of the same fabric for 1 hour in an oven at 140°C (284°F). The samples are then exposed to air until their moisture content has reached equilibrium, after which the heating and exposure are repeated once more and then the tensile strengths of the two samples are compared. Tendering can be avoided by drying a little sodium acetate into the goods so that the sulphuric acid will be converted into harmless acetic acid as soon as it is formed. Another method is to work the dyed material for 30 minutes in a liquor containing 1 to 3 per cent of potassium dichromate and an equal percentage of acetic acid (60 per cent) at 60°C (140°F). This should oxidize any loosely-combined sulphur to sulphuric acid, which can then be removed by thorough rinsing.

Water-soluble sulphur dyes

The water-soluble sulphur dyes will dissolve in water without any other addition, but it must be emphasized that this solution will not dye cellulose without the addition of sodium sulphide and carbonate. Their advantages are that they are easier to handle, contain less insoluble matter, making them more attractive for package dyeing, and they possess superior levelling properties.

The solubilized brands are derived from the conventional sulphur dyes by preparation of the reduced form in a stable state. In some cases the reduction is carried out in aqueous solution and the product is obtained by evaporation and pulverization or alternatively prepared as a liquid mixture. In other cases, sodium formaldehyde sulfoxylate, mild alkali, and the dye are mixed and packed in the dry state.

The thiosulphonic acid solubilized sulphur dyes are prepared by the action of sodium sulphite or bisulphite on the sulphur dye.

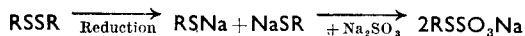

The reduced leuco form is adsorbed by cellulosic fibres where it is subsequently fixed by oxidation. From the sequence of reactions shown below

it is apparent that the thiosulphonic acid derivative must be treated with a reducing agent to convert it into the leuco form before dyeing can take place. The final stage consists of oxidation when the fission products reunite to reform the original water-insoluble sulphur dye.

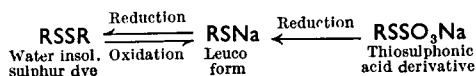

Application of water-soluble sulphur dyes

The methods which are used fall into four categories.

A Liquid mixtures containing sodium sulphide as the reducing agent. Either no or very little sodium sulphide is added and the liquid is poured into the dyebath. The material is entered and the temperature is raised to the boil after which dyeing is allowed to continue in a cooling liquor. There are some dyes for which the maximum temperature recommended is below 100°C. Quantities equivalent to 5 to 15 g/l of common salt or 10 to 30 g/l of crystalline Glauber's salt are added, preferably in several small portions during the dyeing cycle.

B Dye mixtures containing sodium sulphide as the reducing agent and which are in the solid state. The dye is pasted with water at about 30°C and then water equivalent to 10 to 12 times the weight of the paste at the same temperature is added and stirring is continued for a period of 10 minutes. The solution of the dye is poured into the dyebath, to which 5 to 40 per cent on the weight of the goods of common salt or twice the amount of crystalline Glauber's salt together with a small quantity of anhydrous sodium carbonate have also been added. The material is entered and dyed for 45 to 60 minutes at the recommended temperature. With salt-sensitive dyes it is desirable to add the electrolyte in small portions at intervals.

C Dry mixtures containing sodium formaldehyde sulphoxylate as the reducing agent. The dye is pasted and then dissolved by boiling in 10 to 20 times its weight of soft water. This solution is poured into the dyebath and the temperature raised to 90 to 95°C. After 20 to 30 minutes common or Glauber's salt may be added if it is necessary to bring about a satisfactory degree of exhaustion.

D Thiosulphonic acid derivatives. The dye is pasted with cold water and dissolved by boiling, after the addition of sufficient water to ensure solution. The recommended quantity of reducing agent is then added and this may be either sodium sulphide or sometimes sodium hydrosulphite together with sufficient sodium carbonate to ensure stability of the liquor. Electrolyte is added when necessary for satisfactory exhaustion.

The lack of affinity of many of the water-soluble sulphur dyes for cellulose can be of assistance in dyeing tightly-woven piece goods or packages. The method consists essentially of impregnating the material with the dye solution and then exhausting, thus virtually dyeing *in situ*.

Cloth is padded at 80° to 90°C (176° to 194°F) and then transferred to a jig, where it is treated at the normal dyeing temperature with the specified quantities of sodium sulphide, carbonate, and salt.

When dyeing in a yarn package machine the dyestuff solution is added at 40°C (104°F) and, whilst the liquor is in circulation, the temperature is gradually raised to that recommended for the application of the dyes. The required quantities of sulphide and soda ash are dissolved separately, filtered, and entered into the machine gradually over a period of 20 to 30 minutes, after which exhaustion may be completed slowly, adding 15 to 25 per cent of common salt according to the shade.

The solubilized sulphur dyes respond to after-treatment with copper and chromium salts, as do the parent dyestuffs from which they are derived. C.I. Sulphur Blue 4 and C.I. Sulphur Brown 1 are brightened and developed more rapidly by after-treatment with perborate, percarbonate, or hydrogen peroxide, but members of the group usually develop by atmospheric oxidation.

There are a few direct dyes which are stable in the presence of sodium sulphide and they may be used for shading, either by incorporation in the original recipe or by addition to the dye liquor to make a final adjustment. It must, of course, be borne in mind that such additions will detract from the wash-fastness. Some which are specifically recommended are:

C.I. DIRECT YELLOW 28
C.I. DIRECT YELLOW 29
C.I. DIRECT RED 1
C.I. DIRECT BROWN 1

Sulphur dyes may be topped with basic dyes and, because the former act as mordants, the resultant wet-fastness is good. From 0.1 to 0.5 per cent of the basic dye is used, together with 2 to 5 per cent of acetic acid. The goods are entered into a cold bath in which the acid has already been placed. The temperature is raised slowly to 50°C (122°F), during which time the dye is added in portions.

20 · Vat dyes

THE vat dyes are found amongst the oldest natural colouring matters used for textiles. Indigo has been known in India since the earliest periods of which historical records exist. According to the writings of Julius Caesar the Ancient Britons used Woad to stain their bodies and faces and Tyrian Purple was exported from Tyre to the Mediterranean countries nearly 4000 years ago. Tyrian Purple is extracted from a shell fish and is therefore of animal origin, but Woad and Indigo exist in plants, combined with glucose in the form of glucosides. The vat dyes are all insoluble in water and cannot be used for dyeing without modification. When treated with reducing agents they are converted into leuco compounds, all of which are soluble in water in the presence of alkalis. These leuco compounds are substantive towards cellulose and reoxidize to the insoluble coloured pigment within the fibre when exposed to air. The leuco compounds are often colourless or of quite a different colour from the product of oxidation.

Before chemical reducing agents were available the naturally-occurring vat dyes were reduced by fermentation of organic matter in a wooden vessel referred to as a vat—and this is the origin of the name vat dyes. Indigo was outstandingly the most important natural dye of this class and the manufacture of the substance from coal-tar derivatives constituted one of the classical triumphs of industrial organic chemistry. The successful large-scale production of Indigo from naphthalene dates from about 1900 and, since then, the synthesis of vat dyes has been an extremely active field of research and many new members have been added to this class. They embrace a wide range of structural types and often the molecules are complex, but they all contain one or more carbonyl groups ($\text{>C} : \text{O}$) which, when treated with reducing agents, combine with hydrogen to form leuco compounds containing (>C.OH) groups. These secondary alcohols do not dissolve in water but form soluble sodium derivatives (>C.ONa) in the presence of alkalis. On exposure to air the sodium compound is converted to the insoluble coloured derivative through the following reactions:

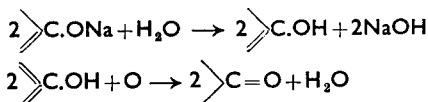

Dyeing with vat dyes thus involves three separate operations:

- (i) Preparation of the vat, or a solution of the sodium derivative of the leuco compound.

- (ii) Impregnation of the goods with the leuco compound.
- (iii) Oxidation on the fibre to the insoluble pigment.

Vat dyes are divided into two main classes:

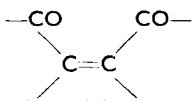
- (a) The indigoids containing the chromophore  and usually derivatives of Indigotin, **(1)**, or Thioindigo, **(2)**.

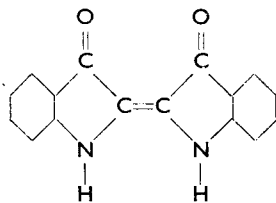
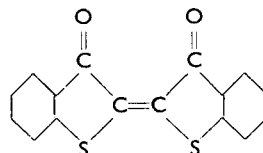
**(1)****(2)**

- (b) The anthraquinone vat dyes derived basically from anthraquinone, **(3)**:

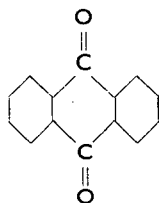
**(3)**

The indigoids form pale-yellow leuco compounds soluble in weak alkaline solutions, and the anthraquinone vat dyes give coloured leuco compounds which are soluble only in strong alkalis.

Until the beginning of the present century Indigo was obtained exclusively from plants, of which the most important was *Indigofera tinctoria*, originally cultivated in India. The knowledge related to Indigo and its properties spread gradually to Egypt and other countries of the Middle East and thence to Greece, Rome, and Europe. Edward III encouraged the cultivation of Indigo in Britain and induced Flemish dyers to settle in the country to practise and teach the art of its application. Considerable opposition was organized by the Woad growers, who feared, not without cause, that it would ruin their trade, and they induced both Henry IV and later Queen Elizabeth I to restrict, or prohibit, the use of Indigo.

The indigo plant cultivated in India is sown, as seed, in February and, by August, has grown to a height of about 3 feet, at which stage the yield of the dye has reached its maximum of about 0.4 per cent of the weight of the plant, and the crop is harvested. The sap extracted from the plants is

greenish-yellow and contains the colouring matter as a soluble glucoside known as Indican, a combination of glucose and Indoxyl, (4):

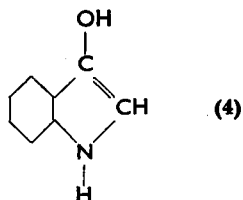

Indoxyl readily reacts with atmospheric oxygen to form the insoluble pigment Indigotin, also known as Indigo Blue:

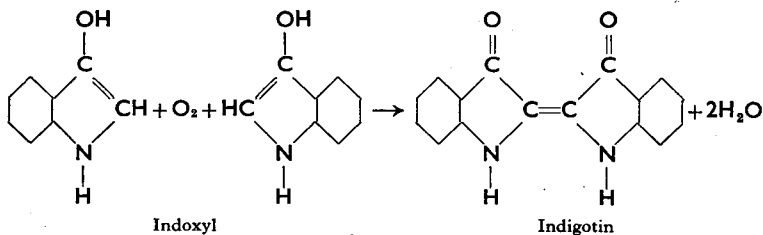

The harvested plants are steeped in water in tanks lined with cement, until fermentation, accompanied by the formation of gas, sets in. When effervescence ceases the hydrolysis of the glucoside is complete and the liquor is separated from the vegetable debris. The extract is collected in fresh tanks, where it is aerated by agitation with moving paddles and the Indoxyl is oxidized to Indigotin, which separates as a blue precipitate. Natural Indigo is associated with varying amounts of Indirubin and Indigo Brown with the result that the shade which it dyes is not constant.

Properties of Indigotin

Indigotin is insoluble in water, alcohol, and dilute acids, but dissolves in boiling glacial acetic acid. It is slightly soluble in chloroform, amyl alcohol, and phenol, but the best organic solvents are boiling aniline or pyridine. It crystallizes from solutions in these solvents in dark blue or purple needles. When heated to about 170°C (338°F) it sublimes, forming a purple vapour which condenses again into blue crystals of pure Indigotin. When treated with concentrated sulphuric acid it dissolves and Indigotin sulphonic acids are formed. The most important is the disulphonic acid, obtained in good yield, by the action of cold sulphuric acid; it is known as Indigo Carmine and is an acid dye which was used for wool.

When Indigotin is treated with strong oxidizing agents, such as nitric acid, or potassium permanganate and sulphuric acid, it is oxidized to Isatin, (5):

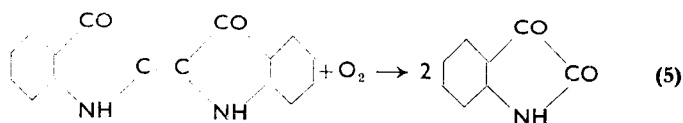

This reaction forms the basis of a common test for the presence of Indigo in a dyed cloth, by observing whether a yellow colour with a green ring at the edge appears when it is spotted with nitric acid.

Indigotin reduces to the leuco compound, known as Indigo White, (6):

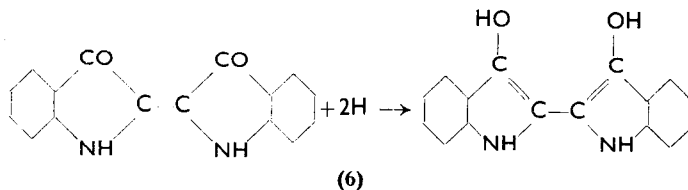

which is colourless and insoluble in water but reacts with sodium hydroxide to form the water-soluble sodium derivative:

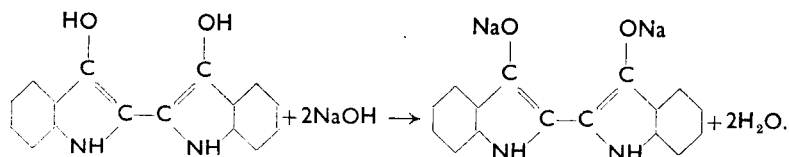

Excess of alkali is necessary to keep the compound in solution because there is a tendency for hydrolysis to occur, accompanied by the formation of the insoluble hydroxyl derivative. The sodium compound is substantive to cellulose and very readily oxidized *in situ* in the fibre to insoluble blue Indigotin by the action of atmospheric oxygen.

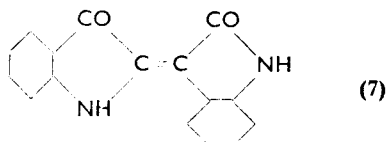

Indirubin, (7), is also a product of the oxidation of Indoxyl and has properties similar to those of Indigotin. It sublimes at 340°C (644°F), is insoluble in water, and forms a leuco compound soluble on reduction in alkalis, for which cellulose has an affinity.

Synthesis of Indigo

One of the disadvantages of natural Indigo was that the proportions of Indigo, Indirubin, and Indigo Brown were never constant, so that there was no certainty about different batches being able to reproduce exactly the same shade. For this reason the production of chemically-pure Indigo which would be of constant composition seemed to be most desirable. At

the beginning of this century the Badische Aniline and Soda Company perfected a process for manufacturing Indigo from naphthalene, with the result that the natural product was very soon entirely displaced. The first stage in the sequence of reactions is that naphthalene is oxidized to phthalic acid, (8):

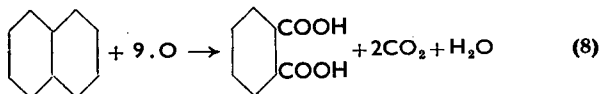

which, when distilled, is converted to phthalic anhydride, (9), and heating with ammonia under pressure converts the latter into phthalimide, (10):

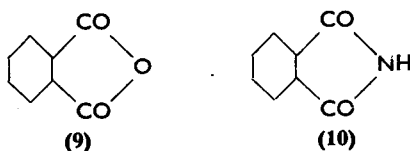

Oxidation with sodium hypochlorite converts phthalimide into anthranilic acid, (11),

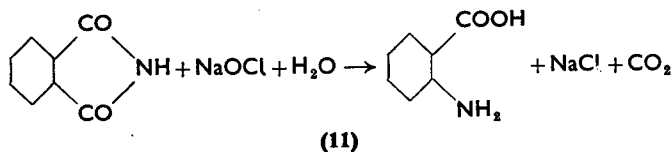

and the latter reacts with chloroacetic acid yielding phenylglycine-*o*-carboxylic acid, (12):

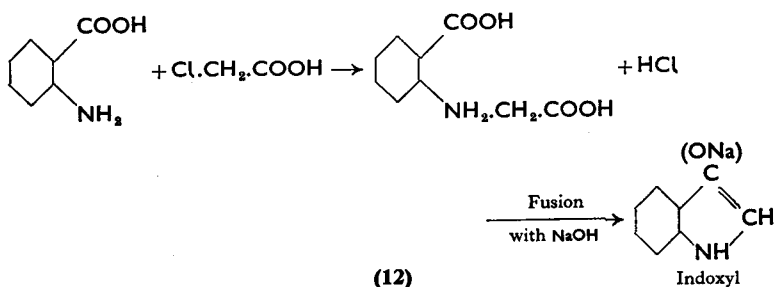

which is converted to Indoxyl by fusion with sodium hydroxide. Oxidation, by passing a current of air through a solution of the sodium derivative of Indoxyl converts it into Indigotin. An improved method for the manufacture of Indigo was discovered later. The sodium salt of phenylglycine-*o*-carboxylic acid was fused with sodium hydroxide to which a small amount of sodamide had been added and this gave a better yield.

Another process consists of heating aniline with formaldehyde, water, and sodium cyanide under pressure in an atmosphere of carbon dioxide. The result is a nitrile which, when heated with an aqueous solution of sodium hydroxide yields the sodium salt of phenylglycine and the latter, when fused with caustic alkali and sodamide gives rise to indoxyl as shown in the following series of reactions:

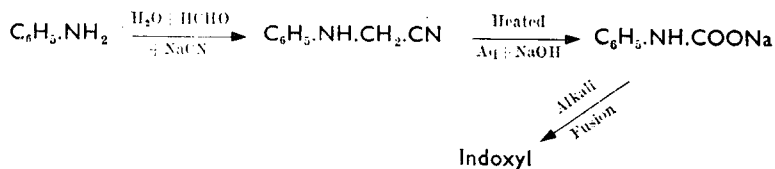

A third route is to prepare β -hydroxyethylaniline by the action of ethylene chlorhydrin on aniline and obtain indoxyl from it by fusion with sodium hydroxide and calcium oxide:

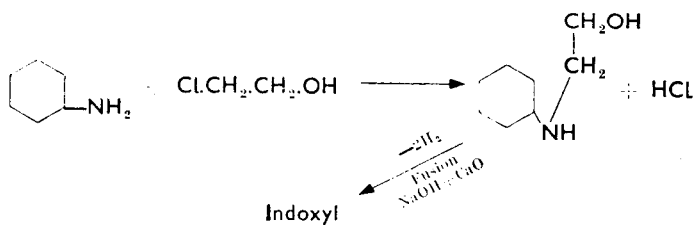

Substituted Indigos

Halogen-substituted derivatives are obtained when suspensions of Indigotin in organic solvents are treated with chlorine or bromine, such as:

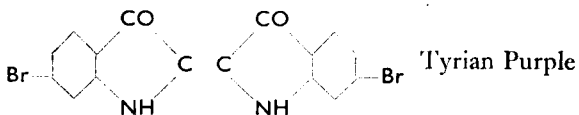
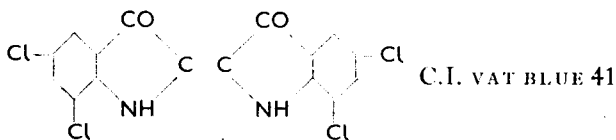

Increasing the number of bromine atoms causes a shift of the shade towards green, accompanied by decreasing solubility of the sodium salt of the leuco compound.

The Thioindigos are vat dyes in which one or both the NH groups in the Indigo have been replaced by sulphur atoms.

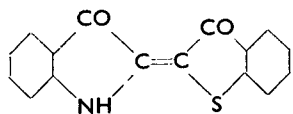

C.I. VAT BLACK 1

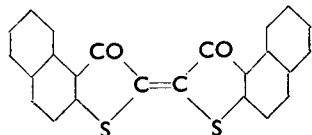

C.I. VAT BROWN 5

In 1901 a most important discovery was made by Bohn. He endeavoured to make the anthraquinone analogue of Indigo by fusing the substituted glycine, derived from 2 : amino-anthraquinone, (13), with caustic soda. A blue vat dye was obtained, but instead of the anticipated product it was proved to be Indanthrone, (14), or Indanthren Blue RS (C.I. VAT BLUE 4):

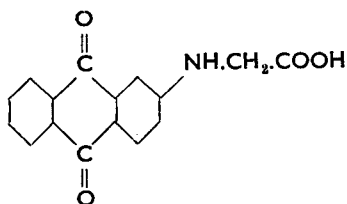

(13)

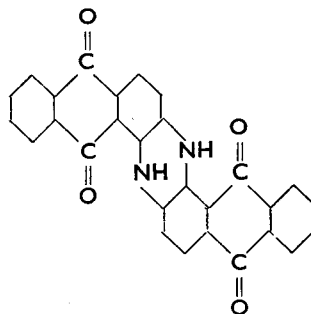

(14)

Two or four of the carbonyl groups in formula (14) reduce to hydroxyl, (15) and (16), giving leuco compounds soluble in alkalis and substantive

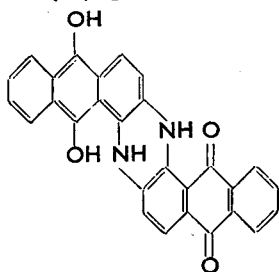

(15)

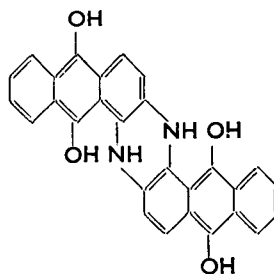

(16)

to cellulose. Indanthren Blue RS was the forerunner of a large number of vat dyes, based on the anthraquinone structure, which can be made in a greater range of shades and possess better fastness properties than those derived from Indigo. The anthraquinone vat dyes, however, reduce to leuco compounds which require stronger alkali to form stable solutions than do the Indigoids and, therefore, they find no application to the protein fibres.

Halogen substitution of Indanthrone increases the range of shades. Thus Indanthren Blue GC (C.I. VAT BLUE 11) is a dibromo derivative and Caledon Blue RC (C.I. VAT BLUE 6) contains two chlorine atoms, (17) and (18).

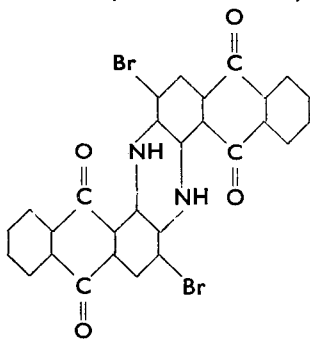

(17)

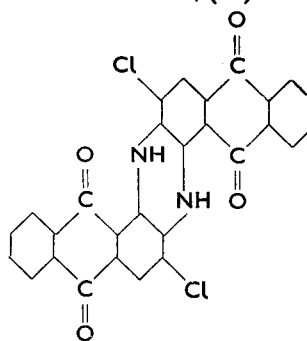

(18)

The early anthraquinone vat dyes were all blue or greenish-blue shades, but the fusion of 2 : amino-anthraquinone at higher temperatures produced a yellow vat dye known as Flavanthrone or Indanthren Yellow G (C.I. VAT YELLOW 1), (19):

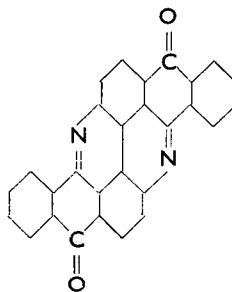

(19)

A further development was the fusion of 2 : methyl anthraquinone with caustic alkali, when water was eliminated, and the dyestuff Indanthren Golden Orange G (C.I. VAT ORANGE 9), (21), containing the characteristic pyrene structure, (20), was the resultant product.

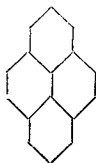

(20)

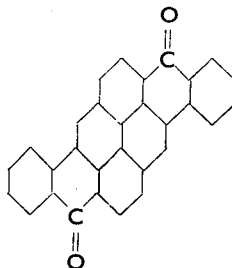

(21)

Pyranthrone or
Indanthren
Golden Orange G

Caledon Orange 2RT (C.I. VAT ORANGE 2) is the dibromo derivative of pyranthrone and Caledon Brilliant Orange R (C.I. VAT ORANGE 4) is the tribromo substitution product.

When anthraquinone in which one of the carbonyl groups has been reduced to a methylene group is condensed with one molecule of acrolein, the product is 1 : 9 benzanthrene, (22):

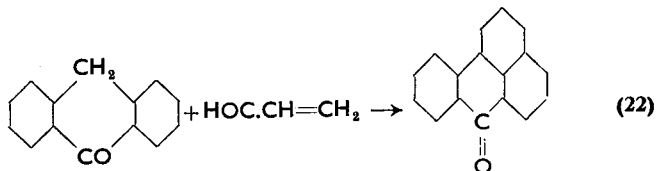

The compound is not, itself, used as a vat dye but is important because, when it is fused with caustic potash 2 molecules unite, yielding dibenzanthrone, (23), from which many vat dyes are derived, the best known example being Caledon Jade Green 3B (C.I. VAT GREEN 4), (24).

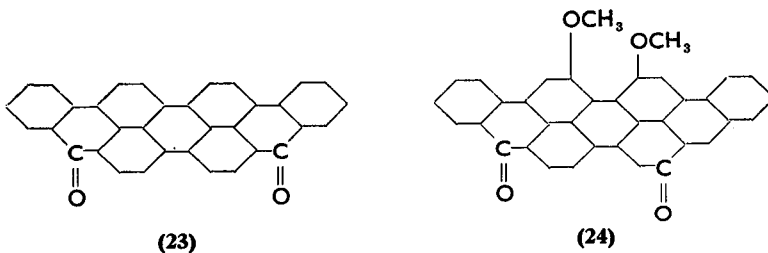

These few examples give some small indication of the chemistry of the Indigoid and Anthraquinone vat dyes, but the subject covers a wide range and the molecular structure of many is far from simple. For further information, Fox (*J.S.D.C.*, 1949, 65, 508), Bradley (*R.I.C. Special Publication*, No. 5, 1958), or Thomson (*J.S.D.C.*, 1936, 52, 237 and 247), should be consulted.

Structure and affinity

It would be natural to expect that conditions governing the relationship between structure and affinity found in the direct dyes would also apply to vat dyes. The picture is, however, more confused because not only are many of the molecules non-linear but they are also deficient in groups capable of forming hydrogen bonds. Thomson (*J.S.D.C.*, 1936, 52, 247) suggested that the substantivity of the anthraquinone vat dyes depended

upon molecular complexity, but this explanation was not entirely convincing. The subject was studied by Peters and Sumner (*J.S.D.C.*, 1955, 71, 130), who state that the possibility of hydrogen-bond formation could not be ignored. As an example it was quoted that substances represented by formulae (25) and (26) had no affinity for cellulose, but compounds (27) and (28), containing bond-forming amido groups, were substantive.

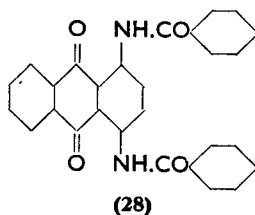
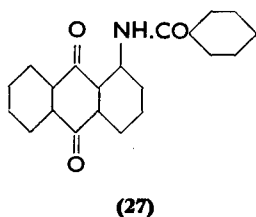
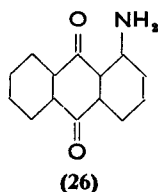
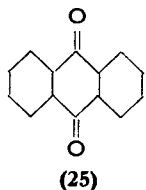

There are, however, too many anomalies for hydrogen-bond formation to be the only explanation, and it was suggested that Van der Waals forces were also an important factor, and one which becomes more prominent as molecular complexity increases. Although the molecule may not be linear it must be sufficiently planar to permit it to approach within the range of action of the binding forces. Evidence in support of this was provided by introducing substituents into the *o*-position in the side chain of 1 : benzamido anthraquinone, (27), which pushes the benzene ring out of position and results in a significant decrease of affinity. The effect of molecular complexity on affinity is illustrated by an example quoted by Fox (*loc. cit.*). Indanthren Yellow FFRK, (29),

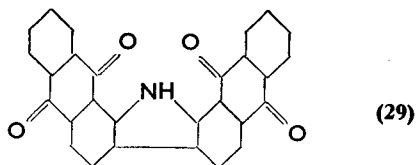

has a poor affinity and requires the addition of salt, but Indanthren Khaki 2G, (30),

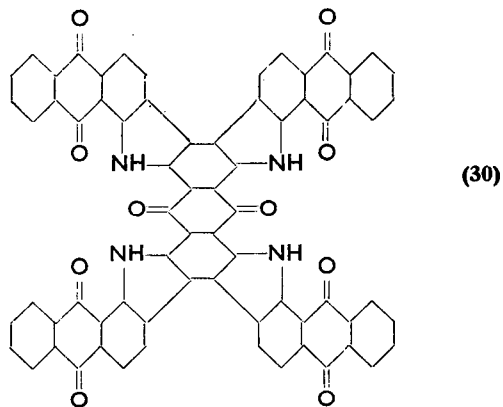

exhausts well without the addition of an electrolyte.

The relationship between affinity and planar configuration was studied

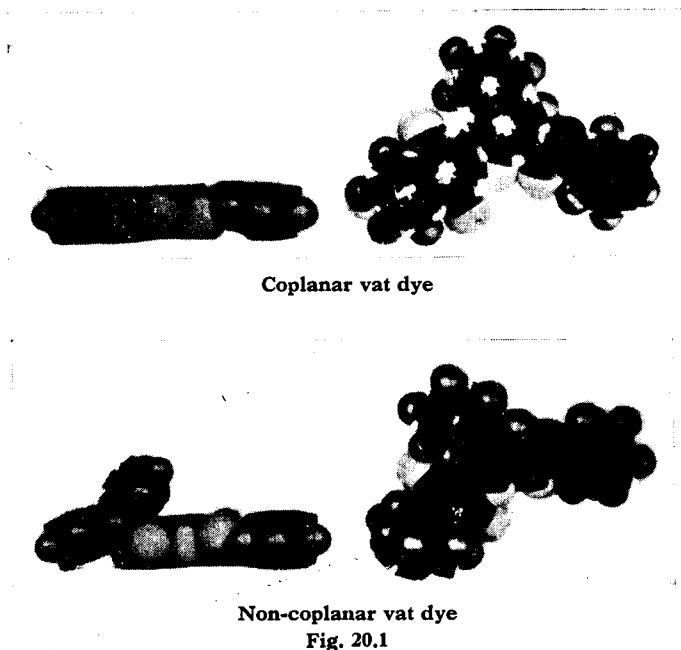

by Daruwalla, Rao, and Tilak (*J.S.D.C.*, 1960, 76, 418). A number of pairs of vat dyes were synthesized in which one was coplanar and the other non-coplanar, see Fig. 20.1. In every case the affinity of the non-coplanar molecule was extremely low, as shown in the table which follows.

*Affinity values of quinonoid vat dyes at 20°C (68°F).
(Similar pairs bracketed)*

		(Affinity as k.cal/mole)
{	Planar	2.54
	Non-planar	< 0.1
{	Planar	2.76
	Non-planar	< 0.1
{	Planar	3.04
	Non-planar	< 0.1
{	Planar	3.9
	Non-planar	< 0.1
{	Planar	4.13
	Non-planar	< 0.1

The application of vat dyes

Most vat dyes are sold in the insoluble oxidized form. The first operation, therefore, consists of reduction to the leuco compound and dissolving the latter in alkali, a process commonly referred to as vatting. The classical natural vat dyes such as Indigo and Tyrian Purple were reduced in a fermentation vat. The operation, as described in Chapter 1, was exceedingly laborious and variable in result. There was, therefore, a constant search for an easier and more reliable method.

One of the earlier processes for reducing Indigo, based on the use of chemicals instead of micro-organisms, was with 'copperas', the colloquial name for ferrous sulphate. The ferrous sulphate was dissolved in water and lime water added; ferrous hydroxide was then precipitated which rapidly reacted with the oxygen with the formation of ferric hydroxide, accompanied by the liberation of hydrogen.

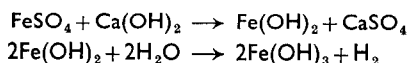

Since the Indigoid leuco compounds dissolve in mild alkalis the excess of calcium hydroxide sufficed for this purpose. The copperas method was followed by the 'zinc-lime' vat, based upon the fact that zinc dissolves in lime water, forming calcium zincate and hydrogen.

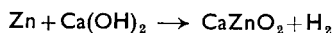

Neither method was entirely satisfactory because the copious precipitates of either ferric hydroxide or calcium zincate interfered seriously with the dyeing process.

Modern large-scale vat dyeing was finally made possible by the appear-

ance of sodium hydrosulphite as a commercial product (see Chapter 10). A stock solution of reduced Indigo may be prepared, using the following quantities as a basis. Ten pounds of Indigo paste (20 per cent) are mixed with 2 gallons of water. To this 2½ lb of sodium hydrosulphite (dithionite) are added with constant stirring, followed by 5 pints of caustic soda of 76°Tw (34.5 per cent) and the liquor is maintained at 60°C (140°F) until reduction is complete, which generally requires about 2 hours.

Application of Indigo to cotton

Since dyeing is carried out at a low temperature a good preliminary scour is necessary to make the cotton easily permeable. The dye vessel is filled with soft water and the dissolved oxygen is removed by the addition of 1 oz per 100 gallons of sodium hydrosulphite. The required amount of reduced Indigo is added from the stock vat and the goods are immersed in the dye liquor at 20° to 25°C (68° to 77°F) and agitated for 15 minutes. It is important that a machine or method of handling should be used in which the goods are totally immersed to prevent premature oxidation from taking place in parts which are exposed to the air. At the end of 15 minutes the goods are taken out, the excess liquor is squeezed back, and the leuco compound is oxidized by exposure to air. The first dip will only give a pale blue and the sequence of operations is repeated 2, 3, 4, or 5 times until the necessary depth of shade is obtained. Cellulose has no great affinity for the leuco compound of Indigo and heavy shades must therefore be built up by successive immersions because an excessive concentration of the dye in the liquor leads to unsatisfactory rubbing fastness. Exhaustion can be improved by the addition of 5 to 40 per cent of common salt, according to the depth of shade and the liquor ratio. Deep shades are built up by successive immersions in a series of liquors of increasing strength. Thus the first bath might, for example, contain 0.3 g per litre of reduced Indigo and concentrations would increase until, in the sixth, it is 3 to 4 g per litre. A counter-flow system may be used, the first bath being fortified from the second, and so on, all additions of reduced Indigo being made to the final liquor. When the dyed goods have been exposed to air for long enough for oxidation to be complete, they are scoured thoroughly to remove any insoluble Indigo Blue deposited on the surface of the fibres.

Piece goods and cotton warps are usually treated in a continuous dyeing range, illustrated diagrammatically in Fig. 20.2 (TURNER, *Hexagon digest*, No. 18).

The grey material is fed into the first box, which has a capacity of 1250 gallons, and contains a boiling solution of a wetting agent such as Calsolene Oil HS. In the second compartment it is rinsed thoroughly. It then passes into the first of the Indigo vats, which has a capacity of 4200 gallons. The material has two dips each lasting 50 seconds and, between each, it passes over guide rollers situated some height above the level of the liquor, so that

the periods indicated in Fig. 20.2 are available for the air to oxidize the leuco compound. It then passes into the second Indigo vat, where it has two

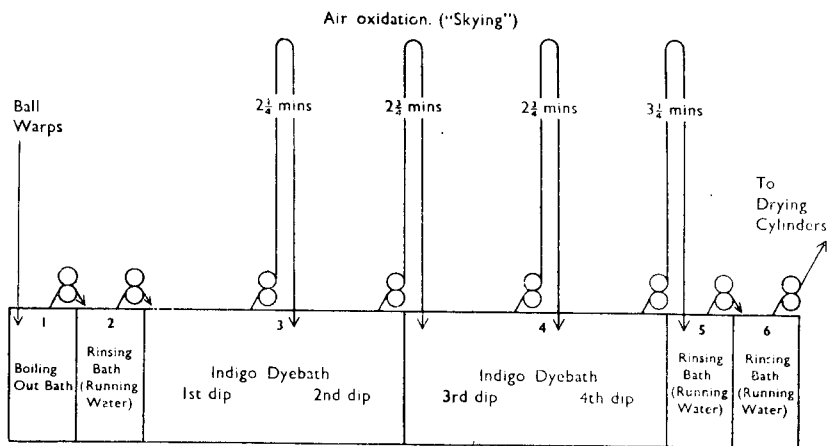

Fig. 20.2 Continuous dyeing range—cotton warps
(*Hexagon digest I.C.I.*)

dips, and finally through two rinses to remove alkali and unoxidized leuco compound.

Application of Indigo to wool

Protein fibres have less affinity than cellulose for reduced Indigo at low temperatures and dyeing is carried out at 38° to 60°C (100° to 140°F). The alkalinity of the liquor must also be kept as low as possible to avoid degradation of the fibre. The stock vat is made alkaline with lime, or more commonly with ammonia, and glue may be added to the dyebath as a protective colloid. On account of the slower rate of exhaustion the period of immersion in the dye liquor must be twice as long as for cotton (30 minutes instead of 15). A typical bath for dyeing wool would be made up in the following manner (HORSFALL AND LAURIE, *The Dyeing of Textile Fibres*). The dye vat is filled with 900 gallons of water and the temperature raised to 50°C (122°F) and 3 pints of ammonia (15 per cent, 0.943 sp gr) together with 2 lb of sodium hydrosulphite and 2 gallons of a 10 per cent solution of glue are added. Finally 2 gallons of a 20 per cent Indigo paste are put in with constant stirring. After a 30-minute dip in this liquor the shade is developed by atmospheric oxidation, and further dips, followed by oxidation, are performed until the colour is the desired depth. Finally the wool is scoured to remove surface-deposited colour. It is difficult to dye really deep blue shades on wool because of the lack of affinity, and it is therefore common to top Indigo with other dyes.

Application of anthraquinone vat dyes

There are a number of different reactions which can occur during the reduction of anthraquinone or indanthrone vat dyes. The indanthrones can be reduced at two carbonyl groups, which, in this particular case, is desir-

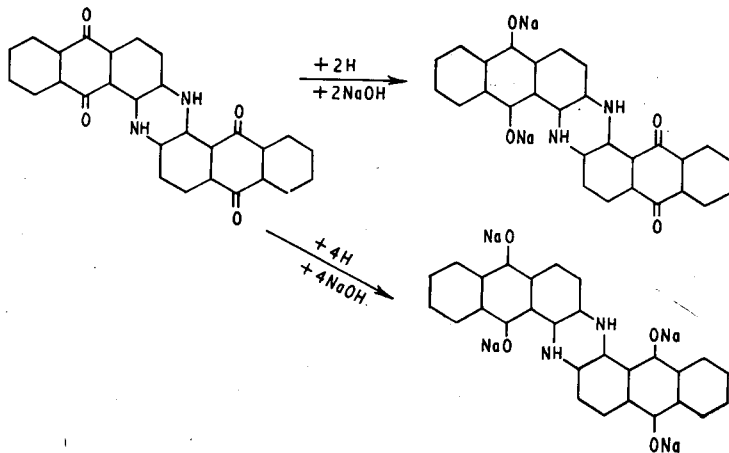

able for dyeing, but also at four, which gives rise to a different leuco compound, bringing about a new set of conditions. The quantity of alkali is also significant because the sodium salt of the leuco compound may be looked upon as the product of a weak acid and a strong base. The equilibrium state of a pure sodium salt would lie well to the left side of the equation

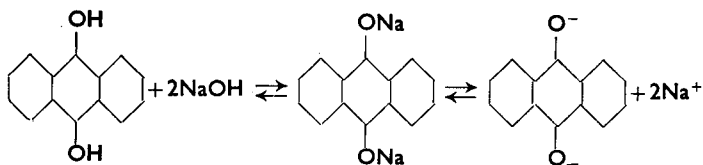

above, and a sufficient excess of sodium hydroxide is necessary to drive it over to the right. If the alkali be insufficient to keep the pH of the system well above 7 the anthrahydroquinone derivative, (31), may undergo isomeric change to an oxanthrone, (32), which does not oxidize very easily

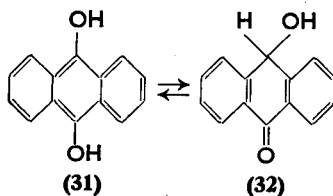

to an anthraquinone but reduces quite easily to anthrone, (33), a compound which isomerizes to anthranol, (34). The anthranol oxidizes readily

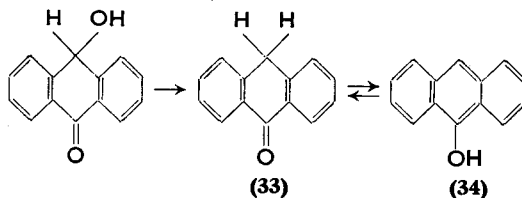

to a mixture of products other than the vat dye pigment. Thus unless the conditions of vatting are observed with scrupulous care a number of side reactions can take place leading to aberrations from the standard shade (WILTSHIRE, *Hexagon digest*, No. 5). Careful control of temperature during vatting is also most important because if it is too low reduction will be incomplete, but if too high the reducing agent may react with the dye. Thus Caledon Blue RC may lose bromine atoms with significant alteration in its shade if reduction goes too far.

Theoretically, every vat dye will have its own optimum temperature and specific proportions of alkali and reducing agent for vatting. In practice it suffices to divide them into four groups applied by methods 1, 2, 3, or 4.

Method 1 is used for vat dyes requiring relatively high alkali concentration, and high vatting and dyeing temperatures. They exhaust well and require no electrolyte.

Method 2 applies to dyes requiring only a moderate amount of alkali, lower temperatures for reducing and dyeing, but require the addition of some salt to complete exhaustion.

Method 3 is based on low alkali concentration, low vatting and dyeing temperature but considerable quantities of electrolyte.

Table 20.1

<i>Dyeing method</i>	1	2	3	4
Dye (single strength) (per cent)	5	5	5	20
FOR VATTING				
Water (gallons)	5	5	5	20
Caustic soda (pints) 70°Tw (24.5%)	2½	2½	2	10
Sodium hydrosulphite (lb)	1¼	1¼	1¼	5
ADDITIONS TO DYEBATH				
Caustic soda (pints), 70°Tw (24.5%)	16	4	4	32
Sodium hydrosulphite (lb)	2	2	2	4
Sodium sulphate, anhydrous, or common salt (lb)	—	10	40	—

(Quoted from I.C.I. Instructions.)

(The quantities relate only to a 20: 1 liquor ratio and would differ with shorter or longer liquors.)

Method 4 is a special case for dyeing blacks with exceptionally high alkali concentrations and temperature but no use of electrolyte.

The quantities are tabulated in great detail by the suppliers of the dyes and the example quoted in Table 20.1 is for dyeing 100 lb of yarn in 200 gallons of water and only serves as an illustration of the order of the quantitative relations.

The vatting and dyeing temperatures vary from one dye to another, irrespective of method, but as an approximate guide the temperature quoted in the instructions given by the Society of Dyers and Colourists for standard dyeings are quoted below (*J.S.D.C.*, 1950, **66**, 506):

<i>Method</i>	<i>Vatting temperature</i>	<i>Dyeing temperature</i>
1	60°C (140°F)	60°C (140°F)
2	50°C (122°F)	50°C (122°F)
3	40°C (104°F)	20°C (68°F)
4	60°C (140°F)	60°C (140°F)*

* Not quoted from *J.S.D.C.*

Cellulose has a strong affinity for many of the sodium salts of the leuco compounds of vat dyes, and precautions such as temperature and salt control and gradual addition of the dye may be necessary to avoid unlevel dyeing. With those colours which develop their maximum affinity at 50° to 60°C (122° to 140°F), dyeing may be commenced at 30°C (86°F) and the temperature raised slowly. When penetration is extremely difficult the temperature may be raised above that of maximum adsorption to assist migration and the liquor allowed to cool back to complete exhaustion before the goods are taken out. There are, however, some vat dyes, such as Caledon Blue. XRC (C.I. VAT BLUE 6) and Caledon Brilliant Purple 4RP (C.I. VAT VIOLET 1), which are unstable at higher temperatures.

The addition of a non-ionic dispersing agent to the dyebath assists penetration but decreases the degree of exhaustion at equilibrium. When dyeing heavy shades, therefore, the addition of dispersing agents can be undesirable. Individual vat dyes vary considerably with regard to their response to the restraining influence of non-ionic condensates (*I.C.I. Publication, Vat Dyeing of Cotton Yarn*).

It is important that the dispersing agent should be added to the made-up liquor and not during vatting. These non-ionic surface-active compounds promote migration and can be used for the correction of unlevel dyeings, the goods being treated at 85°C (185°F) in a fresh liquor containing sufficient sodium hydroxide and hydrosulphite to reduce the dye to its leuco compound.

When it is necessary to use two or more dyes to match a shade it is desirable, wherever possible, to choose those which are applied by the same method. There are many, however, which respond well to more than one process specification and, provided the selection is made judiciously, it is

often permissible to use a recipe which combines vat dyes for which different methods are recommended.

Reference has already been made to the need for excess of alkali to discourage hydrolysis of the sodium derivative of the leuco compound. Some of the alkali will also be consumed by neutralizing the sodium bisulphite formed during the reduction by the sodium hydrosulphite. A great excess above the theoretical stoichiometric quantity of hydrosulphite has also been found to be necessary. This is accounted for by the oxidizing action of atmospheric oxygen and is more apparent in machines that tend to aerate the liquor. After dyeing for $\frac{1}{2}$ to $\frac{3}{4}$ hour it is usually necessary to add some more hydrosulphite to retain the reducing power of the dyebath, and to prevent precipitation of insoluble oxidized vat dye on the surface of the goods.

When the pattern is matched the cutting should be oxidized and soaped under conditions resembling those which will be applied to the bulk. This precaution is important because the shade can show significant variation according to the nature of the after-treatment.

Oxidation

Practically all leuco compounds of vat dyes will oxidize on exposure to air but the reaction often takes 30 to 45 minutes to complete. When the goods are in an open state and air has access to every part, atmospheric oxidation does not present much difficulty. When the material is in a dense mass such as a tightly-wound roll or a cheese or cone of yarn, the penetration of air to the innermost portions may be slow and in such cases treatment with an oxidizing agent is of assistance. The goods can be rinsed with cold water and then treated for 10 to 20 minutes at 30° to 40°C (86° to 104°F) in a liquor containing 1 to 2 parts per 1000 of potassium dichromate and 2.5 to 10 parts of 30 per cent acetic acid. More frequently the oxidation is carried out at 40° to 50°C (104° to 122°F) in a solution containing 3 parts of sodium percarbonate or 2 parts of sodium perborate per 1000, followed by a rinse and treatment with dilute acetic acid (6 to 10 parts of 30 per cent acid per 1000) to neutralize the alkali derived from the per-salt.

Vat dyes should always be finished off with a thorough soaping at the boil. The purpose is to remove loose pigment which will always be deposited, to some extent, on the surface of the fabrics and, if not washed out, will cause lack of rubbing fastness. The soap treatment can, however, have an effect upon the shade. The phenomenon was investigated by Bean and Rowe (*J.S.D.C.*, 1929, 45, 67), who showed, by microscopic examination, that the azoic dyes aggregated in the fibre during soaping (see Chapter 18), and in the same paper a few observations are described on vat dyes which suggest that they behave in a similar manner. The subject was investigated further by Kornreich (*J.S.D.C.*, 1942, 58, 177), who attributed the colour changes to crystallization, preceded by transitory hydration, rather than

aggregation. A more thorough survey was made by Sumner, Vickerstaff, and Waters (*J.S.D.C.*, 1953, 69, 181). Examination with the aid of an electron microscope provided evidence that the aggregates took the form of crystallites, and measurement of dichroism with a recording spectrophotometer indicated increased orientation of the dye in a direction transverse to the longitudinal axis of the fibre. It was also demonstrated that, although crystallization can take place in water, it is greatly accelerated by a detergent compound. Individual vat dyes vary very much in the rate at which they crystallize, but the change is more rapid at higher temperatures, and greater consistency in shade will result if soaping is always carried out at the boil.

Fastness of vat dyes

A few vat dyes, with their light, boiling caustic soda and hypochlorite bleach fastnesses, are shown in Table 20.2 to give an impression of the order of these properties which they possess.

Table 20.2

Dye	C.I. number	Fastnesses (S.D.C.)		
		Light	Caustic boil	Bleach
Cibanone Yellow G	VAT YELLOW 1	5-6	3-4	5
Caledon Yellow 5G	VAT YELLOW 2	4	5	5
Tinon Golden Yellow GK	VAT YELLOW 4	5-6	4	5
Sandothrene Golden Yellow NRK	VAT ORANGE 1	6-7	4	5
Caledon Brilliant Orange 6R	VAT ORANGE 3	6-7	3-4	5
Ciba Orange R	VAT ORANGE 5	4-5	3-4	4
Sandothrene Red N4B	VAT RED 24	6-7	5	4-5
Caledon Brilliant Red 3B	VAT RED 10	6-7	4-5	5
Thio Tinon Blue 2R	VAT BLUE 43	5	4	3
Indigo	VAT BLUE 1	4	1	2
Indanthrene Blue BC	VAT BLUE 6	7-8	5	3-4
Caledon Brown R	VAT BROWN 3	7	5	5

It will be observed that the light fastness of a few would be rated moderate. Vat dyes should be selected for the purpose for which they are intended and only those with the best light fastness used for furnishings and casement fabrics.

Accelerated photochemical action

Several vat dyes, particularly in the yellow and orange colour range, can cause accelerated oxidation under the influence of light. It has been known for a long time that when certain vat blues and yellows which were both

individually fast to light were dyed in combination, the blue component in the resultant shade faded more rapidly than would be anticipated. This is only apparent when a certain minimum proportion of yellow in the recipe had been exceeded (FITZSIMMONS, *J.S.D.C.*, 1934, 50, 305). It was reported by Schofield and Patel (*J.S.D.C.*, 1928, 44, 268) that an examination of the effect of exposure to light of vat-dyed casement cloths revealed that the photochemical degradation of the cellulose was significantly greater in samples dyed with yellows and oranges. The effect received considerable attention when regenerated cellulose rayons became popular for casements because the materials were lighter in structure and the yarn had less initial strength. A list of dyes permissible for casements and furnishings was issued and the following are dyes in current use which are known to be liable to promote tendering of cellulose under the influence of light.

C.I. VAT YELLOW 26
 C.I. VAT YELLOW 2
 C.I. VAT YELLOW 4
 C.I. VAT ORANGE 9
 C.I. VAT ORANGE 2

The same dyes can be the cause of accelerated tendering during hypochlorite bleaching, where the goods have been exposed to light. When bleaching is conducted in a stationary vat, only the dyed portions lying on the surface will therefore be affected. The cause of accelerated oxidation of the cellulose has not been established with certainty. It has been demonstrated that hydrogen peroxide is formed when a dye, known to be tendering, is suspended in water and exposed to light. It may be that the action of light causes liberation of oxygen or hydrogen peroxide from water, and the vat

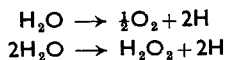

dye, by becoming reduced to the leuco compound, removes the hydrogen, thereby promoting more formation of oxygen or hydrogen peroxide which reacts with the cellulose. The leuco compound is rapidly reoxidized by atmospheric or dissolved oxygen so that the cycle can commence again. There must, however, be other factors involved, but an explanation covering all aspects of the phenomenon has not yet been forthcoming.

Dyeing properties of vat dyes

The recommended procedure for determining which method of dyeing is to be preferred is ascertained as follows (*J.S.D.C.*, 1950, 505). Dyeings are made in full shades equivalent in strength to:

	<i>Dyed by Method</i>
20 per cent Caledon Yellow 5GS Paste	1
20 per cent Caledon Brilliant Red 3BS Paste Fine	2

	<i>Dyed by Method</i>
4 per cent Cibanone Red 4B Powder	2
20 per cent Caledon Brilliant Violet RS Paste Fine	3
6 per cent Caledon Brilliant Violet 3BS Paste Fine	1
20 per cent Caledon Jade Green XNS Paste Fine	1
20 per cent Caledon Blue RCS Paste Fine	1
20 per cent Caledon Grey MS Paste Fine	1

Test dyeings on 10-g hanks are then carried out as described (*loc. cit.*) by the following three methods in a 30 : 1 liquor ratio.

Table 20.3

<i>Method</i>	<i>1</i>	<i>2</i>	<i>3</i>
Caustic soda, 53°Tw (300 g/litre), ml	4.5	2.0	2.0
Sodium hydrosulphite, g	1.0	1.0	1.0
Common salt, g	0	3.0	6.0
Vatting temperature, °C	60	50	40
°F	140	120	105
Dyeing temperature, °C	60	50	20
°F	140	120	68
Dyeing time, min	40	40	40

The preferred dyeing method is that which gives the greatest colour yield and is classed as Grade 5, and the results obtained by the other methods are described by assessing the differences from the preferred method on the S.D.C. Grey Scale No. 2 (see Chapter 24). The three methods above are only applicable to anthraquinonoid dyes. There is a variation in procedure for indigoid dyes because vatting is carried out at two temperatures, either 50°C (122°F) or 80°C (176°F). For specific details as to how the test should be performed, the Society of Dyers and Colourists' publication must be consulted.

The strike-levelling test is designed to determine the rate of 'strike' and the ability of partly dyed material to level. A liquor containing the dye under examination is made up so that it shall yield a shade equivalent in depth to one of the following.

	<i>Dyeing Method</i>
5 per cent Caledon Yellow 5GS Paste Fine	1
1 per cent Cibanone Red 4B Powder	2
5 per cent Caledon Dark Brown 3RS Paste Fine	2
5 per cent Caledon Jade Green XNS Paste Fine	1
5 per cent Caledon Brilliant Violet RS Paste Fine	3
5 per cent Caledon Blue RCS Paste Fine	1
20 per cent Caledon Dark Blue BMS Paste Fine	1

The dyeing temperature is the same as the preferred method except that when Method 3 is used the dyes are also tested at 50°C (122°F) and no salt is added with any of the methods. A 5-g hank is entered into the dyebath and turned steadily and continuously, and after 2 minutes a second 5-g hank is entered and turned with the first. After a further 3 minutes both hanks are removed from the dyebath, after-treated in the method specified for the test, and the difference in depth of the shade between the two hanks is a measure of the strike and is assessed with the S.D.C. Grey Scale No. 2.

In order to determine the levelling property of the dye the dyebath is made up as before and a 5-g hank is placed in it and turned continuously. After 2 minutes a second 5-g hank is entered and the two are turned together without cessation for a further 3 minutes, and thereafter they remain in the liquor for a further 35 minutes, being turned during 1 minute in every 5. The two hanks are then taken out and finished in the specified way and the difference in depth compared with the S.D.C. Grey Scale No. 2.

In order to check the technique of testing in different laboratories the following standard has been specified. A 40/2 bleached cotton yarn is dyed by Method 1 with 5 per cent of Caledon Jade Green XNS Paste Fine. It should give the following results:

Strike	Grade 2-3
Levelling	Grade 3-4

Migration test

Two 5-g hanks of the sample are dyed in the manner described for the strike test and after-treated, with the exception that soaping is omitted. One dyed and one undyed 5-g hank are placed in a liquor made up according to the preferred method for a 10-g quantity of cotton, excluding the electrolyte and dye. The hanks are treated in 'blank' liquors at 50°C (122°F) and 80°C (176°F) for 40 minutes, turning continuously for the first 5 minutes and then 1 minute in every 5 for the remainder of the test. They are then finished off in the usual manner, the second of the original dyed hanks being entered at the soaping stage. The difference in shade between the two hanks which have been treated in the 'blank' bath is then assessed with the S.D.C. Grey Scale No. 2, and any alteration in hue of the dyed hank treated at 80°C (176°F) in relation to the specimen only soaped is noted. Testing technique can be compared with a 5 per cent dyeing of Caledon Jade Green XNS Paste Fine which gives

at 50°C (122°F)	Grade 1
at 80°C (176°F)	Grades 3-4

Solubilized leuco compounds

It will be realized that vatting is a troublesome operation requiring scrupulous care and there has always been a strong incentive to find some

way of simplifying the application. In 1921 Bader and Sunder prepared the disulphuric ester of leuco indigo, (35), by causing its solution in pyridine to react with chlorosulphonic acid.

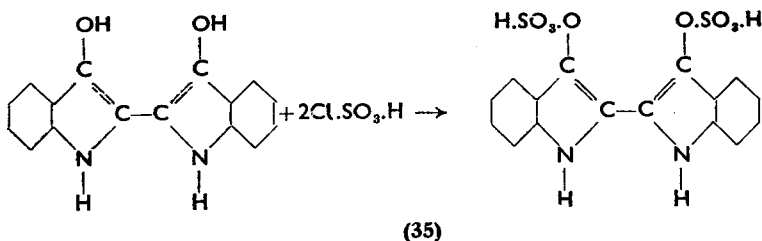

The compound (35) was converted into its sodium salt with the appropriate quantity of sodium hydroxide and this proved to be stable, soluble in water, substantive to cellulose, and capable of being oxidized, on the fibre, to Indigotin (Indigo Blue). The anthraquinone dyes react similarly, an example being solubilized Indanthrone, (36).

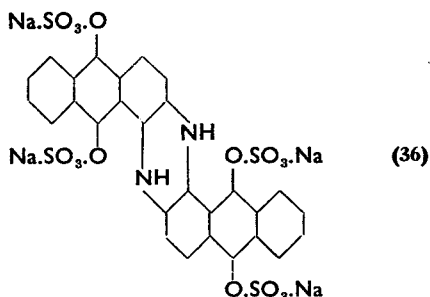

The original Bader and Sunder process was simplified considerably by the discovery of Morton Sundour Fabrics that the sulphuric ester can be formed as a metal complex by the action of fuming sulphuric acid, or an alkyl ester of chlorosulphonic acid, on the oxidized vat pigment in the presence of pyridine. The complex is finally converted into the sodium salt by the action of sodium hydroxide as shown in the series of reactions below:

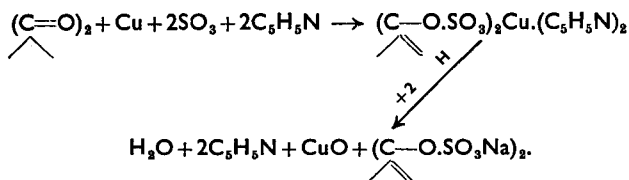

Zinc and iron can be substituted for copper as the metallic element.

The solubilized leuco compounds are known as the Indigosols. Another range called the Soledons is prepared mainly from anthraquinone vat dyes. Their application is comparatively simple. Cellulosic fibres are dyed in a neutral dye liquor and slightly acid baths are used for protein fibres. They exhaust well at 20° to 40°C (68° to 104°F), although there are some requiring temperatures ranging from 60° to 80°C (140° to 176°F). Their affinity for cellulose is not great and high percentages of electrolyte are often necessary, and for this reason they have only found favour in dyeing paler shades where colour cost is not so important.

The general method of application is to dissolve the dye in hot, but not boiling, water and add it to the dye liquor through a strainer, together with the required amount of electrolyte. The goods are entered and the temperature is raised to that at which maximum affinity is developed, which varies from one dye to another, as shown by the following table.

Table 20.4

Dye	C.I. number	Optimum temperature
Indigosol Green IB	SOLUBILIZED VAT GREEN 1	50–55°C (122–131°F)
Soledon Indigo LL	SOLUBILIZED VAT BLUE 1	20–30°C (68–86°F)
Soledon Brilliant Purple 2R	SOLUBILIZED VAT VIOLET 1	50–80°C (122–176°F)
Cibantine Brown BR	SOLUBILIZED VAT BROWN 1	60–70°C (140–158°F)

The goods are dyed at the appropriate temperature for a period of 30 minutes.

The stabilized leuco compounds are developed with a mild oxidizing agent, which may be potassium persulphate or acidified ferric chloride but which, in practice, is more commonly an acidified solution of sodium nitrite. The goods containing the leuco compound are hydroextracted and then transferred to a fresh liquor containing 2.5 to 5 lb per 100 gallons of sodium nitrite and 0.1 to 0.15 lb of sulphuric acid (168°Tw 93.5 per cent) per 100 gallons. The development takes 15 minutes at temperatures varying between 20° and 80°C (68° and 176°F), according to the specific requirement of the dye. As with the conventional vat dyes, the final treatment consists of soaping for 10 minutes at the boil in a solution containing 0.1 per cent of soap or other detergent and 0.1 per cent of sodium carbonate.

Solubilized vat dyes behave towards wool very much as if they were acid dyes. Thus the rate of exhaustion is increased by the addition of acid to the dyebath and they are fixed to the protein fibre by chemical bonds. They are, however, much more difficult to oxidize on protein than on cellulosic fibres. Soluble Vat Blues O and OR are dyed in fairly strongly acid liquors containing 2 to 4 per cent of formic acid, one per cent of sulphoxylate and 5 per cent of sodium sulphate. Most of the other soluble

vat dyes exhaust on wool in the presence of quite a small amount of acetic acid. The oxidation of the leuco esters is usually carried out in an acidified solution of sodium bichromate. Alternatively, in some cases, potassium persulphate can be made use of. Matching is not easy and, so far as goods made entirely of wool are concerned, the solubilized vat dyes find little application because equally good results can be obtained with premetallized dyes or others which present less difficulty in application.

Pigment padding

Many leuco compounds of vat dyes have a very strong affinity for cellulose and this can make it difficult to obtain uniform penetration in tightly constructed or packed goods, especially in yarn in package form. The insoluble pigment, however, has no affinity and if this can be distributed evenly and subsequently reduced and oxidized *in situ* the problem of penetration should be overcome.

The first method based on pigment padding was devised by Abbott and Cox (Cox, *J.S.D.C.*, 1946, **62**, 45; and RICHARDSON AND WILTSHIRE *J.S.D.C.*, 1947, **63**, 225). The dispersion of the pigment was temporarily held in suspension with a surface active agent and slowly precipitated by coagulation caused by the gradual addition of an electrolyte whilst the liquor was in circulation. When precipitation was complete the liquor was run off, the machine was refilled with water and the pigment was reduced with the appropriate quantities of hydrosulphite and alkali to the leuco compound which was taken up by the fibre at the site where the particle had settled. A specific example would be to pigment the wetted-out cheeses in a liquor containing the required amount of vat dye and 5 lb per 100 gallons of Dispersol VL. Pigmentation would be commenced at 30 to 35°C (86 to 95°F) and the temperature would be raised to 80 to 90°C (176 to 194°F) during a period of 30 minutes then, after ten minutes, sodium chloride or sulphate would be added, gradually, preferably in the form of a solution through a drip-feed until exhaustion was complete. The liquor was then run off and a reducing solution was allowed to circulate through the goods for 30 minutes after which the adsorbed leuco compound was oxidized with sodium percarbonate or perborate. A final treatment in boiling soap or detergent was necessary to remove superficially deposited pigment and to develop the colour.

The Abbott-Cox process relies upon exhausting the suspended pigment. In many cases exhaustion is difficult to control and irregularity in the shade can be the result. Vat dyes in their insoluble oxidized state are available in a super finely divided form which may be added to the dyebath and circulated through the goods on which they will be uniformly deposited without the use of an electrolyte to bring about coagulation. After a suitable period sodium hydroxide is added, followed by sodium hydrosulphite when the leuco compound becomes adsorbed on the fibre and is

then fixed by oxidation in the normal manner. As an example of the procedure which might be followed, the vat dye would be added to the dye-bath at 20°C (68°F) and circulated for a period of 20 minutes after which the necessary amount of sodium hydroxide would be entered and circulation continued for a further fifteen minutes. Sodium hydrosulphite would then be added and the temperature would be raised to 50°C (122°F) at the rate of one degree centigrade per minute and circulation would be continued for a further 40 minutes. By this time the leuco compound should be uniformly adsorbed by the material and rinsing, oxidation and soaping should follow.

The use of vat dyes in pigment form for cheeses and rayon cakes suggested improved techniques for various continuous and semi-continuous padding methods for the application of vat dyes to piece goods. Most vat dyes are now marketed in forms specially prepared to yield relatively stable dispersions of extremely finely-divided particles required for pigmentation. The earliest and simplest procedure was the so-called pigment-pad process illustrated diagrammatically in Fig. 20.3 (*Ciba review*, No. 120). In this case

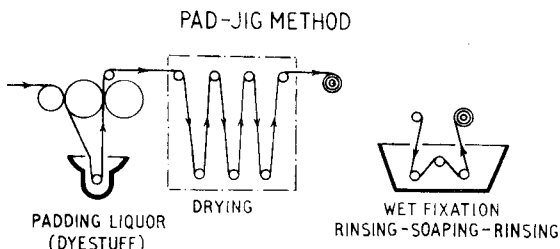

Fig. 20.3

the sequence is discontinuous because the cloth is first padded with a suspension of the vat dye in a finely-divided form and dried, and then transferred to a jig where the deposited pigment is reduced, soaped, and rinsed. Finally, after a further break in continuity, it is hydroextracted and dried.

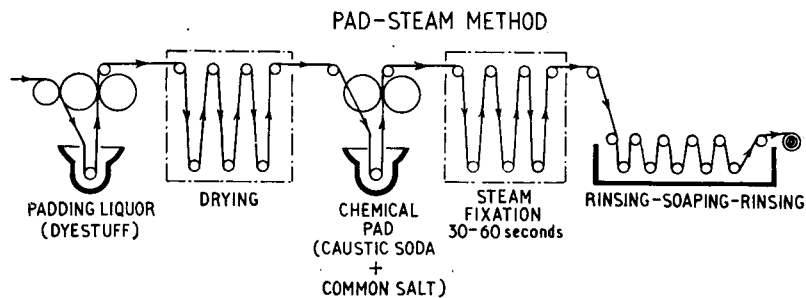

Fig. 20.4

A greater measure of continuity is achieved in the Pad-steam process in which the cloth is first pigment-padded, dried, padded with sodium hydroxide and hydrosulphite, passed through a steam chamber to reduce and fix the vat dye, and finally finished off in a soaping and rinsing range.

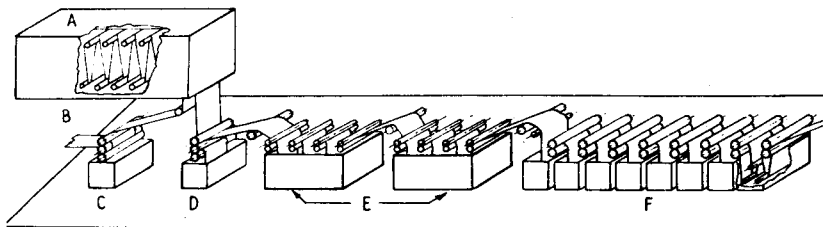

Fig. 20.5 Diagrammatic illustration of typical booster system

- A. Hot flue dryer
- B. Cloth in
- C. Pigment pad
- D. Reduction pad
- E. Booster boxes
- F. Washing, oxidizing and soaping range

(Courtesy of A.A.T.C.C.)

The sequence of operations is illustrated diagrammatically in Fig. 20.4 (*Ciba review*, No. 120). It is customary to add a small proportion of the vat dye to the liquor in the padding mangle containing the reducing agent to compensate for any tendency for the leuco compound to migrate.

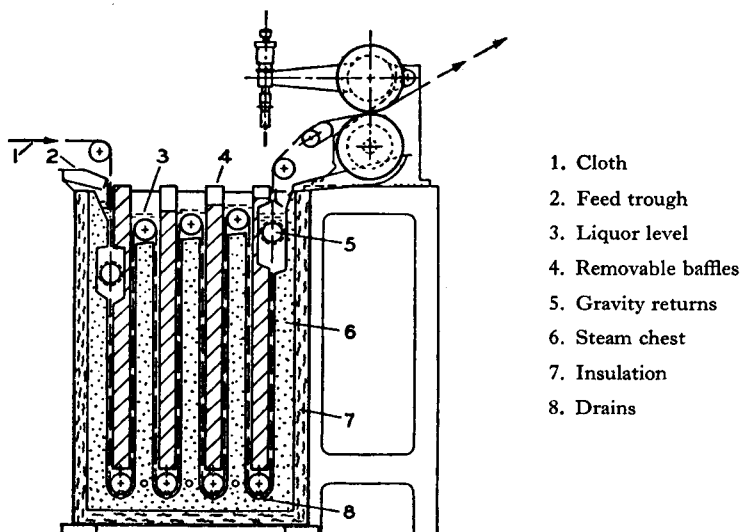

Fig. 20.6 Sketch of essential parts of Williams unit

(Williams unit A.A.T.C.C. Publication No. 2)

Booster boxes are sometimes used instead of the steam chamber. The sequence of operations up to steam fixation is the same, as shown in Fig. 20.4, but two booster boxes consisting of rectangular open becks with a series of rollers above and at the bottom of the liquor are substituted for the steaming chamber. These contain further quantities of vatted dye, to compensate for migration, and caustic soda and sodium hydrosulphite. The liquor is maintained at 75° to 100°C (167° to 212°F) and the reduction and fixation of the pigment is very rapid in the aqueous phase because temperatures are used which are very much higher than would be employed when dyeing with the leuco compounds by conventional methods.

The Williams unit has also been used successfully in the continuous application of vat dyes, for development after pigment padding. It is essentially a booster box with guide rollers at the bottom and also just below the surface of the liquor. The machine is filled with baffle-type steam chests, leaving only a narrow space through which the fabric passes, thereby reducing to a minimum the ratio of reducing solution to goods. The diagrammatic illustration in Fig. 20.6 shows the essential structure of a Williams unit.

The application of vat dyes with the Standfast Molten Metal machine is

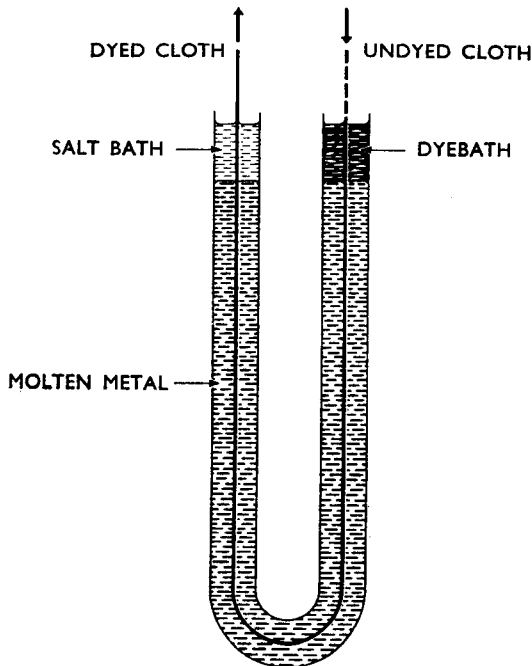

Fig. 20.7 Diagram of molten metal bath

(I.C.I. Publication)

described by Ardron, Fox, and Speke (*J.S.D.C.*, 1952, 68, 249). The plant is illustrated diagrammatically in Fig. 20.7. It consists essentially of a U-tube, through which the cloth passes in open width (Fig. 20.8), filled with a fusible alloy composed of 50 per cent bismuth, 26.7 per cent of lead, 13.3 per cent of tin and 10 per cent of cadmium having a melting point of 70°C (158°F). The U-tube is immersed in a bath containing boiling water so that its temperature is maintained in the region of 96°C (205°F). The molten alloy acts as a perfect squeezing mechanism to force the excess of padding liquor out of the fabric, and it also provides a heat reservoir to raise the temperature of the cloth to promote fixation.

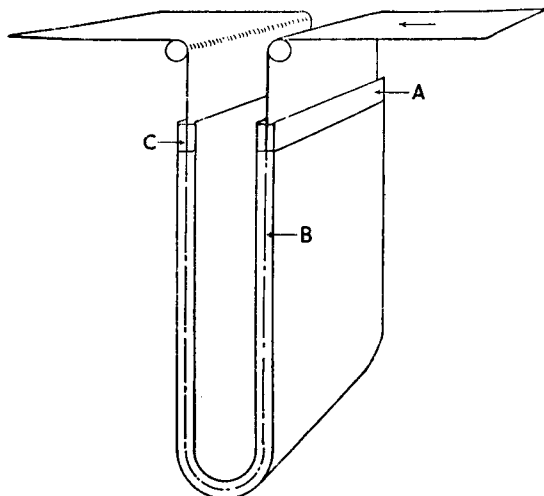
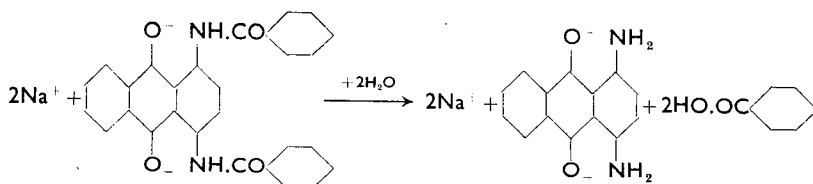

Fig. 20.8 Diagrammatic sketch of standfast molten-metal machine
(BOARDMAN, '*J.S.D.C.*' 1950)

The dye solution is fed in from a stock tank so that it rests on the top of the molten metal in the receiving limb of the U-tube at *A*. As the cloth passes through the metal (*B*) it is subjected to a pressure which leaves 140 per cent of its weight of retained liquor and the dye is fixed by the heat applied during the passage through the alloy. Provided the feed from the stock tank is adjusted to keep the liquor level constant, new dye solution is, of necessity, being supplied at the same rate at which it is being taken up. On emerging, the material passes through a solution containing salt at *C*, the main purpose of which is to prevent metal from being carried away. The dyed cloth is then oxidized and soaped in the usual way.

These continuous methods of dyeing have been described in this context because they find their greatest use in the application of vat dyes. One reason is that the adsorption of leuco compounds is very rapid at high temperatures and the associated tendency for unlevelness can be overcome by

pigment padding. These continuous methods, however, are used with direct dyes and, as will be referred to in a later chapter, also with the reactive colours. There are a few vat dyes which are not stable at high temperatures. Thus the leuco derivatives of vat dyes containing benzoylamino groups tend to hydrolyse under high-temperature reduction conditions, as shown below (Fox, M. R., *Hexagon digest*, No. 10).



Dehalogenation can also occur in those vat dyes with chlorine or bromine atoms in their molecules.

Knitted fabrics and lace cannot be dyed successfully in open width and must be treated in a winch. This is not an ideal machine because exposure to air and turbulence cause excessive oxidation of the leuco compound

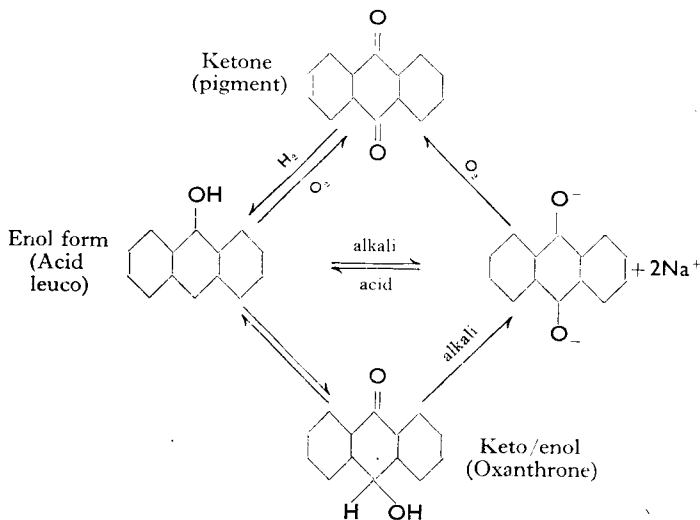

before it has been adsorbed. This causes an accumulation of insoluble pigment on the surface and rapid exhaustion of the hydrosulphite, fresh additions of which have to be made at intervals to maintain the reducing state of the liquor. The scum will not reduce so long as it floats, but the addition of a surface-tension reducing agent, such as Calsolene Oil HS, will cause it to sink. In a winch, much of the load lies stationary in folds during considerable periods and this is a cause of unlevelness with rapidly-exhausting

leuco compounds. It is avoided by the use of Dispersol VL or an equivalent restraining product and by adding the vatted stock solution, and any salt which may be required, very slowly.

Better penetration in the winch machine is sometimes obtained by an adaptation of the pigment-padding principle. A dispersion of the fine powder of the oxidized pigment is made with the aid of a suitable surface-active product. The material is allowed to run in this dispersion, using as short a liquor as possible, whilst the temperature is slowly raised to between 50° and 60°C (122° and 140°F) over a period of 30 minutes. The machine is then filled up to normal working level, caustic soda is added, and the necessary quantity of sodium hydrosulphite is sprinkled slowly over the surface of the dyebath. There are some single or combinations of vat dyes which, in spite of all precautions, will still give unlevel results. In such cases manual opening-up of the rotating rope as it emerges from the dye liquor may be of assistance. It is also desirable to increase the speed of the winch to its working maximum and to make the ropes as short as possible to reduce the static pause.

The vat-acid process has achieved a considerable measure of success and is based upon the use of a dispersion or suspension of the insoluble leuco compound instead of its sodium salt. The various reactions of an anthraquinone vat dye are shown on page 503 (SPEKE, *Hexagon digest*, No. 7). The acid leuco compound is probably a mixture of the enol and keto/enol forms but the more the equilibrium favours the oxanthrone form the greater is the stability towards oxidation. The leuco derivatives are prepared by precipitation from a solution of the sodium salt on acidification. In order, however, that they shall be thrown out of solution in a state suitable for the formation of a stable suspension it is necessary that a dispersing agent should be present before addition of the acid. The vat dyes with the leuco compounds which disperse most easily are:

C.I. VAT ORANGE 12
 C.I. VAT RED 10
 C.I. VAT BLUE 17
 C.I. VAT BLUE 18
 C.I. VAT BLUE 16
 C.I. VAT GREEN 6
 C.I. VAT GREEN 1
 C.I. VAT GREEN 2
 C.I. VAT BLACK 8

The material is impregnated with the vat-acid suspension and subsequently converted into the substantive soluble form by treatment with sodium hydroxide. The usual methods of oxidation and soap boiling are employed. The advantage of using acid leuco compounds is that their suspensions are much finer than those of pigments, therefore giving better

penetration but, on the other hand, only pale to medium shades can be dyed because there is a limit to the concentration of the aqueous dispersions.

Stripping vat dyes

It is not easy to remove the colour from vat-dyed materials. Reducing agents are of little assistance because the leuco compounds are reabsorbed as soon as they are formed. The restraining action of non-ionic surface-active compounds, such as Dispersol VL, may be made use of. An appreciable quantity of colour can be removed at a high temperature in a liquor containing sodium hydrosulphite, sodium hydroxide, and the dispersing agent, but the effectiveness will be governed by the sensitivity of the dye to such treatment. Lissolamine V used together with sodium hydroxide and sodium hydrosulphite at 85°C (185°F) is the most effective stripping agent (see Chapter 9).

21 · Disperse dyes and dyeing cellulose acetates

THE disperse dyes arose out of the endeavours of many workers to find an easy and commercially satisfactory way to dye cellulose acetate. Acetate was the first hydrophobic man-made fibre, and when it appeared on the market knowledge about the mechanism of dyeing and of molecular structure of fibres was limited. Because acetylation makes the fibre hydrophobic, resistant to swelling, and endows it with a greater electro-negative surface charge in water, there is no affinity for direct dyes. The absence of basic groups affords no sites of attachment for acid dyes, but the yarn does show some affinity for basic dyes. In the early days, limited ranges of water-soluble dyes, selected from a variety of sources by trial and error, were placed on the market under the names of Cellit Fast (I.G.), Cellutyl (BDC), Setacyl (Geigy), and Acetate dyes. In many cases both their fastness and exhaustion left much to be desired.

The next step was the saponification method in which an outer layer of the fibre was hydrolysed to cellulose with sodium hydroxide, creating an affinity for direct dyes. The process was soon abandoned because the results were uncertain and the effect on the properties of the rayon was not good.

It had been observed by many workers that cellulose acetate has a marked capacity for adsorbing water-insoluble organic substances from their aqueous suspensions. The behaviour resembled the partition of a solute between two immiscible solvents and the idea emerged that the solution to the problem would lie in finding some way of presenting water-insoluble dyes to the fibre. The first constructive contribution on these lines was made by Green and Saunders (*J.S.D.C.*, 1922, 38, 227), who introduced into coloured insoluble azo compounds methyl- ω -sulphonate, $-\text{CH}_2-\text{SO}_3\text{H}$, groups which hydrolysed slowly in the boiling dyebath, liberating the azo compound and forming formaldehyde bisulphite $\text{CH}_2(\text{OH})\text{SO}_3\text{Na}$. These dyes were called the Ionamines and Ionamine Red KA (1) is an example.

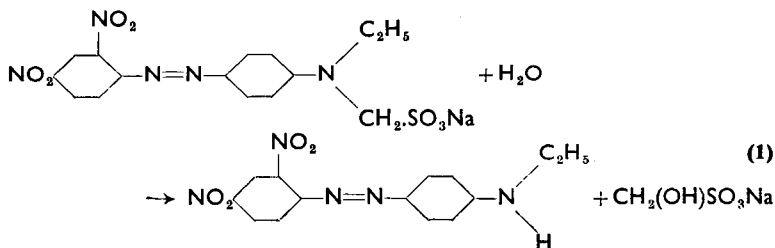

It hydrolysed with the liberation of ethyl aminodinitroazobenzene. In some cases, as in Ionamine Black AS, (2), the product of hydrolysis had a free amino group which could be diazotized and coupled on the fibre.



These dyes found some application but were very soon displaced by the SRA dyestuffs, the first example of water-insoluble pigments held in suspension in the dyebath. This conception was developed simultaneously by Holland Ellis (*J.S.D.C.*, 1924, **40**, 285), who dispersed azoic pigments, and Baddiley (*J.S.D.C.*, 1924, **40**, 190), who used various insoluble coloured amino derivatives of anthraquinone. The letters SRA represent an abbreviation of sulphuricinoic acid, which was the first dispersing agent, but was later displaced by similar products of synthetic origin. Since the application of these dyes was simple and the fastness satisfactory, their development was rapid and they appeared on the market under the names of Dispersols (I.C.I.), Cellitons (I.G.), Cibacets (Ciba), Setacyls (Geigy), and the Artisils (Sandoz). In the early days they were pastes, but they now appear in the form of powders prepared by milling the pigment with a dispersing agent and a little water, drying and adding a diluent such as Glauber's salt. The importance of the water-insoluble disperse dyes has increased to a very great extent with the appearance of the synthetic fibres, some of which, such as Terylene and the acrylonitriles, are much more hydrophobic than cellulose acetate and therefore very resistant to the conventional water-soluble dyes.

The pigments used in the preparation of disperse dyes are either azo compounds, such as shown in formulae (3) and (4), or anthraquinone derivatives of which formulae (5) and (6) are examples.

It was believed that the mechanism of the taking up of disperse dyes

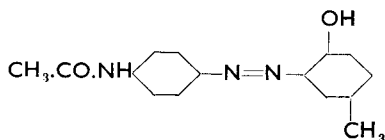

(3)

Dispersol Fast Yellow G
(C.I. DISPERSE YELLOW 3)

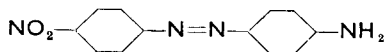

(4)

Cibacet Orange 2R
(C.I. DISPERSE ORANGE 3)

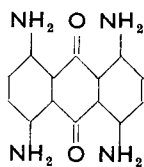

(5)

Duranol Brilliant Blue CB
(C.I. DISPERSE BLUE 1)

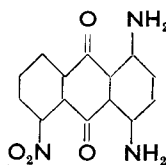

(6)

Duranol Brilliant Violet BR
(C.I. DISPERSE VIOLET 8)

by acetate resembled the partition of a solute between two immiscible solvents. The pigment, in other words, formed a solid solution in the fibre. Meyer, Schuster, and Bulow (*Melliand Textilber*, 1926, 7, 29) studied the partition ratio of *o*-nitroaniline between cellulose acetate and water and found that it was constant, indicating simple solution, and, by analogy, it was assumed that the behaviour of disperse dyes was similar. Vickerstaff and Waters (*J.S.D.C.*, 1942, 58, 116) concluded that this explanation was an over-simplification because the isotherm at 85°C (185°F) for distribution of the dye between acetate and aqueous suspension fitted the Langmuir and not the Nernst equation (see Chapter 12). They regarded the Langmuir equilibrium relationship as fortuitous, but considered that it excluded the possibility of simple partition between two solvents. The adsorption of disperse dyes by cellulose acetate has received very thorough attention

Table 21.1

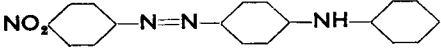
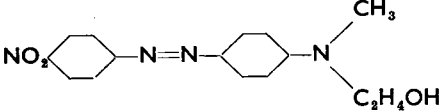
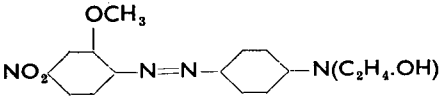
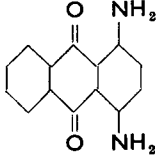
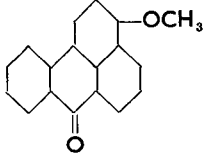
Compound	Aqueous solubility in mg/litre		Solubility in 1% Lissapol LS mg/litre
	25°C	80°C	
	0.1	0.5	41
	0.3	7	138
	7.1	240	970
	0.3	17	17
	<0.2	1.2	22

from Bird *et al.* (*J.S.D.C.*, 1954, 70, 68). Bird and Manchester (*J.S.D.C.*, 1955, 71, 604) discuss their observations on the adsorption isotherms at 80°C (176°F) for five disperse dyes and conclude that the curve was basically linear and the deviation was caused by decomposition of the dispersing agent with the liberation of sodium hydrogen sulphate, a substance capable of forming a salt with amino groups in the pigment.

The view which is now generally accepted is that the dye is transferred from the suspended aggregate to the fibre in molecular form. The pigments are soluble in water to an extremely slight extent but in that state are highly substantive. The undissolved aggregates in suspension serve as reservoirs to maintain a saturated solution. Bird (*J.S.D.C.*, 1954, 70, 68) tabulates a number of disperse dyes with their water solubilities at 25°C (77°F) and 80°C (176°F), and also the solubility at 25°C (77°F) in a 1 per cent solution of purified Lissapol LS (sodium oleyl-*p*-anisidide sulphonate). A few are quoted in Table 21.1.

Although there are exceptions, the times of half-dyeing and levelling at 85°C (185°F) are greater with the less soluble compounds. The effect of a surface-active assistant is to make the water phase more attractive and, therefore, to reduce the percentage exhaustion at equilibrium.

There is reason to believe that hydrogen bonding takes place between primary amino and acetyl groups and that Van der Waals forces also contribute to the retention of the dye

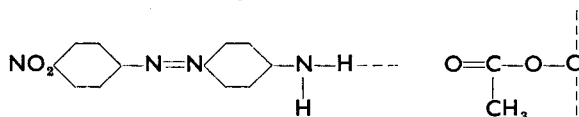

and it is possible that dipole interaction may also play a part.

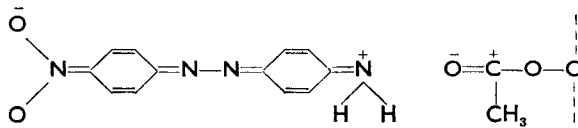

Application of disperse dyes

The dyes of this group must be brought into a state of fine suspension in the dyebath, but this does not present any particular difficulty. The dye is stirred with 10 to 20 times its weight of water at 50° to 60°C (122° to 140°F) and allowed to stand for 10 minutes, with occasional agitation. If the mixture is not sufficiently fluid for straining, more warm water may be added. It must be emphasized that boiling water should not be used nor should pasting be carried out in the presence of highly concentrated surface-active auxiliary products. Small lumps may be formed during pasting which do not disperse and filtration through a sieve before addition to the dyebath is most desirable.

Before addition of the dyestuff either 1 to 2½ lb of soap or approximately 1 to 1½ lb of a synthetic dispersing agent per 100 gallons should be put into the liquor. These products assist in maintaining a stable suspension and also increase the solubility of the pigment (BIRD, *J.S.D.C.*, 1954, 70, 68) in water, thus decreasing the affinity of the fibre and acting as a retarding agent.

When the dyebath is prepared the goods, which have been scoured previously, are entered cold and the temperature is raised slowly to between 70° and 85°C (158° and 185°F) and dyeing is continued at that temperature for 1 hour or until the shade is level. Disperse dyes differ greatly one from another in their rate of exhaustion and level-dyeing properties, and when using more than one in combination it is desirable to select those with dyeing properties as similar as possible. To help in selection the comparative rates of exhaustion and levelling powers of a few are given in Table 21.2.

Table 21.2

<i>Dye</i>	<i>C.I. number</i>	<i>Levelling</i>	<i>Rate of dyeing</i>	<i>Temperature range °C</i>
Dispersol Yellow 3G	DISPERSE YELLOW 4	Very good	Moderate	50–80
Celliton Fast Yellow RRA/CF	DISPERSE, YELLOW 1	Very good	Rapid	55–80
Dispersol Fast Orange B	DISPERSE ORANGE 13	Slow	Poor	75–85
Cibacet Orange 2R	DISPERSE ORANGE 3	Very good	Rapid	50–80
Artisil Direct Yellow G	DISPERSE YELLOW 3	Good	Moderate	50–80
Dispersol Fast Orange A	DISPERSE ORANGE 1	Moderate	Slow	60–85
Dispersol Fast Red R	DISPERSE RED 19	Very good	Moderate	65–85
Setacyl Scarlet B	DISPERSE RED 1	Good	Moderate	50–85
Cibacet Rubine R	DISPERSE RED 13	Good	Moderate	50–85
Artisil Brilliant Rose 5BP	DISPERSE RED 11	Good	Rapid	60–80
Duranol Violet RN	DISPERSE VIOLET 14	Good	Slow	70–85
Cibacet Blue BR	DISPERSE BLUE 14	Moderate	Moderate	70–85
Duranol Blue 2G	DISPERSE BLUE 24	Poor	Slow	75–85

Dyeing properties of disperse dyes

The Committee appointed by the Society of Dyers and Colourists reported that no sharp dividing lines exist which make it possible to group the disperse dyes into separate classifications according to their dyeing behaviour. It was therefore decided that a series of tests which would give reproducible and comparable results should be recommended

(*J.S.D.C.*, 1964, **80**, 237). The standard dyeing procedure is as follows. The dyebath is made up with distilled water together with 2 ml/l of Dispersol VL and sufficient of the dye to be tested to give the specified depth of shade on acetate satin dyed in a liquor ratio of 50 : 1.

Migration test

A 1 : 1 ISO standard depth dyeing is prepared at 80°C. Equal weights of this dyeing and similar undyed material are placed in a bath at 80°C (liquor ratio 50 : 1) and left immersed with agitation for one hour. The difference between the two pieces is then assessed with the S.D.C. Grey Scale (Change in Colour) and the classification is expressed as follows:

<i>Grey scale contrast</i>	<i>Assessment</i>	<i>Rating</i>
5	Excellent	A
4	Very good	B
3	Good	C
2	Moderate	D
1	Poor	E

Temperature range test

Dyeings of a 1 : 1 ISO standard depth shade are prepared according to the instructions given above, at 50, 60, 70, 80, and 90°C. The method of grading is tabulated below:

Contrast between 90 and 50°C not below	Grey Scale 4-5	Excellent	A
„ „ 90 and 60°C „ „ „ „	4-5	Very Good	B
„ „ 90 and 70°C „ „ „ „	4-5	Good	C
„ „ 90 and 80°C „ „ „ „	4-5	Moderate	D
„ „ 90 and 80°C lower than	„ „ 4-5	Poor	E

Rate-of-dyeing test

Dyeings to the ISO 1 : 1 standard depth are carried out at 80°C under the conditions already described, for periods of 5, 10, 20, 80, and 160 minutes. The rate-of-dyeing properties are assessed with the S.D.C. Grey Scale (Change of Colour).

Contrast between 160 and 5 min not below	Grey Scale 4-5	Very rapid	A
„ „ 160 and 10 min „ „ „ „	4-5	Rapid	B
„ „ 160 and 20 min „ „ „ „	4-5	Moderate	C
„ „ 160 and 80 min „ „ „ „	4-5	Slow	D
„ „ 160 and 80 min lower than	„ „ 4-5	Very slow	E

Build-up test

A dyeing of ISO 1 : 1 standard depth at 80°C is prepared under the dyebath conditions already described. Additional dyeings are then made with twice, four times, and eight times the amount of dye required to

produce the 1:1 standard depth. For assessment the comparisons are only made between the 1:1 and eight times dyeings; the differences in depth being determined by comparison with the S.D.C. Grey Scale for change of colour. Whilst the twice and four times standard depth dyeings are not used in the comparisons they are made because they can provide useful information to the practical dyer since they give an indication of whether the build-up is either steady or rapid. The method of expressing the result is as shown below:

<i>Grey scale contrast</i>	<i>Assessment</i>	<i>Rating</i>
1	Excellent	A
2	Very Good	B
3	Good	C
4	Moderate	D
5	Poor	E

A similar series of tests for the assessment of the dyeing properties of Disperse Dyes on cellulose triacetate has been published (*J.S.D.C.*, 1965, **81**, 209).

Blacks can be dyed with disperse colours, but it is expensive because exhaustion is not very good and the washing fastness is only 3 to 4. Better washing fastness (4 to 5) with 3.3 to 4 per cent of dye can be obtained with a dispersed amine capable of being diazotized and coupled. The acetate is first dyed in the manner described and then rinsed and treated for 20 to 30 minutes in a cold bath containing 1½ lb of sodium nitrite and 4½ lb of 32°Tw (31.45 per cent) hydrochloric acid per 100 gallons. During diazotization and until coupling has been completed, it is desirable to protect the material against exposure to direct sunlight.

After diazotization the goods are rinsed again and developed. Between 3 and 5 per cent of the weight of the acetate of β -hydroxynaphthoic acid is dissolved in boiling water and added to the dyebath. The liquor is adjusted to pH 4.5 to 5 with acetic acid and the goods are entered cold. The temperature is raised slowly to 60°C (140°F) and the machine is allowed to run for a further 30 minutes. When the process is complete a final scour for 15 minutes at 50°C (122°F) in a 0.2 per cent solution of soap, or the equivalent quantity of a synthetic detergent, is necessary to remove any insoluble product of coupling deposited on the surface of the fibres. It is most important that during development the correct pH should be maintained, also that the reaction should be allowed to proceed to completion, otherwise fastness will be inferior and the colour will be unstable.

Fastness of disperse dyes

The fastnesses to light and washing are, in general, quite good. As an illustration a few examples are quoted in Table 21.3.

Table 21.3

Dye	C.I. number	Fastnesses	
		Light (S.C.D.)	Wash (S.D.C. 3 alteration)
Dispersol Fast Yellow A	DISPERSE YELLOW 1	4-5	2
Cibacet Yellow 4GC	DISPERSE YELLOW 5	5	3-4
Artisil Direct Brown H	DISPERSE ORANGE 5	5	4
Duranol Red GN	DISPERSE RED 9	5	3
Cibacet Rubine R	DISPERSE RED 13	6	3
Setacyl Violet R	DISPERSE VIOLET 1	6	3-4
Artisil Direct Blue BRP	DISPERSE BLUE 14	5-6	4
Duranol Brilliant Blue CB	DISPERSE BLUE 1	3-4	4

Gas fading

Rowe and Chamberlain (*J.S.D.C.*, 1937, **53**, 268) state that it has been recognized for a number of years that cellulose acetate dyed with disperse dyes tends to lose or alter colour during storage or display, often under conditions when light fading is quite impossible. During more recent times it has been established that a similar phenomenon can occur with the hydrophobic synthetic man-made fibres. It was shown that exposure to the fumes of burnt coal-gas and also to the nitrous oxide evolved by the action of acids on sodium nitrite produced the same effect. It is now recognized that nitrous oxide produced when a gas flame burns, or by the interaction of atmospheric oxygen and nitrogen at a red-hot surface such as an electric element, is the cause of what is generally known as 'gas fading'.

Not all disperse dyes suffer from the defect and it is particularly apparent in blue pigments based on the anthraquinone structure. It was suggested by Rowe and Chamberlain (*loc. cit.*) that the effect was caused by diazotization of primary amino groups or conversion of secondary amines into nitroso compounds. The fastness to gas fading is improved by treating the material during or before dyeing with substances of the general formula $R^1R^2.N(CH_2)_n.N.R^1R^2$ (I.C.I., Brit. Pat., 558784) which have an affinity for the fibre and are preferentially attacked by nitrous oxide. The better solution to the problem has been the synthesis of dyes, particularly in the blue range, which are stable. It has been claimed that dyes of the type of formula (7) (DICKY *et al.*, *J.S.D.C.*, 1958, **74**, 123):

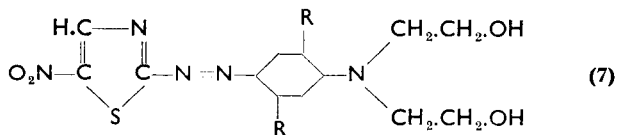

and Eastman Fast Blue GLF, (8) (OLPIN AND WOOD, *J.S.D.C.*, 1957, 73, 254), possess satisfactory fastness to the action of gas fumes.

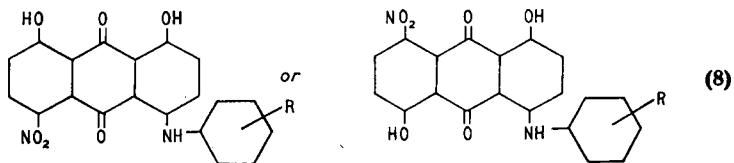

A test for resistance to burnt gas fumes has been described by the Society of Dyers and Colourists. A sample is exposed to nitrogen oxides in a closed container (see Fig. 21.1) until a control specimen dyed with Celanthrene

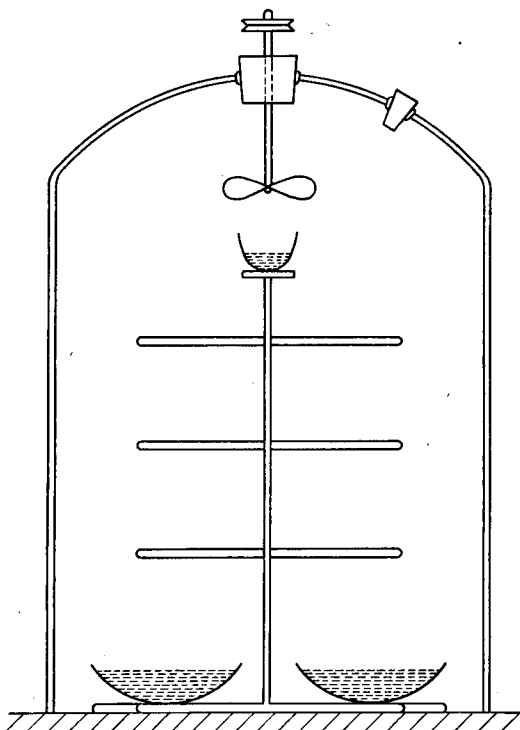
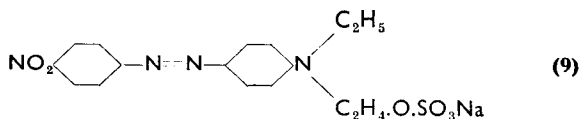

Fig. 21.1 Apparatus for testing fastness to burnt gas fumes
(Society of Dyers and Colourists fastness tests)

Brilliant Blue FFS (C.I. DISPERSE BLUE 3) has changed shade to a specified extent as assessed with a standard grey scale. The sample and control are placed on the arms of the apparatus and the unfilled spaces filled with undyed cellulose acetate fabric until the weight is 0.4 ± 0.05 g for each litre

of exposure chamber capacity. Two basins containing saturated sodium chloride solution are placed at the bottom of the chamber to maintain relative humidity at 75 per cent at $20^{\circ}\text{C} \pm 2^{\circ}\text{C}$ ($68^{\circ} \pm 3.6^{\circ}\text{F}$). Phosphoric acid and sodium nitrite are placed in the upper basin, the fan is caused to revolve and the apparatus is shielded from bright light. When the standard dyeing has faded the requisite amount the exposure to nitrous oxide is terminated. The end point is determined by packing a piece matching the standard, faded equal to grade 2, in a transparent sealed polythene bag, hanging it adjacent to the standard dyed with Celanthrene Brilliant Blue FFS and observing when the two are the same depth of colour. When the test is complete the exposed specimen and a portion of the original dyed material are plunged in a triethanolamine solution to stop further action and, after drying, the loss of colour if any is assessed by relating it with a standard grey scale.

When the disperse dyes were in their early state of development it was observed that compounds containing an external sulphato group, having the general formula $\text{R}'\text{NH.C}_2\text{H}_4.\text{O.SO}_3\text{Na}$, would dye cellulose acetate from an aqueous solution (B.D.C., PERKIN AND BATE, Brit. Pat. 237739). Little attention was paid to this at the time because it appeared that the disperse dyes would fulfil all requirements. In 1936 interest was revived and these dyes were placed on the market as the Solacet range by I.C.I. An example is Solacet Fast Scarlet B, formula (9), C.I. ACID RED 53.



The Solacet dyes differ from the Ionamines because they do not undergo decomposition with the gradual release of an insoluble pigment in the dyebath but dye directly from aqueous solution.

They have not very good levelling properties but they exhaust much more slowly than the disperse dyes. The initial adsorption, therefore, may be expected to be more level. The usual method of application is to enter the goods at 40°C (104°F) and raise the temperature gradually to 70° to 75°C (158° to 167°F), completing the exhaustion by the gradual addition of salt.

Dyeing acetate rayon with azoic dyes

It has been known for a long time that it is possible to dye acetate fibres with azoic dyes provided the right combinations are selected and suitable modifications in the method of application are made. Wallwork (*J.S.D.C.*, 1935, 51, 415) proposed a reversal of the normal procedure by impregnating with the base first, diazotizing, and then coupling with the β -hydroxynaphthoic acid derivative or, alternatively, impregnating with a mixture of the

naphthol and the base and then treating with sodium nitrite and hydrochloric acid.

The normal method of application for cellulosic fibres must be modified because the alkalinity of the solution of the azoic coupling component would saponify the fibre. It is also not practical to couple a fibre impregnated with a naphthol with the diazotized base because, in the conditions under which the operation is carried out, the fibre is unswollen and the molecules of the diazonium compound cannot enter.

The method described by Wallwork (*loc. cit.*) in which the base is applied first, followed by diazotization in the fibre, and coupling is used mainly for the production of black and dark navy blue shades. The base is made into a stable suspension by pasting with soap flakes and a little water, diluting with hot water and boiling for a few minutes. When the base is marketed as its hydrochloride, sufficient alkali must be added to liberate the free amine. The soap emulsion is added to the dyebath where it forms a suspension of adequate stability. The goods are entered, the temperature is raised to 70° to 75°C (158° to 167°F), and the adsorption is allowed to continue for 1 hour. The base is then diazotized in a cold liquor containing sodium nitrite and formic, acetic, or hydrochloric acid. The coupling component is applied from a separate liquor in the form of a suspension after pasting it with an equal weight of methanol, adding caustic soda (as a 20 per cent solution) equal to one-fifth of the weight of the naphthol derivative, and diluting with a little warm water. The mixture is added to the dyebath which already contains a dispersing agent such as Dispersol VL (1 g per litre). Sodium dihydrogen phosphate is then added till the pH is about 7.3, when the free coupling component is precipitated in a finely divided suspension from its soluble sodium salt. The material containing the diazotized base is entered and the temperature is raised to 65° to 70°C (149° to 158°F) and 90 minutes is allowed for the completion of the reaction. As is usual with azoic dyes, the final operation is a washing off to remove surface deposits of the pigment, but with acetate yarns the temperature must not exceed 80°C (176°F).

It is more customary to impregnate the fibre with the base and the coupling component simultaneously and then treat with nitrous acid, when diazotization and coupling take place *in situ*. As a general illustration, the procedure is as follows: the base is pasted with a dispersing agent and diluted with hot water at 60°C (140°F), and the coupling component pasted with a dispersing agent and one-third of its weight of caustic soda and hot water. The dye liquor is brought to 80°C (176°F) and the emulsified base and hydroxynaphthoic acid compound added. The goods are then entered and adsorption is allowed to continue for 90 minutes, after which they are washed well and developed cold, in a bath containing sodium nitrite and acetic acid, followed by rinsing and soaping at 80°C (176°F).

Many dyestuff manufacturers now market mixtures of bases and coupling

components suitable for acetates and some of the hydrophobic synthetic fibres. An example is the Brentacet range of dyes. When these are applied the requisite quantity of dye is mixed with an equal weight of methanol and of soap, one-half its weight of soda ash, and 40 times its weight of water, and the whole is boiled and then added to the dyebath. About 1 lb per 100 gallons of a dispersing agent is added, the goods entered and dyed for 1 hour at 85°C (185°F) with an addition, calculated on the weight of the goods, of 40 per cent of common salt. The load is then rinsed and coupled and diazotized simultaneously with sodium nitrite and hydrochloric or formic acid.

The suspended leuco compounds of vat dyes, precipitated from solutions of their sodium salts, have an affinity for cellulose acetate and they can be developed by oxidation. A few which are suitable are given by Mellor and Olpin (*J.S.D.C.*, 1947, 63, 397).

C.I. VAT VIOLET 18

C.I. VAT BLUE 5

C.I. VAT RED 47

C.I. VAT VIOLET 2

Courtaulds Ltd, Whittaker and Wilcock (Brit. Pat. 517751) recommended vatting with sodium hydroxide and hydrosulphite and then adding sufficient sodium bicarbonate to convert all the free caustic soda into sodium carbonate before dyeing. Vatting is easier with sodium hydroxide in the first place than with sodium carbonate.

Dyeing cellulose triacetate

In cellulose triacetate virtually all the hydroxyl groups in the cellulose have been acetylated and this makes the fibre more hydrophobic and, therefore, less receptive to dye molecules. Triacetate differs from secondary cellulose acetate in that it can be heat set, making it in this respect competitive with the true synthetic fibres. Steam setting is made difficult because triacetate extends slightly during the process, unlike the synthetic fibres which contract. This adds to the difficulty of fixing dimensions and may cause a ripple effect in the warp direction. For this reason dry-heat setting is preferred because it is not accompanied by extension. This may either be done in a stenter, or a Bates Type K machine (Fig. 21.2), in which the fabric is held against electrically heated rollers by means of endless blankets. The temperature which is required for a satisfactory set is between 190° and 250°C (374° to 482°F). Heat setting is preferably carried out before dyeing. X-ray diffraction diagrams show that setting increases the crystallinity of the fibre and therefore reduces accessibility.

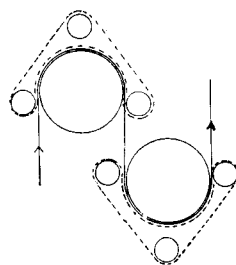

Fig. 21.2 Diagram of hot roller contact setting machine

The greatest quantity of cellulose triacetate is dyed with disperse dyes. They are only adsorbed very slowly at 80°C (176°F), the temperature recommended for secondary acetate, but at 100°C (212°F) the dye is taken up at a rate approximately equal to that which it would be with secondary acetate at 85°C (185°F). The general method of application is to paste the dye with 10 times its own weight of water and add the suspension, through a strainer, to a dyebath which has been raised to 60°C (140°F) and contains the equivalent of 1 to 2 lb per 100 gallons of a dispersing agent.

After the goods have been entered the dye liquor is raised to the boil and dyeing continued at this temperature for 60 to 90 minutes. When exhaustion is complete the load is rinsed and scoured at 50°C (122°F) to remove any surface-deposited colour. The dispersed dyes are classified according to affinity as follows by Mellor and Olpin (*J.S.D.C.*, 1955, 71, 819):

	<i>Good affinity at 90°C</i>	<i>Good affinity at 98°C</i>	<i>Moderate affinity at 98°C</i>
C.I. Disperse Yellow	3, 9, 13		
„ „ Orange	15		4
„ „ Red	7, 13, 15, 18, 22	5	35
„ „ Violet	1, 4, 6, 14		
„ „ Blue	3, 19	7, 24, 27	16

When those dyes are applied which are known to be liable to undergo gas fading, it is advisable to use an inhibitor such as Duranol Inhibitor N (4 per cent required) or Duranol Inhibitor GF (1 per cent required). Dispersed dyes tend to sublime and mark off, during ironing or pleating, on to adjacent material. Triacetate yarns, on account of their thermoplastic nature, are often used in materials where pleating will follow dyeing and, for such purposes, dyes with low volatility are recommended.

Cellulose triacetate can be dyed with safety at temperatures up to 130°C (266°F). Such high temperatures give improved wet-fastness because of the better penetration of the dye molecules into the fibre and assist significantly when dyeing heavy shades. Dyeing above 100°C (212°F) also increases the range of dyestuffs available, making it possible to use those with valuable properties but having rates of exhaustion at the boil too slow to allow them to be made use of in normal practice.

The azoic colours can be applied to tricol in a manner similar to that which has already been described for secondary acetate. Dispersol Black B,

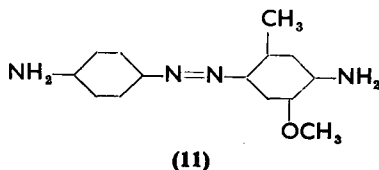
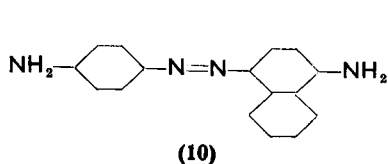

(10), and Cibacet Diazo Black B, (11), are bases which are diazotized and coupled with 3 : Hydroxy : 2 : naphtho-*o*-toluidide (Brenthol OT), (C.I. AZOIC COUPLING COMPONENT 18), (12):

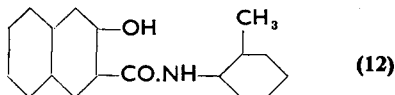

Dispersol Diazo Black B may be applied by a two-bath method or by a one-bath process with a carrier. In the two-bath application the liquor is brought to 60°C (140°F) and a dispersing agent is added, such as, for example, 1 lb per 100 gallons of Lissapol C. The requisite amount of dye is pasted and strained into the dyeing machine. The goods are entered and the temperature is brought to 100°C (212°F) and dyeing is continued at this temperature for 60 to 90 minutes, after which a cold rinse follows. A fresh liquor is made up with a dispersing agent, and a quantity of Brentosyn BB (β -hydroxynaphthoic acid) equal to half the weight of the dye, the temperature raised to 55° to 60°C (130° to 140°F), and adsorption allowed to proceed during 60 minutes. The colour is then developed in another fresh cold liquor with 4 per cent on the weight of the goods of sodium nitrite and 8 per cent of hydrochloric acid of 32°Tw (31.5 per cent). Rubbing fastness is improved by a final reduction clearing in a liquor containing 2 lb of soda ash, 2 lb of sodium hydrosulphite, and 2 lb of Lissolamine A (50 per cent) in 100 gallons for 15 minutes at 60°C (140°F), followed by soaping at 95° to 100°C (205° to 212°F).

An alternative and quicker method is to use diethyl phthalate as a carrier. The bath is made up with the requisite amount of Dispersol Diazo Black together with Brenthol OT, (12), and, after running the goods for 10 minutes, 6 to 10 per cent of diethyl phthalate is added and the temperature raised to 95° to 100°C (205° to 212°F) and dyeing continued for 1 hour. The goods are then rinsed, developed with sodium nitrite and hydrochloric acid and reduction cleared in the manner already described.

Pre-swelling of triacetate increases its affinity for disperse colours and makes it possible to dye the fibre as if it were secondary cellulose acetate. Acetic acid, acetone, and ethyl lactate have been used as swelling agents and one which has proved most successful is diethylene glycol diacetate (DEGDA) (OLPIN AND WOOD, *J.S.D.C.*, 1957, 73, 249). The material is pre-treated by cold padding with 60 per cent DEGDA and, after a short interval, rinsing. Alternatively, treatment with 30 per cent of the swelling agent at 60°C (140°F) for 2 minutes gives the same result.

22 · Reactive dyes

UNTIL quite recently all methods of dyeing cellulosic fibres so that they would have really good wet-fastness depended upon converting soluble substances into relatively insoluble compounds in the fibre, and the processes were always accompanied by a measure of difficulty in application. Direct dyes lack wet-fastness because the forces which retain them on the fibre are easily broken. For a long time chemists have been seeking a method of joining the dye molecule to the cellulose with a covalent bond.

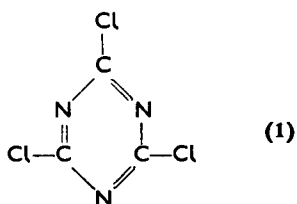

At about the end of the 1940 decade workers turned their attention to the properties of dyes containing cyanuric chloride (1) residues or, in other words, triazinyl dyes.

It is possible to make the chlorine atoms in cyanuric chloride combine with one, two, or three compounds containing hydroxyl or amino groups attached to coloured dye molecules. The reactions with water, alcohols, and amines are summarized below (COFFEY, *Chem. & Ind.*, 1960, 136).

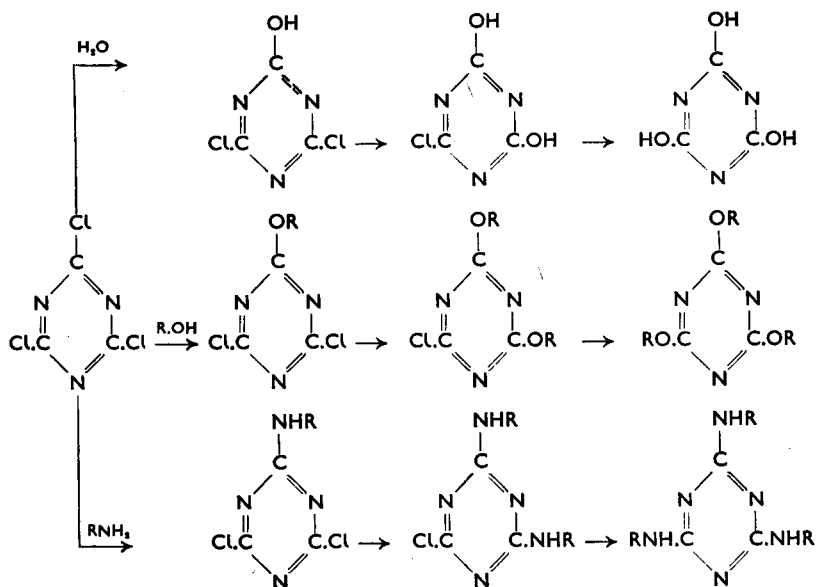

An outstandingly important property of the cyanuric chloride residue is that if one or two of the chlorine atoms are left unsubstituted they will react with the hydroxyl groups of cellulose. The reaction between a dichlorotriazinyl dye and cellulose, which takes place at 20°C (68°F), is illustrated diagrammatically below:

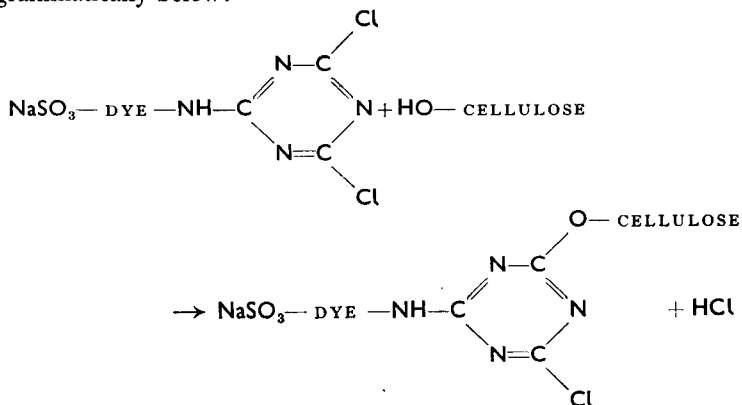

and this can go to a stage further, although it does not in all cases do so at 20°C (68°F), to link with two cellulose molecules, as in (2).

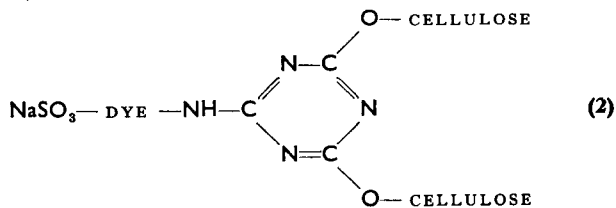

The triazinyl dyes can, at the same time, undergo hydrolysis with water to form the compound represented by (3):

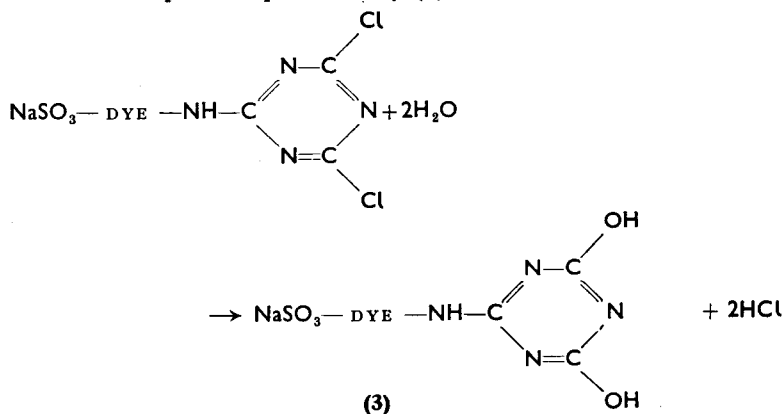

and this formation of the product of hydrolysis decreases the colour yield of the dye. Furthermore, compounds of the type of (3) are substantive towards cellulose. They do not possess good wet-fastness because no covalent bond has been formed and, unless removed, can detract from the excellent properties of the dichlorotriazinyl cellulose compound.

The first series of reactive dyes to make their appearance were the Procion colours of I.C.I. and these were all dichlorotriazinyl derivatives. A few examples are (4), (5), and (6) (COFFEY, *loc. cit.*):

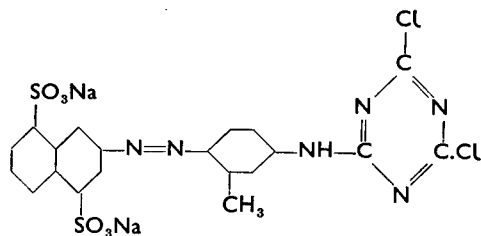

(4)

Procion Yellow

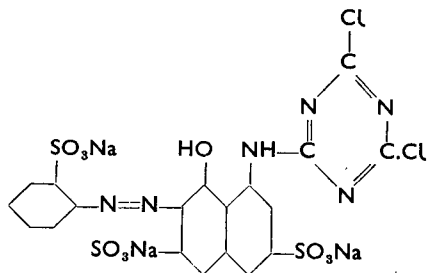

(5)

Procion Red

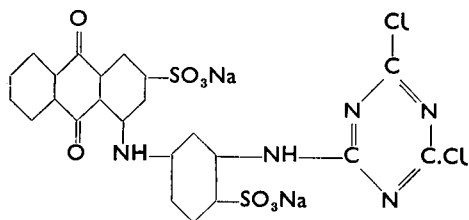

(6)

Procion Blue

The Procion dyes, on account of the sulphonic acid groups in their molecules, are readily soluble in water. In neutral solution they have substantivity towards cellulose similar to that of very low affinity direct dyes, a wet-fastness of a low order, and they exhaust better in the presence of

an electrolyte. The percentage exhaustion of some direct and Procion dyes in neutral liquors containing 5 and 30 per cent of added common salt at 20°C (68°F) and 60°C (140°F) are shown in Table 22.1 (VICKERSTAFF, *J.S.D.C.*, 1957, 73, 237). In the neutral solution physical adsorption and possibly some hydrogen bonding take place, but there is no formation of covalent bonds until alkali has been added.

Table 22.1 Percentage exhaustions of Procion and direct dyes on viscose in neutral solutions

Temperature	20°C		60°C	
	5	30	5	30
Common salt concentration g/litre	5	30	5	30
Chrysophenine GS	93	99	79	82
Chlorazol Sky Blue FFS	99	100	96	100
Procion Yellow RS	85	91	72	75
Procion Brilliant Red 2BS	23	30	9	10
Procion Blue 3GS	30	36	11	12

It must be admitted that the accuracy of the figures is open to question but, nevertheless, they do serve to indicate the general order of the affinities.

The fact that, after the addition of alkali, chemical union has taken place, is based upon the following facts (VICKERSTAFF, *loc. cit.*):

- (i) Before alkali treatment the colour can be washed out with repeated extractions with neutral water, but afterwards it is fast to boiling soap solution.
- (ii) The colour can be stripped from cellulosic materials dyed with direct, azoic, or vat dyes by boiling with pyridine, *o*-chlorophenol or chloroform, but this is not the case with Procion dyes fixed by the action of alkali. The conclusion, therefore, is that a binding force of a different nature has been formed.
- (iii) Polyvinyl alcohol may be regarded as similar to cellulose with regard to chemical activity. When aqueous solutions of polyvinyl alcohol containing, on the one hand, Procion dyes and, on the other, an anionic dyestuff, are poured on to the surface of a solution of sodium hydroxide saturated with salt, they react differently. When the Procion dye is present a film is formed which, although it swells slightly, can be boiled with water without disintegrating, but a film formed with an anionic dye under similar circumstances disintegrates rapidly and dissolves.
- (iv) Cellulose dyed with Procion dyes under certain conditions is insoluble in cuprammonium solution and thus differs from fibres dyed with direct dyes.

- (v) Procion Yellow R contains an azo group which can be severed by reduction, leaving two components with primary amino groups.

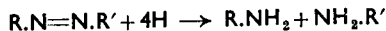

If cellulose dyed with Procion Yellow R be reduced, one-half of the molecule remains anchored to the fibre because it can be diazotized and coupled with phenol or an amine to produce a new dye and this operation can be repeated several times.

Concurrently with the fixation of the dye on the cellulose an undesirable reaction takes place between the chlorine atoms in the cyanuryl chloride groups and water, yielding either the mono or dihydroxy compound

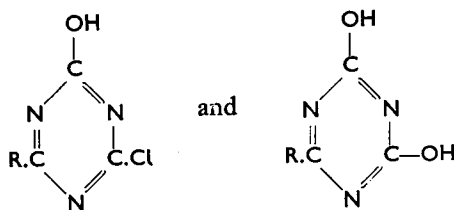

with bad effects, as has already been explained. Because of this hydrolysis, solutions of reactive dyes cannot be stored for any length of time without serious loss of potential colour value. As the temperature increases the rate of this hydrolysis becomes greater and for this reason, when dissolving the dyestuff and during its application in the dyebath, the temperature

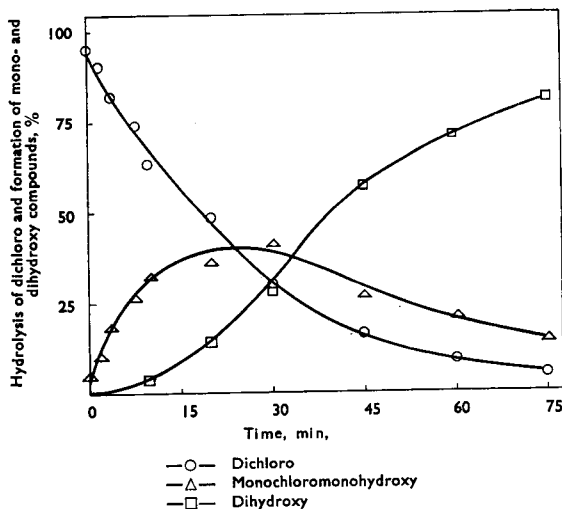

Fig. 22.1 Hydrolysis of Procion Yellow R (25 g. soda ash per litre at 60°C.)

should not rise above 40°C (104°F). Dawson, Fern, and Preston (*J.S.D.C.*, 1960, 76, 210) concluded that under dyeing conditions both the mono- and dihydroxy compounds were formed with a tendency for the formation of the latter to predominate as the time in alkaline solution increases. This is shown in the graphs (Fig. 22.1).

Cellulose contains both primary and secondary alcohol groups and it is not easy to determine which takes part in the reaction. Experiments were therefore carried out with *n*-propanol, a primary, and isopropanol, a secondary, alcohol. The rate of reaction with *n*-propanol is approximately seven times as fast as with isopropanol, and it is therefore reasonable to assume that with cellulose the union takes place preferentially with the primary alcoholic side chains. The comparative rates of reaction of Procion Red G in a 0.1N sodium hydroxide solution at 20°C (68°F) with various compounds containing hydroxyl groups is given in Table 22.2 (DAWSON *et al.*, *loc. cit.*).

Table 22.2

Compound	Relative rate of reaction
Water	1.0
Methyl alcohol	12.3
Ethyl alcohol	7.4
<i>n</i> -propanol	4.8
Isopropanol	0.7
Glucose	5.5
α -methyl glucoside	6.6

The interesting feature of the figures is that the rate of reaction with water is very much slower than with most of the organic compounds and, therefore, excessive hydrolysis will not have taken place before the dye has had time to combine with the cellulose. The behaviour towards α -methyl glucoside, where the reaction is seven times as fast as with water, is particularly interesting because a molecular structure related to that of cellulose is involved. The question of hydrolysis increases in importance as the dyeing conditions demand longer liquors and dyeing cycles.

Consideration of molecular structures suggests that a dichlorotriazinyl compound should be able to cross-link between adjacent cellulose molecules. It has not been possible to isolate a degradation product with two glucose residues united to one Procion dye which would provide conclusive proof of cross-linking. There is, however, indirect supporting evidence because fibres dyed at higher temperatures and greater alkalinity than normal, conditions known to favour cross-linking, cause significant reduction in swelling in cuprammonium. The photomicrographs in

Fig. 22.2 show an unswollen fibre and fibres dyed under conditions which should cause slight and appreciable cross-linking, mounted in water or cuprammonium solution.

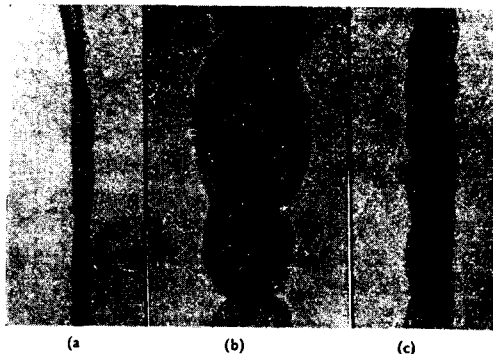

Fig. 22.2

- (a) Dyed fibre in water
 (b) Partially cross-linked fibre in cuprammonium solution
 (c) Heavily cross-linked fibre in cuprammonium solution

(DAWSON, *et al.*, 'J.S.D.C.' 1960)

Application of dichlorotriazinyl reactive dyes

Winch dyeing of cotton goods is quoted (I.C.I. Technical Information Notes) only for the purpose of illustrating the general principles of application.

The dyestuffs are dissolved by making them into a paste with cold water, followed by dilution with more water, the temperature of which must not exceed 50°C (122°F). A stock solution will not remain stable for more than about 4 hours, after which it will begin to lose strength due to hydrolysis.

The goods are loaded into the machine and 30 to 60 parts per 1000 of common salt are added, the quantity varying according to the depth of the shade. The liquor is then raised to the required temperature, either 40 or 60°C and the predissolved dye is run in. If sodium bicarbonate is used it is also added at this stage. The machine is then allowed to run for 20 to 30 minutes and the necessary amount of soda ash is introduced over a period of 10 to 30 minutes. Dyeing is continued for a further 20 to 40 minutes after which the goods are rinsed to remove the salt and the alkali, and they are then washed off at the boil for 15 to 30 minutes to extract any of the products of hydrolysis of the reactive dye. The quantities of common salt, soda ash and sodium bicarbonate required are tabulated opposite.

It must be emphasized that these instructions only apply to winch dyeing of cotton, and the dyestuff maker's technical information must be consulted for other materials or machines.

<i>Depth of shade</i>	<i>Alkali</i> <i>40°C</i> <i>(105°F)</i>		<i>Alkali</i> <i>60°C</i> <i>(140°F)</i>		<i>Salt</i>
	<i>Soda ash</i>		<i>Soda ash</i>	<i>Sodium bicarbonate</i>	
Up to 0.5 per cent	3 parts per 1000		1.5 g/l	1.5 g/l	30 g/l
0.5 to 2 per cent	4 " " "		2 " "	2 " "	40 " "
2 to 4 per cent	7 " " "		3.5 " "	3.5 " "	50 " "
over 4 per cent	10 " " "		5 " "	5 " "	60 " "

The sodium bicarbonate method is preferred for heavy shades and for materials which present penetration difficulties because with most dyes it gives better levelness and exhaustion.

Shades can be corrected by additions of predissolved reactive dyes to the alkaline liquor, but it is desirable that those with comparatively low substantivity should be selected, such as:

Procion Brilliant Yellow M-4G	Procion Red M-G
Procion Yellow M-4R	Procion Blue M-3G
Procion Red Brown M-4R	Procion Brilliant Blue M-R

When it is necessary to shade with reactive dyes of high substantivity it is desirable to run half of the liquor off and refill with cold water and then add the shading colour. When the additions are large the temperature should be raised again.

Considerable importance must be attached to the final washing-off of goods dyed with Procion colours. The exhaustion is often not good and much dyestuff will be in the retained liquor, but of greater significance is the fact that cellulose has some affinity for the hydrolysed dye which, having lost its chlorine atoms, has not entered into chemical combination. The load is first rinsed thoroughly in as great a volume of cold water as the machine permits. If sodium hydroxide has been used for fixation it is advisable to add sodium bicarbonate to the rinsing water. The goods should then be rinsed in hot water nearly at the boil, after which they are scoured at the boil for 15 to 30 minutes with a synthetic detergent or soap and finally rinsed, first in hot and then in cold water.

The application of a reactive dye falls into two distinct phases. During the first 30 minutes it is adsorbed by the fibre by a mechanism similar to that of the direct dyes, resulting in exhaustion varying from 25 to 90 per cent, according to the nature of the dye. With the majority of the cold-dyeing reactive dyes it is of the order of 40 to 60 per cent. During this stage no fixation has taken place and the dyestuff molecules can achieve uniform distribution in the cellulosic fibres because they are free to migrate. Since the hydrolysis of the dye by water is more rapid at higher pH values it is desirable that as much as possible should have entered the fibre whilst

the liquor is neutral. A typical dyeing curve is shown in Fig. 22.3 (FOWLER AND PRESTON, *J.S.D.C.*, 1958, 74, 373), in which the rates of exhaustion

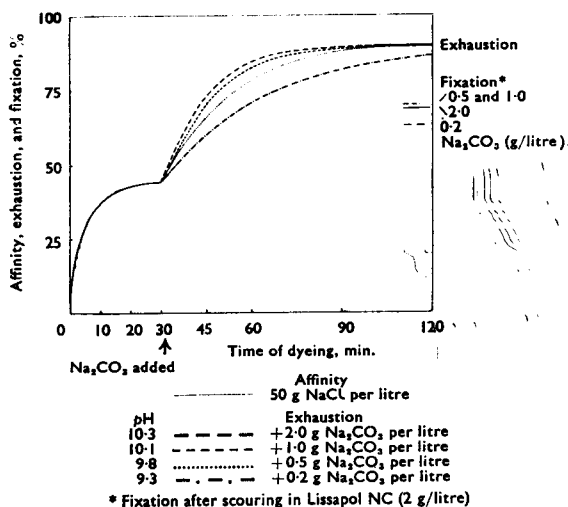
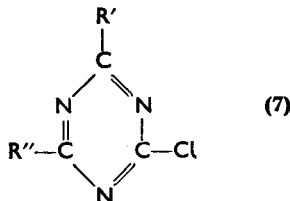

Fig. 22.3 Effect of concentration of sodium carbonate (1.5% Procione Blue M-R on viscose rayon in a 30 : 1 liquor at 20°C)

at different pH values during the second stage are recorded. The point indicating fixation represents the chemically combined dye only and the total exhaustion after 120 minutes includes the loosely held product of hydrolysis.

The instability of the solutions of the cold-dyeing Procione colours was a serious disadvantage in their application to textile printing. The stock solution for printing must be kept and used for several hours. The monochlorotriazinyl dyes of the general structure of formula (7) are less reactive.



Their aqueous solutions, therefore, are more stable but they do not react with cellulose so readily and the temperature of dyeing must be increased to 60° to 70°C (149° to 158°F) and, in some cases, as high as 90° to 95°C (194° to 203°F). There are ranges of monochlorotriazinyl dyes such as the

Procion H series (I.C.I.) and the Cibacrons (Ciba). Triazinyl dyes containing one chlorine atom have been in use as direct dyes for many years and some are described by Fierz-David and Matter (*J.S.D.C.*, 1937, 53, 424), such as Chlorantine Fast Blue 8G, (8), and Chlorantine Fast

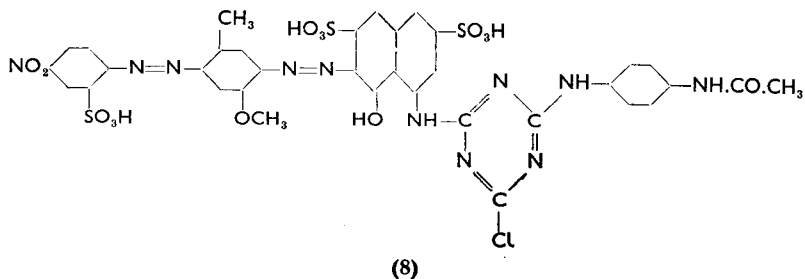

Green 10GL. It was not, at that time, realized that these dyes are potentially capable of forming covalent bonds with the cellulose. Many of the monochlorotriazinyl dyes have poor substantivity which makes them somewhat costly for all but pale shades when long liquors are essential, as is the case with winch machines. Considerable quantities of common salt are often needed, adding significantly to the cost. Regenerated rayons which are not highly orientated have a greater affinity and can be batch dyed with some dyes which are not satisfactory for cotton.

A recommended method for dyeing would be to dissolve sufficient common salt in the dyeing machine to give a concentration of 40 to 80 parts per 1000 according to the depth of the shade, the goods already having been entered. The temperature is brought up to 40°C (105°F) and the machine is run for five to ten minutes in order that the fabric can be uniformly impregnated. The predissolved dye is then added in two portions at five minute intervals followed by the alkali which should be 1 part per 1000 of caustic soda flakes or 20 parts per 1000 of soda ash. The alkali should be added in two portions at five minute intervals and the temperature then raised to between 60 and 90°C (140 to 194°F) according to that which is recommended for the dye in question. A period of 20 to 40 minutes should be allowed to bring the temperature up and dyeing should then be continued for 15 to 30 minutes when sodium hydroxide is the alkali and 30 to 60 minutes when soda ash is used. After dyeing, the materials must be rinsed and soap boiled to remove hydrolysed and unfixed dye.

It must be borne in mind that with soda ash the fixation of the dye is slower, but on the other hand shading colours may be added with greater safety to the hot dyebath. When difficulty in penetration is experienced

improved results can be obtained by gradual addition of the electrolyte to the liquor already containing the dyestuff and also by retarding the rate at which the temperature is raised.

Heterocyclic halogen-containing groups other than dichlorotriazinyl and chlorotriazinyl have been used in the preparation of reactive dyes. The Reactone and Drimarine colours are substitution products of tetrachloropyrimidine, (9), and therefore contain a trichloropyrimidyl group in the molecule, (10). An example of such a dyestuff is Reactone Red 2B, (11).

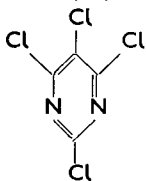

(9)

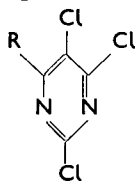

(10)

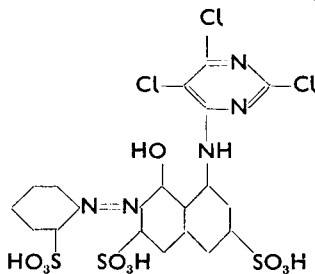

(11)

The method of application is basically similar to the chlorotriazinyl dyes. The dyebath is made up with 50 to 100 g per litre of common salt and fixation is brought about by the addition of 30 to 40 g per litre of soda ash, 20 to 30 g per litre of trisodium phosphate or 1.5 to 7 ml of sodium hydroxide (66°Tw 23 per cent). The temperature necessary for fixation varies from 80°C (176°F) to 90°C (198°F) according to the dye and the method of application. When these dyes are applied in a winch or a package machine the dye, salt, and alkali can all be added at the commencement because there is little danger of the reactive group becoming hydrolysed before it has reacted with the cellulose. The trichloropyrimidyl dyes do not exhaust easily and padding methods are therefore preferable.

Reactive dyes with poor affinity

There are a few reactive dyes requiring variations from the normal method of application. Some, such as those quoted below, have such poor affinity that with long liquor ratios they cannot be exhausted satisfactorily without greatly increased additions of salt.

Procion Brilliant Yellow M-6G
 Procion Brilliant Yellow H-5G
 Procion Orange Brown H-G
 Procion Scarlet H-R
 Cibacron Brilliant Blue C4GP
 Cibacron Black RP

With Procion Brilliant Blue H-5G and H-7G, and also Cibacron Turquoise Blue G, all of which are phthalocyanine derivatives, the temperature of

the dye liquor, after the alkali has been added, is taken up to 85° to 95°C (185° to 203°F). It is also found advisable to use a mixture of sodium hydroxide and sodium carbonate for fixation.

Fastness of reactive dyes

The light- and wash-fastness of reactive dyes, as shown in Table 22.3, is extremely good.

The washing test in Table 22.3 consisted of one treatment at 85°C (185°F) for 30 minutes in a solution containing 5 g per litre of soap. It will be observed that fastness to hypochlorite bleaching is in many cases poor, and this renders reactive dyes unsuitable for effect threads in materials which are to be bleached or rendered unshrinkable with chlorine during a subsequent process. A phenomenon associated particularly with red colours, such as Procion Red 2B, Procion Red 8B, Procion Brilliant Red 5B, Procion Rubin R, and Procion Brilliant Orange G, is that known as acid hydrolysis. When stored under humid and slightly acid conditions some of the fixed dyestuff can become detached from the cellulose and 'marks off' on adjacent goods. The loose dye washes out easily, and causes

Table 22.3

	<i>Fastnesses</i>		
	<i>Light</i>	<i>Washing</i>	<i>Hypochlorite bleaching</i>
Procion Yellow M-6G	6-7	5	1
Procion Yellow M-GR	6	5	4-5
Procion Yellow M-4R	5	5	1
Procion Scarlet M-G	4	4	2
Procion Brilliant Blue M-R	6-7	4	1
Procion Brilliant Orange H-GR	4-5	4	1
Procion Brilliant Blue H-5G	5-6	5	3

no trouble with garments which are laundered frequently because it is removed as soon as it is formed. The effect is less marked on viscose rayon goods, and on cotton which has been resin finished.

Ethylene diamine can reduce acid hydrolysis. The diamine can be added to the soap or detergent liquor used for the final scour at the boil and the quantity recommended is one part per thousand parts of water. Another product which fulfils the same purpose is Triamine PR (I.C.I.) which is used in the proportion of 0.5 to 1.5 parts per thousand of water. It must be borne in mind, however, that any continuous processes which include a steaming operation will not respond to after-treatment with amines. This after-treatment can cause a slight, but not very significant reduction in light-fastness.

When washing off to remove unfixed and hydrolysed dye is thorough, after-treatment with a cationic fixing agent is not necessary. Such treatment is, however, desirable when circumstances prevent the final scour from being as thorough as might be desired, and also with medium to full shades where the very highest fastness to water and perspiration are demanded. The cationic fixing agent will gradually be removed after several washings, but this is immaterial because any loose colour will come away at the same time. The dyeing is, however, safeguarded against marking off during storage or under conditions where frequent launderings do not take place.

It has been found that many of the reactive dyes have not the highest degree of fastness to natural weathering. When exposed over prolonged periods to the atmosphere they fade more rapidly than normal laboratory fastness tests would predict. Procion Yellow H-A, Procion Yellow M-6G, Procion Yellow M-R, and Procion Yellow H-5G are all deemed to be of borderline fastness to weathering. They are, nevertheless, in many cases superior to vat dyes because they do not induce accelerated oxidation of the cellulose on exposure to light. The deeper the shade the less apparent is the alteration due to weathering.

Because of their low affinity during the neutral adsorption stage, and the ease with which really fast dyeings are obtained in the subsequent alkali fixation, the reactive dyes have proved eminently suitable for continuous dyeing processes.

From the mechanical aspect the simplest are the semi-continuous methods. The goods are padded with a solution containing the reactive dye, a penetrating agent, and a weight of sodium bicarbonate sufficient to give a concentration equal to the dyestuff. The cloth is batched in a roll as it emerges from the padding mangle and stored for up to 24 hours, after which it is washed off. Covering the rolls with polythene sheets during storage is advantageous. The sequence of operations is represented diagrammatically in Fig. 22.4.

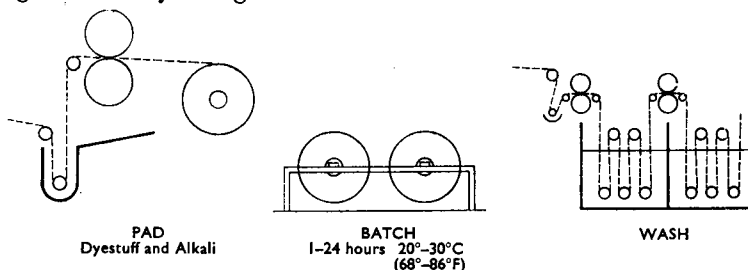

Fig. 22.4 Pad (alkali)—Batch (cold)

(I.C.I. Publication)

The Svetema Pad-Roll Dyeing Machine (*J.S.D.C.*, 1955, 71, 894) is a refinement in which the roll is stored in an enclosed chamber where it

rotates gently to prevent drainage of the padding liquor. The material can be cold during the dwell period when dichlorotriazinyl dyes are used or, by preheating the fabric, it can be hot for the reactive dyes containing one active chlorine atom (see Fig. 22.5). When batching, cold sodium

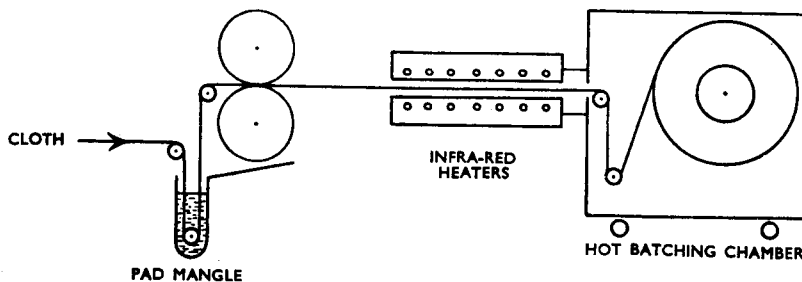

Fig. 22.5

(I.C.I. Publication)

bicarbonate is added to the dye to promote fixation. The advantage of this is that it gives a comparatively stable dye solution which is important when, during long runs, the padding mangle must be fed from a stock tank. More rapid fixation is obtained with stronger alkalis, such as soda ash, trisodium phosphate, sodium metasilicate, or sodium hydroxide, but the dye, in solution, is correspondingly less stable.

A great variety of fully continuous processes have been developed for the application of reactive dyes. Most of them depend upon padding with a solution containing the dye and sodium bicarbonate; a reasonably stable system. At some subsequent stage when heat is applied the bicarbonate loses carbon dioxide, becoming converted into the more alkaline sodium carbonate, bringing about rapid fixation. A very simple fully continuous method consists of padding, drying by the application of heat accompanied by fixation, and washing off (see Fig. 22.6).

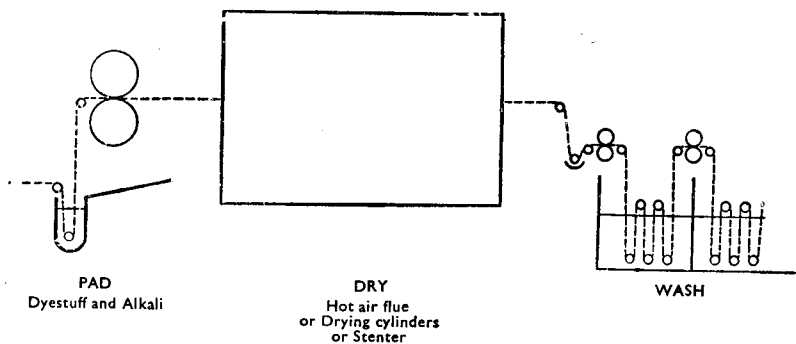

Fig. 22.6 Pad (bicarbonate)—Dry—Wash

(I.C.I. Publication)

The efficiency of the method, however, decreases as shades become deeper. According to Fowler and Preston (*J.S.D.C.*, 1958, 74, 379) a significant improvement in colour yield can be obtained by the addition of 150 to 200 g per litre of urea to the padding liquor. The effect is more apparent with cotton than with viscose. The following dyes respond well:

Procion Brilliant Yellow M-6G Procion Brilliant Red M-5B
 Procion Yellow M-R Procion Brilliant Blue M-R

With Procion Brilliant Red M-2B, Procion Blue M-3G, and Procion Rubine M-B there is less relative difference because they yield quite heavy dyeings in the absence of urea.

The addition of urea is expensive and, as an alternative, fixation can be enhanced by passing the goods through a steaming chamber for 5 to 15 seconds after dyeing and before washing off. The temperature in the chamber should not be less than 100°C (212°F).

The double padding method makes it possible to work with a very stable stock solution of the dye containing no alkali whatsoever. The cloth is first padded with the dye solution and then dried, after which it is impregnated with alkali and salt. It then passes into a steaming chamber where the dyestuff is fixed, and finally washed off. The sequence of operations is illustrated diagrammatically in Fig. 22.7. There are other permutations of the sequence of events in continuous ranges but, with the exception

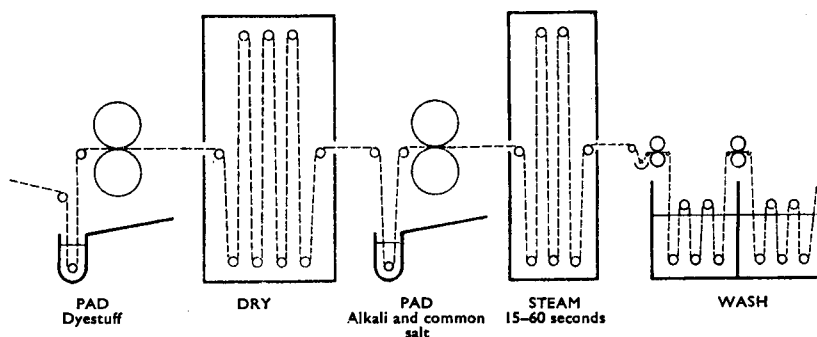

Fig. 22.7 Pad—Pad (caustic soda)—Steam (wet-on-dry)

(I.C.I. Publication)

of the introduction of a molten metal bath, the examples which have been chosen illustrate the principles involved. The molten metal bath (Fig. 22.8) is well adapted for continuous dyeing with reactive dyestuffs. The sequence is padding with dye solution, passing through a solution of sodium meta-silicate and salt resting on the surface of the metal in the entry limb of the U-tube, applying heat whilst immersed in the molten metal, and finally rinsing with water when the cloth emerges from the exit limb.

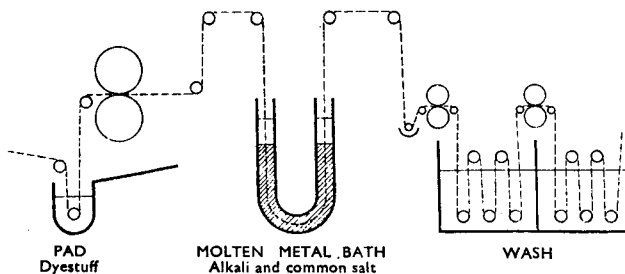

Fig. 22.8

(I.C.I. Publication)

Anomalous fluidities with reactive dyes

Frost and Duveen (*J.S.D.C.*, 1968, **84**, 304) showed that certain reactive dyes gave rise to high fluidities with no corresponding deterioration of tensile strength. Thus, for example, towelling dyed with 2.5 per cent of Procion Scarlet M-G had a fluidity of 22.6 and when dyed with 4 per cent of Procion Yellow M-GR, 15.61. These two examples are chosen from many results recorded. The phenomenon only occurs with the dichlorotriazinyl dyes and it was suggested that under certain conditions cross-linking occurs rendering aggregates of cellulose molecules insoluble in the cuprammonium hydroxide, thus decreasing the concentration of those which have passed into solution. These high fluidities are in no way associated with degradation of the cellulose.

Stripping reactive dyes

When dealing with cold-dyeing dyes, if partial stripping is desired this can usually be achieved with dilute acetic or formic acid. The recommended concentration is between 5 and 10 parts of glacial acetic acid, or 2.5 to 10 parts of formic acid (85 per cent), per 1000 parts of water. The goods are entered and the temperature is raised to between 70° and 100°C (158° and 212°F) and treatment continued until the shade has been reduced by the desired amount. Thorough washing is then necessary to remove the products of hydrolysis. If complete stripping of any reactive dye is required the goods are first treated with sodium hydrosulphite at the boil, then washed off and bleached at ordinary atmospheric temperature in a liquor containing 1 gallon per 100 of commercial sodium hypochlorite.

Dyeing silk

The reactive dyes give colours of exceptionally good wet-fastness on natural silk and their application is comparatively simple. When using the cold method with dichlorotriazinyl colours the dyebath is made up with the dissolved dye and 10 lb of common salt or anhydrous Glauber's salt

per 100 gallons. The goods are entered and run cold for 20 minutes, after which a further 10 to 20 lb per 100 gallons of salt are added in stages. The temperature is then gradually raised to 50°C (122°F) and dyeing is continued for a further 15 minutes. The fixation is then brought about by the addition of 2 lb of anhydrous sodium carbonate per 100 gallons and continuing to run in this alkaline liquor at 50°C (122°F) for 40 minutes. Shading, if necessary, can be effected by additions to the alkaline liquor, allowing a period of 15 minutes for exhaustion. Finally, as with cellulosic fibres, a wash-off with soap or a synthetic detergent at 85° to 95°C (185° to 203°F) is necessary.

Reactive dyes can be applied to silk from an acid dyebath. The liquor is prepared with the dissolved dye and 0.5 per cent of the weight of the goods of formic acid 85 per cent. The temperature is raised to 40°C (104°F) and the goods are entered. The dyebath is then slowly brought up to 85°C (185°F), when a further addition of 3.5 per cent of formic acid 85 per cent is made in portions, at intervals, during a period of 30 minutes. After all the acid has been added dyeing is continued for another $\frac{1}{2}$ hour after which the liquor is run away, the load is rinsed, and finally washed off.

The reactive dyes containing only one active chlorine atom are not applied from acid dyebaths and when dyed neutral require temperatures between 70° and 90°C (158° and 194°F) for adsorption and fixation. Their building-up powers, however, are not good and they are rarely used for silk.

Polyamide fibres can be dyed with both cold- and hot-dyeing reactive colours in a liquor containing 4 per cent of the weight of the goods of acetic acid 80 per cent. The load is entered at 40°C (104°F) and the temperature brought up to 95°C (203°F), after which dyeing is continued for 1 hour, or more, if necessary. The reactive dyes are satisfactory on staple yarns where differences in the affinity of the polyamide fibre are randomized. In continuous filaments any irregularities in the yarn are not covered.

Application of reactive dyes to wool

The reactive dyes contain sulphonic acid groups and they therefore behave as anionic dyes under acidic conditions. When the salt linkages have been formed further reaction between the chlorine atoms in the cyanuric acid group and amino groups in the wool leads to the formation of covalent bonds with the result that the dye molecule is extremely firmly attached to the fibre. Satisfactory results, however, are not obtained by the application of the cold dyeing technique with the dichlorotriazinyl dyes because, when the scale structure remains intact, penetration is too slow at low temperatures unless assisted by an organic solvent, which adds significantly to the expense. When, however, the scale structure has been damaged, as for example by chlorination, penetration of the dye becomes

much easier. In natural wool, weathering causes some localized scale damage, particularly in the tip portions of the fleece, and it is in these regions that dyeing will take place preferentially, giving a skittery or mottled result.

At higher temperatures, near the boiling point, penetration is satisfactory. Adsorption, as has been explained, precedes fixation by covalent bonds. In most cases this calls for comparatively low pH values. Below pH5, however, there is a significant increase in the rate of hydrolysis of the dye with the result that the proportion which becomes fixed on the fibre decreases.

The rate of fixation of the monochlorotriazinyl dyes is very much slower. The result is that there is abundant opportunity for the normal acid dyeing mechanism to give uniform distribution of the dye molecules before they become permanently anchored by covalent bond formation. It has been found that, for some unknown reason, cationic surface active compounds tend to reduce skitteriness, if a non-ionic compound is also present to prevent the precipitation of the cation-dye complex. In order to prevent foaming which can become troublesome the addition of a silicone anti-foaming product has been recommended.

The method of application is to make up the dyebath at 40°C (104°F) with ammonium acetate to give a pH of 7 for pale shades, and with ammonium acetate and acetic acid to yield a pH of 5.5 for heavy shades. The material is run in the liquor for fifteen minutes, after which the pH is tested and adjusted if necessary. Running of the machine is then continued for another fifteen minutes in order that uniformity of pH can be achieved. After this the cationic and non-ionic assistants are added and, after an interval of five minutes, the temperature is raised to the boil, at which it is maintained for one hour.

The reactive dyes give very bright shades on wool with light-fastnesses of the order of 5 to 7 and wash-fastnesses (ISO mechanical wash A) of 4 to 5.

The Remazol linkage

In 1949 the Farbwerke Hoechst A.G. took out patents covering the preparation of reactive dyes having the general formulae of (12) and (13) (see BOHNERT, *J.S.D.C.*, 1959, 75, 581):

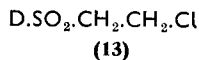
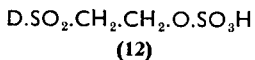

and if D, the dye molecule, contains one or more solubilizing groups, the product is a Remazol dye. When a solution of one of these dyes is made alkaline the following reaction takes place:

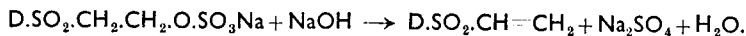

The compound $D.SO_2.CH=CH_2$ is a vinyl sulphone and the presence of the $-SO_2-$ group causes a strong polarity to appear in the vinyl radical



This activated double bond reacts with the hydroxyl group in water alcohols, and cellulose.

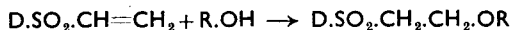

The reactivity of the dyes appears to lie somewhere between the di- and monochlorotriazinyl colours.

The recommended method of application is to allow initial adsorption to take place at 60°C (140°F) and then make the dye liquor alkaline with sodium hydroxide and soda ash or trisodium phosphate. Exhaustion is assisted by the addition of sufficient common salt to bring the concentration to 50 g per litre. The recommended quantities are tabulated overleaf [Hoechst A.G.].

There is a side reaction leading to the formation of a hydroxyethyl sulphone which always takes place to a greater or less extent during dyeing.

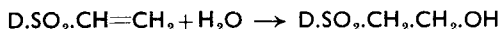

Increase in temperature favours the formation of the hydrolysis product, as does an excessively high pH. The dye-fibre linkage can be split by the action of alkalis at high temperatures. This means that there will be loss of depth if laundered at the boil in alkaline wash liquors, or should the goods subsequently be scoured with strong alkalis when Remazol dyes are used for effect threads.

Evidence confirming the formation of a chemical bond with the fibre is based upon the fact that when cellulose dyed with a Remazol dyestuff containing an azo group is reduced with hydrosulphite, there is an attached residue capable of being diazotized and recoupled. The original dye can be reformed if the coupling component is the same as that which was removed when the azo group was severed with the reducing agent.

Wool can be dyed with Remazol dyes in the following way (BOHNERT, *loc. cit.*). The dye liquor is made up with the dyestuff, 5 per cent of anhydrous Glauber's salt, and 4 per cent of sulphuric acid (96 per cent). The goods are entered at 40°C (104°F) and the temperature is raised to 60°C (140°F), over a period of 30 minutes, at which temperature it is maintained for 10 minutes before raising to the boil and dyeing continues at the boil for 1 hour. Polyamide fibres can be dyed in a similar manner and a strongly acid liquor is recommended for acrylonitriles.

The dye liquor is made up with the chemicals, including the sodium hydroxide. When applied at 60°C the temperature should be raised over a period of 20–30 minutes and dyeing continued for 60 minutes. At 40°C the bath is raised to this temperature during a period of 10 minutes and dyeing

Dyeing temperature 60°C (dyeing period 60 min)

Liquor ratio	1:3 to 1:5	1:8 to 1:12	1:15 to 1:30
Auxiliary based on polyphosphate, g/l	1	1	1
Sodium sulphate Duisburg 'R' or common salt, g/l	50	50	50
Trisodium phosphate cryst., g/l	20-25	10-15	5-10
or caustic soda solution 32.5 per cent (72°Tw), cc/l	2-3	1-2	1
and soda ash, g/l	5	5	5

Dyeing temperature 40°C (dyeing period 90 min)

Liquor ratio	1:3 to 1:5	1:8 to 1:12	1:15 to 1:30
Auxiliary based on polyphosphate, g/l	1	1	1
Sodium sulphate Duisburg 'R' or common salt, g/l	50	50	50
Trisodium phosphate cryst., g/l	30	15-20	10-15
or caustic soda solution 32.5 per cent (72°Tw), cc/l	3-4	2-3	1-2
and soda ash, g/l	5	5	5

Dyeing temperature 20-30°C (dyeing period 120 min)

Liquor ratio	1:3 to 1:5	1:8 to 1:12	1:15 to 1:30
Auxiliary based on polyphosphate, g/l	1	1	1
Sodium sulphate Duisburg 'R' or common salt, g/l	50	50	50
Caustic soda solution 32.5 per cent (72°Tw), cc/l	5-10	3-5	2-4
and soda ash, g/l	5	5	5

continued for 90 minutes. At 20 to 30°C no interval is necessary in bringing to the specified temperature but a period of two hours is required for the completion of the dyeing. After dyeing, the goods should be rinsed in cold water containing some acetic acid, then in hot water, and should finally be scoured for 5 to 10 minutes at the boil with a detergent, followed by one hot and one cold rinse.

The Procion-Resin process

A recent development is based upon the capacity of reactive dyes to combine with resin precondensates during curing conditions. The advantage is that with those fabrics which are normally resin-finished the conventional dyeing operation is eliminated. The fastness of the colour, in this case, is not governed by the cellulose covalent bond but by the permanence of the polymer finish.

Most of the commercial precondensates are suitable for the process, which is based on impregnation with the following padding mixture (*I.C.I. Dyehouse Publication No. 546*).

Reactive dye resin precondensate	100 parts per 1000
Procion-Resin Catalyst A	(according to nature of precondensate and dye)
Velan NW	10 parts per 1000
Perminal PP	3-5 parts per 1000
Common salt	3-5 parts per 1000

The Velan NW fulfils the function of a lubricant, to reduce loss of tear strength, and the Perminal PP is a wetting agent and also, together with the salt, reduces migration during drying. Curing for 3 minutes at 150° to 160°C (302° to 320°F) is satisfactory in most cases but some variation from this may be necessary for heavier cloths. The colours, on average, have wash-fastnesses to S.D.C. No. 4 test ranging from 3 to 4 or better and light-fastnesses of the order of 4 to 6.

Primazine dyes

These contain the acrylamide residue $D.NH.CO.CH_2:CH_2$ as the reactive component, D representing the chromophore-containing portion of the dye molecule. In the presence of alkali the reaction between a cellulosic hydroxyl group and the terminal CH_2 is similar to that which has been described for the Remazol dyes

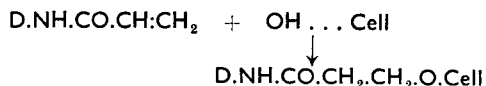

Their fastness to light is of the order of 5 or better (1/1 Standard Depth) and 4-5 when subjected to the ISO No. 4 washing test, with the exception of the turquoise shade which is 3 to 4.

Levafix dyes

In this case the reactive group is $-SO_2.NH.CH_2.CH_2.O.SO_3H$ and they are, in fact, alkyl esters of mineral acids. The reactive group is combined

with a chromophore-containing molecule which must have no sulphonic acid radical. These dyes react with the hydroxyl group of cellulose to form a very stable ether linkage:

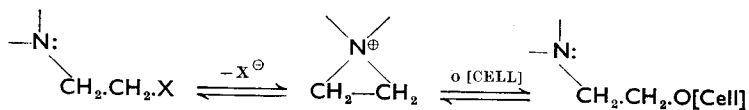

It is possible to prepare a dyestuff molecule containing two or even more reactive groups so that several bonds may be formed with the cellulose, giving very high wet fastness.

The method of application is to make the dyebath up with the requisite amount of dyestuff and then enter the material. After an interval of ten minutes the required quantity of salt is added in several portions. Thirty minutes after the salt addition has been completed the specified quantity of alkali is added in two to three portions. For shades of up to 2 per cent 50 g/l of calcined Glauber's salt and 15 g/l of soda ash are used. The dyeing temperature is 40°C (104°F) and dyeing is continued for one hour after the last addition of soda ash. When dyeing 2 to 4 per cent shades the quantity of Glauber's salt is unaltered but the soda ash is increased to 20 g/l and the dyeing temperature is raised to 50°C (122°F) and the time required is the same. Finally, for shades of over 4 per cent the conditions are the same as for 2 to 4 per cent but the dyeing is continued for 1½ hours after the last addition of soda ash. When dyed the goods should be rinsed in cold, followed by hot water and then scoured at the boil.

Fixation by polyfunctional cross-linking agents (LÜTZEL, *J.S.D.C.*, 1966, 82, 293)

All the reactive dyes which enter into combination with the cellulosic hydroxyl group are also, to a greater or less extent, hydrolysed by the hydroxyl ions in the dyebath, derived from the alkali. This leads to diminution in the colour yield. Experiments were therefore made to find a polyfunctional cross-linking agent which would form a bridge between the cellulose and the dye, thereby anchoring the latter to the fibre. Such a mechanism would mean that any dyestuff containing a reactive group could be united by cross-linkage and furthermore whatever hydrolysis did take place would be confined to the comparatively cheap cross-linking molecule instead of the expensive dyestuff.

As an example, cross linking would be obtained with:

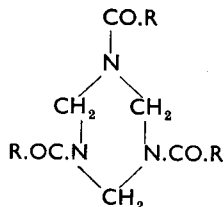

in which R may be



The mechanism of the reaction between the dye and the fibre would be as follows:

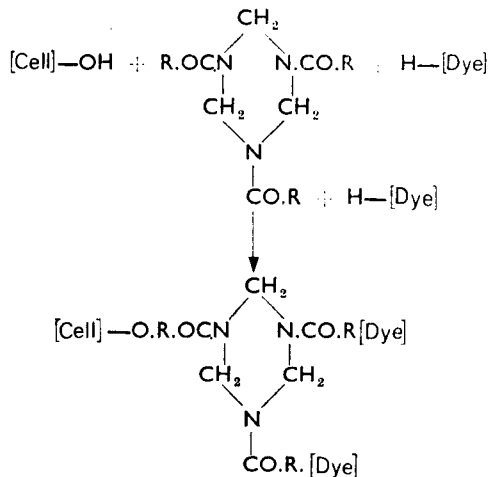

The Basazol dyes are based on this principle and they make use of a polyfunctional cross-linking agent known as Fixing Agent P, the exact constitution of which has not been revealed.

Procilan dyes

These are a range of reactive dyes giving exceptional wet fastness on wool. They are basically 1 : 2 metal complexes but they also contain groups capable of forming chemical bonds with the fibre. They behave like other acid dyes in that the rate of exhaustion is greater at higher temperatures and lower pH values. Once they have been adsorbed by the fibre the extent of the formation of chemical bonds will be governed by pH , temperature and time of dyeing. Increasing the temperature, the time of dyeing, and the value of the pH all increase the rate of reaction.

In order to achieve the maximum degree of fixation it is desirable to dye at as high a pH as is compatible with avoiding degradation of the fibre. The best results are obtained by dyeing at pH 6 to 6.5, which is adjusted by the use of ammonium sulphate together with sufficient acetic acid to counteract the alkalinity of the wool. As with the 1 : 2 metal complex dyes level dyeing is best achieved by a slow and uniform rise of temperature. The addition of Procilan Salt L as a levelling agent is recommended. It delays the adsorption of the dye until the temperature has reached approximately 70°C (160°F) so that it is most important to exercise control over

the range between 70 and 100°C. In common with all premetallized dyes there is an absence of bright shades from the range of colours. A certain amount of brightening, however, can be obtained by the addition of selected fast acid dyes to the dyebath. In order to obtain a degree of fixation which will give fastness suitable for most purposes a boiling period of at least one hour is necessary, but for extremely searching wet fastness requirements a period of two hours is recommended. Alternatively, the wool may be boiled for one hour at pH 6 to 6.5 and ammonia may then be added to bring the pH up to 8 to 8.5 when further boiling for only 15 to 30 minutes would be necessary. Procilan dyes are particularly useful for producing colours of very high wet fastness on wool which has received an unshrinkable treatment because it is well known that most of the ordinary acid dyes suffer a reduction in wet fastness when applied to unshrinkable wool.

A few typical examples of light and washing fastnesses are tabulated below.

<i>Dye</i>	<i>Light fastness</i>	<i>Washing fastness</i>	
	<i>1/1 standard</i>	<i>ISO 2</i>	<i>ISO 3</i>
Procilan Grey BRS	6	4-5	4-5
Procilan Red GS	5-6	5	4-5
Procilan Yellow 2RS	7+	5	4-5
Procilan Dark Blue RS	6-7	4-5	4-5

Procinyl dyes

These are reactive dyes specially designed for the dyeing of polyamide fibres. They are disperse dyes to which have been attached a group containing a labile chlorine atom capable of reacting with the amino groups in the polyamides. Their application will be described in the next chapter.

23 · Dyeing synthetic fibres

HISTORICALLY the first commercially successful synthetic fibre was Nylon 66. At the time when it appeared on the market its dyeing presented many difficulties. The fibre is hydrophobic and, therefore, not very attractive to water-soluble dyes. In the early stages of manufacture the polymer was liable to vary from batch to batch, both in physical properties and with regard to the number of amino end groups. This caused variations in affinity for dyes producing 'barry' effects, unless great care was taken to keep each batch separate.

Since the fibre was hydrophobic the obvious approach was to use the water-insoluble disperse dyes, for which nylon proved to have an adequate affinity. Of all the classes of dye, they are the best for covering up yarn variations. In pale shades the wet-fastness is satisfactory. Not only, however, is it difficult to build up heavy shades, but also their wash-fastness leaves much to be desired.

To obtain better fastness attempts were made to dye nylon with water-soluble dyes. In some ways the structure of the superpolyamides resembles protein fibres in that it possesses a limited number of primary and many secondary amino groups. Theoretical considerations would suggest that there should be an affinity for acid dyes, a prediction which is, in fact, fulfilled in practice. Nylon will take up acid dyes but has a much lower combining capacity than the protein fibres. The shades have better wet-fastness than the disperse dyes, but variations of a chemical nature in the yarn are shown up with greater emphasis. The acid mordant and the premetallized dyestuffs will dye heavy shades of good fastness but are, as a rule, even worse than the acid dyes with regard to covering up yarn irregularities.

The choice, until recently, has been between a disperse dye with wet-fastness which is not all that could be desired, accompanied by coverage of yarn variations, and faster colours which show up differences in physical and chemical properties of the polymer. When, in 1959, I.C.I. placed the Procynyl dyes on the market an advance of considerable importance was made. They are reactive dyes based on disperse dyestuff molecules containing chlorotriazinyl groups. Under neutral conditions the pattern of behaviour is that of a disperse dye and yarn irregularities are covered up to a great extent. When alkali is added to the dyebath, fixation takes place, giving wet-fastness of a high order.

Preparation of nylon for dyeing

Polyamides are thermoplastic, which means that permanent dimensions or shapes can be imposed upon garments or materials by the action of heat. The stage at which setting is applied varies according to the type of garment and the sequence of processes. It was at one time thought that setting of garments must precede dyeing, otherwise the boiling liquor would impose creases which could not be removed. With regard to stockings, socks, or garments, the setting before dyeing is referred to as pre-boarding. There has, however, during recent years, been a marked tendency to change to setting after dyeing, referred to as post-boarding, partly due to the fact that almost all goods are now made out of textured nylon which has already had some form of heat treatment.

In the case of pre-boarding, the most convenient time for the operation

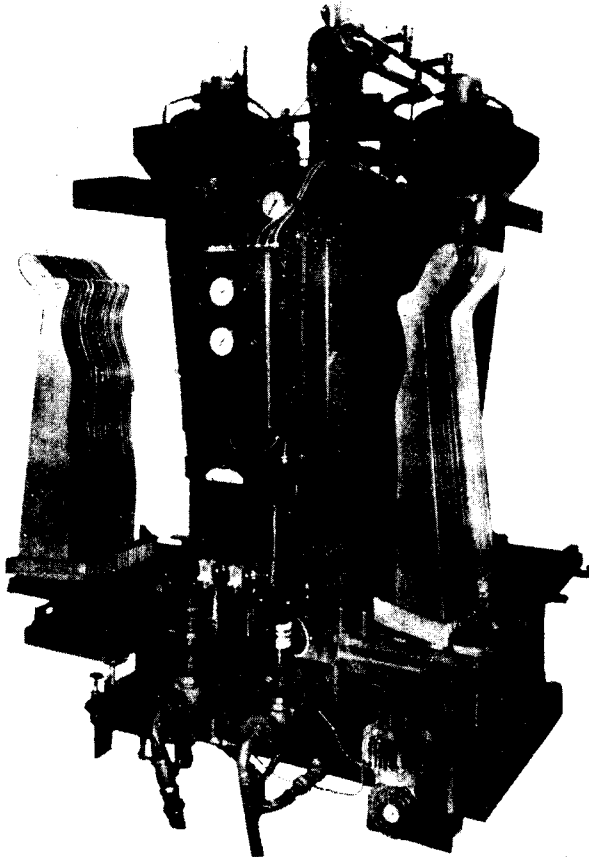

Fig. 23.1 Girland machine for pre-boarding or post-boarding

(Courtesy of Andrew Engineering and Development Co.)

is before scouring. This, however, involves one disadvantage because oil or stains associated with oil penetrate into the fibre under the influence of heat and can then become extremely difficult to remove. If goods are to be bleached or dyed in pale shades there is much in favour of scouring first and then pre-boarding, in spite of the fact that it involves one extra hydro-extraction and drying. It has become an increasingly common practice, particularly with socks, to post-board, or to use the term in current use, to heat-set after dyeing.

Pre-boarding and post-boarding are carried out in autoclaves or vessels

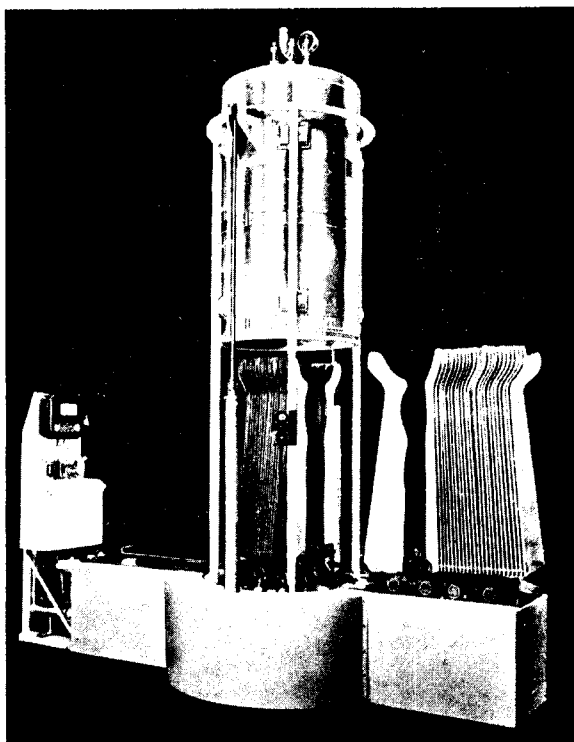

Fig. 23.2 Pegson machine for pre-boarding and post-boarding
(S. Pegg)

in which the goods can be subjected to the action of steam under pressures up to 40 lb per square inch. Typical footwear pre-boarding machines are shown in Figs. 23.1 and 23.2. In the Girland machine illustrated in Fig. 23.1 the stockings or socks are placed on the aluminium shaped boards and conveyed manually into the steam chest on a carriage mounted on a rail. The closing of the doors, the admission and exhaustion of the steam, and the reopening of the doors are all automatically controlled by electrical

timing devices. In the machine made by Pegg, shown in Fig. 23.2, a cylindrical container drops down over the boards which hold the garments, making a hermetically-sealed joint at the seating whilst steam is injected. When the cycle is over the cylinder lifts up vertically so that the frames inside can be taken out and another loaded carriage can take their place.

The temperature and time of exposure to steam varies very much and according to the nature of the yarn and the type of finish which is desired. The following figures must only be taken as an indication of the range within which temperature and time fall.

Spun nylon	Pre-board 18 psi	3½ minutes
Textured nylon	Pre-board 25 psi	2½ minutes
False twist nylon	Post-board 38 psi	30 seconds
False twist nylon	Post-board 28 psi	30 seconds

Fabrics, in open width, are generally set in enclosed stenters in which hot air circulates (Fig. 23.3). The temperatures range between 150°C and

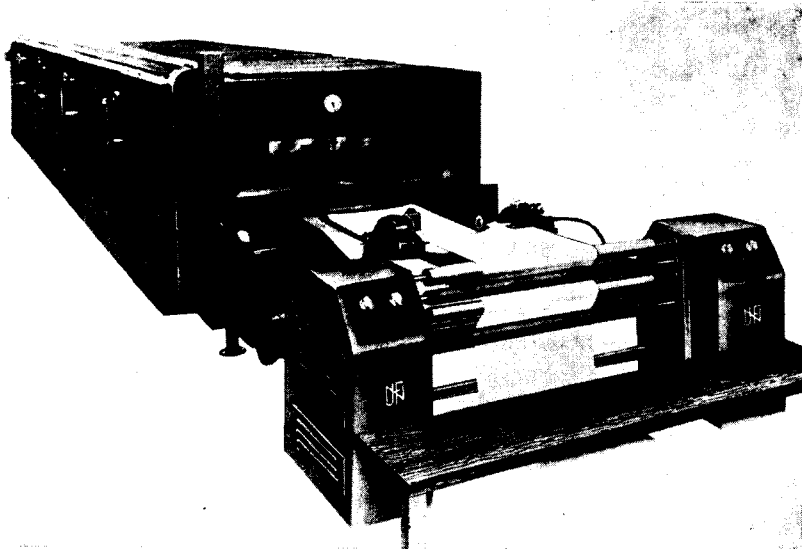

Fig. 23.3 Enclosed stenter
(Courtesy of Sir James Farmer Norton)

220°C (302°F and 428°F) according to the nature of the yarn, the structure of the fabric, and the type of finish required. The temperature of setting can have an effect on affinity for dyes and it is therefore important that conditions should be kept uniform. Circular knitted web can be set on the Hot Bowl Calender (Chapter 21) or the piece may be rolled over a stretcher to the specified width and set in an autoclave (Fig. 23.4).

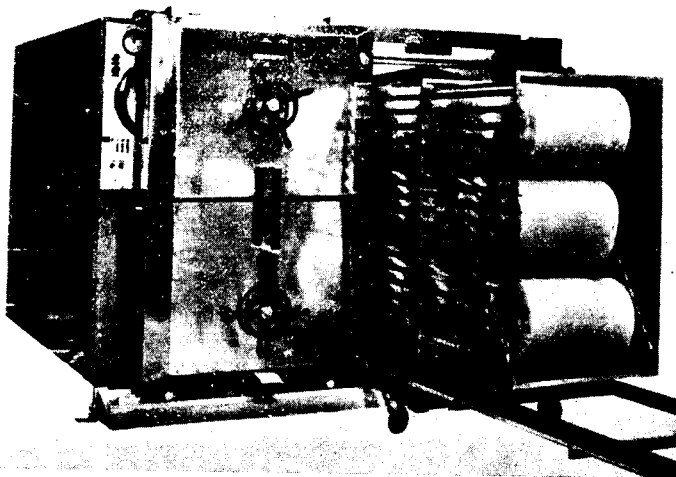

Fig. 23.4 Autoclave for heat-setting fabric
(Courtesy Andrew Engineering)

The effect of heat-setting has been studied by Peters and White (*J.S.D.C.*, 1961, 77, 601). The treatment alters the physical fine structure and hot-air setting can bring about a decrease in the number of the amine end groups through oxidation. Dry heat-setting up to temperatures of the order of 200 to 210°C causes a decrease in the exhaustion and rate of dyeing with all types of dyestuff. Over 210°C the exhaustion at equilibrium increases until at about 250°C it is equal to that of the original yarn. Steam setting, on the other hand, has little effect on the equilibrium uptake of dyes but increases the rate of dyeing, as shown in the graphs in Fig. 23.5.

It must be pointed out, however, that superheated steam resembles dry

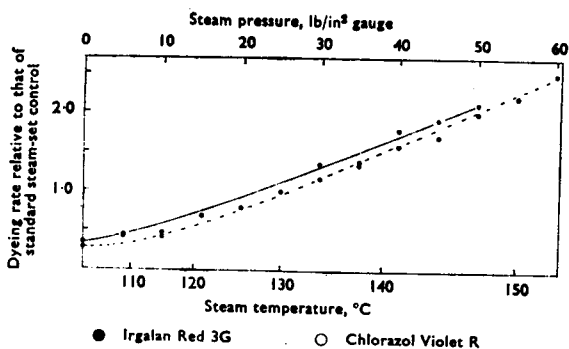

Fig. 23.5 Effect of pressure of saturated steam on rate of dyeing of Nylon 66

(Peters and White, *J.S.D.C.*, 1961, 601)

heat by reducing equilibrium uptake. Nylon goods should be scoured before dyeing, an operation which may be carried out either before or after setting. Treatment during 30 minutes to 1 hour in a liquor containing 1 to 2½ lb of a detergent and ½ to 1 lb of soda ash per 100 gallons at a temperature of 70°C (158°F) is generally adequate. If the goods are to be dyed a pale shade it may be necessary to bleach them with sodium chlorite or peracetic acid. Nylon itself has quite a good white natural colour, but presetting can cause a yellowish discoloration which could be sufficient to detract from the clarity of pale bright shades.

Application of disperse dyes to polyamides

The method is essentially the same as that described in Chapter 21 for their application to cellulose acetate. The dyestuff is sprinkled into 10 to 20 times its own weight of water with vigorous stirring. The use of boiling water for pasting the dye is undesirable because it tends to cause the formation of lumps, as does the addition of undiluted dispersing agent to the unwetted powder. The entry of undispersed particles into the dyebath should be avoided by straining.

About 1 to 2 lb per 100 gallons of a dispersing agent should be added to the dyebath to keep the dye in suspension and to retard the rate of adsorption. The goods are entered into a cold dyebath and the temperature is raised over a period of 30 minutes to 85°C (185°F), where it is maintained for a further 45 minutes. There is usually not much difficulty about level dyeing because the exhaustion is not unduly rapid. The actual rates of exhaustion however, do vary very much from one dye to another and a good combination with comparable dyeing properties is:

C.I. DISPERSE YELLOW 3

C.I. DISPERSE RED 1

C.I. DISPERSE BLUE 3

The disperse diazo blacks are applied by the general method for disperse dyes, using the equivalent of 4 per cent of a colour of 300 per cent strength. After dyeing, the nylon is rinsed and then diazotized in a cold liquor containing 3 lb of sodium nitrite and 9 lb of hydrochloric acid (32°Tw 31.5 per cent) per 100 gallons, the reaction being complete after 30 minutes. The goods are then rinsed and developed with 4.5 per cent of β -hydroxynaphthoic acid. The pH of the coupling liquor is adjusted to between 4 and 5 by the addition of acetic acid and the goods put in cold. The temperature is raised slowly to 60°C (140°F) and coupling is allowed to proceed at this temperature during a period of 30 minutes.

The light-fastness of most dispersed dyes on nylon is within the range of 4 to 6, although there are quite a few falling lower. The washing fastness varies considerably but can be as low as 2, and is usually not very satisfactory in heavy shades. A few examples are quoted in Table 23.1.

Table 23.1

Dye	C.I. number	Fastness to	
		Light	Wash (S.D.C. No. 2 Alteration)
Cibacet Yellow GBA	DISPERSE YELLOW 3	6	4
Setacyl Yellow 2GNE	DISPERSE YELLOW 8	4-5	3
Dispersol Fast Orange G	DISPERSE ORANGE 3	4-5	2
Cibacet Scarlet BRN	DISPERSE RED 1	4	3
Setacyl Blue 2GS	DISPERSE BLUE 1	3	3
Artisil Direct Blue BSQ	DISPERSE BLUE 3	5	3
Dispersol Diazo Black B (Developed β -hydroxynaphthoic acid)	DISPERSE BLACK 1	3-4	3-4

When goods are to be post-boarded some of the disperse dyes are not sufficiently stable to the conditions in the autoclave, particularly if the steam be moist. The disperse dyes also show a tendency to sublime which can cause staining of adjacent materials. Gas fading, however, does not occur when the disperse dyes are applied to polyamides.

Solacet dyes

The Solacet dyes are insoluble azo pigments solubilized with an *N*- β -hydroxy alkyl group and, although they are soluble in water, they will nevertheless exhaust on hydrophobic fibres. Their application to nylon is quite simple. The goods are entered into a cold dye liquor to which the dyestuff, without any assistants, has been added. The temperature is raised to 80° to 85°C (176° to 185°F) and dyeing is continued for 45 to 60 minutes. When heavy shades are required exhaustion is assisted by the addition of 1 per cent of acetic acid (30 per cent). It must be borne in mind that the shade which a dye may produce on nylon often differs quite significantly from the result on cellulose acetate. The disperse dyes migrate and level up quite well on prolonged boiling, especially if the concentration of the dispersing agent is increased. The Solacet dyes, on the other hand, show little redistribution of colour on continued boiling.

The light-fastness of the Solacet dyes on nylon ranges between 3 and 5 in pale shades, with the exception of Solacet Fast Rubine 3BS, Solacet Fast Violet 4RS, and Solacet Violet BS, which are rated as 1, 2, and 1 respectively. The fastness to mild washing at 40°C (104°F) varies between 4 and 5 and there is no risk of trouble due to sublimation.

Direct dyes

Certain selected direct cotton dyes are used for polyamides because they provide an economical method for dyeing heavy shades. In pale shades

their application is restricted because, under such conditions, they do not cover-up yarn irregularities well. The recommended method of dyeing is to make the liquor up with the dye, 10 per cent of Glauber's salt or 5 per cent of common salt and 2 per cent of acetic acid. The goods are then entered and the temperature is raised to the boil over a period of 20 minutes and dyeing is continued for one hour.

The light fastness is of the order of 5 to 6 and washing fastness when tested by the ISO Washing Test No. 2 is between 4 and 5. It is recommended that, in order to achieve the best wet fastness, dyeing should be followed by back tanning, in the manner which will be described when dealing with the application of acid dyes to polyamides.

Acid dyes

The mechanism of the dyeing of nylon with acid dyes was studied by Peters (*J.S.D.C.*, 1945, 61, 95). The relationship between the amount of dye taken up by the fibre and the pH of the dyebath is shown in Fig. 23.6. In the range pH 10 to pH 6 the curve resembles the titration of wool with acids and corresponds with the dye anions uniting with primary amino groups. Between pH 6 and pH 3.5 the curve is flat, indicating that increasing acidity has no more influence upon adsorption because all the sites are already occupied. Between pH 2.5 and pH 2 there is an abrupt change with

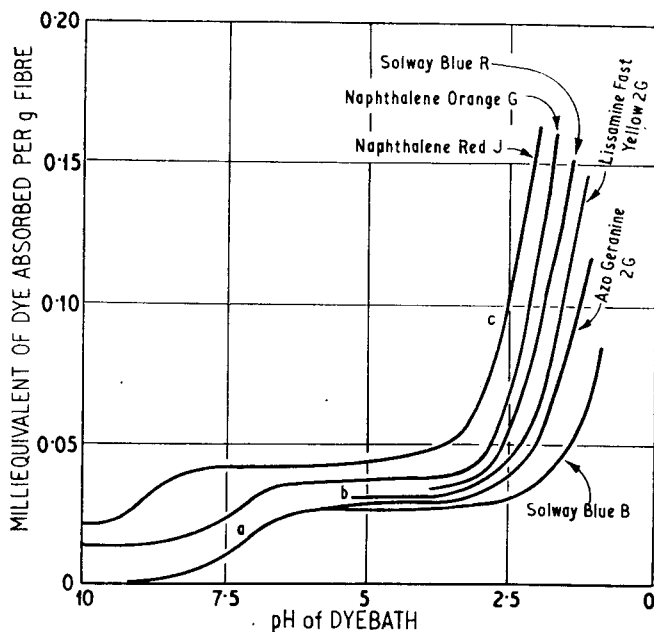

Fig. 23.6 Relationship between pH and acid dyes adsorbed by Nylon 66
(PETERS, *J.S.D.C.*, 1945)

a very rapid increase in the amount of dye taken up. It is believed that at this point the secondary amino groups become positively charged and can attract dye anions.

In practice, dyeing cannot be carried out in the pH 2 to 2.5 region because the degradation of the nylon would be excessive. Practical dyeing thus is restricted to reaction with primary amino groups which are limited in number. The competition for the sites, therefore, can become a significant factor when excess of dye anions are present leading to anomalous effects when mixtures of colours are used. Abbot, Cook, and Townend (*J.S.D.C.*, 1947, **63**, 462) describe the behaviour of Tartrazine NS and Lissamine Red 7BPS. Tartrazine NS has a half-dyeing time of 1 minute and the equivalent time for Lissamine Red 7BPS is 2 minutes. When they are dyed together, however, the half-dyeing time for Lissamine Red 7BPS is 3.5 minutes and for Tartrazine NS it is 11.25 minutes. Only a limited number of electropositive sites are easily accessible at or near the surface of the fibre. Lissamine Red 7BPS, in spite of its slower rate of exhaustion, has a greater thermodynamic affinity. It therefore unites with the readily-available amino groups and cannot be displaced by Tartrazine NS anions, which have to find the more remote unoccupied points of attachment.

The greater the complexity of the dye anion the stronger will be its affinity towards nylon. The acid milling dyes, therefore, are incompatible with the level dyeing acid colours and tend to depress their rate of exhaustion. It has been found, in practice, that Lissamine Fast Yellow 2G (C.I. ACID YELLOW 17), Solway Blue BN (C.I. ACID BLUE 45), and Azo-Geranine 2G (C.I. ACID RED 1) make a combination with very good compatibility. The blocking of sites leading to exclusion of the dye with less affinity is made use of in reserving nylon when dyeing mixtures of the fibre with wool or cellulose. The presence in the dyebath of a colourless, highly sulphonated compound with a marked affinity, will occupy the sites and deny them to the dye anions. Examples of such compounds are Tanninol WR, Erional NW, and Albatex WS.

Application of acid dyes

In most essentials the dyeing properties of acid dyes with regard to nylon and wool are similar. The molecularly dispersed dyes do not exhaust well without acid and the fast acid dyes yield heavy dyeings in a neutral liquor. The shades are very similar to the corresponding colours on wool, but the saturation point is lower with nylon. Thus nylon cannot take up more than 1.5 per cent of Solway Blue BN, compared with a saturation value of 30 per cent for wool. Reference has already been made to the greatly increased affinity for acid dyes at pH 2 or lower, but this is of no practical assistance because of the risk of degradation of the nylon. The acid dyes vary very much with regard to their levelling power at the boil and the general pattern of behaviour is similar to that with wool. The light-fastness is of the

same order as with wool, but the wet-fastness is usually better. A factor which must be taken into account with acid dyes is that yarn differences are not covered up, but it is claimed that, in this respect, there is an improvement when some of the cationic/non-ionic levelling agents are used.

Acid dyes requiring strong acid are applied from a dye liquor containing 3 to 5 per cent of formic acid. Sulphuric acid should not be used because it can cause some degradation of the nylon, and the addition of Glauber's salt is omitted because it has no beneficial effect. Non-ionic levelling agents, either alone or mixed with cationic products, are used. The goods are entered cold and the dyebath is brought to the boil and dyeing continued at this temperature for $\frac{3}{4}$ to 1 hour.

With those acid dyes exhausting well with weaker acids 1 to 3 per cent of acetic acid (80 per cent) may be substituted for the formic acid or, alternatively, 1 to 3 per cent of ammonium acetate. Dihydrogen ammonium phosphate instead of an acid gives very good results but, whichever be used, it is often necessary to complete the exhaustion by the addition of 2 to 4 per cent of formic acid after boiling for 45 minutes. When dyeing with the fast acid dyes the goods are entered into a cold dyebath containing the dye and a restraining agent, if desired. The temperature is brought up to 100°C (212°F) slowly and boiling continued for 45 minutes. To obtain heavy shades, an addition of 1 to 3 per cent of ammonium acetate will then be necessary. The acid dyes are all stable to steam at high temperatures and are suitable for goods intended for post-boarding.

Fastness

The initial attraction between the fibre and the anionic dye is polar but when the molecule is attached to the site non-polar forces come into play. Because of this dual attachment the wet fastness is significantly better than that of the disperse dyes where only physical forces are involved. The anionic dyes, however, are more sensitive to variations in the chemical constitution of the polyamide and also they are of higher molecular weight than the disperse dyes and therefore may give rise to levelling difficulties and yield barré dyeings.

As an illustration the light and washing fastnesses of a few acid dyes are quoted below:

	<i>Light fastness</i> 1/1 <i>standard</i> <i>depth</i>	<i>Washing ISO 3</i> 1/1 <i>depth</i> <i>change of shade</i>
C.I. Acid Yellow 29	6-7	4
C.I. Acid Orange 43	6-7	5
C.I. Acid Red 57	7	4-5
C.I. Acid Blue 40	6-7	4-5

Back tanning

The wet fastness of acid dyes can be improved by back tanning, which consists of treatment with 1 to 2 per cent of tannic acid and 1 to 2 per cent of 85 per cent formic acid at 70°C (160°F). After 15 to 20 minutes at this temperature 1 to 2 per cent of tartar emetic is added and the treatment is continued for a further 15 to 20 minutes. The effect is to improve the fastness to the ISO 2 washing test by something of the order of one half of a grading. A simpler method of bringing about some improvement in wet fastness is to after-treat with certain anionic products such as Erional NW, Cibatex PA, Tanninol WR, or Nylofix P. Treatment would be at 70 to 90°C (158 to 194°F) for 15 to 30 minutes in a liquor containing 3 to 5 per cent of the anionic compound and 2 per cent of formic acid (85 per cent).

Acid mordant and premetallized dyes can be applied to polyamides. They build up well into dark shades and the light- and wet-fastnesses are good. It must, however, be borne in mind that they are worse than other classes for emphasizing yarn variations. These dyes have no migrating properties once they have been taken up by the fibre and it is therefore most important to control conditions during dyeing in such a manner that the initial adsorption is uniform.

The acid mordant dyes are applied, in the first stage, in the manner already described for acid dyes. Because the exhaustion is not so good as with wool it is advisable to run the dye liquor off when the dyeing cycle is complete and refill with fresh water for chroming. The chroming is carried out with 3 to 4 per cent of formic acid (85 per cent) and the following quantities of dichromate:

For shades up to 2 per cent depth	$\frac{1}{2}$ per cent of dichromate
For shades between 2 per cent and 6 per cent	1 per cent of dichromate
For shades over 6 per cent depth	2 per cent of dichromate

On account of the hydrophobic nature of the fibre the penetration of the chrome is slower than with wool and chroming is therefore carried out at the boil for 1 hour. The formation of a complex with the dye requires the reduction of the chromium from the hexavalent to the trivalent state. Keratin is capable of acting as a reducing agent, but this is not the case with polyamides. Hadfield and Sharing (*J.S.D.C.*, 1948, 64, 381) suggest that the dye on the nylon can catalyse the reduction of dichromate by the formic acid in the dyebath. With the heavy shades there is a risk that not enough hexavalent chromium will be reduced to complete lake formation. Furthermore, any dichromate left in the nylon will accelerate tendering on exposure to light. With heavy shades, therefore, it is advisable, after chroming for 1 hour, to add a quantity of sodium thiosulphate equal to twice the weight of the dyestuff and continue boiling for a further 30 minutes to ensure complete reduction of the dichromate.

The **premetallized dyes** are in many ways very suitable for dyeing polyamides. They build up well into heavy shades because their affinity depends upon physical forces and hydrogen bonds, associated with their molecular complexity, as well as on the union of dye anions with amino groups. Their washing and light fastnesses are extremely good and they are reasonably level dyeing provided proper precautions are taken. It must, however, be borne in mind that if the initial adsorption is not uniform there will be absolutely no levelling due to migration on prolonged boiling. The **premetallized dyes** are probably the worst class for emphasizing variations in yarn properties.

The dye is added to a neutral liquor, the **pH** of which must under no circumstances be lower than 7. The goods are entered and the temperature is gradually brought to the boil. It is most important that the rise in temperature should be slow because, with the exception of heavy shades, exhaustion will be complete by the time that the boiling point is reached and then little further levelling will take place. After boiling for 30 minutes, in the case of heavy shades, exhaustion may be assisted by the addition of 1 to 3 per cent of ammonium acetate or dihydrogen phosphate. Surface-active retarding agents afford considerable assistance in obtaining level results.

Procinyl dyes

This range combines the advantages of the disperse and the anionic dyes. They are, in fact, molecules not containing ionic **solubilizing** groups. Their adsorption by the fibre, therefore, is a physical process, conforming essentially to a partition of a solute between two immiscible phases. They do, however, contain within their molecule a group carrying a labile chlorine atom capable of reacting with the amino groups of the polyamide. Thus under faintly acid conditions adsorption is comparatively uniform and barrdness is avoided. When the **dyebath** is made alkaline a chemical reaction takes place between the fibre and the dye thus giving a degree of wet fastness comparable with the acid dyes.

The method of application is to set the **dyebath** at 40°C (104°F) with the dyestuff and two parts per thousand of 30 per cent acetic acid and one part of a non-ionic surface active compound. The temperature is raised slowly to 85 to 100°C (185 to 212°F) and dyeing is continued at this temperature for 30 minutes. The **pH** should be maintained at 3.5 to 4, if necessary by the addition during the dyeing of a small amount of acetic acid. At the end of 30 minutes 2.5 to 3 parts per thousand of soda ash are added and this should be sufficient to bring the **pH** to between 10 and 10.5, and fixation is carried out at the boil for a further 60 minutes. When dyeing is complete the goods should be rinsed and the heavier shades soaped. The washing fastnesses are of the order of 5 to ISO 2 and 4 to 5 to ISO 3 tests.

The dyeing of nylon in pressurized machines at temperatures above

100°C (212°F) is discussed by Hadfield and Seaman (*J.S.D.C.*, 1958, 74, 392). With acid dyes complete exhaustion, except possibly with heavy shades, is obtained at 95°C (203°F) and there is little advantage to be gained by dyeing above this temperature. Irregularities in the affinity of the yarn may be due to varying numbers of terminal amino groups or to differences in physical properties. Where the amino groups are involved no amount of boiling will have any corrective action, but physical variations are masked if exhaustion proceeds to complete equilibrium. In commercial dyeing under normal conditions time is not available for the attainment of equilibrium, but this is possible at 130°C (266°F), when there is a marked improvement in the coverage of irregularities due to physical causes. Reference has already been made to the great saving in time in chroming the acid mordant dyes at 130°C (266°F).

Reference was made in Chapter 16 to the use of benzyl alcohol in wool dyeing. The Irga-Solvent process, based on addition of benzyl alcohol to the dyebath, has met with considerable success in the application of acid dyes to nylon because it gives coverage of yarn irregularities equivalent to the disperse dyes, but with improved wet-fastness. Other advantages are that exhaustion is complete at lower temperatures in a shorter time. Virtually the whole of the dye is adsorbed, leaving, for all practical purposes, a clear liquor. This makes it possible to use the same liquor several times, reducing the cost of the solvent, and assisting in arriving at recipes which will repeat the same shade from batch to batch.

The liquor is made up with 4 gallons per 100 of benzyl alcohol, 2 per cent on the weight of the goods of Irgasol NJ (an anionic surface active product), 2 per cent of acetic acid (40 per cent), and a portion of the dye. The goods are entered at 60°C (140°F) and the temperature raised to the boil and the remainder of the dye is added at intervals. Exhaustion is very rapid and level results are obtained without prolonged boiling.

Dyeing modified nylons

By the addition of copolymers during spinning it is possible to modify the affinities for dyes. Three types are in production, namely regular (type 100), deep dye (type 110) and basic dye (type 120) nylons. Type 100 is normal nylon, type 110 is dyed with acid dyes but has a greater affinity and type 120 is dyed by basic dyes and is resistant to acid dyes. It is therefore possible by appropriate mixing of the yarns to obtain coloured and white, tone and tone and cross dye effects.

The yarns are tinted and the recommended method for scouring is to make up the bath with

- 1 ml/l of a non-ionic detergent
- 1 g/l of sodium hydrosulphite
- 1 g/l of sodium carbonate

The pH must be at least as high as 10 and the temperature raised to 45°C (113°F) over a period of 15 minutes after which scouring is continued for a further 15 to 30 minutes. If the tint has not all been removed the temperature may be raised to 60°C (140°F). When bleaching is necessary a liquor containing:

- 2 g/l of sodium dihydrogen phosphate
- $\frac{1}{2}$ g/l of sodium chlorite
- $\frac{1}{2}$ cc of glacial acetic acid

is recommended. The temperature should not be more than 70°C (158°F) and the time required is 30 minutes. These conditions must not be exceeded in severity, nor must peracetic acid be used, if diminution of the contrast after dyeing is to be avoided.

Dyeing deep dye/basic dye mixtures

Provided only medium shades are selected for the basic dye component there should be no significant staining of the deep dye yarn. For colour and white effects, selected acid dyes are used, and if desired, a fluorescent brightening agent may be added to improve the white of the type 120. Acid dyes reserving basic dyeable yarn in shades up to standard depth are:

- C.I. ACID REDS 57 and 138
- C.I. ACID VIOLET 41
- C.I. DIRECT YELLOW 12
- C.I. ACID BLUES 40, 71 and 112

Acid dyes which have good reserve when they are dyed in deep shades are:

- C.I. DIRECT YELLOW 50
- C.I. ACID RED 57
- C.I. ACID YELLOW 17
- C.I. ACID BLUE 45
- C.I. ACID BROWNS 10 and 11

and the basic dyes which have been recommended are:

- C.I. BASIC YELLOW 23
- C.I. BASIC BLUE 45
- C.I. BASIC REDS 23 and 15

The method of application is to make up a bath with 3 per cent on the weight of the goods of ammonium acetate and the dye. The goods are entered and the temperature is raised to the boil during twenty to thirty minutes and dyeing is continued for a further 45 minutes. If a two-colour effect is desired the basic dye must be added to the dyebath ten minutes after the acid dye. For shading, the temperature must be lowered to 70°C (158°F) and, to avoid mutual precipitation in concentrated solutions, the acid and basic dyes must be added separately.

Basic and standard yarns (Types 100 and 120). In colours of above 1/3 standard depth basic dyes will not reserve the type 100 and, unless very carefully selected, the acid dyes will stain the basic dyeable component.

Deep dye and standard yarns. Tone on tone dyeings can be obtained with acid dyes, the degree of contrast being governed by the pH of the dye liquor and the selection of the dyes and their concentration in the dyebath. If disperse and acid dyes are used in conjunction, the disperse will dye both fibres equally and there will be a degree of selective adsorption of the acid dye giving two colour effects.

Multi colour effects are obtainable with mixtures of types 100, 110 and 120 and further variations are possible by incorporating undyed or predyed polyester yarns.

Nylon 6

From the point of view of dyeing, the essential difference between nylons 6 and 66 is that the former has a greater proportion of amorphous zones and a lower melting point (66 approximately $250^{\circ}C$ and 6 $210^{\circ}C$). Lower temperatures therefore are necessary for heat setting. Thus with dry heat the recommended setting temperature is $185^{\circ}C \pm 2^{\circ}$ ($365^{\circ}F \pm 4^{\circ}$) and with steam setting it should be $115^{\circ}C$ (10 lb per sq. in) ($239^{\circ}F$).

The dyes which are used for nylon 66 are also suitable for nylon 6, but, because of the more open fine structure the dyes usually exhibit a higher rate of initial adsorption, better levelling properties and, because they can enter more easily, there is less obstruction to their migration out again so that there is some reduction in wet fastness.

The disperse dyes show little difference from nylon 66 in their rate of dyeing and their levelling properties are good. The wet fastness and to some extent the light fastness, however, are not all that could be desired. There are some disperse dyes which will give reasonable wet fastness in pale shades and it has been suggested that back tanning with tannic acid and tartar emetic gives some improvement.

Because of their better fastness, acid dyes probably find the greatest application in the dyeing of nylon 6. Owing to the greater rate of exhaustion more care must be taken in the adjustment of the pH and in the use and selection of suitable retarding agents. Migration, however, is usually better than with nylon 66 and this gives an opportunity to correct unlevelness by further boiling, after neutralizing the acid in the dyebath if this is found to be necessary. The wet fastness of medium to heavy shades is improved by back tanning or by treatment with a synthetic tanning agent. If, however, the desired fastness cannot be obtained with acid dyes, the acid chrome or the premetallized dyes should be used and they should preferably be back tanned or after-treated with one of the appropriate synthetic products. It must, however, be borne in mind that the additional fastness imparted by treatment with tannic acid and tartar emetic is seriously impaired by heat setting after dyeing.

Fabric dyed in a winch machine is subject to a measure of tension. For this reason the temperature should not exceed $85^{\circ}C$ ($185^{\circ}F$) to avoid a

permanent stretch which would have an adverse effect upon the final finish. When footwear is dyed in a paddle machine there is no stretching action and there is therefore no objection to dyeing at the boil.

Dyeing polyester fibres

Terylene shrinks about 7 per cent in boiling water and even more at higher temperatures. To avoid this it is heat set (MARVIN, *J.S.D.C.*, 1954, 70, 16). As a general rule it can be stated that a material will be dimensionally stable if set at a temperature 30° to 40°C (86° to 104°F) higher than that to which it will be subjected during use. Fabrics are usually heat-set on pin stenters over temperature ranges between 150° and 230°C (302° and 446°F), but garments can be set in steam autoclave machines at steam pressures between 20 and 25 psi.

Terylene is highly crystalline and markedly hydrophobic. It is not, therefore, easily penetrated by dyes with large molecules. It also has no chemically active groups and cannot combine with dye anions or cations. In practice, polyester fibres are dyed with disperse dyes, a few azoic combinations, and with those disperse dyes which can be diazotized and coupled *in situ*.

The exhaustion of disperse dyes, at equilibrium, is quite good, but the diffusion into the fibre is extremely slow. The time required to reach equilibrium, therefore, is much longer than would be permissible in practice. By selecting disperse dyes with the most rapid rates of diffusion it is possible to dye pale to medium shades at the boil within a reasonable time. Dyestuffs which are suitable are shown below and it will be observed that they all possess simple molecular structure.

Setacyl Orange GR

(C.I. DISPERSE ORANGE 3)

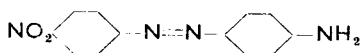

Cibacet Red 3B

(C.I. DISPERSE RED 15)

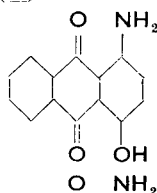

Artisil Direct Violet 2RP

(C.I. DISPERSE VIOLET 1)

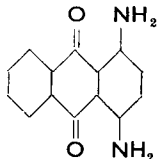

Duranol Blue G

(C.I. DISPERSE BLUE 26)

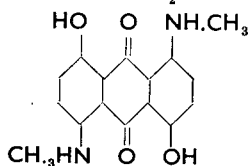

Usually between 2 per cent and 5 per cent of a disperse dye is required to yield a medium shade. The relationship between dye adsorbed, per 100 g of fibre and temperature is illustrated graphically in Fig. 23.7 (WATERS, *J.S.D.C.*, 1950, 66, 609). It is apparent that there is little absorption below

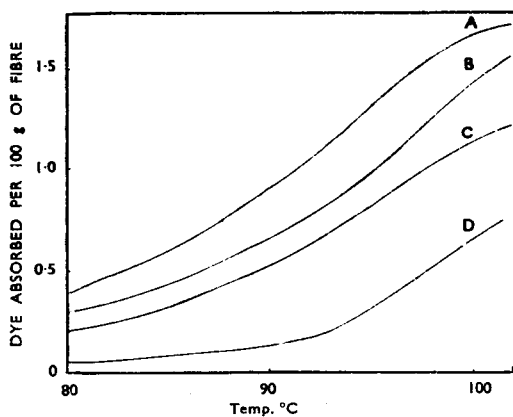

Fig. 23.7

- A. Duranol Red 2B
- B. Dispersol Fast Orange G
- C. Duranol Blue GN
- D. Dispersol Fast Scarlet B

80°C (176°F) and a comparatively rapid increase between 85° and 100°C (185° and 212°F). In every case the curve is still climbing at 100°C (212°F) and it is therefore necessary to dye at a vigorous boil for quite a long period, such as 90 minutes, to obtain a satisfactory degree of exhaustion. In the range 90° to 100°C (194° to 212°F) small changes in temperature make an appreciable difference to the rate of adsorption and, therefore, the goods should be immersed completely in the dye liquor for the whole of the time or, in a winch, the period of immersion for all the chains should be the same. The orange and red disperse dyes exhaust best and the blues are least satisfactory, which places a limitation on the range of compound shades containing blue components. A few disperse dyes with adequate affinities for polyester fibres are:

- C.I. DISPERSE YELLOW 3
- C.I. DISPERSE ORANGE 11 and 3
- C.I. DISPERSE RED 15 and 9
- C.I. DISPERSE VIOLET 1 and 4
- C.I. DISPERSE BLUE 26

Since the rate of dyeing is so slow there is not often difficulty with regard to level dyeing, but there is practically no migration and it is virtually impossible to correct faults by prolonged boiling. Since diffusion into the fibre

is slow the converse applies, equally, and wet-fastnesses are very good. Light-fastness, on the other hand, shows some anomaly in comparison with properties on cellulose acetate. Some disperse reds are faster on polyester fibres but others are more fugitive. Blues present difficulty with regard to light-fastness because they tend to assume a redder hue after comparatively short exposures. The best is probably Duranol Blue GN, which is rated as 4 to 5 in medium shades.

A considerable advance in the dyeing of polyester fibres was made when the carrier method was introduced. It was discovered that quite a number of organic compounds such as phenols, amines, or aromatic hydrocarbons, when either dissolved or suspended in the dyebath, accelerated the adsorption of disperse dyes by the fibre. The way in which carriers produce the effect is not clearly understood but they do cause some swelling of the fibre. It seems probable, therefore, that they can enter into the fine structure of the polyester and push adjacent long-chain molecules apart. This loosens up the molecular pattern and facilitates the entry of the larger dyestuff molecules. The water-insoluble carriers also appear to form a surface film on the fibre in which the disperse dye is highly soluble. The transfer of dye, in such circumstances, does not take place between the aqueous phase and the fibre but between dyestuff dissolved in carrier and fibre (VICKERSTAFF, *Hexagon digest*, No. 20).

Balmforth *et al.* (*J.S.D.C.*, 1966, **82**, 408) showed that there is a maximum concentration of the carrier above which the take-up of the dye by the fibre decreases. This optimum carrier concentration corresponds approximately with the amount necessary to saturate both fibre and dyebath phases of the system. Excess will introduce a third phase, namely undissolved carrier, which will compete with the fibre for the dye. Increase in adsorption at equilibrium is brought about by bisphenyl, orthophenylphenol and phenyl salicylate in the order in which they are set out. Benzoic acid, on the other hand, decreases the adsorption by the fibre at equilibrium and only increases the dyeing rate, probably by promoting the solubility of the dye. It is suggested, in fact, that water soluble carriers such as benzoic acid really act as extremely efficient dispersing agents.

Two carriers which have proved successful are diphenyl (Tumesal D) and *o*-phenylphenol (Tumesal OD). Diphenyl is a cream-coloured powder, insoluble in water, but in a readily dispersible state. Its effect upon the exhaustion of the dye is illustrated by the following comparison.

	<i>Exhaustion at 100°C (212°F) in 60 minutes</i>	<i>Exhaustion at 85°C (185°F) in 60 minutes</i>
<i>Dispersol Fast Scarlet B</i>		
Without diphenyl	48 per cent	11 per cent
With 8 per cent diphenyl	80	—

It is significant that with the carrier good exhaustion is obtained at 85°C (185°F), which is useful under circumstances when prolonged boiling is undesirable. The increases in the rate and degree of exhaustion are illustrated in the graph in Fig. 23.8 (I.C.I. Publication).

The action of diphenyl seems to be independent of liquor ratio and to be governed entirely by the percentage of the weight of the polyester. For pale shades 4 per cent suffices but for medium or heavy shades it is necessary to

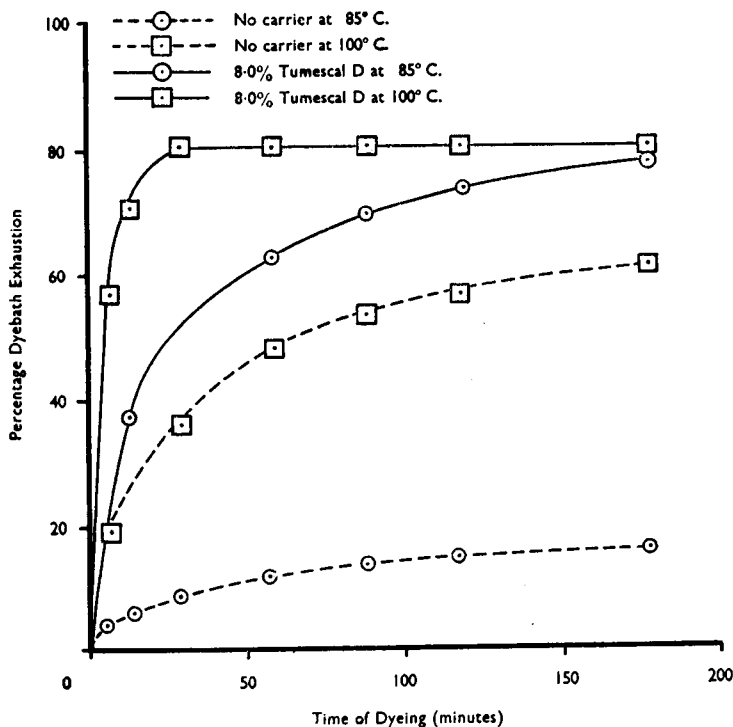

Fig. 23.8 The effect of Tumescal D on the rate of dyeing of Dispersol Fast Scarlet B 150
(I.C.I. Publication)

use 7.5 to 8 per cent. The powdered product is made into a suspension by mixing 1 part by weight with 4 parts of water, bringing to the boil, and boiling with constant stirring until a smooth emulsion has been formed. This is then added to the dyebath which has previously been brought to 85°C (185°F) because, if the temperature be lower, the diphenyl may be precipitated in a condition from which it cannot be emulsified again. The dyebath should also contain 1 to 2 lb of soap or the equivalent quantity of a synthetic emulsifying agent per 100 gallons to maintain the suspension. Dyeing is then carried out at 85°C (185°F) or at the boil, according to

circumstances. Finally the diphenyl must be washed out thoroughly because, if left in, it will give the goods a sickly sweet smell and can cause trouble by volatilizing during drying or hot pressing.

Orthophenylphenol (Tumesal OP), in the form of its sodium salt, is soluble in water, and therefore more easily removed after dyeing. It is also free from the somewhat unpleasant odour of diphenyl. The commercial product is the sodium salt which is dissolved in water and added to the dyebath. Unlike diphenyl the effectiveness is, to some extent, governed by liquor ratio and sufficient must be used to give a concentration of 3 to 4 lb per 100 gallons. The sodium salt does not act as a carrier and the orthophenylphenol must be liberated by the gradual addition of acetic acid.

The dyebath is made up with between $\frac{1}{2}$ and 2 lb of an anionic surface active product and 3 to 4 lb of orthophenylphenol per 100 gallons. The temperature should be 40°C (104°F) and, after the dye has been added, the liquor is slowly brought up to 100°C (212°F). After 15 minutes at this temperature $\frac{3}{4}$ pint of 30 per cent acetic acid, previously well diluted, for every pound of Tumesal OP is added gradually. Boiling is continued for a further hour after the addition of acetic acid is complete. After dyeing, the goods are washed out with a detergent and some sodium hydroxide to ensure the complete removal of the carrier. It has been found that orthophenylphenol is more satisfactory than diphenyl for jig or winch dyeing because it is less volatile in steam and therefore less liable to become deposited on the cooler parts of the machine, causing stains. Orthophenylphenol does cause some reduction in light fastness of dispersed dyes but not to any serious extent if its removal has been virtually complete by thorough washing out.

The very heavy shades such as blacks and navies cannot be dyed by conventional methods on polyester fibres, even with the help of carriers. Since the difficulty is the slow diffusion of the larger dyestuff molecules into the closely packed crystalline structure of the fibre, the obvious approach is to present simple molecules and cause them to combine to form a coloured pigment after they have entered. Brenthols and Naphthol AS products are not adsorbed by polyesters from aqueous solutions of their sodium salts. A limited measure of success was achieved by immersing the goods in a suspension of naphthoic acid anilide derivatives and then coupling with a diazotized base. The results were more successful, however, when coupling components with smaller molecules were used and α - and β -naphthols, applied from suspension, were satisfactory but β -hydroxynaphthoic acid proved to be the most suitable.

The application can be made using either a one- or a two-bath process. In the first the fast base is pasted with a dispersing agent and added to the dyebath, which has been brought to 70°C (158°F), and contains 0.5 to 2 lb per 100 gallons of dispersing agent. The goods are entered and the temperature is raised to the boil and adsorption is allowed to continue at this

temperature for 20 to 30 minutes. The β -hydroxynaphthoic acid, previously brought into suspension with the aid of a dispersing agent, is then added to the dyebath and boiling is continued for a further hour. The following bases are suitable for application by the single bath method.

C.I. AZOIC DIAZO COMPONENTS 5, 8, 9, 34, and 37

All these fast bases yield red or maroon shades with hydroxynaphthoic acid, after diazotization as described in the following paragraph.

The Dispersol Diazo Blacks B and 2B (C.I. DISPERSE BLACKS 1 AND 2), as well as Dispersol Fast Orange G (C.I. DISPERSE ORANGE 3) and Brentamine Fast Blue B Base (C.I. AZOIC DIAZO COMPONENT 48), are applied by the two-bath method. The fast base or disperse dye is added, as a suspension, to a dye liquor at 70°C (158°F) containing a dispersing agent. The temperature is raised to the boil, at which it is maintained for 1 hour. The machine is then emptied, the goods are rinsed, and a fresh liquor is made up to which the aqueous dispersion of β -hydroxynaphthoic acid is added when the temperature has reached 70°C (158°F). The liquor is raised to the boil, after which 1 hour is allowed for adsorption of this coupling component to reach completion. The adsorption of the disperse blacks is assisted considerably by the addition of 7 to 8 per cent of diphenyl. Coupling is finally brought about by treatment with 12 per cent of hydrochloric acid, and 8 per cent of sodium nitrite at 85°C (185°F) for 20 to 30 minutes.

High temperature dyeing

There are many advantages associated with dyeing polyesters at temperatures ranging between 120°C (248°F) and 130°C (266°F). Heavy shades can be dyed with disperse dyes without a carrier, saving expense and also time because rinsing out of carriers is a lengthy operation. A wider range of dyes is also available because some of those possessing good light fastness exhaust badly in conventional machines but can be used successfully at temperatures above 100°C (212°F). Fabrics containing polyester fibres are frequently pleated because of the permanency of the crease so formed. When dyeing at atmospheric pressure, only dyes of low molecular weight which tend to sublime during pleating can be used, but the more satisfactory colours with higher molecular weights can be applied at temperatures between 120° and 130°C (248° and 266°F). There is no perceptible loss of elasticity or tensile strength when polyester fibres are dyed under neutral or slightly acid conditions at 130°C (266°F), but degradation becomes apparent in the presence of even traces of alkali. Any alkali used during scouring, therefore, must be removed entirely before high-temperature dyeing.

Scouring should be carried out at 90° to 95°C (194° to 203°F) in a liquor containing 1 to 2 lb of a detergent and $\frac{1}{4}$ lb of sodium carbonate per 100 gallons during a period of 15 minutes. When scoured a rinse should be

followed by a second rinse in water containing a little acetic acid, to ensure that no alkali is left.

The effect of temperature on both rate and degree of exhaustion of Dispersol Fast Scarlet B (C.I. DISPERSE RED 1) is shown in the isotherms at 120°C, 100°C and 85°C shown in Fig. 23.9 (I.C.I. Publication).

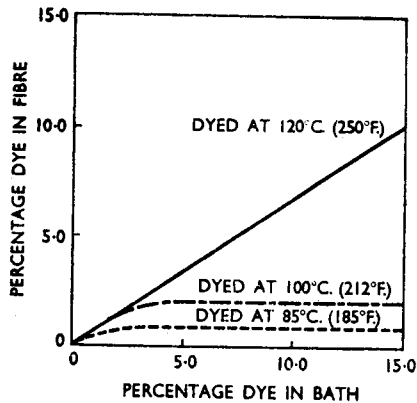

Fig. 23.9 The effect of dyeing temperature on the adsorption of a disperse dye (Dispersol Fast Scarlet B 150, dyed for 90 minutes in a liquor-to-goods ratio of 30 : 1)
(I.C.I. Publication)

The following disperse dyes are particularly recommended for dyeing between 120° and 130°C (248° and 266°F), all of which are sufficiently stable for a dyeing cycle lasting 2 hours, although in practice exhaustion is nearly always complete in 30 minutes.

- C.I. DISPERSE YELLOW 1, 39
- C.I. DISPERSE ORANGE 13
- C.I. DISPERSE RED 11, 13
- C.I. DISPERSE VIOLET 8, 14
- C.I. DISPERSE BLUE 26

With the more level-dyeing disperse dyes, such as those quoted above, no advantage is gained by using temperatures above 120°C (248°F), so long as the initial adsorption is reasonably uniform. On the other hand, if dyes which are known to be unlevel dyeing have to be selected, application at 130°C (266°F) is preferable.

The method of dyeing is to make the dyebath up with the dyestuff and 1 to 2 lb of a dispersing agent such as Lissapol C (oleyl sodium sulphate) or some similar product which is stable up to 130°C (266°F). The dyeing should be started at 70°C (158°F), the temperature raised slowly to 120° to 130°C (248° to 266°F) and maintained for a period of 30 to 60 minutes. If necessary, shading colours can be added at 120° to 130°C, allowing 20

minutes after each addition to ensure uniform distribution. When very heavy shades have been dyed it may be necessary to give a 'reduction-clearing' to avoid lack of fastness to rubbing. The goods are treated for 20 minutes at 45° to 50°C (113° to 122°F) with 6 lb of caustic soda (68°Tw 23.75 per cent), 2 lb of sodium hydrosulphite, and 2 lb of Lissolamine A (50 per cent paste) (cetyl trimethyl ammonium bromide) per 100 gallons of water. Owing to the hydrophobic nature of the polyester fibre only surface dye will be reduced and the chemicals will not penetrate to react with the adsorbed colour. After high-temperature dyeing the goods should always have a final wash-off at 70°C (158°F) for 15 to 20 minutes with a suitable detergent.

Application of vat dyes

It is possible to apply vat dyes to polyester fibre, but not by the conventional method of reduction and subsequent oxidation. The fibre will adsorb the oxidized pigment from an aqueous dispersion at high temperatures such as 130°C (266°F). The mechanism is presumably similar to the adsorption and retention of disperse dyes. Only a few vat dyes are suitable for application and they must, naturally, be in a sufficiently finely divided state to make a stable suspension. The method of application is to make up the dyebath, at 70°C (158°F), with a dispersing agent (1 to 2 lb of Lissapal C or D per 100 gallons) and the dye previously made into a suspension and added through a strainer. The goods are entered and the temperature is raised slowly to 130°C (266°F) and dyed for 1 hour. Shading with the vat dyes may be made at 130°C (266°F), allowing 30 minutes after each addition for exhaustion and equalization. When dyeing is complete a 'reduction-clearing', as already described for disperse dyes, should be given followed by a final wash-off at 70°C (158°F).

Vat dyes which can be applied by this method are quoted below (I.C.I. Publication) and the figures in brackets represent the maximum depth of shade which will give satisfactory results.

Caledon Golden Yellow GK (1 per cent)	C.I. VAT YELLOW 4
Durindone Scarlet Y (3 per cent)	C.I. VAT RED 45
Durindone Red B (3 per cent)	C.I. VAT RED 41
Caledon Brilliant Violet R (2 per cent)	C.I. VAT VIOLET 17

These vat dyes give colours of extremely good wet-fastness and they are quite unaffected by steaming or pleating. The reds are extremely bright.

Azoic dyes applied at high temperatures

There are a number of Fast Bases which are adsorbed by the fibre at 100°C (212°F) and with these no advantage is gained by increasing the temperature further because the degree of exhaustion tends to decrease.

With the bases or diazotizable disperse dyes in the following list, however, levelling and exhaustion are better at 120° to 130°C (248° to 266°F).

Dispersol Fast Orange G (borderline)	C.I. DISPERSE ORANGE 3
Brentamine Fast Blue B Base	C.I. AZOIC DIAZO COMPONENT 48
Dispersol Diazo Black B	C.I. DISPERSE BLACK 1
Dispersol Diazo Black 2B	C.I. DISPERSE BLACK 2

The β -hydroxynaphthoic acid must be taken up from a separate liquor because the exhaustion of the latter decreases rapidly at temperatures above 100°C (212°F) (see Fig. 23.10) (I.C.I. Publication).

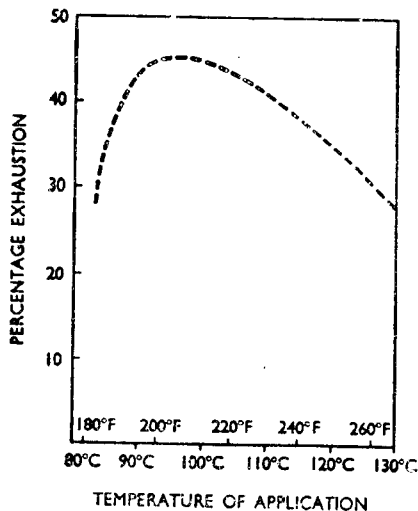

Fig. 23.10 Brentosyn BB. The relation between temperature of application and exhaustion (Time of dyeing 90 minutes, liquor-to-goods ratio 30 : 1, 2 parts β -oxynaphthoic acid per 1000 parts of liquor)

(I.C.I. Publication)

The procedure is to apply the Dispersol Fast Orange G, Dispersol Diazo Black B, and Dispersol Diazo Black 2B in the method described for the high-temperature dyeing of disperse dyes. The bath is then emptied and a fresh liquor is made up to which the appropriate quantity of Brentosyn BB (β -hydroxynaphthoic acid) is added, together with a dispersing agent, at 70°C (158°F). The pH must be adjusted to between 4 and 5 by the addition of hydrochloric acid (acetic and formic acids are not suitable). The temperature is brought up to 100°C (212°F) at which it is maintained for 1 hour. The goods are then rinsed and given a 'reduction-clearing' as already described on page 519. The colour is finally developed in a liquor containing 2 to 6 per cent (of the weight of the goods) of sodium nitrite, and 14 per cent of hydrochloric acid (32°Tw 31.45 per cent). The diazotization and coupling is started cold and the temperature is gradually raised to 95° to 100°C (203° to 212°F) or, when dyeing blacks, to 85° to 90°C (185° to

194°F), and a further 40 minutes is allowed for the completion of the reaction. The amount of sodium nitrite necessary will depend much upon the type of machine in use, but an excess can give a reddish hue to the shade. In totally-enclosed and hermetically-sealed machines it is possible for the liberated nitrous oxide to build up quite a substantial pressure, which would retard circulation.

Continuous dyeing of polyesters

The Thermosol process of Du Pont, or similar thermofix methods, are used extensively for continuous dyeing of materials made of polyester alone or when mixed with other fibres. The process, see Fig. 23.11, is

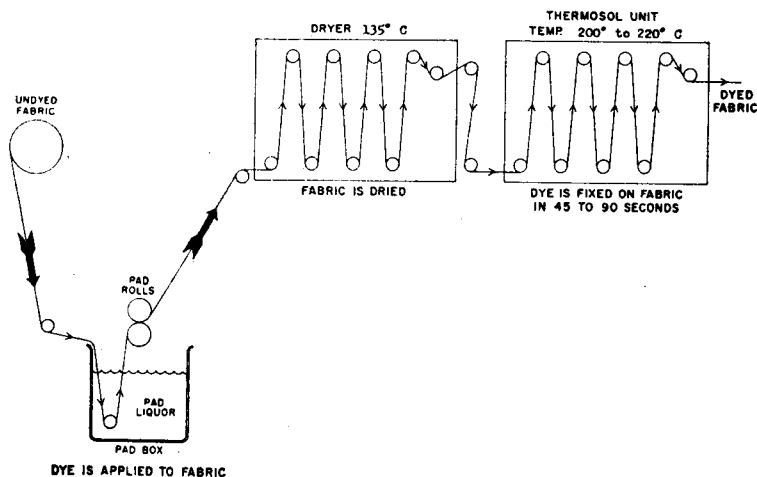

Fig. 23.11 The Thermosol process

(Courtesy of 'The Dyer')

based upon padding with a disperse dye or a finely divided vat dye in its pigment form. This is followed by drying, causing a film containing the dye to adhere to the surface of the fibres. The next stage consists of heating to 180 to 220°C for periods of 30 to 60 seconds.

A pad liquor for 100 per cent polyester fabric would contain the following

	Parts per 1000
Disperse dye	x
Urea	0 to 100
	(to increase exhaustion)
Permal PP (I.C.I.)	2
Migration Inhibitor V (I.C.I.)	10
(Or sodium alginate)	
Water	Up to 1000

(TAYLOR AND DENYER, *J.S.D.C.*, 1965, 81, 302)

After padding, the material passes through a drying unit, which may be a hot flue chamber, heated cans, or an infra-red pre-dryer, before entry into the drying unit proper. The dried material containing a film of the padding mixture is then heated to the desired temperature, which is somewhere between 180 and 220°C in a hot flue oven, or on cans heated by gas or in a fluidized bed.

At the high temperature at which thermofixation is carried out thermal agitation of both the polyester and the dye molecule is substantially increased. This permits much more rapid diffusion of the dye into the fibre. The actual mechanism of fixation is probably mainly one of solution of the dye in the polymer but the possibility of hydrogen bonding between the carbonyl groups in the polymer and the amino or hydroxyl groups in the dye cannot be excluded. There is also no doubt that Van der Waals' forces come into play.

Dyeing polyacrylonitrile fibres

The acrylic fibres always contain a proportion of a copolymer upon which the dyeing properties depend to a large extent, and as an **example**-Courtelle contains negative groups so that it possesses a good affinity for **cationic** dyes. The fibres are hydrophobic and, therefore, do not as a rule possess a marked affinity for water-soluble dyes, although there are some exceptions to this generalization. Polyacrylonitriles will dye with disperse dyes at 95° to 100°C (203° to 212°F), but exhaustion is slow and there is not good build-up for heavier shades. The saturation uptake of a few disperse dyes at 95°C (203°F) on different fibres is shown in Table 23.2 (WALLS, *J.S.D.C.*, 1956, 72, 262).

Table 23.2

Dye	Percentage uptake of dye		
	Polyacrylonitrile	Polyamide	Secondary acetate
Dispersol Fast Yellow G	1.4	4.8	7.4
Dispersol Fast Orange G	1.1	1.8	7.3
Duranol Blue Green B	1.0	9.5	10.8
Dispersol Fast Yellow A	3.0	5.0	16.0
Duranol Red 2B	1.8	4.5	11.0
Duranol Brilliant Blue CB	3.5	8.0	10.5

It is apparent, therefore, that only pale to medium shades can be dyed at the boil under atmospheric pressure. Better exhaustion is obtained at higher temperatures but 110°C (230°F) should be regarded as the limit, because, above this, there will be excessive shrinkage with most fibres.

Because the affinity is low the disperse dyes are very level dyeing on polyacrylonitrile fibres. These colours also have excellent wet-fastness, good light-fastness, and are free from gas fading on the acrylics. They do, however, tend to sublime and mark off on adjacent materials during pleating and hot pressing because only those with low molecular weight can penetrate into the hydrophobic fibre. In heavy shades, however, rubbing fastness is not all that could be desired. Polyacrylonitriles have a tendency to become slightly discoloured on boiling in mildly alkaline solutions. To avoid any risk of this happening it has been recommended that the disperse dyes should be applied under slightly acidic conditions to assure maximum brightness. Thus dyeing should be carried out in a liquor containing 1 g/l of sodium dihydrogen phosphate or 0.5 mg per litre of acetic acid (80 per cent) together with 1 g/l of a non-ionic dispersing agent, at the boil for a period of $1\frac{1}{2}$ hours.

It must be emphasized that dyeing of polyacrylonitriles is generally carried out at temperatures higher than the second order transition. The polymer is therefore in a semi-plastic state and if allowed to cool rapidly distortions and creases can become permanently established. The dye liquor should therefore be cooled down, either by running cold water through a closed coil if this is available or, alternatively, by running in cold water at approximately the same rate as the dye liquor is being discharged until the temperature has fallen below 70°C (158°F). During this time the movement of the goods being dyed should be maintained to prevent creases and distortions remaining static long enough to become a permanent feature. If there is much dye left in the liquor this may, during cooling, come out of suspension and be deposited on the surface of the fibres, causing lack of rubbing fastness. The deposit can usually be removed by boiling for one hour with 1 g/l of acetic acid (80 per cent) and 1 g/l of an emulsifying agent.

Basic dyes

Reference was made to the use of basic dyes for polyacrylonitriles in Chapter 14. Most of these fibres contain anionic sites at which the dye cations can become attached. The classical basic dyes have somewhat better light fastness on polyacrylonitriles than on other fibres because, it has been suggested, the polymer is so hydrophobic that moisture and oxygen, which are known to participate in fading, cannot gain access. Greatly improved light fastness has been obtained with more recent additions to the range of basic dyes which contain azo or anthraquinone groups in the cation:

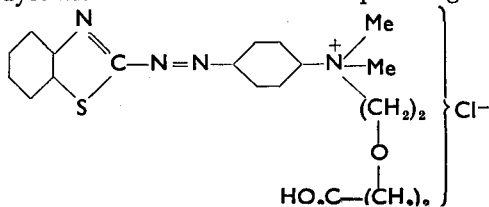

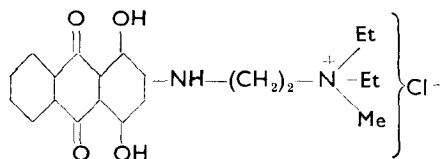

Balmforth et al. (*J.S.D.C.*, 1964, 80, 577) described an investigation on the mechanism of the attachment of basic dyes to the fibre. It was concluded that equilibrium adsorptions conform to the Langmuir equation. From this it was concluded that the reaction is one of ion exchange between the hydrogen ions associated with the anionic groups and the cations of the basic dye. The nature of the sites may well be determined by the catalyst used to promote polymerization of the polyacrylonitrile. The potassium persulphate/sodium bisulphite redox catalyst introduces sulphate or sulphonate end groups. Confirmation of this has been provided by the use of radioactive sulphur in the catalyst as well as by infra-red spectroscopy. On the other hand the amount of dye adsorbed exceeds that which can be accounted for by the sulphate or sulphonate end groups. The suggested explanation is that there are also weakly acid groups present, such as carboxyl, which do not attract the dye cations until all the hydrogen ions in the strongly acid groups have been replaced and that furthermore, they become active at higher pH values.

The basic dyes are applied from a liquor the pH of which is 5.5 for pale to medium and 4.5 for heavy shades. For the medium shades 1 g/l of acetic acid (80 per cent) will give the desired pH ; for heavy shades 1 g/l of acetic acid (80 per cent) and 1 g/l of sodium acetate will be required. It is also advisable to add 1 g/l of a non-ionic dispersing agent. In most cases there is very little adsorption of the dye below 75°C (167°F) and the critical range is from 80 to 100°C as shown in the graph in Fig. 23.12. It is therefore advisable to raise the temperature to 75°C quite rapidly (20 minutes) and then allow one hour for it to reach 100°C.

A few vat dyes, such as those in the following list, can be applied to polyacrylonitriles.

Durindone Pink FF	C.I. VAT RED 1
Ciba Red 3BN	C.I. VAT VIOLET 2
Sandothrene Brown G	C.I. VAT BROWN 5
Durindone Blue 4B	C.I. VAT BLUE 5

The dyes are vatted in the usual way and added to the dyebath, which is then adjusted to pH 10 by the addition of sodium bicarbonate, and the dyeing is carried out at 95°C (203°F). Oxidation of the pigment requires treatment with sodium percarbonate or perborate at 95°C (203°F) because the action of atmospheric oxygen is slow. The vat dyes offer an opportunity to dye a limited range of shades of excellent all-round fastness.

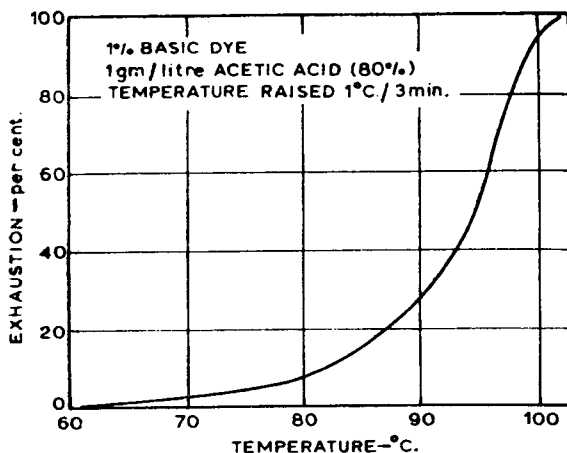
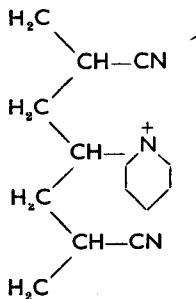

Fig. 23.12 A typical rate of uptake curve
(Courtesy of 'The Textile Manufacturer')

Considerable success has been obtained by applying metal-complex dyes at temperatures of 120° to 130°C (248° to 266°F) (Brit. Pat. 777534). The dyeing is carried out in the presence of an electrolyte such as common salt and it may be desirable to complete exhaustion with a little acetic acid. A good range of colours with excellent fastness to light and washing can be obtained. In spite of assertions that such high temperatures cause excessive shrinkages, the process has had a considerable measure of commercial success, its greatest field of application being in dyeing tow.

Acid dyes

Acrylonitrile can be polymerized with copolymers containing cationic groups such as, for example, vinyl pyridine to give a fibre with an affinity for anionic dyes.



The method of dyeing with acid dyes would be as follows:

- (1) Make up the dyebath with 2 per cent on the weight of the goods of sulphuric acid and a suitable levelling agent.

- (2) Run for 10 minutes at 38 °C (100 °F) and add the dye.
- (3) Raise the temperature to the boil over a period of 45 minutes and continue boiling for 30 minutes.
- (4) Cool to 88 °C (190 °F) and add a further 2 per cent of sulphuric acid.
- (5) Raise to the boil and dye at this temperature for 60 minutes.
- (6) If any additions are necessary, cool to 88 °C (190 °F) before making them.
- (7) When the dyeing is finished, cool the liquor to 71 °C (160 °F) with the goods in motion before the dyebath is run off.
- (8) Scour for 120 minutes at 60 °C (140 °F) with 1 per cent of soap and 0.5 per cent of soda ash.

2 : 1 Premetallized dyes

The dyeing procedure would be as follows:

- (1) Make up the dyebath with 1 per cent of formic acid and suitable assistants and run the goods in it for 10 minutes at 49 °C (120 °F) and add the dye.
- (2) Raise the temperature to the boil over a period of 45 minutes.
- (3) Boil for 60 minutes, and add between 0.5 and 2 per cent of sulphuric acid if necessary for exhaustion.
- (4) Cool to 88 °C (190 °F) for all shading additions.
- (5) When the dyeing is complete cool the liquor to 71 °C (160 °F) with the goods in motion before running the dyebath off.
- (6) Finally scour for 20 minutes at 71 °C (160-F) with 1 per cent of a non-ionic detergent and 0.5 per cent of soda ash.

With the 1 : 1 premetallized dyes the procedure is essentially the same with the exception that the liquor is made up initially with 2 per cent of sulphuric acid and the goods are run at 38 °C (100 °F) for 10 minutes before the dye is added. After boiling for 30 minutes the temperature is reduced to 88 °C (190 °F) and a further 2 per cent of sulphuric acid is added, or whatever amount is found to be necessary to bring about good exhaustion.

24 · Dyeing materials containing mixtures of fibres

THE advent of regenerated and synthetic man-made fibres has greatly increased the scope for making blends of two or more components. The oldest mixture of all is wool and cotton, which is used to make cloths known as unions. For this reason dyeing of mixtures of these two fibres is often referred to as union dyeing. There are three possible ways of dyeing mixtures of protein and cellulosic fibres:

- (i) Dyeing the protein or cellulosic fibre and leaving the other white. In union materials this is often referred to as dyeing 'wool way' or 'cotton way'.
- (ii) Dyeing both fibres the same colour, known as 'solid colour'.
- (iii) Dyeing the two fibres different shades, a procedure to which the term 'cross dyeing' is applied.

To dye the wool in a union without staining the cellulose, which may be either regenerated or natural, is comparatively simple. It is not very common for the wool to be dyed and the cellulose to be left white, but it is quite a general practice to incorporate a pattern constructed out of cellulosic yarns dyed in fast colours with an undyed wool background. The problem of dyeing such materials 'wool way' is the same as leaving the other component white, because a non-staining method must be used.

When wash-fastness is not important the molecularly dispersed acid dyes can be used. The normal method of dyeing with acid and Glauber's salt gives a good reserve provided dyes are selected which are known to be suitable for the purpose.

The molecularly dispersed acid dyes have poor wash-fastness and are not suitable for goods like men's socks which have usually had an unshrinkable treatment with the resultant adverse effect upon wet-fastness.

Better resistance to laundering and non-staining of cellulose is obtained with virtually all the premetallized dyes. The 1:1 chromium complex dyes should not be used under conditions when very high sulphuric acid concentrations are necessary because of the risk of degrading the cellulose. Many of the acid mordant dyes can be used with success.

The acid mordant and premetallized dyes are fast but lack brightness of shade. There are a number of fast acid colours which will dye wool and leave cellulose unstained when applied with ammonium sulphate or acetate.

Polar Brilliant Red G	C.I. ACID RED 85
Polar Brilliant Red BN	C.I. ACID RED 130
Carbolan Yellow R	C.I. ACID YELLOW 71
Carbolan Crimson 3B	C.I. ACID RED 139
Carbolan Blue B	C.I. ACID BLUE 138
Carbolan Green G	C.I. ACID GREEN 27

When molecularly dispersed or acid mordant dyes are applied, it is extremely important to rinse out mineral acid after dyeing in order to avoid the formation of hydrocellulose during storage. A good precaution is to give a final rinse with a little sodium carbonate. Formic or acetic acids are preferable because they volatilize during drying and in most cases they will give adequate exhaustion.

Dyeing the cellulosic fibre

Most of the direct dyes will stain wool either heavily or to a slight extent in a neutral dyebath, and if acid be present the protein fibre will develop a strong affinity for them. It is, therefore, by no means easy to dye 'cotton way' and it is a practice which should be avoided if possible. It is, however, sometimes necessary to dye the cellulosic component preferentially to the wool, particularly in the adjustment of a solid dyeing.

A good working rule is that at low temperatures direct dyes will exhaust on the cellulose in preference, but as the temperature approaches the boil they tend to be transferred to the wool. The pH of the dyebath is most important, slight alkalinity reserving the wool and the slightest trace of acid having the reverse effect. The usual method of dyeing the cotton with the minimum staining on the wool is to maintain the temperature between 40° and 60°C (104° and 140°F) and add 1 per cent of the weight of the goods of sodium carbonate. Unfortunately, when applied at such low temperatures, the wet-fastness of the direct dye is not good. There are wool-reserving agents such as Tanninol WR, a sulphonated complex product obtained by heating phenol with sulphur, Katanol W, or similar substances. In their presence it is possible to obtain good results with a greater range of dyes at 40° to 60°C (104° to 140°F) and with a few, the temperature can be taken up to 80°C (176°F), giving substantially improved wet-fastness. The quantity of Tanninol WR required varies from 2.5 per cent to 6 per cent of the weight of goods, the greater proportion always being employed at higher temperatures such as 80°C (176°F).

Cross-dyeing mixtures of protein and cellulosic fibres, which involves imparting two distinct colours, is not often practised. The best method is to dye the wool or silk first with an acid, acid mordant, or premetallized dyestuff, and then rinse till free from acid, preferably having previously neutralized with ammonia or sodium carbonate. The cellulosic component is next dyed with a selected direct dye in the presence of 1 to 6 per cent of Tanninol WR or Katanol W at 40° to 60°C (104° to 140°F). The addition

of 15 to 20 per cent of anhydrous Glauber's salt or common salt is recommended to assist in the exhaustion of the direct dye at this comparatively low temperature. The combination of shades in cross-dyeing should be such that the wool is the heavier, because it is practically inevitable that it will be stained to some extent by the direct dye.

Solid shades

The greatest proportion of union dyeing is in solid shades. It can be done in two stages when in the first place the wool is dyed with a molecularly dispersed or a fast acid dye. The acid is thoroughly rinsed out, using a little ammonia to assist. In the second stage the cotton is then dyed in the presence of Tanninol WR, Katanol W or similar products at a low temperature with one of the non-staining direct dyes. The method is time-consuming and matching is not easy, and it is now rarely used except in special cases when the desired shade can be matched in no other way.

There are a great number of union dyes available which are usually mixtures of neutral dyeing acid, and direct dyes, giving solid shades with careful manipulation of temperature and use of assistants. It is usually found that the cellulosic fibre dyes to a full shade at 60° to 70°C (140° to 158°F), and as the temperature approaches the boil an increasing amount of the dye is taken up by the protein fibre. At the boil some of the colour adsorbed by the cotton will be transferred to the wool so that, in time, the latter will become much heavier in shade. It is apparent, therefore, that a good solid result depends to a great measure upon control of temperature. It is usually necessary to add 5 to 20 per cent of common salt to promote exhaustion of the direct dye on the cellulose, and with heavy shades as much as 40 per cent may be necessary.

A common method is to bring the liquor in the dyebath to the boil so that the wool comes up to the desired shade, and then turn the steam off and continue dyeing in a cooling liquor, when the cotton takes up the dye. There is a danger, however, that the wool will continue to dye in the cooling liquor and finish up several degrees heavier than was intended. It is probably easier to get a good match on the two fibres if the cotton is first brought to the desired shade at 60° to 70°C (140° to 158°F), and then the temperature of the liquor is raised cautiously to the boil, if necessary, and is run off as soon as the wool matches. Constant supervision is of utmost importance because it is essential to stop the dyeing as soon as the two fibres match, otherwise the distribution of colour between them will very soon be disturbed. Slight corrections are often necessary with wool reserving direct dyes or neutral dyeing acid colours with no affinity for cellulose. The wet-fastness of the cellulosic component leaves much to be desired, and can be improved, to some extent, by after-treatment with cationic fixing agents.

Solid shades on unions with improved wet-fastness are dyed with mixtures of acid dyes and direct dyes capable of forming complexes with

metallic salts, but the range of colours includes no bright shades. The dyes are available as balanced mixtures and are dyed in the manner which has already been described for union dyes. They are then after-treated with 2 per cent of copper sulphate and 0.5 per cent of acetic acid at 60° to 75°C (140° to 167°F) for a period of 20 minutes.

To obtain bright shades of really good wet-fastness it is necessary to devise ways of using vat, azoic, or reactive dyes. Lemin and Collins (*J.S.D.C.*, 1959, 75, 421) point out that the wool, in a union with a cellulosic fibre, is less sensitive to damage by alkalis than it is alone. In the first place the total loss of strength of the material is diminished by the proportion of non-protein component, and secondly the latter acts as a scaffold supporting the structure even if there is some loss of strength suffered by the wool. The results quoted by Lemin and Collins show that, under controlled conditions of alkalinity, azoic dyes do not affect the physical properties of a 50/50 union and, although there may be some loss of abrasion resistance during the application of vat dyes, the decrease in tensile strength is negligible.

It was found that a solution containing 4 g per litre of both sodium hydroxide and sodium hydrosulphite caused no marked degradation of wool at 40°C (104°F) during an immersion lasting 45 minutes. As much as 6 g per litre of sodium hydroxide can, in fact, be used without significant effect but a working limit of 4 g per litre provides a good margin of safety. These conditions limit the selection of vat dyes to those with leuco-sodium derivatives which will form stable solutions in the alkali concentration specified and which will exhaust at 40°C (104°F). A further limitation is that only a few will give reasonably solid shades on the two fibres, but some assistance in this direction can be afforded by adding an acid milling colour to the washing-off liquor. Lemin and Collins (*loc. cit.*) quote the following vat dyes as being potentially capable of giving a useful range of colours.

Caledon Printing Yellow 6G	C.I. VAT YELLOW 27
Caledon Yellow 4G	C.I. VAT YELLOW 13
Caledon Gold Orange 3G	C.I. VAT ORANGE 15
Caledon Brilliant Orange 6R	C.I. VAT ORANGE 3
Caledon Pink RL	C.I. VAT RED 43
Caledon Brilliant Red 3B	C.I. VAT RED 10
Caledon Red Violet 2RN	C.I. VAT VIOLET 14
Caledon Brilliant Violet R	C.I. VAT VIOLET 17
Caledon Dark Blue G	C.I. VAT BLUE 16
Caledon Blue GCP	C.I. VAT BLUE 14
Caledon Jade Green XN	C.I. VAT GREEN 1
Caledon Jade Green 3B	C.I. VAT GREEN 4
Caledon Green 7G	C.I. VAT GREEN 16
Caledon Olive Green B	C.I. VAT GREEN 3

Caledon Brown R	C.I. VAT BROWN 3
Caledon Dark Brown 6R	C.I. VAT BROWN 38
Caledon Dark Brown 2G	C.I. VAT BROWN 49

The dye is vatted with three-quarters of the caustic soda and hydro-sulphite, and the goods are run with the remaining quarter for 10 minutes at 40°C (104°F) to ensure uniform pH and removal of adventitious oxidizing agents before the addition of the dye. An electrolyte is added with those vat dyes which normally require its addition to promote exhaustion, and sometimes a dispersing agent helps with pale shades. The leuco compounds are oxidized with sodium percarbonate or persulphate, and as an alternative hydrogen peroxide may be used. As with all vat dyes, a final soap scour is essential.

Azoic dyes can be applied to unions but there are many complications. An alkali concentration of 4 g per litre is sufficient to keep most of the coupling components in solution, and the application should be carried out cold in as short a liquor as possible. The coupling is accomplished in a separate bath with the diazotized base and 25 g per litre of common salt to prevent the coupling component from migrating into the liquor. Development requires 20 to 30 minutes, after which the material is acidified and scoured.

Dyeing unions with reactive dyes

Extremely good fastness on the cellulosic component can be obtained with reactive dyes. The cold dyeing members are preferable because the conditions of alkalinity and temperature necessary to fix the high-temperature reactive dyestuffs would be harmful to the wool. When Procion dyes are applied cold the protein fibre is left practically unstained, unless it has been chlorinated previously, and must be brought up to shade with neutral dyeing acid dyes such as those on page 575. The Procion dyes which have been found suitable are:

Procion Yellow M-RS
 Procion Brilliant Yellow M-6GS
 Procion Brilliant Orange M-GS
 Procion Brilliant Red M-2BS
 Procion Brilliant Red M-5BS
 Procion Scarlet M-GS
 Procion Blue M-3GS
 Procion Brilliant Blue M-RS

The thoroughly wetted-out goods are dyed in a cold liquor with the Procion dye and 15 to 20 parts per 1000 of common salt. Fixation on the cellulose is brought about with 1.5 to 3 parts per 1000 of trisodium phosphate in

the case of cotton or 1 to 3 for viscose rayon. The wool can be matched with acid milling dyes either in the final soaping bath or in a fresh liquor. The method is interesting because it offers a comparatively easy way of producing clear bright shades of excellent fastness. Some of the acid dyes which have been found suitable are quoted by Lemin and Collins (*J.S.D.C.*, 1959, 75, 424); a few examples are:

C.I. ACID YELLOW 70
 C.I. ACID REDS 111, 139, 239
 C.I. ACID BLUES 59, 112, 175
 C.I. ACID GREEN 28
 C.I. ACID BLACK 48

Dyeing mixtures of cellulose and cellulose acetate

As a generalization it can be stated that the disperse colours will not dye the cellulose, and the acetate has no affinity for direct dyes. Some selection of both disperse and direct dyestuffs is necessary for the best results.

The two dyes can be applied in the same dyebath but, to safeguard against the possibility of hydrolysis of the acetate, the temperature should not exceed 85°C (185°F).

Dyeing mixtures of cotton and regenerated cellulose

It is not easy to obtain identical shades on these two fibres when they are together in a fabric, because the regenerated cellulose has a greater proportion of amorphous regions, allowing more opportunity for dyestuff molecules to enter and attach themselves to cellulose chains. When mercerized cotton, with its greater affinity for dyes, is mixed with a regenerated rayon it is easier to obtain solid shades. With unmercerized cotton some dyes show greater contrast than others, and if two are used of which one gives a comparatively uniform shade and the other does not, the contrast will be exaggerated. The difference in shade is more noticeable in heavy than in pale colours, and can become unpleasantly apparent in navy blues and dark browns. Dyeing at a low temperature favours a relatively heavier shade on the cotton, and excessive use of salt increases adsorption by the regenerated cellulose.

Those direct dyes which are the best for yielding uniform shades are:

C.I. DIRECT YELLOW 50, 28, 44
 C.I. DIRECT ORANGE 37, 34, 1, 26
 C.I. DIRECT RED 81, 82
 C.I. DIRECT BLUE 78
 C.I. DIRECT BLACK 51, 59

Dyeing mixtures of polyamide and cellulosic fibres

Either disperse dyes or, preferably, selected acid dyes will reserve the cellulosic fibre, and the polyamide will not be dyed by a limited number of direct dyes, provided the temperature does not exceed 90°C (194°F) and the dye liquor is maintained in a slightly alkaline condition. There are also a few direct dyes which will give a solid shade on the two fibres at a pH of 4 to 5, examples of which are as follows:

- C.I. DIRECT YELLOW 8, 9, 46
- C.I. DIRECT ORANGE 1, 8, 12, 23
- C.I. DIRECT BROWN 1, 25
- C.I. DIRECT RED 1, 21

There are some direct dyes, such as those listed below, for which polyamides have very little affinity, especially in a slightly alkaline dyebath. These are useful for correcting the shade of the cellulosic component if this should be necessary.

- C.I. DIRECT YELLOW 50
- C.I. DIRECT RED 81
- C.I. DIRECT BLACK 71
- C.I. DIRECT BLUE 1

There are a number of acid dyes as well, which in a neutral liquor will dye the polyamide without staining the cellulose and can correct the shade of the polyamide.

*Acid dyes with an affinity for polyamides in neutral solution
which do not stain cellulose*

- C.I. ACID YELLOW 36, 72
- C.I. ACID RED 88
- C.I. ACID BLUE 25, 67, 78, 138
- C.I. ACID BLACK 48

The wet fastness of the direct dye on the cellulosic component, however, will not stand up to vigorous washing conditions.

Dyeings of very good fastness can be obtained in a one-bath method. The polyamide fibre is dyed with a procinyl dye and the cellulosic fibre with a monochlorotriazinyl dyestuff. The dyeing is carried out for one hour at a temperature not exceeding 85°C (185°F) in a liquor containing 100 g/l of common salt. After one hour trisodium phosphate (crystalline) equivalent to 15 g/l is added to bring about the fixation of the reactive dyes.

Dyeing wool and polyamide mixtures

Many of the molecularly dispersed acid dyes will give solid shades on wool and polyamide fibres. There is usually a tendency for the nylon 66 to

dye a heavier tone in pale shades, but the contrast diminishes with heavier dyeings. The uniformity of the colour on the two fibres can be improved by careful selection of the dyes and by addition to the dyebath of sulphonated products such as Calsolene oil HS and Erional NW to restrain adsorption by the polyamide.

Nearly all the premetallized dyes, as well as many of the acid mordant colours, give solid shades with good wet- and light-fastnesses on nylon 66 and wool mixtures. The 1 : 2 are preferred to the 1 : 1 metal complex dyes because it is not necessary to use such a strongly acid dye liquor. In the case of the 1 : 1 complexes the dyebath is made up with 10 per cent of Glauber's salt and 8 per cent of sulphuric acid (168°Tw). Dyeing is commenced at 60°C (140°F) and the temperature is raised slowly to the boil at which it is maintained for 1½ hours. It is important that, after dyeing, the acidity should be neutralized by rinsing in a 1 to 2 ml per litre solution of ammonia.

The 1 : 2 metal complex dyes are generally applied with 5 per cent of ammonium sulphate but as an alternative dyeing can be commenced in a neutral liquor which is brought to the boil slowly, after which dyeing is continued for 45 minutes before exhaustion is completed by the addition of 1 per cent of formic acid (85 per cent).

The after-chrome dyes can be used but they have to a large extent been replaced by the premetallized dyestuffs. They are applied from a liquor containing 5 to 10 per cent of Glauber's salt and 3 per cent of ammonium acetate. Dyeing is commenced at 40°C (104°F) and the temperature raised to the boil during a period of one hour. After the dyebath has boiled for 30 minutes, 3 to 4 per cent of formic acid (85 per cent) is added gradually to complete exhaustion. It is important to ensure that there is virtually no dye left in the liquor before chroming in order to avoid precipitation of the lake on the surface of the fibres. For mordanting, the temperature is dropped to 80°C (176°F) and 1 to 2 per cent of potassium dichromate is added. The temperature is then raised to the boil again and chroming continued for 30 minutes. Finally 3 per cent of sodium thiosulphate is added and boiling is continued for a further 20 minutes.

Dyeing mixtures of polyester and other fibres

The polyesters have no affinity for direct dyes, and the cellulose is not stained by many of the disperse dyes. It is, therefore, comparatively simple to match the two fibres using the appropriate class of dye for each. If the shades are of medium depth or heavier, a carrier will have to be used to increase the rate of exhaustion of the disperse dye on the polyester. When dyeing heavy shades at above 100°C (212°F) care must be taken to select direct dyes which will be stable.

When better wet-fastness is required on the cellulosic component, especially necessary in deeper shades, it is desirable to dye the polyester with a

disperse colour first, then give a reduction clear with $1\frac{1}{2}$ lb of sodium hydroxide, 2 lb of sodium hydrosulphite per 100 gallons, and a dispersing agent at 70° to 75°C (160° to 170°F). The cellulosic fibre is then dyed with a metal after-treated direct dye or a vat dye, in which case the intermediate reduction clearing may be omitted.

Imperial Chemical Industries Ltd (*Dyehouse circular* No. 576) have described continuous processes for dyeing fast colours on cellulosic and polyester mixtures. Pale shades may be padded with a solution containing Soledon dyes together with:

0.5	parts of sodium carbonate	per 100 gallons		
5.0	„ „ sodium nitrite	„ 100	„	..
0.5	„ „ Perminal PP	„ 100	„	

and then, without drying, the material is repadded with a solution of sulphuric acid of the concentration required by the dyestuff, after which it is soaped before finally being dried. Alternatively the padding mixture can contain disperse dye, reactive dye, sodium bicarbonate, or carbonate and, for heavier shades, some urea to give improved fixation. The sequence of operations in this case is pad, dry, and heat. Some disperse dyes react with the mono- or dichlorotriazinyl dyestuffs, and this should be borne in mind in making up the recipes. It is also possible to obtain a limited number of shades with vat dyes. A few will give a reasonably solid colour on both fibres, but it is usual for the cellulosic component to dye a heavier shade, and for the colour of the polyester to be adjusted by the inclusion of disperse dyes in the recipe.

The Thermosol process (Chapter 23) is applied extensively to the continuous dyeing of cloth made of blends of polyester and cellulosic fibres.

Dyeing polyester and polyamide mixtures

This is not easy because the disperse dyes will always be adsorbed more heavily by the polyamide. There are a few disperse dyes which give a reasonably solid colour when a carrier is used. The tendency is for the polyamide to dye a heavier shade at the commencement, and for the dyestuff to become transferred to the other fibre on prolonged boiling.

If it is not possible to select dyestuffs which will give a solid result on both fibres, it is necessary to dye in the presence of 4 to 8 per cent of carrier until the polyester is on shade. The polyamide is then stripped with sodium hydrosulphite or zinc formaldehyde-sulphoxylate and acetic acid at the boil, leaving the other fibre unaffected because, on account of its hydrophobic nature, the entry of the hydrosulphite into the polyester is extremely slow. It is, of course, important to select dyestuffs which will reduce easily to colourless compounds. The nylon can then be dyed to

contrast with, or to match, the Terylene with acid or premetallized dyes which reserve the latter fibre.

Dyeing polyester and wool unions

Virtually only the disperse dyes are available for the polyester, but they stain the wool quite heavily on which they are only surface deposited, with the result that rubbing-fastness leaves much to be desired. It has, however, been found that after dyeing, the wool can be cleared effectively with a dilute solution of potassium permanganate. The recommended method is to treat in a cold liquor containing 0.2 to 0.3 lb of potassium permanganate per 100 gallons of water, and then, after 10 minutes, $\frac{1}{2}$ lb per 100 gallons of previously well-diluted sulphuric acid is added, and the temperature raised to 40°C (104°F). After a further 10 minutes at this temperature 1 lb per 100 gallons of sodium bisulphite liquor is added, to remove the brown stain caused by the manganese dioxide which has been deposited on the material. Partridge (*J.S.D.C.*, 1959, 75, 377) suggests that the most suitable dyes are:

C.I. DISPERSE YELLOW 39

C.I. DISPERSE RED 11

C.I. DISPERSE ORANGE 1

C.I. DISPERSE BLUE 26

In the case of the pale shades the two fibres can be dyed in the same liquor with a disperse and an acid milling or a premetallized dye, and subsequently cleared with permanganate in the manner described in the previous paragraph. With dark colours it is better to dye the polyester first then clear the wool with sodium hydrosulphite, ammonia, and a non-ionic dispersing agent, and finally match the protein fibre with acid or premetallized colours. It must be borne in mind that when after-chrome dyes are used, some disperse dyestuffs are modified by the dichromate, with a change of colour. C.I. DISPERSE RED 11 (Cibacet Brilliant Pink 4BN) and C.I. DISPERSE RED 15 (Duranol Red 2B) are particularly susceptible, and C.I. DISPERSE RED 13 (Cibacet Rubine R) should be substituted.

Dyeing mixtures containing polyacrylonitriles

The commonest union is a mixture of wool and a polyacrylonitrile. The dyeing is carried out with cationic and fast acid dyes. Light shades can be treated by a single-bath method. The liquor is adjusted to pH 4 to 5 with 1 g/l of sodium acetate and 1 ml/l of acetic acid (80 per cent). The temperature is raised to 40°C (104°F), and 1 g/l of a non-ionic dispersing agent is added followed by the cationic and acid dyes separately, in order to avoid mutual precipitation. The temperature is raised to 70°C (158°F) over a period of 20 minutes and then more slowly, taking 45 minutes over the critical range for the acrylic fibre between 70°C (158°F) and 100°C (212°F). Dyeing is then continued for a further 1 to 1½ hours after which

if any additions are necessary to correct the shade the dyebath should be cooled down to 80°C (176°F). After the addition the temperature should be raised to the boil in 20 minutes, and then a further 20 minutes will be required to ensure levelness. An alternative method, often preferred for medium or dark shades, is to dye the acrylic fibre first with the basic dye, then to cool the dyebath down to 50°C (122°F) and add the acid dyes required to bring the wool up to shade.

Dyeing unions of acrylonitriles and cellulosic fibres

The acrylic component can be left undyed quite easily because it has no affinity for those direct dyes which are classified as acetate reserving. There are also many diazotized and developed direct, as well as vat dyes which will dye the cellulose only. Disperse dyes can be used for acrylonitrile fibre, but they will stain the cotton or rayon component, and clearing with a solution containing 8 oz to 1 lb of potassium permanganate and 2 oz of sulphuric acid per 100 gallons at 30°C (86°F) for 15 minutes, will probably be necessary. The oxides of manganese will subsequently have to be removed with sodium bisulphite.

The cationic dyes will be adsorbed by the acrylic fibre from a liquor containing 2 per cent of glacial acetic acid, but the cellulose may be stained. Effective clearing is often achieved by treatment with 1 lb of potassium permanganate and 2 oz of glacial acetic acid at 40° to 50°C (104° to 122°F) for 20 minutes, followed by the addition of sodium bisulphite to remove the discoloration. In some cases the results are better when the material is boiled for 30 minutes with 1 per cent (of the weight of the goods) of sodium hydrosulphite and 1 per cent of formic acid. The cellulosic component is then dyed to the desired shade with selected direct dyes, bearing in mind that many of the cationic dyes are very much brighter.

A single-bath method can be used if desired. The dyes are dissolved separately and added to the dyebath which already contains an ethylene oxide condensate which acts as an anti-precipitant. The dyebath is adjusted to pH 5 to 5.5 with acetic acid and sodium acetate and the goods are entered at 40 to 45°C (104 to 113°F). A period of 45 minutes is taken to raise the temperature to the boil, at which it is maintained for one hour. Alternatively, the acrylic fibre may be dyed first and then the same liquor is neutralized and the cellulosic fibre is dyed. Application of a cationic fixing agent improves wet fastness of direct dyes but copper after-treatment should be avoided because this can have an adverse effect on the light fastness of the cationic dye. Very good fastness is obtained if, after the acrylic component has been dyed, the cellulosic fibre is brought to shade with vat dyes.

If better wet-fastness is required the polyacrylonitrile may be dyed with a cationic dye, and the cellulose then either matched or cross-dyed with a reactive dyestuff. In such cases an oxidation or reduction clear is not neces-

sary because the same purpose will be achieved by the alkali during the fixation stage. It is not possible to apply the reactive dyes to the cellulose first, because they act as mordants for the cationic dyestuffs with a profound effect upon the shade (KRAMRISCH, *J.S.D.C.*, 1959, **75**, 366). A single-bath process is possible when the dyebath is made up with the cationic and the hot dyeing reactive dyes and 2 per cent of glacial acetic acid. After dyeing for 30 to 45 minutes at the boil the liquor is cooled to the temperature specified for the reactive dye, and the appropriate quantity of common salt is added. Dyeing is then continued during a further 45 minutes, after which fixation is brought about by the addition of 10 to 15 g per litre of trisodium phosphate retaining the temperature at 95°C (203°F) for an additional three-quarters of an hour. As with all reactive dyes, a final washing-off is necessary to remove loosely retained products of hydrolysis of the chlorotriazinyl groups (KRAMRISCH, *loc. cit.*).

Blacks present some difficulty because they cannot be produced satisfactorily by most conventional methods. The best results are obtained by a modified azoic process. A dyebath is made up with 2 per cent (of the weight of the goods) of Cibacet Diazo Black HD, and 3 per cent of Cibaphthol RTO (C.I. AZOIC COUPLING COMPONENT 18). The material is dyed with these products at the boil for 45 minutes and then rinsed. A cold liquor is made up containing 8 per cent of sodium nitrite and 14 per cent of hydrochloric acid (32 per cent), and the temperature is raised gradually to 85°C (185°F) at which it is maintained for 30 minutes. The cellulose will only be stained, and may be cleared with sodium hydrosulphite and formic acid, after which it is dyed with a copper after-treated direct black.

Dyeing mixtures of polyacrylonitriles and polyamides

Disperse dyes are not suitable because the polyamide is dyed much more heavily than the acrylic. The cationic dyes can be applied with 5 per cent of Glauber's salt at pH 4.5 adjusted with acetic acid, at the boil. The polyamide will only be slightly stained, if at all. The latter fibre can be cleared, if necessary, with potassium permanganate and glacial acetic acid (1 lb and 2 oz per 100 gallons respectively) at 25°C (77°F), followed by treatment with sodium bisulphite.

The liquor is then partially run off and the vessel refilled to bring the temperature down. The pH is adjusted to 5.5 and the polyamide is dyed with premetallized or acid dyes, which will not stain the acrylic.

Polyester and acrylic blends

The only dyes available are disperse for the polyester and cationic for the polyacrylonitrile. It is not possible, however, to obtain a reserve effect on either of the fibres because there is a certain amount of cross-staining. The goods are first dyed with the basic dyes in the customary manner and the dyebath is then cooled to 75°C (167°F) and the disperse dyes are added

together with a carrier. Finally the material is scoured at 80°C (176°F) with 1 per cent of ammonium hydroxide and sodium hydrosulphite. Alternatively, the polyester can be dyed first with a carrier and, after scouring, the basic dyes applied. The cationic dyes may, however, cause some staining of the polyester but this can be removed by mild treatment with sodium hypochlorite.

25 · Testing dyed materials

THE outstandingly important property of a dyed material is the fastness of the shade. It has not been easy to find a means of expressing fastness in unequivocal terms, because any simple and universally applicable assessment of alteration of colour must be based on subjective judgement. A number of tests are necessary to cover all the important properties of any one dye because good fastness to one influence is not necessarily accompanied by equal fastness to exposure to other conditions. Tests may be divided into those of consumer significance, such as light, wash, and salt-water staining, and those concerning only the producer, such as fastness to cross-dyeing or unshrinkable treatments.

There was, at one time, an unfortunate lack of uniformity in methods of testing and expression of fastness. It was for the purpose of bringing about greater uniformity that the Fastness Tests Committee of the Society of Dyers and Colourists was set up in 1927, and it did much to co-ordinate methods of testing within the field of the Society's influence. There was, however, little international uniformity and in 1947 the International Organisation for Standardisation (I.S.O.) formed a colour-fastness sub-committee. On account of its international nature the I.S.O. cannot impose its decisions, and the term I.S.O. Recommendation is therefore used for a test upon which final agreement has been reached.

The fastness of a dye is related to the depth of the shade. If a dyed sample be exposed to light the number of molecules which will be modified during a specified period will be the same, irrespective of the percentage of dye on the fibre. The proportion of those present which are decomposed is therefore much greater in a pale shade. It is not possible to standardize dyeings for testing on a percentage basis because of the variations in strengths of dyestuffs. A range of standard depths in 18 hues has been prepared and is available (from the Society of Dyers and Colourists), known as the 1/1 standard depth series. This should be matched, as closely as possible, when preparing the sample for testing. The use of 1/1 range is recommended whenever possible, but the 2/1 standard depth is twice as strong and weaker ones available are the 1/3, 1/6, 1/12, and 1/25, respectively.

Assessment of fastness involves a visual determination of either change in shade or staining of an adjacent material. An entirely subjective description such as good, moderate, or poor has no value. The first effort to introduce greater precision was the pass/fail tests. The specimen was subjected

to a number of tests of increasing severity, and passed as long as no alteration was apparent, the fastness being expressed as the number of the most severe test which the dyeing passed. The method was tedious in use and its sensitivity was poor. It is not surprising, therefore, that the use of dyed standards found favour.

A series of dyes was specified as corresponding with grades of fastness ranging from 1 to 8 for light and 1 to 5 for other tests. Materials dyed to specified strengths with these colours were tested simultaneously with the sample, and the standard which showed the same change of shade or staining indicated the grading. The method was not entirely satisfactory on account of the large number of standard samples which became necessary.

Most of the difficulties are overcome by the use of grey scales against which it has been found possible to compare loss of colour or staining of any hue irrespective of depth. It is necessary to use two scales, one for assessing change in colour and the other for staining.

The graduations of the grey tones in the scales are defined in N.B.S. (National Bureau of Standards) units, one unit being defined as the smallest difference in depth which is of commercial significance. The original scales were constructed on arithmetically spaced differences in depth. Thus if ' n ' be an arbitrary number of N.B.S. units, the arithmetically constructed scales will be as follows:

<i>Fastness grade</i>	<i>Contrast before and after test</i>
5	0 N.B.S. units
4	n N.B.S. units
3	$2n$ N.B.S. units
2	$3n$ N.B.S. units
1	$4n$ N.B.S. units

McLaren (*J.S.D.C.*, 1952, 68, 203) pointed out that the arithmetic scale was not entirely satisfactory, especially as it did not show up sufficiently well comparatively small differences in the 3, 4, and 5 gradings, and the faster the dye, the more significant are the minor changes. In this respect the geometric scale, in which the steps are closer at the top fastness end, is more satisfactory, and this is now used in the I.S.O. recommended tests.

Geometric scales

<i>Grade</i>	<i>Contrast before and after test</i>	<i>I.S.O. recommended scale</i>
5	0 N.B.S. units	0 N.B.S. units
4	n N.B.S. units	1.5 N.B.S. units
3	$2n$ N.B.S. units	3 N.B.S. units
2	$4n$ N.B.S. units	6 N.B.S. units
1	$8n$ N.B.S. units	12 N.B.S. units

For assessing the staining of adjacent white material a different grey scale is necessary, and it was again found that a geometric graduation was most

satisfactory. After much consideration the following I.S.O. Recommendation was issued:

<i>Colour differences in N.B.S. units</i>	<i>Fastness rating</i>
0	5
4	4
8	3
16	2
32	1

In the change in colour scale (Fig. 25.1), the greys are mounted in pairs,

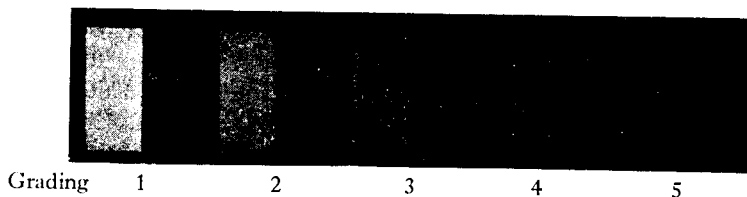

Fig. 25.1 Grey scale for alteration of colour

one of the two always being the original unaltered depth and the other differing by 1.5, 3, 6, and 12 N.B.S. units. The original dyed material and the tested sample are placed side by side, orientated in the same direction on a uniformly-grey field slightly darker than the equivalent of 5 on the scale. With thin materials it is advisable to use two or more layers to avoid penetration of the dark background colour of the field. The scale is placed adjacent and the surfaces are illuminated with north light (south light in the Southern Hemisphere) incident at 45° and not less than 50 lumens per square foot. The materials and scale are viewed perpendicularly and the fastness rating is determined by that pair on the scale which show a contrast equal to that between the original pattern and the tested portion. Where there is a change of hue as well as loss of colour the nature of the alteration is indicated after the grading thus:

3 redder	or 3 R
3 bluer or duller	or 3 Bl or 3 D
4 yellower	or 4 Y

The grey scale for staining (Fig. 25.2) is used in exactly the same way on a

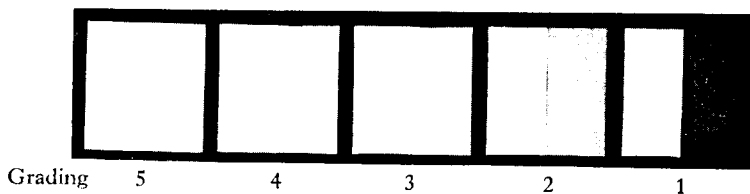

Fig. 25.2 Grey scale for staining

surrounding field of grey slightly darker than the deepest shade on the effect on colour scale.

Determination of light fastness

Exposure to daylight is a test of the behaviour of the sample under actual conditions of use, but takes a long time. Sources of light with spectral distribution as near as possible to daylight give quicker results but do not necessarily provide a precise prediction of behaviour during use.

The I.S.O. Recommendation for daylight exposure specifies that the sample should be tested together with standard dyed wool samples of light-fastnesses 1 to 8 respectively. The fastness is determined by ascertaining which of the eight standards has faded to the same extent. In this test the grey scale cannot be used without reference samples for measurement when daylight is the source of illumination, because the intensity and amount of incident light will differ every time and the standards must always be exposed simultaneously.

The standards which are dyed as follows can be obtained from the British Standards Institution.

<i>Fastness rating</i>	<i>Dye</i>	<i>C.I. number</i>
1	Acilan Brilliant Blue FFR	ACID BLUE 104
2	Acilan Brilliant Blue FFB	ACID BLUE 109
3	Coomassie Brilliant Blue R	ACID BLUE 83
4	Supramine Blue EG	ACID BLUE 121
5	Solway Blue RN	ACID BLUE 47
6	Alizarine Light Blue 4GL	ACID BLUE 23
7	Soledon Blue 4BC powder	SOL. VAT BLUE 5
8	Indigosol Blue AGG	SOL. VAT BLUE 8

The specimens are mounted in a frame facing south in the Northern Hemisphere and north in the Southern Hemisphere at an angle approximately equal to the latitude of the place where the exposure is made. The rack should be placed so that no shadows fall on it, and the specimens must be protected against rain by a glass sheet not less than 5 cm away and supported in such a manner that the samples are well ventilated. One-half of each sample and standard is covered with an opaque sheet of cardboard or aluminium, leaving the other half exposed.

The specimen and controls remain in the frame 24 hours per day until sufficient fading has occurred for a good comparison to be made with the standards. The ideal way of carrying out the test is to mount the standards and specimen as shown in Fig. 25.3 with a hinged opaque cover, and expose until the contrast between the covered and exposed portions of the specimen is equivalent to grade 4 on the change of colour grey scale. At this stage cover up a second previously-exposed portion of the patterns with an opaque screen *CD* and continue to expose until the contrast between the

continuously illuminated and completely shielded portions are equal to grade 3 on the grey scale, unless standard 7 has previously faded to grade 4 when the test may be terminated. The specimen and standards will show

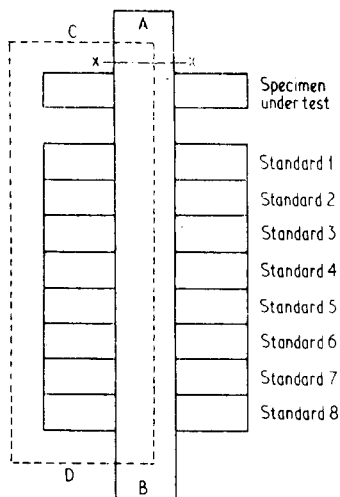

Fig. 25.3 Mounting of specimen and standards for testing fastness to light

(I.S.O. Recommendation R102)

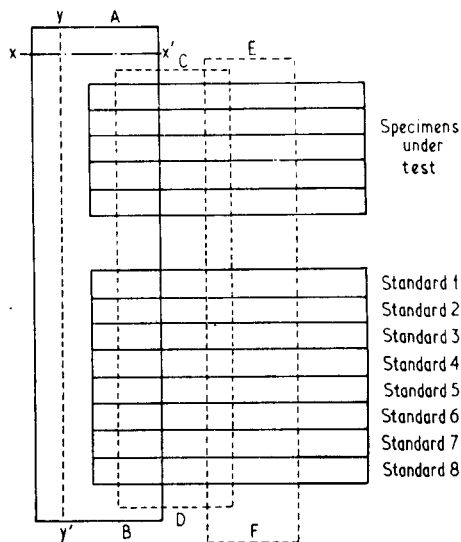

Fig. 25.4 Mounting of a number of specimens and standards for testing fastness to light

(I.S.O. Recommendation R102)

three zones with the unexposed area in the middle. The zones are compared with the standards and, if the two degrees of fading on the specimen do not correspond with the same standard, the fastness would be the mean between the two.

When a number of samples are to be tested the arrangement in Fig. 25.4 is more convenient. The card *AB* covers one-quarter of all the samples and standards. The standards are inspected at intervals until an alteration of shade in standard 3 is just perceived, at which stage the specimens with fastnesses not greater than 3 are assessed. The card *AB* is then replaced in

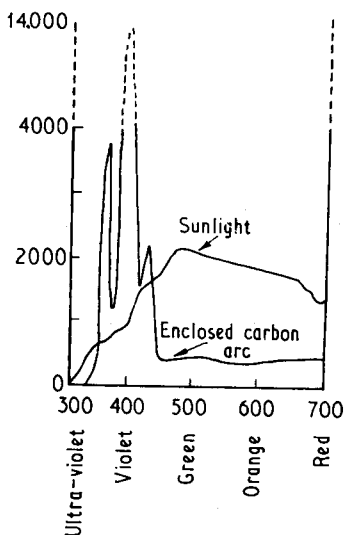

Fig. 25.5 Spectral energy distribution of daylight and carbon arc (McLAREN, 'J.S.D.C.', 1954)

lamps which, in the past, gave a spectral energy distribution curve not unlike daylight were the enclosed carbon arc, such as the Fugitometer and the Fadeometer. The spectral energy distribution curve of these lamps, compared with daylight, is shown in Fig. 25.5 (McLAREN, 'J.S.D.C.', 1954, 70, 554). It is at once apparent that there are great divergences in the artificial source in the ultra-violet and violet regions. With such lamps it was possible to make useful light-fastness assessments of many colours but others, particularly those sensitive to violet or ultra-violet light, reacted very differently when exposed to daylight and to the lamp. It was found that the carbon arc tended to heat the surface of the fabric. Provided the relative humidity of the surrounding atmosphere remains constant, there is a tendency for dyes to fade faster at higher temperatures. The effect is much more marked with some dyes than

exactly the same position as it was before and exposure is continued until a change in standard 4 is just perceptible when the opaque shield *CD* is placed in the position indicated in Fig. 25.4, overlapping *AB*. Exposure is then continued until standard 6 shows initial fading. At this stage the cover *EF* is placed in the position indicated, overlapping *CD*, and the specimens are replaced in the frame until a contrast in standard 7 equal to grade 4 on the change of colour grey scale makes its appearance or, alternatively, until the fastest specimen has faded to an extent equal to grade 3 on the grey scale. Comparisons with standards are then made as described in the previous paragraph.

When daylight is used fading is slow and a quicker answer is often necessary under commercial conditions. The

with others (CUNLIFFE, P. W., *J.S.D.C.*, 1956, **72**, 330). Humidity, however, has a greater influence on the rate of fading than temperature. In the graphs below (LEAD, *J.S.D.C.*, 1949, **65**, 725) the action of light on

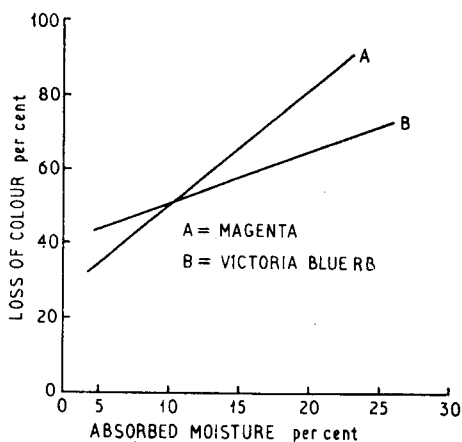

Fig. 25.6 Effect of moisture on light fastness

Magenta and Victoria Blue RB are related to different moisture contents of the substrate corresponding with varying relative humidities of the surrounding atmosphere. It is interesting to note that with 5 per cent absorbed moisture (in equilibrium with atmosphere at 50 per cent relative humidity) Victoria Blue RB fades faster than Magenta, but the reverse is the case with 20 per cent absorbed moisture (100 per cent relative humidity). Lead (*loc. cit.*) reports that with cellulosic materials a change of relative humidity from 45 per cent to 80 per cent increases the rate of fading by approximately 50 per cent with a large number of dyes.

The relationship, between relative humidity and light fastness is also reviewed by McLaren (*J.S.D.C.*, 1963, **79**, 618). Specimens of red cotton dyed with an azoic dye, known to be moisture sensitive with regard to light fastness, were exposed, together with standards in constant-humidity sealed vessels. The results of these experiments are shown graphically in Fig. 25.7. It will be noticed that on the light fastness ordinate, 6-7 appears where 7 would normally be expected. This is because up to standard 6, each grading is twice as fast as the one below, but standard 7 is four times as fast as 6.

The point emphasized by McLaren is that it is not the relative humidity of the ambient atmosphere that is the determining factor but the relative humidity and the temperature at the surface of the material. This is always lower than that of the surrounding atmosphere because the surface temperature of the specimen is increased by absorption of radiation. Exact

measurement of the relative humidity at the surface, under normal testing conditions, is virtually impossible, but bleached cotton dyed with C.I. Azoic Coupling Component 4 and developed with C.I. Azoic Diazo

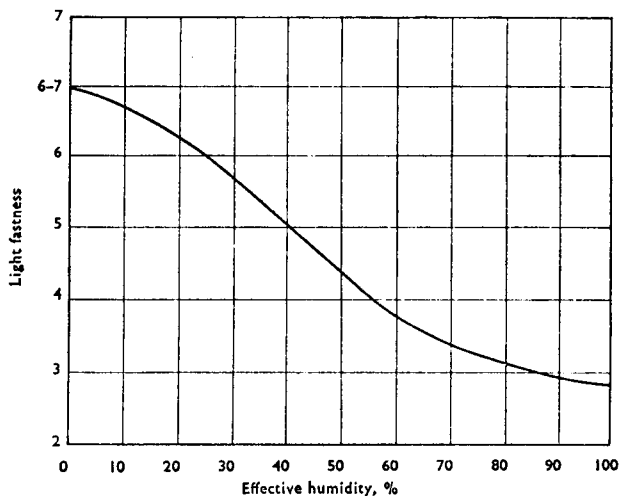

Fig. 25.7 Dependence of azoic dyed cotton light fastness on relative humidity

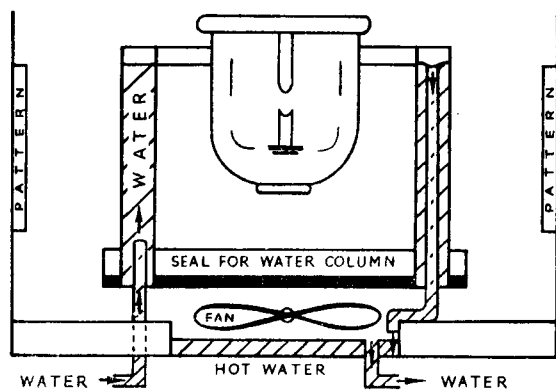

Fig. 25.8 Constant humidity enclosed arc fading lamp
(*Hexagon digest*, I.C.I.)

Component 13 has a known fastness and relative humidity relationship. This can be used for standardizing exposure lamps or as a control for testing simultaneously with the specimens under investigation.

These facts account for the anomalous fading which often occurs when goods are exposed behind glass windows in static atmospheres where relative humidities may become abnormally high. Enclosed arc fading lamps should, therefore, have means of maintaining constant relative humidity, and the specimens should be screened from heat or excessive infra-red radiation, associated with such sources of illumination. A simplified diagrammatic representation of a lamp surrounded with a water-screen and a water-bath and fan at the bottom to maintain constant humidity is shown in Fig. 25.8 (*Hexagon digest*, No. 3). Details of various lamps may be found in the Society of Dyers and Colourists' publication, *Standard methods for the determination of the colour fastness of textiles*, 1960, p. 57.

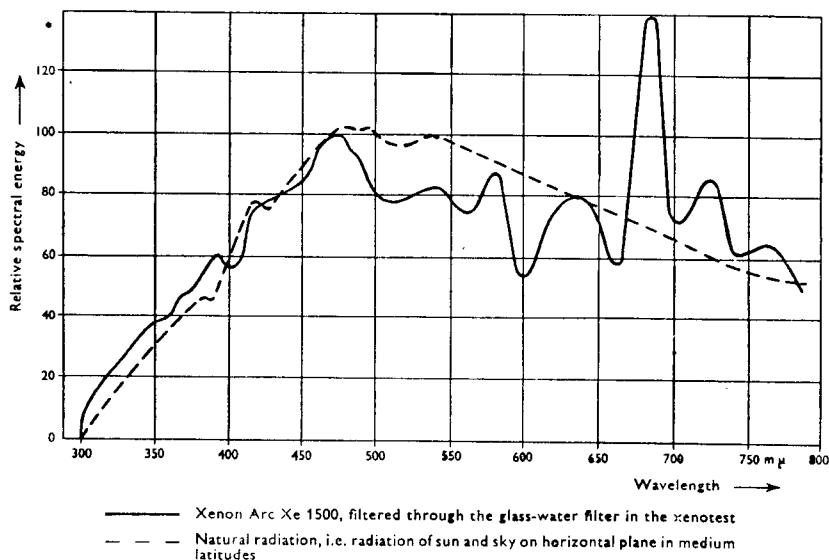

Fig. 25.9 Reproduced from pamphlet published by Quarzlampen G.m.b.H., Hanau, W. Germany

Great progress has been made during recent years by the introduction of the Xenon arc lamp used in the Xenotest lamps. The spectral energy curves of sunlight and the light emitted by the Xenon arc lamp are shown in Fig. 25.9 (MCLAREN, *Hexagon digest*, No. 27). A tentative test has been specified by I.S.O. making use of the Xenon lamp. The mounting of patterns together with standards and the procedure for assessing fastness are similar to the two methods described for exposure to daylight.

Fastness to washing

This is of great importance to the consumer, and there are several washing tests which are applied according to the purpose for which the material is intended.

There are five draft proposals for I.S.O. Recommendation for washing tests

I.S.O. Test No. 1 was formerly the hand washing test (S.S. 2680: 1961)

I.S.O. Test No. 2 was formerly S.D.C. test No. 2

I.S.O. Test No. 3 was formerly Mechanical washing test A

I.S.O. Test No. 4 was formerly Mechanical washing test B

I.S.O. Test No. 5 was formerly S.D.C. test No. 4 (S.S. 2685: 1961)

Tests Nos. 1, 2, and 3 are carried out in the following manner:

A specimen measuring 10 cm × 4 cm of the material to be tested is cut out. Yarn is knitted into a fabric from which a piece of the same dimensions can be obtained, and loose fibre is compressed into a sheet measuring 10 cm × 4 cm.

The specimen to be tested is placed between two pieces of undyed fabric measuring 5 cm by 4 cm and the three pieces are held together by stitching round the edges, leaving 5 cm × 4 cm exposed. In the case of the loose fibre the compressed mass is held in place by sewing it between pieces of cloth measuring 10 cm × 4 cm.

The composition of one of the colourless materials enclosing the specimen will be the same as the dyed sample and the other will be as indicated below:

<i>If the first piece is</i>	<i>The second piece will be</i>
Cotton	Wool
Wool	Cotton
Silk	Wool
Linen	Wool
Viscose	Wool
Cellulose acetate	Viscose
Polyamide	Wool or viscose
Polyester	Wool or cotton
Acrylic	Wool or cotton

A solution is made containing 5 g per litre of soap conforming with the following specification:

Free alkali calculated as Na_2CO_3	0.3 per cent maximum
Free alkali calculated as NaOH	0.1 per cent maximum
Total fatty matter	85 per cent minimum
Titre of mixed fatty acids contained in the soap	30°C (86°F) maximum

I.S.O. Recommendation No. 1

The composite specimen is treated in a wash wheel (Fig. 11.12, Chapter 11) or an equivalent apparatus at $40^{\circ} \pm 2^{\circ}\text{C}$ ($104^{\circ} \pm 3.6^{\circ}\text{F}$) for 30 minutes, using sufficient of the soap solution to give a liquor ratio of 50:1.

I.S.O. Recommendation No. 2

The composite sample is treated in a wash wheel or equivalent apparatus for 45 minutes at $50^{\circ} \pm 2^{\circ}\text{C}$ ($122^{\circ} \pm 3.6^{\circ}\text{F}$), using sufficient of the soap solution to give a liquor ratio of 50:1.

I.S.O. Recommendation No 3

To the soap solution 2 g per litre of anhydrous sodium carbonate are added. The composite sample is then treated in a wash wheel or equivalent apparatus at $60^{\circ} \pm 2^{\circ}\text{C}$ ($140^{\circ} \pm 3.6^{\circ}\text{F}$) for 30 minutes in sufficient of the above solution to give a liquor ratio of 50:1.

After treatment the composite samples are in every case rinsed twice in cold distilled water and then for 10 minutes in cold running tap water. After squeezing, the stitching is removed on the two long sides and one short side, leaving the dyed specimen and the undyed materials sewn together only along one short side. The pieces are opened out and dried in air at a temperature not above 60°C (140°F).

The change in colour of the uncovered portion of the specimen is assessed with grey scale No. 1 and the staining of the undyed materials with grey scale No. 2.

I.S.O. Recommendation No. 4

The dyed specimen, measuring $10\text{ cm} \times 4\text{ cm}$ as before is sewn together with two pieces measuring $5\text{ cm} \times 4\text{ cm}$. One piece is of the same material as the specimen.

<i>If the first piece be</i>	<i>The second piece must be</i>
Cotton	Viscose
Linen	Viscose
Viscose	Cotton
Cellulose acetate	Viscose
Polyamide	Viscose or cotton
Polyester	Viscose or cotton
Acrylic	Viscose or cotton

The composite sample is placed in a wash-wheel container together with ten balls and sufficient solution containing 5 g of soap and 2 g of anhydrous sodium carbonate per litre to give a liquor ratio of 50:1. The test is carried out at $95^{\circ} \pm 2^{\circ}\text{C}$ ($203^{\circ} \pm 3.6^{\circ}\text{F}$) for a period of 30 minutes.

The rinsing, drying, and assessment of the sample are carried out in exactly the same manner as was the case with tests 1 to 3.

I.S.O. Recommendation No. 5

The composite sample is prepared as in the previous cases with the exception that

<i>If the first piece be</i>	<i>The second piece must be</i>
Cotton	Viscose
Linen	Viscose
Viscose	Cotton
Cellulose acetate (triacetate only)	Viscose
Polyamide	Viscose or cotton
Polyester	Viscose or cotton
Acrylic	Viscose or cotton

A 50:1 liquor ratio is used with a solution containing 5 g of soap and 2 g of anhydrous sodium carbonate per litre. The test is carried out at $95^{\circ} \pm 2^{\circ}\text{C}$ ($203^{\circ} \pm 3.6^{\circ}\text{F}$) for a period of 4 hours. The rinsing, drying, and assessment are carried out as in the previous tests.

Fastness to perspiration

Unless care is taken in the selection of suitable dyes those parts of a garment which come into contact with the body where perspiration is heavy may suffer serious local discoloration. Two artificial perspiration solutions are made up as follows:

	<i>Solution</i>	
	(A)	(B)
<i>l</i> -Histidine mono-hydrochloride mono-hydrate	0.5 g	0.5 g
Sodium chloride	5.0 g	5.0 g
Disodium hydrogen orthophosphate ($\text{Na}_2\text{HPO}_4 \cdot 2\text{H}_2\text{O}$)	2.5 g	2.2 g
Volume in distilled water	1000 ml	1000 ml
pH (Adjusted with $N/10$ NaOH)	8	5.5

The material to be tested is placed between undyed pieces, one of which is of the same fibre and the other of an alternative composition, according to the list quoted in the I.S.O. recommended hand-washing test. The pieces are sewn along one side to form a composite specimen, and this is thoroughly wetted out in 50 times its weight of the artificial perspiration solution **(A)**. It is allowed to remain in the solution for 30 minutes at room temperature, after which the liquid is poured off. The specimen is then placed between two glass plates pressed together with a force equivalent to 4.5 kg (10 lb) and allowed to stand in an oven at $37^{\circ} \pm 2^{\circ}\text{C}$ ($100^{\circ} \pm 4^{\circ}\text{F}$) for 4 hours. After this the dyed sample and undyed cloths are separated and they are all dried at a temperature not exceeding 60°C (140°F); the procedure is repeated with solution **(B)**. The changes of colour and staining are then assessed with grey scales for each test.

An alternative procedure is to use the method recommended in the second report of the Society of Dyers and Colourists' Fastness Committee. Two composite specimens are wetted out in solutions (A) and (B) employing a 20:1 liquor ratio by immersion at room temperature for 30 minutes. Each sample is then laid out in a glass dish with a smooth flat bottom, and a glass plate weighing about 50 g is laid over the top and the whole is covered with perspiration solution. The glass plate is pressed to remove air bubbles and, after standing for 15 minutes, the solution is poured off without removing the plate. With no further disturbance the apparatus is heated to $37^{\circ} \pm 2^{\circ}\text{C}$ ($100^{\circ} \pm 4^{\circ}\text{F}$) in an oven for 4 hours.

It must be borne in mind that some dyes are salt-sensitive, the change in shade being caused by the sodium chloride. Such dyestuffs can be discoloured when splashed with sea water, but salt staining is usually removed by rinsing in fresh water. Perspiration can also remove the metal from some copper after-treated direct dyes resulting in loss of wet and light fastness.

Fastness to chlorinated water (I.S.O. Recommendation)

This test is intended to assess the resistance of dyed materials to concentrations of active chlorine, similar to those which may be present in swimming baths. A solution containing 20 mg of active chlorine per litre is prepared by first diluting 13.3 ml of sodium hypochlorite, containing 150 g per litre of active chlorine, to 1000 ml with distilled water, and then adding 10 ml of this to 1000 ml of a solution buffered to 8.5 with

5.1 ml of 0.1M sodium hydroxide solution	}	per litre.
0.0144 g of potassium chloride		
0.1123 g of boric acid		

The pH should be checked, also the available chlorine determined by titration, and adjustments to both made if necessary. The sample is moistened in distilled water, squeezed, and immersed in 100 times its weight of the chlorine solution at room temperature for 4 hours. It is then rinsed thoroughly, dried at room temperature, and any change of colour is assessed with the grey scale.

The tests which have been described are connected with those properties of importance to the consumer. There are also a number of fastnesses which are of interest to the producer, and have particular application to dyed yarns incorporated during knitting or weaving to create a pattern which must withstand subsequent bleaching or dyeing.

Fastness to hypochlorite bleaching (I.S.O. Recommendation)

The sample is wetted out and squeezed. It is then immersed in a solution of sodium hypochlorite containing 2 g per litre of available chlorine, and buffered to pH 11 ± 0.2 with 10 g per litre of sodium carbonate. The liquor ratio should be 50:1 and the material to be tested is immersed at $20^{\circ} \pm 2^{\circ}\text{C}$ ($68^{\circ} \pm 4^{\circ}\text{F}$) for 1 hour under conditions such that there is no exposure to

direct sunlight. The sample is then rinsed in cold running water and immersed at room temperature for 10 minutes in a solution containing 2.5 ml per litre of 30 per cent (wt./vol.) hydrogen peroxide, or alternatively, 5 g of sodium bisulphite (NaHSO_3) per litre. After drying at a temperature not exceeding 60°C (140°F), any change of colour is assessed against the grey scale.

Fastness to peroxide bleaching (I.S.O. Recommendation)

The specimen is sewn between one piece of cloth of the same fibre and another of:

- (a) Cotton if the sample be wool, silk, viscose rayon, or linen.
 (b) Viscose rayon if the sample be cotton or acetate rayon. It is then rolled up and placed in a test tube and covered with the appropriate peroxide liquor. The compositions of the liquors and the conditions of the tests are set out in Table 25.1.

Table 25.1 Composition of bleach bath and conditions of use

Starting bath (per litre of distilled water)	Bath 1 (for natural and regenerated cellulose)	Bath 2 (h) (for wool)	Bath 3 (for wool and acetate rayon)	Bath 4 (for silk)
Hydrogen peroxide (a), ml	5	—	20	20
Sodium peroxide (b), g	—	3	—	—
Sodium silicate (c), ml	5	5	—	5
Sodium pyrophosphate (d), g	—	—	5	—
Magnesium chloride (e), g	0.1	0.1	—	0.1
pH, initial value ± 0.2 (f)	10.5	11.5	9.3 (g)	10
Temperature, $^\circ\text{C} \pm 2^\circ$	90	80	50	70
Temperature, $^\circ\text{F} \pm 4^\circ$	194	176	122	158
Duration of treatment, hr	1	1	2	2
Liquor ratio	30:1	30:1	30:1	30:1

(a) 30.4 per cent H_2O_2 (wt./vol.)

(b) 100 per cent Na_2O_2 .

(c) About 26 per cent SiO_2 and 10 per cent

Na_2O (sp gr = 1.32, 35°Bé).

(d) $\text{Na}_2\text{P}_2\text{O}_7 \cdot 10\text{H}_2\text{O}$

(e) $\text{MgCl}_2 \cdot 6\text{H}_2\text{O}$

(f) Adjust by addition of NaOH solution if necessary.

(g) The pH of the bath at the end of the test must not be less than 9.0.

(h) Bath 2 is included primarily to meet the requirements of some continental countries.

The degree of staining and alteration in colour are assessed with grey scales.

Fastness to chlorite bleaching (I.S.O. Recommendation)

The dyed material is sewn between two pieces of cloth of the same fibre. The test solution contains 1 g of sodium chlorite (80 per cent) per litre and, before the test, sufficient acetic acid is added to bring the pH to 3.5. The specimen is wetted out in the solution and subsequently immersed in it at $80^\circ \pm 2^\circ\text{C}$ ($176^\circ \pm 4^\circ\text{F}$) for 1 hour, using a liquor ratio of 50:1. The sample is then washed in cold running water for 10 minutes and dried at a temperature below 60°C (140°F).

Fastness to chlorination (I.S.O. Recommendation)

The test is designed for yarns or goods which will, at a later stage of manufacture, receive unshrinkable treatment. A specimen of the dyed material measuring 7.5 x 5 cm is recommended. If it be desirable to ascertain the degree of staining of other fibres, a few stitches of the appropriate undyed yarn are sewn into the fabric at approximately 1-cm intervals. The sample is immersed for 10 minutes at room temperature in 25 times its weight of a solution of hydrochloric acid containing 6 ml (1.16 sp gr) per litre of the acid; then an equal volume of sodium hypochlorite solution containing 1 g of available chlorine per litre is added, and treatment is continued in a cold liquor for another 10 minutes. The sample is next rinsed thoroughly in cold running water and subsequently dechlorinated in a 3 g per litre sodium sulphite ($\text{Na}_2\text{SO}_3 \cdot 7\text{H}_2\text{O}$) solution at 35° to 40°C (95° to 104°F), using a 50:1 liquor ratio for a period of 10 minutes. After rinsing and drying at temperatures not exceeding 60°C (140°F), assessments of alteration of colour and staining are made with the aid of the appropriate grey scales.

Fastness to cross-dyeing (I.S.O. Draft Recommendation)

The purpose is to test yarns intended for use with wool, and which should withstand dyeing by all the methods that may be used for the protein fibre. The yarns should be knitted into fabrics for the preparation of the samples. A piece of the dyed material measuring 10 cm x 4 cm is placed between two pieces of undyed cloth and sewn round the edges. One undyed piece should be of the same fibre as that of the sample undergoing test, and the other selected as follows:

<i>Fibre under test</i>	<i>Composition of alternate undyed piece</i>
Cotton	Wool
Wool	Cotton
Silk	Wool
Linen	Wool
Viscose rayon	Wool
Cellulose acetate	Wool
Polyamide fibre	Wool
Polyester fibre	Wool
Acrylic fibre	Wool

The specimen is then tested in the following different ways corresponding with the methods by which wool may be dyed, the liquor ratio always being 50:1 and the percentages being based on the weights of the protein and polyamide fibre in the composite sample.

(1) Neutral cross-dyeing

Enter the composite specimen into a liquor containing 20 per cent of

sodium sulphate crystals. The temperature is raised to $92^{\circ} \pm 2^{\circ}\text{C}$ ($198^{\circ} \pm 4^{\circ}\text{F}$) over a period of 30 minutes, and maintained for a further 90 minutes.

(2) Acetic acid cross-dyeing

The procedure is as in (1) except that the liquor contains 5 per cent of acetic acid (30 per cent) and 20 per cent of sodium sulphate crystals.

(3) Sulphuric acid cross-dyeing

The procedure is similar, but a solution containing 4 per cent of sulphuric acid (sp gr 1.84) and 20 per cent of sodium sulphate crystals is used.

(4) Acetic acid, chrome cross-dyeing

The composite specimen is entered into a bath containing 20 per cent of sodium sulphate crystals and 5 per cent of acetic acid (30 per cent). The temperature is raised to $98^{\circ} \pm 2^{\circ}\text{C}$ ($208^{\circ} \pm 4^{\circ}\text{F}$) over a period of 30 minutes, at which it is then maintained for a further 30 minutes, and then 2 per cent of potassium dichromate is added and the temperature is maintained at $98^{\circ} \pm 2^{\circ}\text{C}$ for another 60 minutes.

(5) Sulphuric acid, chrome cross-dyeing

The specimen is entered into a liquor made up with 20 per cent of sodium sulphate crystals and 3 per cent of acetic acid. The temperature is brought up to $98^{\circ} \pm 2^{\circ}\text{C}$ ($208^{\circ} \pm 4^{\circ}\text{F}$) over a period of 30 minutes, and after a further 30 minutes 2 per cent of sulphuric acid (sp gr 1.84) is added. Then after another 15 minutes, 2 per cent of potassium dichromate is added. The temperature is now kept at $98^{\circ} \pm 2^{\circ}\text{C}$ for 1 hour, after which the test is complete.

Whichever method is used the samples are rinsed in cold running water, dried at a heat not greater than 60°C (140°F), and the change of colour and staining are assessed with the grey scales.

Fastness to mercerizing (I.S.O. Recommendation)

If the sample to be tested be fabric, a portion measuring 10 cm x 10 cm is sewn round its edges to a piece of undyed bleached cotton of the same size. The composite specimen is then fastened firmly, but without excessive tension, to a frame with the coloured portion uppermost. Dyed yarn is wound on to a rigid frame, without excessive tension, with the parallel strands arranged closely together until an area of 10 cm x 10 cm is covered. A piece of undyed bleached cotton cloth is then attached by sewing, leaving the coloured yarn uppermost.

The specimen, on the frame, is immersed in a solution containing 300 g of sodium hydroxide (NaOH) per litre at $20^{\circ} \pm 2^{\circ}\text{C}$ ($68^{\circ} \pm 4^{\circ}\text{F}$) for 5 minutes. It is then rinsed, whilst still on the frame, with 1 litre of water at $70^{\circ} \pm 2^{\circ}\text{C}$ ($158^{\circ} \pm 4^{\circ}\text{F}$) for 1 minute, and finally in running cold water for 5 minutes.

The sample is next removed from the frame, and the residual alkali is neutralized by immersion for 5 minutes in 50 times its weight of sulphuric acid of a concentration of 5 ml per litre. After rinsing the acid out in cold running water the material is dried, the temperature not exceeding 60°C (140°F), the dyed and undyed portions having been separated except at the stitching along one side.

Many colours show an apparent increase in depth on mercerizing. In such cases the rating of 5 is distinguished with an asterisk (5*) or, if the hue alters without loss of depth, the grey scale grading is used to indicate, not the loss of colour, but the extent of the alteration (3-4 redder*).

There are many other fastness tests and for further information the second edition of the Society of Dyers and Colourists' publication *Standard methods for the determination of the colour fastness of textiles* should be consulted. The only process for which no test has been published is dealgination, a treatment used almost invariably with men's socks of wool or wool and cotton. The method found satisfactory by the author has been to attach white cotton to dyed wool or the reverse, and treat at 60°C (140°F) for 30 minutes in a solution containing 2.5 g per litre of tetrasodium pyrophosphate.

Identification of dyes

It is often necessary to ascertain what dye or class of dyestuff has been used on a pattern before goods can be dyed in bulk to match. An exact identification is often difficult because a mixture of dyes will nearly always be used in practice. The first serious publication on the subject was A. G. Green, *Analysis of dyestuffs* (Griffin, London, 1915). For very many years this was the standard work, but so many new dyestuffs had been introduced that Clayton (*J.S.D.C.*, 1937, 53, 178) prepared revised tables for identification of dyes on the fibre, which are now obtainable as a separate publication from the Society of Dyers and Colourists.

In the first place it is helpful if the class rather than the individual dye can be determined, and in very many instances this information is sufficient. In the case of wool and silk the probable classes are basic dyes, acid dyes, and mordant or premetallized dyestuffs.

The basic dyes differ from all others because they are extracted quite easily by boiling with acetic acid or with alcohol. If, however, these reagents do not remove a substantial portion of the dye from the fibre, the next test is to boil the coloured material in dilute ammonia (1 ml of 0.88 ammonia per 100 ml of water) for 1 to 2 minutes in the presence of white cotton (CLAYTON, *loc. cit.*). If the solution is distinctly coloured and the cotton remains unstained, the presence of an acid dye is indicated. This can be confirmed by boiling with 40 per cent of Glauber's salt when a considerable proportion of molecularly-dispersed acid dyes are stripped, but little effect is apparent with the fast acid dyes. If the cotton is stained the presence of

a substantive dye or a structurally analogous neutral dyeing acid colour is indicated. It must be emphasized, however, that there are many acid dyes which are strongly adsorbed by wool in a neutral liquor and leave the cellulose unstained.

If, on boiling with ammonia, virtually no colour migrates into the liquor, a mordanted or premetallized dye is probably present. This is confirmed by testing for the presence of appropriate metallic ions. To do this the material must be ashed, and the method recommended by Clayton is to heat about 1 sq in., if possible, in a platinum or silica dish until charring has taken place. The dish is then cooled and the residue is covered with a hot saturated solution of sodium nitrate, the water is evaporated, and heating is continued until all the carbon has burned away. The ash is extracted with water or dissolved with the aid of a little hydrochloric acid, and the usual qualitative tests for metallic ions are applied.

When the general group to which the dye or dyes belong has been determined, much useful information about the nature of the chemical constitution can be gained by studying the action of Formosul G. This reagent is prepared by dissolving 75 g of Formosul in 75 ml of hot water, and then diluting with 75 ml of cold water and 50 g of mono- or di-ethylene glycol. The specimen is boiled with the reagent for 1 to 2 minutes, and its behaviour can be compared with the information given in Clayton's tables.

With regard to cellulosic fibres, the simplest test for the dyes which will probably be present, ignoring unlikely ones such as acid or basic dyes, is to boil for 1 to 2 minutes with a 5 per cent caustic soda solution. If a considerable quantity of colour is stripped a substantive dye is indicated, and it will probably be an azo dye if the colour of the fresh sample is destroyed by boiling for 2 minutes with Formosul G. If, on the other hand, very little or no dye is stripped, the inference is that the material has been dyed with a sulphur, vat, or reactive dye. When boiled for 1 to 2 minutes with Formosul G and a few drops of sodium hydroxide solution, azoic or reactive dyes are virtually stripped. They can, however, be distinguished because only reactive dyes and certain phthalocyanine derivatives, usually recognizable by their distinctive colour, will withstand the following treatment (GILES *et. al.*, *J.S.D.C.*, 1962, 78, 126):

Boil for four minutes, in succession, in the following reagents, rinsing in distilled water after each treatment:

- (1) Glacial acetic acid and ethanol (1:1 vol./vol.)
- (2) 1 per cent ammonia solution (sp gr 0.88, 10 ml/litre)
- (3) Dimethyl formamide and water (1:1 vol./vol.)
- (4) Dimethylformamide

If the pattern, on boiling with Formosul G and alkali is decolorized but

the colour is restored by rinsing in hot water, the presence of a sulphur dye is suggested. Confirmation is provided by boiling for half a minute with 16 per cent hydrochloric acid, cooling, and adding a little zinc when hydrogen sulphide will be evolved, detectable by the black colour produced on filter paper moistened with lead acetate solution. As an alternative, the sulphur can be reduced to hydrogen sulphide with an acidified solution of stannous chloride (BRADLEY AND DERRETT-SMITH, *J.S.D.C.*, 1940, 56, 114).

If the dyeing changes shade when treated with alkaline Formosul G but the colour is restored on exposure to air, or when treated with hydrogen peroxide or ammonium or potassium persulphate, and it does not respond to the test for a sulphur colour, it will be a vat dye. Some sodium salts of leuco compounds differ little in colour from the oxidized pigment, but in such cases the free leuco compound, obtained by reduction with a boiling solution containing equal proportions of Formosul and acetic acid, will often show a more marked change of colour which is restored on oxidation or exposure to air. According to Bradley and Derrett-Smith (*loc. cit.*), if a small specimen of the dyed sample be wrapped in a piece of bleached linen or cotton measuring about 1 sq in., and tightly bound into a roll with undyed sewing thread and boiled for a few seconds in alkaline hydrosulphite, the leuco compound marks off onto the white material and the colour is developed on oxidation. Although both vat and sulphur dyes mark off, the latter can easily be recognized by the hydrogen sulphide test. The recognition of individual vat dyes by colour reactions produced when spotted with various reagents, has been described by Bradley and Derrett-Smith (*J.S.D.C.*, 1940, 56, 95), Derrett-Smith and Gee (*J.S.D.C.*, 1947, 63, 401), and Derrett-Smith and Gray (*J.S.D.C.*, 1956, 72, 211).

Resin or crease-resist finishes retard reduction with hydrosulphite and

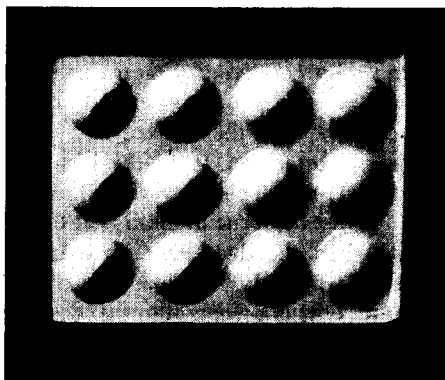

Fig. 25.10 Spotting tile

(Courtesy of Loughborough Glass)

the liberation of hydrogen sulphide from sulphur dyes when they are treated with reducing agents. Whittaker and Wilcock, *Dyeing with Coal Tar Dyestuffs* (fifth edition), recommend that the resin finish should be removed by treatment for 5 to 10 minutes at 90°C (194°F) in a 0.5 per cent solution of hydrochloric acid before the tests are carried out.

When the class of the dye has been determined it is desirable, if possible, to identify the actual dyestuff. A simple but not very reliable method is to place cuttings in a spotting plate of white porcelain with a series of small depressions about $\frac{1}{8}$ in. in diameter, arranged in parallel rows (Fig. 25.10). Three, four, or more cuttings of the sample are placed in one row, and cuttings of the same fibre dyed with known colours of similar shade from the corresponding group are placed in parallel rows. The sample and cuttings of known dyestuffs are then spotted with drops of reagents, such as concentrated sulphuric acid, nitric acid, hydrochloric acid, 20 per cent sodium hydroxide solution, acidified stannous chloride, and alkaline hydro-sulphite. The colorations which result are compared, and if any of the series shows the same reactions as the sample this is taken as evidence of identity. The method is entirely empirical, not very reliable, and of no value unless the sample has been dyed with only one dyestuff. It is often more useful as a source of negative information when it is desirable to prove that two batches were not dyed in the same way.



Fig. 25.11

Strip chromatograph

Chromatography

A very promising field for the examination of dyed materials which has recently been receiving much attention is chromatography. The method has been used, in a crude manner, for indicating whether dyes are homogeneous or mixtures, for a long time. Some of the dye is stripped from the material with boiling alkali, pyridine, ethylene diamine, or other solvent which does not cause decomposition, and then converted to aqueous solution, into which strips of filter paper are suspended so that the lower end makes contact with the surface and the remainder (6 to 12 in.) is not immersed. If the dye be a mixture, the different components will rise to various levels in the strip (Fig. 25.11). It must be borne in mind that the separation is only effective when the dyes have no marked affinity for the cellulose of which the filter paper is composed.

A more efficient separation is described by Clayton (*J.S.D.C.*, 1937, 53, 183). A tube is filled with an absorbent material, one of the most satisfactory being a specially prepared alumina. The dye, in solution, is introduced through a dropping funnel at the top of the column, and is initially absorbed by the top layer of alumina. A suit-

able solvent is then allowed to percolate downwards, accelerated by the application of suction if necessary. After the solvent, often referred to as the eluant, has flowed through the column for a suitable time, often 2 to 3 hours, the components will be separated into clearly defined zones, *A*, *B*, and *C* in Fig. 25.12. The column can then be broken up, the bands separated, and the dyes isolated from them or, alternatively, it may be eluted with suitable solvents which will carry the zones, one after another, into the receptacle at the bottom of the column.

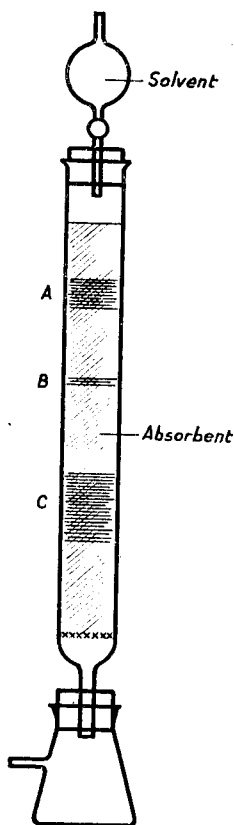

Fig. 25.12 Simple apparatus for chromatographic separation

Paper chromatography has now, to a great extent, replaced alumina or similar absorbent columns. An advantage is that much smaller quantities can be used. The apparatus is illustrated diagrammatically in Fig. 25.13. The sheet of filter paper is suspended so that its bottom dips into a vessel containing the eluent and the upper end is attached by clips to a frame (Fig. 25.14).

The whole can be placed in a rectangular glass vessel with ground edges at its open end, so that an airtight seal can be formed when covered with a glass plate. A spot of dye solution is placed on the paper and it will rise to a height d where it forms a stationary coloured patch at a distance $D-d$ from the height D to which the solvent rises. The factor R_f , which should be constant for the same compound at the same temperature with the same solvent, is the ratio of the distance travelled by the spot

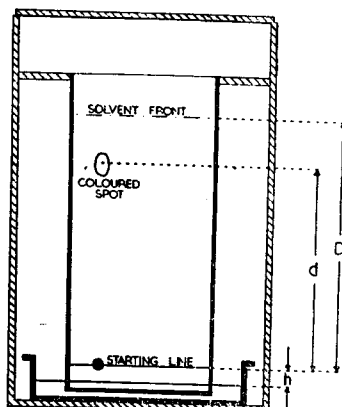

Fig. 25.13 Diagram of apparatus for paper chromatography

(ELLIOTT AND TELESZ, *J.S.D.C.*, 1957)

The whole can be placed in a rectangular glass vessel with ground edges at its open end, so that an airtight seal can be formed when covered with a glass plate. A spot of dye solution is placed on the paper and it will rise to a height d where it forms a stationary coloured patch at a distance $D-d$ from the height D to which the solvent rises. The factor R_f , which should be constant for the same compound at the same temperature with the same solvent, is the ratio of the distance travelled by the spot

to the distance travelled by the eluent or, d/D . Brown (*J.S.D.C.*, 1960, 76, 537) suggests that the R_f value is not very reliable for identification unless supported by actual chromatograms of known dyes. As has been indicated in Fig. 25.14, chromatograms may be prepared with either an ascending or a descending eluent. A typical descending chromatogram for disperse dyes is shown in Fig. 25.15 and an ascending diagram for acid dyes in Fig. 25.16.

Classical absorption chromatography relied upon the strength of the

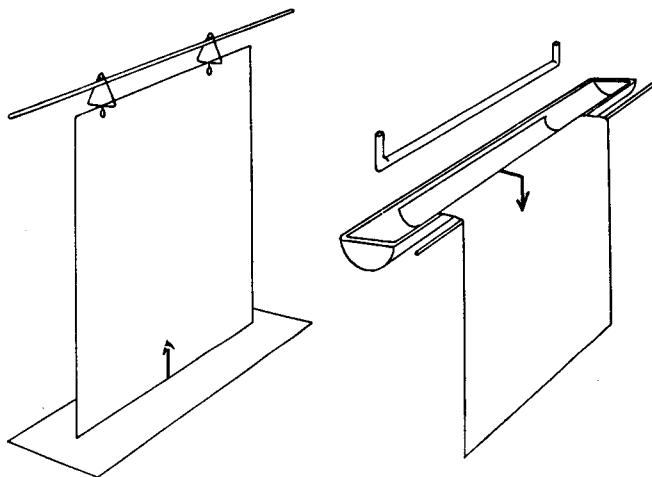

Fig. 25.14 Production of ascending and descending chromatograms

(BROWN, *J.S.D.C.*, 1960)

conflict between molecular attraction of the substance under examination for the absorbent, and the tendency for the eluent to dissolve and remove it. Alumina or paper was the absorbent and usually only one solvent, very often water, was percolated. Partition chromatography is a refinement of this procedure. The absorbent in this case is a stationary liquid supported on a solid substrate such as filter paper. The rate of travel of the dye depends upon partition between the stationary liquid and the eluent. A typical method is described by Brown (*loc. cit.*). An eluent mixture is made up of:

Cyclohexane, 200 ml
Glacial acetic acid, 192 ml
Water, 8 ml

This mixture is shaken in a separating funnel and allowed to stand overnight. It will separate into a concentrated acetic acid phase in equilibrium with cyclohexane, and a layer composed essentially of cyclohexane. To prepare a descending chromatogram the lower layer in the separating funnel is run off the next day and poured into the bottom of the chromatography

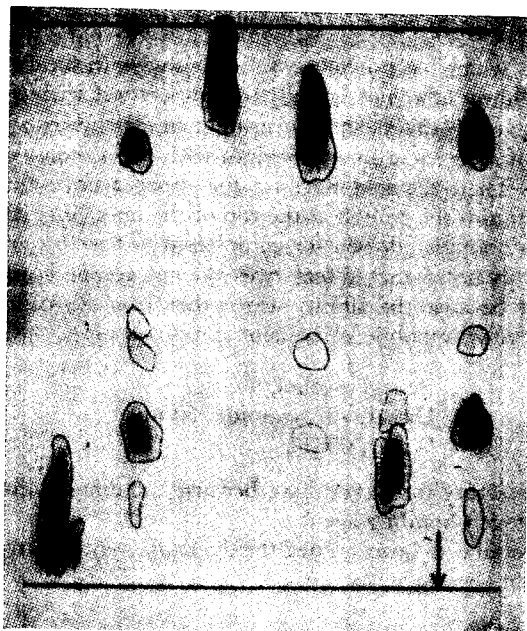

Fig. 25.15 Blue anthraquinonoid disperse dyes. Descending chromatograph
(BROWN, 'J.S.D.C.')

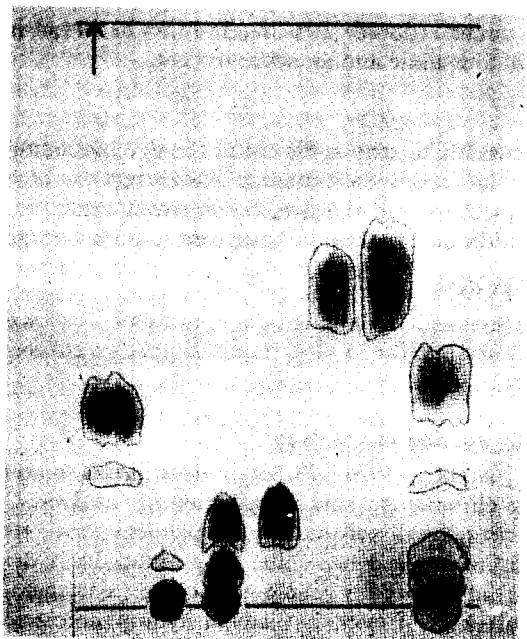

Fig. 25.16 Acid dyes. Ascending chromatograph
(BROWN, 'J.S.D.C.')

tank. The paper, which has previously been spotted with the dyes, is placed in position, the lower edge not actually making contact with the liquid. It is allowed to remain in this position overnight so that by absorption of the vapour a layer of acetic acid in equilibrium with cyclohexane can be built up on the paper. Then, the next morning, the upper layer from the separating funnel is run into the trough at the top of the tank (Fig. 25.13), and a period of 4 to 6 hours is allowed for completion of the chromatogram. It must be borne in mind that direct dyes do not respond well to paper chromatography because the affinity which they have for cellulose makes the colour relatively immobile. An eluent composed of:

Benzyl alcohol, 90 ml
Dimethylformamide, 60 ml
Water, 60 ml

has proved satisfactory for direct dyes, because the dimethylformamide is a powerful hydrogen bonding agent.

If a dyed material is to be examined the dyestuffs may be extracted in the following manner (BROWN, *loc. cit.*).

Direct dyes

Boil for about 2 minutes in a mixture composed of 2 parts of dimethylformamide and 1 part of water. The extracted dye solution is concentrated by evaporation under reduced pressure. It must be borne in mind that dimethylformamide is toxic and an acute irritant.

Acid dyes

It is usually possible to strip sufficient of the dye by boiling in a 10 per cent (vol./vol.) solution of 0.88 ammonia. The extract can be concentrated at atmospheric pressure and the dye, if somewhat insoluble, retained in solution by the addition of a drop of 1 per cent sodium carbonate solution.

2:1 Metal complex dyes

These can be stripped by boiling in a mixture of 2 parts of dimethylformamide and 1 of water for 15 to 30 minutes, and then concentrated under reduced pressure.

Chromatography applied to vat dyes

Klingsberg (*J.S.D.C.*, 1954, **70**, 563) describes a method specially designed for the chromatographic examination of vat dyes. Owing to the insolubility in virtually all solvents of the pigment form, the separation must be carried out in the leuco state. The reduced vat dyes, however, have such a marked affinity for cellulose that paper chromatography must be ruled out, but strips of material made of hydrophobic synthetic fibres, of which polyesters are the best, may be substituted. Rao, Shah, and Venka-

taraman (*Current Sci. (India)*, 1951, 20, 66) reported that they were able to separate vat dyes on paper or on powdered cellulose if they used sodium hydrosulphite and tetraethylenepentamine instead of sodium hydroxide as the vatting mixture. Klingsberg (*loc. cit.*) describes an apparatus (Fig. 25.17) with which chromatograms of vat dyes can be obtained on strips of paper using as the eluent 10 g of sodium hydrosulphite dissolved in 100 ml of a 10 per cent solution of tetraethylenepentamine. The whole is enclosed

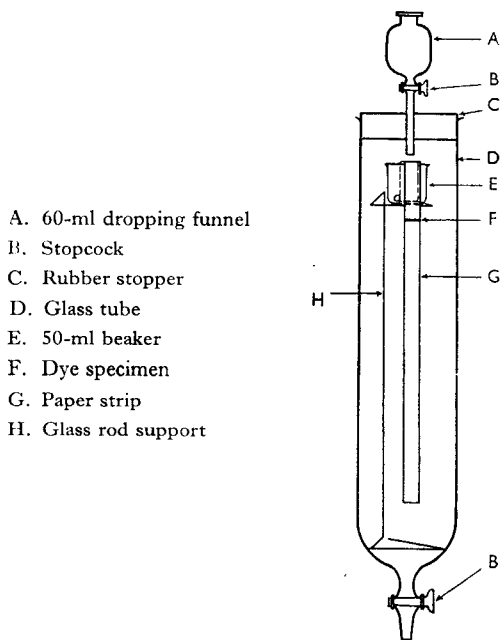

- A. 60-ml dropping funnel
- B. Stopcock
- C. Rubber stopper
- D. Glass tube
- E. 50-ml beaker
- F. Dye specimen
- G. Paper strip
- H. Glass rod support

Fig. 25.17 Apparatus for paper chromatography under nitrogen

in a wide glass tube (*D*) which can be evacuated and filled with nitrogen to exclude the possibility of oxidation of the leuco compound to the insoluble pigment during the preparation of the chromatogram. A descending chromatogram is prepared by suspending the upper end of the strip of paper in a small beaker into which the eluent is delivered from the stoppered funnel (*A*). Further information about examination of dyes by chromatography can be obtained from the following sources:

ELLIOTT AND TELESZ	<i>J.S.D.C.</i> , 1957, 73, 8
MIDGELOW	<i>Hexagon digest</i> , No. 3
BROWN	<i>J.S.D.C.</i> , 1960, 76, 536
KLINGSBERG	<i>J.S.D.C.</i> , 1954, 70, 563.

Šrámek (*J.S.D.C.*, 1962, 78, 326) describes an alternative method for

chromatographic examination of vat dyes. The vessels in which the chromatograms, on strips of Whatman No. 1 paper, are prepared consist of test tubes with the approximate dimensions of 1.8 cm diameter and 20 cm length. The eluent which has the following composition:

distilled water, 32 ml
 turkey red oil (1 per cent solution), 48 ml
 sodium hydroxide (35 per cent Analytical Grade), 4 ml
 sodium hydrosulphite (Tech.), 4 g
 pyridine (Analytical Grade), 6 ml

is added so that there will be sufficient to reach a level just below the starting point of the chromatogram. The test tubes are fixed in the vertical position in a thermostat as shown in Fig. 25.18 and the strips of filter

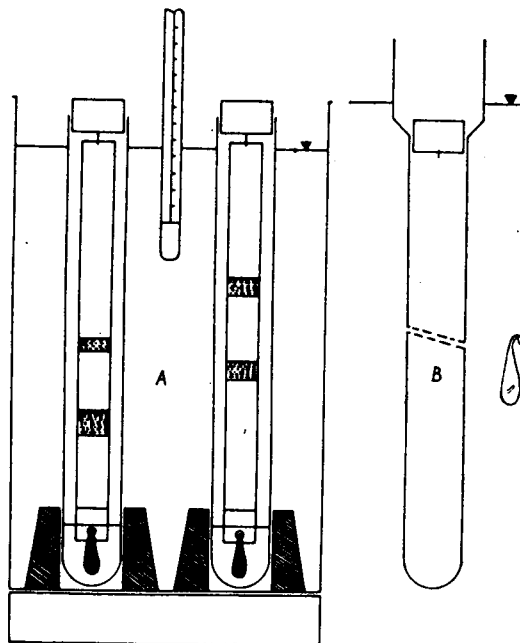

Fig. 25.18 Thermostat with chromatograms in position

(Šrámek, *J.S.D.C.*, 1962, 78, 326)

paper are held taut by small glass weights attached to the bottom of each. The tube must be immersed completely in the bath and maintained at 80°C so that there will be no condensation of the eluent in the upper portions, and for the same reason it is most important that the rubber stopper to which the strip is attached should fit tightly. The leuco vat dye is applied to the starting line of the chromatogram which is then quickly, without being dried, placed in the test tube. The reducing eluent ensures

that the vat dye will remain in the state of the leuco compound and separation is complete in periods varying between two and four hours. The same procedure can be used with sulphur dyes with the exception that the leuco compound is obtained by dissolving the dye in sodium hydroxide and sodium hydrosulphite.

Thin-layer chromatography is probably the most successful technique for the examination of dyes. The method is described by Rettie and Haynes (*J.S.D.C.*, 1964, 80, 629) and by Titterington (*J.S.C.I.*, 1966, 746). A glass plate or even a microscope slide is coated with a thin layer of an absorbent which may be a form of silica gel, alumina, kieselghur, cellulose powder, magnesium sulphate and ion-exchange cellulose powders. These may or may not be mixed with a binding agent. The procedure is to prepare a slurry which is coated onto the glass surface with a special spreader such as that shown in Fig. 25.19. The plates are then dried and

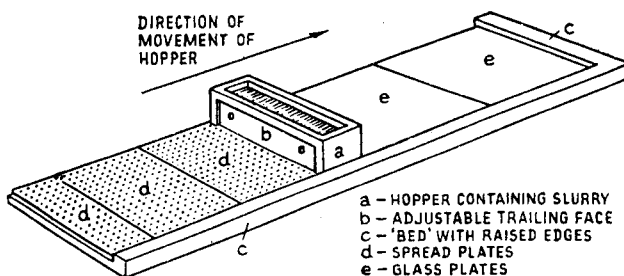

Fig. 25.19 Moving-spreader apparatus
(*'Chromatographic Methods', Stock and Rice, Chapman and Hall*)

kept in a desiccator until required. It must be borne in mind, however, that prolonged storage is not desirable.

To prepare the chromatogram a drop of the dye solution is placed at the starting point and a suitable solvent is chosen from a selection such as the following. Petroleum ether, cyclohexane, benzene, chlorobenzene, chloroform, diethyl ether, esters, dioxan, acetone, alcohols, pyridine, and water,

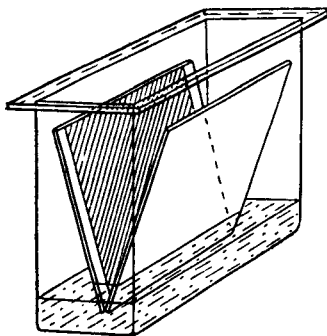

Fig. 25.20 Small tank for two 20 × 20 cm plates
(*'Chromatographic Methods', Stock and Rice, Chapman and Hall*)

and organic acids. The best results, ascertained by trial and error, may be obtained by any one of these solvents alone or by mixtures. The plate is then put in a glass tank, containing enough eluent to fill the bottom to a depth of 0.5 to 1 cm. The plates are stacked in the tank as shown in Fig. 25.20 or in any other convenient arrangement and the glass vessel is covered with a plate in order that a homogeneous atmosphere can be maintained during the development of the chromatogram. When the components have separated into clearly divided zones each one can be removed independently with a cinkered filter attached to a vacuum pump as illustrated in Fig. 25.21. The component which has been collected can then be extracted from the absorbent with a suitable solvent.

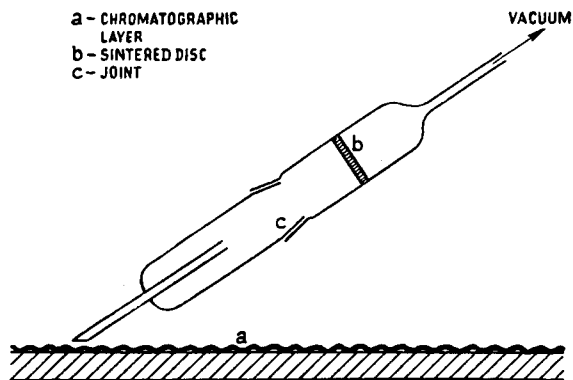

Fig. 25.21 Apparatus for removal of part of a thin-layer chromatogram

(*Chromatographic Methods*, Stock and Rice, Chapman and Hall)

26 · Colour

ELECTROMAGNETIC radiations range from γ -rays, with a wavelength of 10^{-11} cm, to radio waves, varying from 10 to 10^4 cm. As illustrated in Fig. 26.1, visible light constitutes only a very narrow band in this spectrum, lying between 4×10^{-5} cm and 7.2×10^{-5} cm. Wavelengths are also expressed in Ångström units (1 Å equals 10^{-8} cm or 10^{-10} metre) and when using standard international units, in nanometres (10^{-9} metre).

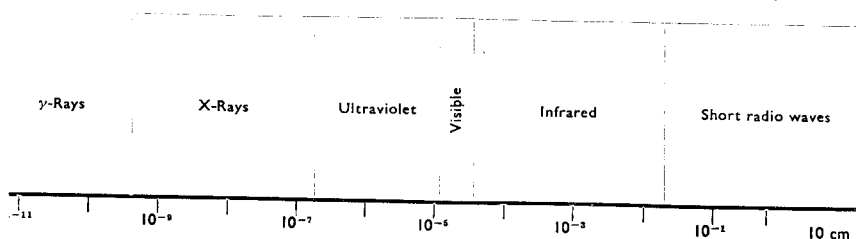

Fig. 26.1 Scale of wavelengths for the range of electromagnetic waves

When a beam of sunlight passes through a prism it is separated into a spectrum of seven easily discernible colours which are:

Colour	Wavelength
Violet	3900–4300 Å (390–430 nm)
Blue	4300–4600 Å (430–460 nm)
Blue-green	4600–5000 Å (460–500 nm)
Green	5000–5700 Å (500–570 nm)
Yellow	5700–5900 Å (570–590 nm)
Orange	5900–6100 Å (590–610 nm)
Red	6100–7000 Å (610–700 nm)

It must be emphasized that the phenomenon of colour is entirely subjective, because it is the sensation created in the brain by the message stimulated by the impact of radiation of a particular wavelength on the nerves in the eye.

The retina of the eye contains innumerable nerve ends which can be differentiated into two categories known, because of their shapes, as the rod and cone types. The rods function when the illumination is of low intensity and do not appear to play much part in colour vision. This is demonstrated by the fact that objects appear colourless in a dim light. It

is believed that the cones play the predominant part in conveying the colour stimulus to the brain. The exact mechanism is not understood, but it appears that photochemical reactions are involved.

Almost any colour, including white (but not black), can be matched by mixing together different proportions of blue-violet, green, and red. These colours are called the additive primaries, and their wavelengths are 435, 546.1 and 700 nm respectively (Fig. 26.2). It is believed that the eye only responds to these three primary colour stimuli, and all other hues are derived by variations in the relative intensities of the stimuli. The idea was first expressed by Young and Helmholtz, who suggested that there were three different kinds of cone-shaped cells responding to the three wavelengths referred to above. Evidence has been accumulated which leads to the conclusion that the cone-shaped cells contain pigments sensitive to three specific light frequencies. Acceptable radiation brings about a readily reversible change in constitution, simultaneously emitting a message through the communicating nerves to the brain. It has been demonstrated, by the most exacting experimental techniques, that in the case of goldfish the receptors show maximum absorption at wavelengths of 455, 535, and 625 nm and in primates at 445, 546, and 590 nm which bear a close resemblance to the approximate values of 430, 546, and 590 for human vision.

Materials are coloured because they reflect certain of the wavelengths of the white light which falls upon them, and absorb others. This is referred to as production of colour by the subtractive process. If a beam of white light passes through filters which block the passage of most of the wavelengths and transmit only a selected wave-band, it will be found that three different colours, known as the subtractive primaries, are required to match all hues. These are the familiar yellow, blue, and red. It must, however, be emphasized that to match all possible hues, these subtractive primaries must be selected very carefully, and the most perfect combination has proved to be magenta, yellow, and cyan. They are in each case white light from which different pairs of the additive primaries have been excluded. The effect of subtractive colour production is shown diagrammatically in Fig. 26.3, where the lights transmitted by partially superimposed filters of yellow, magenta, and cyan are demonstrated.

There are certain attributes of colour requiring some definition. The hue describes the kind of colour, namely, whether it is a red, an orange, a green, a yellow, or a blue. The saturation of a colour is an expression of the proportion of the dominant wavelength. Thus, ideally, a fully saturated yellow would contain only rays corresponding with a wavelength of 576 nm. In practice this never happens and saturation is decreased by adulteration with light of other wavelengths. Finally, in order to give a complete description of a colour, the attribute of luminosity must be introduced. This represents the quantity of light reflected or emitted per unit area of the surface. To an

observer, colours with the same hue and saturation appear different if their luminosities are not the same.

Defective colour vision

The majority of persons, amounting to 92 per cent in the case of men, are trichromats, meaning that they have normal colour vision. When matching two or more shades with each other they make use of the three primaries. Between 2 and 3 per cent of men are dichromats because their eyes respond to only two primaries and their capacity to discriminate is less acute than that of the trichromats.

Those with defective colour vision have been classified in the following manner (McLARAN, *J.S.D.C.*, 1966, 82, 382 and JORDINSON, *J.S.D.C.*, 1967, 83, 406).

- (i) Achromats who are quite deficient in colour vision.
- (ii) Protanopes who are not sensitive to blue-green and bluish-red.
- (iii) Deutanopes whose colour vision mechanism is defective in response to greenish-blue, green, and purple.
- (iv) Tritanopes who lack sensitivity to greenish-yellow and violet.
- (v) Tetartanopes whose vision is deficient in reddish-yellow and blue hues.

With advancing age there is a tendency for the yellow macular pigment in the eye to increase. This filters out more of the blue light entering the eye so that the colour of an object appears yellower to an older than to a younger man. The result is that there can be a significant difference of opinion when endeavouring to match patterns and samples in which different dyes have been used to obtain the same shade with dissimilar spectral distributions of the reflected light (metamerism).

Testing colour perception

A commonly-used device for testing colour perception is the Ishihara test. This consists of a number of plates composed of numerous spots of different colours and sizes. Incorporated into this random arrangement are a number of dots, tracing out numerals, which are of a colour distinguishable from the remainder. The colour sensitivity of the observer's eye is assessed by his ability to read these numbers. It is also possible to detect different kinds of colour blindness with the plates. Four of them, for example, each contain two numbers; one in scarlet and the other in purple. Those who suffer from panatropy cannot see the scarlet spots and only read the purple ones, but the deutanopes read only the scarlet numerals; those with normal vision see both numbers. (For further information see JORDINSON AND MINSHALL, *J.S.D.C.*, 1959, 75, 585.)

Subsequently 'inverted' plates were introduced in which the normal observer sees no figure and the dichromat does. The results of this test must be judged with discretion because it has been shown that it is not

uncommon for one who fails the Ishihara test to be found to be normal when examined with a colorimeter which is, without doubt, the most reliable method of assessment. The A.O./H.R.R. test is based on confusion charts and has received favourable reports. It is published by the American Optical Company.

The Farnsworth test (*J.S.D.C.*, 1945, 61, 213) uses 85 pieces of card painted in different colours and the observer is set the task of arranging them in a logical sequence. The Garner test makes use of samples of material dyed in such a way that some turn greener and others redder in artificial light. To a normal observer any pair will match when viewed in a north light in the Northern Hemisphere, although they reflect different spectral mixtures. To a person who is not equally sensitive over the whole range of the spectrum, however, the two patterns will not appear alike.

The Giles–Archer colour perception unit consists of a lamp with three apertures; one of 5 mm, another of 0.5 mm, and finally a 0.5-mm aperture covered with a neutral filter. Filters transmitting six different colours can be placed over the apertures by rotating a disc on which they are mounted. The observer, standing at least 6 ft from the lamp, must name the colours, using the three apertures in turn. Severe cases of red and green blindness cannot differentiate between the large exposures of these hues, and are often unable to see any of the colours when the small apertures are used.

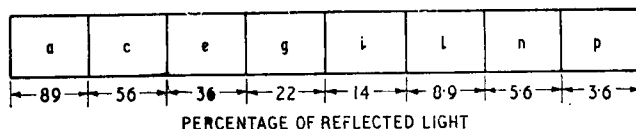

Fig. 26.4 Neutral shades in Ostwald's system

One of the most reliable instruments for the detection and classification of defective colour vision is the Nagel anomaloscope. This contains a prism from which the spectral yellow light is used to illuminate one half of the field of vision. The other half of the field is illuminated with spectral red and green. The observer must vary the proportions of red and green and also the intensity of the yellow until the two halves of the field are, in his opinion, a match. The relative amounts of red and green selected give an indication of the normality or defectiveness of the colour vision. Owing to the subjective nature of colour perception and the widespread existence of slight abnormalities of vision a method of classifying and objectively specifying colours is most desirable. Ostwald made one of the earliest endeavours to provide such a system. He specified a series of shades devoid of hue which was, in fact, a scale graded in geometrically progressive steps from white to black through greys of increasing depth (Fig. 26.4). He also divided the pure hues, in the first place into one hundred colours, but for practical purposes limited the number to twenty-four. Triangular

diagrams were constructed for each hue made of the pure colour mixed with varying amounts of black or white, and such a triangle is shown in Fig. 26.5. The parallelogram at the apex marked *R* contains the pure hue and the parallelograms at *W* and *B* are white and black respectively. The row *WB* contains no hue and is the white, grey, black scale divided into eight graduations. The row *RW* consists of the hue *R* mixed with different amounts of white, and the quadrilaterals in *RB* are made up of the hue with increasing proportions of black.

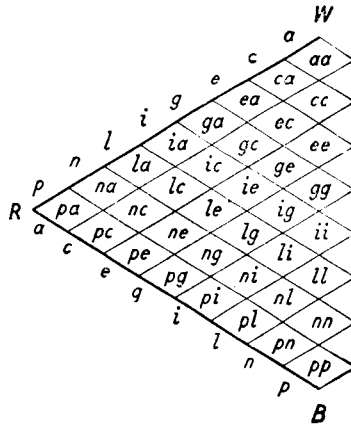

Fig. 26.5 Oswald's system. Isochromatic triangle

The arrangement of colours shown in Fig. 26.5 is known as an isochromatic triangle, and represents the range of shades obtainable by mixing varying amounts of black or white with the hue. Each parallelogram is identified by two letters, the first of which shows the percentage of white and the second the percentage of black mixed with sufficient of the hue to bring the total up to one hundred.

In the case of white the letter *a* would represent 86 per cent of reflectance, which is the highest obtainable under normal practical conditions. The scale for the proportions of white might, for example, be as shown below; blacks being the converse.

<i>White</i>		<i>Black</i>	
<i>a</i>	86 per cent	<i>a</i>	3.6 per cent
<i>c</i>	56 " "	<i>c</i>	5.6 " "
<i>e</i>	36 " "	<i>e</i>	8.9 " "
<i>g</i>	22 " "	<i>g</i>	14 " "
<i>i</i>	14 " "	<i>i</i>	22 " "
<i>l</i>	8.9 " "	<i>l</i>	36 " "
<i>n</i>	5.6 " "	<i>n</i>	56 " "
<i>p</i>	3.6 " "	<i>p</i>	89 " "

It follows that *pp* represents the maximum proportion of black and the minimum of white, and *aa* is equivalent to a virtual absence of black. Thus if *R* were to be hue 24 in the Ostwald scale, square 24 *le* would represent, for example:

White equivalent to	8.9 per cent reflectance
Black equivalent to	8.9 per cent reflectance
Hue equivalent to	82.2 per cent reflectance

and square 24 *ni* would represent:

White equivalent to	5.6 per cent reflectance
Black equivalent to	22 per cent reflectance
Hue equivalent to	72.4 per cent reflectance.

An imitation of a colour solid may be made by mounting the isochromatic triangles, with their black, grey, white bases attached, to a vertical axis and the apices with the pure hues pointing outwards (Fig. 26.6).

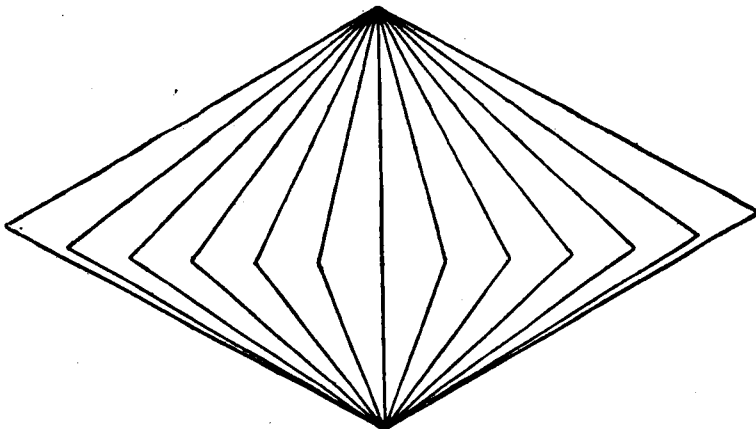

Fig. 26.6 Ostwald's colour solid

The Ostwald classification has been replaced by the Munsell system, which leaves spaces to accommodate pigments of greater brightness than have hitherto been made. The three basic attributes used for the description and location of colours are value, hue, and chroma.

(1) Value is the amount of black mixed with the hue. There are ten numbers on the scale, one being a perfect black and ten an ideal white. Neither exists in practice, with the result that numbers two to nine are used.

(2) Hue. There are ten principal hues.

Yellow	Purple-blue
Yellow-red	Blue
Red	Blue-green
Red-purple	Green
Purple	Green-yellow

Each of these, however, may be further differentiated into ten subdivisions. As shown in Fig. 26.7, the graduations are numbered in such a manner that the principal hue is always 5.

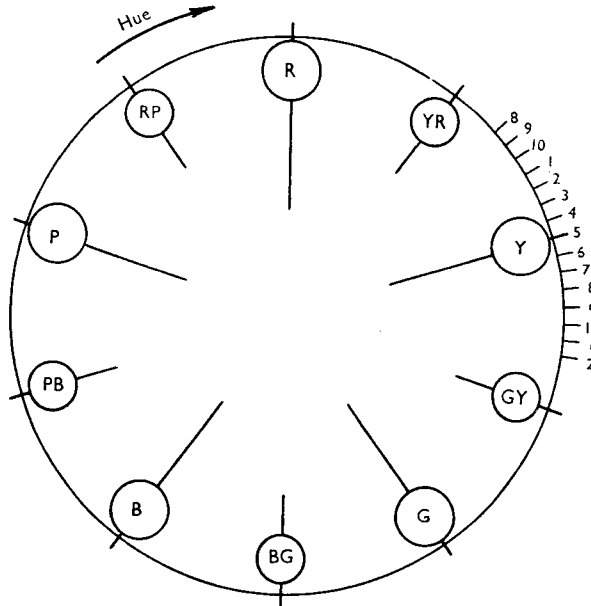

Fig. 26.7 Munsell system. Arrangement of hues
(*'The Measurement of Colour', Wright*)

(3) Chroma, which is a measure of the saturation of the colour, is expressed by the distance from the value axis. A typical plane in the Munsell chart is shown in Fig. 26.8, in which the hue 5Y (yellow) is illustrated in various values and graduations of chroma on the right of the central black/white axis. On the left of the same axis the hue 5PB (purple-blue) is treated in the same manner. The individual colours are identified according to their positions and that represented by the square marked X would be designated as 5Y8/4; the hue being followed by the value number and separated by a stroke from the chroma number.

The Munsell chart and Ostwald's system are not all that might be desired because their construction and use are not free from subjective elements; they have other limitations such as lack of permanency of the colour standards. In 1931 the Commission Internationale de l'Eclairage, usually referred to as the C.I.E., recommended what is known as the C.I.E. system for numerical specification of colour. The foundation on which the method was based was the colour triangle illustrated in Fig. 26.9.* It is assumed that the corners of an equilateral triangle are illuminated by the

* Facing page 616.

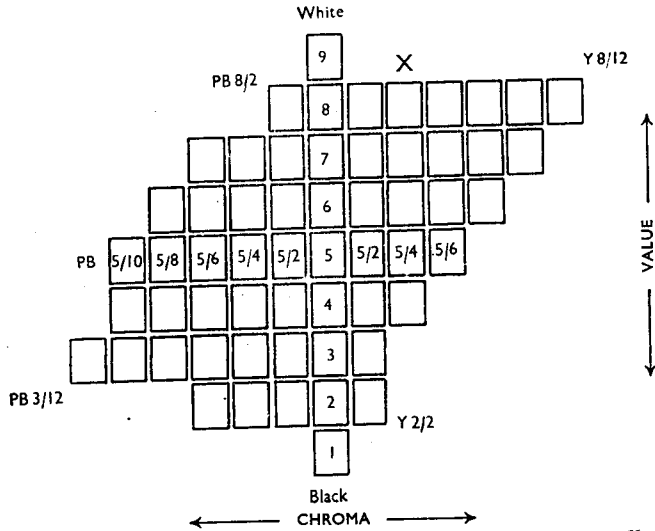

Fig. 26.8 A vertical section through the Y-PB plane of the Munsell solid
 ('The Measurement of Colour', Wright)

three additive primary colours in such a way that each becomes progressively weaker until it is completely extinguished when it reaches the side opposite the angle at which it is situated. As will be seen in the figure, the point at the centre of the triangle is illuminated equally by all the sources and is therefore an equienergy white; it is represented by the symbol S_e . Every conceivable mixture of the primary additives must exist at some point within the triangle, and every colour value (hue and saturation) can be defined by describing its location in geometrical, and therefore numerical, terms. The most convenient method is to use the co-ordinates, namely,

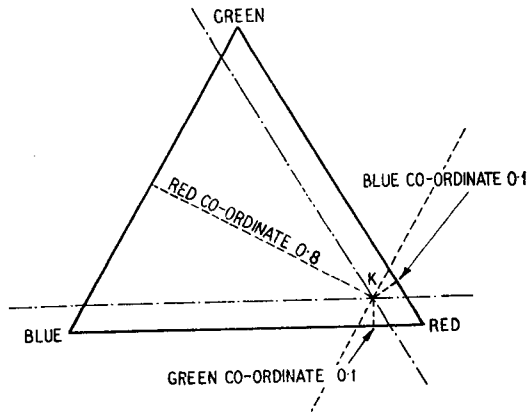

Fig. 26.10 Co-ordinates of the point K
 (Courtesy of Tintometer Ltd, Salisbury)

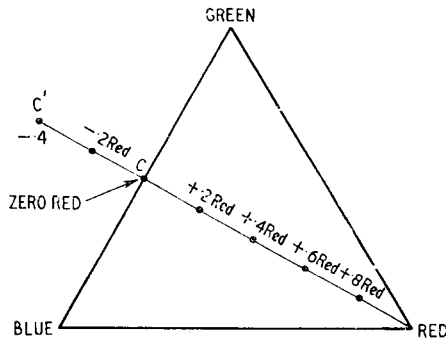

Fig. 26.11 Diagrammatic representation of spectral blue-green

(Courtesy of Tintometer Ltd, Salisbury)

the distances at which the point is situated along lines passing through it and at right-angles to the sides of the triangle. In an equilateral triangle the co-ordinates will always add up to the same total, and it is therefore convenient to treat the sum as unity. Description of the point K in the colour triangle, which is by definition equilateral, is illustrated in Fig. 26.10.

There are no additive sources of illumination giving the equivalents of all the colours in the solar spectrum with equal saturation. Thus, for example, the blue-green of the spectrum must be flattened by the addition of some red before it can be matched with the available primaries. Expressed in another way, the spectral blue-green contains a negative amount of red in relation to the triangle, and is not within the area bounded by its sides (Fig. 26.11).

Only the three additive primaries can, in fact, match the spectral hues with-

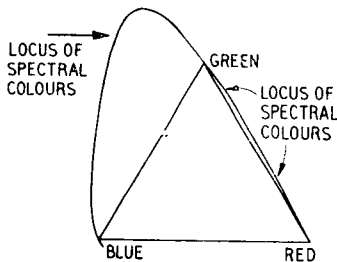

Fig. 26.12 Loci of spectral colours in relation to colour triangle

(Courtesy of Tintometer Ltd, Salisbury)

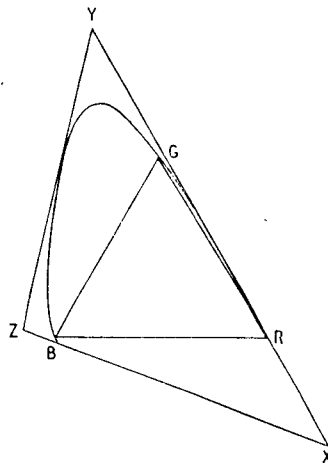

Fig. 26.13 Spectral loci curve contained within XYZ triangle

(Courtesy of Tintometer Ltd, Salisbury)

out resorting to the conception of negative quantities of one of the components. The location of the colours of the spectrum in relation to the colour triangle will be in positions on the curved line in Fig. 26.12.

In order to avoid the introduction of negative quantities the C.I.E. suggested a system for the definition of colour based on three imaginary primaries having greater saturation than their spectral equivalents, and also such that they will give an equienergy white. These are referred to as the X , Y , and Z stimuli (Fig. 26.13). They constitute a triangle enclosing the curve of the spectral loci in Fig. 26.12.

To plot colour values on a two-dimensional system it is necessary to have only two co-ordinates. With a tristimulus combination this can only be achieved when the values add up to unity; so that if X and Y are defined the value of Z is: $1 - (X + Y)$. The proportions of the imaginary stimuli in a colour can be made to add up to one by converting them into the so-called chromaticity co-ordinates (x , y , and z) by the following treatment:

$$x = \frac{X}{X + Y + Z}$$

$$y = \frac{Y}{X + Y + Z}$$

$$z = \frac{Z}{X + Y + Z}$$

It is now possible to define chromaticity with x and y co-ordinates on a two-dimensional chart, because, as explained, $Z = 1 - (X + Y)$.

When the spectral loci are plotted in this manner, with adjustments to make the XYZ triangle right-angled, the chromaticity diagram in Fig. 26.14 is obtained. The wavelengths corresponding with various positions on the curve are marked in numerals.

The line joining blue (400 nm) and red (700 nm) is called the alychne, and on it are situated purple colours which do not appear in the spectrum. All combinations of hue and saturation are enclosed within the boundaries of the spectral curve, and the approximate positions in which some of the colours are situated are shown in Fig. 26.15.

The chromaticity co-ordinates for the spectral wavelengths are shown in Table 26.1.

It will be apparent that the fully saturated colours are situated on the spectral loci curve, and saturation decreases as the central white portion is approached. A colour inside the chromaticity chart may be looked upon as the hue of the dominant wavelength, together with a measure of desaturation caused by the addition of surplus light of other wavelengths. With the additive primaries this tends to promote whiteness by increasing the spectral distribution of the reflected or emitted light.

The dominant wavelength is determined by extending a line drawn from the point of equienergy white, through the situation of the colour value, until it reaches the spectral loci curve, when the point at which it crosses

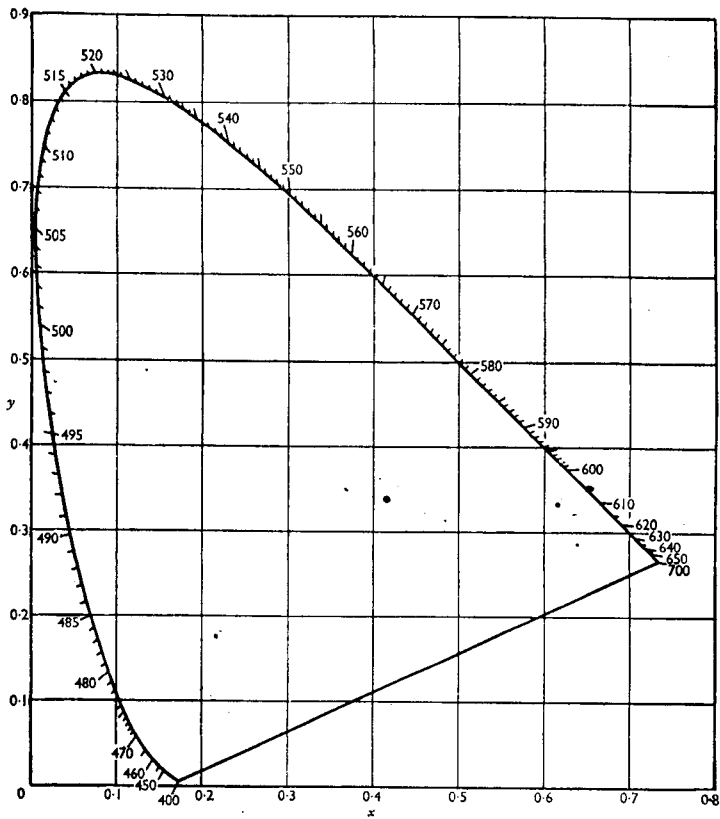

Fig. 26.14 Spectral loci on chromaticity chart
(*The Measurement of Colour*, Wright)

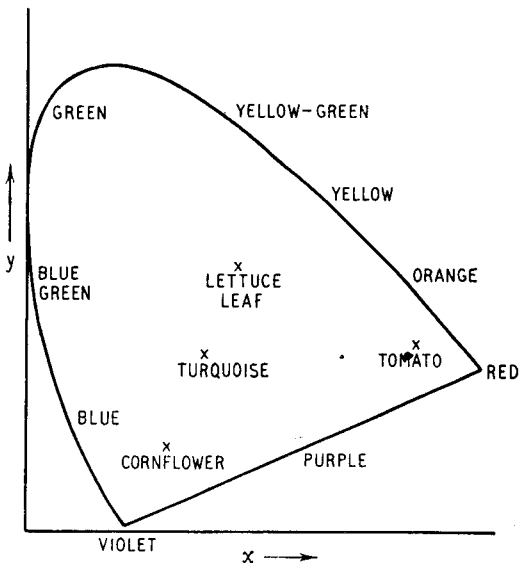

Fig. 26.15 Situation of some colours in the chromaticity chart

Table 26.1

<i>Chromaticity co-ordinates</i>			<i>Wavelength</i>
<i>x</i>	<i>y</i>	<i>z</i>	
0.1741	0.0050	0.8209	380
0.1738	0.0049	0.8213	390
0.1733	0.0048	0.8219	400
0.1726	0.0048	0.8226	410
0.1714	0.0051	0.8235	420
0.1689	0.0069	0.8242	430
0.1644	0.0109	0.8247	440
0.1566	0.0177	0.8257	450
0.1440	0.0297	0.8263	460
0.1241	0.0578	0.8181	470
0.0913	0.1327	0.7760	480
0.0454	0.2950	0.6596	490
0.0082	0.5384	0.4534	500
0.0139	0.7502	0.2359	510
0.0743	0.8338	0.0919	520
0.1547	0.8059	0.0394	530
0.2296	0.7543	0.0161	540
0.3016	0.6923	0.0061	550
0.3731	0.6245	0.0024	560
0.4441	0.5547	0.0012	570
0.5125	0.4866	0.0009	580
0.5752	0.4242	0.0006	590
0.6270	0.3725	0.0005	600
0.6658	0.3340	0.0002	610
0.6915	0.3083	0.0002	620
0.7079	0.2920	0.0001	630
0.7190	0.2809	0.0001	640
0.7260	0.2740	0.0000	650
0.7300	0.2700	0.0000	660
0.7320	0.2680	0.0000	670
0.7334	0.2666	0.0000	680
0.7344	0.2656	0.0000	690
0.7347	0.2653	0.0000	700
0.7347	0.2653	0.0000	710
0.7347	0.2653	0.0000	720
0.7347	0.2653	0.0000	730
0.7347	0.2653	0.0000	740
0.7347	0.2653	0.0000	750
0.7347	0.2653	0.0000	760
0.7347	0.2653	0.0000	770
0.7347	0.2653	0.0000	780

indicates the dominant wavelength. This is illustrated in Fig. 26.16, where the line drawn from W (white spot) through C_{xy} (the colour to be defined) meets the boundary of the chromaticity chart at λ_d , the locus corresponding

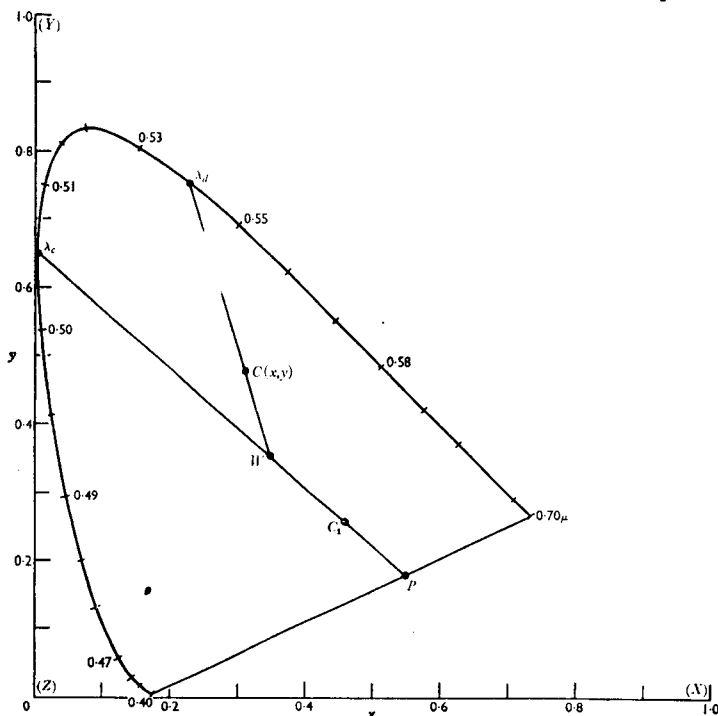

Fig. 26.16 Determination of dominant wavelength

(*'The Measurement of Colour', Wright*)

with the dominant wavelength. A slightly different procedure is used with purple shades since they have no spectral loci, and the complementary saturated colour is used. Thus in Fig. 26.16 the line through C_1 and W is extended to meet the curve at λ_c which, by convention, is quoted as the dominant wavelength.

The saturation varies from zero at the equienergy point to 100 per cent at the spectral location of the dominant wavelength. Saturation can be expressed as colorimetric purity which is:

$$\frac{F}{F + F_w}$$

in which F is the luminous flux of the dominant wavelength, and F_w is the flux of white light necessary to make the pure hue match the colour C_{xy} . It is, however, more common to describe saturation in terms of excitation purity, which is the ratio of the distances $C_{xy}W$ to $W\lambda_d$ in Fig. 26.16.

Hue and purity alone are not enough to describe the subjective sensation of colour. The element of luminosity must also be taken into account. Thus the difference between the orange represented by $x = 0.56$ and $y = 0.41$ on the chromaticity chart, and a dark brown with the same co-ordinates, is that one might have a luminosity of 25 per cent and the other 8 per cent. The complete specification of a colour, therefore, requires a third dimension and, in the C.I.E. system it is a mathematical conception that the X and Z stimuli have hue but no luminosity, and the whole of the latter attribute is contained in the Y component. Thus when the whole of the incident light is reflected, the value of Y is 1 and the colour is white. For lesser degrees of luminosity the values of Y are fractions of unity, until at zero the colour is black because there is no reflection or transmission of light. A three-dimensional colour solid is illustrated in Fig. 26.17 in which the base is black, the apex white, and in any horizontal plane saturation decreases as the location of the colour becomes nearer to the Y axis.

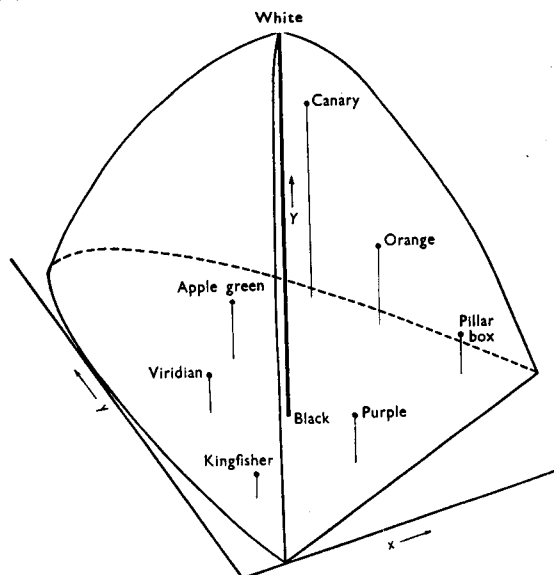

Fig. 26.17 C.I.E. three-dimensional colour space with representative colours plotted

(GUTHRIE AND OLIVER, 'J.S.D.C.', 1957)

From a consideration of the colour solid it is apparent that there is a maximum possible luminous reflectance or transmission for any specific colour value. The gamut of possible colour values diminishes as the Y value approaches 1, and a few discontinuous steps in the relationship between chromaticity and maximum luminance with standard source S_c are shown in Fig. 26.18. An interesting feature is that the highly saturated reds, yellows, and oranges situated near the spectrum loci boundary in the

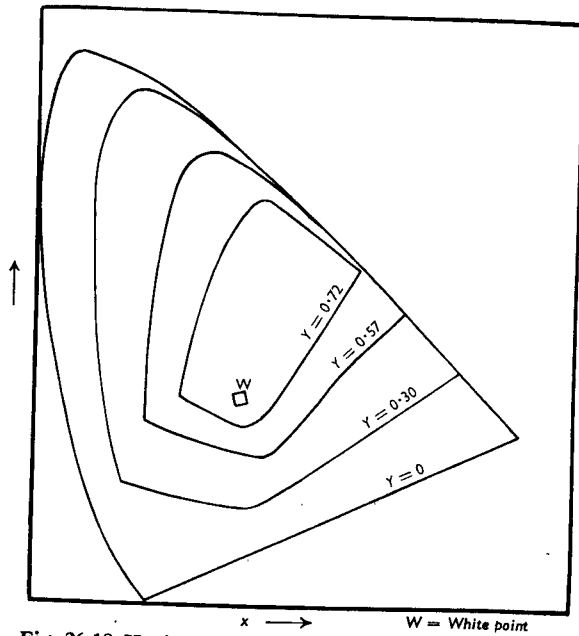

Fig. 26.18 Horizontal chromaticity planes at various values of Y

(GUTHRIE AND OLIVER, 'J.S.D.C.', 1957)

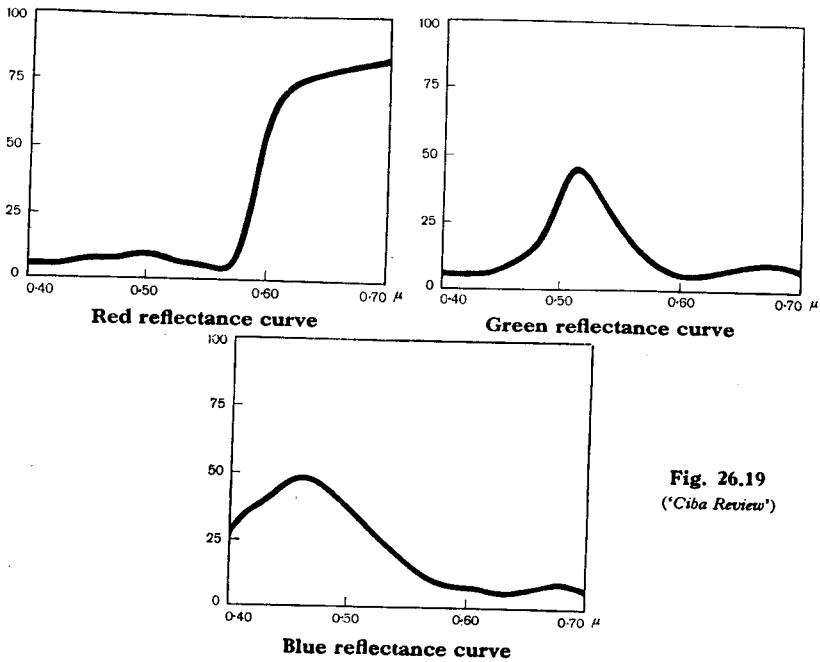

Fig. 26.19
(*'Ciba Review'*)

chromaticity chart, can have luminosity factors up to 0.72 or more, but with saturated blues and greens the corresponding values lie between 0 and 0.3. This is because yellow and red colouring matters can absorb completely all wavelengths other than those corresponding with their particular colour. Blue or green dyes or pigments, on the other hand, are less critically selective with regard to the wavelengths which they absorb. A red colouring matter, therefore, reflects a great proportion of the selected light without becoming desaturated. The reflectance curves for red, green, and blue in Fig. 26.19 show clearly the comparative selectivities.

Distribution coefficients

All the wavelengths of the spectrum must be capable of being matched by mixtures of the red, blue, and green stimuli to which the eye responds. These proportions have been measured with trichromatic colorimeters at 5 $m\mu$ intervals over the spectral range by a number of different observers. The average values are used to specify the responses of the hypothetical 'Standard Observer' and they can, by mathematical treatment, be converted into the chromaticity co-ordinates of the C.I.E. system.

The distribution coefficients (\bar{x} , \bar{y} , and \bar{z}) have been calculated for the standard observer. They are the amounts of the three imaginary reference colours, X, Y, and Z, weighted to conform with the equi-energy spectrum

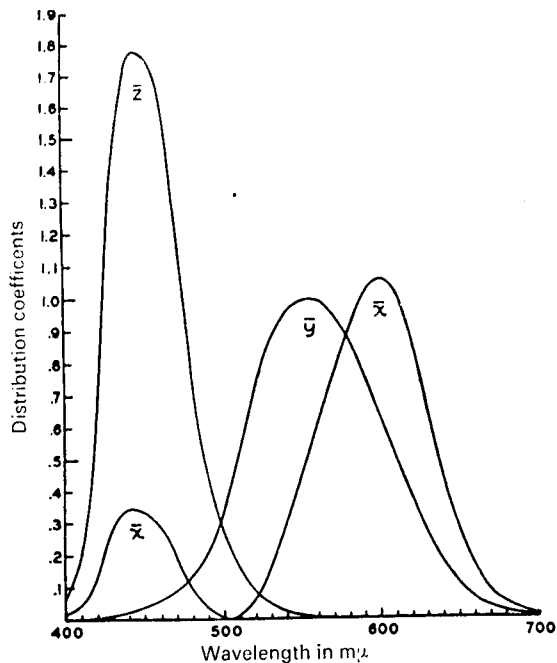

Fig. 26.20 C.I.E. distribution coefficients

required to match any wavelength in the spectrum. Their values are represented graphically in Fig. 26.20.

In 1942 MacAdam (*J. Opt. Soc. Amer.*, 1942, **32**, 247) published the result of an extensive investigation of visual sensitiveness to colour. Many observers were asked to make matchings of a range of shades with a tri-chromatic colorimeter, and their readings were converted into x and y coordinates on a chromaticity chart. The spread of readings for individual colours fell within the ellipses shown in Fig. 26.21. The important feature is that the eye is obviously less sensitive to variations in colour in the green

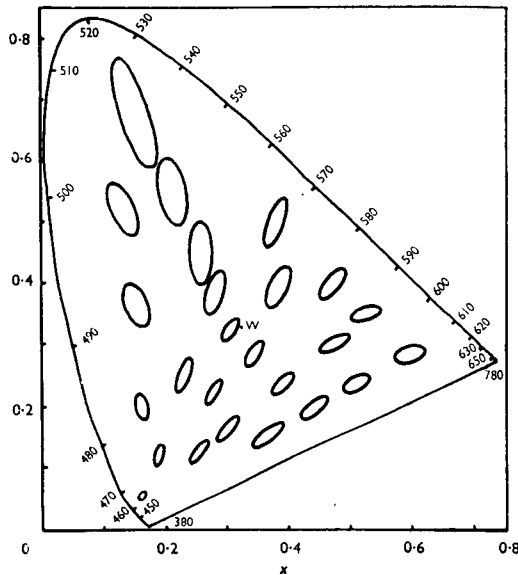

Fig. 26.21 Optical sensitivity in different regions within the chromaticity chart
(GUTHRIE AND OLIVER, 'J.S.D.C.' 1957)

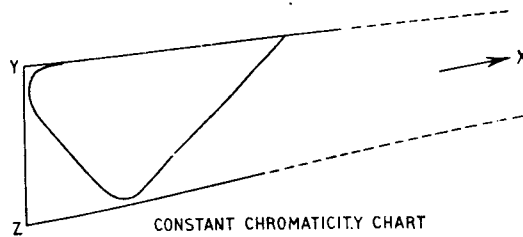

Fig. 26.22
(Courtesy of Tintometer Ltd, Salisbury)

region than in the blue. This can be objectionable when precise correlation between chromaticity and observation is necessary. It would, for instance, be advantageous if acceptable tolerances regarding variations in shade could be specified in terms of maximum distances apart on the chromaticity chart. This is not possible without allowing a different tolerance for every colour

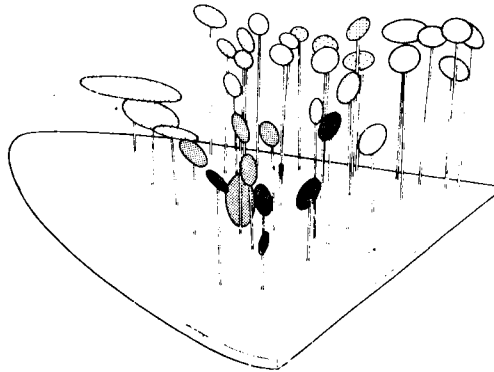

Fig. 26.23 Threshold values. Brown and MacAdam ellipsoids in C.I.E. colour body
(*Journal Opt. Soc. Am.* 39, 808, 1949)

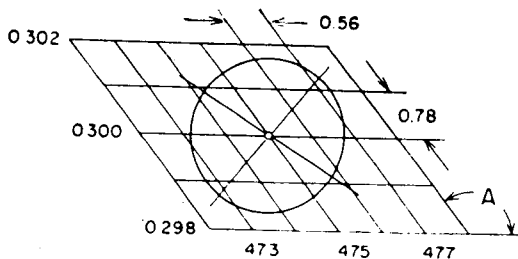
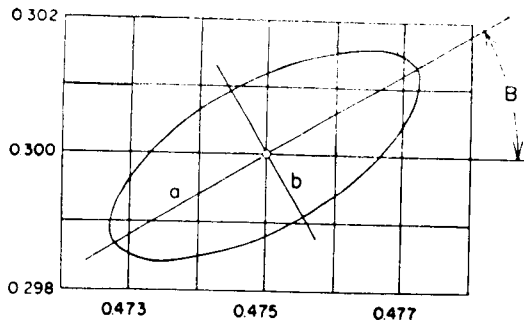

Fig. 26.24 Simon and Goodwin method of calculating small colour differences based on the MacAdam ellipses

value, owing to the variations in the sensitivity of the eye. It is possible, however, to replot the XYZ triangle in such a way that the chromaticity chart is distorted, with the result that the area where the eye is most sensitive becomes enlarged in relation to the green region. This rearrangement gives the constant chromaticity chart shown in Fig. 26.22.

The MacAdam optical sensitivity chart shown in Fig. 26.21 does not take luminence into account and Silberstein (Phil. *Mug.*, 1946, 37, 126) showed that when these ellipses were transferred to the three-dimensional version of the chromaticity chart they would be ellipsoid as shown in Fig. 26.23. In order that a really satisfactory universally applicable specification for tolerances in colour matching can be established it is desirable that these ellipsoids should be spherical. This, unfortunately, is not possible and the nearest approach is the Simon and Goodwin system which takes the form of about 100 different charts in which, by alteration of the angle of the co-ordinates of the chromaticity chart the ellipses are converted to circles. The scale is such that each half-inch is equivalent to a threshold value of discrimination Fig. 26.24 (SIMON AND GOODWIN, *Amer. Dyes Rep.*, 19.58, 105).

Standard illumination

The location of a colour in the chromaticity chart is dependent upon the nature of the incident light. The C.I.E. has, therefore, specified three standard illuminants. The first, standard illuminant A, or S_a , is a gas-filled tungsten lamp operating at 2850°K. The second is designated S_b and is equivalent to a yellower version of daylight, and consists of light from source A filtered through two cells of colourless optical glass, each 1 cm thick, containing respectively solutions of:

Copper sulphate ($\text{CuSO}_4 \cdot 5\text{H}_2\text{O}$)	2.45 g per litre
Mannite ($\text{C}_6\text{H}_8(\text{OH})_6$)	2.452 g per litre
Pyridine ($\text{C}_5\text{H}_5\text{N}$)	30 ml per litre

and

Cobalt ammonium sulphate ($\text{CoSO}_4(\text{NH}_4)_2\text{SO}_4 \cdot 6\text{H}_2\text{O}$)	21.71 g per litre
Copper sulphate ($\text{CuSO}_4 \cdot 5\text{H}_2\text{O}$)	16.11 g per litre
Sulphuric acid (sp gr 1.835)	10 ml per litre.

Finally the S_c source is equivalent to light from the north sky in the Northern Hemisphere or from the southern sky south of the equator. In this case the light from source A is filtered through two 1-cm cells containing the following solutions respectively:

Copper sulphate	3.412 g per litre
Mannite	3.412 g per litre
Pyridine	30 ml per litre

and

Cobalt ammonium sulphate	30.58 g per litre
Copper sulphate	22.52 g per litre
Sulphuric acid (sp gr 1.835)	10 ml per litre.

Measurement of colour

There are a variety of instruments available for the measurement of colour. Colorimeters usually determine the proportions of the primary additive lights which are necessary to match the colour reflected or transmitted by the sample under investigation. Spectrophotometers differ in that they record the intensity of the reflected light continuously over the whole spectral range.

One of the simplest tristimulus colorimeters is the Lovibond Tintometer. The apparatus consists essentially of a viewing tube and light reflected from a standard white surface. One half of the field is illuminated by the light reflected by, or transmitted through, the specimen under examination. The other half is illuminated directly by a beam of standard light. Into the path of the latter beam coloured glass filters of the subtractive primaries are inserted and moved by mechanical means.

The coloured glasses progress from nearly colourless to fully saturated colours in 200 carefully graded steps. The scales are additive, so that ten units marked 0.01 would equal in colour one glass graded 0.1. The primaries are also such that equal amounts of them inserted in the beam would give a neutral tint. As an example, glass slides inserted into the path of the beam equal to 9.5 units of red, 14 units of yellow, and 4.8 units of blue would transmit a brown colour.

The Lovibond-Schofield Tintometer is a modification of the simpler form of tintometer in which the readings can be converted into the x , y , and Y co-ordinates of the C.I.E. system. The instrument is based on the fact that hue and saturation can be matched with two primaries, but the third only affects the luminosity of the colour. Thus in the case of the brown shade described above, which was matched with:

9.5 units of red
4.8 units of blue
14 units of yellow

there are 4.8 units of each primary which only contribute neutral tints, and the same effect could be obtained with 4.7 units of red and 9.2 units of yellow if the amount of light passing through the filters could be diminished. In the Lovibond-Schofield instrument the relative illumination falling on the two halves of the field is varied by a movable vane operated by a calibrated control. The illumination is also rigidly controlled as to colour temperature for S_A , S_B , and S_C , as required. With the aid of nomograms the

chromaticity co-ordinates of the operative filters can be determined, and the luminosity is found by the position of the vane.

The Donaldson Tristimulus Colorimeter has been a most successful instrument but has now been replaced by more sophisticated designs. A brief description is justified because many are probably still in use, and it illustrates well the basic principles of trichromatic colorimetry. The essential features are shown diagrammatically in Fig. 26.25. Light from a standard lamp *A* passes through three filters at *C* which can be adjusted to transmit varying proportions of the additive primaries. The triple beam is directed into a spherical colour-mixing chamber at *J*. The inside of the sphere is covered with a highly reflecting surface, so that the beams of the three colours travel backwards and forwards at all conceivable angles and leave, thoroughly mixed, at *K*. The emerging light is directed to a photometric cube at *G* which causes the beam to illuminate half of the field visible through the eyepiece *E*. The other half of the field is illuminated with light from the sample at *X*. The proportions of the three stimuli are altered with

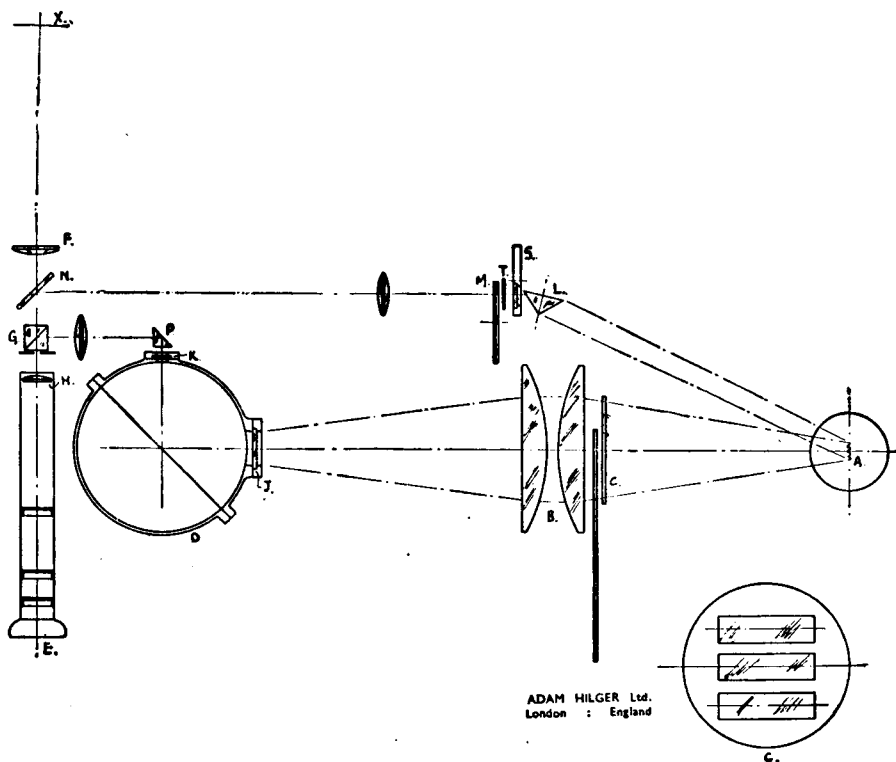

Fig. 26.25 The Donaldson Tristimulus Colorimeter

the calibrated controls, and the readings can be converted into chromaticity co-ordinates.

When the colour of the specimen is very highly saturated some desaturation of the light which it reflects or transmits may be necessary. This can be achieved by passing some of the light from lamp *A*, through the prism, *L*, and mixing it with light from the specimen by means of a transparent reflector, at *N*. This desaturation can be varied by means of an optical wedge, at *M*, or converted into one of the primaries by rotating the wheel, at *S*, in which the filters are mounted.

A disadvantage of tristimulus colorimetry is that a comparison has to be made between the product of mixing together light of three comparatively narrow wave-bands, and that reflected by the pattern which may be composed of a much more random selection of wavelengths. This can cause significant differences in readings between various observers because of minor defects in colour vision. To overcome this objection the six-stimulus Donaldson instrument was designed. The colour was matched approximately using red, orange, yellow-green, green, blue-green, and blue filters, and the final adjustment was made with the three primary stimuli.

In modern instruments the photoelectric cell gives galvanometer readings indicating the proportions of the three primary stimuli. The basic principle of a photoelectric colorimeter is illustrated very simply in Fig. 26.26. (WRIGHT, W. D., *The Measurement of Colour*.) Light reflected from the sample passes through filters, transmitting only the primaries. The three lights fall onto photoelectric cells, each producing a current which can be amplified to give a galvanometer reading proportional to the intensity of the beam. An alternative method is to use only one photoelectric cell and galvanometer and interpose the filters successively.

A typical trichromatic photoelectric colorimeter is the instrument of Hilger and Watts. The photoelectric cell, the filter, and the illuminant are contained in a mobile housing (Fig. 26.27) attached to the galvanometer

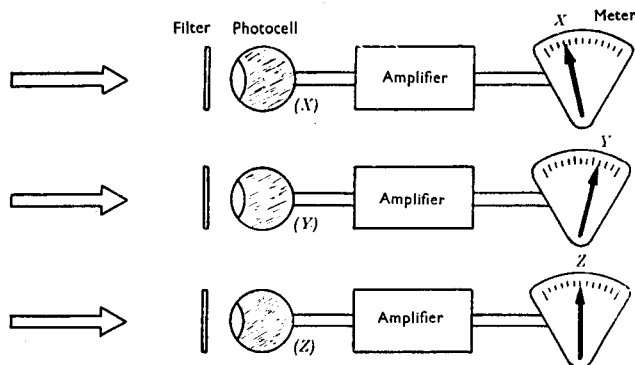

Fig. 26.26 The principle of the trichromatic photoelectric colorimeter
(*The Measurement of Colour*, Wright)

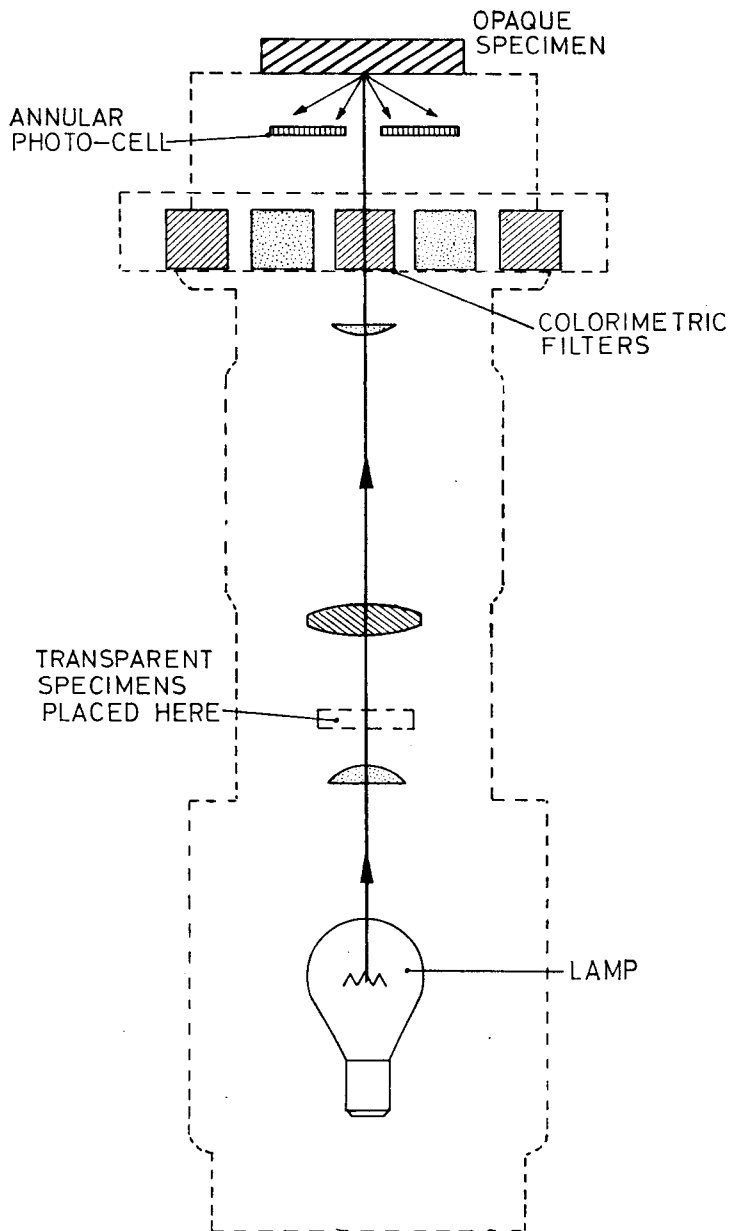

Fig. 26.27 Diagram of photoelectric colorimeter
(Hilger and Watts)

by an extensible cable, so that measurements can be made on surfaces that could not be placed in an instrument. In the base of the detachable unit there is an aperture which rests on the coloured surface under examination. The intensity of the light reflected is recorded when each of the three filters, housed in a sliding frame, is interposed in turn between the surface and the light source.

The method of operation is to adjust the instrument so that the galvanometer reads 100 when the photoelectric cell is exposed to a magnesium oxide white surface. The readings are then recorded with the red, yellow, and blue filters, resetting to 100 with magnesium oxide between each observation. Tables are available with the aid of which it is possible to convert the recordings to x , y , and z co-ordinates. The apparatus can also be used with a null indicator for more accurate work. A calibrated potentiometer controls the balancing current and the tristimulus values can be read directly on a scale. Measurements are normally made with C.I.E. illuminant S_c , but a filter is available for conversion to standard illuminant S_p . It is also possible to use a series of filters, each transmitting only a narrow band of the spectrum; making it possible to plot something approaching a spectrograph for the coloured surface.

For many commercial purposes all that is required is to assess small variations from a standard pattern and differential colorimeters are designed for this purpose. Such an instrument is shown diagrammatically in Fig. 26.28.

Light falls from the illuminant L on both the standard \check{y} and the sample H from which two separate beams are reflected. At the rotating decentered lens D they are separated into two alternating pulses, one of which can be adjusted with trichromatic filters B until it is identical with the other. The alternating pulses are directed onto a photoelectric cell A which will record whether they are different from each other or identical.

Trichromatic colorimeters are comparatively easy to construct and to use, and therefore find a place in many industrial laboratories. The spectral composition of the light under examination cannot be identical in all res-

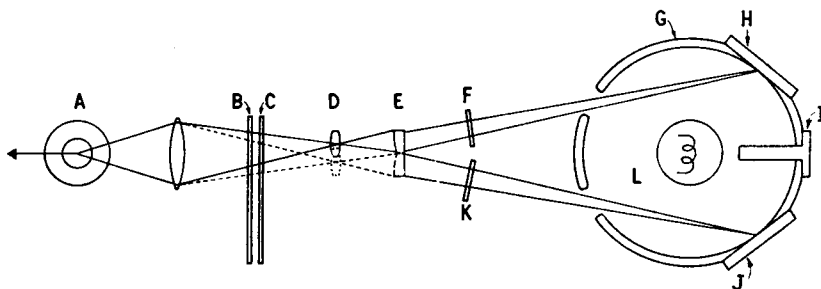

Fig. 26.28 Diagram of differential colorimeter

(Courtesy of Ciba)

pects with that obtained by mixing primary colours. As an example the continuous curve in Fig. 26.29 is the spectral distribution of additive mixtures of red and green primaries, giving an optical match with the orange light represented by the dash line. The colours would look alike to a normal observer in a standard light. If, however, the source was deficient in the

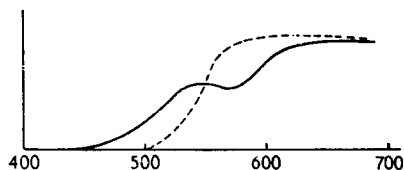

Fig. 26.29

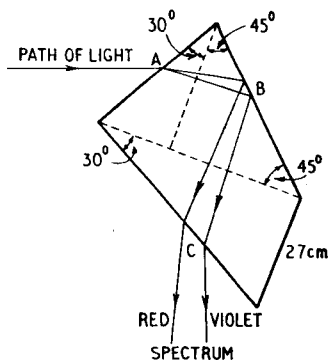

Fig. 26.30 Monochromator

450 to 500 nm range, or the observer was insensitive in this region, the two colours would not look alike.

The spectrophotometer which gives the whole spectral composition of a colour has every advantage other than simplicity. The visual spectrophotometer is the least sophisticated instrument but is tedious to operate and has, therefore, been replaced by automatic recording systems for industrial use. A description of the comparatively primitive visual apparatus is, however, justified because it affords an illustration of the principles involved.

In the Guild spectrophotometer two beams of light from the same source, one direct and the other transmitted by or reflected from the specimen, are directed onto a monochromator. The latter is a specially constructed prism in the form shown in Fig. 26.30, and it can be rotated round the axis perpendicular to the plane of this printed page when narrow sections of the spectrum will be directed in turn into the viewing field. The line diagram in Fig. 26.31 illustrates the essential features of this spectrophotometer. Two parallel beams of light from the same source are focused by lenses, L_1 and L_2 , onto slits in the collimators, S_1 and S_2 . The two beams are then brought into juxtaposition by the photometer prism, at P , after which they are directed onto the monochromator, at D . The beams are subsequently focused so that they form two separate images of the same portion of the spectrum in the eyepiece, at S_3 . The wavelength of the light under observation can be varied by rotating the monochromator. One beam has travelled directly from the source but the other has been reflected or

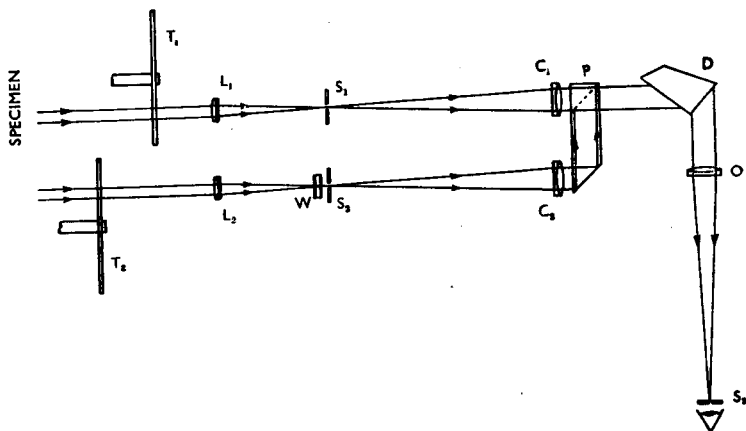

Fig. 26.31 Diagram of the Guild spectrophotometer
(The Measurement of Colour, Wright)

transmitted by the sample. The intensity of either beam can be adjusted by optical mechanisms known as sectors, at T_1 and T_2 . The final adjustment of the rays from the source can be made with a neutral optical wedge, W , in front of the collimator opening, at S_2 . From the difference in the adjustments which have to be made to the two beams to bring the halves of the field to the same intensity, the amount of light of the wavelength in question can be ascertained.

Many instruments use two beams of light polarized at right-angles to each other, and measure the relative intensities by the degree of rotation of a polarizing prism in the eyepiece required to equalize the light under inspection with that direct from the same source. Such an apparatus is the Nutting-Hilger spectrophotometer illustrated diagrammatically in Fig. 26.32. The two beams of light, one direct from the source and the other from the specimen under examination, enter at A and B and are polarized in planes at right-angles to each other by prisms, J and j . The two beams are brought into juxtaposition at K , and then pass through a polarizing

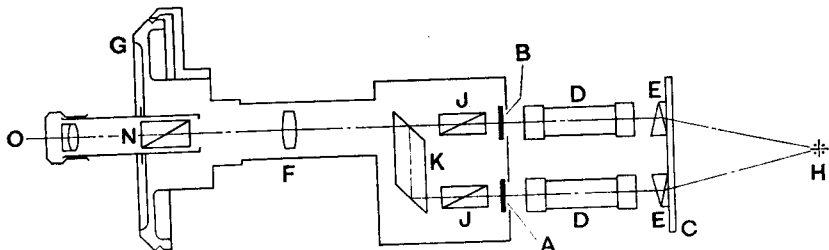

Fig. 26.32 Nutting-Hilger spectrophotometer
(Hilger and Watts)

prism, N, which can be rotated to equalize the relative intensities of the halves of the field. From the angle through which the prism, N, has to be turned, the proportion of the reflected spectral light selected by the **monochromator** situated in front of the light source can be determined.

Self-recording spectrophotometers substitute a photoelectric cell for the eye, and the electrical impulses can be amplified and converted into a continuous plot on paper attached to a rotating drum. A simplified diagram of the mode of working of the General Electric recording spectrophotometer is shown in Fig. 26.33. Light from the lamp *V* passes through slit *T* into

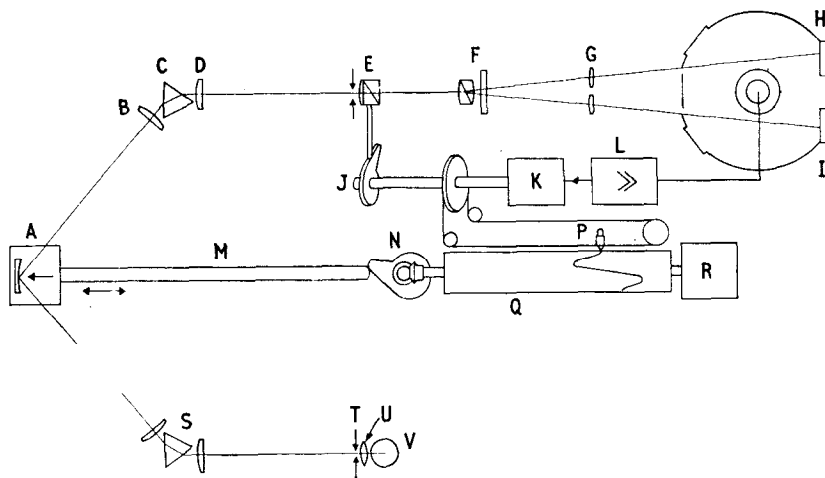

Fig. 26.33 General Electric recording spectrophotometer

(Courtesy of Ciba)

prism *S*, which throws the spectrum onto a mirror situated behind it. At this stage a narrow wave-band is selected and reflected onto prism *C*, where it is again diffracted to free it from any stray light other than that required. The monochromatic rays are polarized in a Rochon prism *E* and split into two beams with perpendicular planes of vibration by subsequent passage through a Wollaston prism *F*. The position of the Rochon prism will determine the relative intensities of the two beams emerging from the Wollaston prism. The light rays next pass through a rotating polarizing filter which causes oscillation between maximum and minimum intensity in the two beams, such that one is at its highest value when the other is at its lowest. The beams pass into an integrating sphere in such a manner that one falls onto the sample *H* and the other onto a white magnesium oxide surface *I*. The rays reflected from both surfaces are thoroughly mixed up in the integrating sphere, and the resultant flux is picked up by a photoelectric cell.

Since the reflections from the white surface and the sample are polarized in opposite planes they will cancel out when they are of equal intensity. If less light should be reflected from the sample than from the white surface, the beams will not balance and an electric current will be generated by the

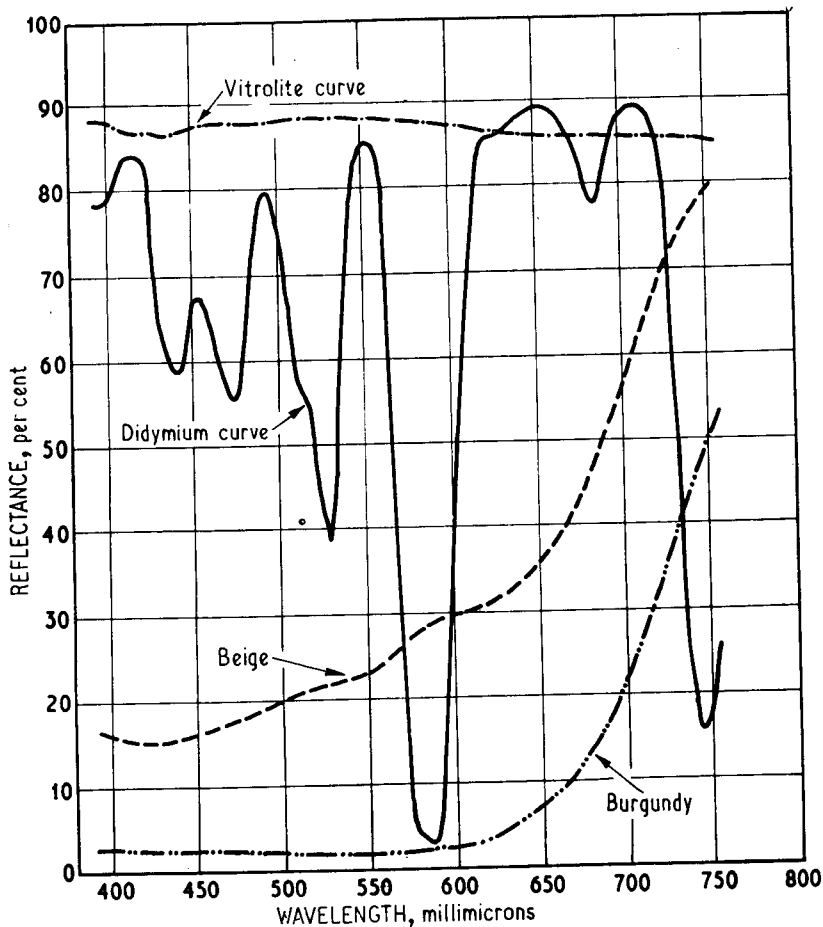

Fig. 26.34 Spectrophotometric recordings of absorption curves
(GIBSON, K. S., *Nat. Bureau of Standards, Circular 484, 1949*)

photoelectric cell which will cause a balancing motor to alter the position of the Rochon prism until the fluctuation in the light flux is extinguished. The movement of the prism is easily converted into an automatic plot on the graph paper on the rotating drum *Q*. Two typically automatically recorded plots are shown in Fig. 26.34, together with that of a vitrolite white surface and the transmission curve of didymium glass.

Instrumental match prediction

The development of instruments capable of recording the wavelengths of light reflected from dyed materials stimulated interest in the possibility of using such information to calculate the quantities of dyes required to match a given pattern. The calculations which were necessary, however, were too laborious until computers became available.

The basic information required is the relationship between reflectance of the dyed material and the concentration of the dyestuff. If a simple curve of reflectance against concentration at a specified wavelength be plotted it is very far from a straight line, but a linear relationship is desirable for instrumental match prediction.

Many efforts have been made to arrive at a mathematical expression which will give the desired linear relationship. One which has often been used is the Kubelka-Munk equation:

$$\frac{K}{S} = \frac{(1 - R)^2}{2R}$$

in which

R = reflected light
 K = coefficient of absorption
 S = coefficient of scattering.

When concentration is plotted against $(1 - R)^2/2R$ an approximately straight line results and for any one substrate and dye K/S is a constant. In fact the line meets the K/S axis somewhere above the zero intercept at a point which corresponds with K^0/S^0 for the substrate.

Alderson *et. al.* (*J.S.D.C.*, 1961, 77, 663) modified the Kubelka-Munk equation to conform to collimated incident light, as would apply in a spectrophotometer or a colorimeter, and arrived at the equation:

$$\left(\frac{1}{R_\lambda}\right) = \left(\frac{1}{R_\lambda}\right)_s + \alpha_\lambda c \quad (1)$$

in which

R_λ = the reflectance of the dyed material at the wavelength λ
 $(R_\lambda)_s$ = the reflectance of the substrate
 α = the absorption coefficient of the dye
 c = the concentration of the dye.

In normal commercial dyeing it is common practice to use three dyes in matching a pattern and then equation (1) becomes

$$\left(\frac{1}{R_\lambda}\right) = \left(\frac{1}{R_\lambda}\right)_s + \alpha\lambda_1c_1 + \alpha\lambda_2c_2 + \alpha\lambda_3c_3 \quad (2)$$

This equation, however, leaves something to be desired because it does not take into account the way the human eye synthesizes different stimuli

into an overall colour. This is, on the other hand, taken into account in the C.I.E. system and, therefore, good match prediction requires that the dyeing should have the same tristimulus values as the pattern when illuminated by the same light. This treatment requires some modification of equation (2) as shown in (3):

$$R_\lambda = \frac{1}{(1/R_\lambda)_s + \alpha\lambda_1c_1 + \alpha\lambda_2c_2 + \alpha\lambda_3c_3} \quad (3)$$

and, derived from 3, the tristimulus values are:

$$\left. \begin{aligned} X &= \int \frac{E_\lambda \cdot \bar{x}_\lambda \cdot d\lambda}{(1/R_\lambda)_s + \alpha\lambda_1c_1 + \alpha\lambda_2c_2 + \alpha\lambda_3c_3} \\ Y &= \int \frac{E_\lambda \cdot \bar{y}_\lambda \cdot d\lambda}{(1/R_\lambda)_s + \alpha\lambda_1c_1 + \alpha\lambda_2c_2 + \alpha\lambda_3c_3} \dots \\ Z &= \int \frac{E_\lambda \cdot \bar{z}_\lambda \cdot d\lambda}{(1/R_\lambda)_s + \alpha\lambda_1c_1 + \alpha\lambda_2c_2 + \alpha\lambda_3c_3} \end{aligned} \right\} \dots \quad (4)$$

Since X , Y , and Z are known by examination with a tristimulus colorimeter, the only unknown quantities are c_1 , c_2 , and c_3 , namely the concentrations of dyestuffs required to match the pattern. These equations, however, can only be solved by making a series of approximations, a procedure which was far too laborious until digital computers became available. It is easy for a computer to calculate the c values for a first trial dyeing from data fed into it relating to the dyes selected as most suitable. A trial dyeing is made with the predicted recipe and it is examined in a colorimeter. Its tristimulus values are fed into the computer, when the necessary corrections can be ascertained from the following equations:

$$\left. \begin{aligned} \Delta c_1 &= \left(\frac{\partial c_1}{\partial X} \right) \cdot \Delta X + \left(\frac{\partial c_1}{\partial Y} \right) \cdot \Delta Y + \left(\frac{\partial c_1}{\partial Z} \right) \cdot \Delta Z \\ \Delta c_2 &= \left(\frac{\partial c_2}{\partial X} \right) \cdot \Delta X + \left(\frac{\partial c_2}{\partial Y} \right) \cdot \Delta Y + \left(\frac{\partial c_2}{\partial Z} \right) \cdot \Delta Z \dots \\ \Delta c_3 &= \left(\frac{\partial c_3}{\partial X} \right) \cdot \Delta X + \left(\frac{\partial c_3}{\partial Y} \right) \cdot \Delta Y + \left(\frac{\partial c_3}{\partial Z} \right) \cdot \Delta Z \end{aligned} \right\} \dots \quad (5)$$

in which $\left(\frac{\partial c_1}{\partial X} \right)$ etc. are coefficients relating change of concentrations with

iterations in X , Y , Z values. A simplified computer flow diagram is shown in Fig. 26.35.

Comparatively simple analogue computers, specifically designed for colour formulation, have achieved a good measure of success. An example of such an instrument is the Colorant Mixture Computer (often abbreviated to COMIC) the panel of which is shown in Fig. 26.36 (DAVIDSON *et al.*, *J.S.D.C.*, 1963, 79, 577). The spectrophotometric reflections of

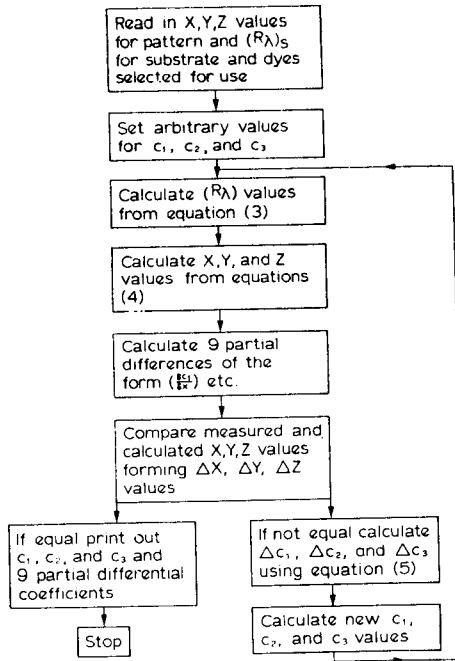

Fig. 26.35 Simplified computer flow diagram

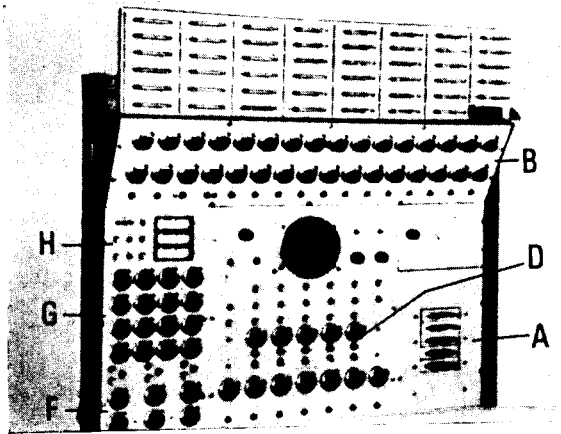

Fig. 26.36 Panel of Colorant Mixture Computer

the pattern are made at sixteen 20-nm intervals. The K/S values are calculated and are set on the dials B . Sixteen spots on the oscilloscope display unit will then appear representing the reflectance curve of the standard to be matched.

There are a number of plug-in electrical resistance boxes containing spectral characteristics of the dyes, and those corresponding with the dyes that have been selected are inserted at A . The concentration dials at D are then adjusted till all the dots lie on the straight line across the oscilloscope display window (Fig. 26.37), when the necessary concentrations can be read on the dials. The positions of the dots represent $\Delta K/S$ between the pattern and the selected dyes at sixteen spectral intervals and when all the spots are on the meridian line $\Delta K/S = \text{zero}$ in every case. If, however, it is not possible to bring $\Delta K/S$ to zero at all the sixteen spectral intervals it may be that the wrong dye or dyes have been chosen and another selection must be made.

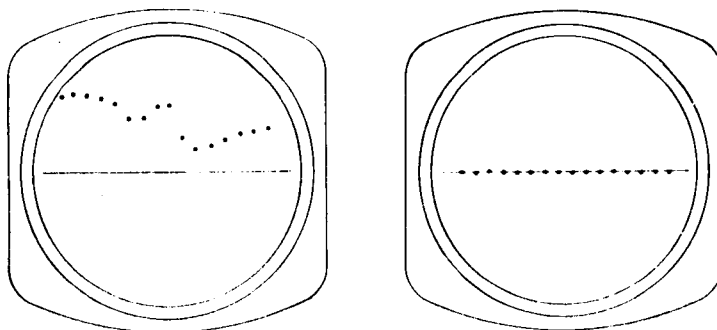

Fig. 26.37 Spectro photometric curves before and after adjustment of concentration dials

Sometimes even after exhaustive selection it will not be possible to find dyes with which all the dots can be brought to the zero line. In such cases a metameric match must be made by using ΔX , ΔY , and ΔZ , by switching the computer to tristimulus recipe prediction. The sixteen $dR/dK/S$ functions for the pattern are set on the bank of dials G and the ΔX , ΔY and ΔZ dials F are set to zero.

Selected dye boxes are plugged in and the concentration dials are adjusted till the three meters H read zero, when the appropriate recipe will be recorded on the concentration dials. Any single or compromise illuminant can be used for matching.

A further development, is the Redicolour Computer (Redifon Ltd). By mathematical treatment the so-called C function is substituted for K/S of the Kubelka–Munk equation. It is claimed that by working with this C function there is improved accuracy of dye prediction, especially in heavier shades.

The instrument consists of three main parts. In the first place there is the photometer which measures reflectance at sixteen spectral points. The absorption properties of the dyes at these sixteen wavelengths are stored in dye boxes (Fig. 26.38) and two variables are allowed for each wavelength so that one can make the necessary compensations for the natural colour of the substrate, a factor of increased significance when dyeing pale shades.

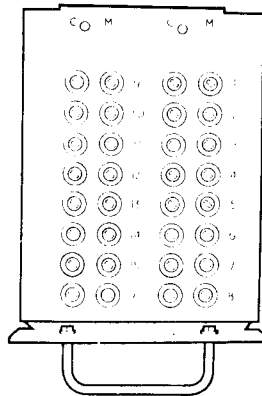

Fig. 26.38 Dye box

The second component is the automatic data transfer link. This can accept the sixteen spectral reflectance readings from the photometer. They are then automatically converted into C values and fed into the computer. This avoids the use of tables to convert readings into K/S or C values, thereby saving time and eliminating a possible source of human error.

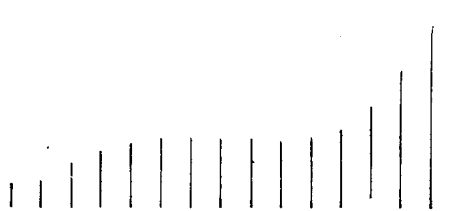

Fig. 26.39 Spectral display of pattern

The third stage is the recipe calculating computer. This shows the spectral plot of the pattern on the oscilloscope screen in the form of a 'match-stick' display as shown in Fig. 26.39. Its general shape helps in the selection of the most suitable combination of dyes. The computer is then switched to the match mode when the display appears in a form most suitable for match prediction as shown in Fig. 26.40. The dye boxes are

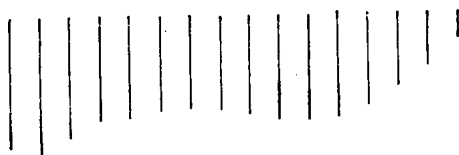

Fig. 26.40 Spectral display set for matching

then plugged in and the concentration dials are adjusted till all the 'match-stick' lines are reduced to spots across the centre of the screen (Fig. 26.41), when the required dye concentrations will be recorded on the dials. If a



Fig. 26.41 Spectral display adjusted for a match

metameric match must be made the computer is switched to tristimulus prediction and any one of six built-in illuminants may be selected. The concentration controls are adjusted until the tristimulus meters record zero readings. The dyeing recipe can then be ascertained by reading the dials on the concentration controls.

In practice the customary procedure is to carry out the dyeing with the predicted recipe, possibly with some reduction in quantities as a precaution. A sample is then cut off and inserted in the photometer together with the pattern and the spectral reflectances are fed into the computer which will compute the additions which are required to bring the dyeing onto shade.

Acknowledgment

THE illustrations reproduced by courtesy of Tintometer Ltd, Salisbury, were taken from *The C.I.E. International Colour System Explained*, by G. J. Chamberlin.

Appendix · Miscellaneous information and tables

Comparative temperatures: centigrade and fahrenheit

°C	°F	°C	°F	°C	°F	°C	°F
-5	+23·0	31	87·8	67	152·6	103	217·4
-4	24·8	32	89·6	68	154·4	104	219·2
-3	26·6	33	91·4	69	156·2	105	221·0
-2	28·4	34	93·2	70	158·0	106	222·8
-1	30·2	35	95·0	71	159·8	107	224·6
0	32·0	36	96·8	72	161·6	108	226·4
+1	33·8	37	98·6	73	163·4	109	228·2
2	35·6	38	100·4	74	165·2	110	230·0
3	37·4	39	102·2	75	167·0	111	231·8
4	39·2	40	104·0	76	168·8	112	233·6
5	41·0	41	105·8	77	170·6	113	235·4
6	42·8	42	107·6	78	172·4	114	237·2
7	44·6	43	109·4	79	174·2	115	239·0
8	46·4	44	111·2	80	176·0	116	240·8
9	48·2	45	113·0	81	177·8	117	242·6
10	50·0	46	114·8	82	179·6	118	244·4
11	51·8	47	116·6	83	181·4	119	246·2
12	53·6	48	118·4	84	183·2	120	248·0
13	55·4	49	120·2	85	185·0	121	249·8
14	57·2	50	122·0	86	186·8	122	251·6
15	59·0	51	123·8	87	188·6	123	253·4
16	60·8	52	125·6	88	190·4	124	255·2
17	62·6	53	127·4	89	192·2	125	257·0
18	64·4	54	129·2	90	194·0	126	258·8
19	66·2	55	131·0	91	195·8	127	260·6
20	68·0	56	132·8	92	197·6	128	262·4
21	69·8	57	134·6	93	199·4	129	264·2
22	71·6	58	136·4	94	201·2	130	266·0
23	73·4	59	138·2	95	203·0	131	267·8
24	75·2	60	140·0	96	204·8	132	269·6
25	77·0	61	141·8	97	206·6	133	271·4
26	78·8	62	143·6	98	208·4	134	273·2
27	80·6	63	145·4	99	210·2	135	275·0
28	82·4	64	147·2	100	212·0	136	
29	84·2	65	149·0	101	213·8	137	
30	86·0	66	150·8	102	215·6	138	

Conversion formulae:

Centigrade to fahrenheit: $\times \frac{9}{5} + 32$

Fahrenheit to centigrade: $-32 \times \frac{5}{9}$

Comparison of the hydrometer degrees according to Baumé and Twaddell with the specific gravities

Baumé	Twad- dell	Specific gravity	Baumé	Twad- dell	Specific gravity	Baumé	Twad- dell	Specific gravity
0	0	1.000	19.3	31	1.155	36.0	66.4	1.332
0.7	1	1.005	19.8	32	1.160	36.2	67	1.335
1.0	1.4	1.007	20.0	32.4	1.162	36.6	68	1.340
1.4	2	1.010	20.3	33	1.165	37.0	69	1.345
2.0	2.8	1.014	20.9	34	1.170	37.4	70	1.350
2.1	3	1.015	21.0	34.2	1.171	37.8	71	1.355
2.7	4	1.020	21.4	35	1.175	38.0	71.4	1.357
3.0	4.4	1.022	22.0	36	1.180	38.2	72	1.360
3.4	5	1.025	22.5	37	1.185	38.6	73	1.365
4.0	5.8	1.029	23.0	38	1.190	39.0	74	1.370
4.1	6	1.030	23.5	39	1.195	39.4	75	1.375
4.7	7	1.035	24.0	40	1.200	39.8	76	1.380
5.0	7.4	1.037	24.5	41	1.205	40.0	76.6	1.383
5.4	8	1.040	25.0	42	1.210	40.1	77	1.385
6.0	9	1.045	25.5	43	1.215	40.5	78	1.390
6.7	10	1.050	26.0	44	1.220	40.8	79	1.395
7.0	10.2	1.051	26.4	45	1.225	41.0	79.4	1.397
7.4	11	1.055	26.9	46	1.230	41.2	80	1.400
8.0	12	1.060	27.0	46.2	1.231	41.6	81	1.405
8.7	13	1.065	27.4	47	1.235	42.0	82	1.410
9.0	13.4	1.067	27.9	48	1.240	42.3	83	1.415
9.4	14	1.070	28.0	48.2	1.241	42.7	84	1.420
10.0	15	1.075	28.4	49	1.245	43.0	84.8	1.424
10.6	16	1.080	28.8	50	1.250	43.1	85	1.425
11.0	16.6	1.083	29.0	50.4	1.252	43.4	86	1.430
11.2	17	1.085	29.3	51	1.255	43.8	87	1.435
11.9	18	1.090	29.7	52	1.260	44.0	87.6	1.438
12.0	18.2	1.091	30.0	52.6	1.263	44.1	88	1.440
12.4	19	1.095	30.2	53	1.265	44.4	89	1.445
13.0	20	1.100	30.6	54	1.270	44.8	90	1.450
13.6	21	1.105	31.0	54.8	1.274	45.0	90.6	1.453
14.0	21.6	1.108	31.1	55	1.275	45.1	91	1.455
14.2	22	1.110	31.5	56	1.280	45.4	92	1.460
14.9	23	1.115	32.0	57	1.285	45.8	93	1.465
15.0	23.2	1.116	32.4	58	1.290	46.0	93.6	1.468
15.4	24	1.120	32.8	59	1.295	46.1	94	1.470
16.0	25	1.125	33.0	59.4	1.297	46.4	95	1.475
16.5	26	1.130	33.3	60	1.300	46.8	96	1.480
17.0	26.8	1.134	33.7	61	1.305	47.0	96.6	1.483
17.1	27	1.135	34.0	61.6	1.308	47.1	97	1.485
17.7	28	1.140	34.2	62	1.310	47.4	98	1.490
18.0	28.4	1.142	34.6	63	1.315	47.8	99	1.495
18.3	29	1.145	35.0	64	1.320	48.0	99.6	1.498
18.8	30	1.150	35.4	65	1.325	48.1	100	1.500
19.0	30.4	1.152	35.8	66	1.330	48.4	101	1.505

Percentages of caustic soda and caustic potash in caustic lyes

<i>Specific gravity</i>	<i>Na₂O, per cent</i>	<i>NaOH, per cent</i>	<i>K₂O, per cent</i>	<i>KOH, per cent</i>
1·0035	0·23	0·30	0·35	0·45
1·0070	0·47	0·61	0·70	0·90
1·0105	0·70	0·90	1·05	1·30
1·0141	0·93	1·20	1·40	1·70
1·0177	1·26	1·60	1·80	2·15
1·0213	1·55	2·00	2·20	2·60
1·0249	1·83	2·36	2·55	3·05
1·0286	2·10	2·71	2·90	3·50
1·0323	2·35	3·03	3·35	4·00
1·0360	2·60	3·35	3·80	4·50
1·0397	2·85	3·67	4·25	5·05
1·0435	3·10	4·00	4·70	5·60
1·0473	3·35	4·32	5·05	6·00
1·0511	3·60	4·64	5·40	6·40
1·0549	3·85	4·96	5·80	6·80
1·0588	4·10	5·29	6·20	7·40
1·0627	4·32	5·58	6·55	7·80
1·0667	4·55	5·87	6·90	8·20
1·0706	4·82	6·21	7·30	8·70
1·0746	5·08	6·55	7·70	9·20
1·0787	5·37	6·76	8·10	9·65
1·0827	5·67	7·31	8·50	10·10
1·0868	5·84	7·66	8·85	10·50
1·0909	6·20	8·00	9·20	10·90
1·0951	6·46	8·34	9·65	11·45
1·1000	6·73	8·68	10·10	12·00
1·1035	7·06	9·05	10·45	12·45
1·1077	7·30	9·42	10·80	12·90
1·1120	7·55	9·74	11·25	13·35
1·1163	7·80	10·06	11·60	13·80
1·1206	8·22	10·51	12·00	14·30
1·1250	8·50	10·97	12·40	14·80
1·1294	8·84	11·42	12·80	15·25
1·1339	9·18	11·84	13·20	15·70
1·1383	9·49	12·24	13·55	16·10
1·1423	9·80	12·64	13·90	16·50
1·1474	10·15	13·00	14·35	17·15
1·1520	10·50	13·55	14·80	17·60
1·1566	10·82	13·86	15·20	18·10
1·1613	11·14	14·37	15·60	18·60
1·1660	11·43	14·75	16·00	19·05
1·1707	11·73	15·13	16·40	19·50
1·1755	12·03	15·50	16·80	20·00
1·1803	12·33	15·91	17·20	20·50
1·1852	12·66	16·38	17·60	20·95
1·1901	13·00	16·77	18·00	21·40
1·1950	13·35	17·22	18·40	21·90
1·2000	13·70	17·67	18·80	22·50
1·2050	14·05	18·12	19·20	22·85
1·2101	14·40	18·58	19·60	23·30
1·2152	14·74	19·08	19·95	23·75
1·2202	15·18	19·58	20·30	24·20
1·2255	15·67	20·08	20·70	24·65
1·2308	15·96	20·59	21·16	25·10

Percentages of caustic soda and caustic potash in caustic lyes—*continued*

<i>Specific gravity</i>	<i>Na₂O, per cent</i>	<i>NaOH, per cent</i>	<i>K₂O, per cent</i>	<i>KOH, per cent</i>
1·2361	16·36	21·00	21.50	25·60
1·2414	16·76	21.42	21·90	26·10
1·2468	17.18	22.03	22.30	26.50
1.2522	17·55	22·64	22.70	27·00
1.2576	17·85	23.15	23·10	27·50
1.2632	18.35	23·67	23.50	28·00
1·2687	18.78	24·24	23.85	28·45
1.2743	19.23	24.81	24.20	28.90
1·2800	19.61	25.30	24·60	29.35
1.2857	20·00	25.80	25.00	29.80
1·2905	20·40	26.31	25·40	30.25
1·2973	20.80	26.83	25.80	30.70
1·3032	21.02	27.31	26.25	31.25
1.3091	21.55	27.89	26.70	31.80
1.3151	21.95	28.31	27.10	32.25
1.3211	22·35	28.83	27.50	32.70
1.3272	22.67	29.38	27·90	33.20
1.3333	23.20	29.93	28.30	33.70
1.3395	23.75	30·57	28·80	34.30
1.3458	24.20	31·22	29.30	34.90
1.3521	24.68	31.85	29.75	35·40
1.3585	25·17	32.47	30·20	35.90
1·3649	25.68	33.08	30·60	36.40
1.3714	26.12	33.69	31·00	36·90
1.3780	26.61	34.38	31·40	37.35
1.3846	27.10	34.96	31·80	37.80
1.3913	27.60	35·65	32.25	38.35
1.3981	28.10	36.25	32.70	38.90
14049	28·58	36·86	33.10	39.40
1.4187	29.56	38.13	33.95	40.40
1.4267	30·08	38.80	34.40	40.90
1.4328	30.54	39.39	34.90	41.50
1.4400	31.00	39.99	35·40	42·10
1.4472	31·50	40·75	35.95	42·75
1.4545	32.10	41.41	36.50	43.40
1·4619	32.65	42.12	37·00	44·00
1.4694	33.20	42.83	37.50	44·60
1.4769	33.80	43.66	38·00	45.20
1.4845	34.40	44.38	38·50	45.80
1·4922	35 05	45.27	39·05	46.45
1·5000	35.50	46·15	39.60	47·10
1.5079	36.30	46.86	40·15	47·70
1.5158	36.90	47.60	40·60	48·30
1.5238	37.45	48·81	41·50	48.85
1·5310	38·00	49·02	41.50	49.40

Sulphuric acid

Temperatures of dry saturated steam

°Bé	Sp gr	°Tw	Per cent H ₂ SO ₄	Absolute pressure in lb per sq in.	Temperature °C	Temperature °F
0	1.0000	0.0	0.00			
1	1.0069	1.4	1.02			
2	1.0140		2.08			
3	1.0211	4.2	3.13	14.69	100.0	212.0
4	1.0284	5.7	4.21	20	108.9	228.0
5	1.0432	7.1	5.22	30	121.3	250.3
6	1.0507	10.0	6.37	40	130.7	267.2
7			7.45	50	138.3	280.9
8	1.0584	11.7	8.55	60	144.8	292.6
9	1.0741	13.2	9.66	70	150.5	302.8
10	1.0821	14.8	10.77	80	155.5	311.9
11	1.0902	16.4	11.89	90	160.1	320.2
12	1.0985	18.0	13.01	100	164.3	327.7
13	1.1069	19.7	14.13	110	168.2	334.7
14	1.1154	21.4	15.25	120	171.7	341.1
15	1.1240	23.1	16.38	130	175.1	347.2
16	1.1328	24.8	17.53	140	178.3	353.0
17	1.1417	26.6	18.71	150	181.3	358.4
18	1.1508	28.3	19.89	160	184.1	363.5
19	1.1508	30.2	21.07	170	186.9	368.4
20	1.1600	32.0	22.25	180	189.4	373.0
21	1.1694	33.9	23.43	190	191.9	377.5
22	1.1788	35.8	24.61	200	194.3	381.8
23	1.1983	38.7	25.81	210	196.7	386.0
24	1.2083		27.03	220	198.9	390.0
25	1.2185	41.7	28.28	230	201.0	393.8
26		43.7	29.53	240	203.1	397.6
27	1.2288	45.8	30.79	250	205.1	401.2
28	1.2393	47.9	32.05	260	207.1	404.7
29	1.2500	50.0	33.33	270	208.9	408.1
30	1.2609	52.2	34.63	280	210.8	411.4
31	1.2719	54.4	35.93	290	212.5	414.6
32	1.2832	56.6	37.26	300	214.3	417.8
33	1.2946	58.9	38.58	320	217.7	423.8
34	1.3063	61.3	39.92	340	220.9	429.6
35	1.3182	63.6	41.27	360	223.9	435.1
36	1.3303	66.1	42.63	380	226.9	440.4
37	1.3426	68.5	43.99	400	229.7	445.5
38	1.3551	71.0	45.35	420	232.5	450.5
39	1.3679	73.6	46.72	440	235.1	455.2
40	1.3810	76.2	48.10	460	237.7	459.8
41	1.3942	78.8	49.47	480	240.2	464.3
42	1.4078	81.6	50.87	500	242.6	468.6
43	1.4216	84.3	52.26	600	253.3	488.3
44			53.66	700	262.8	505.5
45	1.4356	87.0	55.07	800	271.6	520.9
46	1.4500		56.48	900	279.3	534.7
47	1.4646	99.9	57.90	1000	286.3	547.3
48	1.4796		59.32	1500	314.6	598.2
49	1.5104	105.0	60.75	2000	336.0	636.8
50	1.5263		62.18			
51	1.5426	108.5	63.66			
52	1.5591	111.8	65.13			
53	1.5761	115.2	66.63			
54	1.5934	118.7	68.13			
55	1.6111	122.2	69.65			
56	1.6292	125.8	71.17			
57	1.6477	129.5	72.75			
58	1.6667	133.3	74.36			
59	1.6860	137.2	75.99			
60	1.7059	141.2	77.67			
61	1.7262		79.43			
62			81.30			
63	1.7470	153.7	83.34			
64	1.7683	158.0	85.66			
64½	1.7957	159.1	86.33			
64¾	1.8012	160.2	87.04			
65	1.8068	161.4	87.81			
65½	1.8125		88.65			
65¾	1.8182	162.5	89.55			
65¾	1.8239	164.8	90.60			
65¾		165.9	91.80			
65¾	1.8354	167.1	93.19			

Decinormal solutions

Potassium permanganate

3.161 g per litre
 1 ml = 0.0016 g oxygen
 = 0.0034 g hydrogen peroxide

Sodium thiosulphate

24.815 g of Na₂S₂O₃·5H₂O per litre
 1 ml = 0.00355 g chlorine

Arsenious oxide

4.9455 g of As₂O₃ per litre
 1 ml = 0.00355 g chlorine

Hydrochloric acid

$^{\circ}\text{Bé}$	Sp gr	$^{\circ}\text{Tzw}$	$\% \text{HCl}$	$^{\circ}\text{Bé}$	Sp gr	$^{\circ}\text{Tzw}$	$\% \text{HCl}$	$^{\circ}\text{Bé}$	Sp gr	$^{\circ}\text{Tzw}$	$\% \text{HCl}$
1.00	1.0069	1.38	1.40	16.0	1.1240	24.80	24.57	20.8	1.1675	33.50	32.93
2.00	1.0140	2.80	2.82	16.1	1.1248	24.96	24.73	20.9	1.1684	33.68	33.12
3.00	1.0211	4.22	4.25	16.2	1.1256	25.12	24.90	21.0	1.1694	33.88	33.31
4.00	1.0284	5.68	5.69	16.3	1.1265	25.30	25.06	21.1	1.1703	34.06	33.50
5.00	1.0357	7.14	7.15	16.4	1.1274	25.48	25.23	21.2	1.1713	34.26	33.69
5.25	1.0375	7.50	7.52	16.5	1.1283	25.66	25.39	21.3	1.1722	34.44	33.88
5.50	1.0394	7.88	7.89	16.6	1.1292	25.84	25.56	21.4	1.1732	34.64	34.07
5.75	1.0413	8.26	8.26	16.7	1.1301	26.02	25.72	21.5	1.1741	34.82	34.26
6.00	1.0432	8.64	8.64	16.8	1.1310	26.20	25.89	21.6	1.1751	35.02	34.45
6.25	1.0450	9.00	9.02	16.9	1.1319	26.38	26.05	21.7	1.1760	35.20	34.64
6.50	1.0469	9.38	9.40	17.0	1.1328	26.56	26.22	21.8	1.1770	35.40	34.83
6.75	1.0488	9.76	9.78	17.1	1.1336	26.72	26.39	21.9	1.1779	35.58	35.02
7.00	1.0507	10.14	10.17	17.2	1.1345	26.90	26.56	22.0	1.1789	35.78	35.21
7.25	1.0526	10.52	10.55	17.3	1.1354	27.08	26.73	22.1	1.1798	35.96	35.40
7.50	1.0545	10.90	10.94	17.4	1.1363	27.26	26.90	22.2	1.1808	36.16	35.59
7.75	1.0564	11.28	11.32	17.5	1.1372	27.44	27.07	22.3	1.1817	36.34	35.78
8.00	1.0584	11.68	11.71	17.6	1.1381	27.62	27.24	22.4	1.1827	36.54	35.97
8.25	1.0603	12.06	12.09	17.7	1.1390	27.80	27.41	22.5	1.1836	36.72	36.16
8.50	1.0623	12.46	12.48	17.8	1.1399	27.98	27.58	22.6	1.1846	36.92	36.35
8.75	1.0642	12.84	12.87	17.9	1.1408	28.16	27.75	22.7	1.1856	37.12	36.54
9.00	1.0662	13.24	13.26	18.0	1.1417	28.34	27.92	22.8	1.1866	37.32	36.73
9.25	1.0681	13.62	13.65	18.1	1.1426	28.52	28.09	22.9	1.1875	37.50	36.93
9.50	1.0701	14.02	14.04	18.2	1.1435	28.70	28.26	23.0	1.1885	37.70	37.14
9.75	1.0721	14.42	14.43	18.3	1.1444	28.88	28.44	23.1	1.1895	37.90	37.36
10.00	1.0741	14.82	14.83	18.4	1.1453	29.06	28.61	23.2	1.1904	38.08	37.58
10.25	1.0761	15.22	15.22	18.5	1.1462	29.24	28.78	23.3	1.1914	38.28	37.80
10.50	1.0781	15.62	15.62	18.6	1.1471	29.42	28.95	23.4	1.1924	38.48	38.03
10.75	1.0801	16.02	16.01	18.7	1.1480	29.60	29.13	23.5	1.1934	38.68	38.26
11.00	1.0821	16.42	16.41	18.8	1.1489	29.78	29.30	23.6	1.1944	38.88	38.49
11.25	1.0841	16.82	16.81	18.9	1.1498	29.96	29.48	23.7	1.1953	39.06	38.72
11.50	1.0861	17.22	17.21	19.0	1.1508	30.16	29.65	23.8	1.1963	39.26	38.95
11.75	1.0881	17.62	17.61	19.1	1.1517	30.34	29.83	23.9	1.1973	39.46	39.18
12.00	1.0902	18.04	18.01	19.2	1.1526	30.52	30.00	24.0	1.1983	39.66	39.41
12.25	1.0922	18.44	18.41	19.3	1.1535	30.70	30.18	24.1	1.1993	39.86	39.64
12.50	1.0943	18.86	18.82	19.4	1.1544	30.88	30.35	24.2	1.2003	40.06	39.86
12.75	1.0964	19.28	19.22	19.5	1.1554	31.08	30.53	24.3	1.2013	40.26	40.09
13.00	1.0985	19.70	19.63	19.6	1.1563	31.26	30.71	24.4	1.2023	40.46	40.32
13.25	1.1006	20.12	20.04	19.7	1.1571	31.44	30.90	24.5	1.2033	40.66	40.55
13.50	1.1027	20.54	20.45	19.8	1.1581	31.62	31.08	24.6	1.2043	40.86	40.78
13.75	1.1048	20.96	20.86	19.9	1.1590	31.80	31.27	24.7	1.2053	41.06	41.01
14.00	1.1069	21.38	21.27	20.0	1.1600	32.00	31.45	24.8	1.2063	41.26	41.24
14.25	1.1090	21.80	21.68	20.1	1.1609	32.18	31.64	24.9	1.2073	41.46	41.48
14.50	1.1111	22.22	22.09	20.2	1.1619	32.38	31.82	25.0	1.2083	41.66	41.72
14.75	1.1132	22.64	22.50	20.3	1.1628	32.56	32.01	25.1	1.2093	41.86	41.99
15.00	1.1154	23.08	22.92	20.4	1.1637	32.74	32.19	25.2	1.2103	42.06	42.30
15.25	1.1176	23.52	23.33	20.5	1.1647	32.94	32.38	25.3	1.2114	42.28	42.64
15.50	1.1197	23.94	23.75	20.6	1.1656	33.12	32.56	25.4	1.2124	42.48	43.01
15.75	1.1219	24.38	24.16	20.7	1.1666	33.32	32.75	25.5	1.2134	42.68	43.40

Allowance for temperature

10°-15° Bé—1/40° Bé or 0.0002 sp gr for 1°F
 15°-22° Bé—1/30° Bé or 0.0003 " " 1°F
 22°-25° Bé—1/28° Bé or 0.00035 " " 1°F

Specific gravity of*Acetic acid at 15°C**Formic acid at 20°C*

<i>Specific gravity</i>	<i>Per cent</i>	<i>Specific gravity</i>	<i>Per cent in weight</i>	<i>Per cent in volume</i>
0.9992	0	0.9983	0	0.00
1.0007	1	1.0020	1	0.82
1.0022	2	1.0041	2	1.64
1.0037	3	1.0071	3	2.48
1.0052	4	1.0094	4	3.30
1.0067	5	1.0116	5	4.14
1.0083	6	1.0142	6	4.98
1.0098	7	1.0171	7	5.81
1.0113	8	1.0197	8	6.68
1.0127	9	1.0222	9	7.55
1.0142	10	1.0247	10	8.40
1.0214	15	1.0371	15	12.80
1.0284	20	1.0489	20	17.17
1.0350	25	1.0610	25	21.73
1.0412	30	1.0730	30	26.37
1.0470	35	1.0848	35	31.10
1.0523	40	1.0964	40	35.90
1.0571	45	1.1086	45	40.82
1.0615	50	1.1208	50	45.88
1.0653	55	1.1321	55	51.01
1.0685	60	1.1425	60	56.13
1.0712	65	1.1544	65	61.44
1.0733	70	1.1656	70	66.80
1.0746	75	1.1770	75	72.27
1.0748	80	1.1861	80	77.67
1.0739	85	1.1954	85	83.19
1.0713	90	1.2045	90	88.74
1.0660	95	1.2141	95	94.48
1.0553	100	1.2213	100	100.00

Specific gravities of ammonium hydroxide at 15°C (*Lunge and Wiernik*)

Specific gravity 15°	Per cent NH ₃	1 Litre contains g NH ₃	Correction of the specific gravity for + 1°C	Specific gravity at 15°	Per cent NH ₃	1 Litre contains g NH ₃	Correction of the specific gravity for + 1°C
1.000	0.00	0.0	0.00018	0.940	15.63	146.9	0.00039
0.998	0.45	4.5	0.00018	0.938	16.22	152.1	0.00040
0.996	0.91	9.1	0.00019	0.936	16.82	157.4	0.00041
0.994	1.37	13.6	0.00019	0.934	17.42	162.7	0.00041
0.992	1.84	18.2	0.00020	0.932	18.03	168.1	0.00042
0.990	2.31	22.9	0.00020	0.930	18.64	173.4	0.00042
0.988	2.80	27.7	0.00021	0.928	19.25	178.6	0.00043
0.986	3.30	32.5	0.00021	0.926	19.87	184.2	0.00044
0.984	3.80	37.4	0.00022	0.924	20.49	189.3	0.00045
0.982	4.30	42.2	0.00022	0.922	21.12	194.7	0.00046
0.980	4.80	47.0	0.00023	0.920	21.75	200.1	0.00047
0.978	5.30	51.8	0.00023	0.918	22.39	205.6	0.00048
0.976	5.80	56.6	0.00024	0.916	23.03	210.9	0.00049
0.974	6.30	61.4	0.00024	0.914	23.68	216.3	0.00050
0.972	6.80	66.1	0.00025	0.912	24.33	221.9	0.00051
0.970	7.31	70.9	0.00025	0.910	24.99	227.4	0.00052
0.968	7.82	75.7	0.00026	0.908	25.65	232.9	0.00053
0.966	8.33	80.5	0.00026	0.906	26.31	238.3	0.00054
0.964	8.84	85.2	0.00027	0.904	26.98	243.9	0.00055
0.962	9.35	89.9	0.00028	0.902	27.65	249.4	0.00056
0.960	9.91	95.1	0.00029	0.900	28.33	255.0	0.00057
0.958	10.47	100.3	0.00030	0.898	29.01	260.5	0.00058
0.956	11.03	105.4	0.00031	0.896	29.69	266.0	0.00059
0.954	11.60	110.7	0.00032	0.894	30.37	271.5	0.00060
0.952	12.17	115.9	0.00033	0.892	31.05	277.0	0.00060
0.950	12.74	121.0	0.00034	0.890	31.75	282.6	0.00061
0.948	13.31	126.2	0.00035	0.888	32.50	288.6	0.00062
0.946	13.88	131.3	0.00036	0.886	33.25	294.6	0.00063
0.944	14.46	136.5	0.00037	0.884	34.10	301.4	0.00064
0.942	15.04	141.7	0.00038	0.882	34.95	308.3	0.00065

pH intervals over which indicators change colour

<i>Indicator</i>	<i>pH range</i>	<i>Acid-alkali colour change</i>
Methyl violet	0.1-3.2	yellow-violet
Metaniline yellow	1.2-2.3	red-yellow
Thymolsulphone phthalein	1.2-2.6	red-yellow
Tropaeolin OO	1.3-3.2	red-yellow
Benzopurpurin	1.3-5.0	bluish-violet-orange
Dimethyl yellow (= dimethylaminoazo benzene)	2.9-4.0	red-blue
Methyl orange	3.1-4.4	red-orange-yellow
Tetrabromophenolsulphone phthalein	3.0-4.6	yellow-blue
Congo red	3.0-5.2	bluish-violet-red
Sodium alizarin	3.7-5.2	yellow-violet
Methyl red	4.2-6.3	red-yellow
Lucmoid	4.4-6.4	red-blue
p-Nitrophenol	5.0-7.0	colourless-yellow
Dibromocresolsulphone phthalein	5.2-6.8	yellow-purple
Dibromothymolsulphone phthalein	6.0-7.6	yellow-blue
Neutral red	6.8-8.0	red-yellow
Phenolsulphone phthalein	6.8-8.4	yellow-red
Rosolic acid	6.9-8.0	brown-red
o-Cresolsulphone phthalein	7.2-8.8	yellow-red
Brilliant yellow	7.4-8.5	yellow-reddish-brown
α -Naphtholphthalein	7.3-8.7	pink-blue
Tropaeolin OOO	7.6-8.9	brownish-yellow-pink
Turmeric	7.8-9.2	yellow-reddish-brown
Thymolsulphone phthalein	8.0-9.6	yellow-blue
Phenolphthalein	8.2-10.0	colourless-red
Thymolphthalein	9.3-10.5	colourless-blue
Alizarin yellow	10.1-12.1	yellow-lilac
Tropaeolin O	11.0-13.0	yellow-orangeish-brown
Alizarin blue S	11.0-13.0	green-blue

Equivalent British and Metric measures of volume

<i>Gallons</i>	<i>Litres</i>	<i>Litres</i>	<i>Gallons</i>	<i>Pints</i>	
1	=	4.5460	1	=	0 1 $\frac{3}{4}$
2	=	9.0919	2	=	0 3 $\frac{1}{2}$
3	=	13.6379	3	=	0 5 $\frac{1}{4}$
4	=	18.1839	4	=	0 7
5	=	22.7298	5	=	1 0 $\frac{3}{4}$
6	=	27.2758	6	=	1 2 $\frac{1}{4}$
7	=	31.8217	7	=	1 4 $\frac{1}{4}$
8	=	36.3737	8	=	1 6
9	=	40.9137	9	=	1 7 $\frac{3}{4}$
10	=	45.460	10	=	2 1 $\frac{1}{2}$
20	=	90.919	11	=	2 3 $\frac{1}{4}$
30	=	136.379	12	=	2 5
40	=	181.839	13	=	2 7
50	=	227.298	14	=	3 0 $\frac{3}{4}$
60	=	272.758	15	=	3 2 $\frac{1}{4}$
70	=	318.217	16	=	3 4 $\frac{1}{4}$
80	=	363.737	17	=	3 6
90	=	409.137	18	=	3 7 $\frac{3}{4}$
100	=	454.596	19	=	4 1 $\frac{1}{4}$
200	=	909.193	20	=	4 3 $\frac{1}{4}$
300	=	1363.789	21	=	4 5
400	=	1818.385	22	=	4 6 $\frac{3}{4}$
500	=	2272.982	23	=	5 0 $\frac{1}{4}$
1000	=	4545.963	24	=	5 2 $\frac{1}{4}$
			25	=	5 4
			50	=	11 0
			75	=	16 4
			100	=	22 0

Metric and other conversion factors

<i>To convert</i>	<i>Multiply by</i>
Metres into feet	3.2809
Yards into metres	0.9144
Metres into yards	1.0936
Miles into kilometres	1.6093
Kilometres into miles	0.6214
Square inches into square feet	0.00694
Square feet into square inches	144
Square inches into square centimetres	6.4516
Square centimetres into square inches	0.155
Square feet into square metres	0.0929
Square metres into square feet	10.764
Square yards into square metres	0.8361
Square metres into square yards	1.196
Cubic inches into cubic feet	0.00058
Cubic feet into cubic inches	1728
Cubic inches into cubic centimetres	16.387
Cubic centimetres into cubic inches	0.06104
Cubic feet into gallons	6.235
Gallons into cubic feet	0.16037
Cubic inches into gallons	0.0036
Gallons into cubic inches	277
Cubic feet into litres	28.32
Litres into cubic feet	0.0353
Cubic centimetres into pints	0.00176
Pints into cubic centimetres	567.936
Gallons into litres	4.5436
Litres into gallons	0.2202
Grains into ounces	0.00228
Ounces into grains	437.5
Grains into grams	0.0648
Grams into grains	15.4323
Ounces into grams	28.3495
Grams into ounces	0.0353
Pounds into kilograms	0.45359
Kilograms into pounds	2.2046

Standard regains

<i>Fibre</i>	<i>Regain</i> (per cent of dry weight)
Worsted tops, in oil	19
Worsted yarns	18.25
Worsted tops, dry	18.25
Woollen yarns	17
Wool, scoured	16
Worsted and woollen cloths	16
Wool noils	14
Viscose rayon	14
Jute	13.75
Shoddy	13
Flax and hemp	12
Silk	11
Mercerized cotton	11
Cotton	8.5
Acetate rayon	6
Nylon	4
'Terylene' polyester fibre	0.5

Counts of yarn

The English count of a yarn is expressed as the number of hanks, of a given length, per lb.

Cotton is calculated on a basis of	840 yards
Spun silk is calculated on a basis of	840 yards
Linen is calculated on a basis of	300 yards
Worsted is calculated on a basis of	560 yards
Woollen (Yorkshire) is calculated on a basis of	256 yards
Woollen (Dewsbury) is calculated on a basis of	16 yards
Woollen (West of England) is calculated on a basis of	320 yards
Woollen (Galashiels) is calculated on a basis of	300 yards
	(per 24 oz)

Silk, nylon, and rayon: The denier count is the weight in grams of 9000 metres

Tex system

Internationally recognized system.

The thickness of the yarn is expressed in grammes per 1000 metres.

Conversion factors:

- Divide 590.5 by English cotton count to give tex number
- Divide 590.5 by tex number to give cotton count
- Divide 885.5 by worsted count to give tex number
- Divide 885.5 by tex number to give worsted count
- Divide 1938 by woollen count to give tex number
- Divide 1938 by tex number to give woollen count.

Index of Names

- Abbott, 498, 552
Adam, 190
Adkins, 14
Aickin, 202
Alderson, 643
Alexander, 87, 90, 91, 261, 273, 275, 276,
279, 281, 319, 401
Ardron, 502
Armstrong, 304
Astbury, 17, 86, 87
- Baddiley, 507
Bader, 496
Badische, 9
Bayer, li
Bainbridge, 271
Baldwin, 280
Barr, 278, 279, 280
Bate, 515
Beal, 401
Beckmann, 138, 373
Bell, 87, 165, 286
Bellhouse, 401
Bernberg, 112
Bevan, 114, 126
Bird, 509, 510
Birtwell, 229
Bleachers' Association, 278
Bohn, 10, 439, 480
Bohnert, 537, 538
Booker, 307, 309
Böttiger, 8, 405
Boulton, 328, 415
Böwe, 266
Bowman, 78, 317
Bradley, 482, 605
Bragg, 17
Braun, 46
Brown, 143, 611, 632
Bulow, 508
Bury, 306
Butterworth, 428
- Capp, 280
Carter, 275, 281
Carothers, 131, 132, 140
Chaikin, 216
Chamberlain, 261, 264, 513
Chardonnet, 109, 110
Cheetham, 340
Chesner, 205, 236
Chibnall, 43
Ciba, 153
Clayton, 271, 603, 606
Clegg, 386
Clibbens, 50, 53, 55, 229
- Coates, 309
Coffey, 520
Collie, 189
Collins, 577, 579
Cook, 552
cooper, 55
Corey, 88
Coutie, 400
cox, 497
Crick, 88
Cross, 114, 126
Crowder, 245, 254
Cunliffe, 275, 293
- Darawulla, 484
Davis, 200, 299
Debye, 29
Denham, 104
Denyer, 568
Derbyshire, 325, 386, 389
Derrett-Smith, 605
Derry, 231
Dickey, 513
Dickinson, 401
Dickson, 104, 141, 142
Donnan, 60, 194
Dupaisis, 112
Du Pont, 131, 145
Duveen, 535
- Earland, 281
Edwards, 271, 288
Elliott, 276, 611
Elöd, 94
Elsworth, 250, 288
Ender, 439
Evans, 470
Everest, 460, 462
- Fairhead, 264
Fargher, 43
Farrington, 278
Farrow, 53
Fern, 525
Ferne, 277
Fierz-David, 425, 529
Fitzsimmons, 493
Flatters, 71
Foulds, 289
Fowler, 528, 534
Fox, 91, 482, 483, 502
Freudenberg, 46, 73
Freundlich, 389, 410
Frick, 298
Frost, 535
Fuggitt, 388

- Garrett, 105
 Garvie, 323
 Geake, 50, 53
 Giles, 410
 Glenz, 373
 Gomborg, 305
 Goodwin, 633
 Graebe, 7, 303, 431
 Graham, 258
 Green, 406; 420, 506, 603
 Greisheim Elektron A. G., 445
 Griess, 7
 Griffiths, 323
 Gustav, 388
 Guthrie, 296, 629, 630
 Gutmann, 292
- Hadfield, 554
 Hagenbach, 435
 Hall, 276, 277
 Hamer, 170, 312
 Harbome, 195
 Harris, 250, 387, 388
 Hassan, 410
 Haworth, 45
 Hayes, 613
 Hearle, 20
 Heighway-Bury, 297
 Helmholtz, 616
 Hendry, 162, 166
 Hewitt, 105
 Hilger and Watts, 636
 Hirst, 46, 90
 Hodgson, 408
 Hoffman, 5
 Holland Ellis, 10, 507
 Hooke, 109
 Horn, 91
 Horsfall, 487
 Houtz, 14
 Howard, 260
 Huckel, 458
 Hudson, 87, 90, 91, 275, 319
- Irvine, 46
- Jackson, 170
 Jones, 91
 Jordinson, 617
- Kekulé, 7
 King, 195
 Klingsberg, 600, 611
 Knight, 386
 Kornreich, 491
 Kraic, 255
 Kramrisch, 584, 585
- Lalor, 433
 Laska, 9
 Latraille, 270
 Laue, 16
 Laurie, 487
 Lawrence, 194
 Lead, 409, 593
 Lees, 288
- Lemin, 400, 412, 415, 416, 577, 579
 Leuchs, 279
 Liebermann, 7, 303, 431
 Lightfoot, 7
 Lilienfeld, 121
 Lipson, 260, 277
 Lister, 382
 Little, 228
 Lodge, 470
 Loewe, 541
 Lowe, 62
 Lutzel, 541
- McAdam, 630, 632, 633
 McBain, 195
 McLaren, 588, 592, 593, 595., 617
 Madaras, 299
 Mark, 17
 Manchester, 509
 Marsden, 408
 Marsh, 289, 291, 293
 Martin, 261, 263, 434
 Mather and Platt, 210
 Matter, 529
 Medlock, 6
 Meggy, 321
 Meister Lucius and Bruning, 9
 Mellor, 517, 518
 Menkart, 261, 262, 263
 Mercer, 62, 266
 Meunier, 270, 278
 Meyer, 17, 256, 407, 508
 Middlebrook, 278
 Midgelow, 611
 Miles, 126
 Minshall, 617
 Mittlemann, 261
 Moilliet, 189
 Morton Sundour, 496
 Muller, 439
 Myerson, 27
- Natta, 13
 Neale, 53, 60, 323
 Neish, 270, 281
 Nicholson, 6, 378
 Nietzki, 435
 Noble, 392
 Norden, 271
- Oliver, 629, 630
 Olpin, 514, 518, 519
 Owen, 201
- Paine, 409
 Palmer, 202
 Parker, 278
 Pamell, 2
 Partridge, 275
 Pasteur, 99
 Patel, 493
 Patterson, 172
 Pauling, 88
 Pauly, 112, 287
 Perkin, 5, 7, 269, 431, 515
 Perryman, 392

- Peters, 401, 407, 409, 483, 548, 551
 Pfeil, 411
 Phillips, 278, 286
 Pliny, 1
 Preston, 46, 525, 528, 534
 Priestman, 213
 Probert, 43

 Rao, 484, 610
 Rattee, 440, 441
 Raynes, 273, 274
 Read Holliday, 9
 Reading, 328, 415
 Reeves, 296
 Reid, 297, 298
 Rettie, 613
 Rice, 613, 614
 Rich, 88
 Richardson, 497
 Ridge, 55, 228, 229
 Rimington, 287
 Ringel, 91
 Ritter, 466
 Robinson, 263
 Rose, 409
 Row, 460, 491
 Ryan, 169

 Sagar, 400
 Samson, 216
 Sandmeyer, 435
 Saunders, 506
 Sanderson, 286
 Schetty, 441
 Schirm, 409
 Schofield, 493
 Schuster, 508
 Schutzenburger, 126
 Schwartzbach, 178
 Schweitzer, 112
 Shah, 610
 Sharmg, 554
 Shorter, 262
 Silberstein, 633
 Simon, 633
 Skelly, 244, 245
 Smith, 250
 Speakman, 90, 92, 95, 128, 260, 261, 262,
 270, 278, 279, 280, 281, 386, 387, 438
 Speke, 502
 Sramek, 611, 612
 Stacey, 401
 Stanford, 128
 Statham, 258
 Steinhart, 387, 388
 Stevens, 401, 438
 Stevenson, 273, 274, 275

 Stock, 613, 614
 Stott, 95, 260, 387
 Straw, 196
 Stubbs, 278
 Summersgill, 176
 Sumner, 409, 483, 492
 Sunder, 496
 Swan, 109

 Taylor, 568
 Telesz, 611
 Thiele, 112
 Thomson, 482
 Thurston, 170
 Tilak, 484
 Titterington, 613
 Tootal Broadhurst Lee, 289
 Topham, 117
 Townend, 552
 Trotman, 105, 267, 270, 278, 279, 285, 286
 Turner, 57, 486

 Vaeck, 55
 Venkataraman, 611
 Verguin, 6
 Vickers, 412, 415
 Vickerstaff, 383, 388, 412, 415, 492, 523,
 561
 Vjidal, 9, 463
 Von Baeyer, 10

 Wallwark, 460, 462, 515
 Ward, 410
 Waters, 492, 508
 Weaver, 298
 Whewell, 286
 Whinfield, 141, 142
 White, 245
 Whittaker, 416
 Wiltshire, 456, 489, 497
 Witt, 303
 Wolfram, 28
 Wood, 2, 277, 286, 289, 297, 519
 Wool Industries Research Association, 79,
 270, 271
 Worshipful Company of Dyers, 2
 Wright, 636

 Young, 616

 Zahn, 94
 Zanker, 470
 Zerweck, 466
 Ziegler, 13, 380
 Zimm, 27
 Zitscher, 9, 447

Index of Dyestuffs

- Acilan Brilliant Blue FFR, 590
 Alizarin, 430
 Afizarine Light Blue 4GL, 590
 — Red R, 381
 — Yellow 2G, 435
 Alkali Blue, 6
 Aniline Black, 7
 Artisil Brilliant Rose 5BP, 510
 — Direct Blue ERT, 513
 — — BSQ, 550
 — — Brown H, 513
 — — Violet 2RP, 559
 — — Yellow G, 510
 Auramine, 372
 Azo Geranine 2G, 380, 552
- Benzo Para Deep Brown G, 424
 Benzopurpurine 4B, 408
 — 10B, 419
 — test for mercerization, 64
 Benzo Viscose Blue 4GFL, 415
 Bismarck Brown, 8, 370
 Bleu de Lyons, 6, 378
- Caledon** Blue GCP, 577
 — — RC, 481, 489, 494
 — — XRC, 490
 — — Brilliant Orange 6R, 492, 577
 — — Purple 4RP, 490
 — — Red 3B, 492, 577
 — — Violet 3BS, 494
 — — — R, 494, 566, 577
 — — Brown R, 492, 578
 — — Dark Blue G, 577
 — — BMS, 494
 — — Brown 2G, 578
 — — — 6R, 578
 — — — 4RS, 494
 — — Gold Orange 3G, 577
 — — Golden Yellow GK, 566
 — — Green 7G, 577
 — — Grey MS, 494
 — Jade Green 3B, 482, 577
 — — — XN, 494, 577
 — — Olive Green B, 577
 — — Orange 2RT, 482
 — — Pink RL, 577
 — — Printing Yellow 6G, 577
 — — Red Violet 2RN, 577
 — — Yellow 4G, 577
 — — Yellow 5G, 492, 494
 Carbide Black ER, 424
 Carbolan Blue B, 575
 — — Crimson 3B, 575
 — — Green G, 575
- Carbolan Yellow R, 575
 Celanthrene Brilliant Blue FFS, 514
 Celliton Fast Yellow RRA/CF, 510
 Chloramine Red B, 381
 — — Yellow 2G, 419
 Chlorantine Fast Black 2G, 425
 — — — Blue 8G, 529
 — — — Green 10GL, 529
 — — — Violet 2RLL, 419
 — — — Yellow BS, 417
 — — — RLSW, 419
 Chlorazol Black BH, 413, 423
 — — — GF, 419
 — — — JH, 423
 — — — LF, 425
 — — — Brown GM, 406
 — — — Fast Helio 2RK, 413
 — — — Orange R, 419
 — — — — TR, 423, 424
 — — — Rose BS, 417
 — — — Sky Blue FF, 412
 — — — Yellow G, 419
 — — — 6G, 414
 Chrome Orange R, 436
 — — Yellow, 5
 Chrysoidene, 8
Chrysofenine, 412, 413
 Ciba Orange R 492
 Cibacet Blue BR, 510
 Cibacet Diazo Black B 519
 — — Orange 2R, 507, 510
 — — Red 3B, 559
 — — Rubine R 510, 513
 — — Scarlet BRN, 550
 — — Yellow GBA, 550
 — — 4GC, 513
 Cibacron Black RP, 530
 — — Brilliant Blue C4GP, 530
 — — Turquoise Blue G, 530
 Cibanone Red 4B, 494
 — — Yellow G, 492
 Cibantine Brown BR, 497
 Cloth Red 2B, 380
 Congo Red, 8, 405
Coomassie Brilliant Blue R, 381, 590
 — — Fast Grey G 381
 — — Green T, 381
 — — Navy Blue G, 381
 — — Turquoise Blue 3G, 381
 — — Violet 2R, 379
 Copper Blue G, 427
 Coprantex B, 426
 Coprantine Grey G, 427
 Cuprefix Dyes, 426
 — — Navy Blue CGBL, 427

Cuprophényl Navy Blue BL, 427
Crystal Violet, 7, 317, 369

Diamond Black F, 11
Dianisidine Blue, 445
Diazamine Blue G 423
Diazamine Fast Green **GL**, 423
Diazo Brilliant Orange GR, 415

— Brown **3RNA.CF**, 405
— Fast Yellow **3GLL**, 423
Diazophényl Red LN, 423
Diphenyl Blue **5B**, 414
— Brown CB, 414
— Chrysoine, 406
— Fast Red **5BL**, **419**
— Orange GG, **424**
— Red BS, 413, 414
Direct Black E, 425
— Blue BT, 417
— Fast Scarlet **3BS**, 414
— — Yellow **3G**, 413
— Red 0,424

Disperse Yellow **3G**, 510
Dispersol Black B, 518
— Brilliant Blue CB, 569
— Diazo Black B, 550, 567
— Fast Orange A 510
— — — **B**, 510
— — — G, 550, 567, 569
— — — Red R, 510
— — — Scarlet B 565
— — — Yellow A 513, 569
— — — G, 569

Disulphine Blue V 383
Duranol Blue G 559
— — **2G**, 510
— — Green B 569
— Brilliant Blue CB, 507, 513
— — Violet BR, 507
— Red **2B**, 569
— — GN, 513
— Violet RN, 510
Durazol Blue **8G**, 407
— Red **2B**, 414
Durindone Red B, 566
— Scarlet Y, 566

Eastman Fast Blue GFL, 514
Eclipse Brilliant Blue **2RL**, 467
Eriochrome **Azurole** B, 436
— Black T, 435, 436

Fast Blue BB Base, 448
— Bordeaux BD Base, 448
— Orange G Base, 448
— Red B Base, 448
— Red G Base, 121
— Red GL Base, 448
— Salts, Coupling, 458
— Scarlet GG Base, 448
— — LG Base, 448
— — VD Base, 448

Flavanthrone, 481
Fuchsine, 6

Helidon Pink R, 121
Hoffman Violet, 7

Immedial Black FF, 463
— Orange C, 465
— Yellow GG, 464
Indanthrene Blue, 10
— — CG, 481
— — R C, 492
— — RS, 121,480
— Golden Orange G 481
— Khaki, 483
— Yellow **FFRK**, 483
— Yellow G 481
Indigo, 121, 492
— Carmine, 476
Indigosol Blue AGC, 590
Indirubin, 477
Ionamine Black AS, 507
— Red K 507
Irgalan Brown Violet DL, 442
— Grey BL, 401

Kiton Blue A 379
— Yellow S, 381

Lissamine Fast Yellow **2G**, 399, 552
— Flavine FF, 398, 399
— Green SF, 379
— Red **7BPS**, 552
— Rhodamine B 378, 379
— Rhodamine G 379
Lyons Black, 435

Magenta, 6, 593
Malachite Green, 368
Mauveine, 370
Meldola Blue, 369
Merantine Blue, 379
Methyl Green, 368, 369
Methyl Violet, 7
Methylene Blue, 369, 379
Methylene Violet, 370

Naphthalene Black D, 381
— Scarlet **4R**, **400**
Naphthol Orange G, 399
— Yellow, 379
Neocotone Dyes, 459
Neolan Blue B, 439
— — FR, 585
— — **2R**, 440, 585
— Pink BA, 440
— Red **3B**, 440
— — BRE, 585
— — REG, 585
— Salt P, 440
— Violet **3R**, 440
— Yellow BE, 585
— — RE, 585
— — G, 440
Neutral Red, 369
New Magenta, 369
— Methylene Blue, 369
Nile Blue, 369

- Omega Chrome** Yellow ME, 436
 Orange II, 8, 378

 Palatine Fast Salt O, 440
 — Blue GGN, 439
Para Red., 9, 444
Pararosaniline, 368, 369
Perlon Fast Orange RRS, 442
 Phthalocyanine Blue, 121
 — **Green**, 121
 Polar Brilliant Blue AW, 381
 — — Red BN, 575
 — — Red G, 575
Primuline, 406, 420
 Procilan Dark Blue RS, 543
 — Grey BRS, 543
 — Red GS, 543
 — Yellow **2RS**, 543
 Procion Blue **M-3GS**, 527, 534, 578
 — Brilliant Blue **H-5G**, 530, 531
 — — — **H-7G**, 530
 — — — M-R, 527, 531, 534, 578
 — — — Orange MG, 531
 — — — Red **M-2B**, 534, 578
 — — — **M-5B**, 534, 578
 — — — Yellow **M-4G**, 527
 — — — **M-6G**, 530, 534
 Procion Orange M-GS, 578
 — Red **M-2B**, 531
 — — **M-8B**, 531
 — — M-G, 527
 — — Brown **M-4R**, 527
 — Rubine M-B, 534
 — Scarlet M-G, 531, 535, 578
 — — H-R, 530
 — Yellow HA, 532
 — — **H-5G**, 532
 — — M-GR, 531, 535
 — — **M-6G**, 531, 532
 — — M-R, 524, 532, 534, 578
 — — **M-4R**, 531
 Pyrogene Blue V, 466
 — Deep Black B 466
 — Orange O, 469
 — Yellow Brown RS, 467

 Safranine, 370
 Sandothrene Golden Yellow NRK, 492
 — Red **N4B**, 492
Setacyl Blue **2GS**, 550
 — Orange GR, 559
 — Scarlet B 510
 — Violet R 513
 — Yellow **2GNE**, 550
 Sirius Super Green BTL, 426
Solacet Fast Rubine **3BS**, 550

Solacet Fast Violet **4RS**, 550
 — Violet BS, 550
 Solar Brilliant Blue A 417
 — Orange **4GA**, 419
 — Red **2BL**, 414
 — Violet **3R**, 414
 — Yellow R 419
 — — **2R**, **415**
Soledon Blue **4RC**, 590
 — Brilliant Purple **2R**, 497
 — Indigo LL, 497
 Solochrome **Flavine** G, 436
 — Orange M, 43.5
 — Red B 436
 — Red D, 400
Solophenyl Brilliant Blue BL, 419
 — Fast Blue Green BL, 419
 — Yellow BRL, 414
 — — GFL, 414
Solway Blue B 381, 382
 — — BN, 552, 590
 — *Green G, 383
 Sulphonine Red **3B**, 381
 Suprarnine Blue EG, 590

Tartrazine, 380, 552
 Thioindigo, 475, 480
 Thionol Dark Blue B 469
 — — — V, 469
 — Red Brown **5R**, 466, 467
 — Yellow G, 466
 — Yellow **2G**, 466, 469
 Thionol Bordeaux BR, 466, 469
 — Dark Brown B 467
 — Direct Blue RLS, 467
 — Navy Blue RM, 469
 — Orange R 466
 — Sky blue **6B**, 469
 — Yellow YN, 467
Tinon Golden Yellow GR, 492
 Trisulphon Brown B, 419
 — Fast Blue B 413
 — Violet B, 413
 — Violet **2B**, 419
 Turkey Red, 431
 Tyrian Purple, 1, 3, 9, 474

 Victoria Blue RB, 593
Vidal Black, 463, 470
 Violet Imperial, 6
 Viscolan Black B 381

 Xylem Blue VS, 379
 — Fast Green A 379
 — Light Yellow **2GL**, 381
 — Red B 379

General Index

- Acetate dyes, 506
Acetic acid, sp. gr. and concentrations, 655
Achromats, 617
Acid dyes! 11, 378 et seq.
 adsorption isotherms, 387
 anthraquinone, 381
 application, 390 et seq.
 —, with ammonium salts, 391
 — to polyacrylonitriles, 572
 —to polyamides, 551
 — to silk, 404
 —to wool, 399
 bisazo, 380
 effect of acids, 382
 — of Glauber's salt, 383
 of temperature, 390
 function of acid, 388
 monazo, 380
 phthalocyanine, 381
 pyrazolone, 380
 shrink resistance and fastness, 399
 stripping, 398
 structure and fastness, 386
 theory of dyeing, 387 et seq.
 triphenylmethane, 379
 wash fastness, 384
Acid Magenta, 378
Acid mordant dyes, 435
 application, 436
 — to polyamides, 554
 correction of shade, 437
 fastness, 436
Acids, action on cotton, 58
Acrlan, 148
Acrylonitrile, 145
 polymerization, 145
 preparation, 146
 properties, 146
 vinyl chloride co-polymers, 15 1
Activation energy, 303
Addition polymerization, 15
Additive primaries, 616
Adipamide, 133
 —, from butadiene, 133
 —, from furfuraldehyde, 133
Adipic acid, 131
Adiponitrile, 133
Adsorption isotherms, 315 et seq.
 — isotherm for Solway Blue B 387
 — — — Chrysophenine G, 411
Aerosol MA, 198 .
Æsculetin, 255
Æsculin, 255
Afterchrome acid dyes, 11
Agilon, 155
Agrinine, 85
Alanine, 85
Albatex WS, 552
Alginate yarns, 128
 — —, removal, 220
 — —, uses, 129
Alginic acid, 128
Alizarin, 2, 4
 —, dyeing, 431
 —, properties, 431
 —, synthesis, 431
Alkali cellulose, 59
 solubility test, 250
Aluminium hydroxide, 162
Aluminoferic, 162
Aminoanthraquinone, 10
Aminocoumarins, a57
N-2-aminopiperazine, 138
ω-Amino-undecanoic acid, 139
Ammonia, sp. gr. and concentrations, 656
Amorphous regions, 20
Analysis of scoured wool, 219
Angora, 98
Anhydrocarboxyglycine, 280
Aniline, 6
Animal fibres, 74 et seq.
Anion exchange resin, 175
Anomaloscope, 618
Anomalous fading, 595
Anthranilic acid, 478
Anthraquinone, 475
 — vat dyes, 475
Antheraea mylitta, 99, 107
 — *pernyi*, 99, 107
 — *yama-mai*, 107
Anthrone, 489.
Antidiazotate, 449
Anti-mildew agents, 301
Antimony oxide flame resist finish, 298
A.O./H.R.R. test for colour vision, 618
A.P.O., 298
Ardil, 219
Artisil dyes, 507
Aspartic acid, 85
Astralene C 156
Astralon C, 156
Atactic polymers, 14
Atmosphere, standard, 30
Attacus ricini, 107
Autoclave heat setting, 548
Automatic process control, 365
Autosetter, 548
Auxochromes, 303
Available chlorine estimation, 224, 268
Azine dyes, 369
Azo chromophore, 313
Azo basic dyes, 370

- Azoic colours, application, 455
 Azoic dyes, 9, 444 et seq.
 —, application, 450 et seq.
 —, — to cellulose acetate, 515
 — —, — protein to fibres, 460
 — —, blinding, 460
 — —, coupling, 457
 — —, stripping, 462
 — —, washing off, 459
- Back tanning, 554
 Bakelite, 15
 Barlon, 155
 Barium peroxide, 232
 Basazol dyes, 542
 Base-exchange materials, 173
 — — —, synthetic, 173
 — — — softeners, 173
 — — — softening, 172 et seq.
- Basic dyes, 368
 action of reducing agents, 373
 anthraquinone, 370
 application to celluloses, 376
 — — polyacrylonitriles, 371
 — — silk, 374 et seq.
 — — wool, 376
 assistants, 374
 back tanning, 375
 classification, 368 et seq.
 dissolving, 374
 light fastness, 372
 methine, 371
 nature of affinity, 373
 polyacrylonitriles, 570
 properties, 371 et seq.
 synthetic mordants, 377
 tannic acid mordant, 373
 wash fastness, 372
- Bast fibres, 67
 Bathochromic effect, 3 13
 Bave, 100
 Beater tubs, 217
 1 : 9-Benzanthrene, 482
 Benzoquinone, 262
 Benzoyl peroxide, 13
 Benzyl alcohol, 556
 Bifunctional monomers, 22
 Biochemical oxygen demand, 180
 Blancophor R, 256
 — WT, 257
 Bleaching, continuous, 243 et seq.
 —, hypochlorites, effects of temperature,
 231
 — powder, available chlorine, 222
 — —, chemical constitution, 222
 — —, manufacture, 222
 — — solution, preparation, 225
 — — —, sp. gr., 226
 — man-made fibres, 253 et seq.
 — silk, 253
 — with hypochlorites, 227 et seq.
 — wool, 248
- Block co-polymers, 14
Boehmeria, 69
 — *tenacissima*, 69
 Boiler corrosion, 166
 Boiler scale, 165
 — — — prevention, 166
 Bokara, 98
 Boil, 38
Bombyx mori, 99, 107
 Böwe machine, 266
 Bragg's law, 18
 Brazil wood, 4
 Brenthamine fast blue B base, 567
 Brenthol AT, 450
 — DA, 450
 1 1-Bromoundecanoic acid, 139
 Bulking false twist, 154
 — stuffing box, 155
 — thermoplastic yarns, 1.54 et seq.
- Burrs., 82
 Butadiene, 133
 Butanediol, 152
- Calcium alginate, 128
 Calcium hypochlorite reactions, 223
 Calgon, 17.5
 Camhium, 67
 Camieau effect, 441
Cannabis Sativa, 70
 Caprolactam, 138
 Carbon, atomic orbitals, 310
 Carbon black, 121
 Carbonization of wool, 97
 Carboxyl groups in cellulose, estimation, 53
 Carnaubyl alcohol, 184
 Carroting, 263
Carthamus Tinctorius, 2
 Casein yarns, 129
 Cashmere, 98
 Castor oil, 183
 Cation active substances, 200
 Cationic dyes, 368
 — — for polyacrylonitriles, 570
 Cationic fixing agents, 427
 Caustic potash, sp. gr. and concentration, 651
 Caustic soda, sp. gr. and concentration, 651
 Celcon automatic dye control, 366
 Cellit fast dyes, 506
 Celliton dyes, 507
 Cellobiose, 46
 Cellulose II, 60
 Cellulose
 acid tendering, 58
 action of formaldehyde, 293
 — — nitric acid, 59
 chemical constitution, 44
 cross-linking, 292 et seq.
 flame resist finish, 294
 fluidity test, 53
 general properties, 44
 hydrates, 44
 hydrogen bonds, 48
 molecular weight, 48
 nitrate, 109
 phosphoric acid esters, 296
 polyamide mixtures, dyeing, 579
 structural formula, 47
 triacetate, 126, 130
 —, dyeing, 517
 xanthic acid, 114

- Cellulose acetate, application of azoic dyes, 515
 —, dyeing, 128, 506 et seq.
 —, black, 512
 —, rayon manufacture, 127 et seq.
 —, tensile strength, 127
 — and cellulose mixtures, dyeing, 579
 — rayon, 126
 Cellulosic fibres, crystallinity, 22
 Cellutyl dyes, 506
 Centrifugal spinning box, 117
 Centrigrade-Fahrenheit conversion, 649
 Ceryl alcohol, 43, 184
 Cetyl alcohol, 184
 Chelation, 176
 Chemical oxygen demand, 180
 Chemical potential, 303
 Chlorine dioxide, 240
 Chlorine gas, action on wool, 270
 Cholesterol, 83
 Chromaticity chart, 624
 — co-ordinates, tabulated, 625
 planes, 629
 Chromatographic separation of dyes, 607 et seq.
 Chromatography, 606
 —, partition, 608, 610
 —, thin layer, 613
 —, vat dyes, 610
 Chromium alpinate, 128
 Chromium co-ordinate compounds, 430
 —, co-ordination with alizarin, 430
 Chromophores, 303, 315
 Cihacet dyes, 507
 C.I.E. colour definition, 624
 Cirrasol OD, 282
 Classification of fibres, 35
 Cloud point, 202
Coccus cacti, 4, 432
 Cochineal, 4, 432
 cocoon, 100
 Coefficient of diffusion, 323
 Cohesive force, 26
 Colorimeter, photoelectric, 636
 Colour, 615 et seq.
 —, anomaloscope test, 618
 —, A.O./H.R.R. test, 618
 —, ellipsoids, 632
 —, luminosity, 628
 —, perception testing, 617
 —, quinonoid theory, 305
 —, space, three dimensional, 629
 —, vision, Farnsworth test, 618
 —, —, Giles-Archer test, 618
 Colour and chemical constitution, 303 et seq.
 — distribution co-efficients, 628
 — measurement, 634
 — saturation, 616, 627
 — triangle, 622
 COMIC colour matching computer, 646
 Computer flow diagram, 645
 Condensation polymerization, 15
 Condition weight, 32
 — determination, 33
 Conjugation and colour, 312
 —, effect on energy levels, 313
 Constant chromaticity chart, 630
 Contact angle, 191
 Continuous alkali boiling, 210
 — bleaching, 243 et seq.
 — filaments, 12
 Co-ordinate bonds, 439
 Copper number, 50
 Coprantine dyes, 426
Corchorus, 72
 — *capsularis*, 72
 — *olitorius*, 72
 Correct condition weight, 32
 Cortex, 67
 Cortex, wool, 77
 Cotton, 37 et seq.
 acid tendering, prevention, 58
 action of acids, 58
 — alkalis, 59
 — heat, 57
 — micro-organisms, 58
 — water, 57
 American, 41
 China, 42
 classification, 41
 convolutions, 40
 cultivation, 38
 dead fibres, 40
 effect of Schweitzer's reagent, 40
 Egyptian, 41
 fibre, unripe, 38
 growth of mildew, 58
 immunized, 65
 impurities, 42
 Indian, 42
 mineral matter, 44
 natural history, 37
 peroxide bleaching, 434 et seq.
 regenerated cellulose mixture, dyeing, 579
 scouring, 203 et seq.
 Sea Island, 41
 solvent scouring, 210, 212
 South American, 41
 steeping, 204
 structure, 39
 Cotton-way dyeing, 574
 Counts of yarns, 659
 Coupling components, affinities, 453
 — dissolving, 451
 — standing baths, 453
 Courtelle, 148
 Courtrai flax, 66
 Covalent bonds, 320
 Crease resist finishes, 288 et seq.
 Crease shedding, 291
 Crimp rigidity, 156
 Crimped thermoplastic yarns, 154 et seq.
 Crimplene, 156
 Crystalline regions, 20
 Crystallinity, determination, 21, 22
 Cuprammonium rayon, 112
 Cupri-ethylenediamine, 105
 Cuprofix dyes, 426
 Cuprophenyl dyes, 426
 Cyanamide, 280
 Cyanine dyes, resonance, 307

- Cyanuric chloride, 10, 520
 Cyclohexane, 132
 Cyclohexanol, 132
 Cyclohexanone, 132
 Cysteic acid, 92
 Cystine, 85
 Cystine linkages, 24, 89
 Cystine links, action of alkali, 91
 —, — — hydrogen peroxide, 91
 —, —, — sodium bisulphite, 91
- Dacron, 141
 D.D.T., 300
 Decinormal solutions, 653
 Deep well water, 160
 Defective colour vision, 617
 Degeneracy, 309
 Degree of polymerization, 29
 Dehydrothio-toluidine, 464
 Dermis, 74
 Desizing, 204
 Detergency, measurement, 195
 —, theory, 193 et seq.
 Detergents, synthetic, 197
 Deuteranopes, 617
 Dew retting, 67
 D.F.E., 260
 —, Lipson and Howard method, 261
 — violin bow method, 260
 — and shrinkage, 261
 Diamino-stilbene disulphonic acid, 256
 Diammonium adipate, 133
 Diastase, 204
 Diazoic acid, 449
 Diazonium salts, structure, 8
 Diazo reaction, 449
 Dibenzanthrone, 482
 Dichloroisocyanuric acid, 274
 1 : 3-Dichloro-2-propanol, cross links, 291
 Diethanolamine, 203
 Diethylene glycol diacetate, 519
 Differential colorimeter, 638
 2 : 2-Dihydroxyazobenzene, 441
 3 : 4-Dihydroxyphenylpropane, 73
 2 : 5-Dimethoxy-phenyldiazonium chloride, 450
 Dimethyl aniline, 7
 — diaminoazobenzene, 7
 — formamide, 158
 Dimethylol cyclic ethylene urea, 290
 — ethylene urea, 291
 — methyl triazone, 290
 — urea, 290
 Diphenyl, 561
 Direct dyes, 8, 405 et seq.
 after treatment, 420
 application, 418 et seq.
 — above 100°C, 428
 — to polyamides, 550
 bichromate after-treatment, 427
 cationic fixing agents, 427
 chemical constitution, 405
 cis-trans isomerism, 408
 class A 416
 class B, 416
 class C 416
 Direct dyes
 copper after-treatment, 427
 coupled, 424
 diazotised and developed, 420
 effect of electrolytes, 411
 — — liquor ratio, 413
 — — pH, 414
 — — temperature, 412
 fastness, 414
 formaldehyde after-treated, 425
 hydrogen bonds with cellulose, 409
 metallic salts after-treatment, 426
 migration test, 416
 stripping, 429
 substantivity, 407 et seq.
 test for class, 417
 time of half-dyeing, 415
 theory of dyeing, 407
 Directional friction effect, 260
 — light absorption, 316
 Disperse dyes, 506 et seq.
 application, 509
 to polyamides, 549
 build-up-test, 511
 dyeing properties, 510
 fastness, 512, 550
 hydrogen bonding, 509
 mechanism of dyeing, 508
 migration test, 511
 rate-of-dyeing test, 511
 solubilities, 508
 temperature range test, 511
 Dispersol A, 440
 Distribution coefficients, 628
 — —, C.I.E., 630
 Ditertiary butyl peroxide, 13
 Diurethane, 291
 Divinylbenzene, 175
 Divinyl sulphone, 294
 Dominant wavelength, 627
 Donaldson colorimeter, 635
 Donnan pipette, 195
 Drawing and orientation, 136
 Dri-Sol finish, 277
 Dry spinning rayon, 111
 Durafil, 121
 Duranol inhibitor GF, 518
 — — N, 518
 Dyer's thistle, 1, 2
 Dyes, adsorption and non-polar forces, 386
 --I classification, 329 et seq.
 —, extraction for chromatography, 610
 —, physical attraction, 321
 — and binding forces, 320
 Dye molecules, size of, 320
 Dyeing, effect of agitation, 319
 Dyrel, 151
- Easy care finishes, 291 et seq.
 E.D.T.A., 176
 Effluents, 179
 —, biological purification, 181
 —, purification, 181
 —, synthetic detergents, removal, 181
 Elastomeric fibres, 157
 — —, bleaching, 255

- Elastomeric fibres, spinning, 158**
 Electromagnetic waves, 615
 π Electrons and substantivity, 410
 Emulsifying power, measurement, 194
Emulsin, 46
Enant, 140
 End group, molecular weight determination, 28
Epidermis, 74
Erifon finish, 297
Erional NW, 552
 Ethyl alcohol, hydrogen bonds, 25
 2 : Ethylanthraquinone, 233
 Ethylene cyanhydrin, 145
 Ethylene diamine, 531
 Ethylenediamine tetra-acetic acid, 176
 Ethylene glycol, manufacture, 141
 Ethylene oxide, 145, 201
 Ethylene polymerization, 13
Eulan BL, 300
Eulan N, 301
 False twist, 154
 Farnsworth test, 618
 Fast salts, 449
 Fastness classifications, 333
 to chlorinated water test, 599
 — — chlorination test, 601
 — — chlorite bleaching, 600
 — — cross-dyeing test, 601
 — — hypochlorite bleaching test, 599
 — — mercerizing test, 602
 — — peroxide bleaching test, 600
 Fats, 183 et seq.
 Fehling's solution, 50
 Felting, effect of pH, 264
 Ferric oxides as coagulants, 162
 Fibre-forming polymers, 131
 Fibres, properties of, 12
 Fibrils, fringed, 20
Fibroin, 100
Fihrolane, 129
 -, tensile strength, 129
Fick's Law, 319
 Filippi glands, 101
 Fine structure, 29
 Fischer-Tropsch reaction, 138
Fixanol C 200, 427
 Flame resist finishes, 296 et seq.
 — —, antimony oxide, 298
 — —, testing, 294
Flax, 66
 cottonizing, 69
 hackling, 68
 impurities, 69
 microscopic structure, 68
 ripping, 66
 scutching, 68
 tensile strength, 69
Fluorescent brightening agents, 255 et seq.
 application, 258
 discoloration of wool, 258
 light fastness, 258
 use with hypochlorites, 258
 use with peroxides, 258
Formic acid, sp. gr. and concentration, 655
Formosul G, 604
Fortisan, 122
 Free electron model, 314
Freundlich equilibrium, 327
Fringed fibrils, 20
 — micelles, 20
 Fulling mill, 265
 Fungi, conditions of growth, 301
Fustic, 430
 Galacturonic acid, 43
 Gallons to litres conversion, 657
 Gantt piler, 243
Gardinol WA, 195
 Gear crimping, 154
 Giles-Archer test, 618
Girland machine, 545
 Gland, sebaceous, 74
 -, sweat, 74
Glucose, 45
 —, pyranose structure, 45
Glutamic acid, 85
Glycerol, 186
 —, succinic acid polymer, 22
 Glycine, 84
 ω -Glycols, 141
 Gossypyl alcohol, 43
Gossypium barbadense, 38
 herbaceum, 37
 hirsutum, 37
 peruvianum, 38
 Graft co-polymers, 14
Grege, 102
 Grey scales, 589
 Ground nuts, 129
 Guild spectrophotometer, 639
 Haematin, 434
 Haematoxylin, 4, 434
 Hank scouring machines, 216
 Hard water properties, 165
 Hardness of water, 164
 — — —, determination 177
 — — —, -with E.D.T.A., 178
 — — —, — with soap solution, 177
 —, Eriodrome Black T titration, 179
 —, methods of expressing, 164
 Harrison's test, 52
 Harrow scouring machine, 213
 Heat of dyeing, 325
 — — setting, effect on dye uptake, 584
 — — —, temperatures, 547
 — — wetting, wool, 95
Hemp, 70
 —, microscopic appearance, 71
 —, retting, 71
 —, uses, 71
 Heptioic acid, 140
Hexadecane sulphonic acid, 198
Hexamethylene diamine, 131
 — —, preparation, 133
 — di-isocyanate, 152
Histidine, 85
Hog wool, 78
Hue, 616

- Hydrocellulose**, formation, 48
 —, **methylene blue test**, 5 2
 —, **tests for**, 50
Hydrochloric acid, sp. gr. and concentrations, 654
Hydrogen bonds, 320
Hydrogen peroxide, 13, 232
 estimation, 233
 expression of strength, 233
 manufacture, 232
 pad-toll method, 247
 properties, 234
Hydroxylysine, 85
 4 : Hydroxy : 4' : methyldiphenyl, 465
Hydroxynaphthoic acid, 9, 445

Identification of dyes, 603 et seq.
Igepon A, 198
 — **T**, 198
Iminodiacetic acid, 176
Immunized cotton, 65
Indican, 476
Indigo, 9
 application, continuous dyeing, 4X6
 —to cotton, 486
 — — wool, 487
 dyeing piece goods 486
 — warps, 486
 fermentation reduction, 3
 historical account, 475
 natural separation, 476
 qualitative test, 477
 substituted, 479
 synthesis, 477 et seq.
 white, 477
Indigofera tinctoria, 2, 475
Indigoid vat dyes, 475
Indigosols, 497
Indigotin, 2, 475
 —, **preparation**, 476
Indophenol, 464
Indoxyl, 476
Injector, 207
Instrumental match prediction, 643 et seq.
Interfacial graft polymerization, 281
Intermittent lime-soda softener, 169
Intermolecular forces, 24
International organization for standardization, 587
Ionamine dyes, 506
Ionic links, 320
Irgapadol A, 403
 — **P**, 403
Irgasol NJ, 556
Irgasolvent process, 401
Isatin, 477
Isatis tinctoria, 2
Isihara test, 617
I.S.O., 587
Isocholesterol, 83
Isoelectric point, 97
Isotactic polymers, 14
 — polypropylene, 15

J box, 244
J box, peroxide bleaching, 245

Jet scouring, 215
Jigs, 355
 —, **high pressure**, 357
Justinian, 98
Jute, 72
 —, **microscopic structure**, 72
 — **fibres**, properties, 73

Katanol W, 575
Keratin, 84, X7
 —, **chemical composition**, X4
 —, **extended structure**, XX
 —, **helical structure**, XX
Kermes, 4
Kier boiling, 206 et seq.
 — —, **assistants**, 209
Kiers, 206 et seq.
 —, **high pressure**, 208
Kilburn mill, 266
Kinetics of dye adsorption, 327.
Kiton red test, 286
Kubelka-Munk equation, 643

Langmuir equilibrium, 326
Lanital, 129
Lanoc CN, 301
Lanthionine, 91, 270
Lauric acid, 183
Levatix dyes, 540
Leucine, 85
Light, visible, wavelengths, 615
 — **fastness**, artificial sources, 592
 — —, **effect of humidity**, 593
Lignin, 73
Lignocellulose, 67
Lime boil, 212
Lime-soda softening, 171 et seq.
Linacrae, 66
Linen, 66 et seq.
 —, **tensile strength**, 69
 — **count**, 69
Linseed oil, 66
Linum usitatissimum, 66
Lissapol C, 199, 214
 — **LS**, 198
 — **N**, 201, 214, 441
Lissolamine V 201
Logwood, 4, 11, 430, 433
 —, **application to silk**, 435
 —, — — **wool**, 434
Lorol, 199
Lousiness, test, 105
Lovibond tintometer, 634
Lovihond-Schofield tintometer, 634
Lucine, 85
Luminosity, 616, 628
Lyofix EW, 427
Lyogen SMK, 443
 — **DK**, 418
Lysine, 85, 89

Machines
 annular cage, 339
 beam dyeing, 364
 cake dyeing, 349
 cop. dyeing, 351
 dyeing, **basic requirements**, 340

- Machines
 GSH hank dyeing, 344
 Hussong, 342
 loose stock dyeing, 360
 overhead paddle, 362
 package dyeing, 346 et seq.
 pulsator, 343
 rocket dyeing, 350
 rotating drum, 362
 top dyeing 337 et seq.
 toroid, 363
 winch dyeing, 352 et seq.
 —, high temperature, 354
- McAdam** sensitivity ellipses, 630
- McGowan factor, 179
- Malachite green absorption vectors, 317
- Meggy's theory of dyeing, 321
- Melafix process, 272
- Melamine, 280
- Melt spinning, 135
- Membrane equilibrium, 60
- Mercaptals, 29
- Mercerization, 62
 -, tests for, 64
- Mercerized cotton, **benzopurpurin** test, 64
 — —, microscopic appearance, 64
- Merkalon, 153
- Mesityl alcohol, 184
- Metachrome mordant method, 11, 438
 1 : 1 Metal complex dyes, 439
 2 : 1 Metal complex dyes, 443
- Metamerism, 617
- Methionine, 85
- Methylene blue test for hydrocellulose, 52
 — — — —, oxycellulose, 52
 — — — — and wool degradation, 287
 — dichloride, 130
 — glycol, 141
- Methylol melamine, 280
- Methyl orange resonance, 307
- Methyl β -ubelliferone, 256
- Metric conversion factors, 658
- Micelle, fringed, 20
 hlicelle, soap, 187
- Micro-organisms, action on cellulose, 58
- Mildew and cotton, 58
- Milk casein, 129
- Milling, effect of pH , 264
 — shrinkage, determination, 284
- Millon's reagent, 108
- Mitin FF, 301
- Modacryls, 148
- Mohair, 98
- Moisture content of fibres, 30
- Moisture meters, 34
- Molecular energy levels, 305
 — orbitals and colour, 309 et seq.
 — weight, end group method, 28
 — —, osmotic method, 27
 — —, ultracentrifuge method, 29
 — —, by light scattering, 29
- Monochlorotriavinyl dyes, 528 et seq.
 — —, application, 529 et seq.
- Monochromator, 639
- Monoethanolamine, 203
- Monofilaments, 12
- Monomers, bifunctional, 22
 Monomers, trifunctional, 22
- Montanyl alcohol, 43
- Moplin, 153
- Mordant dyes, 430 et seq.
 — —, natural, 431
- Mordants, 4
- Mothproofing, 300 et seq.
- Munsell colour system, 620
- Myristic acid, 183
- Nagel anomaloscope, 6 18
- Naphthol AS, 445
 — **AS.AN**, 447
 — **AS.BS**, 447
 — **AS**, derivatives and substantivity, 447
 — **AS.G**, 447
 — **AS.OL**, 447
- N.B.S. Units, 588
- Nekal, 209
- Nekal A 198
- Nelson process, 119
- Neolan dyes, 11, 439
- Neps, 81
- Nernst distribution, 326
- Nitric acid, action on cellulose, 59
- Nitrilo triacetic acid, 176
- Nitrobenzene, 6
- Nitrocellulose rayon, 109
- Nitro dyes, 379
- Nitrogen constituents, cotton, 43
- Nitrosamine red, 444
- Non-ionic surface active compounds, 201
 — — — —, solubility, 202
- Nutting-Hilger spectrophotometer, 640
- Nylon
 basic dyeable and standard yarns dyeing, 557
 crystallinity, 22
 deep dye, 138
 deep dye/basic dyeable dyeing, 557
 delustring, 138
 drawing, 136
 effect of methoxylation, 23
 heat setting, 545 et seq.
 hydrogen bonds, 137
- Nylon 6, 138 et seq.
 -7, 140
 — 9, 140
 -11, 139
 — 66, 131, 134, 137
 — 66 + 6, 139
 — 100, 138, 556
 — 110, 138, 556
 — 120, 138
 — 610, 132, 139
 — 6 melting point, 139
 — 66 tensile strength, 138
- Oils, 183 et seq.
- Oleic acid, 183
- Oleine, 186
- * Orbitals, 311
- Organzine, 102
- Orlon, 148
- Ortho-cortex, wool, 77

- Orthophenyl phenol, 563
 Orthophthalic acid, 27
 Orthoxylene, 142
 Osmometer, 27
 Ostwald colour classification, 618
 Oxanthrene, 488
 Oxanthrene dyes, 370
Oxazine dyes, 369
OxO reaction, 198
Oxycellulose, 49
 acidic, 50
 estimation, 53
 methylene blue test, 52
 reducing, 50
 silver nitrate test, 52, 53
 tests for, 50
- Package dyeing, 346 et seq.
 Pad dyeing, booster method, 500
 -jig method, 499
 — mangle, 359
 — roll bleaching, 247
 — steam method, 499
 Palatine fast salt, 440
 Palmitic acid, 183
 Papain, 278
Paracortex, wool, 77
Paranitroaniline, diazotization, 424
Para Red, 444
Paraxylene, 142
 Parchment paper, 58
 Peach wood, 4
 Pe Ce, 150
Pectic acid, 43
Pegson pre-boarding machine, 546
 Peptides, 84
 Peracetic acid, 239
 — —, action on disulphides, 91
 Perlon, 138
 Perlon U, 152
 Permanent hardness, 167
 Permanent set, 93
Permonosulphuric acid, 275
 Peroxide, acid bleach, 250
 — —, bleaching, 234 et seq., 248
 — —, metallic catalysts, 249
 Perspiration, fastness determination, 598
 Persulphates, 13
pH and indicators, 657
 Phenol Blue, resonance, 308
Phenylalanine, 85
Phenyldiazonium chloride, 7
 Phenyl phosphoric acid, 138
Phloem, 67
 Phthalic acid, 478
 Phthalimide, 478
Picric acid, 380
 Polyacrylic acid, 12
 Polyacrylonitrile mixtures, dyeing, 583
 — /cellulose dyeing, 584
 — /polyamide dyeing, 585
 — /polyester dyeing, 586
Polyacrylonitriles, 145 et seq.
 affinity for **basic** dyes, 571
 application of acid dyes, 572
 — — **basic** dyes, 571
 Polyacrylonitriles, application of **premetal-**
 lized dyes, 673
 — — vat dyes, 571
 bulking, 147
 co-polymers, 147
 durability of, 149
 fastness of disperse dyes, 570
 second order transition, 148
 spinning, 146 et seq.
 temperature and dyeing, 570, 572
 tensile strength, 150
Polyalanine, 88
 Polyamide 610, 140
 — /acrylic mixtures, dyeing, 585
 fibres, characteristics, 140
 Polyamides, application of acid dyes, 552
 —, —, —, — mordant dyes, 554
 —, —, — direct dyes, 551
 —, —, — disperse dyes, 549
 —, —, — premetallized dyes, 555
 —, —, — **solacet** dyes, 550
 —, —, — back tanning, 554
 —, —, — dyeing with solvents, 556
 —, —, — fastness of acid dyes, 553
 —, —, — heat setting, 545 et seq.
 —, —, — scouring, 549
 Polyaminoperlagonic acid, 140
 Polyester, 140 et seq.
 / acrylic mixtures, dyeing, 586
 application of **azoic** dyes, 564, 566
 application of vat dyes, 566
 bleaching, 254
 continuous dyeing, 568
 dyeing, 559
 dyeing with carriers, 561
 effect of temperature on dyeing, 566
 high temperature dyeing, 564
 mixture dyeing, 581
 / polyamide mixtures, dyeing, 582
 spinning, 142 et seq.
 / wool mixtures, dyeing, 582
 Polyfunctional cross linking in dyeing, 541
 Polymerization, 13, 131
 Polymers, **fibre** forming, 17, 131
 Polynosic fibres, 124
 Polypropylene, **atactic**, 14
 —, isotactic, 14, 23
 —, syndiotactic, 14, 23
 Polystyrene, cross-linked, 175
 Polythene, 153
 Polyurethane, 152
 Polyvinyl alcohol, 12, 151
 — chloride, 150
 — chloride, chlorinated, 151
 — fibres, 150
 Potassium **permanganate**, unshrinkable
 finish, 273
 — persulphate, — —, 233
Premetallized dyes, 11, 439 et seq.
 2 : 1 premetallized dyes, 441 et seq.
Premetallized dyes, application to poly-
 amides, 555
 — —, — — acrylics, 573
Primazine dyes, 540
Proban finish, 297
 Procilan dyes, 443, 542

- Procilan dyes, fastness, 543
 Procinyl dyes, 543
 — —, application to polyamides, 543
 Procion dyes, 522 et seq.
 — —, exhaustion, 523
 — H dyes, 529
 Procion-resin process, 546
 Proline, 85
 Protanopes, 617
 Proteins, helical structure, 88
 Pyran, 45
 Pyranthrone, 481
 Pyrazolone dyes, 380

 Quinone, 304
 Quinonoid theory of colour, 305

 Rabbit hair, 98, 264
 Rain water, 160
 Ramie, 69
 Rapid Fast Dyes, 449
 Rate of dyeing, 322
 Rayon, dry spinning, 111
 —, mass coloration, 120
 —, skin effect, 123
 —, wet spinning, 111
 Reactive dyes, 520 et seq.
 acid hydrolysis, 531
 anomalous Huidities, 535
 application, 527 et seq.
 — at high temperature, 529
 — to cellulose, 539
 — to polyamides, 536
 —to silk, 535
 — to wool, 536
 cold dyeing, 526
 cross linking, 525
 exhaustion, 523
 fastness, 531
 hydrolysis, 524
 molten metal process, 535
 pad-roll methods, 533
 poor affinity, 530
 reactions with cellulose, 521
 stripping, 535
 trichloropyrimidine, 530
 washing off, 527
 Reactone dyes, 530
 Reduction clearing, 519
 Reflectance curves, 630
 Regains, 32
 Regenerated celluloses, crystallinity, 22
 — man-made fibres, 109
 Relative humidity, 3 1
 Relaxation shrinkage, 282
 Remazol dyes, 538
 Resofix C, 426
 Resonance, 306
 Retting, 67
 Rhovyl, 150
 Ricinoleic acid, 183, 197
 Rilsan, 139
 Rochelle salt, 50
 Rochon prism, 641
 Rocket dyeing, 350
 Rotary scouring machine, 21 S,

 Rotation X-ray diagram, 18

 Safflower, 1
 Salicyl anilide, 302
 Salicylic acid, 426
 Salt linkages, 24, 90
 Sandofix K, 282
 — WE., 427
 Sapamine CH, 199
 Saran, 153
 Saturation, colour, 616
 Scale forming waters, 165
 Schweitzer's reagent, 40, 64
 Scotch mill, 266
 Scoured wool, analysis, 219
 Scouring cotton, 203
 — effect of electrolytes, 202
 — machines, 213, 216
 — polyamides, 549
 silk, 221
 — wool, 212 et seq.
 Sea Island cotton, 38
 Sebaceous gland, 74
 Sebasic acid, 132, 139
 Second order transition, 143
 Secondary cellulose acetate, 126
 Sequestering agents, 175
 Sericin, 100, 104
 Sericulture, 99 et seq.
 Serine, 85
 Setacyl dyes, SO6
 Setting of wool, 92
 Shirilan, 302
 Shirley moisture meter, 34
 Shrink resist finishes, 266 et seq.
 Shrinkage, Martin's theory, 263
 —, milling, determination, 284
 —, Shorter's theory, 262
 Silica, coagulant, 162
 Silicates in kier boiling, 209
 Silicones in waterproofing, 299
 Silk, 98 et seq.
 action of acids, 106
 — — alkalis, 106
 — — heat, 105
 — — salts, 106
 bleaching, 253
 boiling off, 221
 chemical composition, 100, 103
 cocoons, 100
 degumming, 221
 detection of damage, 105
 fibrils, 103
 fluidity test, 105
 glands, 100
 gum, 100
 lousy, 105
 microscopic appearance, 102
 natural history, 98
 ruptured fibres, 103
 scouring, 221
 scoop, 100
 spun, 102
 tussur, 107
 weighting, 107
 wild, 107

- Silver nitrate, test for hydrocellulose, 53
 — — — — — oxycellulose, 53
 Simon-Goodwin colour difference charts, 632
 Singeing, 204
 Si-Ro-Set process, 93
 Sizing, 12, 206
 Skin, structure of, 74
 —, wool, 78
 Soaps, 185 et seq.
 — manufacture, 186
 — oils for manufacture, 186
 — potassium, 186
 — properties, 186
 — selection, 196
 — solutions, critical concentration, 194
 —, lamellar structure, 137
 —, micelles, 187
 —, properties, 187 et seq.
 —, standard, 177
 — titre, 196
 Sodium aluminate, 162
 Sodium chlorite, 240
 —, manufacture, 240
 —, mechanism of bleaching, 240
 —, pad-roll method, 247
 —, use in bleaching, 241
 — and corrosion, 243
 Sodium dithionite, 252
 — hydrosulphite, 254
 — hypochlorite, 223 et seq.
 —, estimation of available chlorine, 268
 —, manufacture, 223
 — metasilicate, 209
 — perborate, 239
 — percarbonate, 239
 — peroxide, properties, 237
 —, use in bleaching, 238
 Softener, intermittent, 169
 Softeners, metering chemicals, 170
 Softening, base exchange, 172 et seq.
 Solacet dyes, application to polyamides, 5.50
 Soledon dyes, 497
 Solid shades, dyeing, 574
 Solvent scouring, 210
 Souple silk, 221
 Soxhlet extractor, 219
 Specific gravity, Twaddell/Baumé conversion tables, 650
 Spectrophotometer, Guild, 639
 —, Nutting-Hilger, 640
 —, recording, 641
 Spinneret, 110
 Spotting tile, 605
 Spun silk, 102
 S.R.A. dyes, 128, 507
 Stabilizer C, 249
 Stainless steel, composition, 336
 Standard atmosphere, 30
 — depth dyeings, 587
 — illuminants, 633
 — observer, 628
 — potential, 323
 — regains, 659
 Standard molten metal machine, 501
 Staple fibres, 12
 Steam pressure and temperature table, 653
 Stearic acid, 183
 Stearin, 186
 Steeping press, 115
 Stenter, 547
 Stereospecific polymers, 12
 Stoving, 251
 Stretch spinning, 112, 121
 Strike, 328
 Stuffing box, 155
 Sub-soil water, 160
 Subtractive primaries, 616
 Succinic acid, 141
 Sulphated alcohols, 199
 Sulphonation, 6
 Sulphur dioxide bleaching, 251
 Sulphur dyes, 9, 463 et seq.
 — after-treatment, 469
 — application, 470
 — application to wool, 470
 — bronzing, 470
 — chemical structure, 464
 — detection, 464
 — dissolving, 467
 — dyeing properties, 467
 — fastness, 466, 469
 — properties, 466
 — tendering cellulosic fibres, 470
 — water soluble, 471
 Sulphuric acid, sp. gr. and concentration, 653
 Sulphuryl chloride, action on wool, 276 et seq.
 Superpolyamides, 13 1
 Surface tension, 188 et seq.
 Surface water, 160
 Suint, 82
 Synchromate process, 438
 Syn diazotates, 449
 Syndiotactic polymers, 14
 Synthetic detergents, 197
 Synthetic fibres, definition, 131
 —, dyeing, 544 et seq.
 Svetema pad-roll machine, 532
 Sweat gland, 74
 Swelling, 30
 Tanninol WR, 552, 575
 Taslan, 1.55
 Teepol, 199
 Temperature control, automatic, 365
 Temporary hardness, 164
 —, determination, 178
 —, removal, 167
 Tenasco, 121, 124
 Terephthalic acid, 24, 141
 Terylene, 141
 — crystallinity, 22
 — manufacture, 142 et seq.
 — molecular configuration, 141
 — tensile strength, 143
 Testing dyed materials, 587 et seq.
 Tetartanopes, 617
 Tetrakis(hydroxymethyl)phosphonium chloride, 296
 Tetramethyl glucose, 28

GENERAL INDEX

- Tetramethylamino triphenyl carbinol, 304
 Tetramethylol acetylene diurea, 291
 Tex system, 659
 Theory of dyeing, 3 18 et seq.
 - - - thermodynamics, 322
 Thermal activation, 323
 Thermovil, 150
Thiazine dyes, 369
 Theonine, 85
 Thioglycollic acid, 92
 THPC, 296
Tiliaceae, 72
 Time of half-dyeing, 327, 415
Tinegal, 443
Tinofix, 427
Tinopal BV, 256
 Tinting, 1
 Titanium, 336
 — dioxide, 120, 138
Titanox finish, 297
Titre, 196
Tram silk, 102
 Trelon, 140
 Triallyl phosphate, 298
Triamine PR, 531
Triazinyl dyes, 520
 Tricel, 130
 Trifunctional monomers, 22
Trioleine, 183
Tripalmitin, 183
 Triphenylmethane dyes, 6
 Triphenylmethyl, 305
 Trisaziridinylphosphine oxide, 298
 Tristearin, 183
 Tritanopcs, 617
 Trypsin, 278
Tryptophane, 85
 Tumescal OD, 561
 Tumescal OT, 563
 Turkey Red, 4
 — — dyeing, 431
 - - - oil, 147
 Tussur silk, 107
 Tyrosine, 85
- Ulstron**, 153
 Ultracentrifuge, molecular weight, 29
 Undecvlenic acid, 139
Union dyeing, 574
 — — with azoic dyes, 578
 — — — reactive dyes, 578
 Unshrinkable finishes, 260
 Urea, 130
 — bisulphite test, 288
 formaldehyde crease-resist finish, 290
Urticaceae, 69
- Vacanceine Red process, 9
 Valine, 85
 Van der Waals' forces, 26
 Vaporlok Unit 210
 Vat-acid process, 504
 Vat dyes, 9, 474 et seq.
 Abbott-Cox process, 497
 accelerated photochemical action, 492
 affinity and planarity, 484
- Vat dyes
anthraquinone, application, 488
 application, 485
 — to acrylics, 571
 application to knitted fabrics, 50:
 chemical properties, 474
 chromatography, 611
copperas vat, 485
 crystallization in **fibre**, 492
 dispersing agents, 490
 dyeing properties, 493
 fastness, 492
 for casement furnishings, 493
 hydrosulphite reduction, 486
levelling test, 495
 method of dyeing tests, 494
 migration test, 495
 oxidation, 491
 pigment padding, 498
 reduction methods, 489
 soaping, effect on shade, 491
 solubilized application, 497
 — leuco compounds, 495
 — Morton-Sundour method, 490
 strike test, 494
 stripping, 505
 structure and **affinity**, 484
substantivity, 410
 vatting temperatures, 490
 zinc-lime vat, 485
- Vegetable cell, 37
 — fibres, multicellular, 66 et seq.
Velan PF, 299
Vicara, 130
 Vinyl acetate, 150
 — chloride, 150
 — cyclohexane dioxide, 292
 Vinylidene chloride, 152
Vinyon H.H., 151
 -N, 15 1
 Viscometer, for fluidity, 54
 Viscose, coagulating solution, 1 17
 — fibres, cross section, 124
 — rayon, 114 et seq.
 — —, continuous spinning, 111 et
 — —, desulphurization, 119
 — —, purification, 117
 — —, tensile strength, 121
- Warp yam, 12
 Washing fastness, I.S.O. tests, 596 e
 - - - , — recommendation No. 1, 5
 — —, — — No. 2, 597
 — —, — — No. 3, 597
 — —, — — No. 4, 597
 — —, — — No. 5, 598
- Water**, 160 et seq.
 biological oxygen demand, 180
 chemical oxygen demand, 180
 classification, 160
 dissolved oxygen, determination,
 filtration, 162
 hardness, 164
 retting, 67
 scale forming, 165
 softening, 167 et seq.

water

- soluble impurities, 162, 164
- suspended matter, 162
 - solids determination, 181
 - use of coagulants, 162
- Waterproof finishes, 289 et seq.
- Waterproofing, aluminium soaps, 299
 - , silicones, 299
- Waxes, 181 et seq.
 - , saponification, 184
- Waxol PA, 298
- Weft yarn, 12
- Weighting silk, 107
- Weld, 430
- Wet spinning, rayon, III
- Whiteley scouring machine, 216
- Wild silks, 107
- Willey, 98
- Williams unit, 500
- Wool, 74
 - action of acids, 96
 - - air, 95
 - - alkalis, 96
 - — benzoquinone, 218
 - - chlorine, 266 et seq.
 - — di-isocyanates, 280
 - - enzymes, 278
 - - ethylene sulphide, 279
 - — hypochlorous acid, 270
 - - sodium hydroxide, 277
 - - sodium sulphide, 278
 - - thioglycolic acid, 92
 - alkali solubility test, 250
 - Amino acids, 85
 - bleaching, 248
 - botanies, 79
 - carbonization, 97
 - chlorination, 266 et seq.
 - composition, 82
 - cortical cells, 77
 - /cotton unions, dyeing, 574
 - crimp, 79
 - cross-bred, 79
 - cystine cross-links, 76, 89
 - — and shrinkage, 262
 - cuticle, 76
 - damaged fibre count, 285
 - dichlorisocyanuric acid unshrinkable finish, 274
 - dry chlorination, 270
 - effect of chlorine on scales, 267
 - epicuticle, 76
 - exocuticle, 76
 - fat, 83
 - felting, 260
 - fibre diameter, 79
 - grading, 78
 - heat of wetting, 95
 - helical structure, 89
 - hydrogen peroxide unshrinkable finish, 275
 - impurities, 82
 - interfacial graft polymerization, 281
 - isoelectric point, 97
 - jet scouring, 215
 - Kiton Red test, 286

Wool

- Melafix process, 272
- melamine process, 281
- Methylene Blue test, 287
- milling, 266
- mineral matter, 83
- neps, 81
- orthocortex, 77
- paracortex, 77
- Pauly test, 2X7
- permanent set, 92
- permonosulphuric acid treatment, 275
- /polyamide mixtures, dyeing, 580
- /polyester mixtures, dyeing, 582
- polymers and unshrinkability, 280
- potassium permanganate process, 273
- quality, 78
 - , air flow method, 80
- regain curves, 33
- salt linkages, 89
- scouring, 212 et seq.
- scouring and fulling machine, 265
- scouring effluents, 182
- setting, 92
- shrink resist finishes, 266 et seq.
- shrinkage, 260
- shrinkage causes, 262
- silicon polymers, 281
- sodium hydroxide unshrinkable finishes, 277
- solvent scouring and milling, 266
- sorting, 78
- Stevenson unshrinkable process, 273
- structure of fibre, 76
- sulphur dioxide bleaching, 251
- sulphuryl chloride unshrinkable process, 276 et seq.
- super contraction, 94
- tone and tone dyeings, 441
- Tootal unshrinkable finish, 277
- unshrinkability, assessment, 282 et seq.
- and spot welding, 279
- with cross-links, 278 et seq.
- — polymers, 279 et seq.
- unshrinkable process, Edwards and Clayton, 271
- urea bisulphite test, 288
- wax, 83
- way dyeing, 574
- weathering, 95
- wetting, 95
- X-ray diffraction diagrams, 86

- Xanthating chum, 116
- Xanthic acid, 114
- Xanthone dyes, 379
- Xenon lamp, 595
- X-ray diagram, ramie, 19
- —, Terylene, 19
- diffraction, 17
- Xylem, 67
- X Y Z stimuli, 624

- Zein, 130
- Zeolites, 173