

CLASSIC TAILORING TECHNIQUES

A CONSTRUCTION GUIDE FOR WOMEN'S WEAR



ROBERTO CABRERA/PATRICIA FLAHERTY MEYERS



Digitized by the Internet Archive
in 2012

<http://archive.org/details/classictailoring00cabr>

CLASSIC TAILORING TECHNIQUES:

**A CONSTRUCTION GUIDE FOR
WOMEN'S WEAR**

CLASSIC TAILORING TECHNIQUES:

A CONSTRUCTION GUIDE FOR WOMEN'S WEAR

Roberto Cabrera
Assistant Professor
Fashion Design Department
Fashion Institute of Technology

Patricia Flaherty Meyers

Fairchild Publications
New York

Book Design by Catherine Gallagher
Barbara Woolworth

Photographs by Gustavo Candelas

Illustrations by Roberto Cabrera

Copyright © 1984, Fairchild Publications
Division of Capital Cities Media, Inc.

All Rights Reserved. No part of this book may be reproduced
in any form without permission in writing from the publisher, except by
a reviewer who wishes to quote sources in connection with a review
written for inclusion in a magazine or newspaper.

Standard Book Number: 87005-435-X

Library of Congress Catalog Card Number: 84-80058

Printed in the United States of America

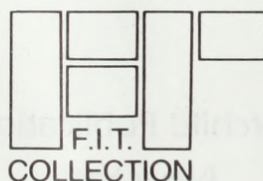

To my family, Elvira, Robert and Liliana.
R.C.

To Jonathan, my husband—my joy.
P.F.M.

To my family, my friends and my
to my family, my friends and my

to my family, my friends and my
to my family, my friends and my

to my family, my friends and my
to my family, my friends and my

to my family, my friends and my
to my family, my friends and my

to my family, my friends and my
to my family, my friends and my

to my family, my friends and my
to my family, my friends and my

to my family, my friends and my
to my family, my friends and my

Preface

When I took my first tailoring course with Roberto Cabrera, and watched him so effortlessly transform a length of fabric into a beautifully living suit, I was both delighted and overwhelmed. What Professor Cabrera was offering to us was the sum total of his forty years of tailoring experience—construction techniques nowhere detailed in the available tailoring textbooks.

The question was how to absorb all of this information before it disappeared again at the end of the course.

This book, *Classic Tailoring Techniques: A Construction Guide for Women's Wear*, is our joint attempt to present these tailoring techniques in a detailed and precise manner, so that they can be understood and performed by any serious student—from novice tailors to home sewers ready for the next challenge.

This book is a sequel to and an expansion of our earlier work, *Classic Tailoring Techniques: A Construction Guide for Men's Wear*. Since women's tailoring is an adaptation of an art which originally belonged exclusively to men's wear, many construction procedures outlined in our first book are repeated here with only slight adjustments—pockets, lapels, vents, etc.

We include construction techniques for three jacket styles, and for three variations on the straight skirt, in order to respond to the almost endless variety of style and detail in women's wear. To afford yourself the best opportunity for success, we suggest that you complete the construction of the classic jacket and the basic straight skirt before moving on to the variations of each.

Although patternmaking is an integral part of the art of tailoring, this book, as its title indicates, concentrates on the construction techniques used in classic tailoring and deals with patternmaking only indirectly in Chapters 2, The Pattern, and 3, The Fit.

We offer our sincere gratitude to those students and colleagues whose encouragement and assistance facilitated the presentation of this work—Patricia De Georges, Sarita de Castro, Mary Gray, Suzanne Galimir, Coli Cabrera, Joan Kinateder, Edward Barnes, Betty Novak and her students at Sew and Show, On-ke Wilde, Steven Stipelman, Randy Dana, and Orchard Street's S. Beckenstein Inc. A special word of thanks to William Fioravanti Inc., and to Robin Ryan and Dara Lamb of Darabin Ltd., who most graciously allowed us to photograph their work.

Preface

When I look back on the history of the book, I am struck by the fact that it has been written in a spirit of freedom and independence. The book is not a collection of essays, but a record of the work of the author. It is a record of the work of the author, and it is a record of the work of the author.

The book is a record of the work of the author, and it is a record of the work of the author. It is a record of the work of the author, and it is a record of the work of the author.

The book is a record of the work of the author, and it is a record of the work of the author. It is a record of the work of the author, and it is a record of the work of the author.

The book is a record of the work of the author, and it is a record of the work of the author. It is a record of the work of the author, and it is a record of the work of the author.

The book is a record of the work of the author, and it is a record of the work of the author. It is a record of the work of the author, and it is a record of the work of the author.

The book is a record of the work of the author, and it is a record of the work of the author. It is a record of the work of the author, and it is a record of the work of the author.

The book is a record of the work of the author, and it is a record of the work of the author. It is a record of the work of the author, and it is a record of the work of the author.

Contents

1. TAILORING	1	
General Tailoring Supplies		2
Understructure Supplies		4
Hand Stitching	5	
Saddle Stitch	5	
Prick Stitch	5	
Back Stitch	5	
Running Stitch	5	
Slip Stitch	6	
Cross Stitch	6	
Double Cross Stitch	6	
Overcast Stitch / Whip Stitch		6
Diagonal Stitch / Pad Stitch		6
Blanket Stitch	6	
Hem Stitch	6	
Pressing Supplies	7	
Pressing Techniques	8	
Tailoring Supply Sources		8
2. THE PATTERN	9	
The Jacket Pattern	9	
The Skirt Pattern	11	
The Pants Pattern	11	
Preliminary Pattern		
Adjustments	12	
1. Jacket Roll Line	12	
2. Shoulder Seams	12	
3. Vents	12	
4. Revised Facing Pattern		13
5. Pants Cuffs	14	
Lengthening or Shortening Patterns	14	
3. THE FIT	15	
Measurements	15	
How to Take Measurements		16
1. Center Back/Neck to Waist	16	
2. Center Back/Neck to Hip	16	
3. Back	16	
4. Shoulder	16	
5. Sleeve Length		16
6. Bust	17	
7. Bust Level	17	
8. Waist	17	
9. Hip Level	17	
10. Hips	17	
11. Skirt Length	17	
12. The Fly	18	
13. Pants Inseam	18	
14. Pants Outseam	18	
15. Knee Width	18	
16. Width of Pants at Hem		18
The Muslin Fitting	19	
The Muslin Jacket	20	
Lapels—Too Wide/Too Narrow		20
Lapels—Too Long/Too Short		21
Jacket Balance	21	
Stooped Posture	22	
Overly Erect Posture	22	
Low Shoulder	23	
Bust—Very Full	26	
Bust—Very Flat	27	
Misplaced Front Dart	28	
Front Dart—Too Long/Too Short		29
Too Loose/Too Tight Above Waist		30
Too Loose/Too Tight Below Waist		31
Shoulder—Too Wide/Too Narrow		32
Sloped Shoulder	33	
Square Shoulder	34	
Neckline—Too High/Too Low		35
Tight Neckline	36	
Loose Neckline	36	
Armhole—Too High/Too Low		37
The Muslin Skirt	38	
Too Tight/Too Loose Across Hips		39
Waistband—Too Loose/Too Tight		40
Waistline—Too Little/Too Much Ease		41
Swayback	42	
One Hip Higher than the Other	44	
Hips Thrust Forward		44

Flat Seat	44		
Protruding Stomach/ Buttocks	45		
The Muslin Pants	46		
Waistband—Too Loose/Too Tight	47		
Waistline—Too Little/Too Much Ease	48		
Too Tight Across Hips	49		
Too Loose Across Hips	50		
Protruding High Hips	51		
Crotch—Too Short/Too Long	51		
Bowlegs/Knock-knees	52		
Flat Seat	54		
Prominent Seat	55		
Protruding Stomach	56		
Rise—Too Long/Too Short	56		
4. FABRIC	57		
Selecting the Fabric	57		
Properties of Woven Fabrics	58		
The Grain	58		
Straightening the Grain	60		
Shrinkage	61		
The Nap	62		
5. LAYOUT/CUTTING	63		
Oaktag Patterns	63		
Chalkmarking, Cutting, Tailor Tacking	66		
Plaids or Stripes	70		
6. JACKETS	76		
Darts and Seams	76		
The Jacket Pockets	78		
The Welt Pocket	78		
Welt Pocket (Plaids/Stripes)	83		
The Double-Piping Pocket	83		
Double-piping Pocket (Plaids/Stripes)	88		
The Cash Pocket	89		
The Double-piping Pocket with Flap	91		
Double-piping Pocket with Flap (Plaids/Stripes)	94		
The Patch Pocket	95		
Patch Pocket (Plaids/Stripes)	99		
Preparing the Canvas	100		
The Pad Stitch	102		
Assembling the Canvas and Jacket	103		
Padstitching the Lapels	107		
The Taping	110		
First Fitting	113		
The Facing	114		
Attaching Facing by Machine	115		
Attaching Facing by Hand	121		
The Facing Pocket	125		
The Lining	128		
The Lining Pocket	134		
The Shoulder Seams	136		
The Shoulder Pads	137		
Inserting Shoulder Pads	140		
The Collar	142		
Constructing the Undercollar	144		
Constructing the Topcollar	150		
Plaid and Striped Collars	155		
The Collar Draft	156		
The Sleeve	162		
Reinforcing the Armholes	162		
The Muslin Sleeve	164		
The Sleeve Vents	168		
Sleeves without Vents	170		
Lining the Sleeve	170		
Setting the Sleeve	173		
Tacking the Armholes	174		
The Sleeve Head	176		
The Plaid Sleeve	177		
Buttons and Buttonholes	177		
Constructing the Buttonholes	179		
The Handworked Buttonhole	179		
The Bound Keyhole Buttonhole	181		
The Bias Bound Buttonhole	182		
Setting the Buttons	184		
Final Pressing	186		
The Unlined Jacket	187		
Darts in the Unlined Jacket	187		
Pockets in the Unlined Jacket	188		
The Facing in the Unlined Jacket	191		

Covering Shoulder Pads in the Unlined Jacket	191	Assembling Skirt and Skirt Lining	244
The Peplum Jacket	194	The Grosgrain Waistband	245
The Full Canvas Interlining	195	8. PANTS	248
The Peplum	196	The Pants Pockets	248
The Peplum Reinforcement	197	The Slant Pocket	249
Assembling the Peplum Jacket	198	The Side Pocket	253
The Peplum Jacket Lining	201	The Western Pocket	257
The Mandarin Collar	203	The Back Pocket	262
Constructing the Mandarin Collar	205	The Pants Fly	265
Attaching the Mandarin Collar	206	The Pants Side Seams	268
The Peplum Jacket Sleeve	207	Belt Loops	270
7. SKIRTS	208	The Pants Waistband	271
1. Basic Straight Skirt	208	The Pants Lining	272
Curved Double-Piping Skirt Pocket	212	The Pants Hem	274
Side Zipper Closing	218	The Heel Stay	275
Hong Kong Piping Hem Finish	219	The Pants Cuffs	276
Overlap Vent at Center Back	221	Pleated Pants	277
The Skirt Hem	222	9. ALTERATIONS	282
Waistband backed with Grosgrain Ribbon	224	Tapering the Jacket Lapels	282
2. Straight Skirt with Shirring	226	Adjusting the Sleeve Length	284
Kick Pleat at Center Back	227	Re-lining the Jacket	286
The Crescent Pocket	229	Altering the Jacket Width	287
Shirring at the Center Front	232	Altering Skirts	289
Assembling Skirt and Skirt Lining	232	Adjusting the Pants Waistline	289
The Self-backed Waistband	234	Tapering the Pants Leg	290
3. Skirt with Pleats	236	Adjusting the Pants Length	290
Three Pleats from Waist to Hem at Left Front	236	PATTERNS	291
The Side Seam Pocket	241	Western Yoke	291
		Western Facing	293
		Western Shaper	293
		Back Pocket Piping	295
		Slant Yoke	295
		Side & Slant Pocket Facing	297
		Back Pocket Facing	297
		Shoulder Pad	299
		Crescent Pocket Yoke	301
		Crescent Pocket Facing	303
		Facing Pocket	305
		About the Authors	307

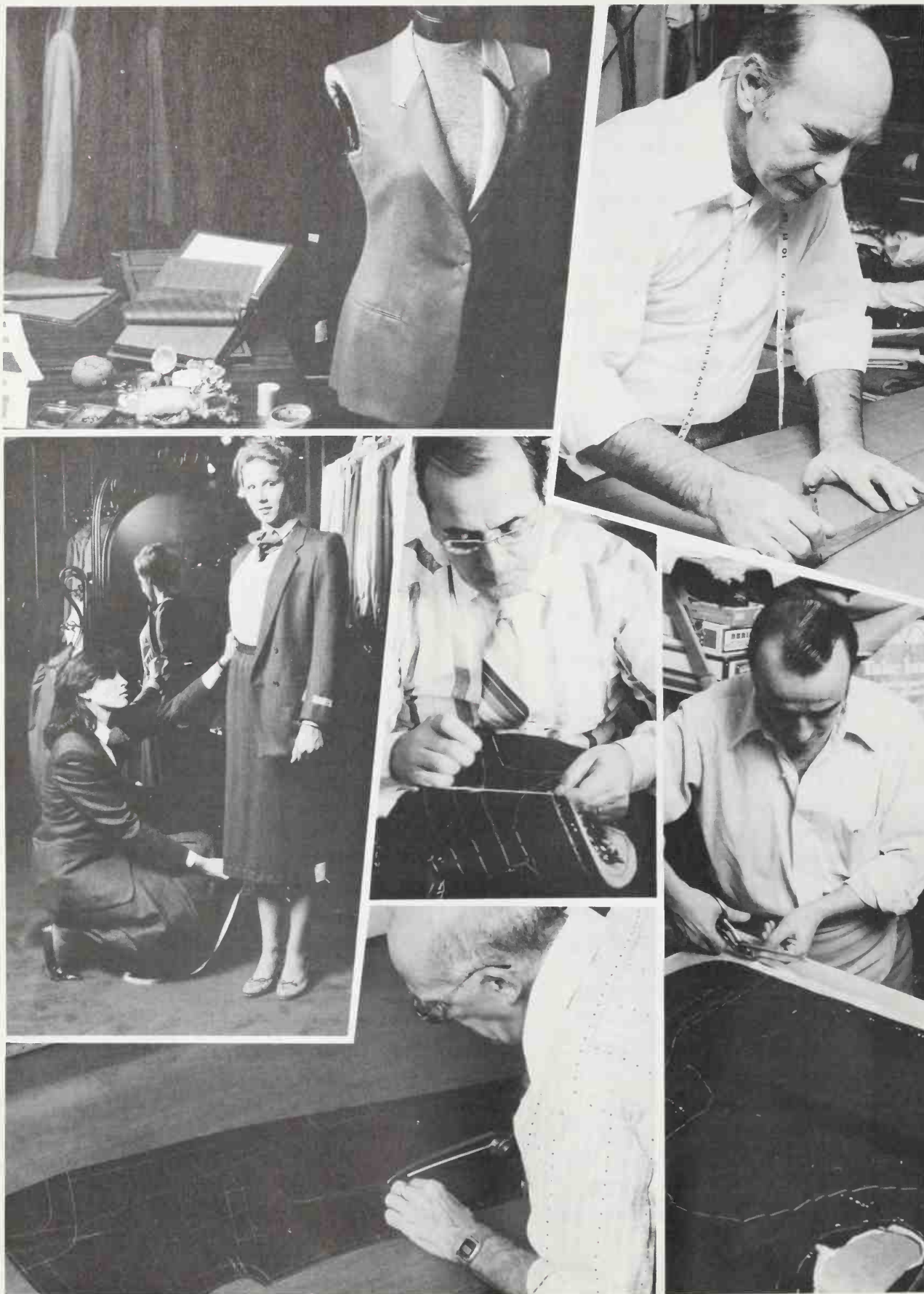

Courtesy of Darabin Limited and William Fioravanti Inc.

1 Tailoring

The art of tailoring can be traced back at least to the fourteenth century, when it became fashionable in Europe to add an underlayer of padding in the chest area of men's jackets. Rather than taking its form from the contours of the wearer's body, the garment fabric was cut and carefully shaped to fit over the padded form. Through the ages the padding was extended, according to fashion, to the sleeves, the shoulders, even to the stomach area. The padded understructure provided what was considered to be improvements over the contours of the body. It also enabled the garment fabric to lie neatly, relatively unaffected by the body's wrinkling movements.

The construction techniques developed to create these structured garments were quite different from those used to produce shirts and dresses. By the sixteenth century the makers of men's jackets had formed a separate branch of the clothing makers' guilds, complete with precise specifications for the quality and color of padding materials and linings for gentlemen's silk brocade jackets.

By the late seventeenth century women's fashion began to be influenced by the man-tailored coat. Tailors were presented with the new challenge of adapting their craft to feminine form and fancy.

Not until the early nineteenth century did careful fit become a criterion of well-tailored garments. The understructure remained, but the shaping became more subtle, its purpose now being to complement rather than to distort the natural lines of the body. Great attention was also given to the flawless lay of the garment fabric over the canvas form. The lapel was to roll gracefully open at the chest, without pulling the garment forward, away from the body. All edges of the jacket were to belie the existence of the several layers of fabric beneath, by being flat and

sharp, without noticeable bulk. The collar, and all curved edges of the garment were to incline ever so slightly inward toward the body, a graceful avoidance of the awkward, upward curl of collar tips and pocket flaps. Pockets were never to gape open when not in use, and vents were expected to lie flat and firm. The result was a clean definition of design lines, a controlled yet graceful presentation of the garment fabric, impeccable fit, form and detail.

The construction techniques presented in this book and practiced today, with minor variations, by the finest tailors all over the world, have changed very little in the past 100 years. Although new machines and new methods of fusing layers of fabric together offer today's tailor speedy alternatives to time consuming handwork, relatively few of these faster methods have been adopted by custom tailors. The sewing machine is used for almost all seams and darts, but almost 75 percent of all stitches in a custom-tailored suit are still done by hand, to ensure the most accurate shaping of the fabric. The new fusible interfacings are being used by most custom tailors to reinforce certain small areas, such as dart tips or the inside of some pockets, however, they are not considered acceptable substitutes for the multi-layered, hand-stitched canvas interfacing which gives body to the entire front of the jacket.

Today's tailors continue to practice their art almost exactly as it was practiced a century ago. Not because slower is necessarily better, but because these methods produce body and form, detail and durability which newer faster methods of tailoring are simply unable to equal.

We encourage you to enjoy the tailoring process as much as its beautiful product, and to afford yourself the necessary time and patience to become proficient in these time-honored skills.

GENERAL TAILORING SUPPLIES



Bent Handle Shears

These shears are designed for the most convenient and careful cutting of fabric. In use, the handle bends up and away from the cutting surface while the blade is allowed to slide along the surface without disturbing the lay of the fabric. A 10" (25.4 cm) to 12" (30.5 cm) pair will handle most tailoring needs. Fine shears will give best service if they are oiled and sharpened when necessary, and if they are not used to cut materials other than fabric.

Thread Snips

Small, sharp, pointed scissors. Used for easy access to small areas, and for cutting threads.

Clay Tailor's Chalk

White clay chalk. Used for marking pattern information onto the garment fabric. The edge of the chalk should be sharpened before use, for a clean, fine line. Clay chalk can be brushed away easily when no longer needed, however, avoid pressing on top of the chalkmarks, as this will make removal more difficult. Darker colored chalks are used for markings on interfacings.

Tapemeasure

Necessary for taking body measurements. Available with inches printed on one side and centimeters on the other. Special tapemeasures are also available for taking the inseam measurement for trousers. These tapemeasures have cardboard stiffening at one end. The cardboard, and not the tailor's hand can then be placed at the top of the inseam for measuring. Plastic, rather than cloth tapemeasures should be purchased, since those made of cloth are inclined to shrink.

Ruler

Flexible, plastic see-through rulers are very convenient for measuring curved areas on patterns and fabric, as well as for flat surfaces. Do keep them away from the iron!

Hip Curve Ruler

A gracefully curved ruler essential for making and adjusting pattern lines.

Straight Pins

Either dressmaker pins, which are of medium thickness, or silk pins, which are somewhat thinner, are appropriate for tailoring needs.

Basting Thread

White cotton thread #40–#50, easy to break for removal when necessary.

General Sewing Thread

Mercerized cotton thread, #0 or #00, or size A, *silk thread*, is suitable for both hand and machine stitching.

Buttonhole Twist

Silk tailor's twist #8 is best for making hand-worked buttonholes. It is also used for sewing on buttons. The twist comes on large spools, six strands of silk loosely intertwined. The strands are separated and used singly. If tailor's twist is unavailable, *size D, buttonhole twist*, will do.

Gimp

Stiff cord, in a color close to that of the garment fabric. Used to reinforce the edges of hand-worked buttonholes.

Beeswax

Used by tailors to coat thread for hand sewing, to prevent the thread from knotting and gnarling. For hand topstitching the thread is also pressed between sheets of paper after having been drawn through the beeswax. This process keeps the several strands, which constitute the thread, flat and uniform.

Tailor's Thimble

Worn as a protection for the middle finger, the area which covers the fingernail is used to push the needle through the fabric. Tailor's thimbles are open at the top for comfort.

Needles

Hand sewing needles for tailoring come in a variety of lengths and widths, in categories called *sharps* and *betweens*. *Betweens* are shorter, stronger needles. *Sharps* are medium to long in length. Within each category, the needle sizes are numbered. The higher the number, the shorter and thinner the needle. A #7 sharp needle might easily take you from beginning to end of your tailoring project.

Buttons

The button size is measured across the diameter in "lines," 40 lines to the inch. 30-line buttons are used on the jacket front, 24-line buttons can be used for the sleeves, the pants, and back pocket. Dull bone or horn buttons are most attractive on the classic suit. Plastic buttons break easily and sharp edges in the hole of the button often tear the thread.

Zipper

Use a strong zipper with metal teeth for the pants fly; one which is at least 1" (2.5 cm) longer than the fly measurement.

For a skirt, the zipper should be the length of your hip level measurement (see page 17).

Muslin

A lightweight cotton fabric, from which tailors make a prototype of the suit. Used to check fitting details.

UNDERSTRUCTURE SUPPLIES

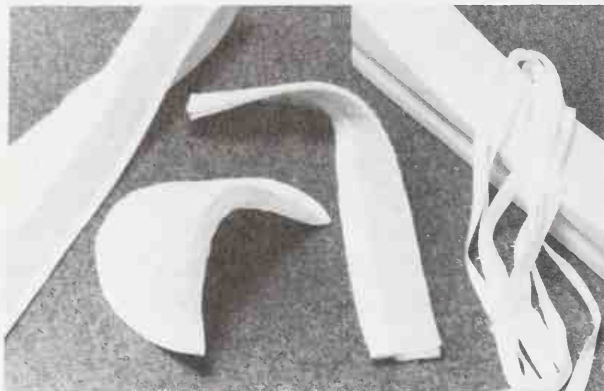

Wool Canvas Interfacing

Woven from wool and hair fibers, used as a supporting fabric for the jacket front. The interfacing adds shape and body to the garment fabric, and reduces wrinkling. It should be soaked in cool water, allowed to drip dry and pressed before use, to ensure against its shrinking in the finished garment.

A lighter weight wool canvas interfacing is used if your jacket has a full canvas (see page 100).

Pocketing Fabric

Soft, strong cotton fabric, tightly woven and without sizing. Used to form the insides of pockets, and as a stay, or reinforcement for several areas on the jacket and pants.

Lining

A lightweight, smooth fabric of rayon, silk or polyester; used in jackets, skirts, and pants. Despite being lightweight and soft, the lining must be strong enough to endure constant, long-term wear.

Prepadded Collar Melton

Two fabrics—French canvas and melton—machine-pad-stitched together, from which the jacket undercollar is constructed. The melton should be of a color that matches or coordinates with the color of the garment fabric. Since this prepared undercollar fabric is often difficult to find in the color or quality desired, tailors often buy the melton and canvas separately and hand-stitch them together.

Undercollar Melton

A strong wool fabric in a color that coordinates with the garment fabric. Used to give crisp body and sharp edges to the jacket collar.

French Canvas

A stiff, linen interfacing; used in the undercollar.

Waistband Interfacing

A layer of stiff interfacing; used to give support to the garment fabric in the waistband.

Shoulder Pads

Gracefully shaped layers of cotton wadding covered with muslin. Used to define shoulder area.

Sleeve Head

A strip of cotton wadding or lamb's wool, reinforced with a bias strip of wool canvas interfacing, sewn into the cap of the sleeve. The head fills out the sleeve cap and helps create the graceful fall of the sleeve fabric.

Cotton Twill Tape

$\frac{3}{8}$ " (1 cm) wide, used to define the outer edges of the lapel and jacket front, and to control the lapel roll line. The tape should be soaked in cool water, and pressed before use to ensure against shrinkage in the finished garment.

Grosgrain Ribbon

A closely woven corded ribbon, usually of silk or rayon. Used as a waistband or waistline backing.

Shirring Tape

A thin, loosely woven bias tape; used on the underside of gathers.

HAND STITCHING

If you are not used to hand sewing, we can almost guarantee that you will begin by:

- Cutting your thread much too long
- Pulling your stitches much too tightly
- Resisting the use of a thimble until your finger begins to bleed.

If you can manage to pass through this beginning stage quickly, you will save yourself a great deal of aggravation.

Using a very long thread does not necessarily mean that you will be threading your needle less often. On the contrary, it usually means that your thread will gnarl and tangle, and that you will have to break off the tangled area repeatedly, losing all satisfaction in your work. Use a comfortable length of thread, one which does not require you to stretch your arm with each stitch. If you still have trouble with tangles, draw the thread through a piece of beeswax.

Tightly pulled stitches are usually placed with great care and concentration, and unfortunately, their intensity is usually clearly visible on the front of the garment. There is just no need to nail the layers of fabric this tightly together. Any stitch which goes through to the right side of the garment should pick up only one thread of the garment fabric, and should be drawn softly enough to leave that thread's appearance unchanged on the right side of the fabric.

A thimble is more necessary in tailoring than in other hand sewing, because of the added pressure needed to drive the needle through several layers of fabric. The tailor's thimble is open at the top for comfort. The fingernail area of the thimble, instead of the top, is pressed against the needle. Simply place the thimble on the middle finger of the hand you sew with, and your finger will figure out how best to use it.

Innumerable rows of *basting* are required in producing a tailored garment. Basting is more accurately done if the two layers of fabric to be joined are laid flat on the table to avoid shifting. With one hand holding the fabric flat in place, and the other hand placing the stitch, your work will progress quickly and accurately.

Basting stitches, like other hand stitches, should be placed without tension. Since these are temporary stitches, more attention should be given to their location than to their appearance. Each row of basting is begun with a backstitch to secure the thread. Basting thread is never knotted at the end, since knots would make the eventual removal of the basting more difficult and more hazardous to the fabric.

The most common hand stitches are illustrated here. Others will be presented throughout the text as their need arises.

saddle stitch

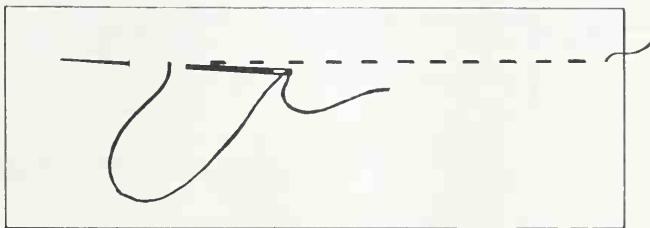

back stitch

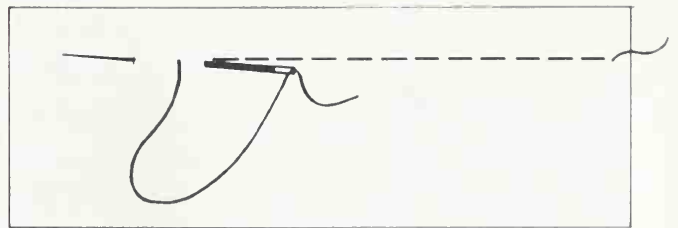

prick stitch

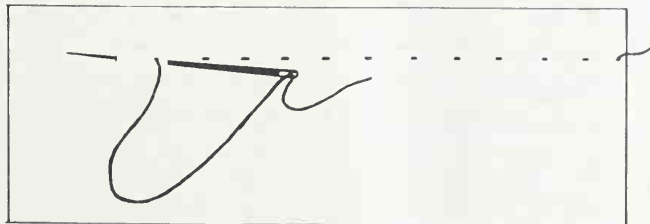

running stitch

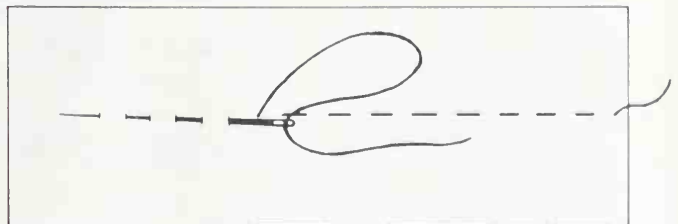

slip stitch

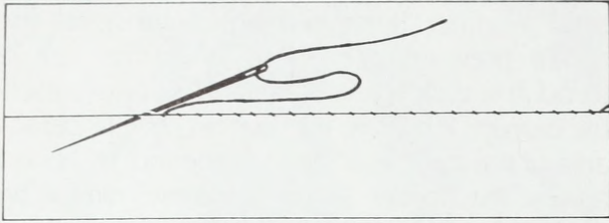

cross stitch

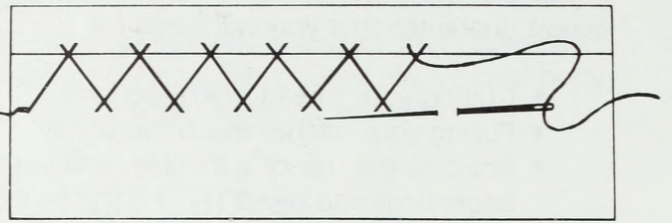

double cross stitch

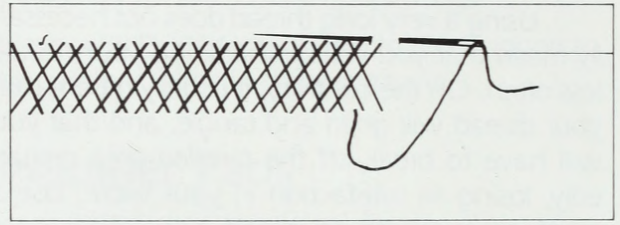
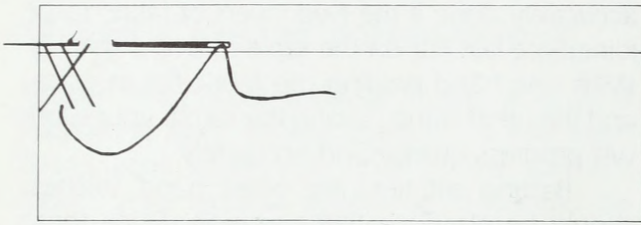

overcast stitch/whip stitch

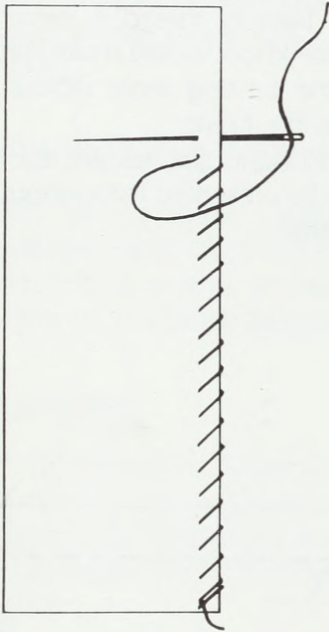

diagonal stitch/pad stitch

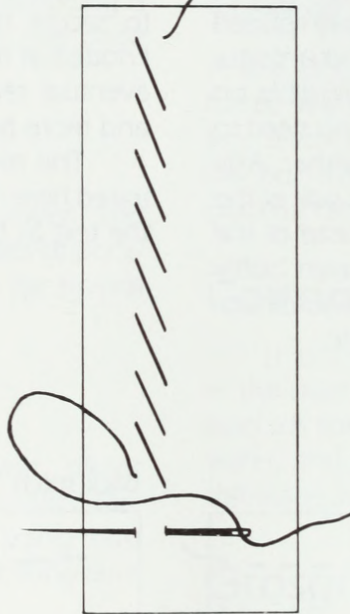

blanket stitch

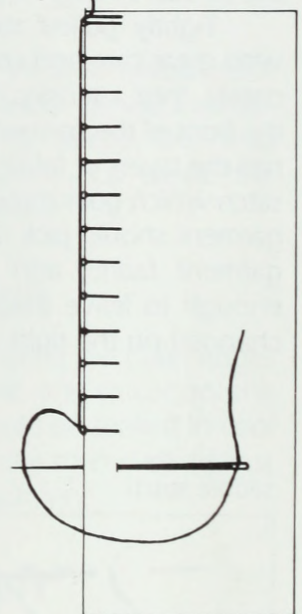

hem stitch

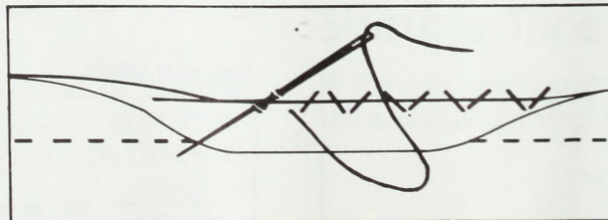

PRESSING SUPPLIES

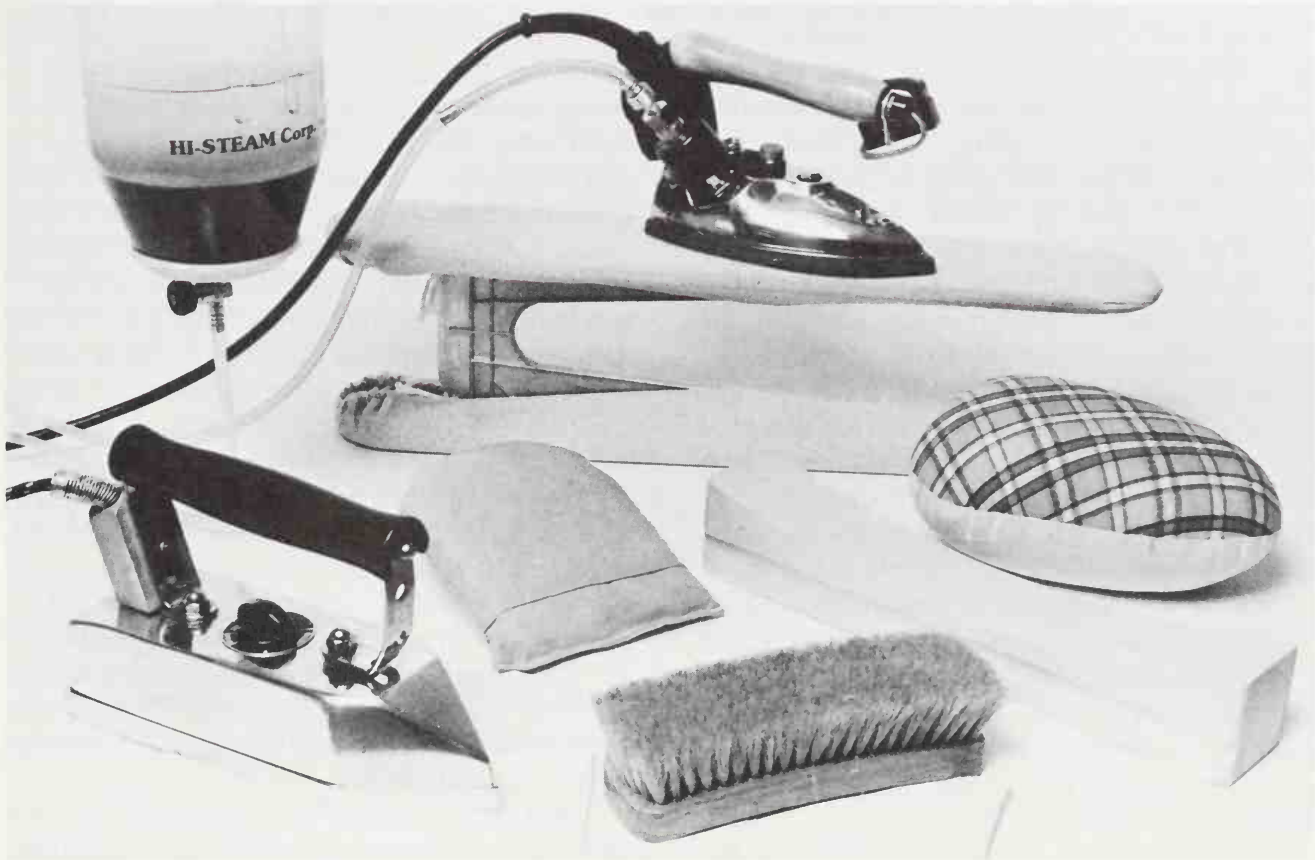

Heavy, Dry Iron

About 12 pounds or more in weight; preferred over lighter weight irons by most tailors, because of the added pressure the weight affords, especially in the job of flattening and reducing bulk by pressing.

Steam Iron

Professional models offer a powerful surge of steam; preferred by those who find heavier weight irons difficult to manipulate.

Sleeve Board

A small ironing board convenient for pressing the sleeve and other difficult to reach areas.

Tailor's Ham

A tightly packed, large or small, curved pressing surface, preferably stuffed with sawdust.

Pleater

A wooden block, curved on one side and flat on the other. Used as a pressing surface or as pounding block for flattening bulky edges.

Brush

Used for brushing the fabric, and for pounding delicate areas.

Presscloth

Soft cotton fabric which is free of sizing. Used to protect the garment fabric from direct contact with the hot iron. With a dry iron, the presscloth is dampened to produce steam.

Press Mitt

A padded mitt worn on the hand. Used to assist in pressing areas that do not lie comfortably on a tailor's ham or ironing board, especially the sleeve cap and shoulder area.

PRESSING TECHNIQUES

Pressing is an integral part of the tailoring process. Besides ridding the fabric of wrinkles, and producing neat, flat darts and seamlines, the iron is used in tailoring to gently shape the fabric. Using heat, moisture and pressure, fabric which is suitable for tailoring can be shrunk in some areas and stretched in others, so that it will hang most gracefully as a finished garment.

The amount of heat, moisture and pressure necessary to accomplish your job depends upon the weight and quality of your fabric. Therefore, before using the iron on your fabric, it is essential that you pretest, using a fabric scrap. If your heat setting is too high, the fabric fibers will flatten out and produce an unattractive shine. If your presscloth is too wet, the fabric will shrink and matt.

Wool fabric is very vulnerable when damp. Therefore, rather than pulling the iron back and forth over the fabric, and stretching the fabric off grain, the iron is placed and lifted, placed and lifted, etc. A presscloth is always needed between the iron and the garment fabric to prevent damage to the fabric.

Flat seams can be safely pressed on flat surfaces. However, if a curved area of the garment is placed on a flat surface for steam pressing, and restricted by the flat surface of the hot iron, the fullness in the fabric will shrink as much as it can, in order to fit into this limited space. For this reason, curved areas of the garment are laid over a tailor's ham so that the ham might fill out the shape of the garment. Steam pressing a curved area in this manner will not result in shrinkage, since the fabric is being pressed in conformity with its own shape.

Using a dry iron, the best procedure for pressing is to cover the fabric with a uniformly damp (not dripping) presscloth, and then to lay

the hot iron on the presscloth until steam is produced. Pressure is added while the fabric is being steamed. Remove the iron and the presscloth while the steam is still being produced. If you are pressing a curved area of the garment, allow the fabric to lay over the ham for a few minutes while it dries. If the ham is stuffed with sawdust the wood particles will absorb the moisture fairly quickly. After pressing flat areas of the garment, the fabric can simply be hung up to dry. Drying the fabric completely before lifting the iron, will flatten out the wool fibers and rob the fabric of its life.

Some worsteds or heavier woolens will require more than the normal amount of pressure to create sharp, flat edges. Pressing on a wooden surface—the area to be flattened can be struck sharply with a pounding block while the fabric is still steaming. This extreme pressure, coupled with the instant drying produced by the blow and the wooden surface, usually produces the desired flat, crisp edge.

If a shine appears on the surface of your fabric as the result of extreme heat or pressure, you will probably be able to eliminate it by lightly steaming the shiny area, and then using a soft brush to coax the fibers back to life.

The beginning tailor usually sins by excess—dampening, pressing, pounding the fabric limp. Remember that the surface life of the fabric is quite vulnerable, as are the many bias and semi-bias raw edges which can all too easily be stretched out of shape. If each of the several pieces of your garment are handled carefully during the tailoring process, and laid carefully aside when not in use, the amount of pressing needed will be greatly reduced.

TAILORING SUPPLY SOURCES

S. Beckenstein Inc.
125 Orchard Street
New York, N.Y. 10002

Bergen Tailor and Cleaning Supply Corp.
9027 River Road
Edgewater, N.J. 07020

Gubi Linings and Trimmings Co.
61 Delancey Street
New York, N.Y. 10002

Louis A. Lew Co., Inc.
108 Fifth Avenue
New York, N.Y. 10011

Sew and Show
401 North Avenue
Garwood, N.J. 07027

Greenberg & Hammer Inc.
24 West 57th Street
New York, New York 10019

Steinlauf & Stoller Inc.
239 West 39th Street
New York, New York 10018

Nat Gelfman Company Inc.
237 West 35th Street
New York, New York 10001

2 The Pattern

Unless you are skilled enough to create your own pattern, your job now is to carefully choose and adjust a commercial pattern in order to produce a personally flattering *style and fit*. Beautifully detailed construction is wasted on a garment which does not fit, or on a style which does not suit the wearer.

The size of the skirt and pants patterns is determined by the hip measurement, and, for most women, the bust measurement will be the best gauge to determine the size of the jacket pattern. If, however, your bust is very full or very flat, check the information on pages 26 and 27 before purchasing and adjusting your jacket pattern.

THE JACKET PATTERN

In selecting the jacket style of the pattern, look to the broad style lines. For the moment, ignore such things as styles of pockets, or whether there is a back vent, or if the jacket pattern includes a lining. Fortified with the tech-

niques outlined in this book, all you will use from the pattern envelope are the basic pattern pieces: *the jacket front, side panel and back, the sleeve, and the undercollar*. You will be able to create the rest of the jacket on your own.

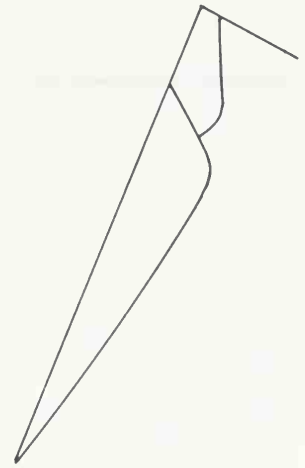
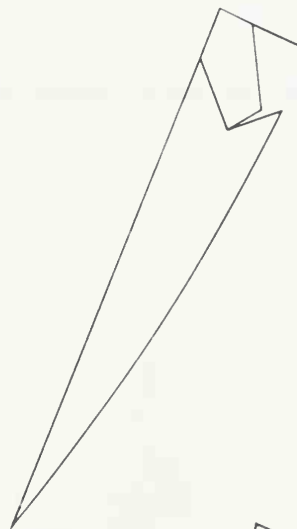
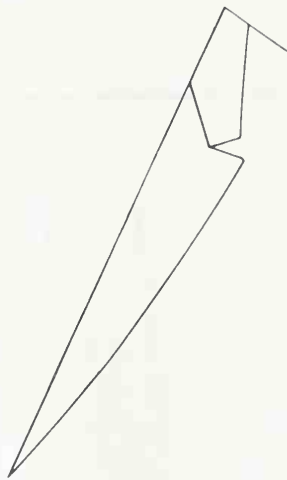

Look to the shape of the collar and lapel as they meet at the gorge line, and choose your jacket pattern.

The lapel width is a matter of taste and current trend. A safe width for a lapel which you would be able to wear for many years would be about 3" (7.6 cm). Remember that out of style, wide lapels may always be tapered (page 282), but lapels which are too narrow can only hang in the closet until fashion welcomes them back again.

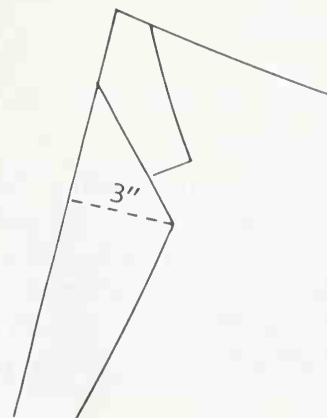

welt pocket

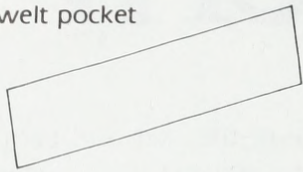

double piping pocket

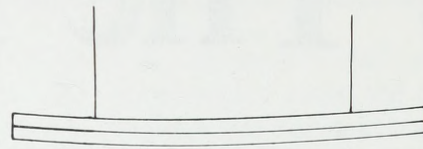

double piping pocket with flap

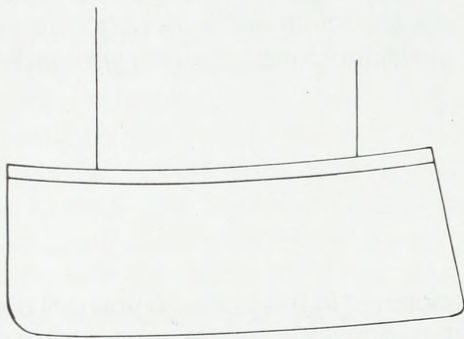

patch pocket

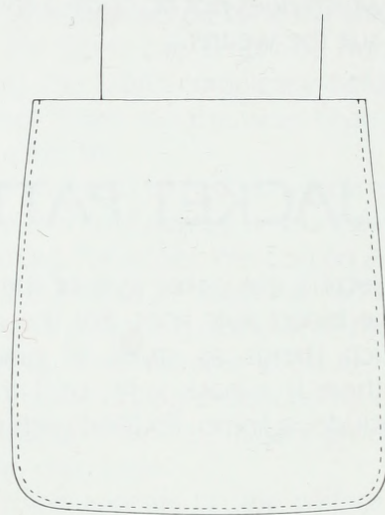

You will be able to interchange patch pockets with double piping pockets, or to add a welt breast pocket if there is none. You will not need your pattern envelope to help you with making these changes.

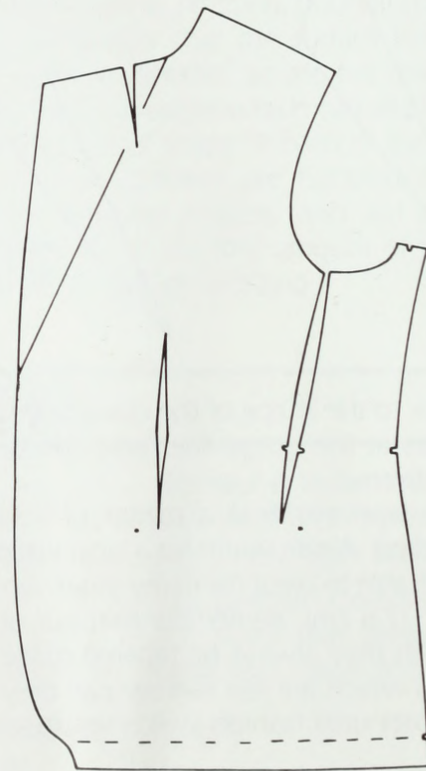

If you will be working with a plaid fabric, choose a pattern that eliminates the seam below the pocket by using a dart instead of a separate side panel. The plaid below the pocket is then undisturbed by seamlines, and matching the plaid during the construction of the pockets is not difficult.

THE SKIRT PATTERN

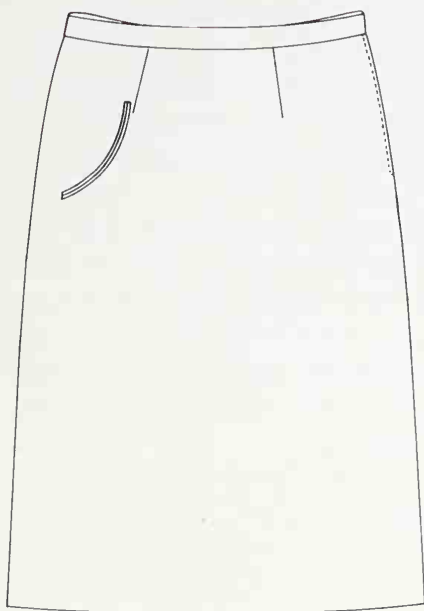

basic straight skirt

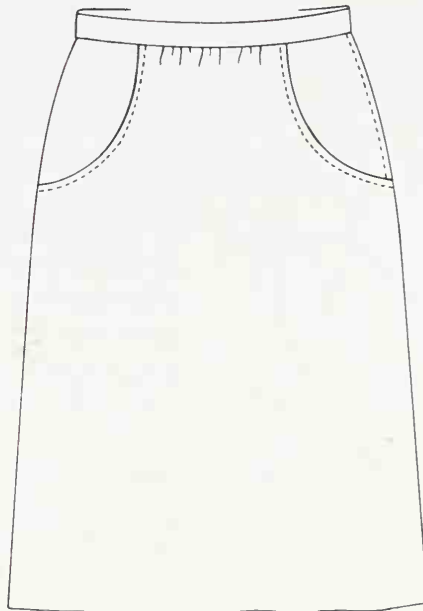

straight skirt with shirring

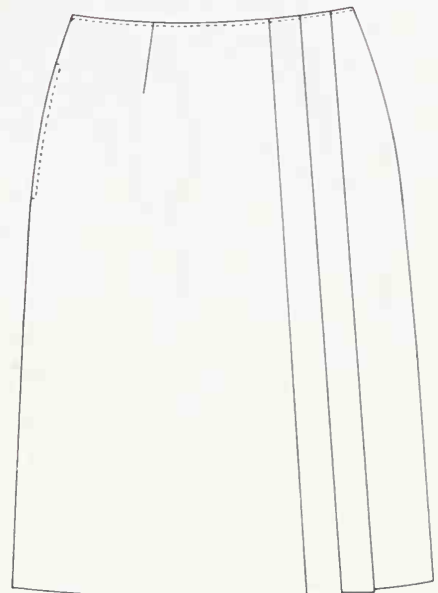

skirt with pleats

We suggest that you begin with a *basic straight skirt* pattern. Once you have a well-fitting straight skirt, your pattern can easily be

modified to create a variety of styles. The three skirts which are constructed in Chapter 7 are adapted from the same straight skirt pattern.

THE PANTS PATTERN

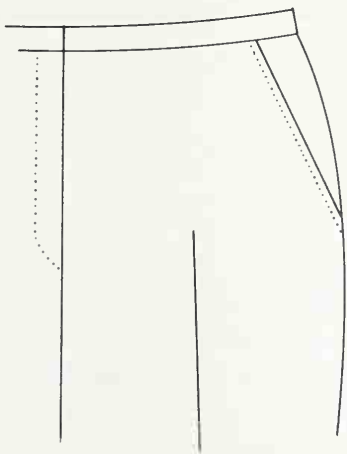

slant pocket

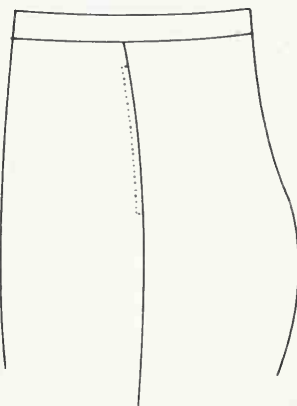

side pocket

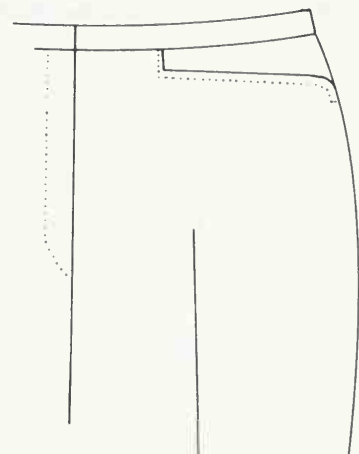

Western pocket

In selecting a pants pattern, select a high or low rise, whichever your client has found to be more comfortable, and decide for or against pleats.

No matter what style pockets you would like, the best pants pattern to buy is one that has side pockets rather than Western or slant pockets. This will give you a pattern with side and waistline seams intact—a pattern that can be

modified to create all three pockets using the patterns included in this book. (If you choose a pattern with front pleats, of course, you forfeit your option for a Western pocket.)

The *width of the pants leg* should not be a determining factor in choosing the pattern, since this is a minor pattern alteration (page 290). *Cuffs* also can be added or subtracted without difficulty (page 14).

PRELIMINARY PATTERN ADJUSTMENTS

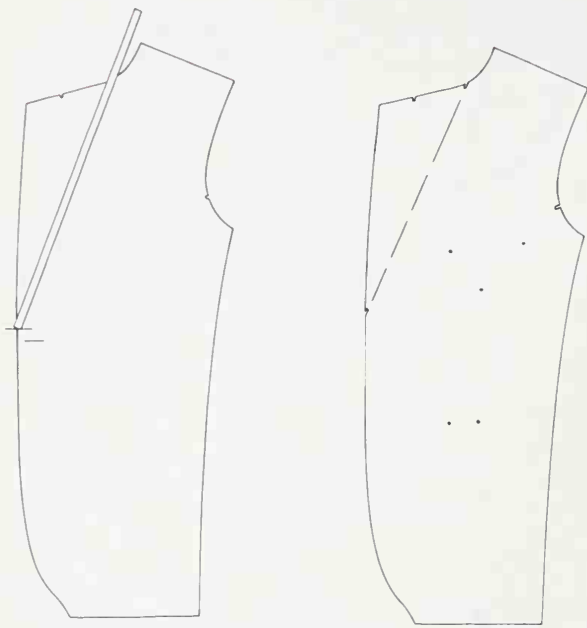

1. Jacket Roll Line

Draw the lapel roll line on your pattern if it is not already indicated. The roll line begins about $\frac{5}{8}$ " (1.6 cm) above the top button, and is drawn at an angle which would bring it $\frac{3}{8}$ " (1 cm) out from the neck cutting edge at the shoulder. Notch the top and bottom of the roll line.

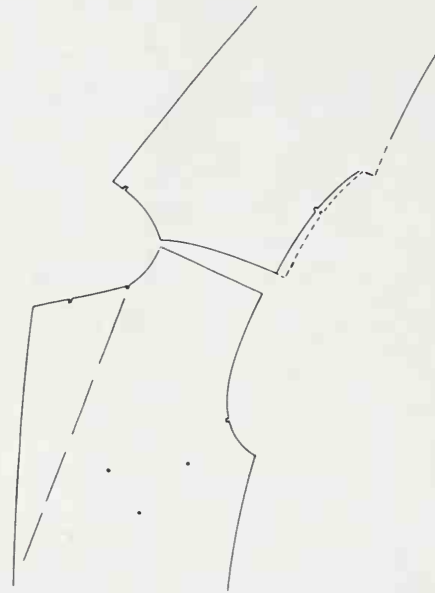

2. Shoulder Seams

The jacket back shoulder seam should be at least $\frac{1}{2}$ " (1.3 cm) longer than the front shoulder seam, to allow for ease of movement. Measure your pattern shoulder seams. Add $\frac{1}{2}$ " (1.3 cm) to the back shoulder seam if it has not been included.

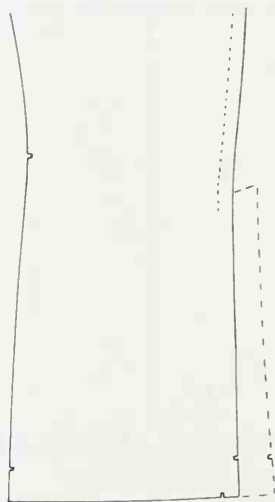

3. Vents

If you would like to add a *center back vent* to a jacket which does not have a back vent, extend your pattern out 2" (5 cm) from the stitchline at the top of the vent, and 3" (7.6 cm) at the bottom. The top of the center back vent is about 1" (2.5 cm) below the waistline.

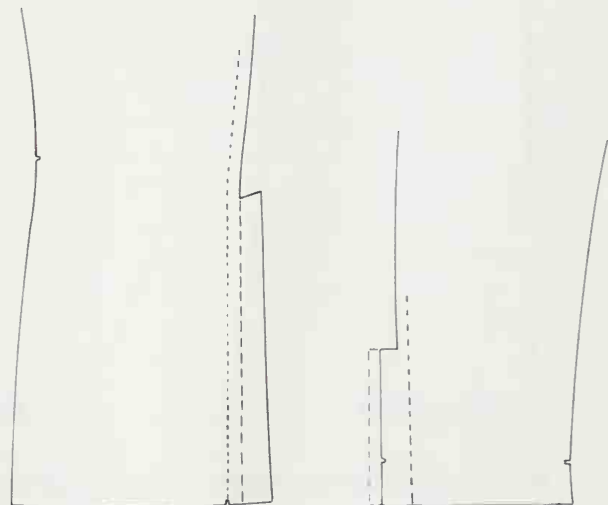

If your pattern includes a back vent and you wish to eliminate it, simply treat the vent foldline as a stitchline, and trim away the pattern beyond the seam allowance.

If the vent is not at least $1\frac{1}{2}$ " (3.8 cm) from the foldline on both the topsleeve and the undersleeve patterns, extend it to that amount.

4. Revised Facing Pattern

If the outer edge of the facing pattern is curved to match the shape of the outer edge of the jacket lapel, the facing pattern must be redrawn. This procedure is an inconvenience, but one which will produce a far more professional product.

We are redrawing the facing pattern in order to create a pattern that will enable us to place the straight of the grain on the facing at the outer edge of the lapel. This is essential for a controlled, graceful lay of the fabric. We will also add ease to the facing to assist in the roll of the lapel.

This adjustment, although detailed here, should only be made *after* the muslin fitting, when the jacket front pattern corrections have been completed.

Use the jacket front pattern as a guide, and draw a new facing pattern on oaktag or brown paper. Trace around the jacket front pattern leaving $\frac{1}{2}$ " (1.3 cm) margin at the shoulder, neck and top of the lapel. The front of the facing pattern is a straight line, which is drawn $\frac{1}{2}$ " (1.3 cm) away from the center of the lapel and continues to $\frac{1}{2}$ " (1.3 cm) below the bottom of the jacket.

The front edge of the facing does not yet take the shape of the front of the jacket. This shaping will be accomplished *later* with the help of the steam iron.

Indicate the bottom of the lapel and the waistline notch on the facing pattern, and remove the jacket front pattern.

The facing extends 3" (7.6 cm) past the center of the roll line, and should be 3" (7.6 cm) wide at the shoulder. The facing should be cut $5\frac{1}{2}$ " (14 cm) wide at the bottom for a jacket that curves in at the center front hem. For a straight front jacket, the bottom of the facing is 4" (10.2 cm) wide.

Add a seam allowance notch at the top of the lapel, $\frac{1}{2}$ " (1.3 cm) in from the edge. Your revised facing pattern is complete.

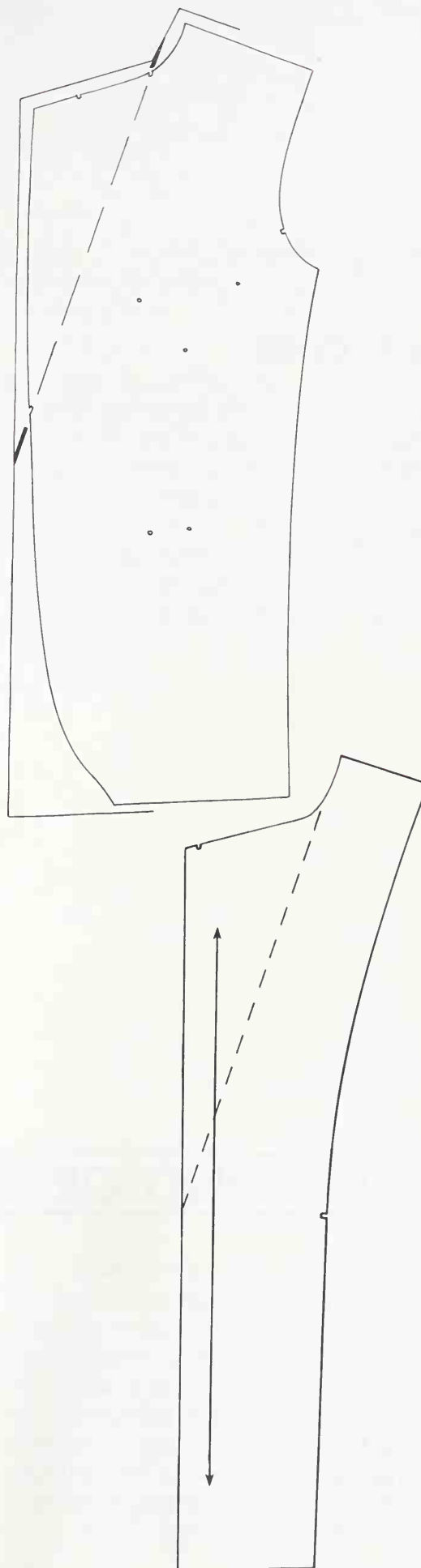

5. Pants Cuffs

If your pattern does not include cuffs and you would like them, extend the bottom of your pants pattern below what will be the bottom edge of the finished pants—an amount equal to at least three times the cuff width. The average cuff width is 1 1/2" (3.8 cm). If you have the fabric, it would be wise to leave slightly more fabric, since the final determination of the pants length is made only after the pants are completed.

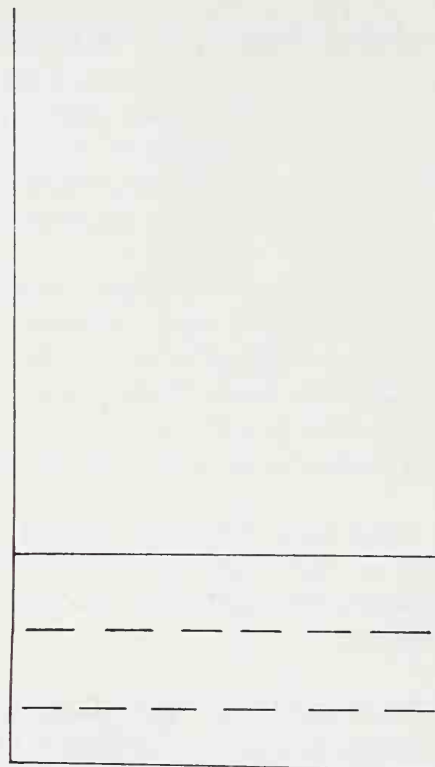

LENGTHENING OR SHORTENING PATTERNS

With the preliminary pattern check completed, lengthen or shorten your jacket, skirt, and pants patterns as indicated by your measurements. Follow the instructions for length adjustments given on your pattern. As a general guide pants should be long enough to reach to the middle of the back of the shoe. Leave yourself a generous hem at the bottom of the pants for now. Length of skirts and jackets is a matter of taste and the current style trends.

If you have had successful experience with flat pattern alterations, you may wish to make further adjustments to your pattern at this point. If you have no experience, or only painful memories regarding pattern alterations, leave the adjustments for the moment. The needed pattern alterations will become very obvious in the muslin fitting.

3 The Fit

MEASUREMENTS

The following are standard measurements taken by tailors, and used by them to draft patterns which will fit their clients as closely and as comfortably as possible. In conjunction with the measurements, the tailor also notes important information about the client's body: whether her posture is stooped or overly erect; whether her shoulders are square or sloped; whether her bust and buttocks are full or flat; whether her stomach protrudes; whether one hip or one shoulder is higher than the other, etc.

In order to get an uncensored picture, the tailor keeps the client away from the mirror during these observations. The temptation to suck in the stomach and stand up straight for the mirror, is too strong. If the tailor were to note that version of the body, the suit would fit only in

front of a mirror. While making the pattern, the tailor applies his craft to build into the pattern whichever characteristics are needed.

If you are not a skilled patternmaker, and are, therefore, using a commercial pattern, certain fitting and style adjustments will undoubtedly be necessary. Your pattern will have to be customized after the fact, by means of a muslin fitting.

The standard tailors' measurements taken in this chapter will, therefore, most likely be used by you only to choose a commercial pattern closest to your client's fit, and to adjust the length of the pattern. All other adjustments of the pattern will be diagnosed and made during the muslin fitting.

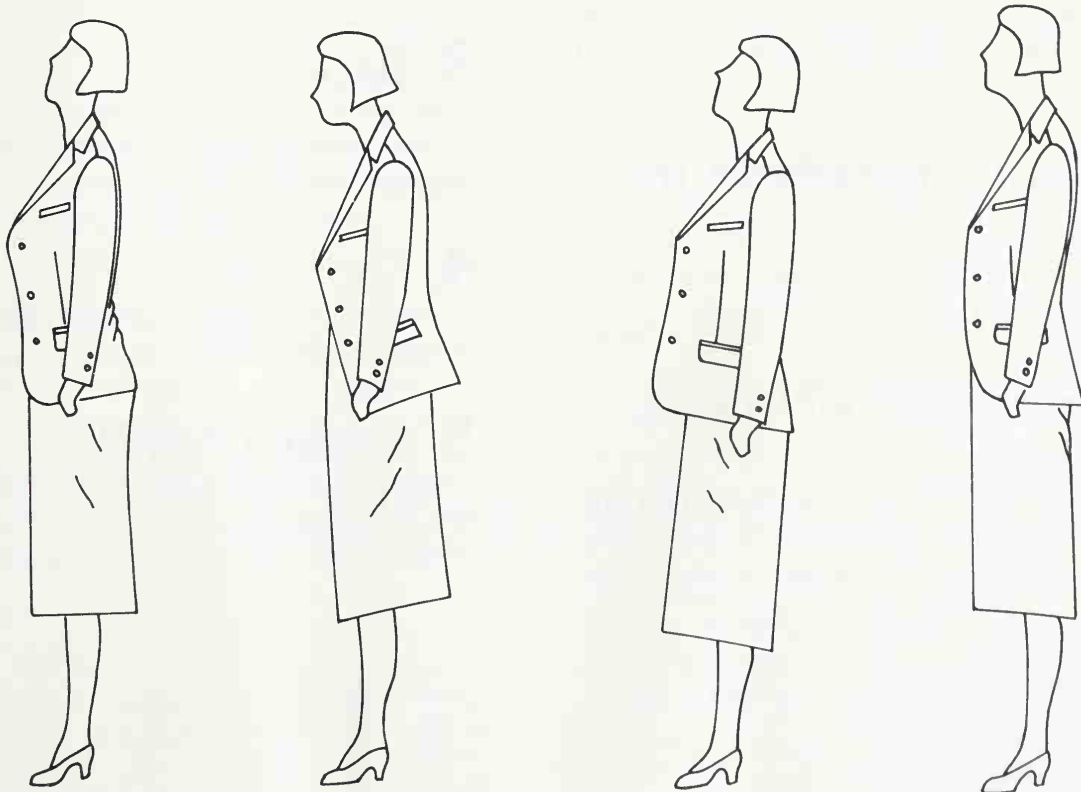

HOW TO TAKE MEASUREMENTS

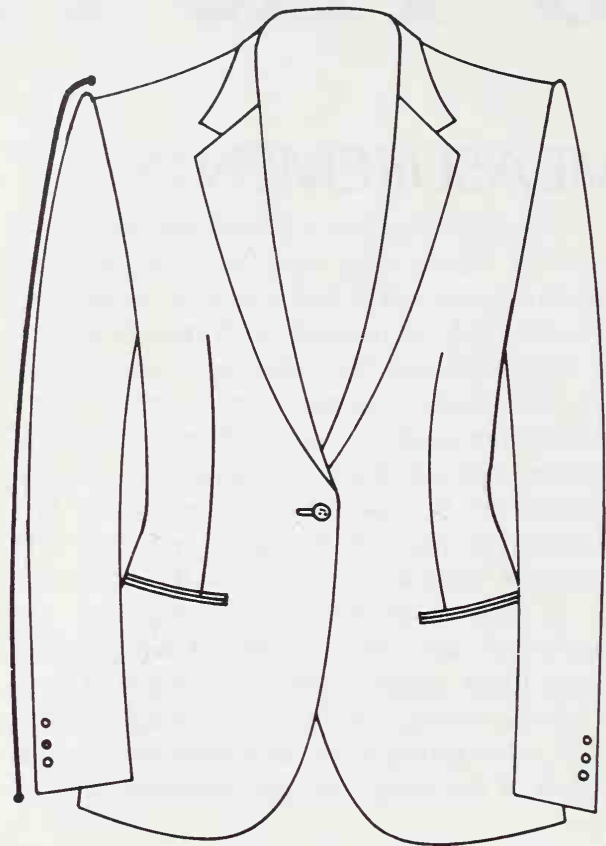
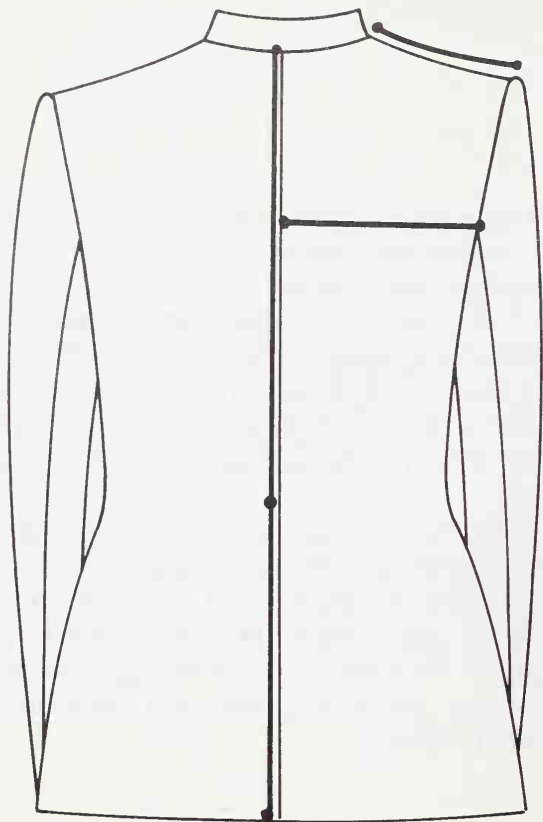

The first five measurements are taken over the best fitting jacket the client has available. *Don't* be concerned if the jacket is not a perfect fit. We will have an opportunity to improve the fit during the measurements and the muslin fitting.

1. Center Back/Neck to Waist

With the jacket collar up, measure from the collar seam to the waist at center back.

2. Center Back/Neck to Hip

With the tapemeasure touching the body at the waist, measure from the collar seam to the hip level. Of course, the length of your jacket

depends on the style you have chosen. Take your measurement to the hip level as a point of reference for adjustments in the muslin fitting.

3. Back

At about center armhole level, measure across the back from the armhole seam to the center back seam.

4. Shoulder

Measure the shoulder seam from collar seam to armhole seam.

5. Sleeve Length

Measure the sleeve from the shoulder seam to the hem fold, taking into consideration the slight rise of the sleeve over the shoulder pad.

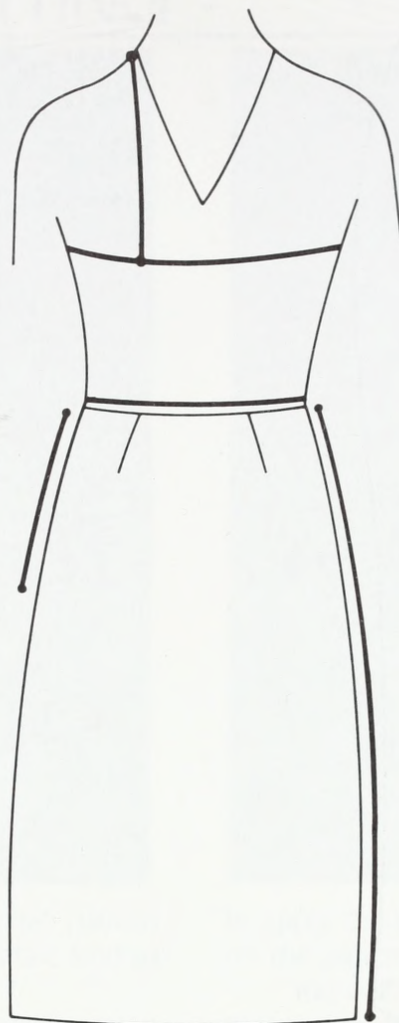

6. Bust

Measure around the body at the fullest part of the bust. This measurement can be taken over a blouse, but not a sweater. Check that the tape measure is at the same level at the back as in the front. The measurement should be comfortable, neither too loose nor too tight.

7. Bust Level

Measure from the shoulder (about 1" (2.5 cm) from the base of the neck) down to the center of the bust. Be aware that this measurement can change significantly depending on the bra that is worn. Therefore, the type of bra that will usually be worn under the jacket, should be worn for this measurement.

8. Waist

The waist measurement can be taken over a blouse, but not over a skirt waistband, or a

belt. The measurement should be comfortable, but without additional ease.

9. Hip Level

Measure down from the waist at the side seam, to the level at which the hips are fullest.

10. Hips

The hip measurement can be taken over an unbulky straight skirt or trousers. The pockets, if any, should be empty and the client's feet should be together. With two fingers under the tape for ease, measure around the fullest part of the hip.

11. Skirt Length

Measure down from the waist at the side seam, to the desired length of the skirt.

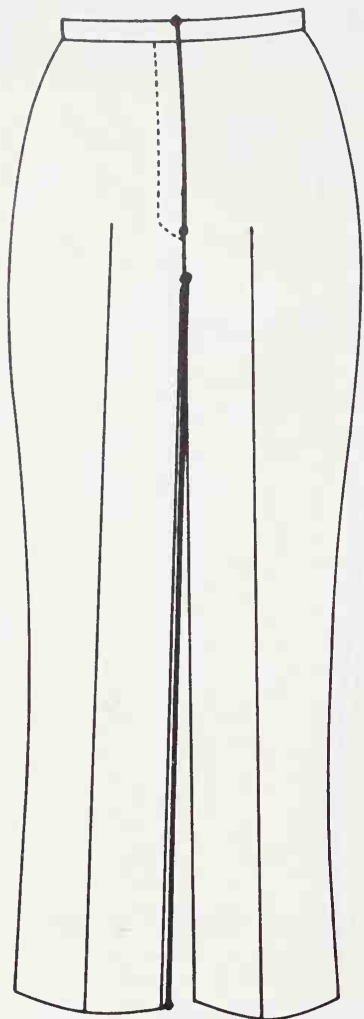

12. The Fly

Have your client raise the waistline of the trousers she is wearing until they just touch the body at the crotch. If the waistband is much too high on the client, when the pants are in this position, the fly is too long.

If she cannot get the waistline of the pants up to her waistline, without the pants becoming uncomfortable in the crotch, the fly is too short.

Measure the fly from what should be the top of the waistband, down to the beginning of the curve of the crotch.

13. Pants Inseam

With the pants waistline at a comfortable level for the client, measure the pants inseam from the crotch to the middle of the shoe. As a courtesy to the client, there are special tape-measures for taking this measurement. The top few inches of the tapemeasure have a piece of

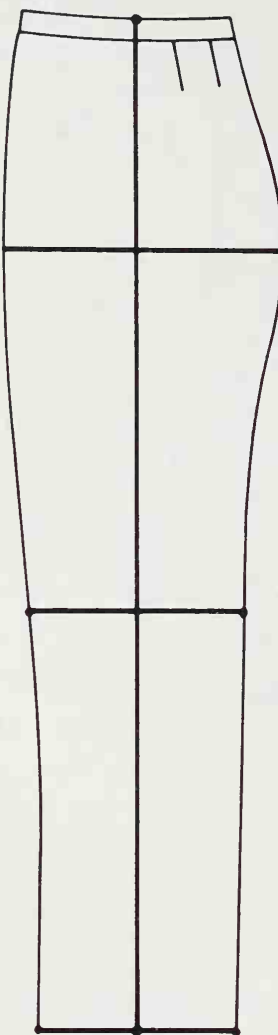

cardboard attached, so that the cardboard, and not the tailor's hand reaches to the top of the inseam.

14. Pants Outseam

With the pants waistline at a comfortable level for the client, measure down the outseam from the top of the waistband to the middle of the shoe.

15. Knee Width

Measure across the knee of the pants from crease to crease.

16. Width of Pants at Hem

Measure across the bottom edge of the pants leg from crease to crease.

THE MUSLIN FITTING



The next step is to cut the basic pattern pieces from a good quality muslin fabric and to check the fit.

We assume that you are anxious to get on with the job of making the real suit, and that you can think of hundreds of reasons to support you in avoiding this seemingly over-cautious step. However, unless you are a tailor with years of cutting experience, a muslin fitting *must* be made.

The muslin will serve as an inexpensive prototype of your suit, through which you can become aware of, (and then avoid) creases and wrinkles caused by the fact that your body is unique, and the pattern is an "average" size. These creases literally "point at" and advertise the peculiarities of your body, such as knock-knees or protruding seat.

If for the first time you are aware of the creases in the *finished suit*, it may be too late to eliminate them; but the *muslin* offers an early warning system. The knock-knees and protruding seat will not disappear, but the wrinkles which note their presence will.

The pattern corrections given here are for some of the most common fitting problems. The procedure is to diagnose the problem, determine the amount needed to correct the fit, and then,

to apply the corrected amount at certain points on the pattern.

You will have to attach paper to the areas of the pattern that need expanding, so that new lines can be drawn, blending the corrected amounts gracefully into the original lines.

A hip curve ruler is an essential tool for this procedure. The contours of the hip curve coincide with the contours of the body. If you turn the hip curve, you will find a place on it that takes you smoothly from a newly added $\frac{1}{2}$ " (1.3 cm), back into the seamline. Use the curve of the original line as a general guide for the contour of the new line.

If the pattern correction has been at all significant, it would be wise to verify the corrections by changing the muslin accordingly. Only then can the cutting of your suit fabric be done with full confidence.

Now that you have decided to make the muslin, be aware that it is not an entire suit in muslin. For the jacket, cut only the front, back and side panel from muslin, and the undercollar from French canvas (for body). Eliminate the facing and the topcollar. Chalkmark on the muslin, lines that indicate the placement of the pockets, the buttons, and the center front.

A muslin sleeve will not be cut at this point.

When the jacket is almost finished, the armhole will be measured and a muslin sleeve will be cut to fit (page 164). Forget the sleeve for now. You will need shoulder pads for the jacket fitting. Use a pair of commercial pads. (On page 137 there are instructions for making your own shoulder pads, however, you may wish to make them only after the fitting, when you will have determined the amount of padding best for you.)

The skirt and pants muslin should include zippers and simple waistbands, so that you get a sense of the actual hang of the garment. The pockets can simply be chalkmarked.

Cut the muslin fabric with *full attention* to the *grain*. If the muslin is off grain, wrinkles may be quite misleading: they may be indicating bias draping, rather than fitting problems.

Machine stitch the seam allowances and darts accurately, and press the seams open.

The muslin jacket should be fit over a well-fitting blouse. A sweater should not be worn under the muslin, unless one will be worn regularly under the finished suit jacket. Attention

should be given to the height of the shoe heel, since variation here may significantly alter the length of the pants.

The first view of the muslin suit provides important information about the overall impression. The jacket and skirt (or pants) should provide a pleasing balance and style line for the figure. Although the classic blazer length is just below the hip, a woman with long legs and a short torso may require a jacket that comes well below her hips in order to create an attractive balance between top and bottom.

Wide lapels and pleated trousers may combine to create too heavy an impression for a shorter, slightly built woman. A long lapel may be better than a short one on a tall, broad-shouldered woman.

None of this is gospel. Use your eye and trust your judgment. If necessary, lengthen or shorten the jacket according to your pattern instructions, and then make whatever style adjustments you think best, using the guidelines on the following pages.

LAPELS—TOO WIDE/TOO NARROW

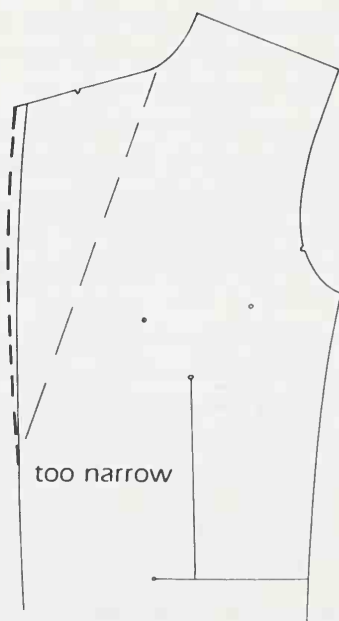

If you wish to widen or narrow the lapel, add to or subtract from the top of the outer edge of the lapel, and taper a line to the bottom of the roll line.

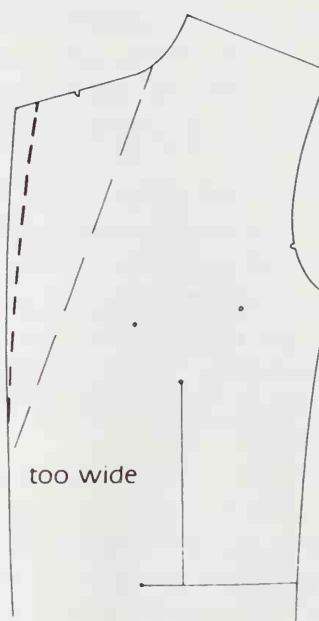

Adjusting the shape of the lapel will not prove a problem with the facing since we will eventually redraw the facing pattern using the new line of the lapel as a guide.

LAPELS—TOO LONG/TOO SHORT



If you would prefer to raise or lower the lapel, draw a line from the top of the existing roll line to the desired height of the lapel roll. Below the roll line, the jacket front tapers to a straight line.

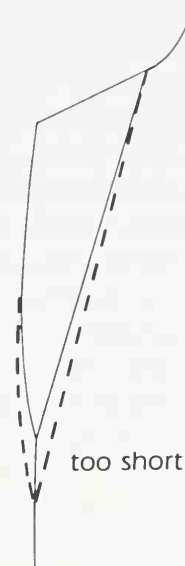

If you wish, the design of the collar can be completely changed during the construction of the collar (page 142).

JACKET BALANCE



With the preceding style problems out of the way, we will move on to the problems of *fit*. The procedure will be to correct the most obvious problems first, and to work our way down to the finer details. The major corrections often eliminate the minor ones before we get to them.

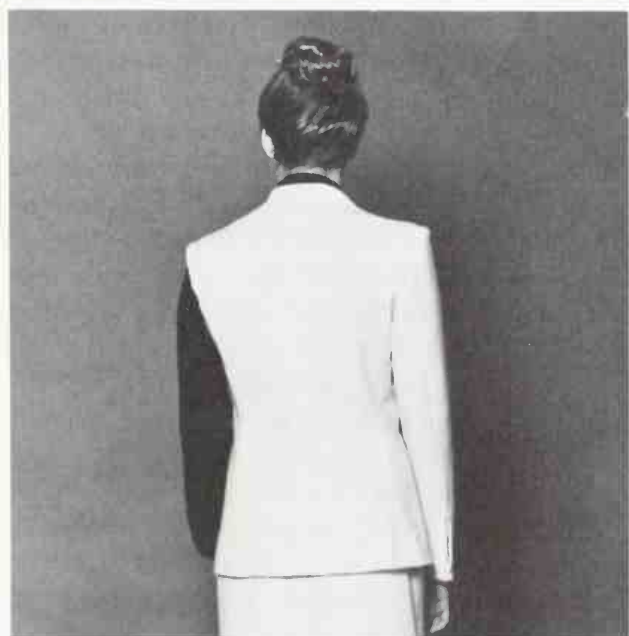

Far and away, the most obvious fitting problems are those caused by posture and body imbalance. If the client's posture is stooped or overly erect, or if one shoulder is higher than the other, the jacket will not hang correctly.

STOOPED POSTURE

A jacket on a woman with stooped posture will pull towards the *back* and *upwards*. To prevent the jacket from pulling, fold the pattern at the back side seam about $1\frac{1}{2}$ " (3.8 cm) below the armhole. Approximately $\frac{1}{2}$ " (1.3 cm) to $\frac{3}{4}$ " (1.9 cm) is folded out of the pattern at the seam, and tapered across the pattern back.

On the pattern front, about $1\frac{1}{2}$ " (3.8 cm) below the armhole, and about 2" (5 cm) in from the cutting edge of the side seam, draw a line across the pattern to the lapel edge, at a level just below the top of the dart. About $\frac{1}{2}$ " (1.3 cm) to $\frac{3}{4}$ " (1.9 cm) fabric is folded out of the pattern at the lapel, tapering to the end of the line.

The top of the side panel is lowered so that the side panel back seam from waist notch to armhole is equal in length with the newly adjusted side seam on the jacket back pattern.

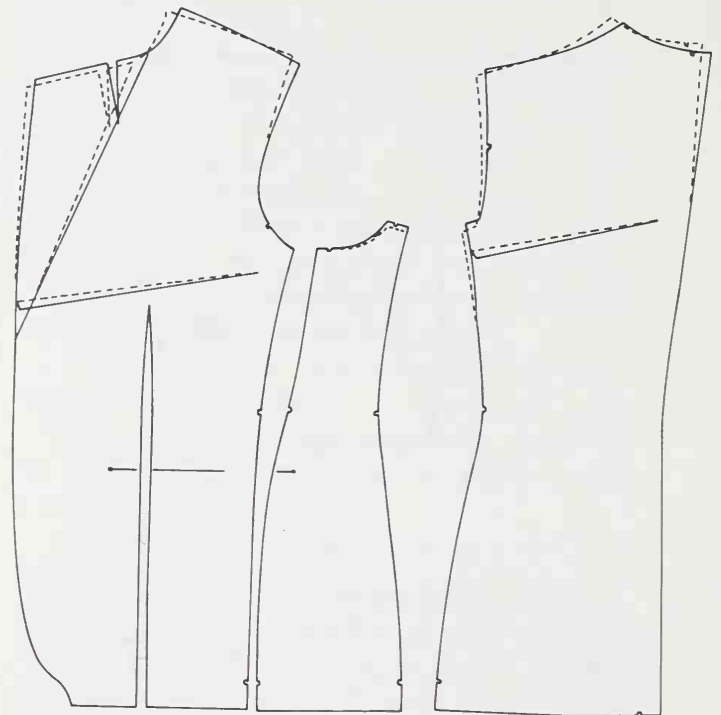

OVERLY ERECT POSTURE

A jacket on a woman with overly erect posture will pull towards the *front* and *upwards*. To prevent the jacket from pulling, slash the pattern, beginning on the back side seam, about $1\frac{1}{2}$ " (3.8 cm) below the armhole. The slash continues across the back of the pattern to about 2" (5.1 cm) from the center back seam. The pattern is spread apart at the side seam $\frac{1}{2}$ " (1.3 cm) to $\frac{3}{4}$ " (1.9 cm).

A slash is cut into the pattern front from the lapel edge to about 2" (5.1 cm) from the side seam. The pattern is spread apart at the slash $\frac{1}{2}$ " (1.3 cm) to $\frac{3}{4}$ " (1.9 cm).

The top of the side panel is raised so that the side panel back seam from waist notch to armhole is equal in length with the newly adjusted side seam on the jacket back pattern.

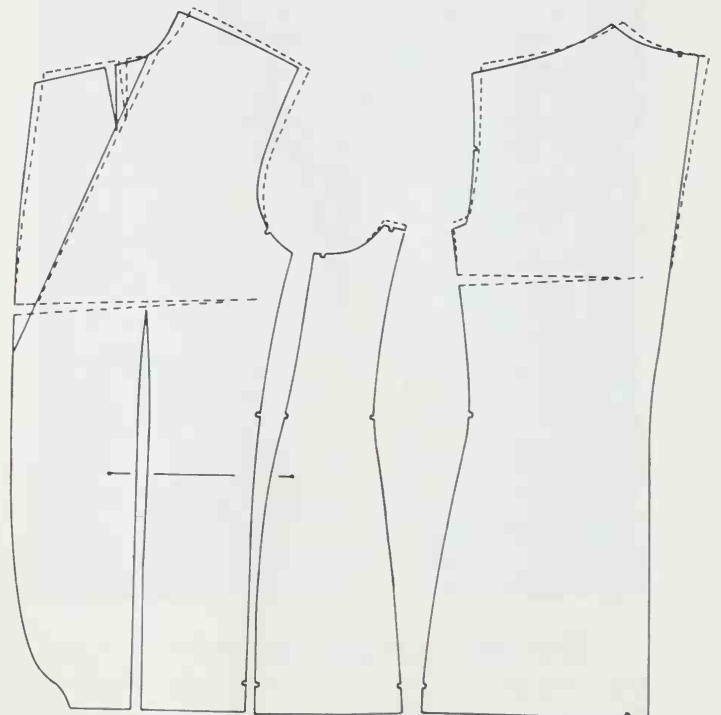

LOW SHOULDER

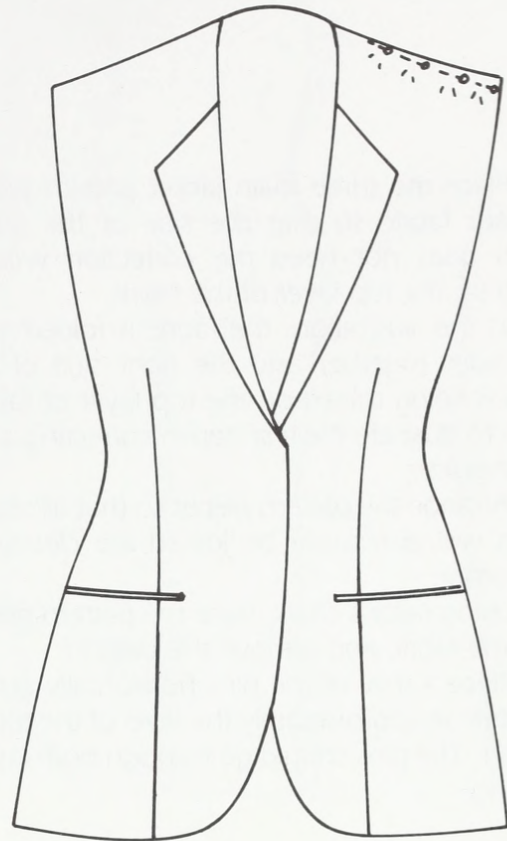

Many people have one shoulder lower than the other, usually as a result of their work, or some other regular activity which places the body in an unbalanced position. A clear indication of this peculiarity of the body is visible in the sagging diagonal creases along one side of the jacket only.

Pin the fabric up at the shoulder (as illustrated) until the creases disappear, and measure the amount of the needed adjustment.

It would appear that the logical pattern correction would be a deeper, slanting seam at the shoulder. Doing this would make the arm-

hole smaller, which, in turn, would necessitate making the sleeve smaller.

The fact is that the correction has *nothing* to do with the armhole. It has to do with the *rib cage area*. The shoulder is low because the body is contracting itself somewhere between the armhole and the waist, on one side. The adjustment required is somewhat complicated—however, it works. The adjustment requires either a new muslin, or your confidence in being able to make the correction directly on the garment fabric. You decide.

Place the three main jacket pattern pieces on your fabric so that the side of the jacket which does not need the correction will be traced on the top layer of the fabric.

In the illustration, the fabric is folded with right sides together and the right side of the jacket is being traced on the top layer of fabric. This is to illustrate the first step in correcting a *left low shoulder*.

Arrange the pattern pieces so that all seams which will eventually be joined are closest to each other.

Using tailor's chalk, trace the pattern pieces onto the fabric and remove the pattern.

Place a row of the pins horizontally across the fabric at approximately the level of the top of the dart. The pins should go through both layers of fabric.

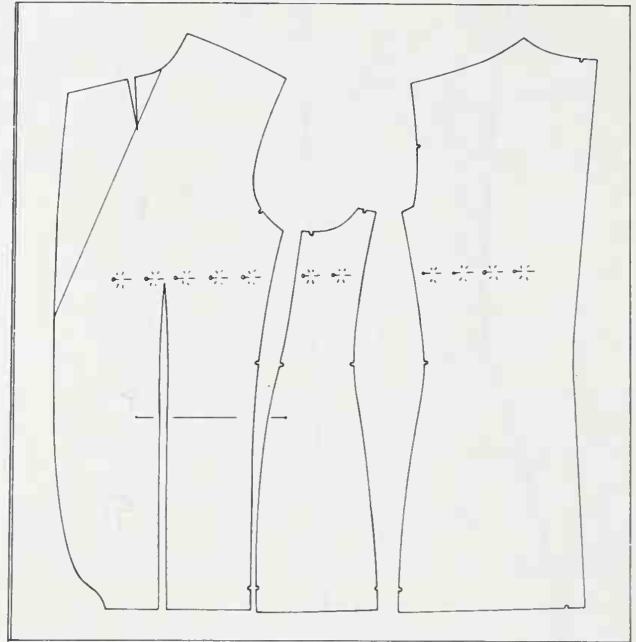

Cut through only the top layer of fabric (as illustrated) about $\frac{1}{2}$ " (1.3 cm) away from the cutting edge of the armhole and the side panel. The fabric layers are still anchored together by the row of pins.

Now, at the top of the lapel, move the top layer of fabric in $\frac{1}{4}$ " (6 mm). At the shoulder of the jacket front, move the top layer of fabric down an amount equal to one half the needed correction.

With one hand, hold the top layer of fabric flat, in its new position. With the other hand, smooth the fabric downward toward the pins, and outward towards the side seam. An excess of fabric will appear just above the row of pins.

A second row of pins is now placed through both layers of fabric, confining the ripple of fabric to this area. The two rows of pins should be about 1" (2.5 cm) apart at the side panel.

With the fabric pinned in this manner, cut through both layers of the jacket front and side panel. Be attentive as you cut the rippled area. Follow the chalk guideline.

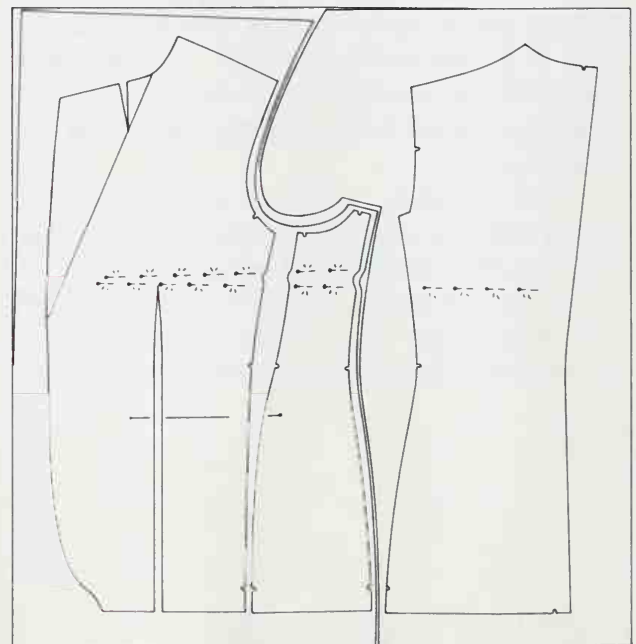

When both layers of the front and side panel are placed together on the table it will be obvious that the underlayer is shorter between the underarm and waist, yet both armholes are equal.

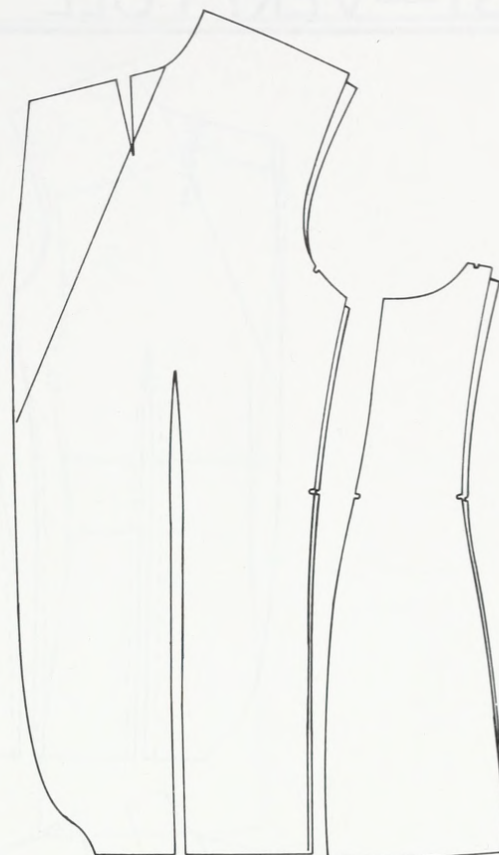

The back of the jacket is adjusted in the same manner. The top layer of fabric is moved in $\frac{1}{4}$ " (6 mm) at the center back neck, and down at the shoulder an amount equal to one half the needed correction. The fabric is smoothed downward and outward towards the side. The excess of fabric which appears above the pins is pinned in place, and both layers of the jacket back are cut together.

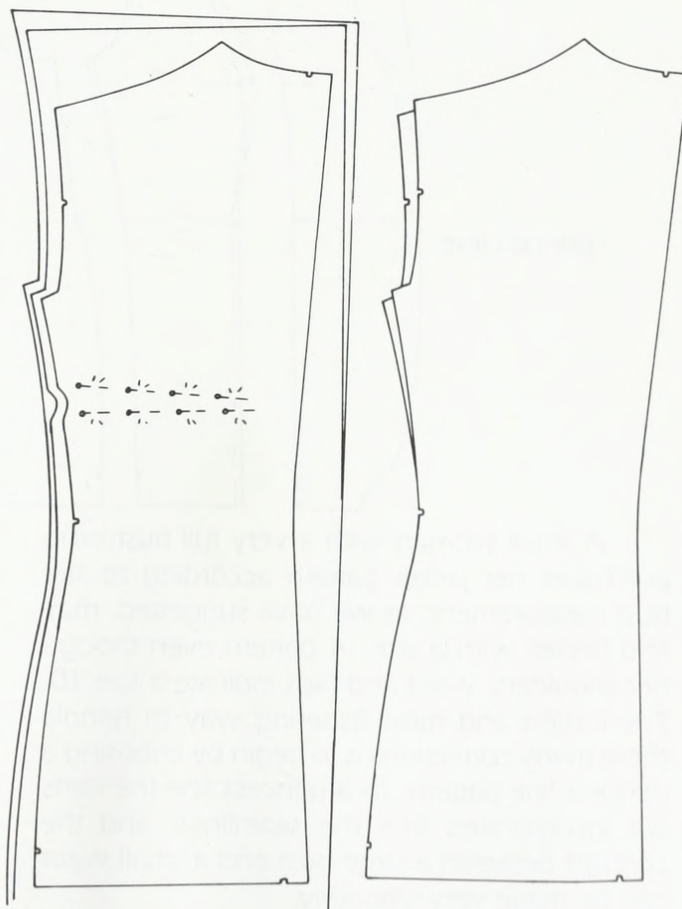

BUST—VERY FULL

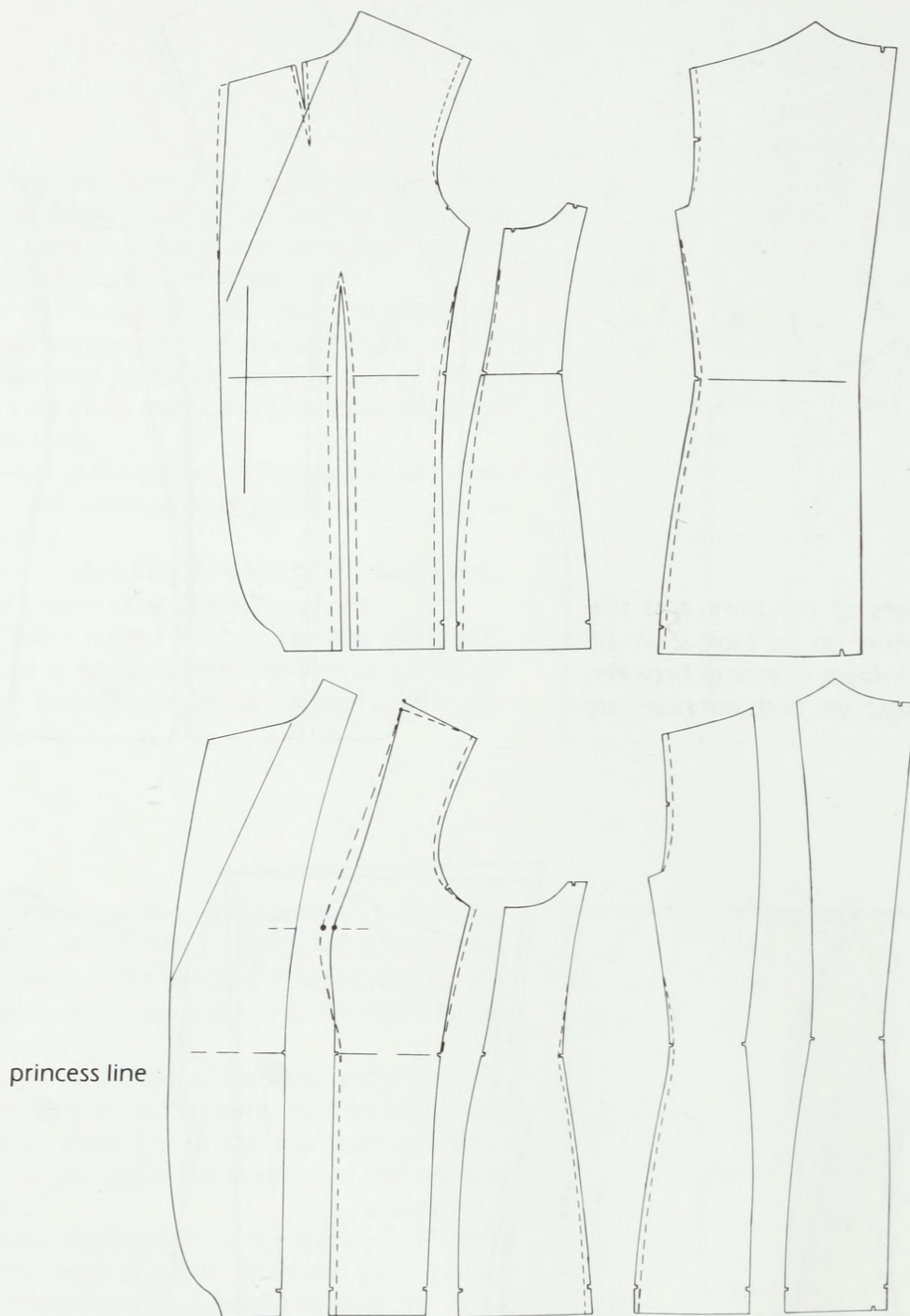

A small woman with a very full bust who purchases her jacket pattern according to her bust measurement, as we have suggested, may find herself with a size 14 pattern even though her shoulders, waist and hips indicate a size 10. The easiest and most flattering way to handle these many corrections is to begin by choosing a princess line pattern. In a princess line the darts are incorporated into the seamlines, and the contrast between a large bust and a small waist can be made very smoothly.

If you choose a classic line jacket, taper the pattern below the bust using the front dart, the side panel, and the side back. Reduce the shoulder seams equally on front and back. In order to maintain the jacket balance and prevent the lapel from gaping open, the lapel dart is increased by $\frac{1}{2}$ " (1.3 cm) and the same amount is then added at the top of the outer edge of the lapel. The pattern is lengthened or shortened as needed, using the pattern guidelines.

BUST—VERY FLAT



The bust measurement is usually the best guide for choosing the size of your jacket pattern. If, however, you are an average- to large-sized woman, with a flat bust, we suggest that you purchase your jacket pattern using your waist and hip measurements as a guide.

Any excess fabric in the chest area should be tapered out of the armhole, the front underarm seam, and the jacket back.

MISPLACED FRONT DART

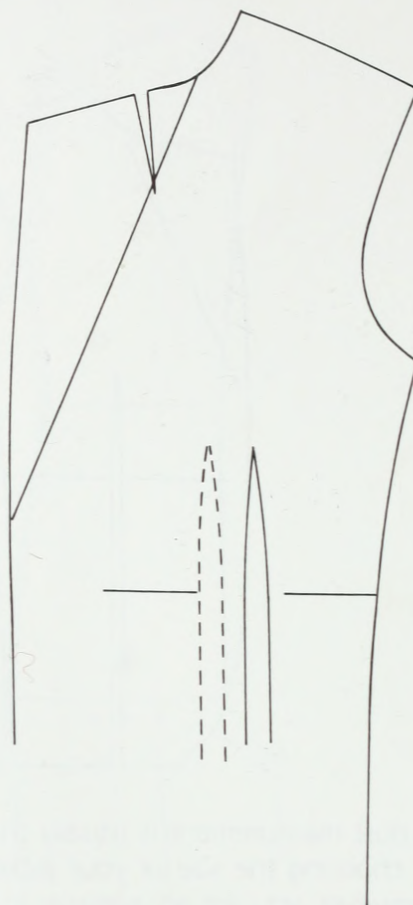
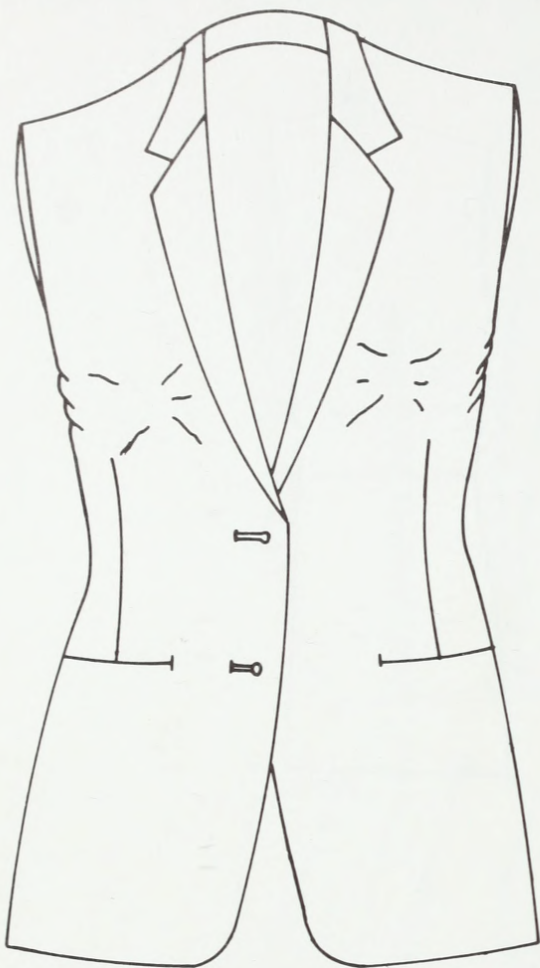

If the dart on the jacket front is not directly in line with the center of the breast, the dart is misplaced, and must be moved. A fullness of fabric is released at the end of the dart. If this fullness is directed to a point other than the center of the breast, there will be a restriction of fabric across the breast, and most likely, an unfilled bulge of fabric off to the side.

The correction is a simple one. Using a hip curve ruler, redraw the existing dart on your pattern at the correct position.

FRONT DART—TOO LONG/TOO SHORT

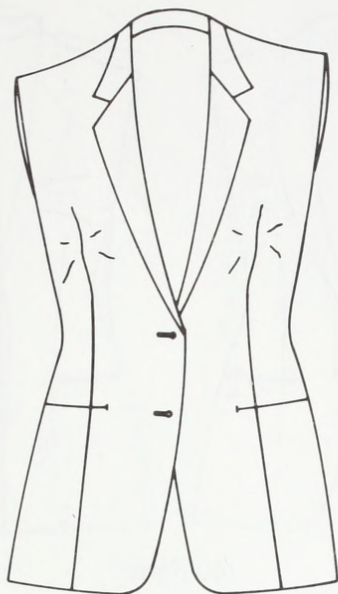

too long

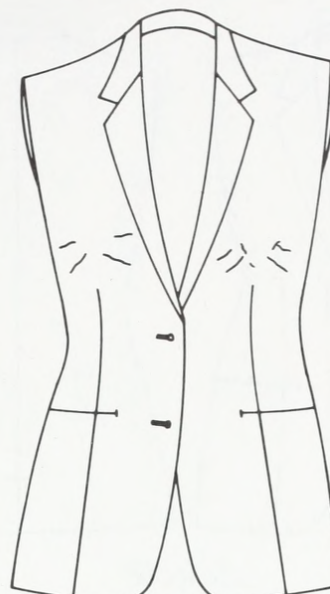

too short

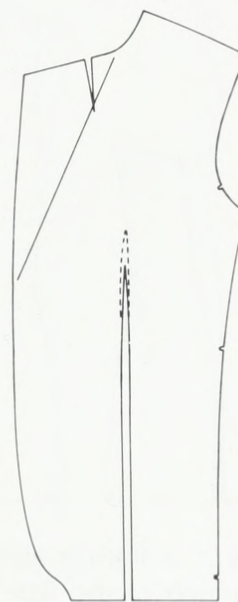
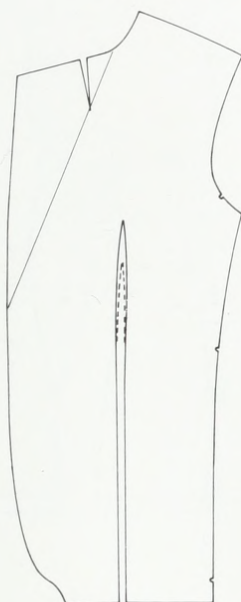

The job of the front dart is to help create the necessary shaping by restricting the fabric where the body is narrow, and releasing the fabric where the body is fullest. The front dart should, therefore, end about 1" (2.5 cm) below the center of the breast.

If the dart continues beyond the center of the breast, there will be noticeable pulling in the fabric. If the dart stops well below the center of the breast, there will be unnecessary fullness in an area lower than it is needed.

Simply draw the top of your dart lower or higher on your pattern, as needed, and with the help of a hip curve ruler, taper the sides of the dart to the waistline.

TOO LOOSE/TOO TIGHT ABOVE WAIST

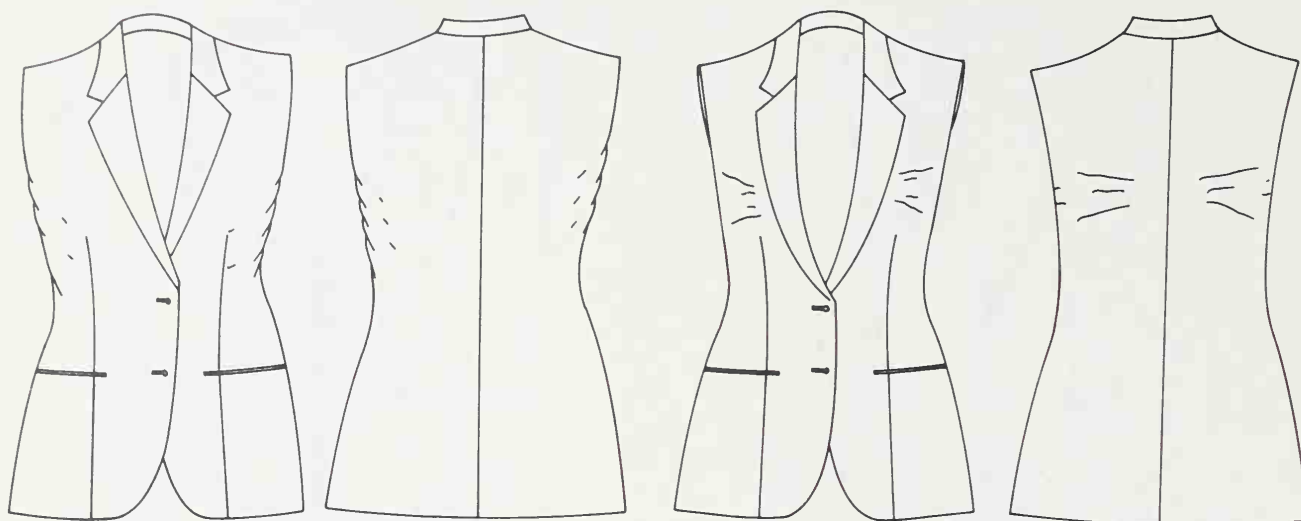

too loose

too tight

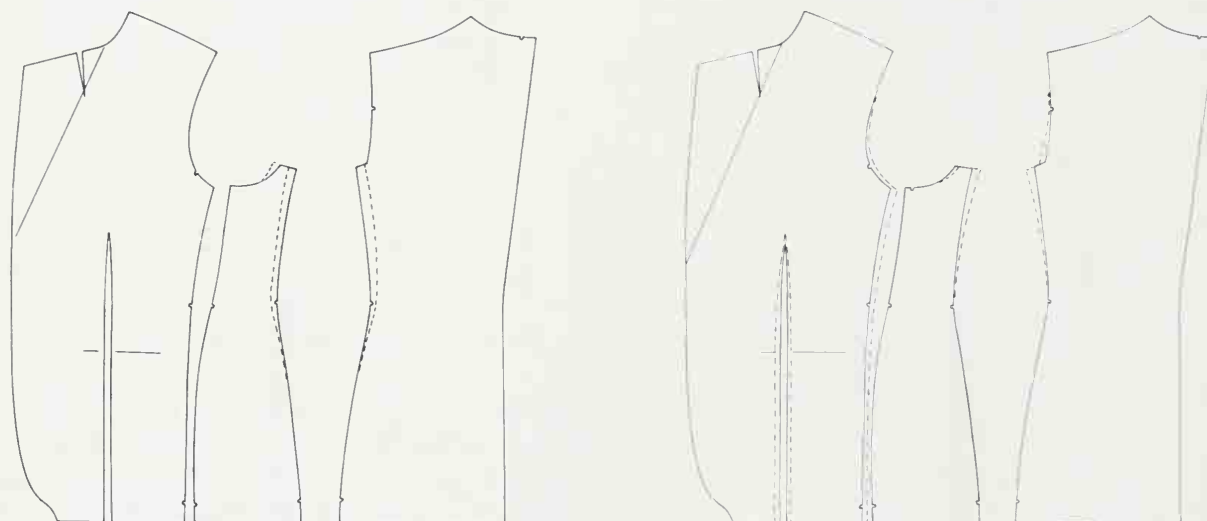

If the jacket is wrinkling above the waist because of too much or too little fabric, determine the amount of the correction by pinning (too much fabric), or by opening the side seams (too little fabric).

On the pattern, add or subtract the corrected amount not only from the underarm to the hip, but also at the armhole.

The horizontal line at the top of the side seams, back and front, is equal to the side seam allowance. When your pattern correction is complete, that horizontal line must measure the same as it did before you began to correct the pattern. Therefore, whatever amount is added or subtracted from the side seam must inversely be subtracted or added at the armhole. Failure to do this will result in a gap at the back of the armhole which will destroy the armhole contour.

TOO LOOSE/TOO TIGHT BELOW WAIST



too loose



too tight

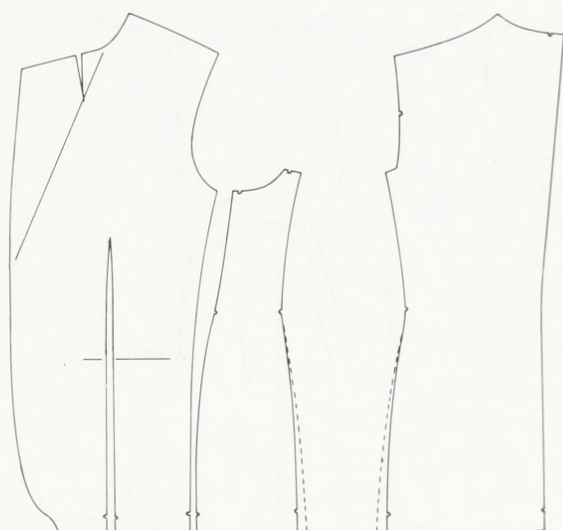
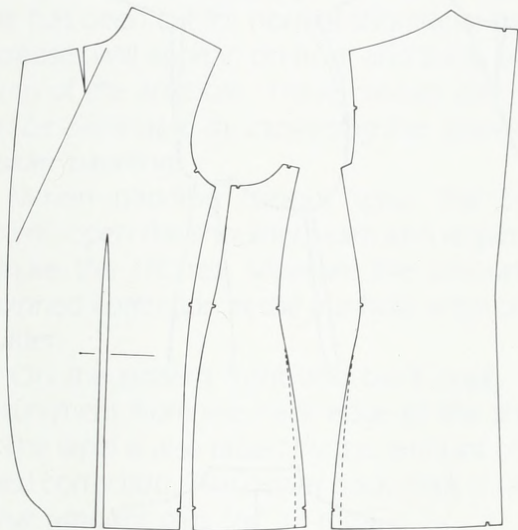

There should be no wrinkling on the jacket below the waist, on front or back, and the vent should lie closed, without pulling to one side or to the other.

On the pattern, add or subtract the corrected amount at the bottom of the side seam, and taper gradually to the waist.

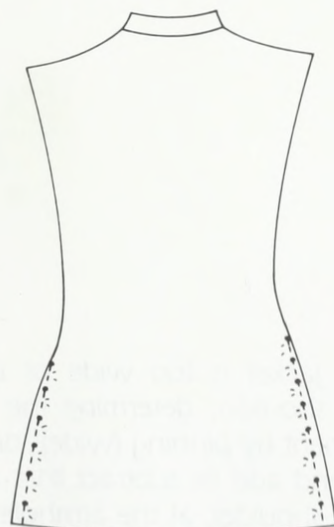

SHOULDER—TOO WIDE/TOO NARROW

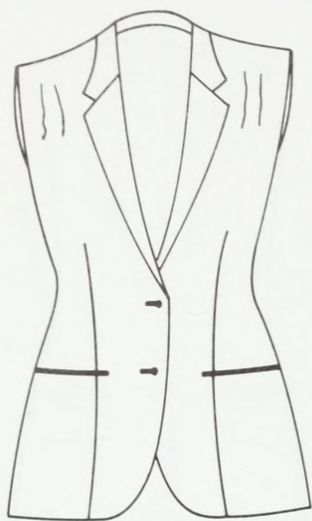

too wide

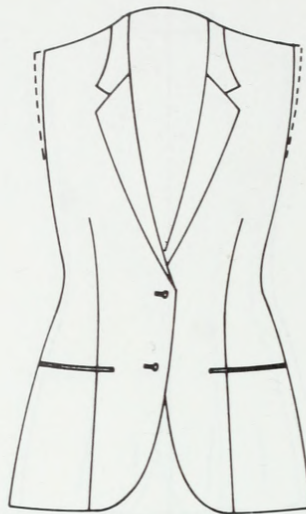
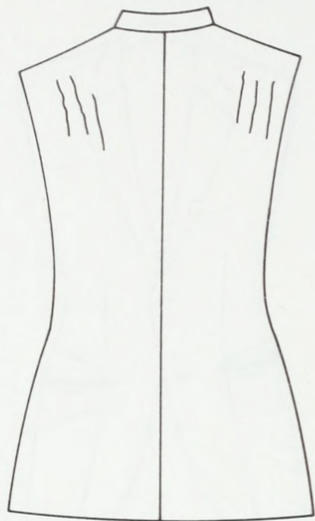

too narrow

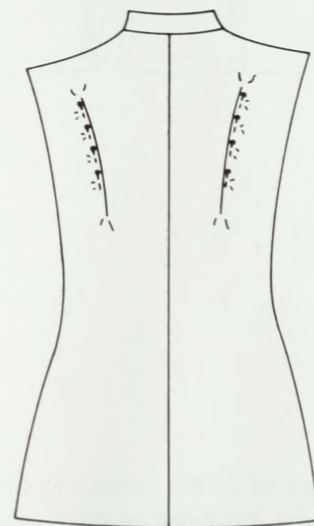
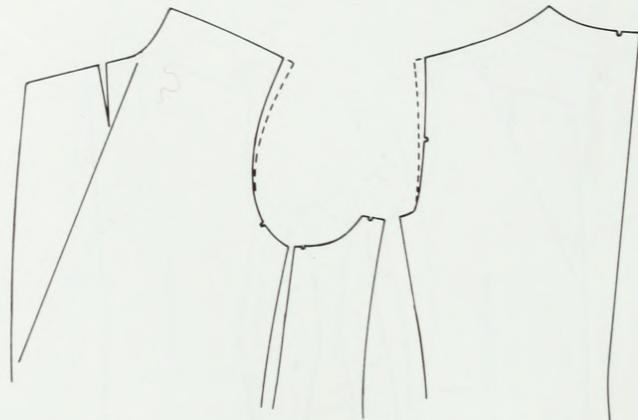
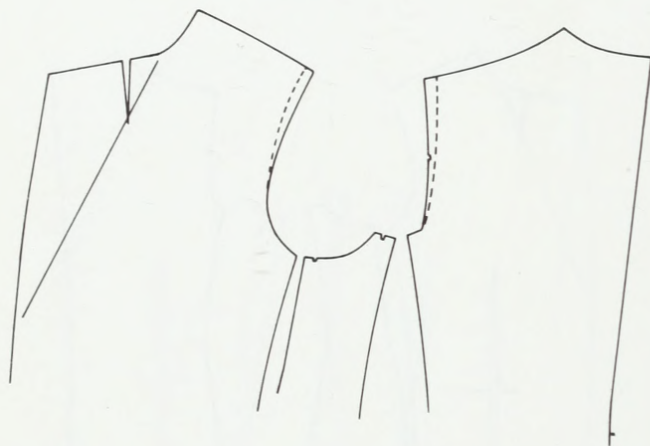
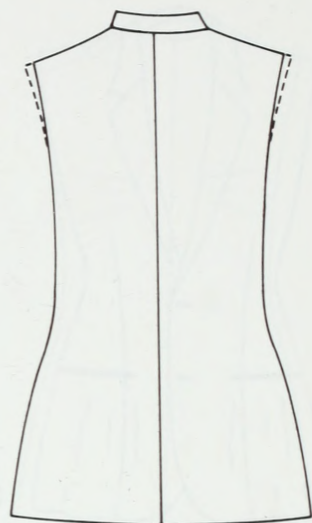

If the jacket is too wide or too narrow across the shoulder, determine the amount of the adjustment by pinning (wide), or measuring (narrow), and add or subtract that amount on the pattern shoulder, at the armhole.

SLOPED SHOULDER



If your client has sloped shoulders, and the jacket has been cut for normal shoulders, diagonal creases will appear, on front and back, at the bottom of the armhole. *These creases can most often be eliminated by increasing the amount of shoulder padding.*

When padding cannot solve the entire problem, open the shoulder seam and re-pin it to eliminate the creases. Measure the amount of the pinned correction at the armhole edge of the shoulder.

On the pattern front and back apply that measurement from the neck edge of the shoulder. The lapel is also raised by the amount of the pinned correction. The center back neck is raised by that amount plus $\frac{1}{8}$ " (3 mm).

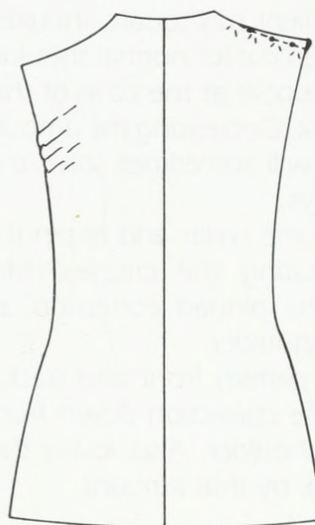

SQUARE SHOULDER

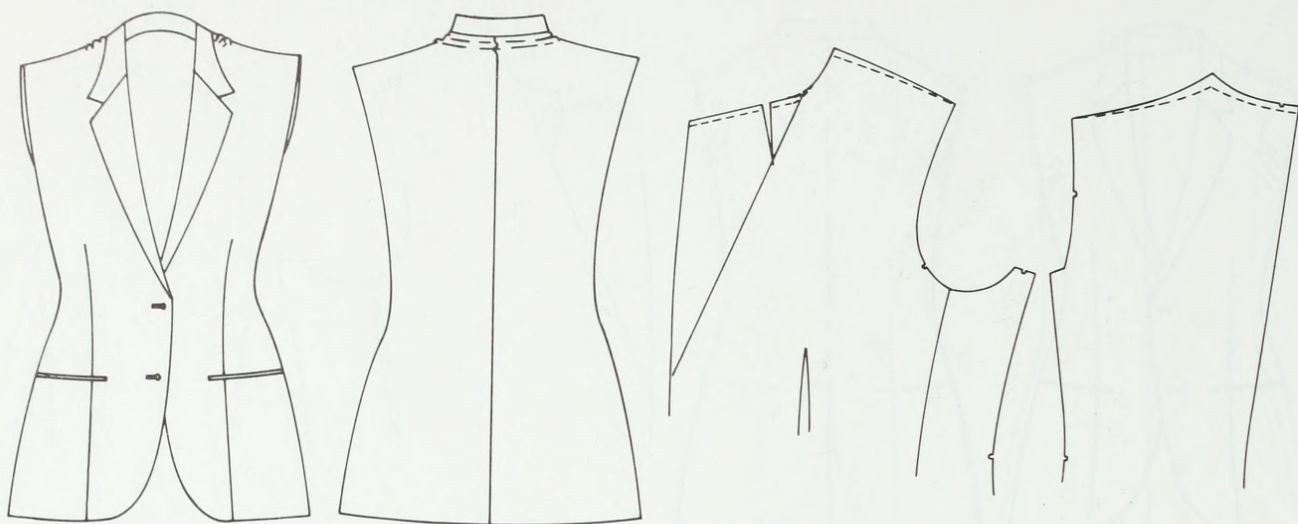

If your client has square shoulders and the jacket has been cut for normal shoulders, circular creases will appear at the base of the collar, on front and back. Decreasing the amount of shoulder padding will sometimes solve the problem, but not always.

Remove the collar and re-pin the shoulder seam, eliminating the creases. Measure the amount of the pinned correction at the neck edge of the shoulder.

On the pattern front and back, apply the amount of the correction down from the neck edge of the shoulder. Also, lower the lapel and the back neck by that amount.

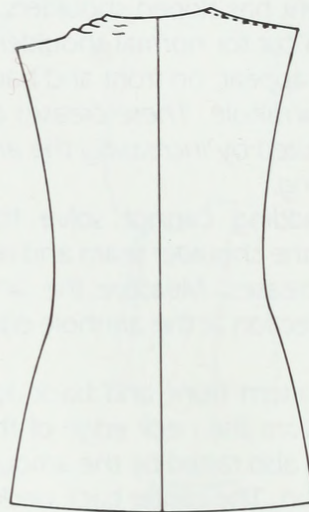

NECKLINE—TOO HIGH/TOO LOW

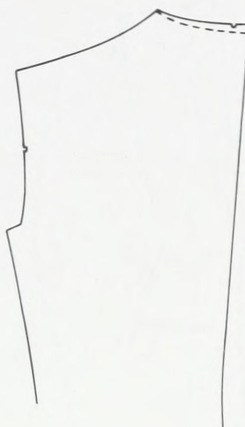
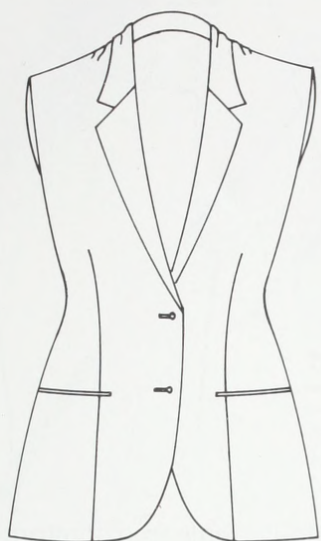

too high

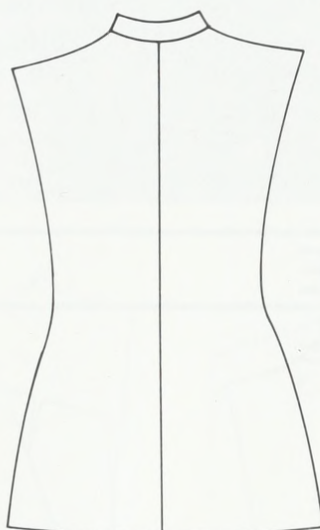
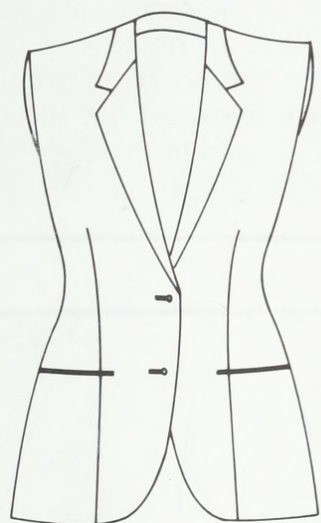

too low

If the bottom of the collar does not sit on the shoulder at the back, but sits above or below shoulder level, the collar must be removed and the back neckline raised or lowered.

Apply the depth of the adjustment to the pattern neckline at center back.

TIGHT NECKLINE

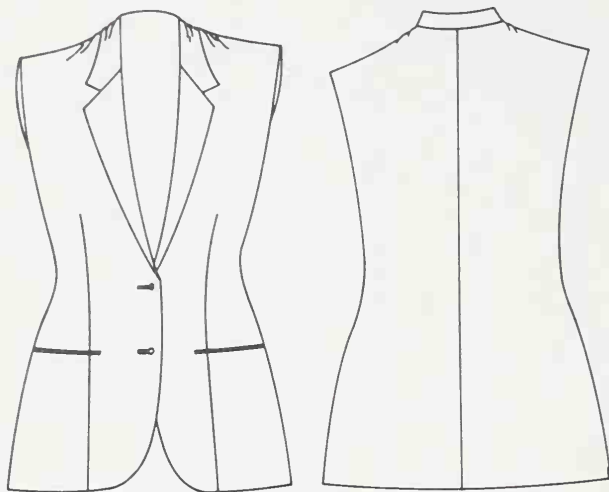

If the jacket neckline is too tight, the armhole seam at the shoulder will show signs of pulling towards the neck. There will be creases on the front shoulder, reaching out from the neck towards the armhole.

The collar will be a bit high if the neckline is too tight, but the height of the collar will be less obvious than the pulling of the fabric in the shoulder and neckline area. Once the neckline is

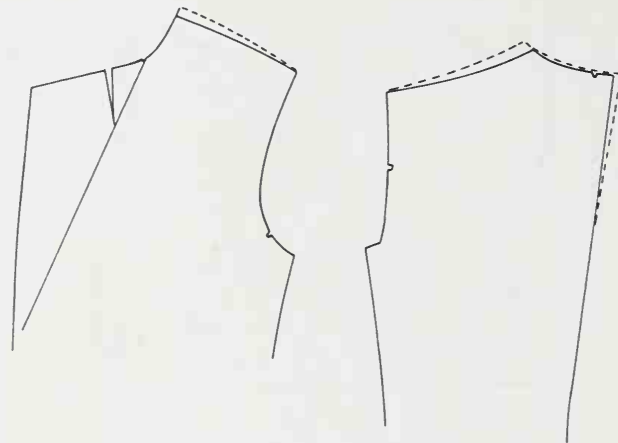

released, the collar should settle to a comfortable height.

Remove the collar. Open the muslin shoulder seam and the top of the center back seam, and let the jacket settle at the neckline.

The adjustment should be distributed equally at the neckline between the shoulder seam and the center back seam.

LOOSE NECKLINE



If the jacket neckline is too loose, the jacket will pull away from the body at the back neck; and in the front, the lapel will gape open uncomfortably.

Remove the collar, and pin a tuck in the center back seam until the neckline hugs the body more closely.

Apply the depth of the adjustment at the neck edge of the center back seam.

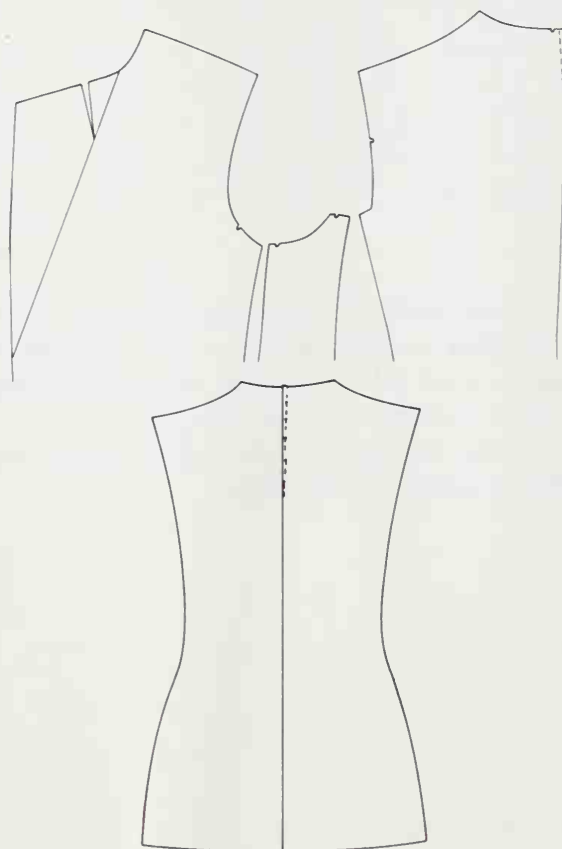

ARMHOLE—TOO HIGH/TOO LOW

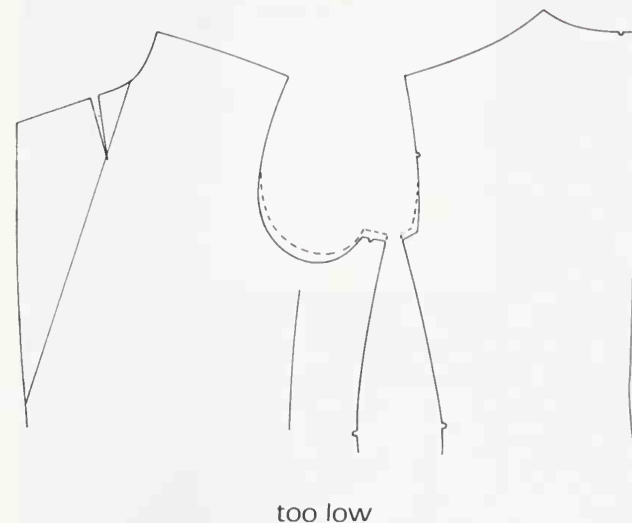
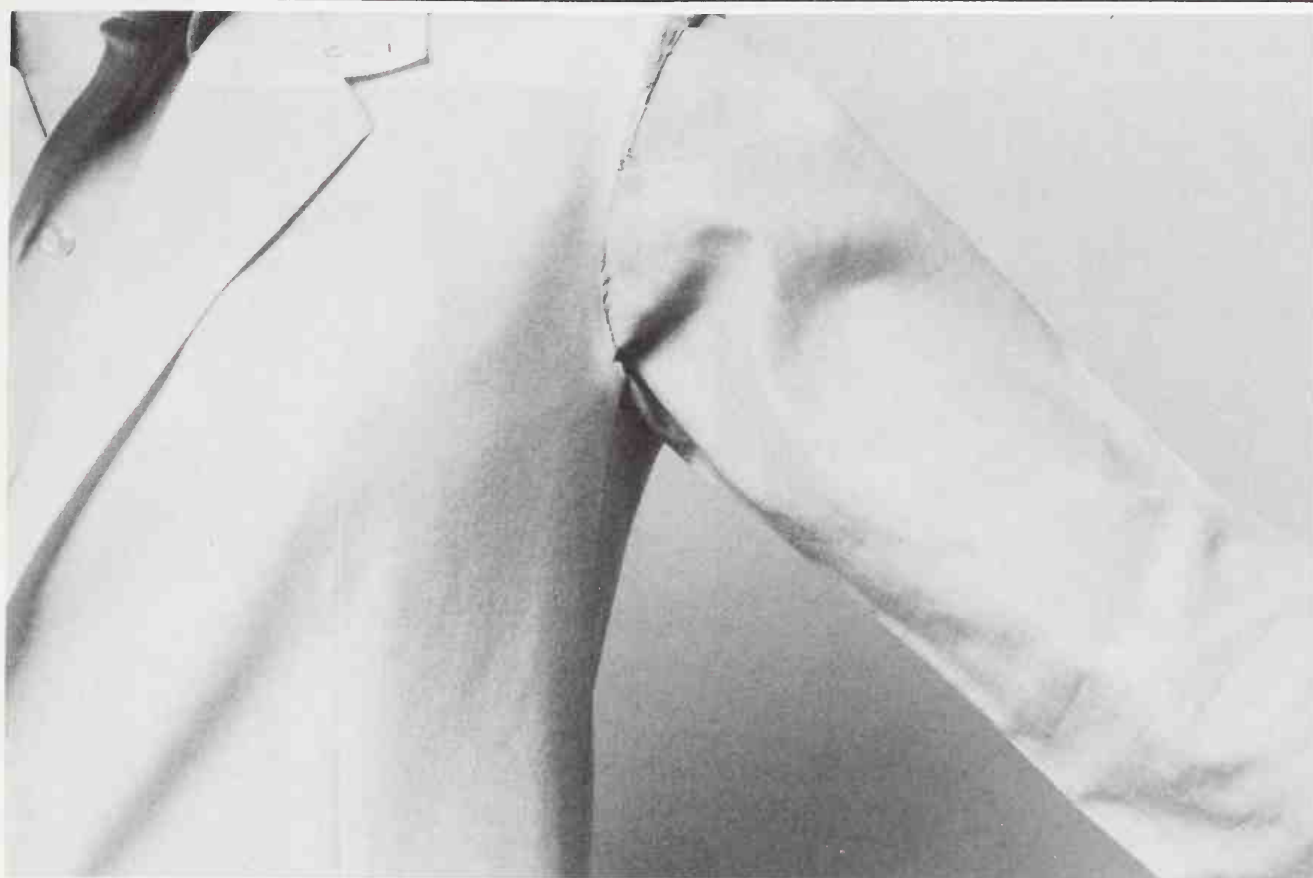

Contrary to popular belief, the most comfortable armhole for a sleeve is one which is cut as high as possible without restricting the forward movement of the arm. A low-cut armhole is only comfortable if a sleeve is not attached. With a sleeve set into a low-cut armhole, raising one's arm involves raising the entire side of the jacket.

The cutting edge of the fabric should be about 1" (2.5 cm) below the center underarm.

Raise or lower the pattern the depth of the adjustment at mid-underarm, and at the top of the side seam, back and front. This adjustment at the top of the side seams is necessary to maintain the contour of the armhole.

The armhole should also be "scooped" slightly in the front notch area, if wrinkles develop when the arm is resting at the side. Trim the fabric, a little at a time, until the wrinkles disappear.

THE SKIRT

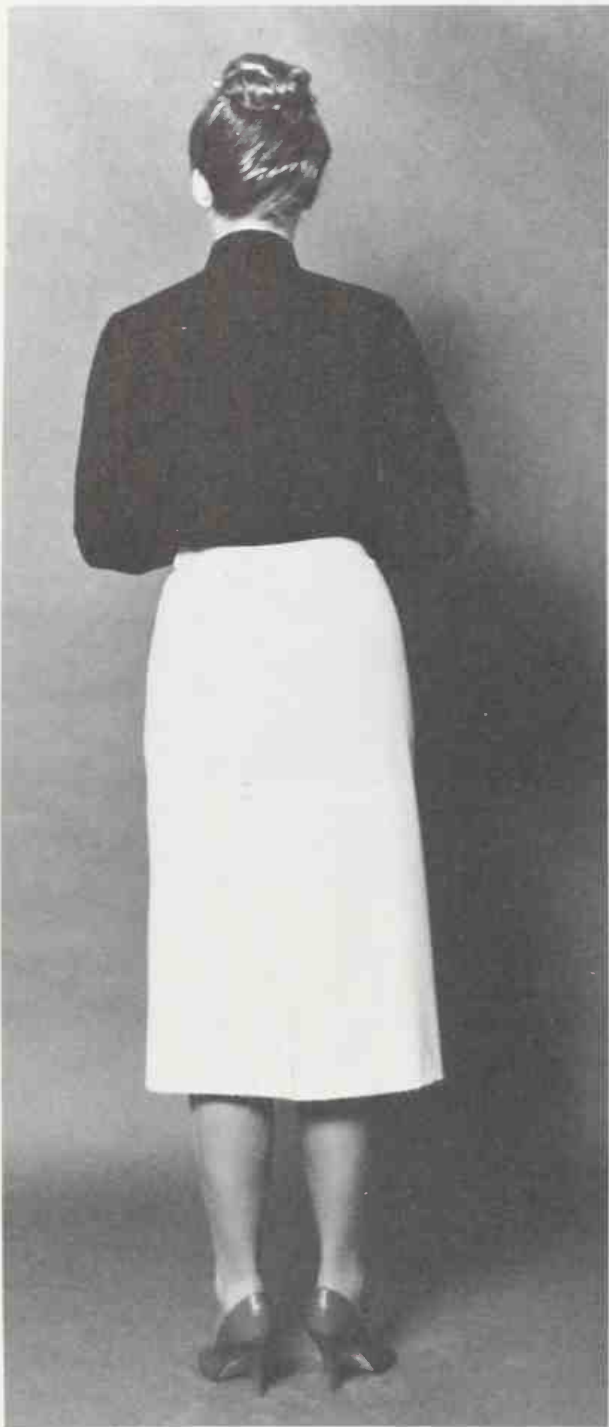

The beauty of the straight skirt is especially dependent on a graceful fit. The fabric should lie smoothly at the waistline, and fall gracefully over the hips. The side seams must hang perpendicular to the floor, despite demands made by a high hip, or a protruding rear.

TOO TIGHT/TOO LOOSE ACROSS HIPS



too tight

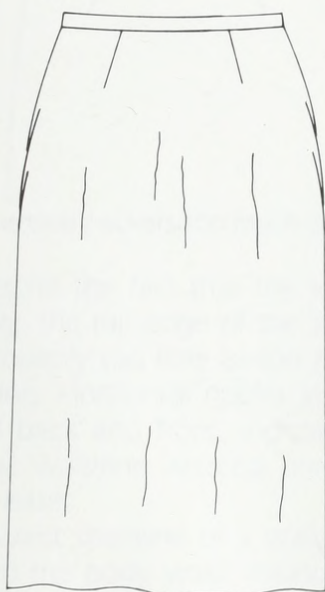
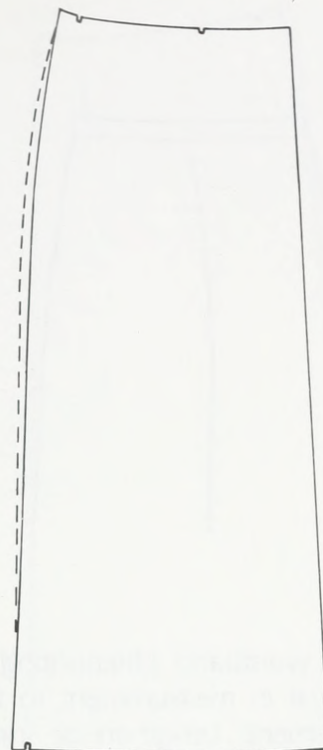

too loose

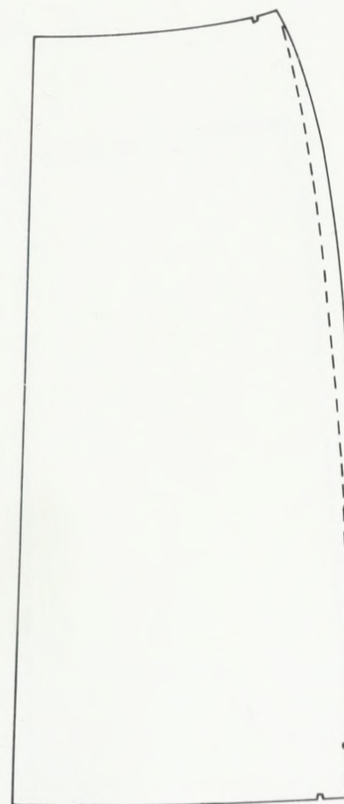

If the skirt is too tight or too loose across the hips the necessary addition or subtraction is made at the pattern side seams, hip level, front and back. A hip curve ruler is used to draw a new side seam line, tapered gracefully from the hip to the waist, and from the hip to the bottom of the skirt.

WAISTBAND—TOO LOOSE/TOO TIGHT

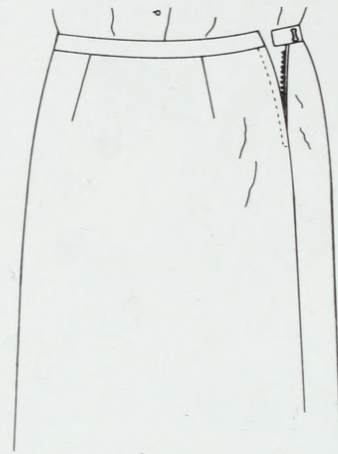

The skirt waistband (discounting overlap) should be equal in measurement to the body waist measurement. Lengthen or shorten the waistband as indicated.

WAISTLINE—TOO LITTLE/TOO MUCH EASE

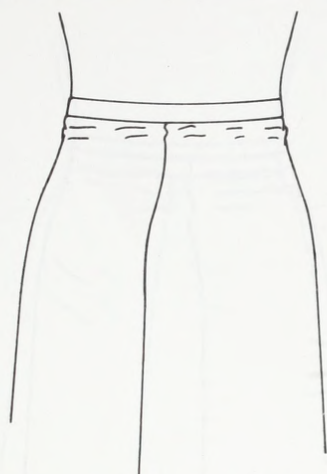

horizontal ripples/too little ease

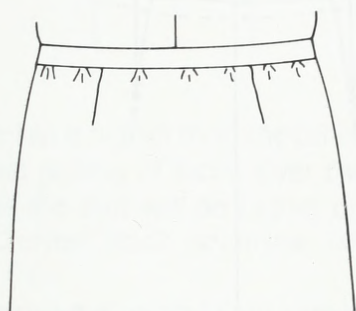
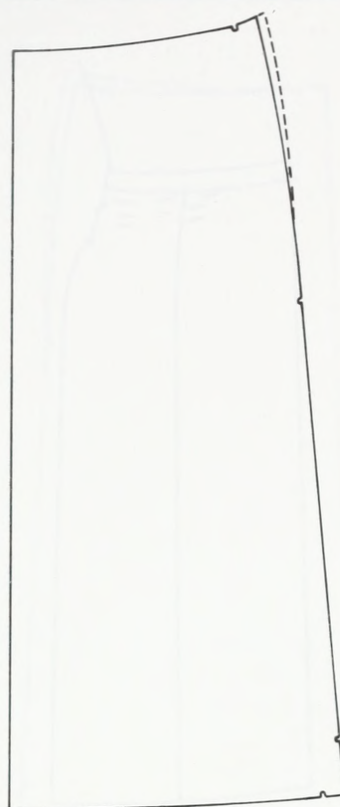

vertical puckers/too much ease

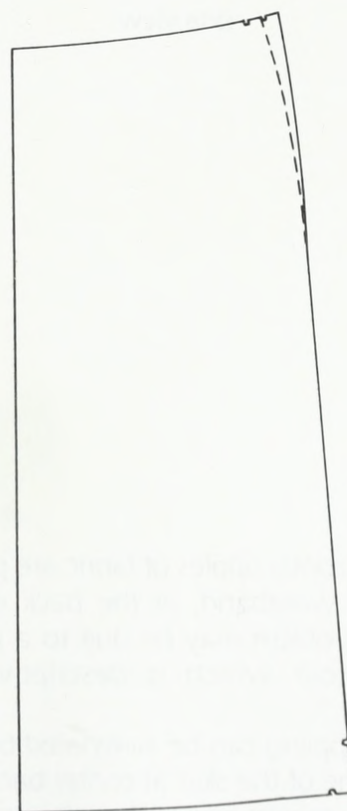

If, despite the fact that the waistband fits comfortably, the top edge of the skirt does not, there is probably too little or too much ease at the waistline. Horizontal ripples just below the waistband back and front, indicate insufficient ease at the waistline. Vertical puckers indicate too much ease.

The waist seamline of a straight skirt must be equal to the body waist measurement, plus approximately $\frac{1}{2}$ " (1.3 cm) ease at the front and $\frac{1}{2}$ " (1.3 cm) ease at the back. This total of 1" (2.5 cm) excess fabric at the top edge of the skirt, is "eased" into the slightly smaller waistband to allow for the fact that directly below the waist the body (and therefore, the skirt) begins to expand.

Adjust your pattern by adding or subtracting the necessary amount at the waistline side seams, back and front. The new point is then tapered gracefully to the hip.

SWAYBACK

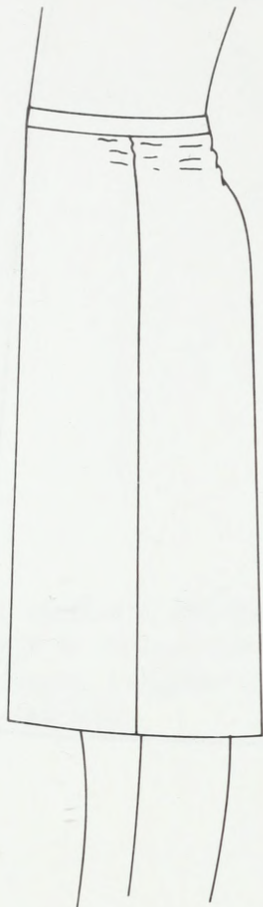

side view

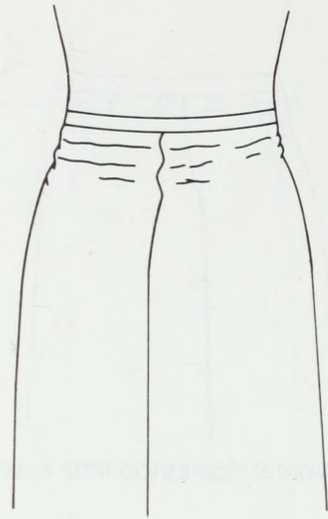

back view

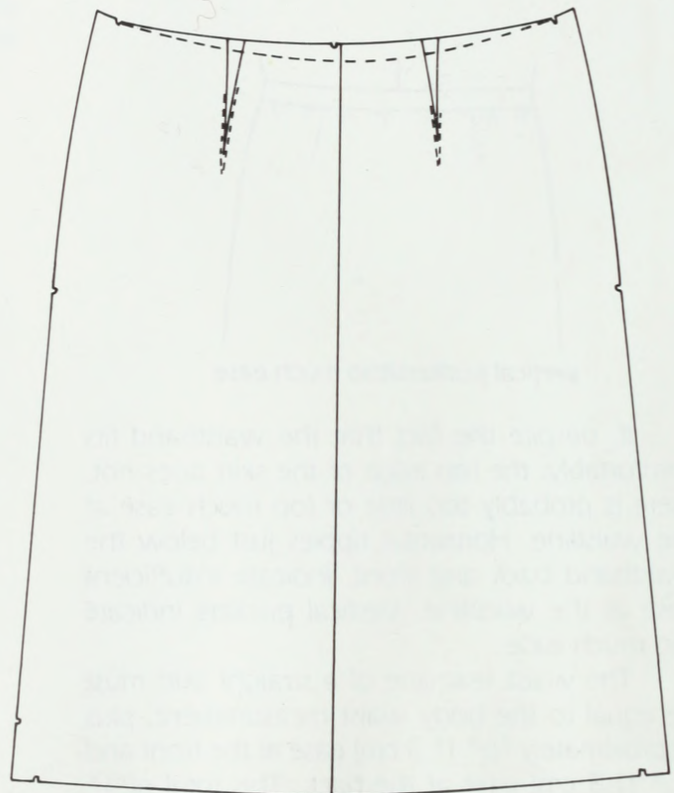

skirt back

If horizontal ripples of fabric are present just below the waistband, at the back of the skirt only, the problem may be due to a posture, or body contour which is descriptively called "swayback."

The rippling can be eliminated by lowering the waistline of the skirt at center back, tapering to the side seams; and by lengthening the back darts slightly.

ONE HIP HIGHER THAN THE OTHER

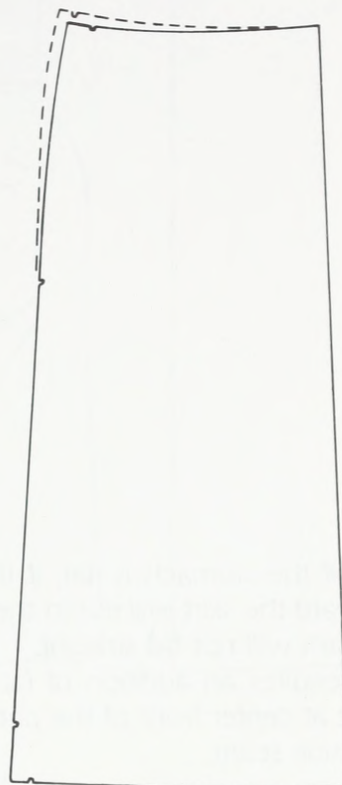
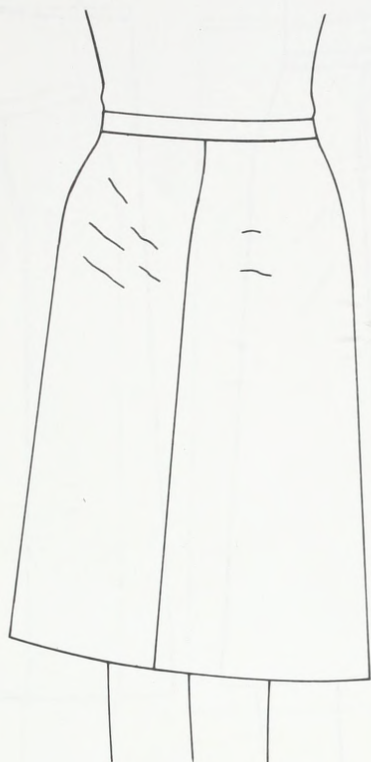

If one hip is higher than the other, there will be diagonal pulling of fabric over the high hip, the hem of the skirt will be higher on that side, and the center back seamline will not fall straight.

To correct this, extra fabric is necessary both in length and in width. Estimate the amount of the correction, and add this amount to the skirt pattern, both up and out from the waistline at the side seam. Only the side of the skirt affected by the high hip is corrected. Use a hip curve ruler to taper these adjustments to the existing pattern lines, as indicated.

HIPS THRUST FORWARD

Even if the stomach is flat, if the hips are thrust forward the skirt will rise in the front, and the side seam will not fall straight.

This requires an addition of fabric and an adjustment at center front of the pattern, tapering to the side seam.



FLAT SEAT

If the client has very flat buttocks, the skirt may hang longer in the back than in the front, and cause the bottom of the side seam to pull forward.

The estimated adjustment is removed from the skirt back at the center of the waistline, and at the hip level side seam.

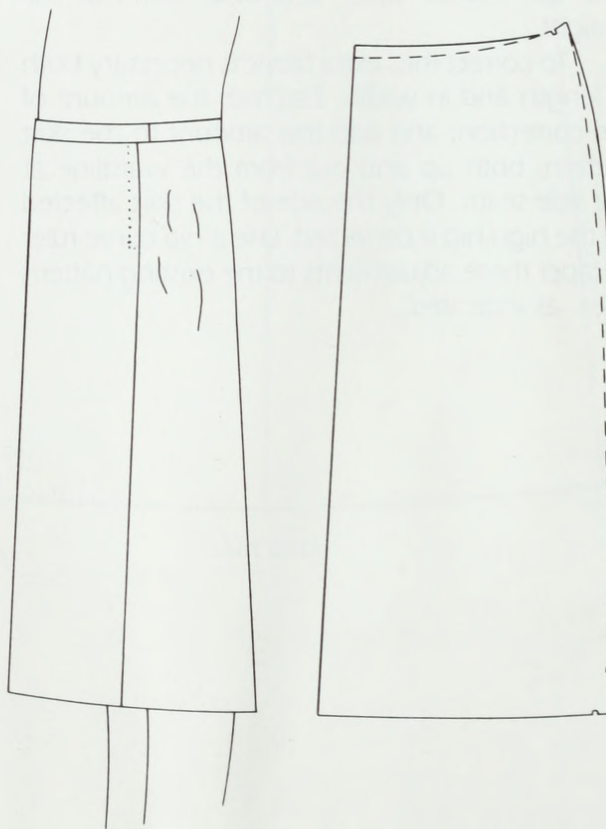

PROTRUDING STOMACH/BUTTOCKS

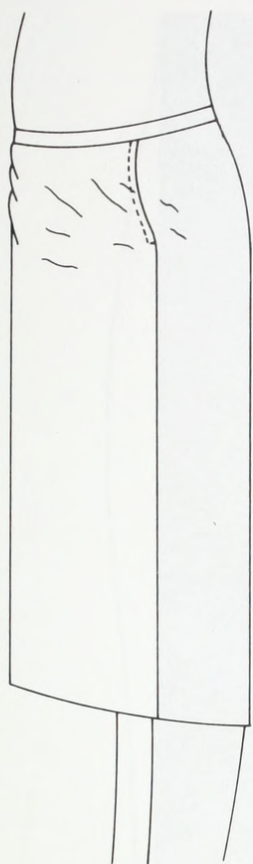

protruding stomach

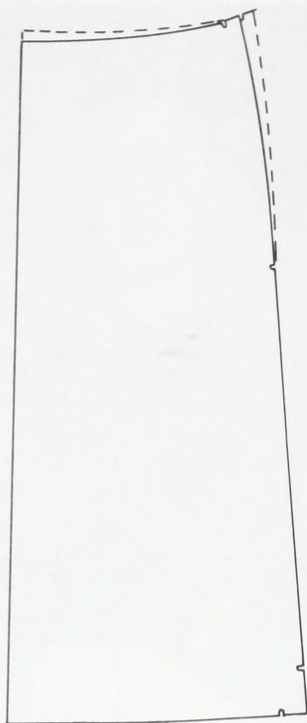

protruding buttocks

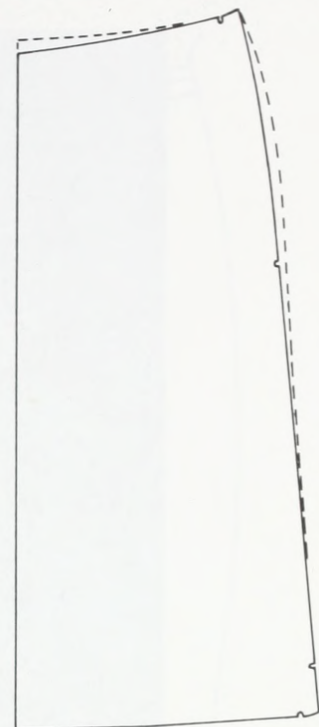

If the stomach or the buttocks protrude significantly, the bulge will draw the skirt up either in the front or in the back, and prevent the side seam from falling straight.

An addition of fabric in both length and in width is necessary to accommodate the bulge.

To correct for the *protruding stomach*, extend your skirt pattern up at center front, and out at the waistline side seam. Correct for *protruding buttocks* by extending your skirt pattern up at center back, and out at the side seam, at the level of the buttocks.

THE PANTS

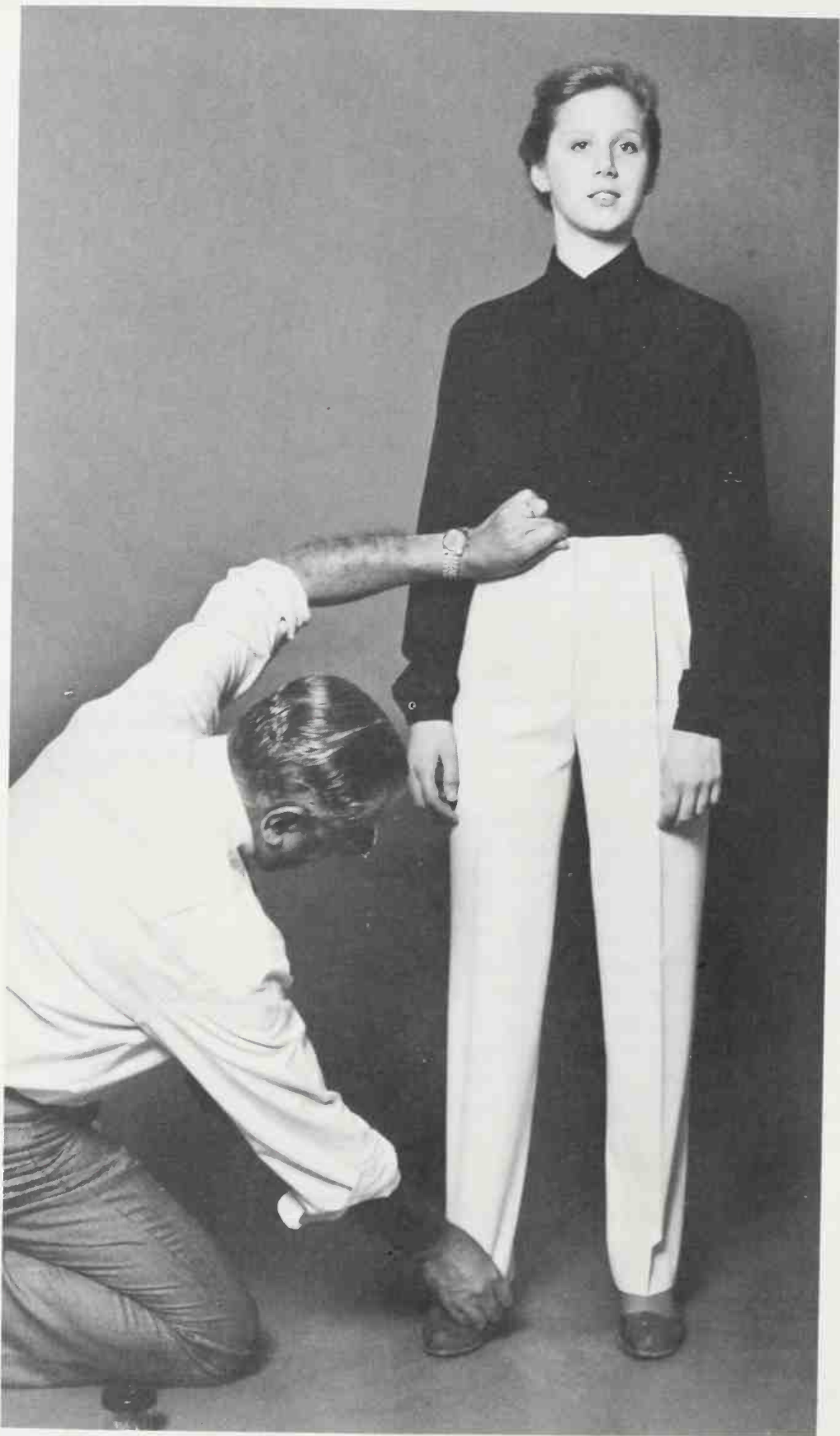

WAISTBAND—TOO LOOSE/TOO TIGHT



The pants waistband (discounting overlap) should be equal in measurement to the body waist measurement. Lengthen or shorten the waistband as indicated.

WAISTLINE—TOO LITTLE/TOO MUCH EASE

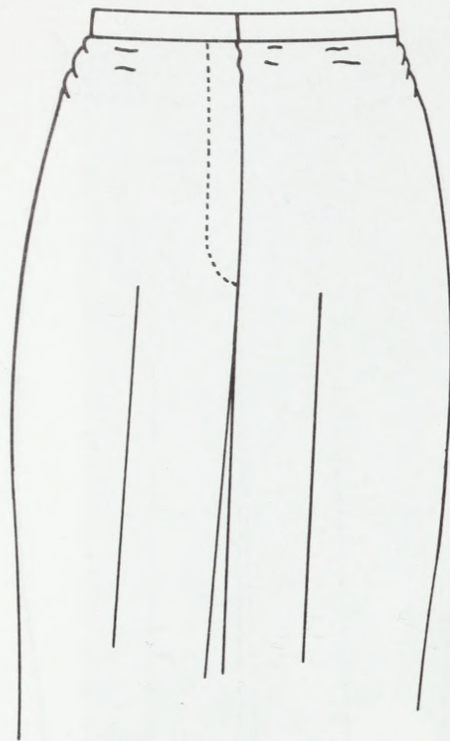

horizontal ripples/too little ease

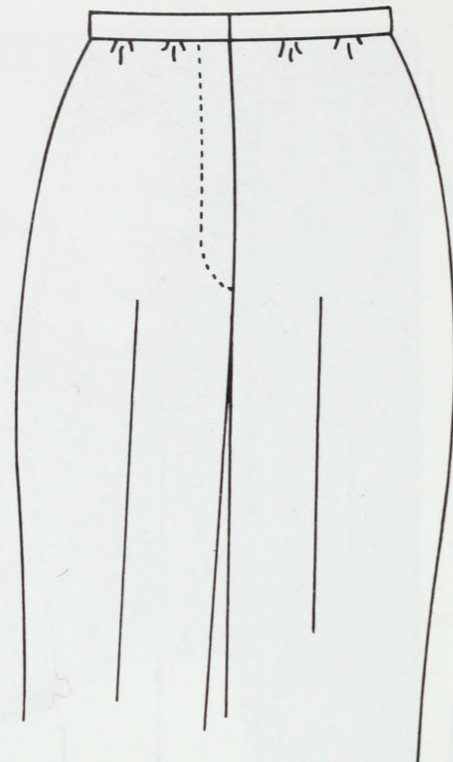

vertical puckers/too much ease

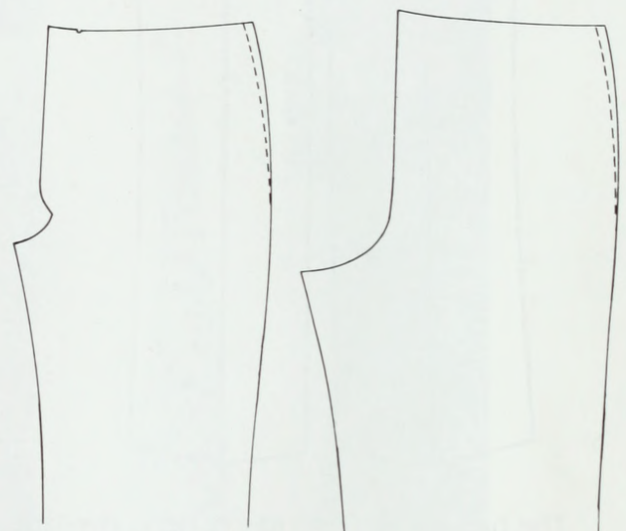
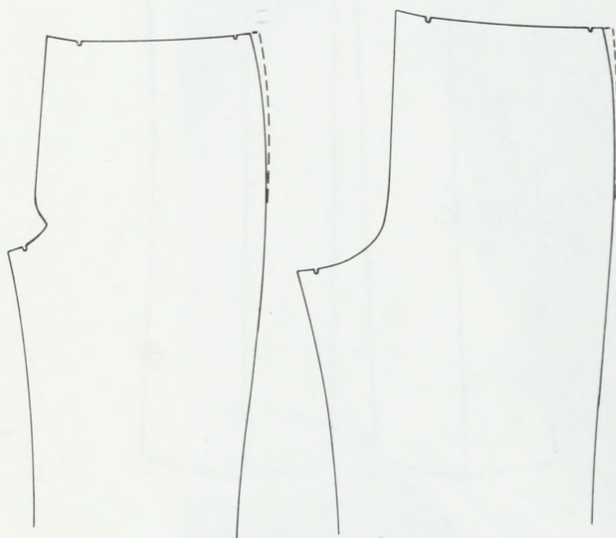

If, despite the fact that the waistband fits comfortably, the top edge of the pants does not, there is probably too little or too much ease at the waistline.

Horizontal ripples just below the waistband back and front, indicate insufficient ease at the waistline. Vertical puckers indicate too much ease.

The waist seamline of unpleated pants must be equal to the body waist measurement, plus approximately $\frac{1}{2}$ " (1.3 cm) ease at the front and

$\frac{1}{2}$ " (1.3 cm) ease at the back. This total of 1" (2.5 cm) excess fabric at the top edge of the pants, is "eased" into the slightly smaller waistband, to allow for the fact that directly below the waist the body (and therefore, the pants) begins to expand.

Pattern adjustments, if minor, are made at the center back waistline. Adjustments of more than $\frac{1}{2}$ " (1.3 cm) must be applied to the waistline side seams, back and front.

TOO TIGHT ACROSS HIPS

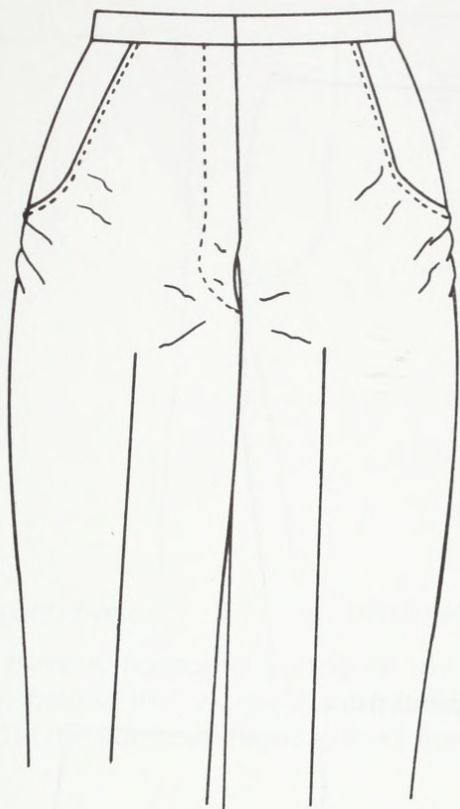

front view

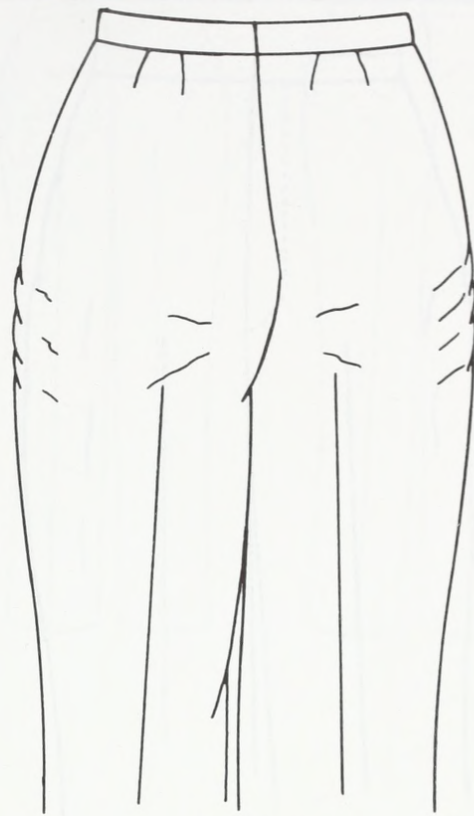

back view

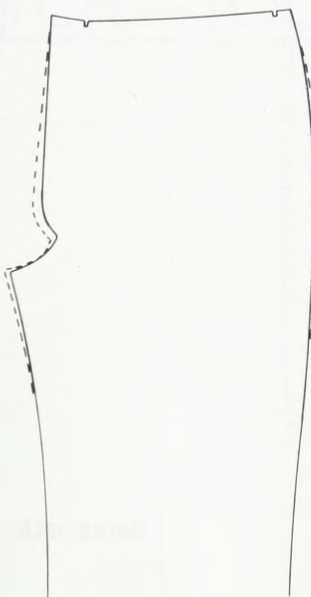

pants front

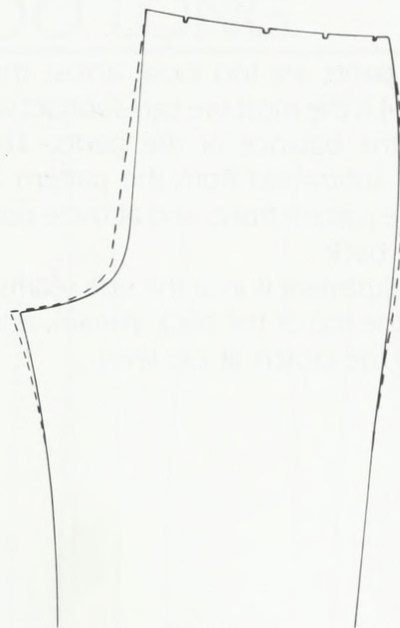

pants back

If the pants are too tight across the hips, $\frac{3}{4}$ " (1.9 cm) is the most we can *add* without disturbing the balance of the pants. The $\frac{3}{4}$ " (1.9 cm) is *added* at three points on the pattern pants front and back.

The adjustment is *out* at the top of the inseam, *out* at the crotch at hip level, and *out* at the side seam at hip level.

TOO LOOSE ACROSS HIPS

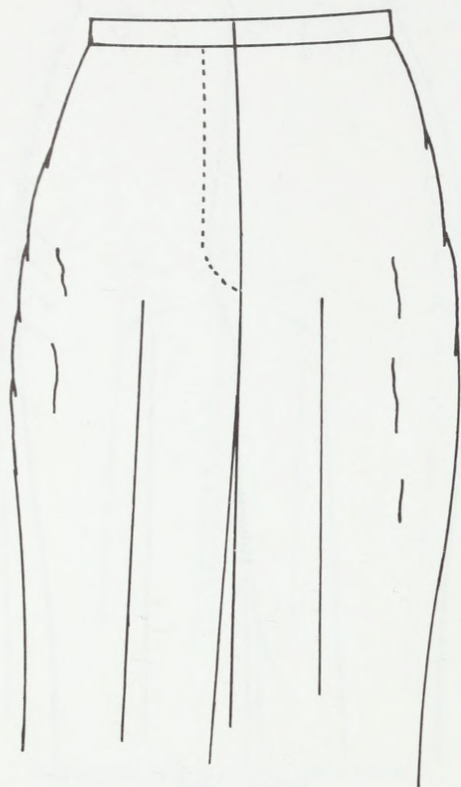

pants front

If the pants are too loose across the hips, $\frac{1}{2}$ " (1.3 cm) is the most we can *subtract* without disturbing the balance of the pants. The $\frac{1}{2}$ " (1.3 cm) is *subtracted* from the pattern at one point on the pattern front, and at three points on the pattern back.

The adjustment is *in* at the side seams at hip level, *in* at the top of the back inseam, and *in* at the back of the crotch at hip level.

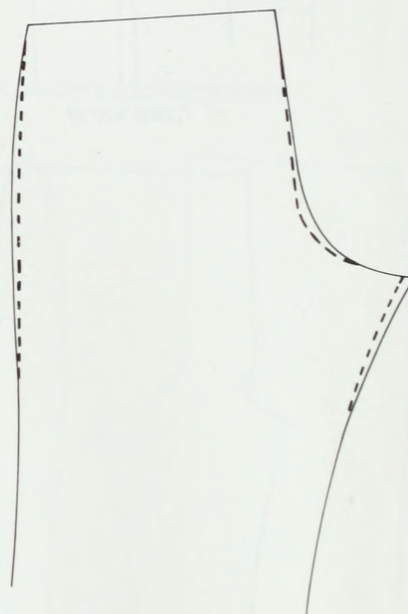

pants back

PROTRUDING HIGH HIPS

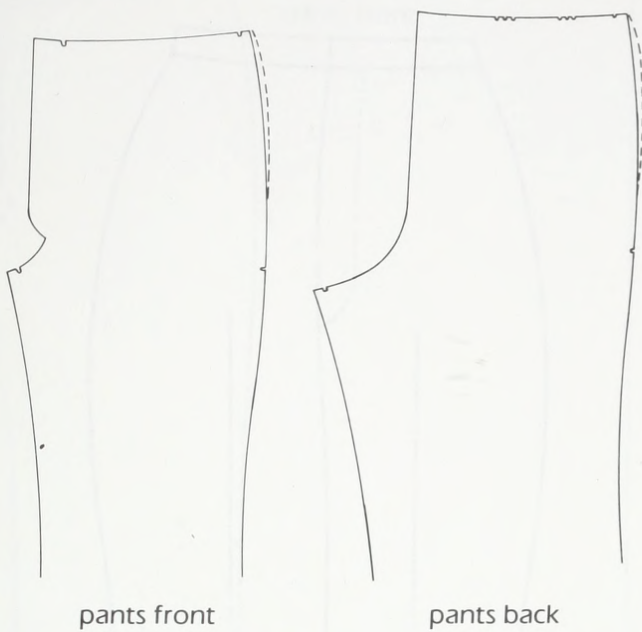

If there is horizontal pulling of the fabric directly below the waistline, extra fabric is needed at the side seam high hip level, front and back.

CROTCH—TOO SHORT/TOO LONG

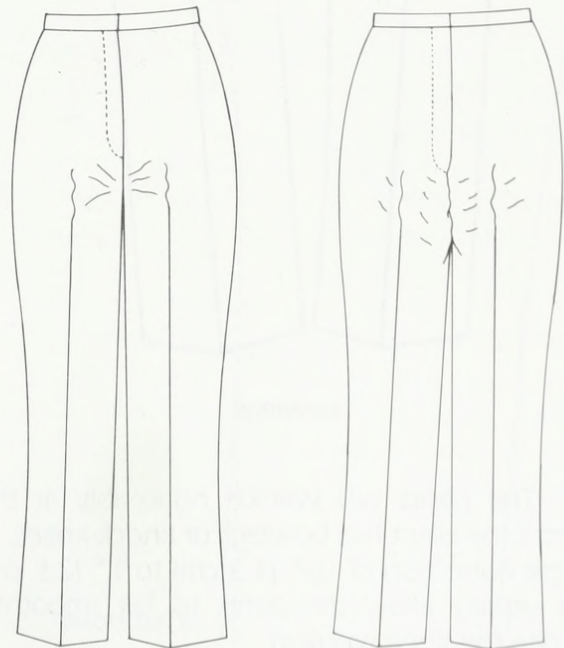
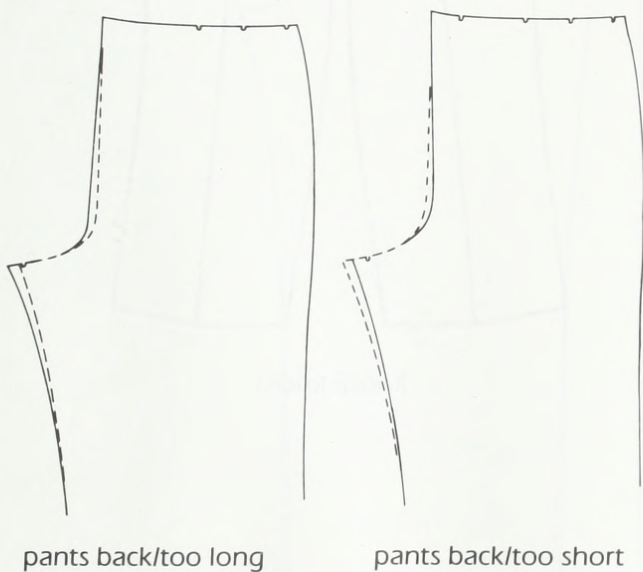

If wrinkles are concentrated in the crotch area, the hips are probably fine, but the crotch length must be corrected. Tight, pulling creases radiating from the crotch indicate a short crotch. Sagging, loose creases indicate a crotch that is too long.

Depending upon the amount of wrinkling, adjust the crotch between $\frac{3}{4}$ " (1.9 cm) and 1" (2.5 cm). Add or subtract this corrected amount on the *pattern back only*, by extending out or in from both the top of the inseam, and the center back seam at hip level.

BOWLEGS/KNOCK-KNEES



bowlegs



knock-knees

The pants will wrinkle noticeably at the knee if the client has bowlegs or knock-knees. A simple correction of $\frac{1}{2}$ " (1.3 cm) to 1" (2.5 cm) will usually allow the pants to fall smoothly, despite the knee problem.

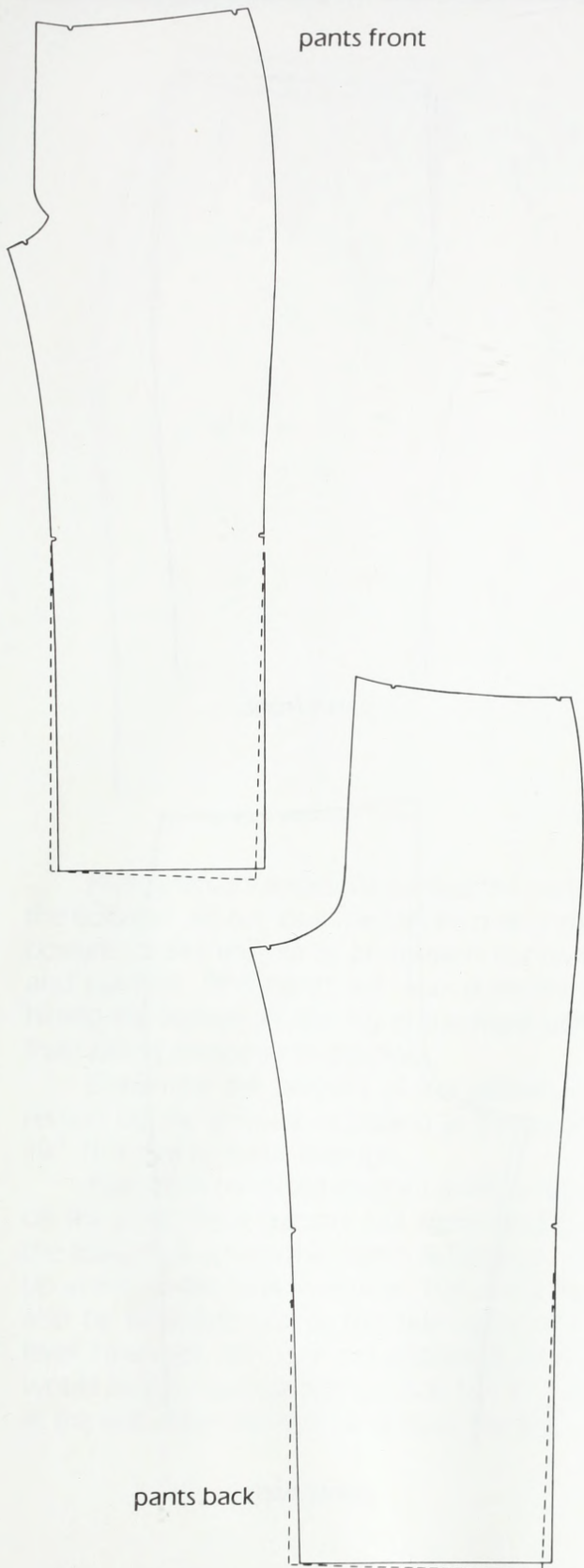

Bowlegs

Apply the same adjustment amount in and down at the bottom of the outseams, and out at the bottom of the inseams.

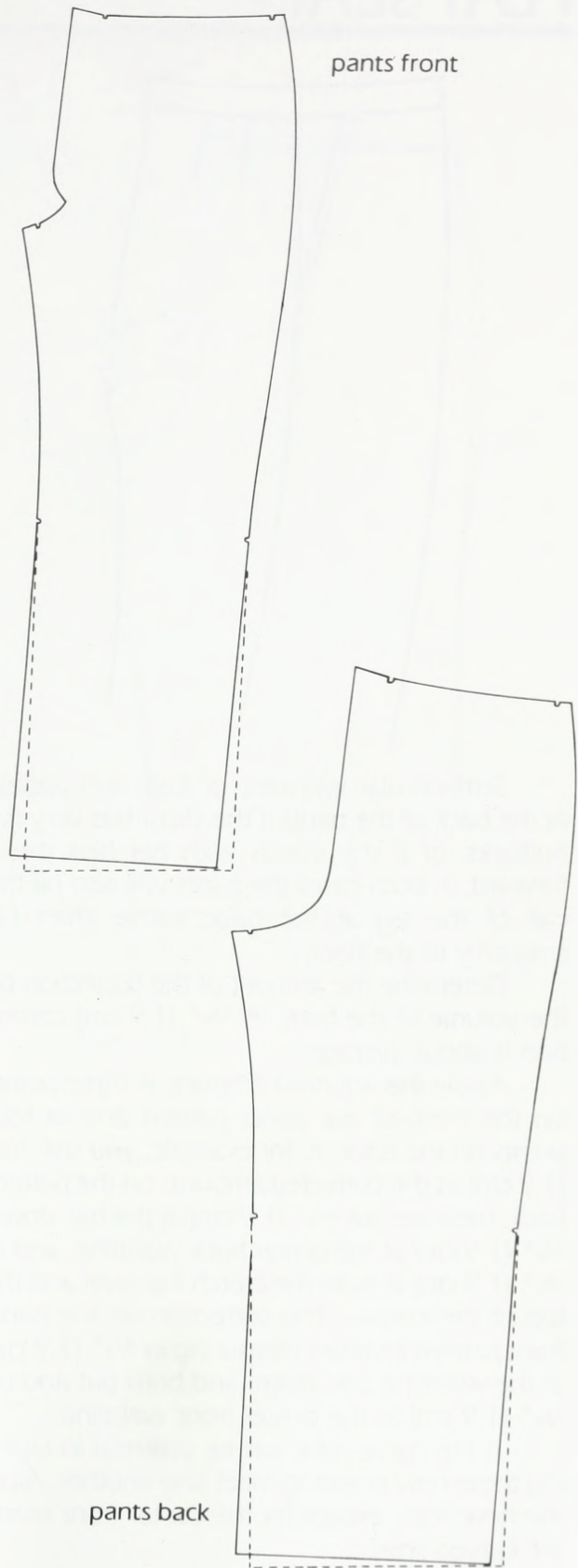

Knock-Knees

Apply the adjustment amount in and down at the bottom of the inseams, and out at the bottom of the outseams.

FLAT SEAT



Semi-circular wrinkles, or folds will appear at the back of the pants if the client has very flat buttocks, or if she stands with her hips thrust forward. In both cases the pants will also hit the calf of the leg at the back, rather than fall smoothly to the floor.

Determine the amount of the correction by the volume of the folds. A $\frac{3}{4}$ " (1.9 cm) correction is about average.

Apply the adjusted amount at three points on the front of the pants pattern and at four points on the back. If, for example, you use $\frac{3}{4}$ " (1.9 cm) as the corrected amount, on the pattern back, measure out $\frac{3}{4}$ " (1.9 cm) at the hip, down $\frac{3}{4}$ " (1.9 cm) at the center back waistline, and in $\frac{3}{4}$ " (1.9 cm) at both the crotch hip level and the top of the inseam. The correction on the pants front pattern involves measuring in $\frac{3}{4}$ " (1.9 cm) at the waistline side seam, and both out and up $\frac{3}{4}$ " (1.9 cm) at the center front waistline.

A hip curve ruler will be essential in tapering these new points to meet one another. All of the new lines, except for the center front seam, are curved lines.

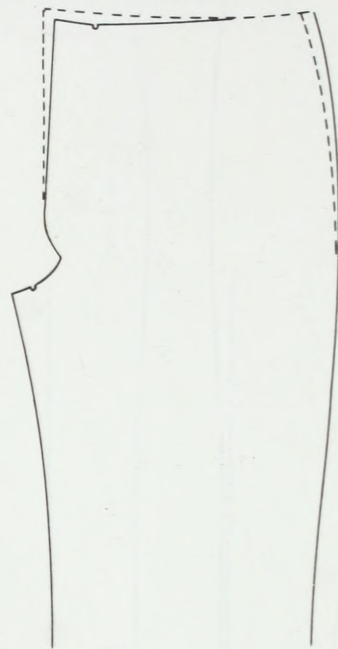

pants front

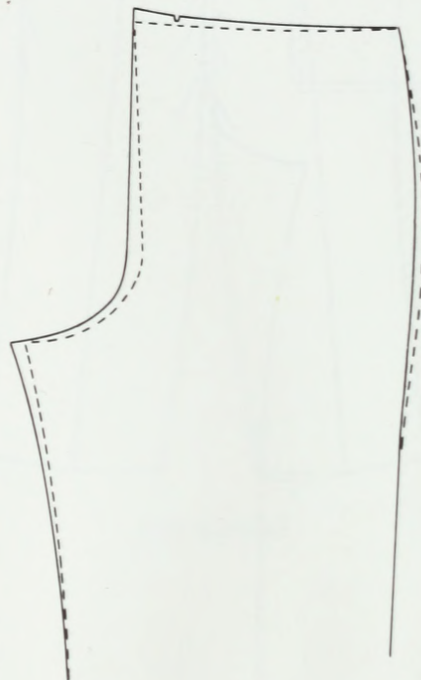

pants back

PROMINENT SEAT

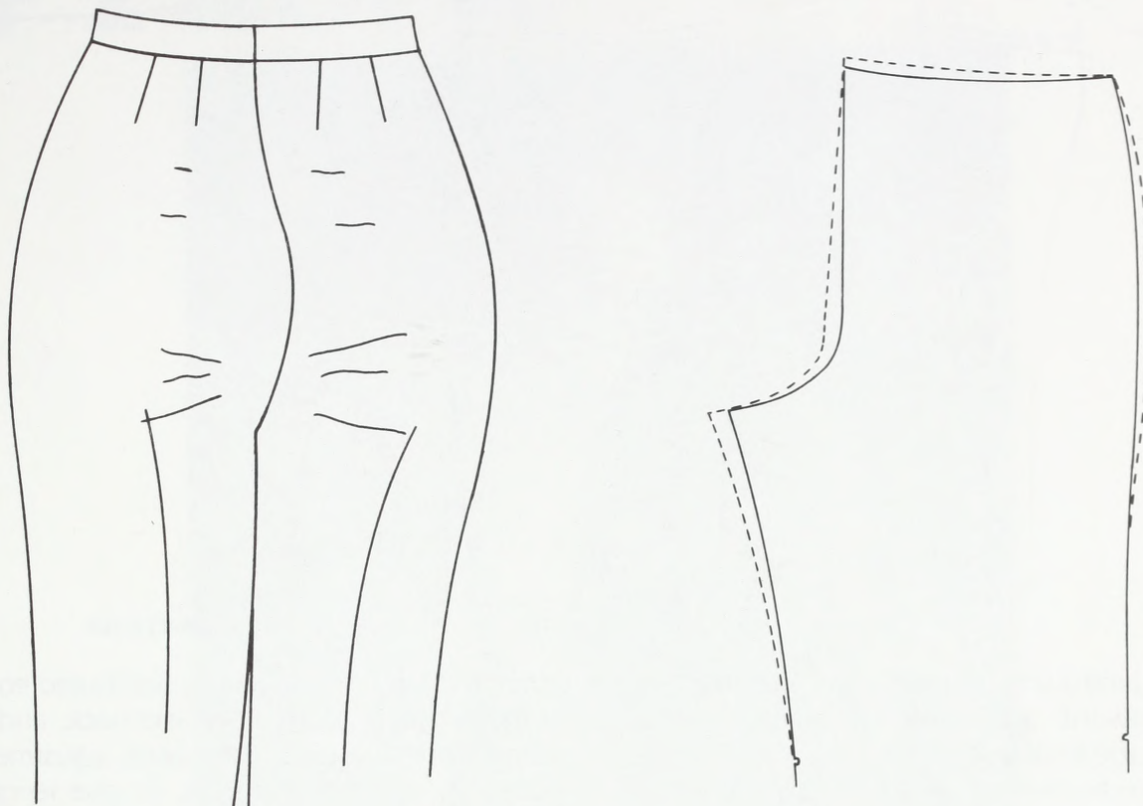

Pulling occurs across the back of the pants if the buttocks are full, or if the client's overly erect posture causes the hip to be thrown backward and upward. The pants are also distorted by hitting the bottom of the leg in the front rather than falling smoothly to the floor.

Determine the amount of the pattern correction by the amount of pulling at the back— $\frac{3}{4}$ " (1.9 cm) is about average.

Apply this corrected amount at three points on the pants back pattern: out from the top of the inseam, and from the crotch at hip level, and up at the center back waistline. The pants must also be extended out at the side seam at hip level. However, $\frac{3}{4}$ " (1.9 cm) additional shaping would be too much at the hip. Add $\frac{1}{2}$ " (1.3 cm) at the side seam hip level and taper the line.

PROTRUDING STOMACH

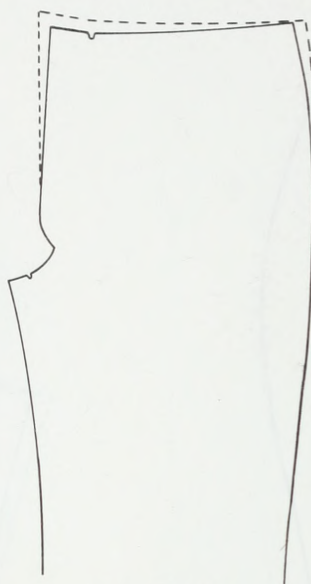

pants front

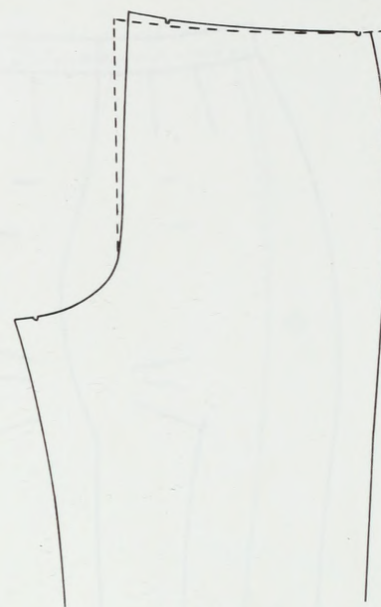

pants back

A protruding stomach will pull the side seam forward, and draw the waistline down lower in the front than in the back. Extra fabric is needed in both *length* and in *width* at the *front* of the pants, and in *width* at the pants *back*. The

estimated addition of fabric is distributed equally at the waistline center front and back, and side seams front and back. The same adjustment is added up at the center front, to give length in the rise.

RISE—TOO LONG/TOO SHORT



too long

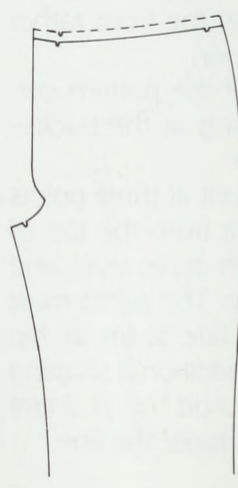

too short

If the pants are too long or too short from crotch to waistline, the pattern is either lengthened or shortened at the waistline by the desired amount.

4 Fabric



SELECTING THE FABRIC

If you want the very finest fabric for classic tailoring, choose wool. There is an endless variety of beautiful fabrics available to us today, most of which will respond favorably to certain tailoring features. There is no reason to limit your wardrobe to one fabric. However, full tailoring procedures (canvas, tape, etc.) will produce their best results for wool. Silk and linen are close seconds.

Wool fabric has a distinctive personality which relates better with tailoring procedures than any other fabric. There is no disagreement among tailors on this.

The tailoring techniques described in this book, direct you at times, to stretch the fabric, or to shrink it, to mold it to fit the contours of the human body. Wool fabric is somehow able to take on this newly molded shape and to hold it as if it had always been its own. This is unique among fabrics.

Wool comes in a variety of weights and characteristics, which can be worn comfortably

from the tropics to the Arctic, year-round. It is durable, has a long-life expectancy, and handles beautifully at the sewing machine.

There are two major wool categories:

- Worsteds
- Woolens

Worsted fabric is woven from long, finely combed wool fibers which have been twisted tightly, and then woven tightly. The effect is a fabric with a firm, flat surface, as in a serge, or a gabardine. The traditional tailored business suits are made from worsteds rather than from woolens.

Woolens are woven from relatively short wool fibers, which have not been combed smooth. These fibers are twisted loosely and then woven much less tightly than the worsteds. The effect is a soft, easy fabric, such as a Harris tweed, or a flannel. Woolens are more suited to comfortable, sporty garments than they are to business suits.

PROPERTIES OF WOVEN FABRICS

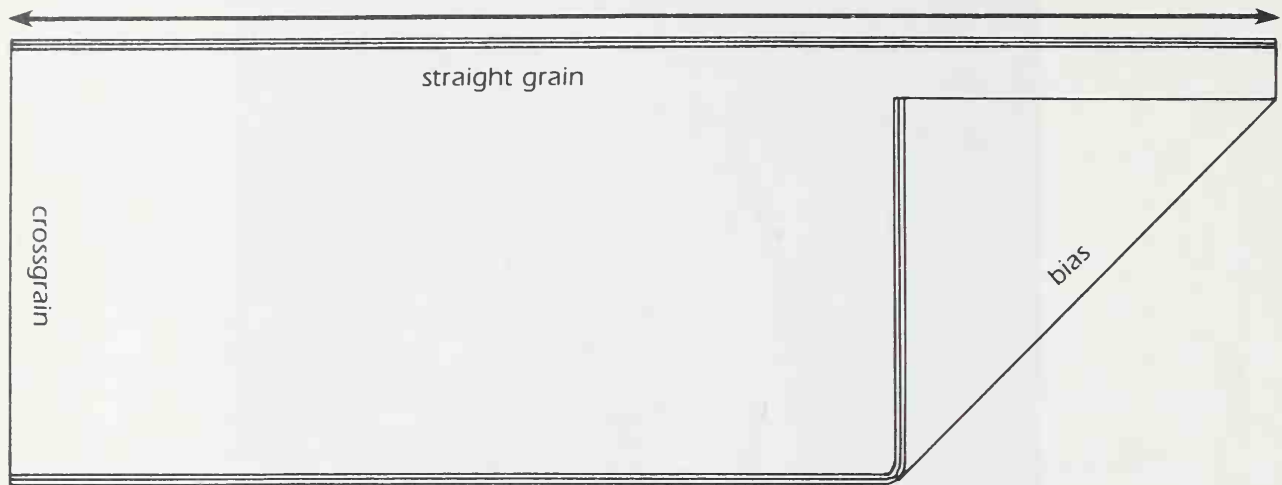

The Grain

There are certain properties of woven fabrics, which must not be overlooked as we set to work.

Woven fabric is made by interlacing threads at right angles to one another, evenly or in patterns. The lengthwise thread (the warp) runs parallel to the *selvage* (the finished edge along the length of the fabric at either end). The lengthwise of the fabric is called the *straight grain*. The crosswise thread (the weft), the *crossgrain*, runs at a right angle to the selvage. There is no thread running diagonally across the fabric. However, the diagonal direction of the fabric is called the *bias*. The lengthwise thread must be strong to withstand the workings of the loom, and to support the fabric. The crosswise thread need not be quite as strong.

Because of the strength of the lengthwise thread, and the fact that the crosswise thread will "give" or drape gently in response to grav-

ity, most garments will hang best if they are cut so that the lengthwise thread hangs vertically. Garments cut on the crossgrain (with the crossgrain hanging vertically) hang less comfortably and somewhat stiffly. Garments cut on the bias (with the bias hanging vertically) have neither the lengthwise nor the crosswise thread to support them directly. Therefore, the fabric finds it difficult to hold a shape. Bias-cut garments drape beautifully, *and* they stretch.

Whether you are cutting a bias skirt, or a crossgrain waistband, or a straight grain pair of trousers, the directions for cutting are always the same. Every pattern piece should be placed on the fabric so that the *arrow* on the pattern is *parallel* to the *lengthwise grain* of the fabric.

To say that something is cut on the crossgrain, or on the bias, has less to do with the direction in which it is cut than it has to do with the direction in which it is worn.

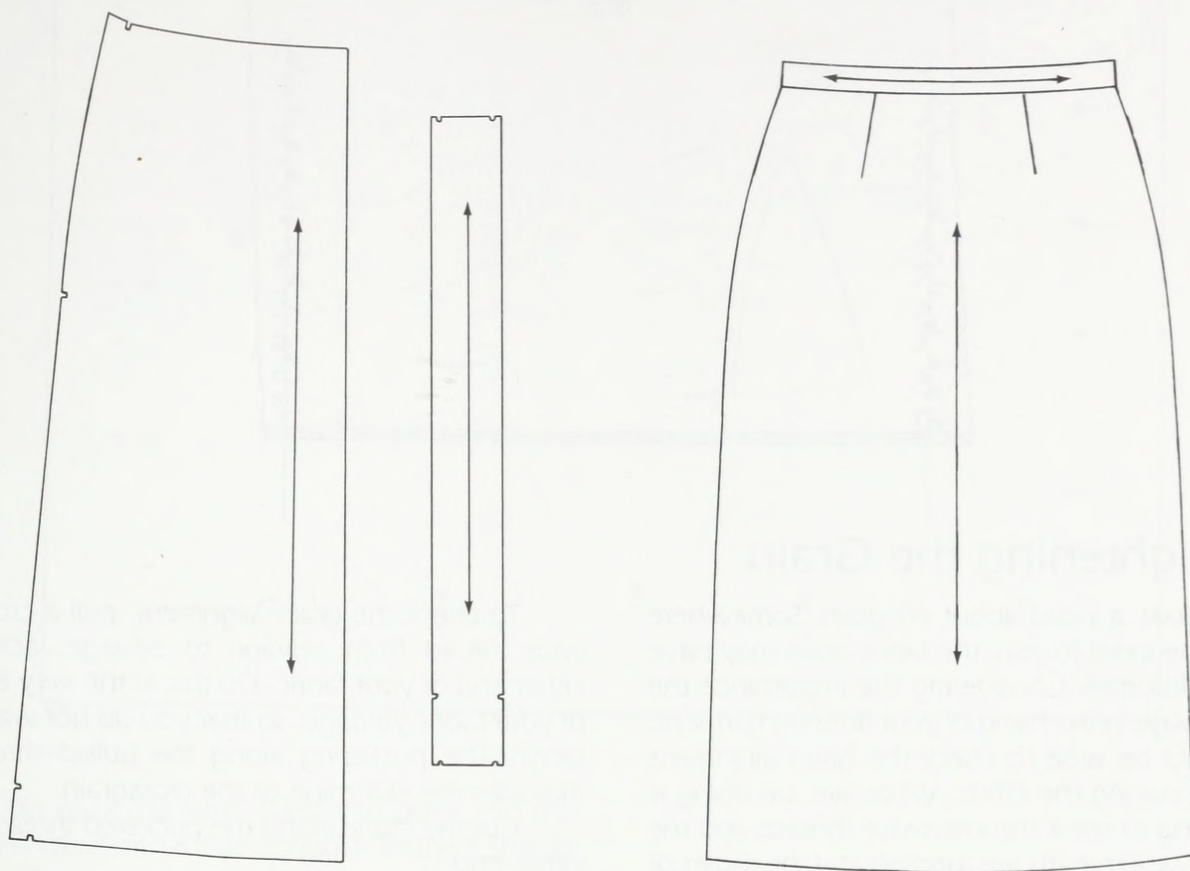

The waistband and the skirt, have both been cut in the same direction. However, because the waistband will eventually be placed on the garment with the straight of the grain in a horizontal position, the waistband will be said to have been cut on the crossgrain. And since the straight of the grain on the skirt will be in a vertical position, the skirt is said to have been cut on the straight grain.

The major pattern pieces of tailored garments are cut on the straight grain. And for various reasons, certain smaller pieces of each garment are cut on the crossgrain or on the bias.

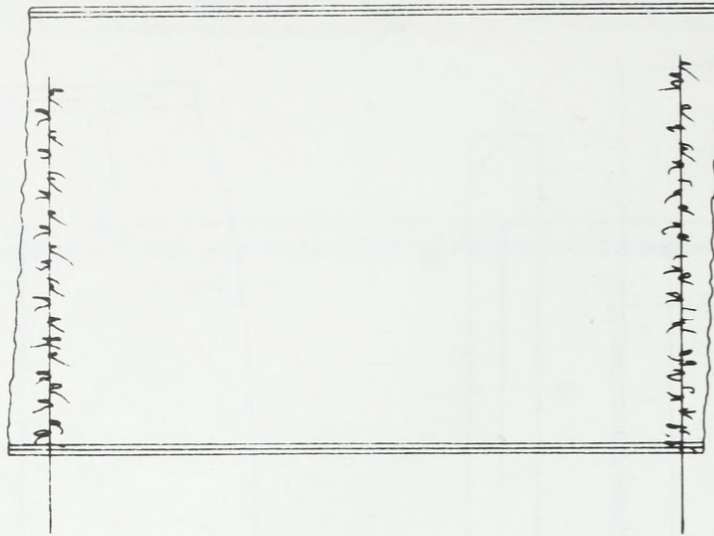

Straightening the Grain

Now, a word about *off grain*. Somewhere from the loom to you, the fabric grain may have been distorted. Considering the importance the grain plays in the hang of your finished garment, it would be wise to check the grain alignment before cutting the fabric. What we are doing is checking to see if the crosswise threads and the lengthwise threads are running at right angles or perpendicular to one another. If they are not, everything we have discussed about placing the arrows on the pattern parallel with the selvage, will be useless.

To check the grain alignment, pull a crosswise thread from selvage to selvage, across either end of your fabric. Do this at the very end of your fabric yardage, so that you do not waste fabric. The puckering along the pulled thread indicates the exact line of the crossgrain.

Cut the fabric along the puckered thread at either end.

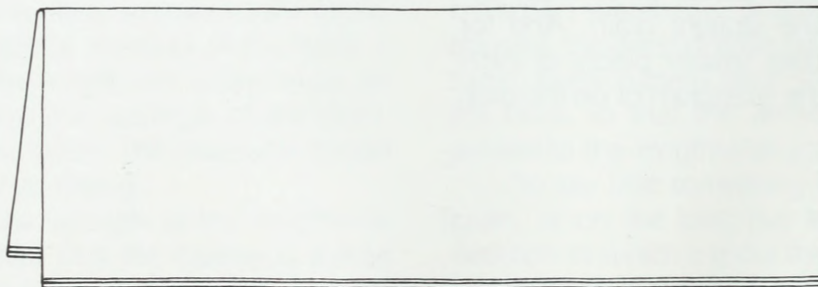

Fold the fabric selvage to selvage, right sides together. See if the fabric will lie comfortably in a perfect rectangle. If it will not, the crosswise and lengthwise threads are no longer running perpendicular. The fabric is *off grain* and must be coaxed back into place.

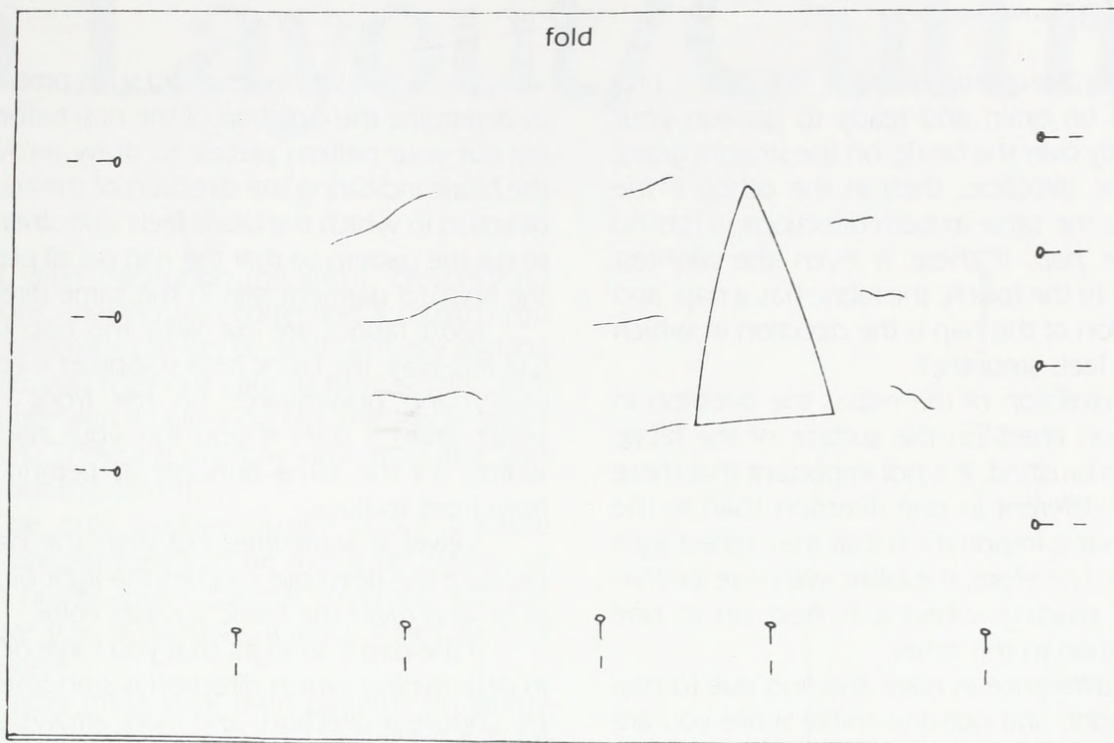

To coax the fabric back into place, pin the folded fabric into the rectangular shape it should have. Steam press from selvage to fold, on the wrong side, until the ripples in the fabric disappear. Washable fabrics which are off grain can be gently pulled back into shape while they are damp. This should be done on a flat surface, a small area at a time.

Shrinkage

Woven natural fibers are susceptible to shrinkage. All woven fabrics, which will become part of your garment such as the wool canvas interfacing, the twill tape, the pocketing, and the garment fabric itself, must be *preshrunk*. The French collar canvas is an exception.

Even if the label on the garment fabric says that it has been preshrunk, you are safer if, before cutting, you have the fabric steam-pressed and preshrunk professionally by a dry cleaner.

Shrink the wool canvas interfacing by soaking it in cool water for about one hour. Let it drip dry and then steam press *well*. The cotton twill tape can be soaked in cool water and ironed wet. It will not lose its shape. Pocketing fabric and grosgrain ribbon are sufficiently shrunk by simply steam pressing them well. The lining fabrics we have suggested will not shrink during drycleaning.

The Nap

When the garment fabric has been pre-shrunk, is on grain and ready to go, run your hand lightly over the fabric, on the straight grain, first in one direction, then in the other. If the fabric feels the same in both directions, it has *no* discernible *nap*. If there is even the slightest difference to the touch, the fabric has a nap, and the direction of the nap is the direction in which the fabric feels smoother.

The direction of the nap is the direction in which short fibers on the surface of the fabric have been brushed. It is not important that these fibers feel different in one direction than in the other. What is important is that they reflect light differently. Therefore, the fabric will have a different color shading when it is held up in one direction than in the other.

The difference in color shading due to nap is often slight, and not discernible while you are working with the fabric flat on the table. If you ignore the nap and (for example) cut the jacket body with the nap down and the sleeves with the nap up, from across the room it may look as if you have cut the sleeves from completely different fabric.

The simplest way to avoid such problems is to determine the direction of the nap before you lay out your pattern pieces; to draw arrows on the fabric indicating the direction of the nap (the direction in which the fabric feels smoother); and to cut the pattern so that the nap on all pieces of the finished garment falls in the same direction.

Most fabrics are cut with the nap down. Cut this way, the fabric feels smoother if you run your hand downwards on the front of the jacket, than it does if you run your hand upwards. It's the same principle as petting a cat from front to back.

Velvet is sometimes cut with the nap up, because the deep pile catches the light best that way, and gives the fabric a richer color.

If the nap is so slight that you have difficulty in determining which direction is smoother, simply choose a direction, and mark arrows to that effect on the fabric. It is less important to have the direction of the nap correct than it is to cut all the pattern pieces *consistently*, in whatever direction you have chosen.

5 Layout/Cutting

If, after measuring the client, preshrinking the fabric, making and correcting a muslin, you are very anxious to get on with actually making the suit, you may not care to hear at this point that professional tailors do not use tissue paper patterns. They are just too unwieldy (the patterns, not the tailors).

The only positive quality about a tissue paper pattern seems to be that it fits neatly, or not so neatly, into a pattern envelope. On the negative side, it wrinkles, it tears, it flies away if you sneeze.

Tailors make their own patterns on sturdy paper or on oaktag. The oaktag pattern can be laid in place on the fabric, weighed down rather than pinned, and traced with tailor's chalk. Small holes are made in the oaktag pattern through which dart tips and pocket points can be marked. Notches are cut into the edge of the pattern at waistline, hemline, roll line, etc. When not in use, the patterns are hung neatly on pattern hooks.



Except when cutting the sheerest dress fabrics, this method of pattern layout is faster and more accurate, because it eliminates pinning the pattern to the fabric. Besides being time-consuming, the process of pinning disrupts the lay of the fabric, making it very difficult to cut the two layers of fabric identically.

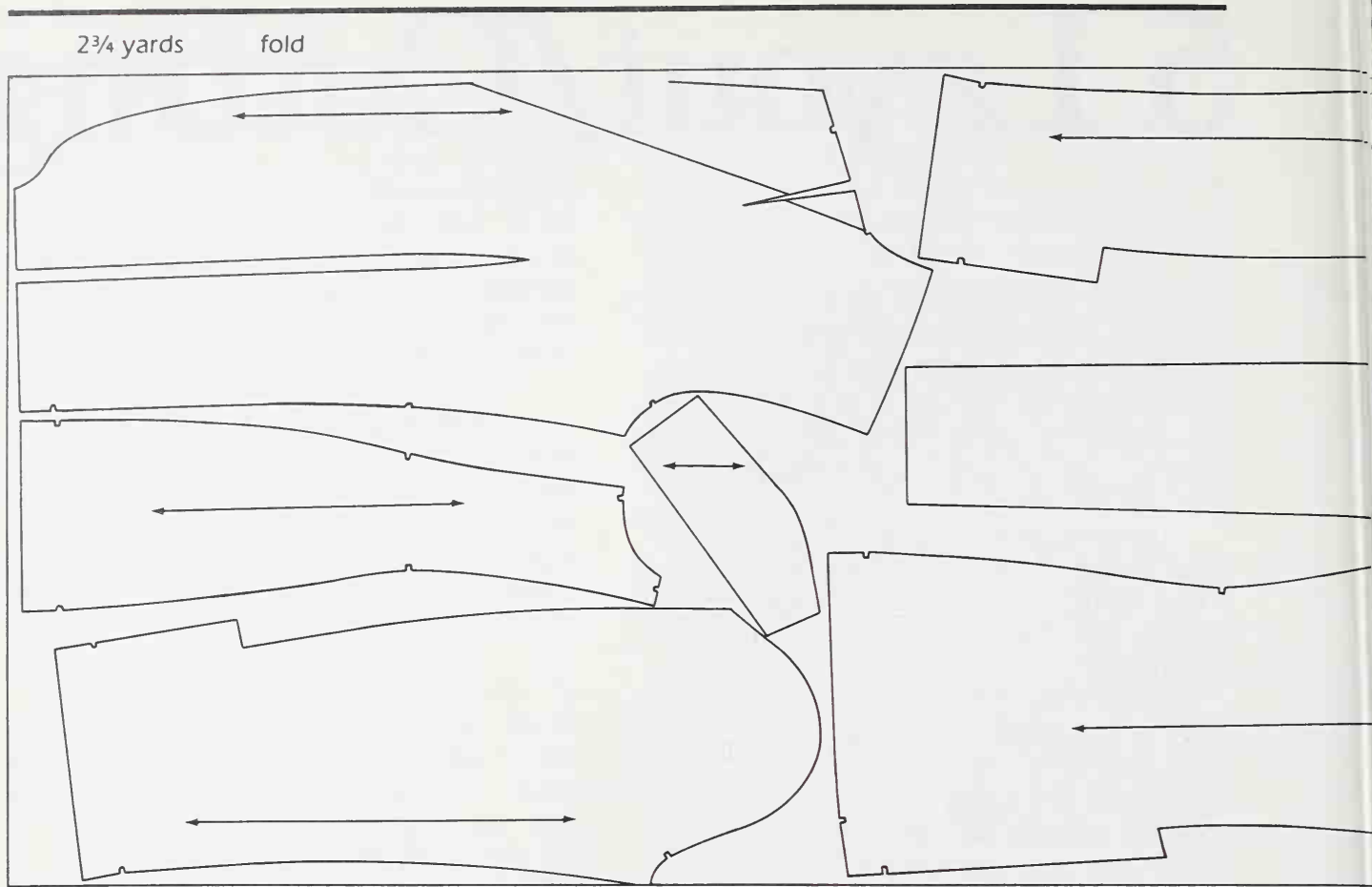

If you simply don't have the patience to transfer your pattern onto oaktag at the moment, you can still avoid pinning the pattern to the fabric by weighing down the tissue pattern. Tracing will not be quite as speedy without the stiff pattern edge to guide the chalk, but it will still be more accurate, and easier than pinning.

Keep the oaktag alternative in mind, especially for patterns that you use over and over again.

For your first few tailoring projects, we suggest that you purchase more fabric than your

pattern requires, to allow for a few small errors in judgment and skill, pocket flaps, etc.

For the jacket, lay out your main pattern pieces: the front, back, side panel, facing (make sure this is the revised facing on page 13), and sleeve. The sleeve should be traced onto the fabric along with the other main pattern pieces, as a reminder of its presence, and its demands on the fabric. However, we will not cut the sleeve until much later, when the jacket is almost completed. Until you are familiar with the construction techniques, the pockets and the collar

2³/₄ yards fold

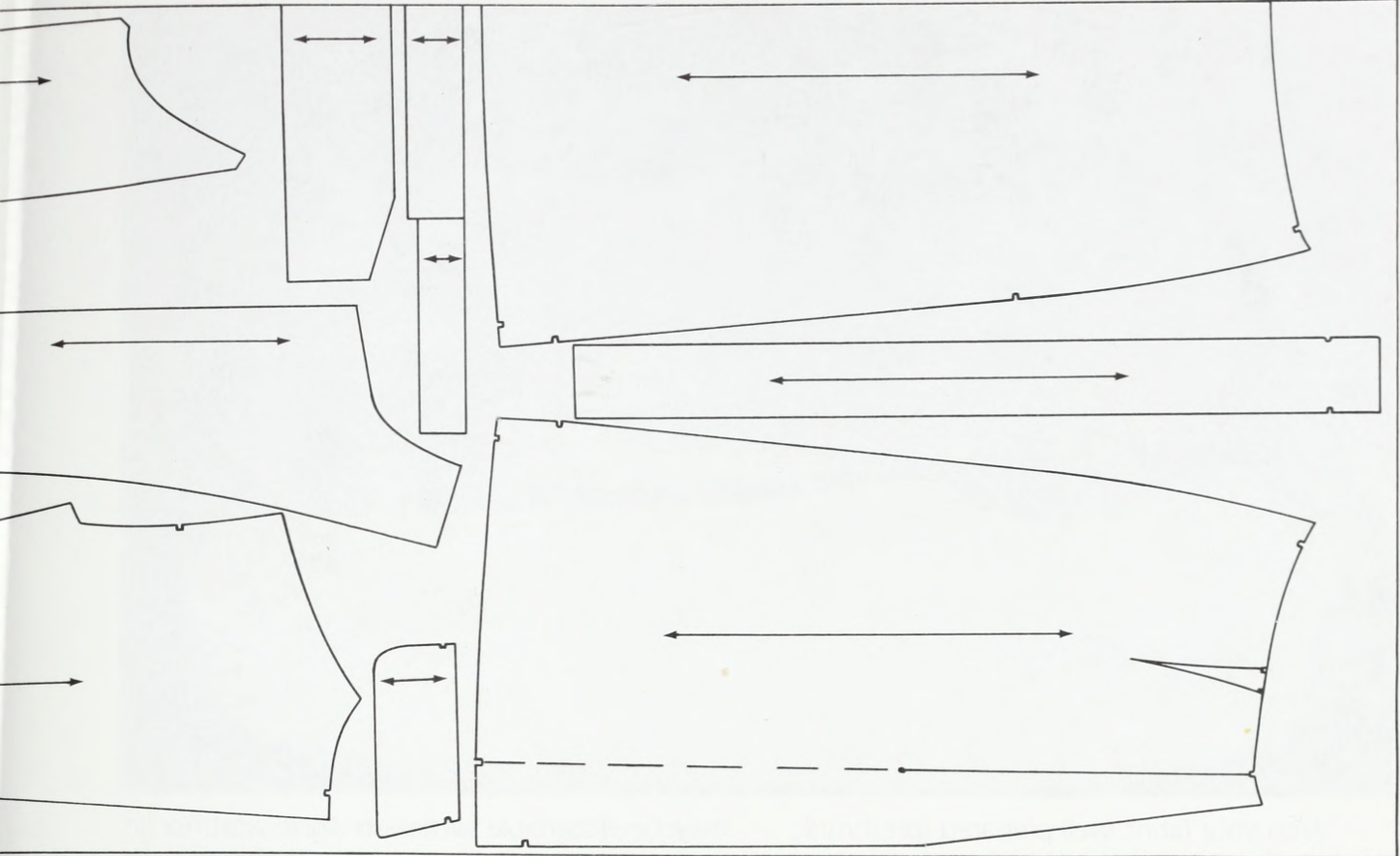

should be cut only as you need them, following the instructions in each section.

Do the same with your skirt and pants patterns. Set to work with only the main pieces of your skirt and pants cut. The facings, pockets and waistband are cut as you work along with the book.

Of course, cutting everything at once allows for the most economical use of your fabric, and many tailors develop this skill to a fine art. The illustration shows a professional, nap layout of a size 10, woman's suit. It makes good busi-

ness sense as well as a good challenge to plan your work as tightly as it is illustrated here. It also takes experience. For the moment we will assume that you have challenge enough in producing a well-tailored suit. The challenge of a tight layout can come later, with experience.

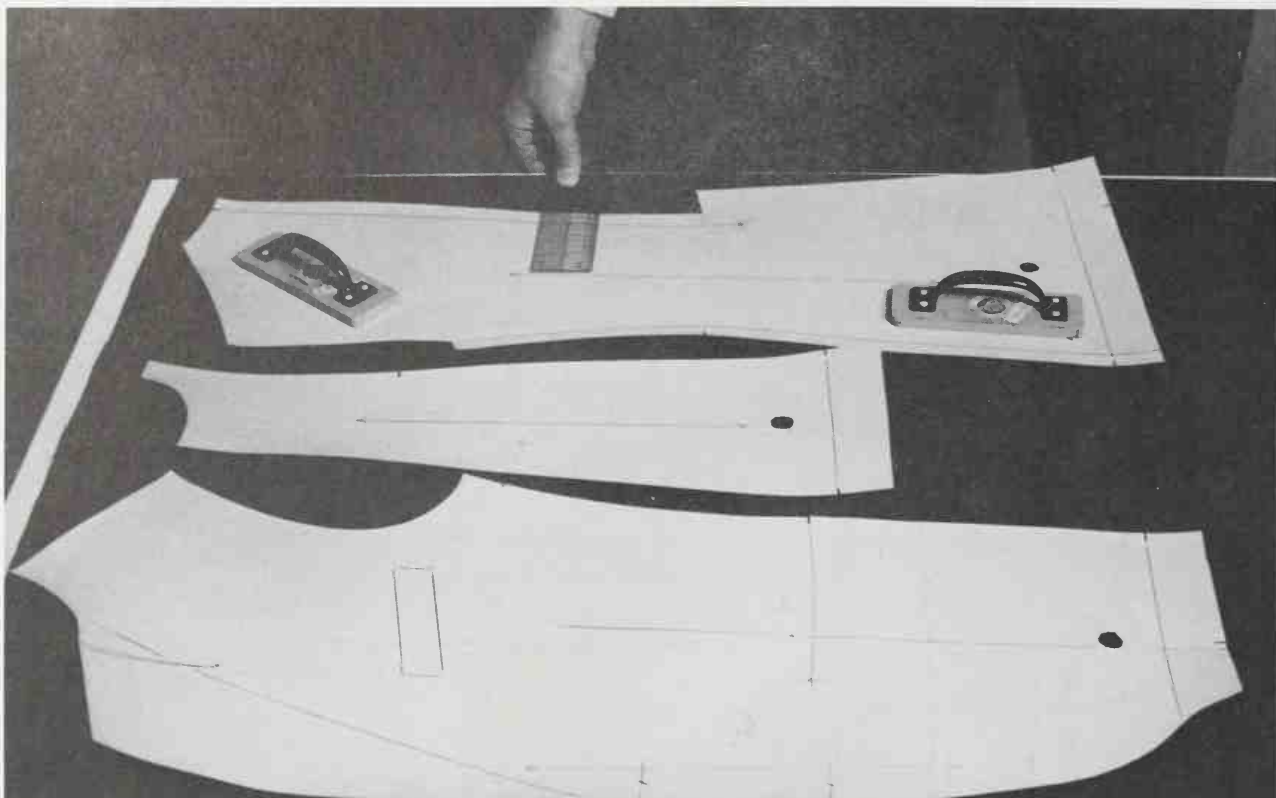

With your fabric well prepared (preshrunk, pressed, on grain and marked for nap), lay out your main pattern pieces. Use a nap layout unless you have a good reason not to (too little fabric). It is always safer to use a nap layout, especially with wool, since slight color shading

may be discernible in the sunlight, and not in your workroom. Lay your pattern pieces with great respect for the fabric grain. The grain arrows on each pattern piece should be exactly parallel with the selvage. Measure to check the accuracy of your eye.

With sharpened, clay tailor's chalk, the process of tracing around each pattern piece is easily and accurately done. Sharpen the chalk, so that you can produce a thin, clean line without the necessity of pressing heavily on the chalk and the fabric. Applying pressure to the chalk instead of sharpening it, produces a thick, undetermined line, and may even disturb the lay of the fabric.

We suggest clay tailor's chalk, rather than chalk with a wax content, because with chalk you can freely mark on the right side of your fabric without ever worrying that the marks will be permanent. The clay chalklines can be brushed away easily when they are no longer needed. Pressing on top of the clay chalklines is not suggested, since this will render the marks more difficult (though not impossible) to remove.

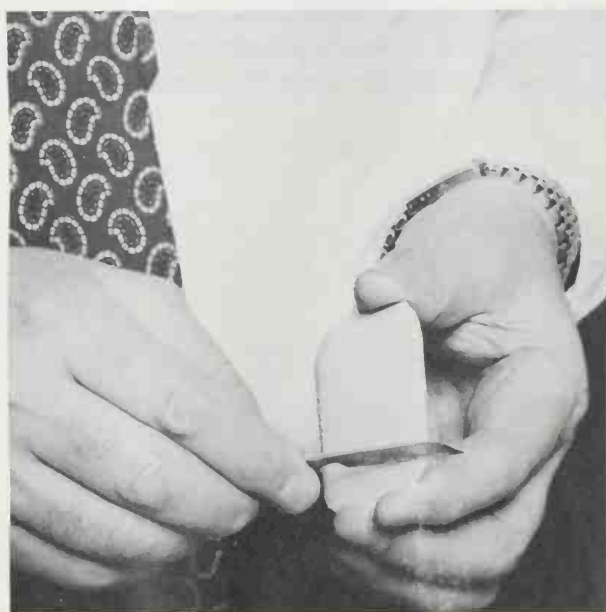

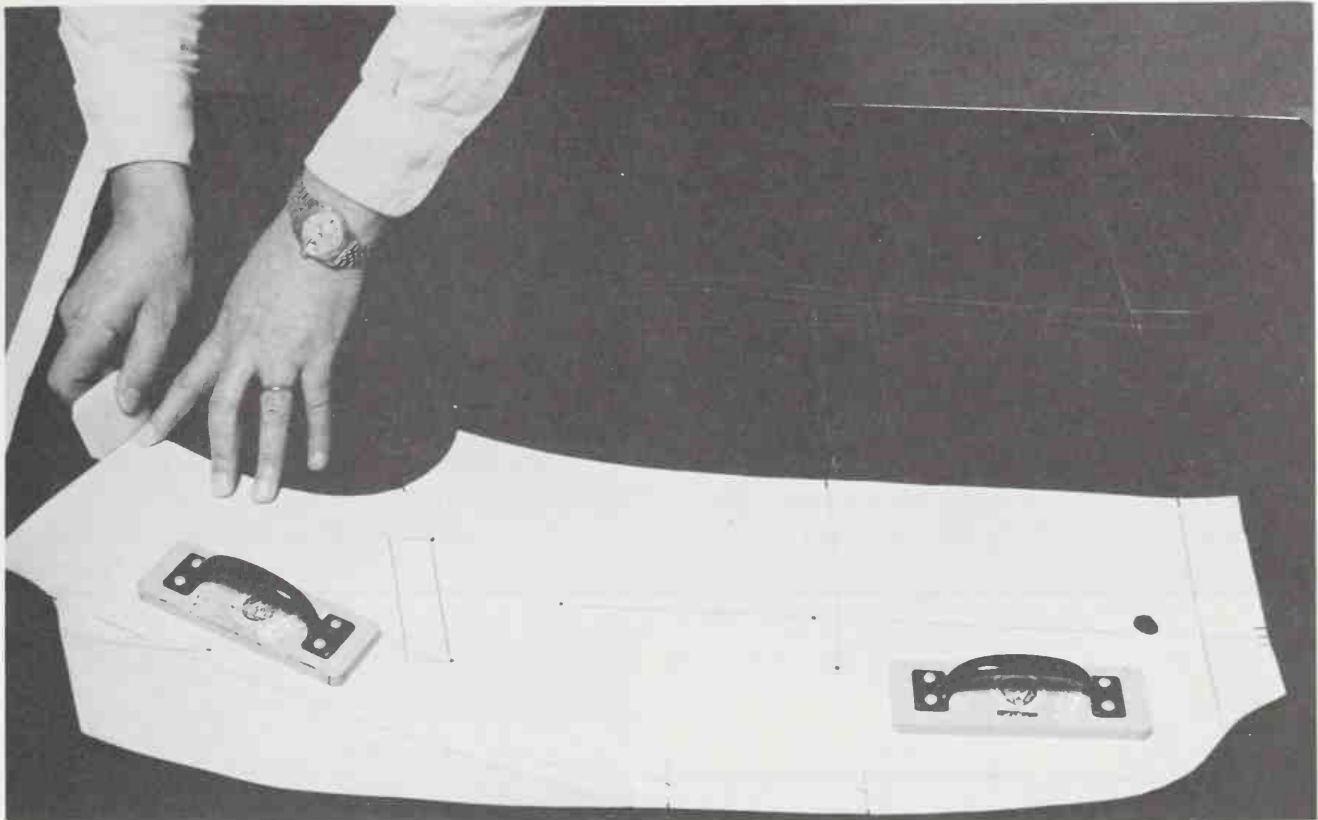

Trace around the jacket front pattern piece indicating all notches, including the waistline, the collar notch, the top and bottom of the lapel roll line, and the front armhole notch.

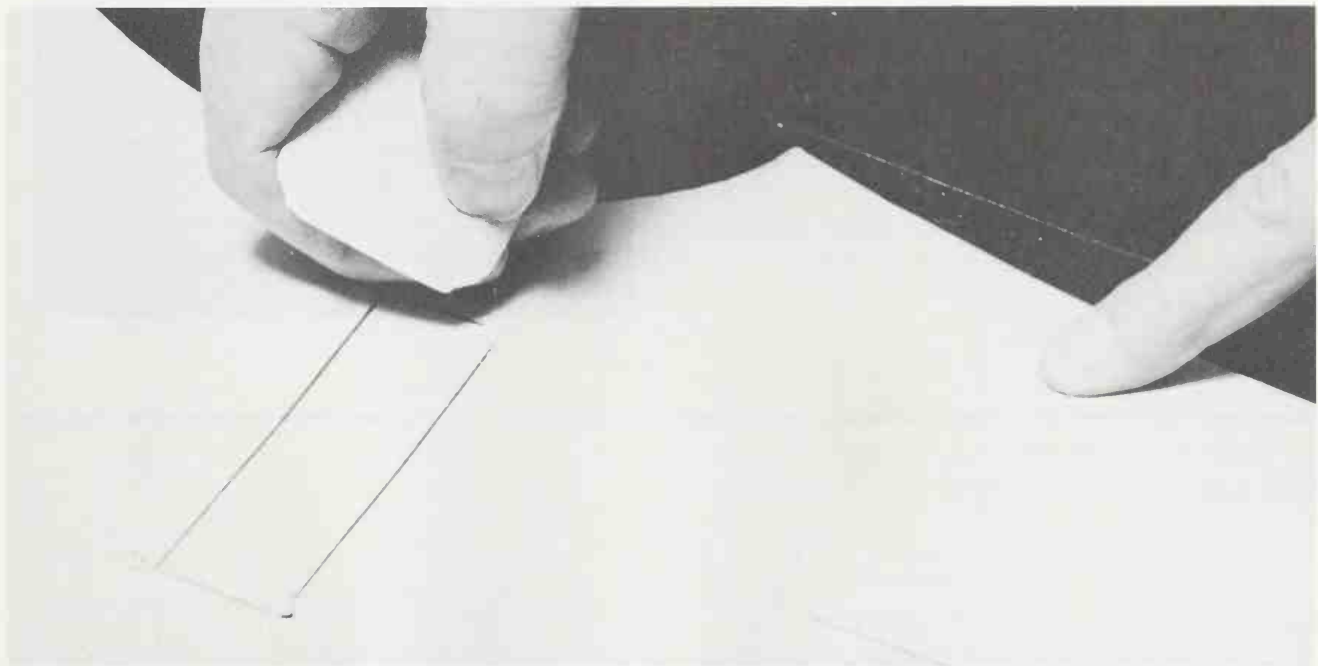

Mark the dart tips and the ends of the pocket placement lines, by scratching the chalk and letting the chalk dust settle through the holes in the pattern.



The pocket placement line for a double-piping pocket is the center line.

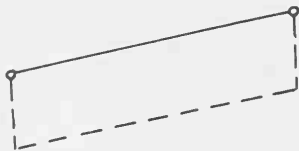

For a welt pocket, it is the bottom line.

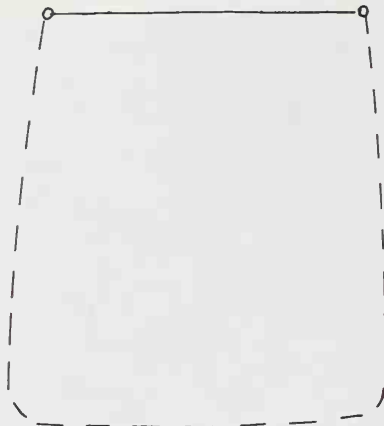

And for a patch pocket, the pocket placement line is at the top.

Remove the pattern and cut the fabric, indicating border notches by a snip into the seam allowance (no deeper than $\frac{1}{8}$ " (3 mm)).

The best scissors to use for cutting double layers of fabric are bent-handle shears. The bottom blade can rest on the table as the fabric is being cut. The blade is in a position to slide along with minimal disruption of the fabric.

Resist the urge to pull the fabric towards you as you cut. Any such movement might ruin your careful grainline efforts.

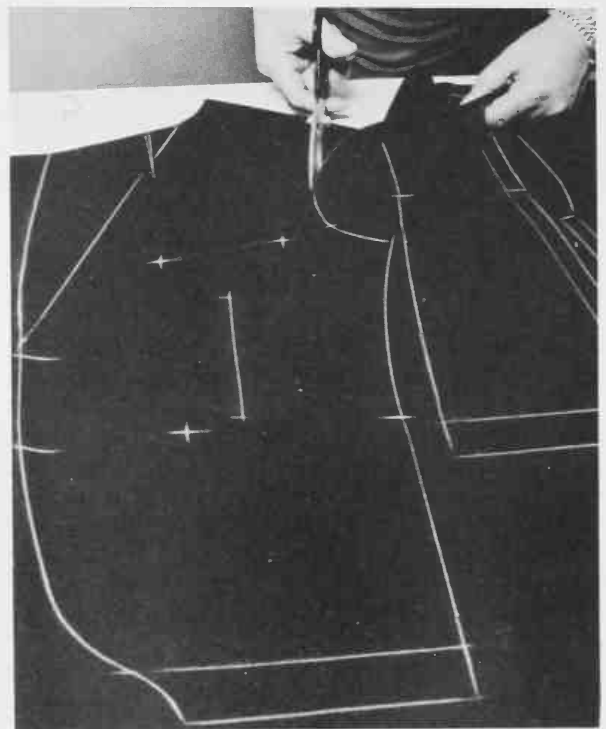

After each pattern piece has been cut, the chalk guidelines are preserved by *tailor tacking*.

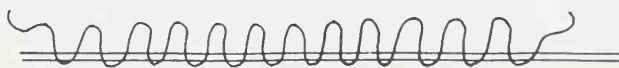

Tailor tacking is simply a running stitch through two layers of fabric, which leaves loops of extra thread on the top layer (as illustrated).

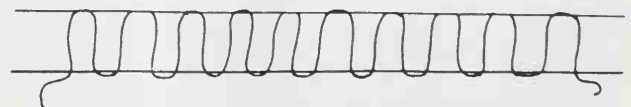

When the two layers of fabric are separated, the excess thread is shifted to the inside.

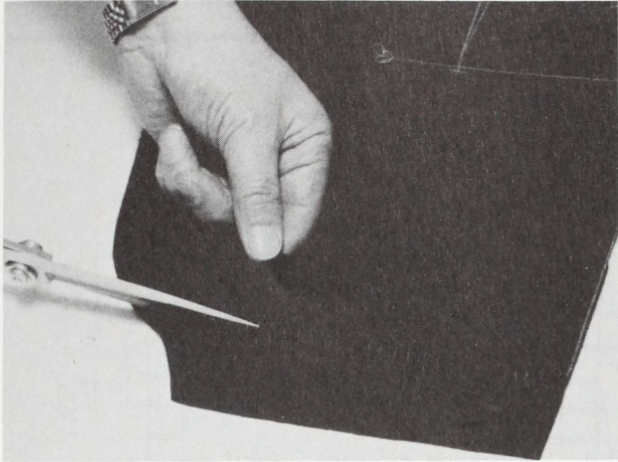

Snipping the thread down the center creates the thread markers—neat loops on the wrong side of the fabric, and hair-like protrusions on the right side.

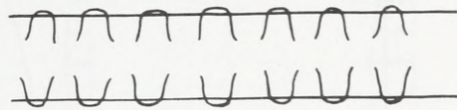

To tailor tack points or ends rather than lines, two stitches are taken on top of each other, leaving the loose thread loop on the top layer of fabric. Dart tips and the ends of each pocket are point-tacked in this way.

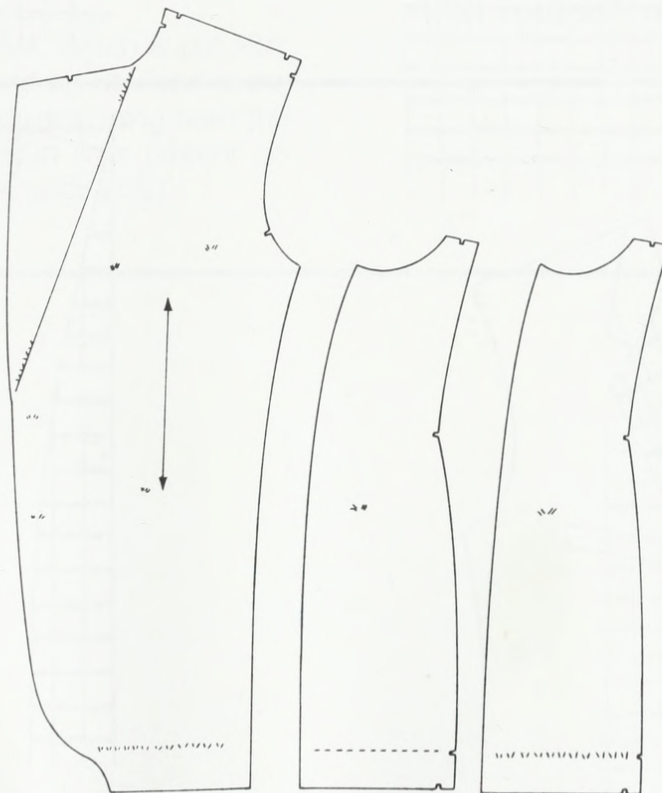

Chalkmark the hemline and roll line. Tailor tack the full length of the hem, and only the beginning and end of the roll line.

The procedure for cutting *skirt* and *pants* is essentially the same as for cutting the jacket. The

grain of the fabric is vital, and all pertinent pattern information should be tailor-tacked into the fabric. The short time spent on tailor tacking now will save hours of guessing and correcting later.

PLAIDS OR STRIPES

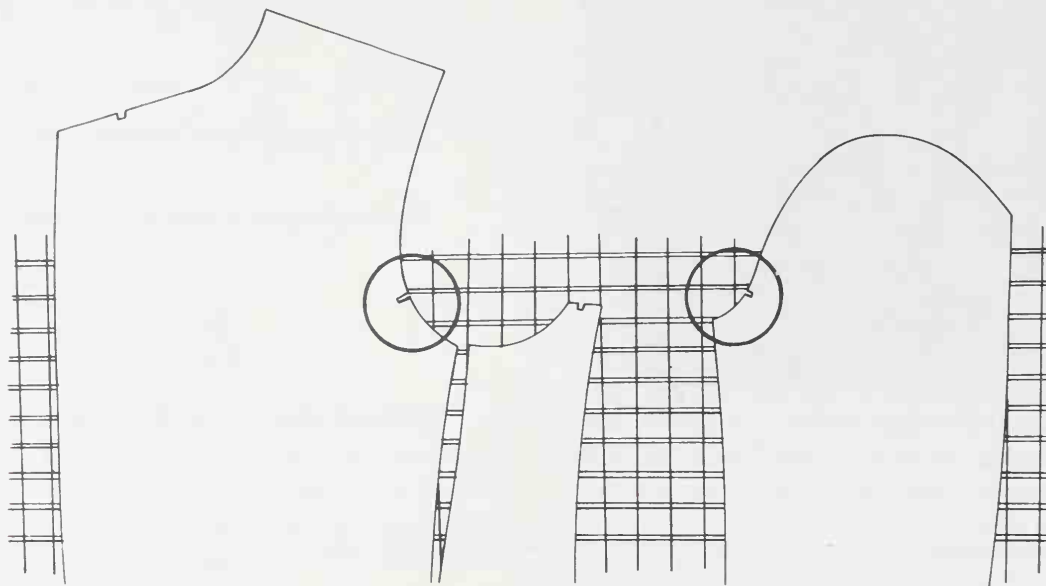

The layout for a plaid or striped fabric requires added attention.

The horizontal lines at the top of the sleeve front should match those on the body of the jacket. Place the notch on the top sleeve pattern and the front notch on the armhole at identical points on the plaid design. (See page 177.)

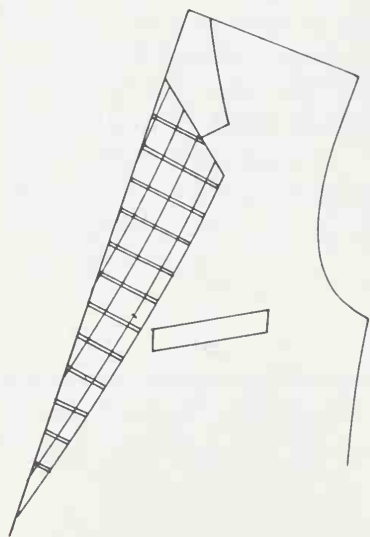
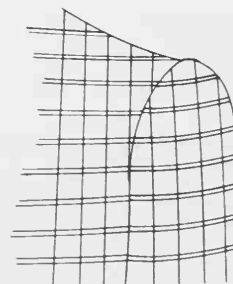

The outer edge of the lapel on the facing should be on the straight of the grain, between two prominent vertical stripes. The stripe should run the whole length of the lapel, without veering off along the way.

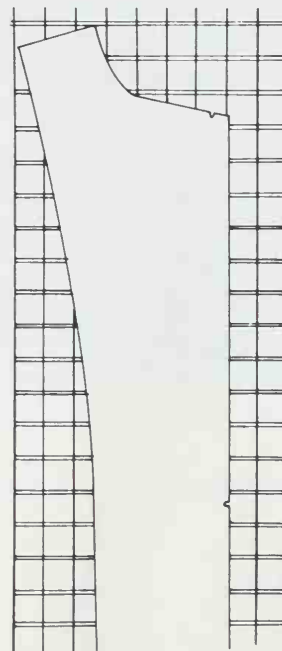

Place the revised facing pattern (page 13) so that the notch at the top of the lapel falls between two prominent vertical stripes. The facing on a plaid or striped jacket should be applied by hand (page 121) rather than by machine, for the most control in matching the lines.

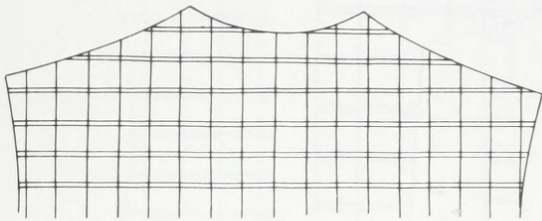

The center back seam, at the neck edge, should not interrupt the pattern of the plaid.

Place the stitchline of the center back neck edge at the very center between two vertical stripes on the plaid.

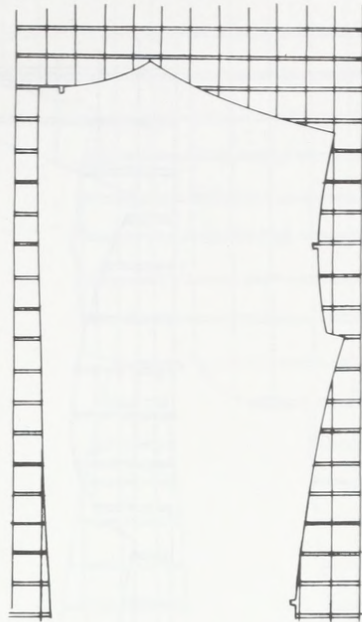

The collar, viewed from the back, should not create any interruption in the plaid design of the jacket back.

Therefore, the topcollar, which is cut after the undercollar is set, should be attached to the undercollar with an eye to continuing both the horizontal and vertical design lines present on the back of the jacket. (See page 155.)

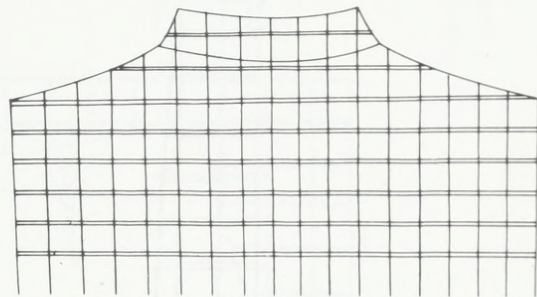

The seamline at the straight part of the jacket front, below the lapel, should not fall on a prominent vertical stripe.



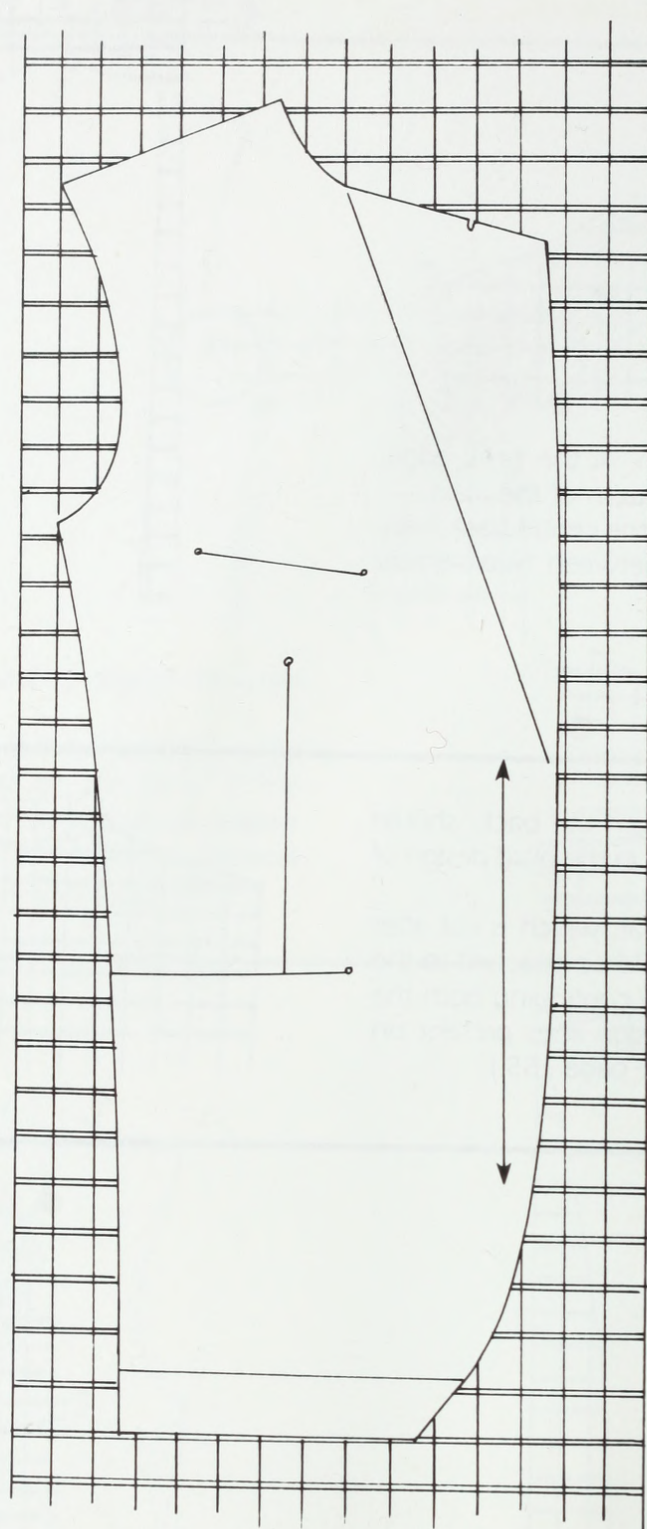

Place the straight portions of the jacket front pattern on the plaid so that the stitchline falls between two prominent vertical stripes.

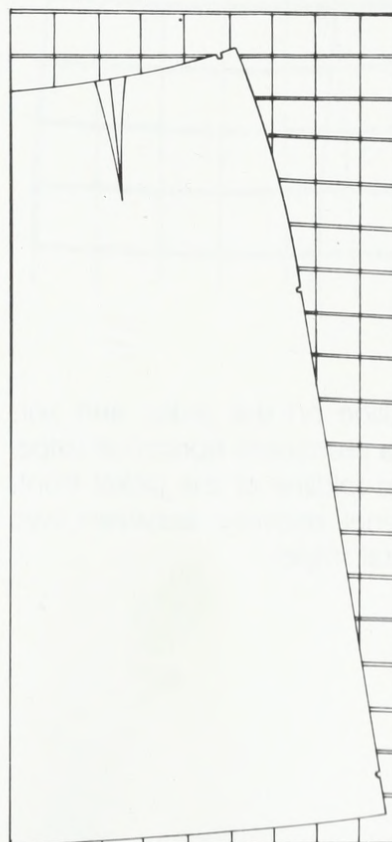
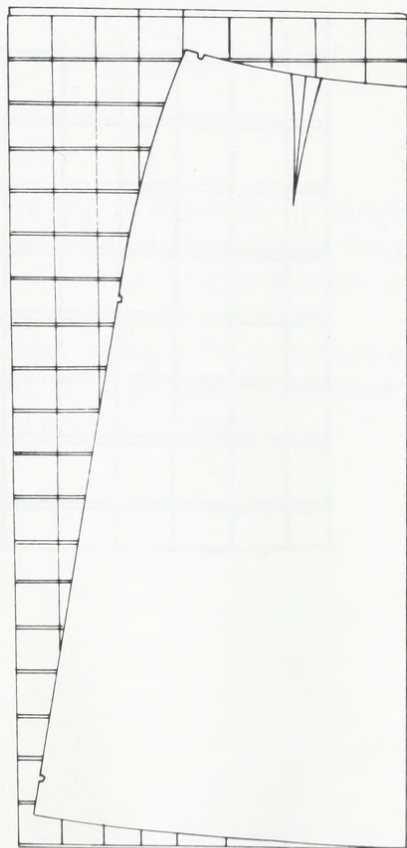
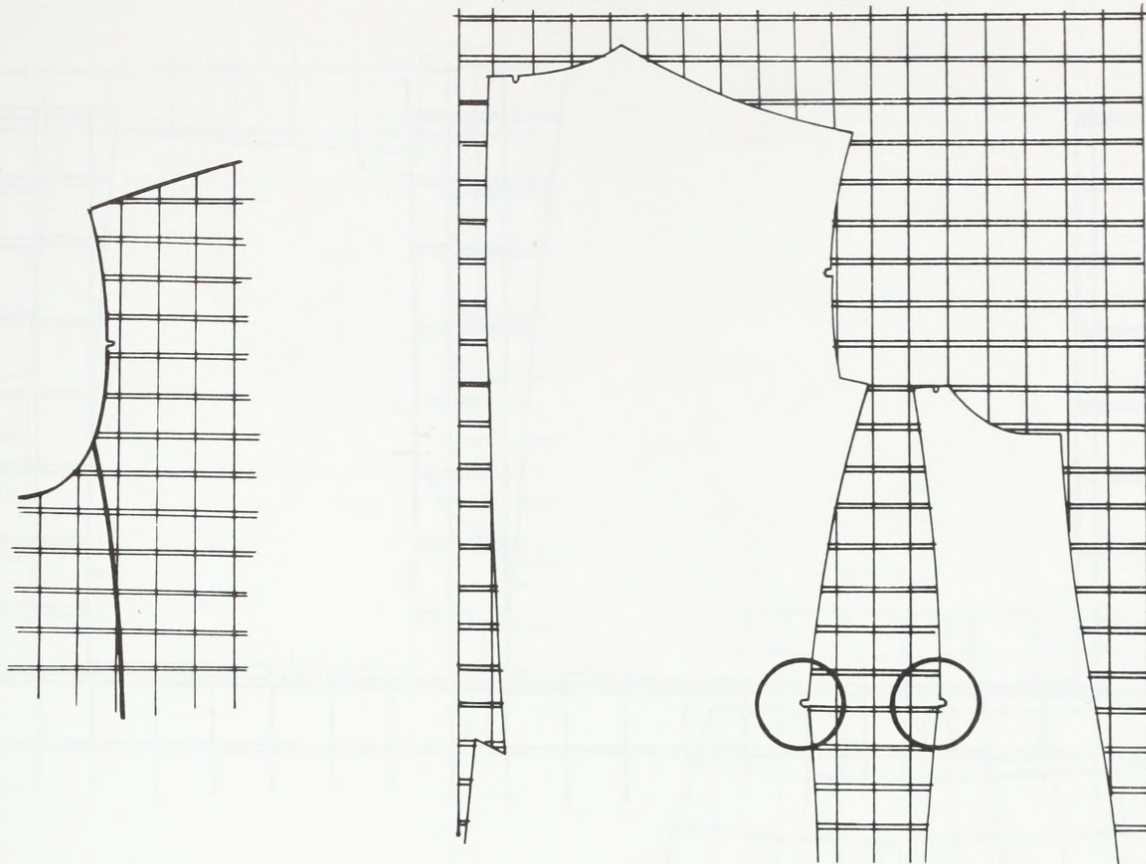

All horizontal bars in a plaid must match at the seamlines.

Place the notches of all seams, which will be joined, at identical points on the plaid design.

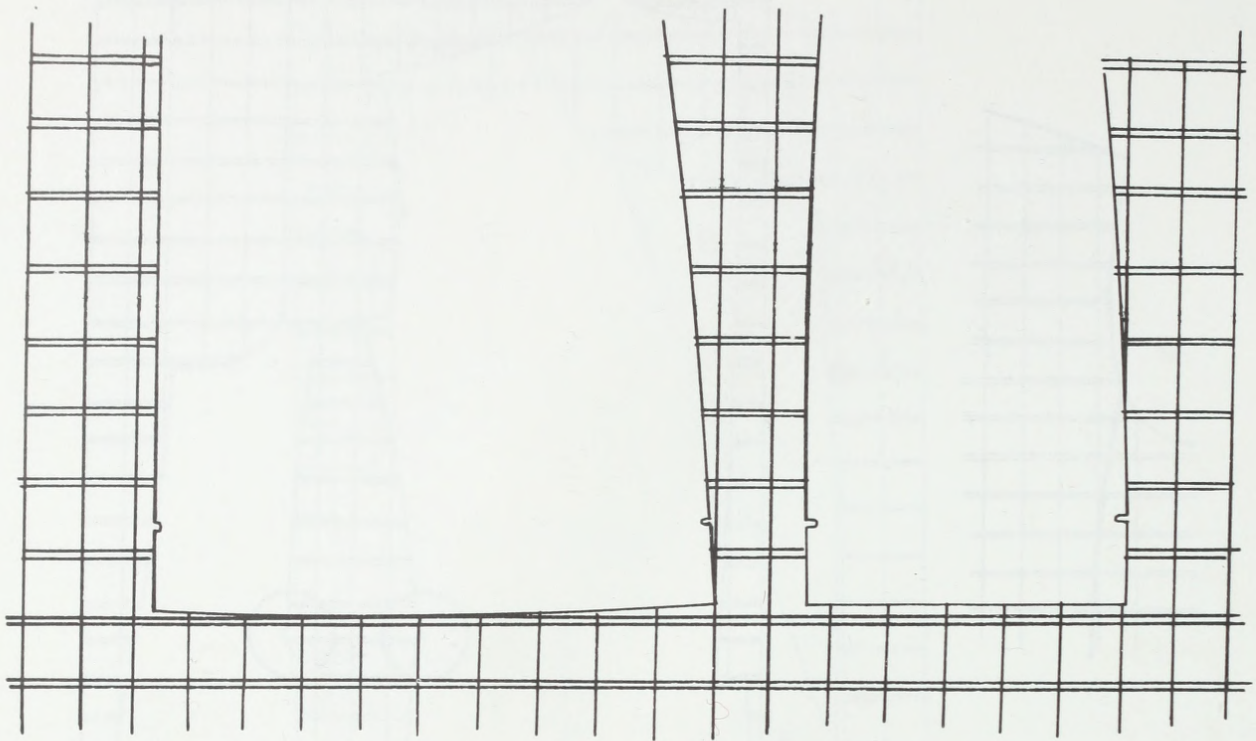

The hem foldline on the jacket and skirt should not fall on a prominent horizontal stripe. Place the hem foldline of the jacket front, back and side panel midway between two prominent horizontal stripes.

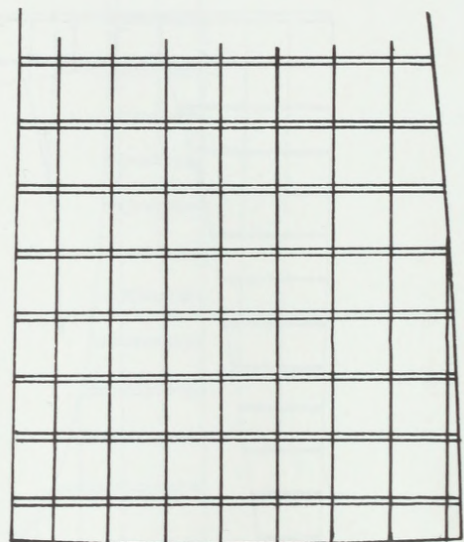

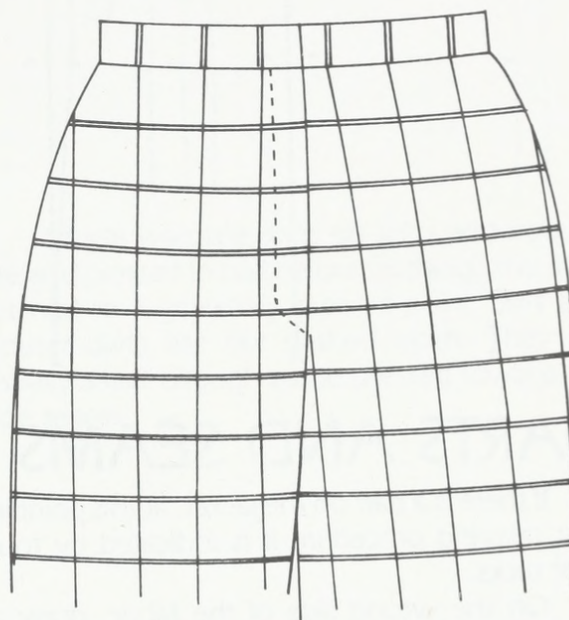
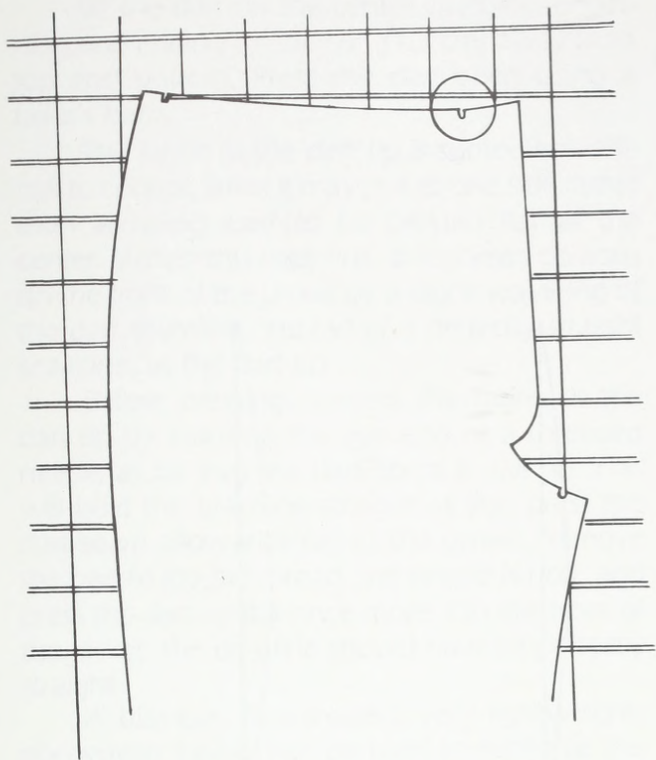

The fold at the top of the pants fly should be between two prominent vertical stripes. Place the notch at the center front waistline between two prominent vertical stripes.

The information needed for constructing pockets on a plaid or stripe fabric is discussed with the individual pocket directions.

6 Jackets

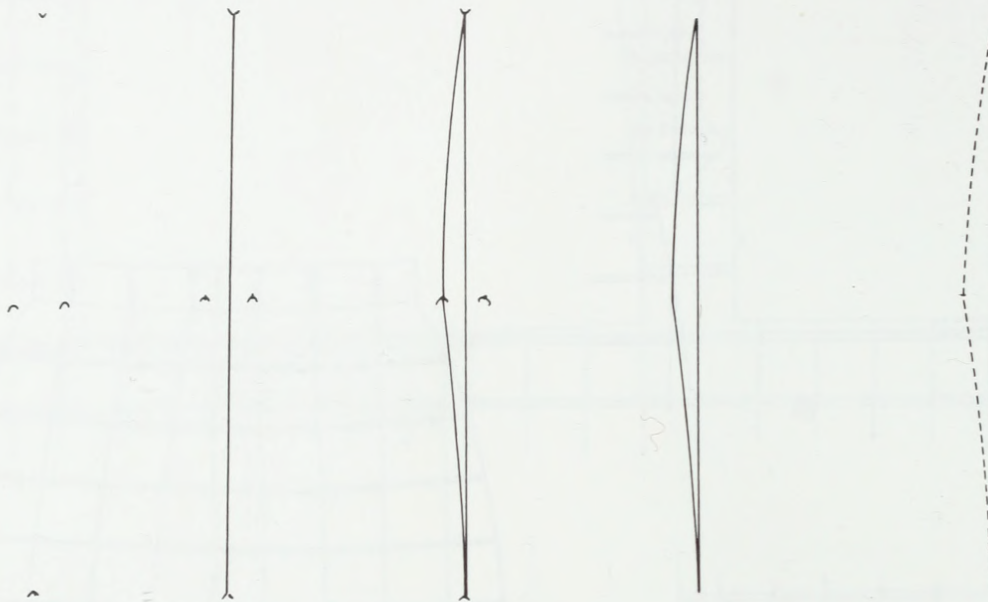

DARTS AND SEAMS

If there is a dart on the jacket, at this point in your tailoring procedure it is indicated by four tailor tacks.

On the wrong side of the fabric, draw a chalkline from top to bottom at the center of the dart.

On one side of the dart, draw a slightly curved line from the top of the dart to waist, and from waist to bottom of the dart. Use the hip curve to taper line gradually into the dart ends. An abrupt curve at the dart ends will create puckering on the right side of the fabric which will be impossible to press out.

Remove the tailor tacks and press the dart in half, using the center chalkline as foldline.

Machine stitch the dart from top to bottom. Sewing the fabric in the direction of the nap is an added courtesy to the fabric. In velvet or pile fabrics, it is an absolute necessity.

It is better to tie the threads at the dart ends, rather than backstitching to tack. Backstitching adds unwanted bulk and stiffness into the delicately thin area of the dart tips.

Slit the dart on the center chalkline, beginning and ending the slit $\frac{1}{2}$ " (1.3 cm) away from top and bottom. Press the dart open using a tailor's ham.

The fabric at the dart tip is somewhat difficult to control, since it may pull to one side rather than allowing itself to be pressed flat at the center. When this happens, it becomes obvious on the front of the jacket by a slight wavering of the dart seamline, instead of a perfectly straight seamline, at the dart tip.

Before pressing, control the fabric at the dart tip by inserting the eye end of a threaded needle as far into the dart tip as it will go. This will hold the seamline straight as you press the dart seam allowance flat in the center. Remove the needle (by the thread, the needle is hot), and press the dart tip flat once more. On the front of the jacket, the dart line should now be perfectly straight.

A bias-cut, oval-shaped, very lightweight, nonwoven fusible can be used to reinforce the dart tip and maintain the fabric's body in this area. Use only a fusible which presents no competition in weight with the garment fabric. Try a sample on a fabric scrap. If there is any indication of the fusible from the right side of the fabric, it is too heavy. If in doubt, leave it out.

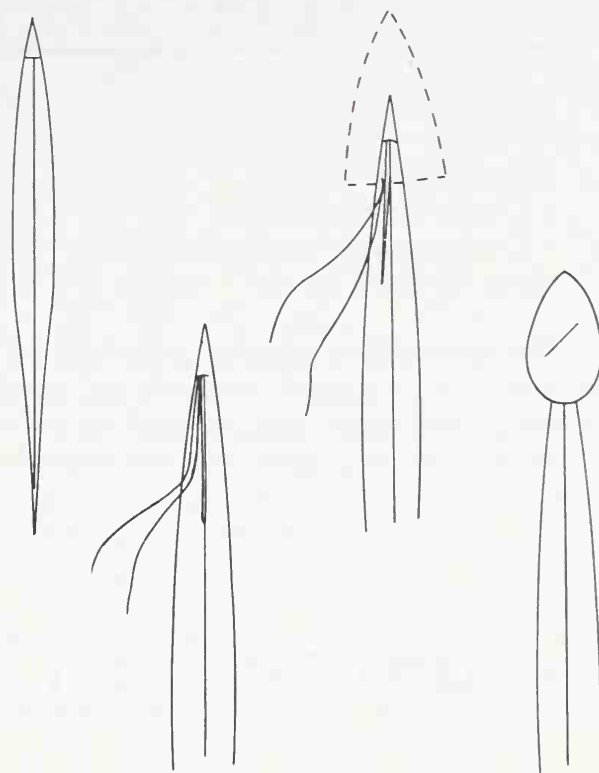

Simple waistline darts on skirts and trousers are also pressed in half before stitching, and then stitched to a gracefully tapered point. Skirt and trouser darts are *not* slashed open. They are usually small enough to be pressed toward the side seams.

Baste and sew your side panel to the jacket front, matching notches, and press the seam open. If the jacket has significant waistline shaping, there will be some constriction in the waistline area at the seam. Stretch the seam allowance in the waistline area by steam pressing it into a curve opposite to its shape. When the seam allowance is then pressed open, the constriction will have been relieved.

Slashing the seam allowance at the waist to relieve this tightness weakens the garment unnecessarily in this area, and it's always wise to keep seam allowances in tact for possible future alterations.

Gently press the jacket front from the wrong side. You are now ready for the construction of the jacket pockets.

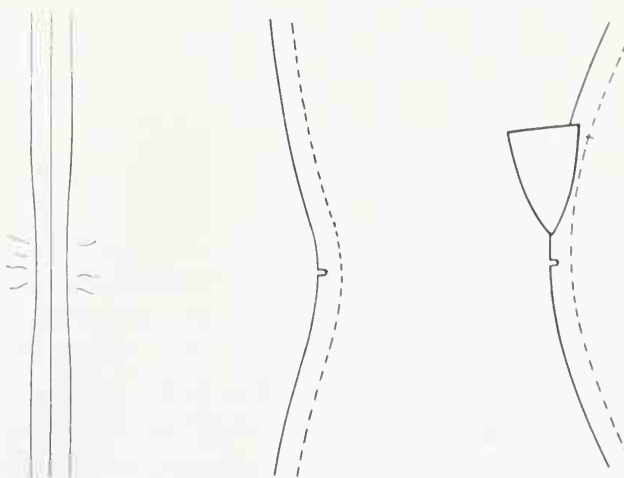

THE JACKET POCKETS

The most popular types of jacket pockets are:

- Welt Pocket
- Double-Piping Pocket
- Double-Piping Pocket with Flap
- Patch Pocket

The construction of these pockets is presented here in great detail. Therefore, you need not limit yourself to the style of the pocket given on your commercial pattern. Feel free to substi-

tute a double-piping pocket for a patch pocket, or to add a flap if you wish.

The perfection of the pocket construction says much about the skill of the tailor. Because of the prominent position of the pockets on the front of the jacket, any distortion in the pocket line will call attention to itself, and detract from the overall beauty of the jacket. We suggest that you practice the pocket construction on a fabric scrap before constructing them in your jacket fabric.

THE WELT POCKET

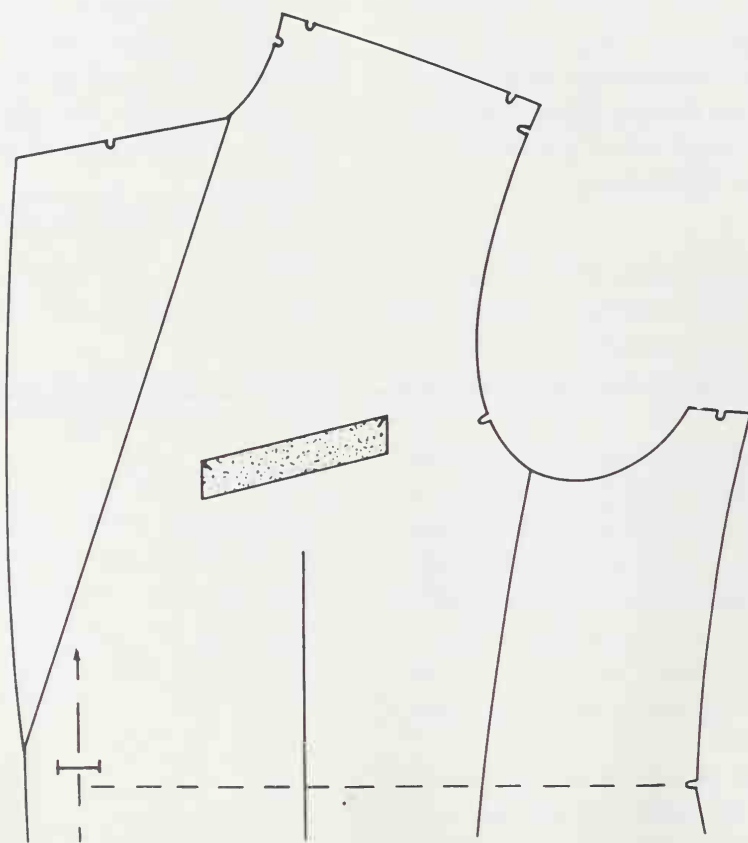

The breast welt pocket is $4\frac{1}{4}$ " (10.8 cm) long and about 1" (2.5 cm) wide, placed on the left side of the jacket at approximately the level of the front sleeve notch. The placement line is usually on a $\frac{1}{2}$ " (1.3 cm) slant, lower right to upper left when the jacket is worn.

Chalkmark the placement line on the jacket front. If you have adjusted your pattern at the front armhole, check to see that the pocket placement line is at least $1\frac{1}{2}$ " (3.8 cm) away from the armhole stitchline.

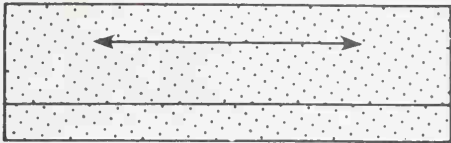

Cut a piece of woven fusible, on the cross-grain, $4\frac{1}{2}$ " (11.4 cm) by $1\frac{3}{8}$ " (3.5 cm). Draw a $\frac{3}{8}$ " (1 cm) margin along the bottom edge on the unglued side. This line will eventually be the stitchline for attaching the welt to the jacket.

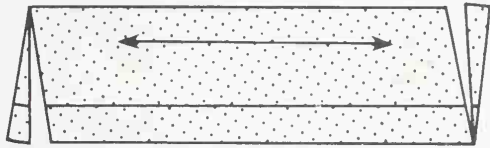

Trim away $\frac{1}{4}$ " (6 mm) diagonals from the upper right and lower left of the rectangle. This will create the slant for the welt.

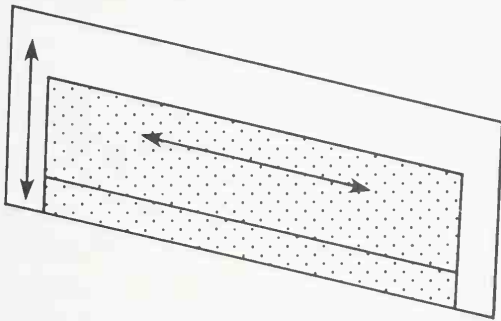

Press the fusible to the wrong side of a piece of the garment fabric, leaving $\frac{3}{8}$ " (1 cm) fabric at each side and $\frac{3}{4}$ " (1.9 cm) at the top. It is important that the side of the fusible be parallel with the straight grain of the garment fabric, and that the nap be down.

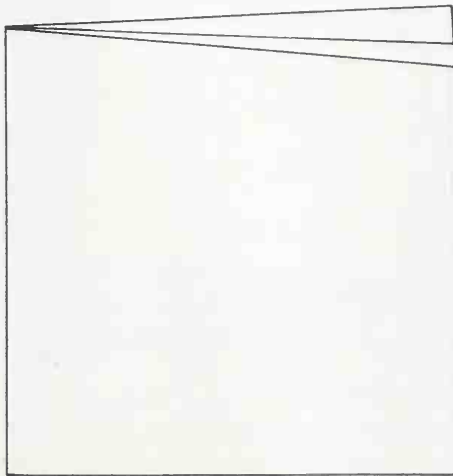

Cut two pieces of pocketing, 6" (15.2 cm) by 6" (15.2 cm) on the straight grain, and cut a $\frac{1}{2}$ " (1.3 cm) diagonal off the top of each piece.

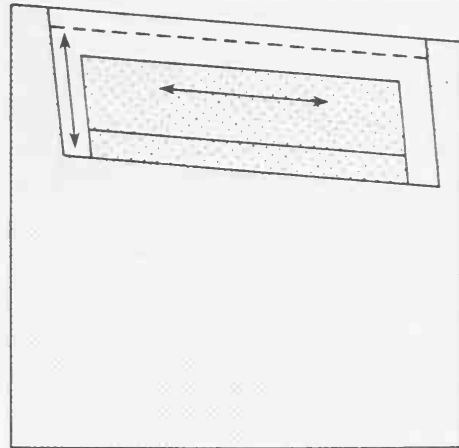

Use a $\frac{1}{4}$ " (6 mm) seam to sew the top edge of the garment fabric to the top of the pocketing, and press the seam open.

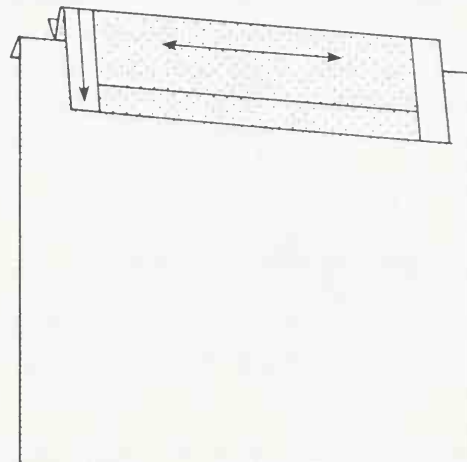

Fold the garment fabric, using the top edge of the fusible as a guideline.

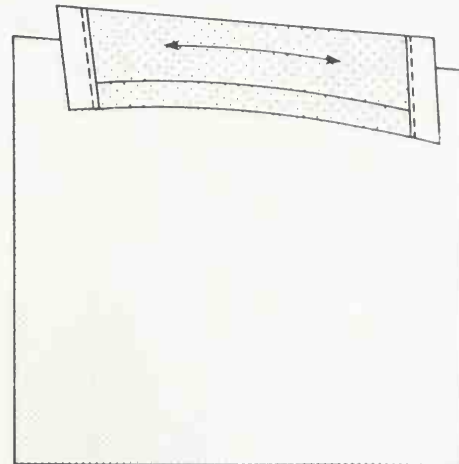

At either end of the fusible, baste the welt to the pocketing, easing the welt slightly towards the center. This easing creates a slight bulge in the welt, which will ensure that the pocketing edges will be hidden when the welt is turned to the right side.

Machine-stitch just beyond the edge of the fusible. Tack the top, but not the bottom of each stitchline.

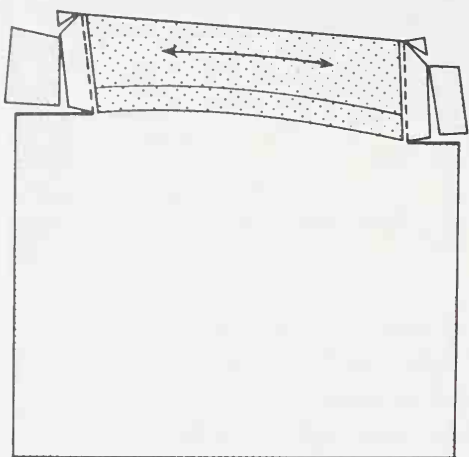

Slash the pocket to the bottom of the stitchlines. Trim the seam allowances to $\frac{1}{4}$ " (6 mm) and trim the top corners.

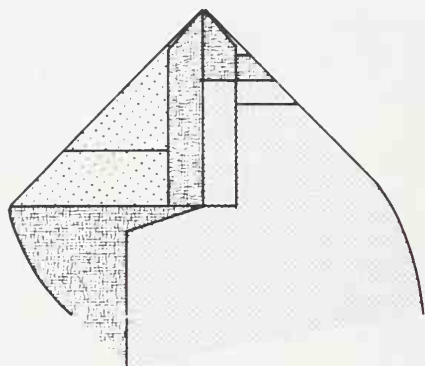

Press the seams open and turn the welt to the right side.

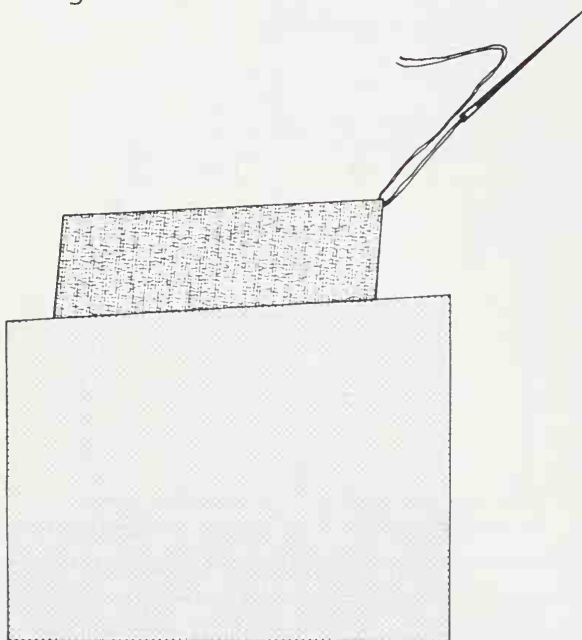

To assist in turning the corners, take one stitch and gently pull both ends of the thread. This is a safer procedure than poking the corners from the inside with the point of the scissors. Press the welt on the right side.

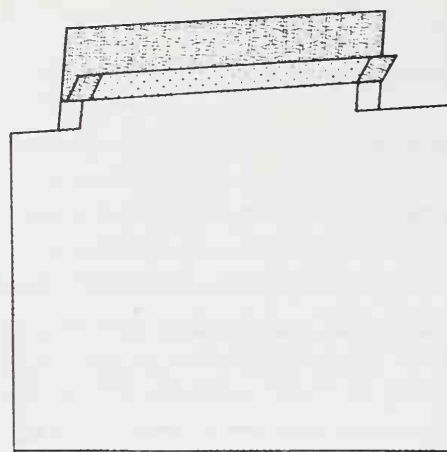

Carefully open the welt seam just enough to expose the stitchline which is drawn on the fusible.

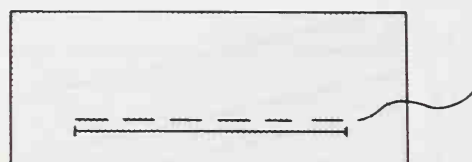

Cut a piece of pocketing 2" (5 cm) by 6" (15.2 cm) on the straight grain, and place it on the wrong side of the jacket. The lower edge of the pocketing should fall about $\frac{1}{2}$ " (1.3 cm) below the welt placement line which is drawn on the jacket front. Baste or pin the pocketing in place. This piece of pocketing is called a *reinforcement* since its purpose is to strengthen the fabric in the area in which we will be working.

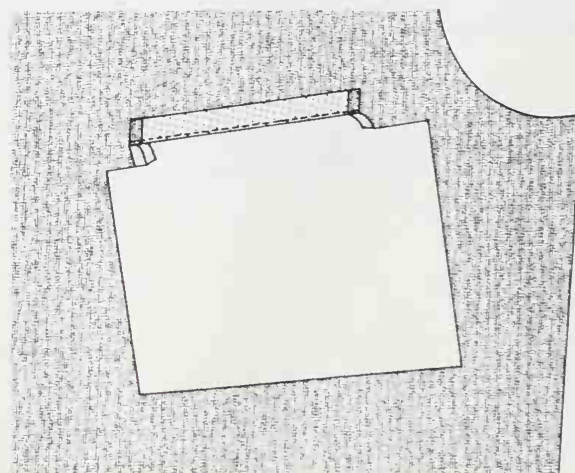

Place the welt face down on the jacket front, matching the stitchline which is drawn on the fusible with the placement line drawn on the jacket. Don't be concerned if you notice that the welt is upside down at this point; it should be.

Baste, and then machine stitch the welt to the jacket, tacking well at either end.

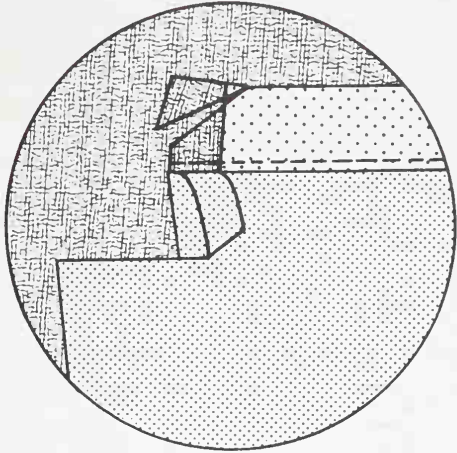

Trim corners of the welt seam allowance.

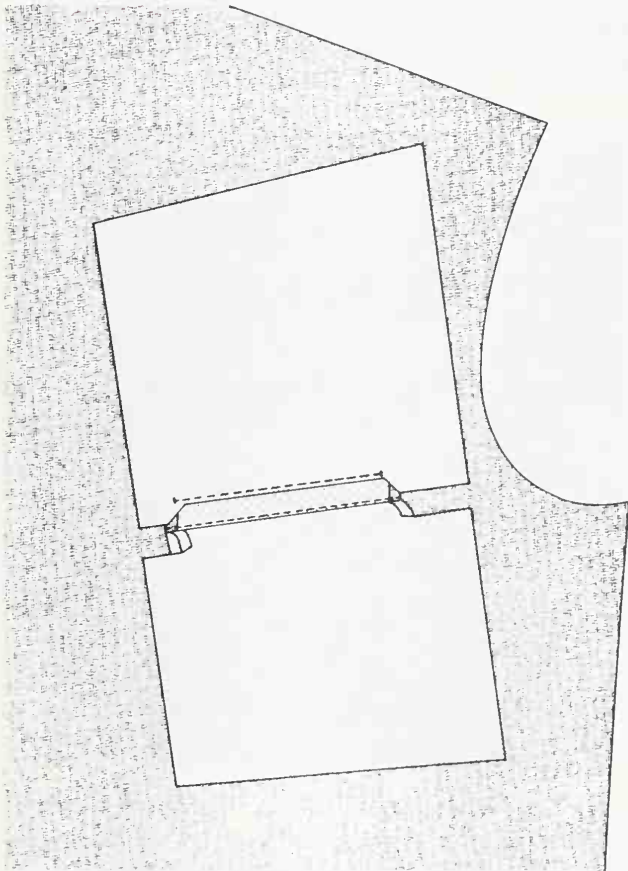

Insert the second piece of pocketing under the welt seam allowance and stitch on the pocketing, very close to the welt seam allowance. This stitchline should be about $\frac{3}{8}$ " (1 cm) shorter than the welt stitchline at either end. Tack well at either end.

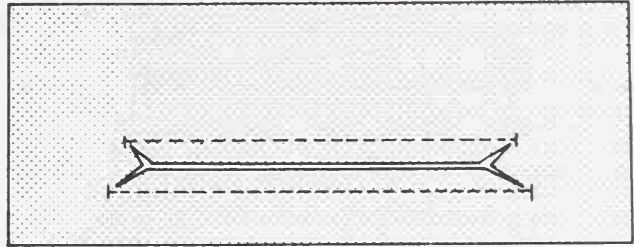

From the wrong side of the jacket the two stitchlines will be clearly visible on the reinforcement. Begin at the center and slash through the reinforcement and the jacket fabric, directly between the two stitchlines. While you are cutting, hold the welt seam allowance and the pocketing safely out of the way. Cut prongs about $\frac{3}{8}$ " (1 cm) long at each end. Slash very close to the last stitch on each line, *but* not close enough to cut the threads. Cutting the prongs correctly is a simple, but essential step in the construction of a perfect pocket.



If the prongs, especially at the bottom, are not snipped directly to the last stitch, your pocket corners will pucker.

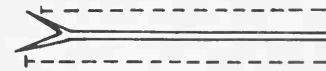

If, however, the cut overshoots the last stitch, you will have a hole on the front of your jacket at the ends of the pocket. Avoid any puckers and holes by simply giving this step your full attention.

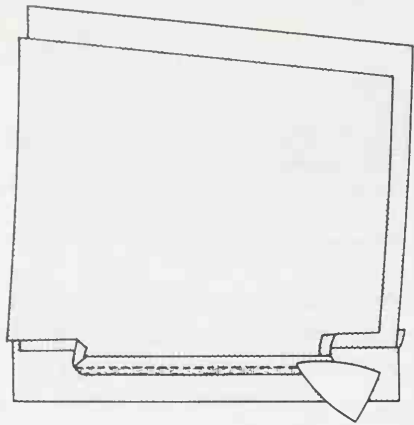

Reach through the opening and pull the pocketing to the wrong side. Press open the seam that attaches the welt to the jacket.

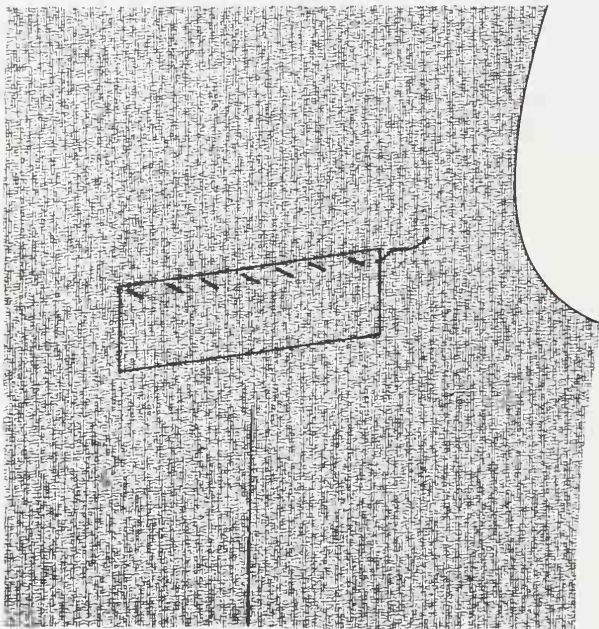

On the front of the jacket, the welt should now be sitting upright. Baste the pocket closed.

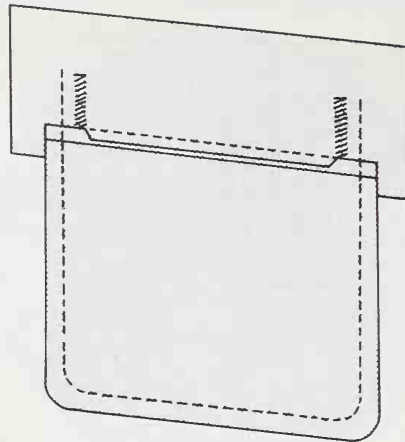

The sides of the welt are attached to the jacket by a diagonal handstitch from the wrong side. The stitches should not be visible on the outside. Machine-stitch the pocketing pieces together, and trim the seam allowance. Do not trim the reinforcement piece. It will be used later for attachment to the canvas.

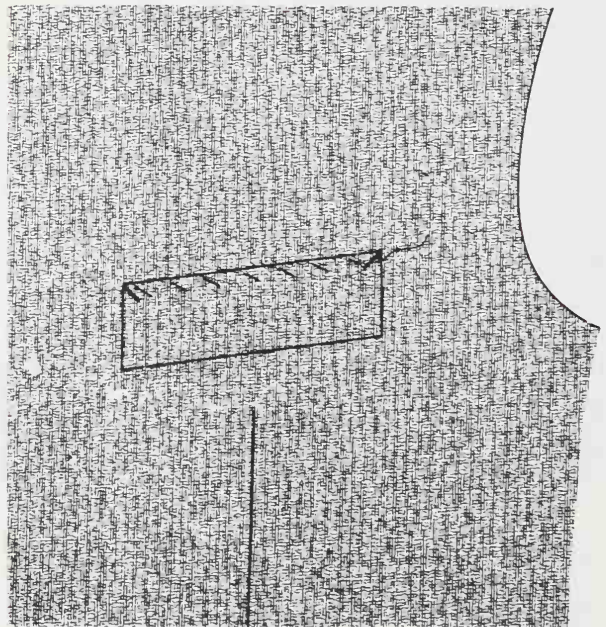

You may wish to add a decorative bartack at either end of the top of the welt. If you wax the buttonhole twist and press it between two pieces of paper, the wax will melt into the thread and give it a better body. Take one stitch at either end of the welt, and anchor the stitch on the inside. The welt pocket is complete.

WELT POCKET (PLAIDS/STRIPES)

Because there are no darts or seams in the area of the breast welt pocket, the plaid or stripe should be able to run uninterrupted from the jacket, through the welt, both vertically and horizontally.

The best way to guarantee an accurate match of fabric is to draw the plaid design on the fusible, during the construction of the welt (page 78).

Place the trimmed fusible, glue side up, on the jacket front, with the welt stitchline at the pocket placement line. Draw the plaid design lines on the edges of the fusible.

Place the marked fusible, glue side down, on the wrong side of a piece of garment fabric, matching the plaid. Be sure to match the plaid at the sides of the welt, as well as at top and bottom.

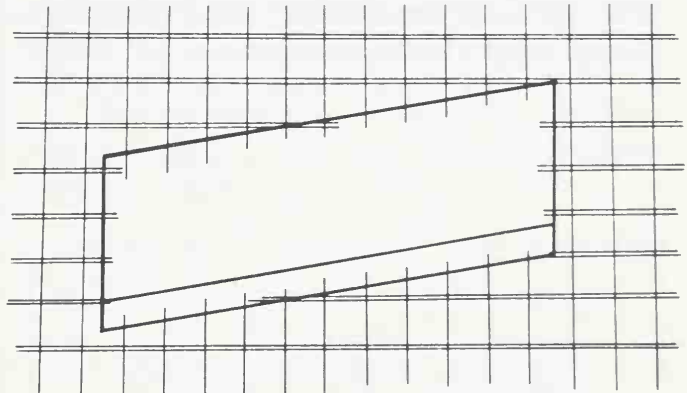
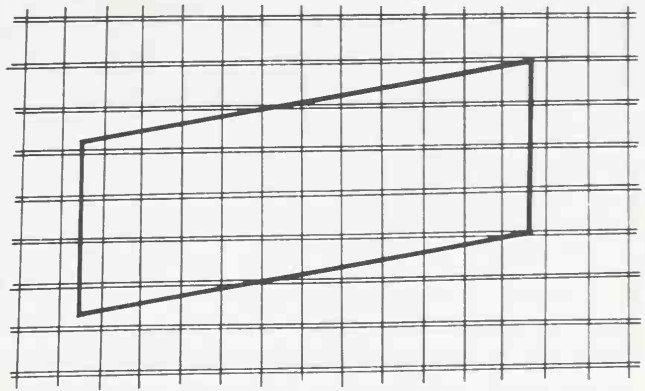

Press the fusible in place on the garment fabric, and continue construction of the welt pocket as previously discussed.

THE DOUBLE-PIPING POCKET

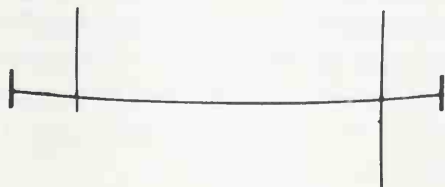

The double-piping pocket on a woman's jacket is approximately $5\frac{1}{2}$ " (14 cm) to $5\frac{3}{4}$ " (14.6 cm) long. The visible piping is $\frac{1}{4}$ " (6 mm) at top and bottom.

Draw the pocket placement line on the jacket front using the hip curve. A slight curve, less than $\frac{1}{8}$ " (3 mm) deep at center, will be almost imperceptible in the finished pocket, but will help prevent the pocket from gaping open when not in use. Remove the tailor tacks at either end of the pocket placement line and chalkmark the ends.

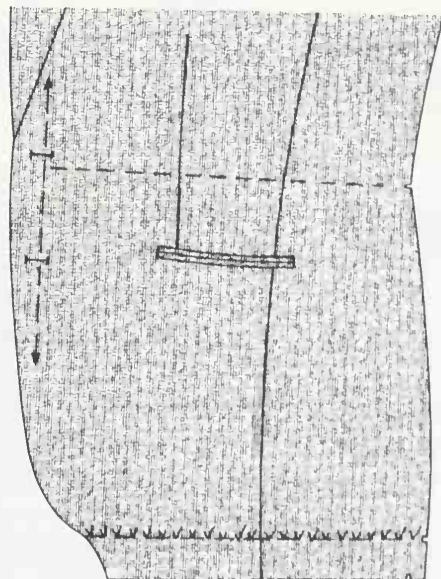

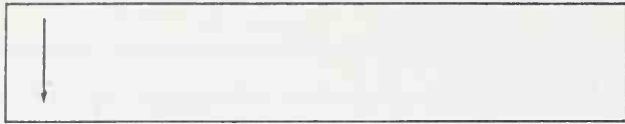

For each pocket cut two pieces of garment fabric to be used as piping; one 8" (20.3 cm) by 1 1/2" (3.8 cm), the other 8" (20.3 cm) by 2" (5 cm), straight grain, nap down.

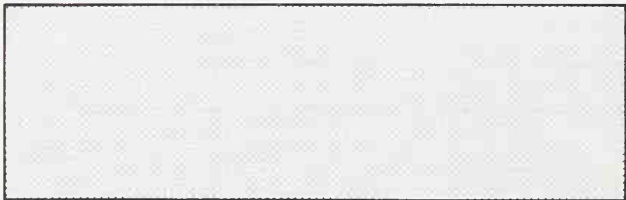

Cut a piece of pocketing to be used as reinforcement, 8" by 2 1/2" (20.3 by 6.4 cm), straight grain. On the wrong side of the fabric, center the reinforcement along the pocket placement line. Baste or pin in place.

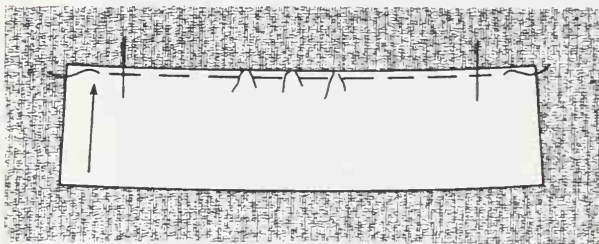

Place the wider piece of piping face down on the jacket front, nap up. The top edge of the piping should be flush with the placement line. Baste very close to the edge, catching the piping, the jacket, and the reinforcement. Because the placement line is on a slight curve, some rippling will appear at the center of the piping. Chalkmark on the piping, indicating either end of the pocket placement line.

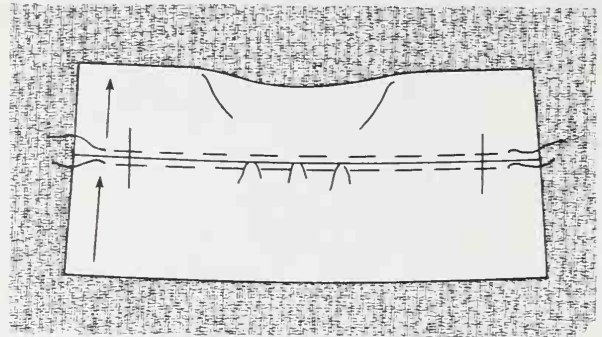

Place the second piece of piping face down on the jacket front, nap up, the edges of both pieces of piping touching. Baste very close to the edge.

Chalkmark on the top piping, indicating either end of the pocket placement line.

Steam press the piping on a flat surface to eliminate the rippling in the piping.

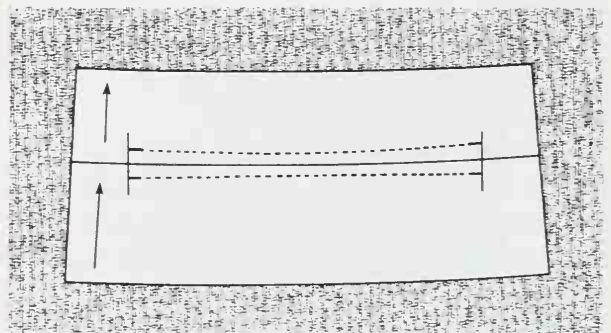

Machine-stitch the piping to the jacket 1/4" (6 mm) above and below the placement line. These stitchlines should not be exactly parallel. The center of each stitchline should be slightly closer to the placement line than the ends are. Refer to the illustration as your guide for what we mean by "slightly." This contour of the line will not be visible in the finished pocket, and will help prevent the pocket from gaping open when not in use.

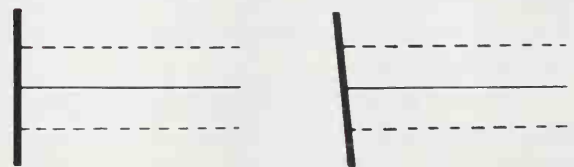

It is very important that the ends of the two stitchlines be directly aligned. If they are not, the sides of the finished pocket will slant rather than stand straight, and the whole effect will be unprofessional.

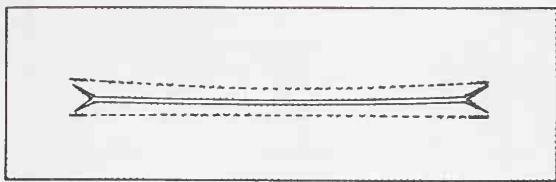

Working on the wrong side of the jacket, begin at the center and slash through the reinforcement and the garment fabric. Be careful to hold back the piping so that it is not snipped in the process.

Cut $\frac{3}{8}$ " (1 cm) prongs at either end of the slash, snipping as close as possible to the last stitch in either line. *It is very important to slash correctly here.*



If the prong is not snipped up to the last stitch, there will be puckering on the right side of the jacket at either end of the pocket.



If, on the other hand, the slash overshoots the last stitch, you will have a hole on the front of your jacket at the ends of the pocket. Avoid the puckers and the hole by simply giving this step your full attention.

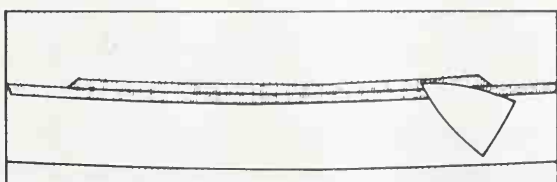

Pull the piping to the wrong side and press the seams open.

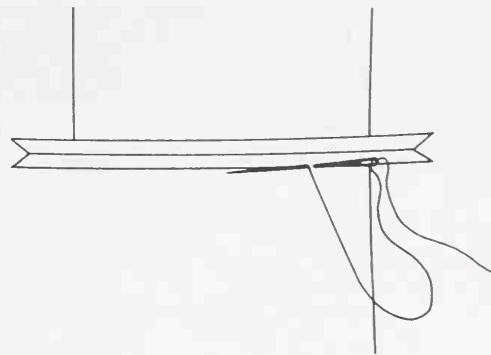

Using the seam allowance as a guide, and ignoring the prongs for the moment, backstitch by hand in the piping seam, using silk finishing thread. The piping must be kept even on top and bottom, and the stitches should not be seen.

The pocket is now steam pressed on the right side using a ham and covering the fabric with a presscloth.

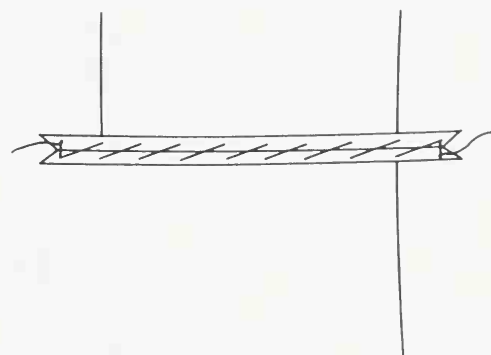

Whip-stitch the piping closed so that it will not shift while we attend to the prongs.

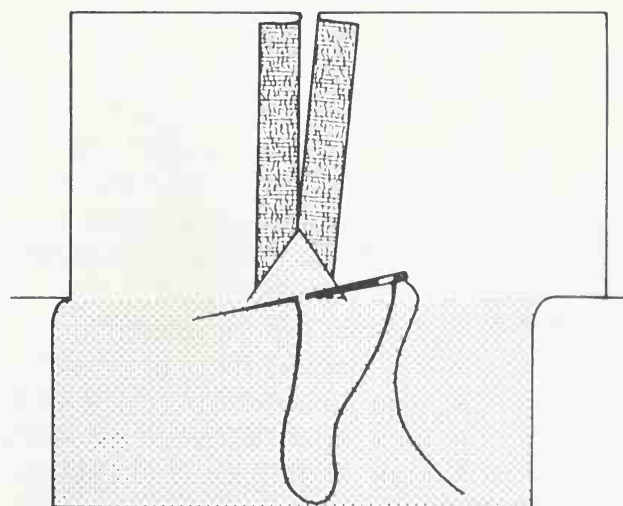

Push the prong to the wrong side and hold it so that the end of the pocket is a straight line, not a slanted one. Backstitch the prong to the piping by hand for complete control.

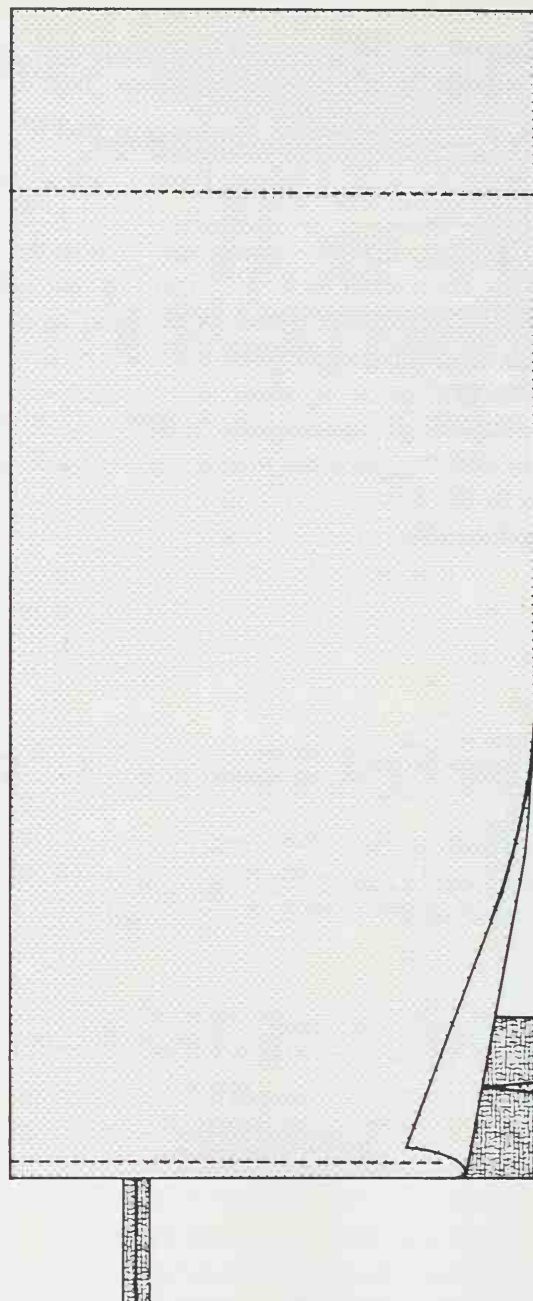
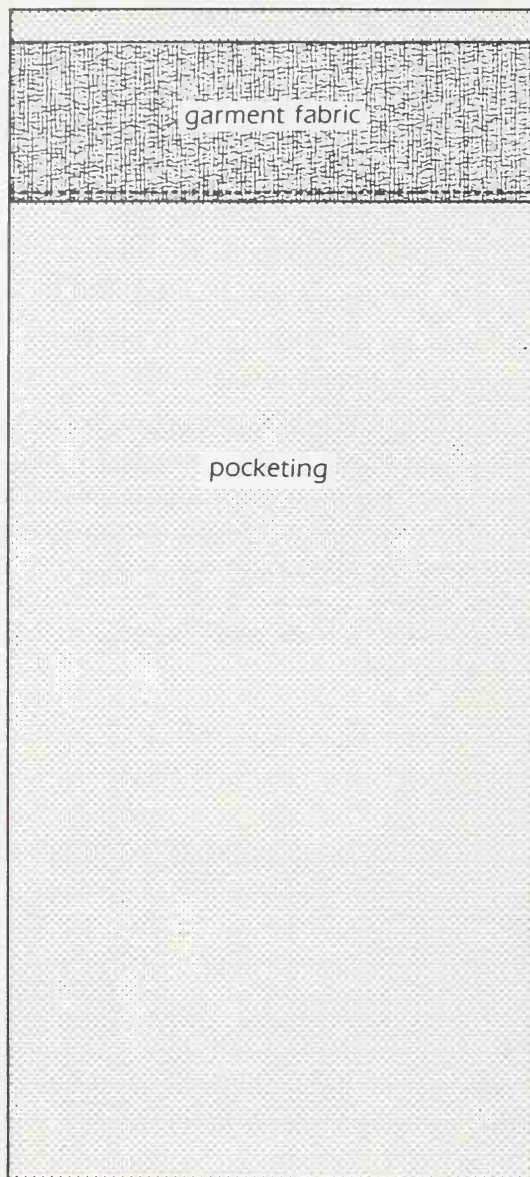

Cut a piece of pocketing, straight grain, 8" (20.3 cm) wide and 2" (5 cm) longer than twice the depth of the pocket. The pocket depth varies with the length of the jacket, but the pocketing should extend no lower than about 1" (2.5 cm) above the top of the finished jacket hem.

Cut a piece of garment fabric to be used as facing, straight grain, nap down, 2" (5 cm) by 8" (20.3 cm). Topstitch a folded edge of the facing to the top of the pocketing, leaving about 1/2" (1.3 cm) pocketing above the facing.

With the facing touching the wrong side of the jacket, sew the bottom edge of the pocketing to the edge of the bottom piping. Use a 1/4" (6 mm) seam.

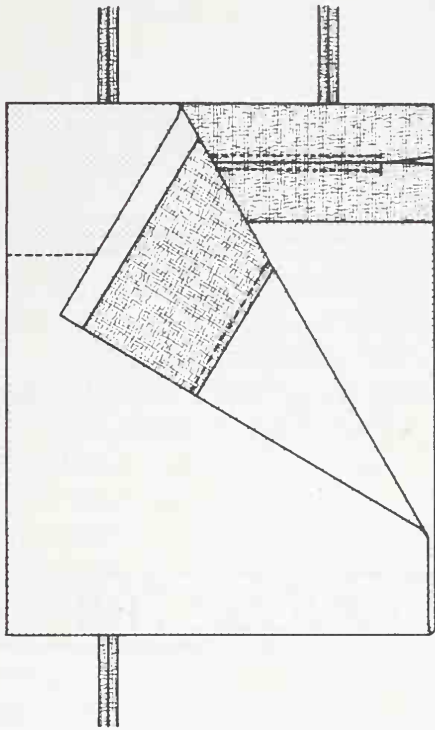

Pull the pocketing down and thumbnail press the fold. Match the top edges of the pocketing and the top piping.

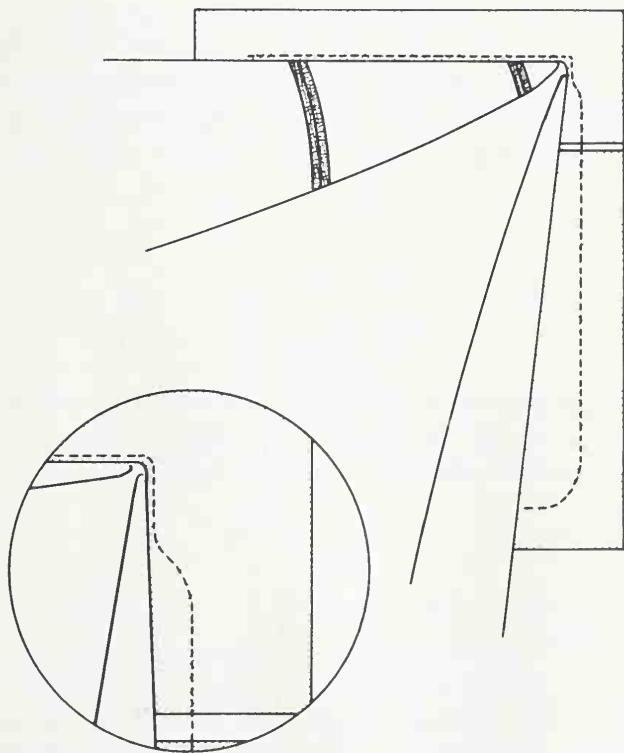

Machine-stitch on the reinforcement as close as possible to the garment fabric. Stitch the length of the pocket opening, pivot to catch the prong area, and continue out and around the pocketing.

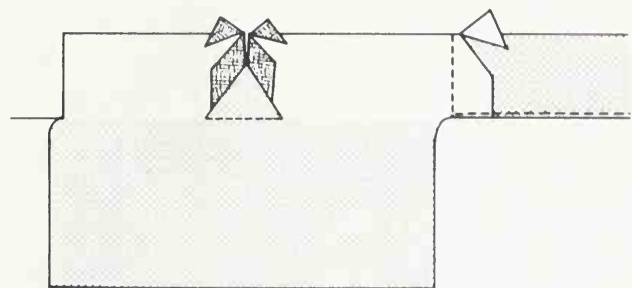
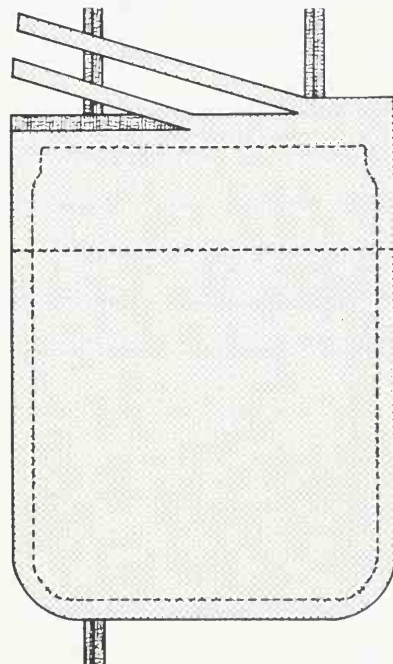
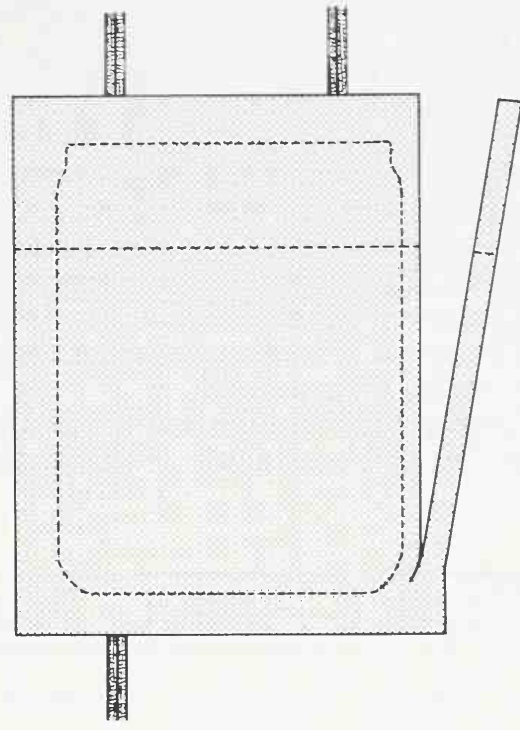

Trim the seam allowance, but not the reinforcement. Layer the fabric above the top stitchline, and snip away the excess fabric in the seam allowances to reduce the bulk.

If you wish, bartack one stitch at either end of the pocket, using silk buttonhole twist. If you wax the buttonhole twist and press it between two pieces of paper, the wax will melt into the twist and give it a better body.

The pocket remains basted closed until the jacket is ready to be worn.

Steam press the finished pocket on the right side of the fabric, using a ham and a presscloth.

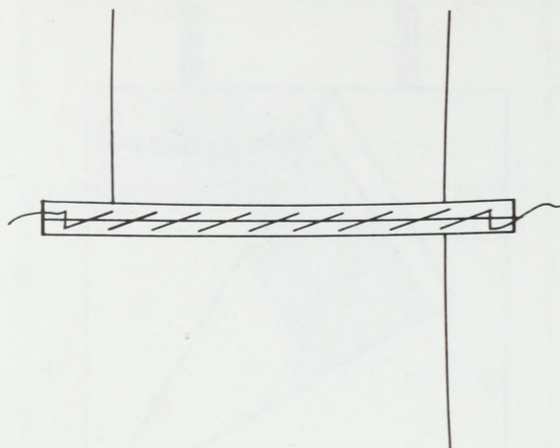

DOUBLE-PIPING POCKET (PLAIDS/STRIPES)

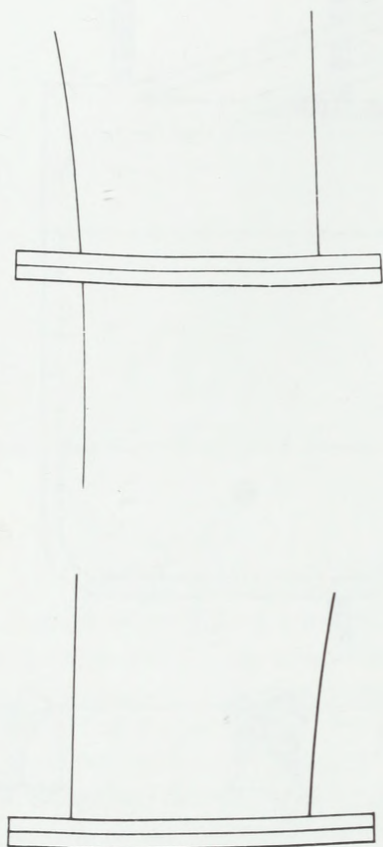

In almost all instances, two seams cut into the top of a hip-level, double-piping pocket—the front dart and the side panel seams. Depending on the pattern, either one seam or no seam will continue below the pocket.

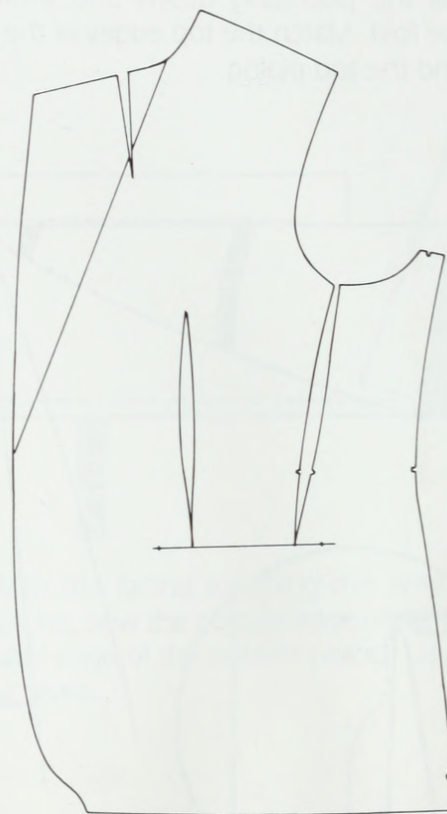

The best pattern to use for a plaid or striped fabric is one which eliminates the seam below the pocket by using a dart instead of a separate side panel. The plaid below the pocket is then undisturbed by seamlines. Above the pocket, you can't avoid seams if proper shaping is to be achieved.

In a striped fabric, cut the piping on the crossgrain and place it on the jacket so that the visible piping falls between the stripes, in the solid area of the fabric. Cutting the piping in this way avoids the question of matching a stripe on the piping with a stripe on the jacket.

On a plaid fabric, the vertical matching cannot be avoided. You can, however, cut the piping to eliminate any horizontal lines on the finished pocket.

Cut the piping on the straight grain, and match the plaid lines at the center of the pocket. The plaid on the jacket at the end of the pocket will have been slightly distorted by the darts. Simply match the piping at the center, and ignore the slight mismatch at the ends of the pocket. Even the most expensive custom-tailored plaid jackets are not matched at the end of the pocket.

We do not suggest cutting the piping on the bias. This would avoid the matching problem by introducing a completely different line, but it would also leave us with bias, stretchable piping which would cause the pocket to gape open.

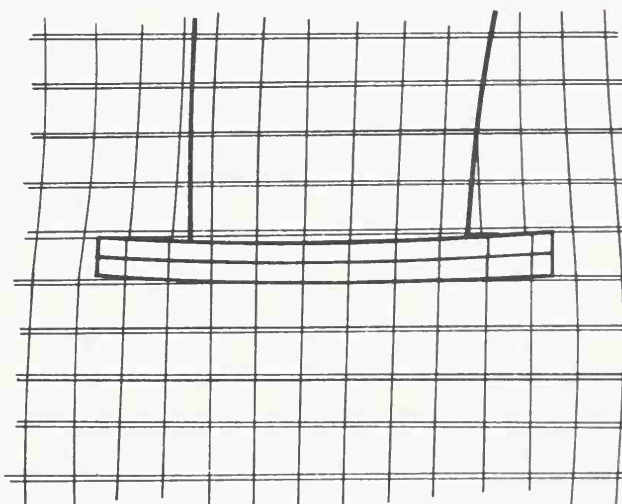
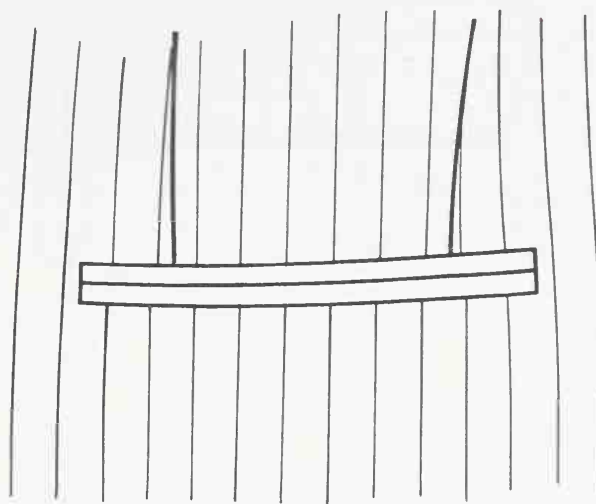

THE CASH POCKET

Once you are familiar with the construction of the double-piping pocket, it is simple to add, during construction, a smaller inner pocket, used most commonly for loose change—a *cash pocket*.

In addition to the fabric needed for the double-piping pocket, you will need a piece of pocketing, straight grain, 4" (10.2 cm) by 4½" (11.4 cm) by 4½" (11.4 cm), rounded slightly at the bottom edges.

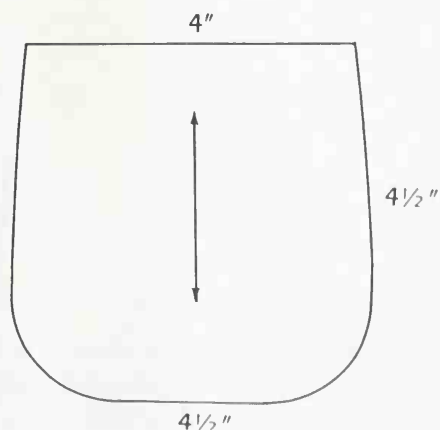

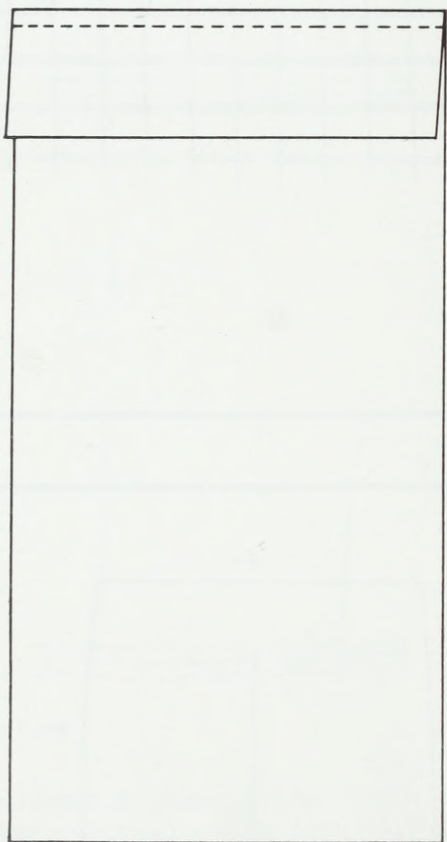
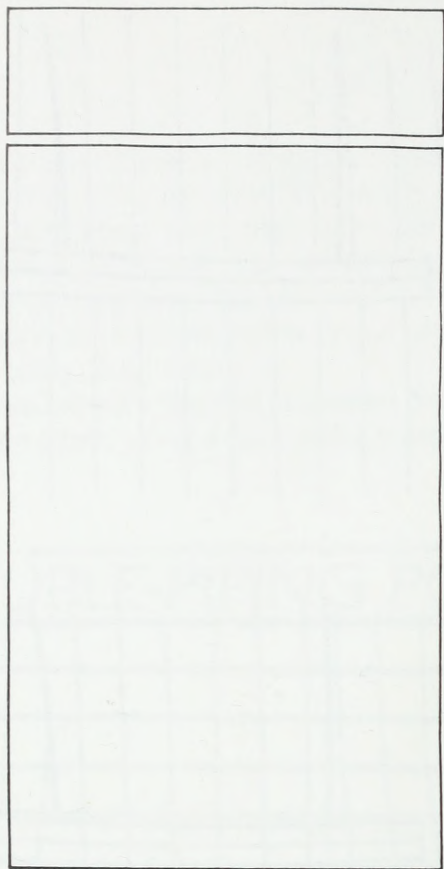

Cut about $2\frac{1}{2}$ " (6.4 cm) from the top of the main piece of pocketing, and then stitch the pieces together, using a $\frac{3}{8}$ " (1 cm) seam.

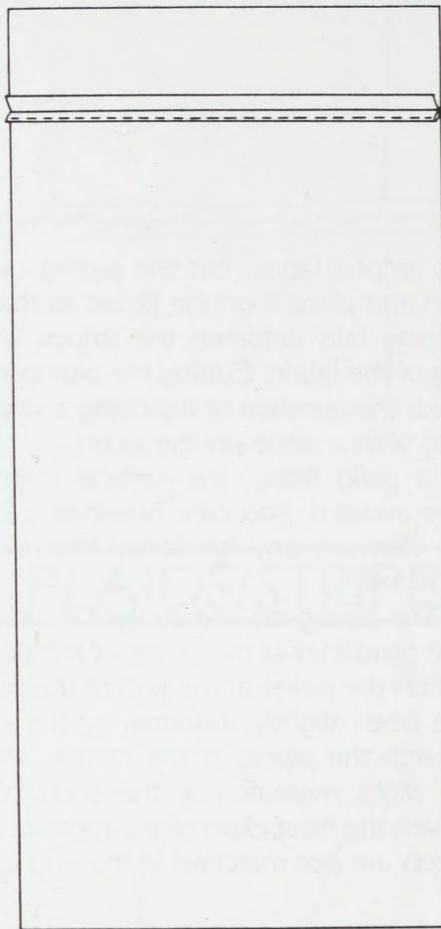

Press the seam open. Fold the bottom seam allowance under, and topstitch it in place.

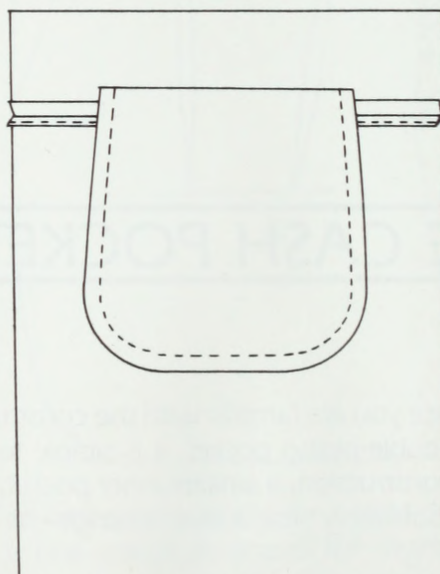

Place the cash pocket fabric on the wrong side of the pocketing, with the top edge of the cash pocket just above the top seam allowance. Stitch around the edge of the cash pocket using a $\frac{3}{8}$ " (1 cm) seam.

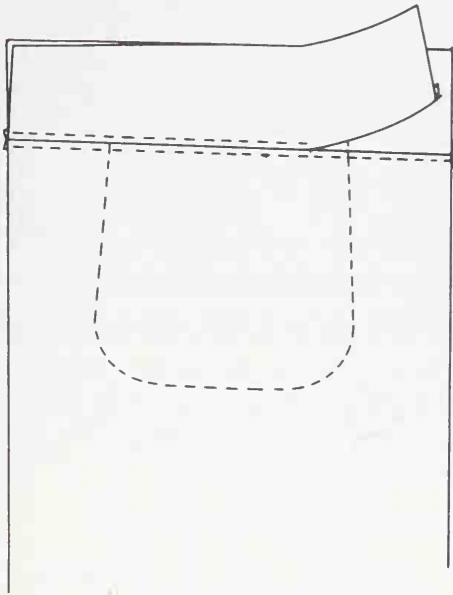

The garment fabric facing is now placed on the right side of the pocketing. Place the folded edge of the facing along the pocketing seamline, and topstitch the facing.

If there is a flap on the double-piping pocket you are making, there will be no facing. In this case, simply topstitch just above the seamline, holding the top seam allowance in place.

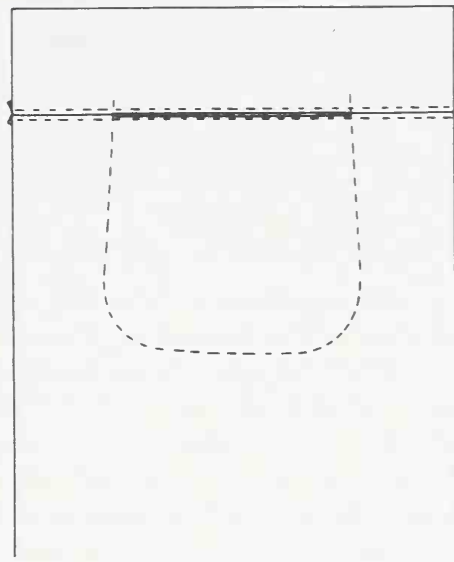

The seam at the top edge of the cash pocket is now snipped open to allow access, and the construction of the cash pocket is complete.

The construction of the double-piping pocket now continues.

THE DOUBLE-PIPING POCKET WITH FLAP

The flap added to the double-piping pocket is about 2 1/4" (5.7 cm) wide, finished. A flap which extends out slightly at the lower back edge compensates for the contour of the body and is more graceful than a perfect rectangle.

The top edge of the flap should be 1/8" (3 mm) larger (a slight 1/8") than the opening of the pocket into which it will be placed. The extra ease is taken by the body contour, and allows the flap to fall comfortably. It is easier to be accurate concerning the amount of ease in the flap if you make the flap first, and then the pocket.

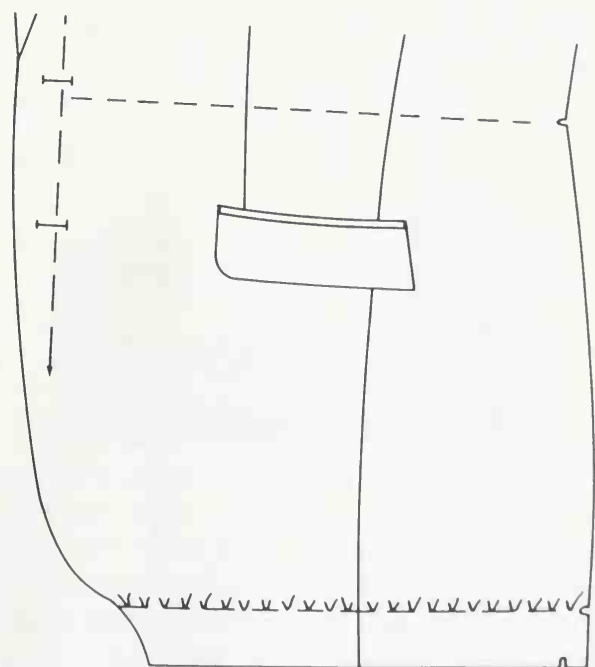

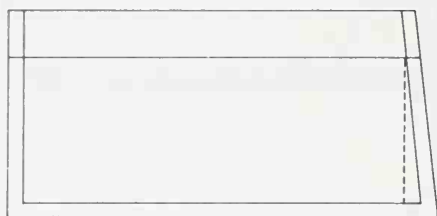

To make a pattern for the flap, draw a rectangle equal to the dimensions of the finished flap. For a 5½" (14 cm) pocket opening, this would be 5⅝" (14.3 cm) by 2¼" (5.7 cm). At the lower right corner, extend the rectangle by ¼" (6 mm). Add ¾" (1.9 cm) seam allowance at the top edge and ¼" (6 mm) around the three sides. Use this pattern to cut flaps from your garment fabric, straight grain, nap down.

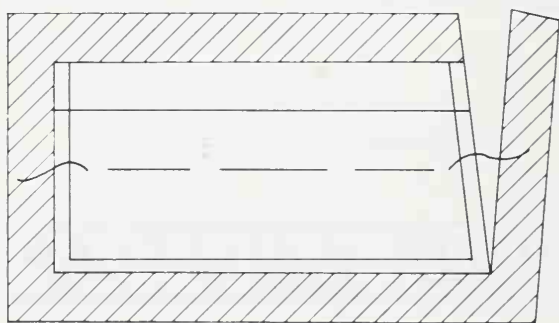

Baste the flap face down on the right side of a piece of lining, straight grain. Trim the lining even with the flap.

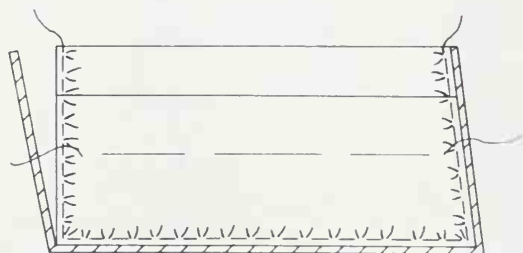

Baste around the flap close to the edge easing the garment fabric in from the lining about ⅛" (3 mm). This will make the lining slightly smaller than the flap, and will ensure that the lining will not show at the edges of the finished flap. Trim the excess lining.

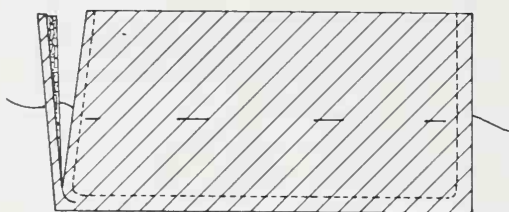

Machine stitch around the three sides using a ¼" (6 mm) seam allowance. Stitch from the lining side to avoid slippage. Trim the seam allowance to ⅛" (3 mm) and turn the flap to the right side.

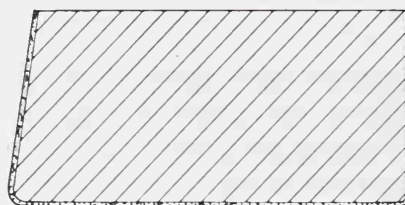

A thin border of garment fabric should be visible from the lining side.

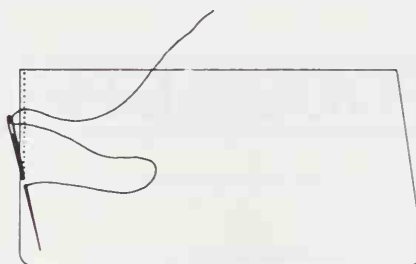

For a crisp finish, prick-stitch along the edge of the flap using silk finishing thread.

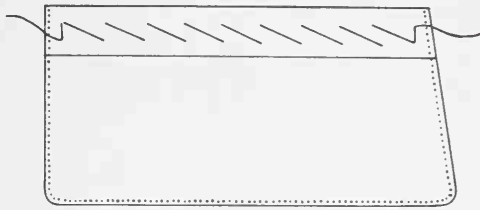

Press the flap from the right side, and baste across the top of the flap to hold the lining in place.

Measure up $2\frac{1}{4}$ " (5.7 cm) from the bottom of the flap and draw a chalkline. This is the guideline for inserting the flap into the pocket opening.

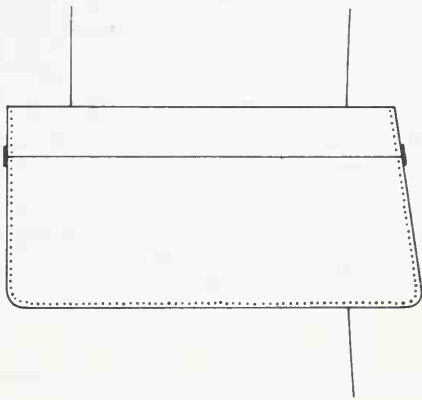

Place the flap on the jacket front. Match the chalkline on the flap to the pocket placement line on the jacket. Indicate the exact length of the flap by chalkmarking the jacket at either end of the flap.

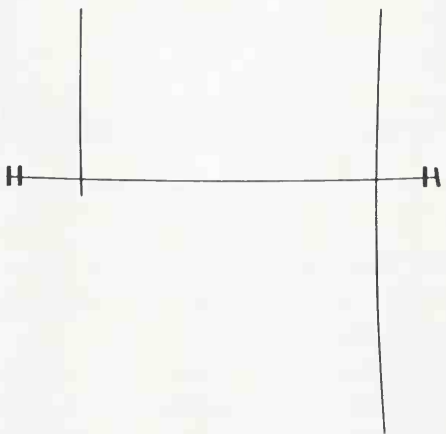

The pocket opening should be made $\frac{1}{8}$ " (3 mm) smaller than the flap. Therefore, chalkmark $\frac{1}{16}$ " (1.5 mm) in from either end of the pocket placement line. Take these measurements carefully. If the flap is more than $\frac{1}{8}$ " (3 mm) larger than the pocket opening, the finished effect will be puckered and quite unprofessional.

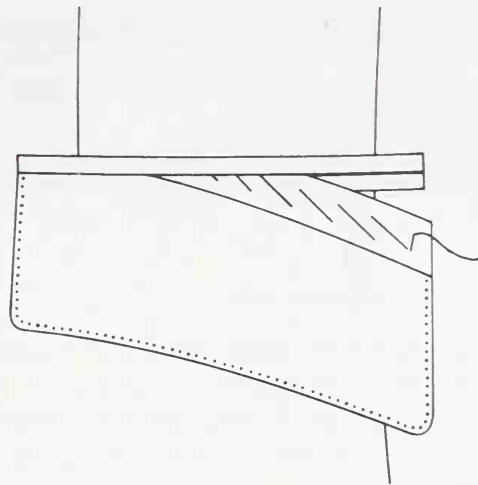

The double-piping pocket is now constructed according to the instructions given above. When the prongs have been secured to the piping (page 85), open the pocket and insert the flap, using the chalkline on the flap as a guide.

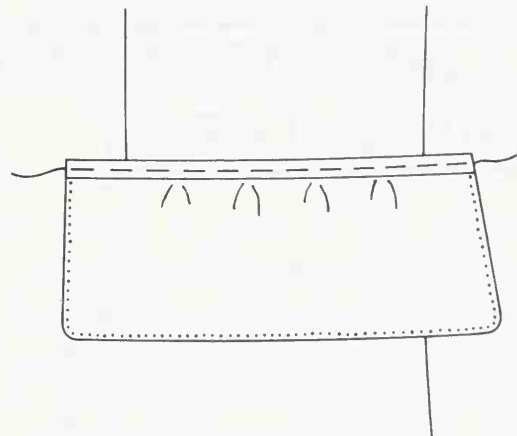

Baste through the top piping to hold the flap in place. The $\frac{1}{8}$ " (3 mm) ease in the flap should be drawn towards the center.

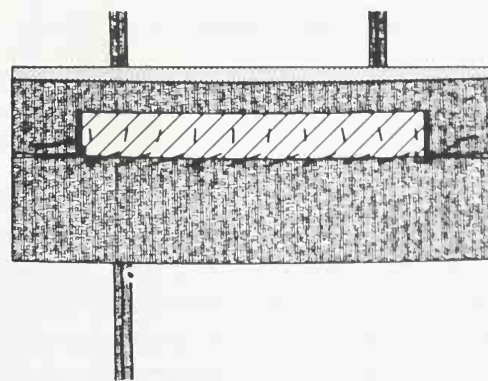

From the wrong side of the jacket, baste the pocket closed, catching one layer of the top piping through the flap.

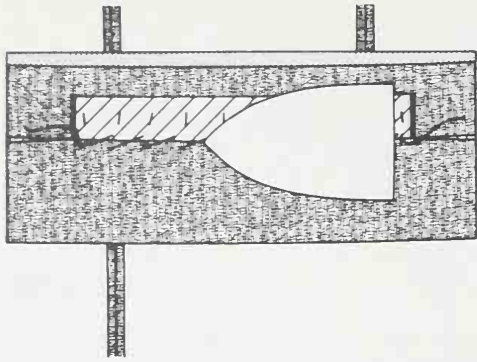

Using a ham, steam press the flap from the wrong side. The ripples at the top of the flap should disappear. If they do not, steam press once more, this time from the right side of the pocket.

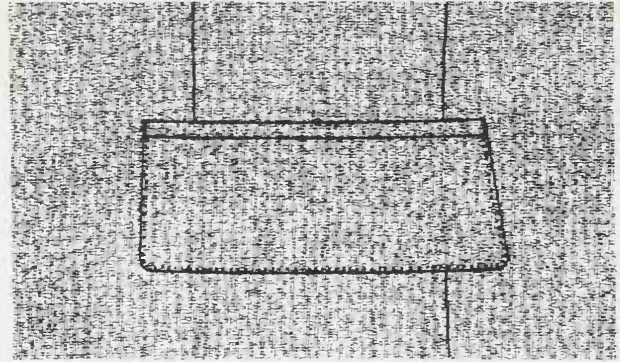

The inside of the pocket is completed according to the instructions for the double-piping pocket, with the exception of the facing. Since the flap covers the pocket opening, the garment fabric facing is not necessary at the top of the pocketing. It may be eliminated completely, or replaced by a less bulky facing of lining fabric.

When the pocketing is being machine stitched to the top piping (page 86), the flap is also caught, and thus attached to the garment.

DOUBLE-PIPING POCKET WITH FLAP (PLAIDS/STRIPES)

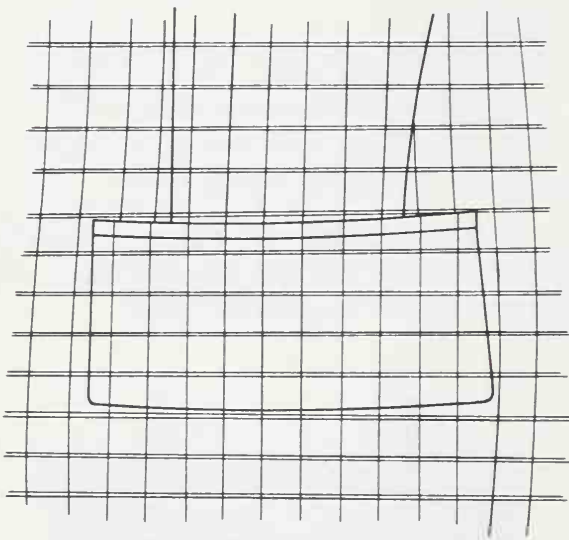

The best jacket pattern to use for a plaid or striped fabric is one which eliminates the seam below the pocket by using a dart instead of a separate side panel (page 10). If there is no seam to distort the plaid lines below the pocket opening, it is possible to cut the flap for a double-piping pocket so that it matches the jacket fabric at the sides and bottom of the flap, as well as matching the piping at the top.

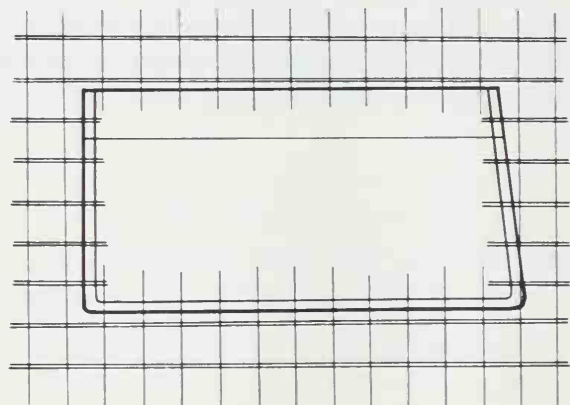

Place the flap pattern (page 91) on the jacket front, matching the flap placement line and pocket placement line.

On the pattern, draw lines around the edges indicating the placement of the plaid design. This procedure must be done for each pocket, since the lines may differ slightly.

Place the flap pattern on the right side of the plaid fabric so that the lines around the edges of the pattern coincide with those on the fabric.

Cut the fabric and proceed with the construction of the pocket (following the instructions given previously).

THE PATCH POCKET

The patch pocket is used on tailored jackets when a more casual effect is desired.

For a hip-level patch pocket, the width at the top edge is $5\frac{1}{2}$ " (14 cm) to $5\frac{3}{4}$ " (14.6 cm). The depth is approximately 8" (20.3 cm), however, this will vary according to the length of the jacket. The patch has a more graceful line if the width at the bottom is about 1" (2.5 cm) larger than at the top.

A breast-level patch pocket runs from $4\frac{1}{4}$ " (10.8 cm) to $4\frac{1}{2}$ " (11.4 cm) at the top edge, and is approximately $5\frac{1}{2}$ " (14 cm) deep. The width at the bottom edge should be about $\frac{1}{2}$ " more than the top edge.

Chalkmark the pocket placement line, (the top edge of the patch) on the front of the jacket.

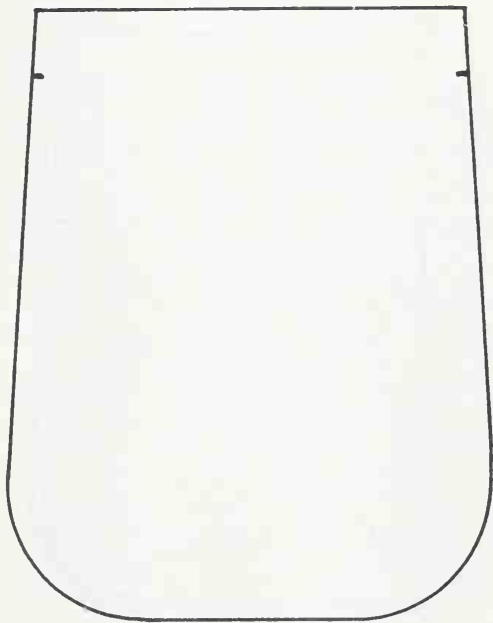
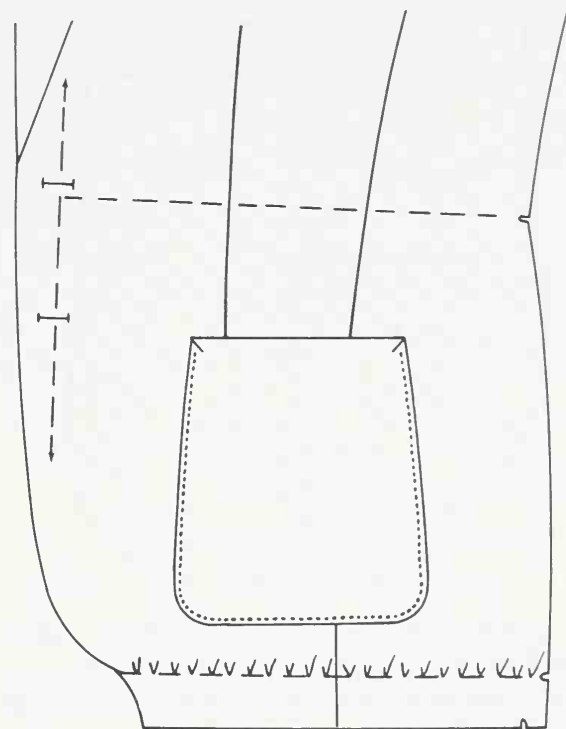

Cut a piece of garment fabric in the dimensions of the desired pocket, plus 1" (2.5 cm) extra fabric across the top and $\frac{1}{4}$ " (6 mm) seam allowance on the other sides.

Notch both ends of the 1" (2.5 cm) fabric extension.

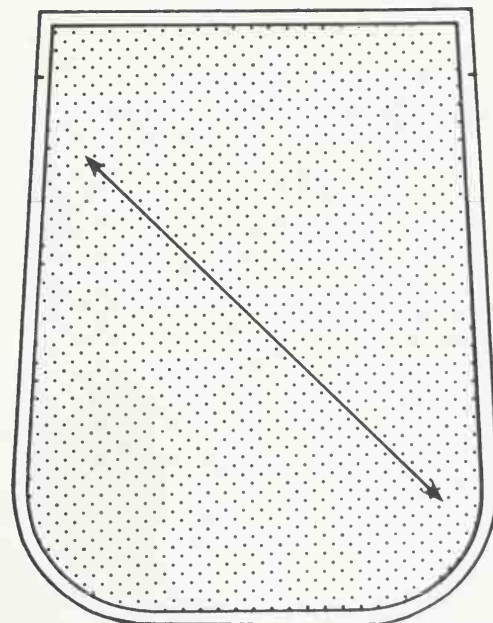

Apply a lightweight woven fusible, bias cut, to the wrong side of the pocket, leaving $\frac{1}{4}$ " (6 mm) margin of fabric free all around.

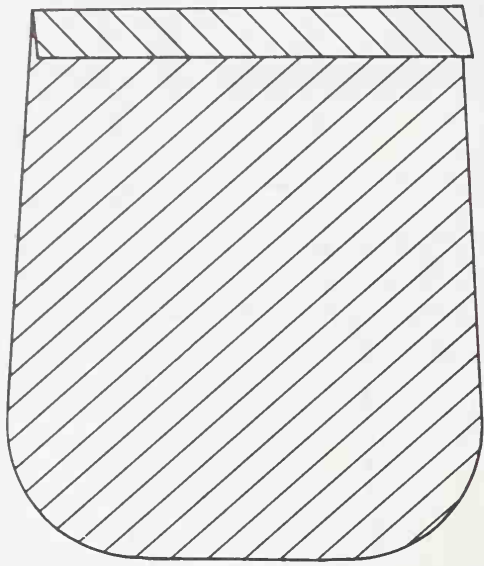

Cut a piece of lining, straight grain, slightly larger than the garment fabric. Press down $\frac{1}{2}$ " (1.3 cm) towards the wrong side at the top edge.

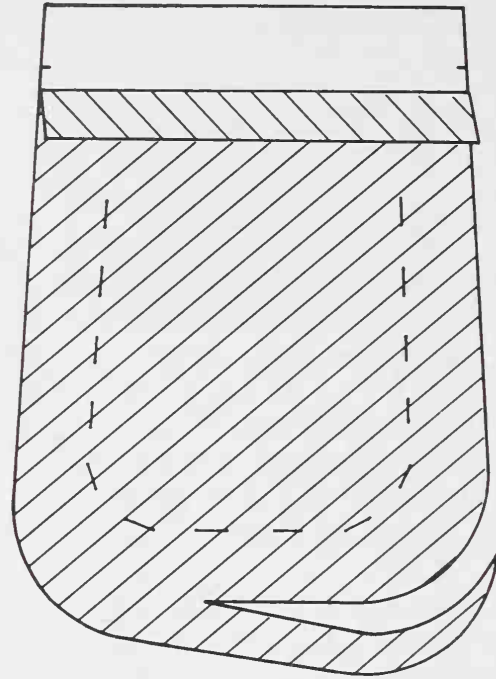

Trim the lining even with the patch.

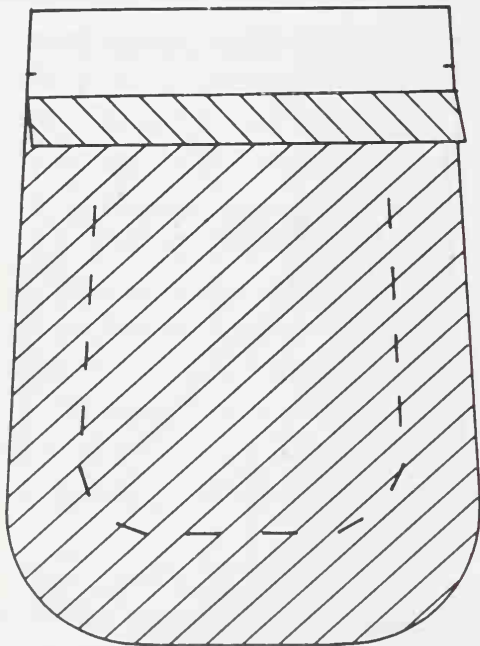

Place the lining and pocket together, right sides touching; the folded edge of the lining should be $\frac{1}{2}$ " (1.3 cm) below the notches at the top of the pocket. Baste around the pocket, about $1\frac{1}{2}$ " (3.8 cm) in from the edge.

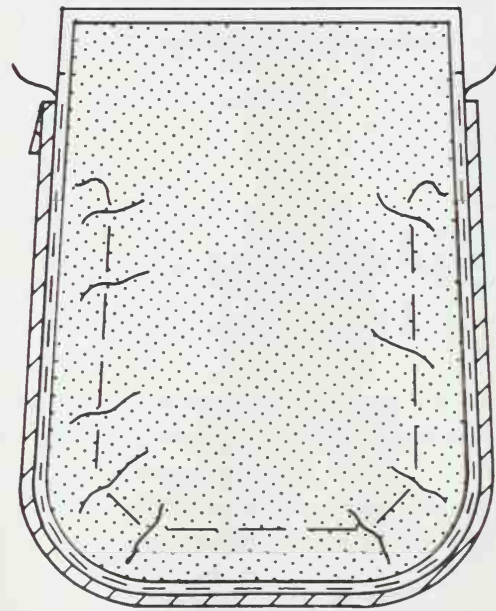

Working from the fusible side, baste around the patch once more, this time easing the patch in from the edge of the lining about $\frac{1}{8}$ " (3 mm) all around. This step ensures that the finished patch will be slightly larger than the lining and that the lining will not show at the edges.

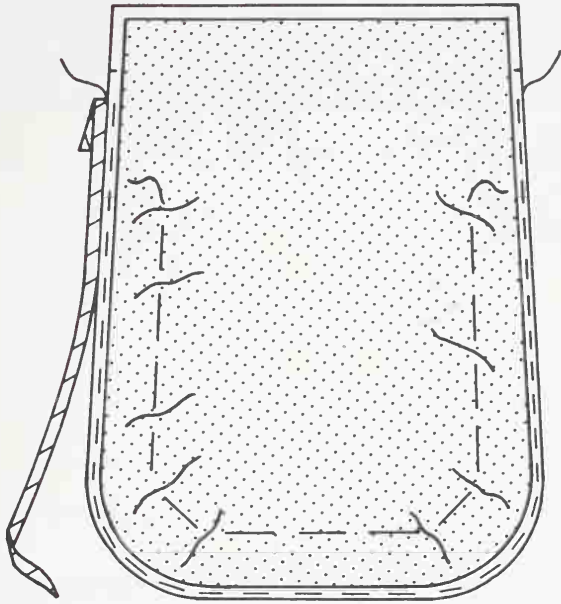

Trim the lining even with the patch

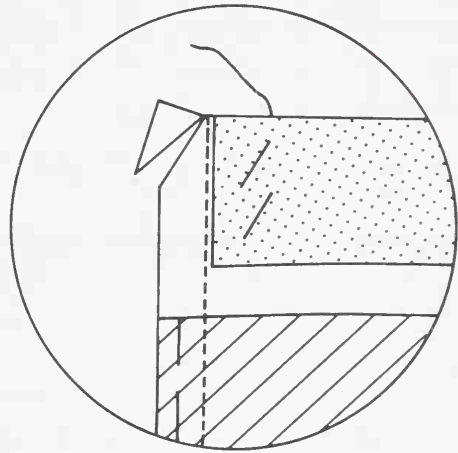

Using a $\frac{1}{4}$ " (6 mm) seam, machine stitch around the pocket, tacking well at the top corners. Sew from the lining side to avoid slippage. Trim the corners, remove the basting, and turn the pocket to the right side.

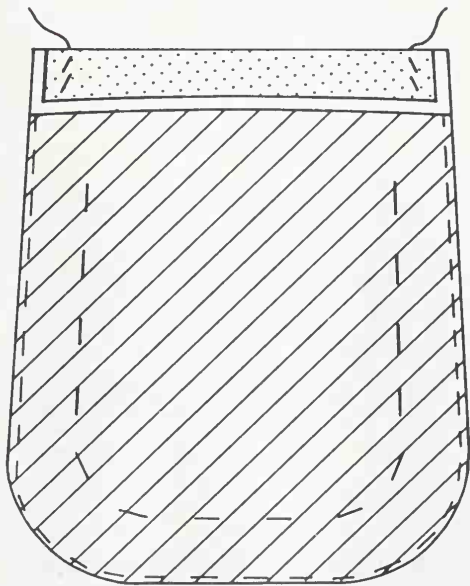

Fold the 1" (2.5 cm) extension back onto the lining and baste the ends down.

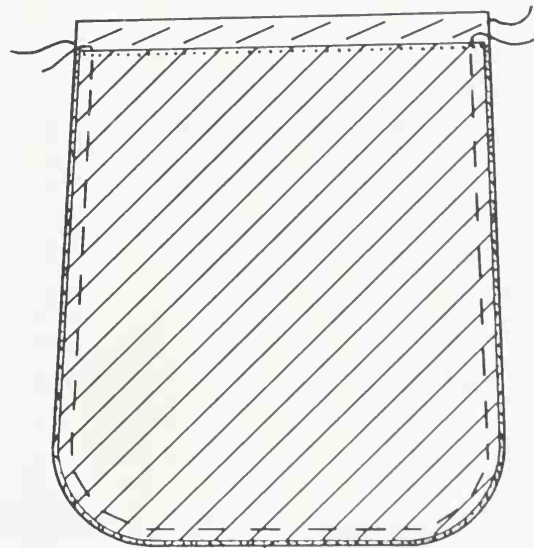

Baste around the edges of the patch once more, and then steam press on the right side. Use a handstitch to secure the folded edge of the lining at the top of the pocket. The patch is ready to be attached to the jacket.

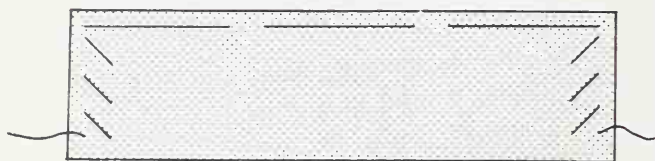

Cut a piece of pocketing to be used as reinforcement, straight grain, 3" (7.6 cm) wide and 2" (5 cm) longer than the top of the finished patch. Place the reinforcement on the wrong side of the jacket, centered over the pocket placement line. Baste or pin in place.

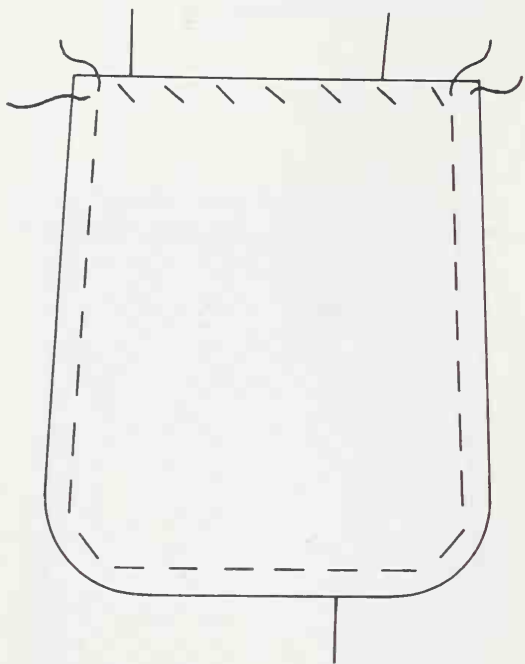

On the right side, place the top of the patch at the pocket placement line. Baste the patch to the jacket.

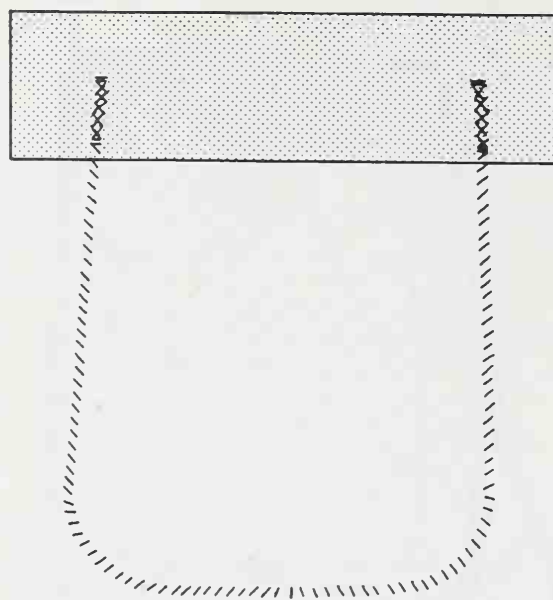

On the wrong side, secure the patch to the jacket by hand, using a diagonal stitch and silk finishing thread. Double the stitch in the reinforcement area.

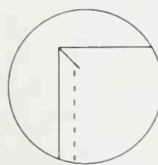
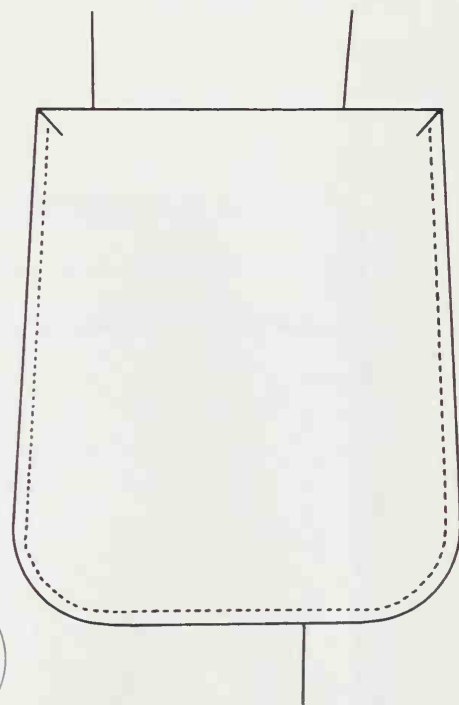

You may choose to add a row of hand topstitching to the front of the pocket. If so, use buttonhole twist which you have waxed, and then pressed between two pieces of paper. The heat will melt the wax into the twist and give the thread a better body. If you wish, add a single bartack at each corner of the pocket as a finishing touch.

PATCH POCKET (PLAIDS/STRIPES)

The plaid on the patch pocket should match the plaid on the jacket perfectly along both sides and at the bottom of the patch. There will, however, be slight distortion in the plaid on the jacket at either end of the pocket at the top edge, due to the darts.

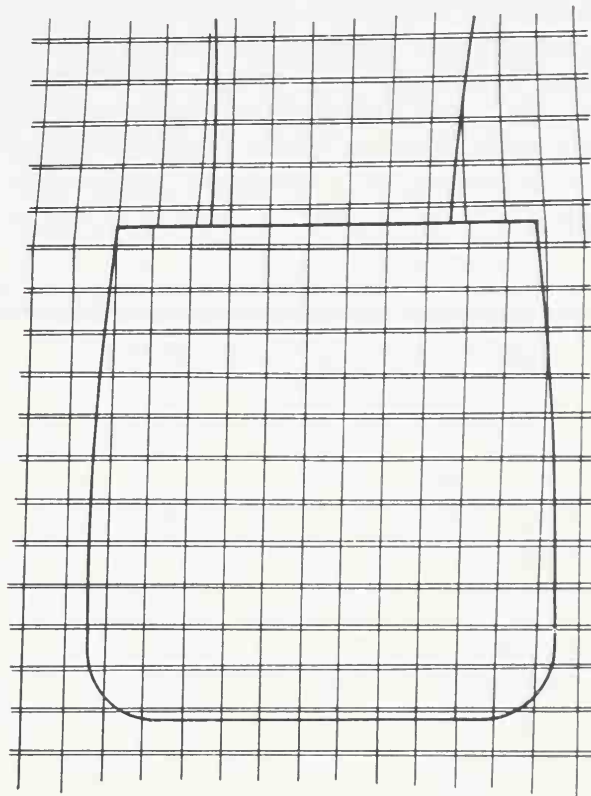

In order to cut the patch so that the plaid lines match, place the patch pocket pattern (page 95) on the front of the jacket. Fold back the 1" (2.5 cm) extension at the top of the patch and place the notches, which are at the top of the patch, at the pocket placement line on the jacket. Draw lines on the pattern, around the edges, indicating the placement of the plaid design. This procedure must be done separately for each pocket, since the lines may differ slightly.

Open out the 1" (2.5 cm) extension which was folded at the top of the patch, and place the pattern on the right side of the plaid fabric, so that the lines around the edges of the pattern coincide with those on the fabric.

Cut the fabric and proceed with the construction of the pocket, following the instructions given above.

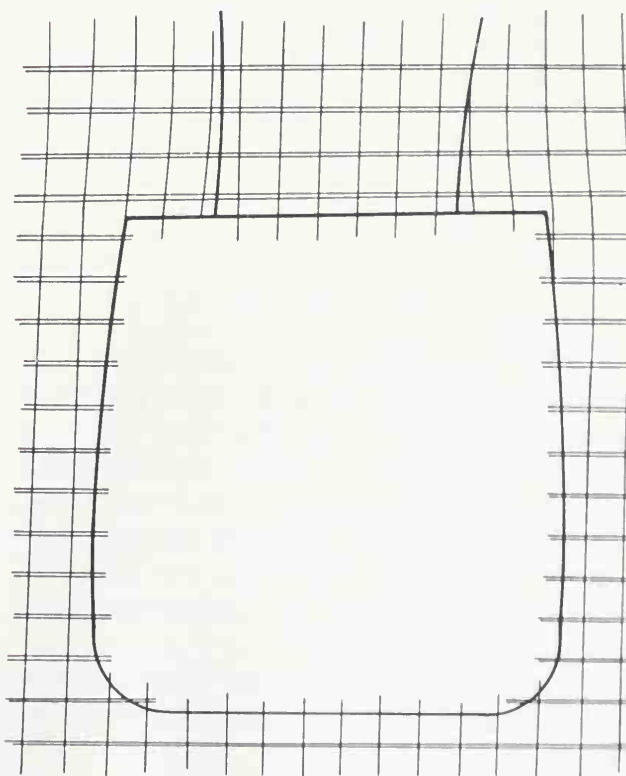

PREPARING THE CANVAS

The canvas in a woman's jacket is a light-weight version of the understructure originally designed for men's tailored jackets.

For men's wear, the chest and front of the shoulder are built up with padded layers of wool canvas interfacing, haircloth, French canvas, and wool flannel. This solid breastplate is unnecessary and unflattering to the feminine figure.

The canvas in a woman's jacket, constructed entirely of wool canvas interfacing, is

designed to give the jacket a soft yet controlled body, and to reduce the fabric's susceptibility to wrinkling and stretching. In this section we will show the most commonly used canvas understructure. On page 103 we show the full canvas interlining.

Remember that it is necessary to soak the canvas in cool water and drip dry before use to ensure against shrinkage.

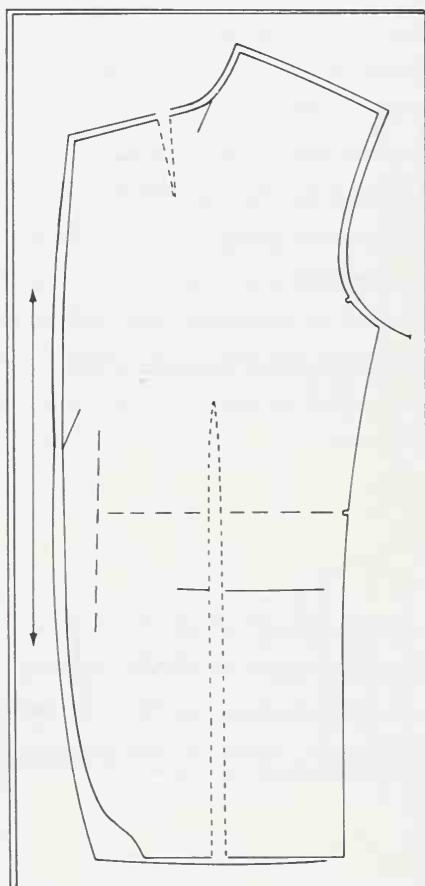

The wool canvas interfacing is cut on the straight grain using the jacket front pattern as guide. Trace around the pattern, $\frac{1}{2}$ " (1.3 cm) from the edge at the armhole, shoulder, neck, lapel, and jacket front. Leave a bit of extra fabric at the hem curve and across the bottom of the pattern. Extend the underarm line about 2" (5 cm) out at the side, to approximately the center of the underarm.

Indicate on the canvas, the top and bottom of the roll line and the dart points. Remove the pattern.

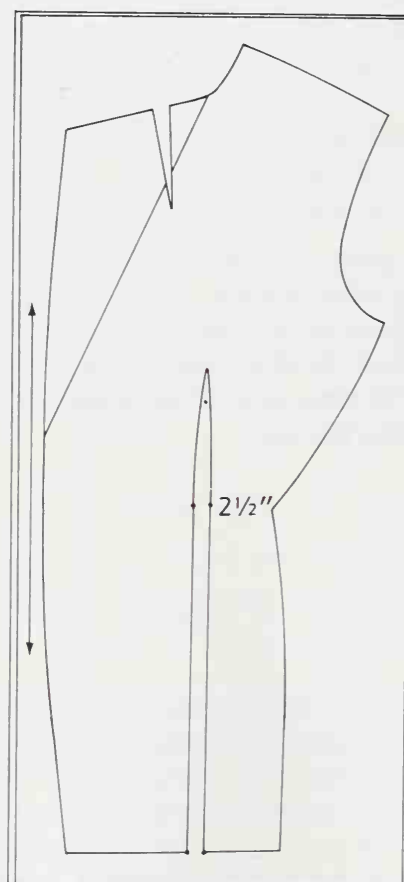

Draw the roll line. Lengthen the dart 1" (2.5 cm) at top and bottom, and draw new dart stitchlines.

Draw a curved line from the armhole to a point on the waistline $2\frac{1}{2}$ " (6.4 cm) from the dart stitchline. Curve gently from the waist to the hem.



Cut out the canvas. There is no right or wrong side of the canvas fabric, however, for purposes of construction, indicate with an "X" the wrong side of each piece.

Cut out the darts, using the dart stitchline as a cutting line.

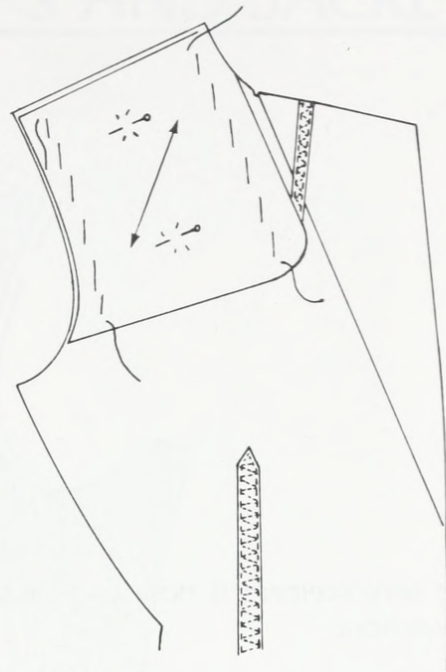

Cut a bias piece of canvas as reinforcement for the front of the shoulder. The reinforcement should be the width of the shoulder, and extend to just above underarm level.

Baste the reinforcement to the wrong side of the canvas, $\frac{1}{2}$ " (1.3 cm) in from the lapel roll line.

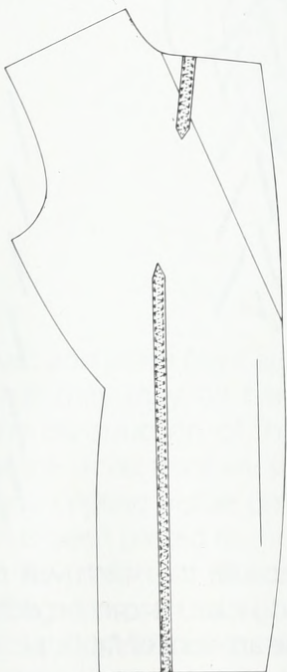

The darts are closed by butting the edges together, and topstitching a bias strip of pocketing to the wrong side of the canvas. The dart is reinforced by a row of zigzag stitching on top of the pocketing strip.

The reinforcement is now pad-stitched to the canvas front.

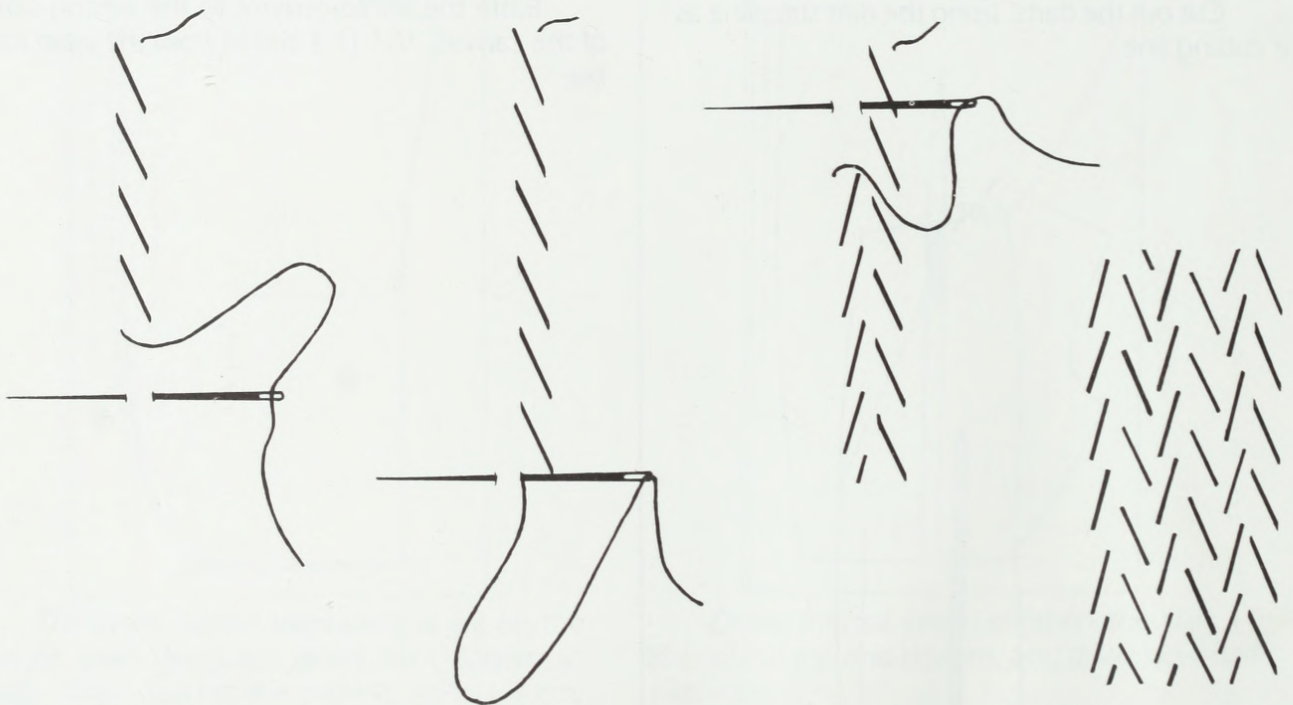
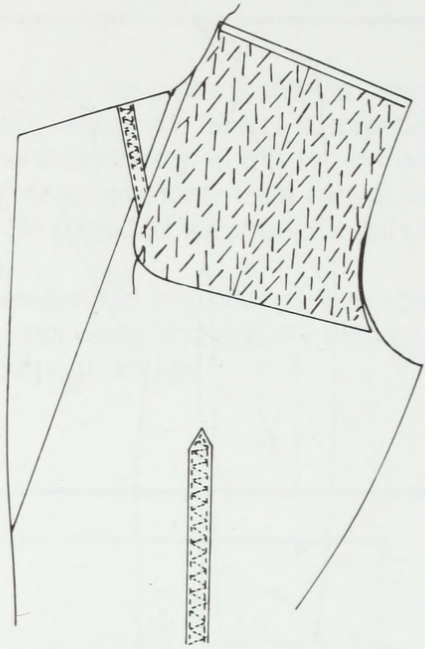

The pad stitch is a diagonal stitch which is staggered from one row to the next. It is used to join two or more layers of fabric, so that they act as one, while maintaining their individual characteristics. If the stitches are pulled too tightly while padding, the fabric will pucker and create bulky ridges between the rows. We will be using the pad stitch at several points during the construction of the jacket.

Here, because the stitch will not be visible in the finished jacket, it can be done in basting thread and the amount of fabric picked up by the needle (the size of the stitch on the underside) can be a generous $\frac{1}{8}$ " (3 mm). The size of the diagonal is a good $\frac{3}{8}$ " (1 cm). *Do not* spend time measuring your stitches. Just get a general sense of the size, and proceed.

ASSEMBLING THE CANVAS AND JACKET

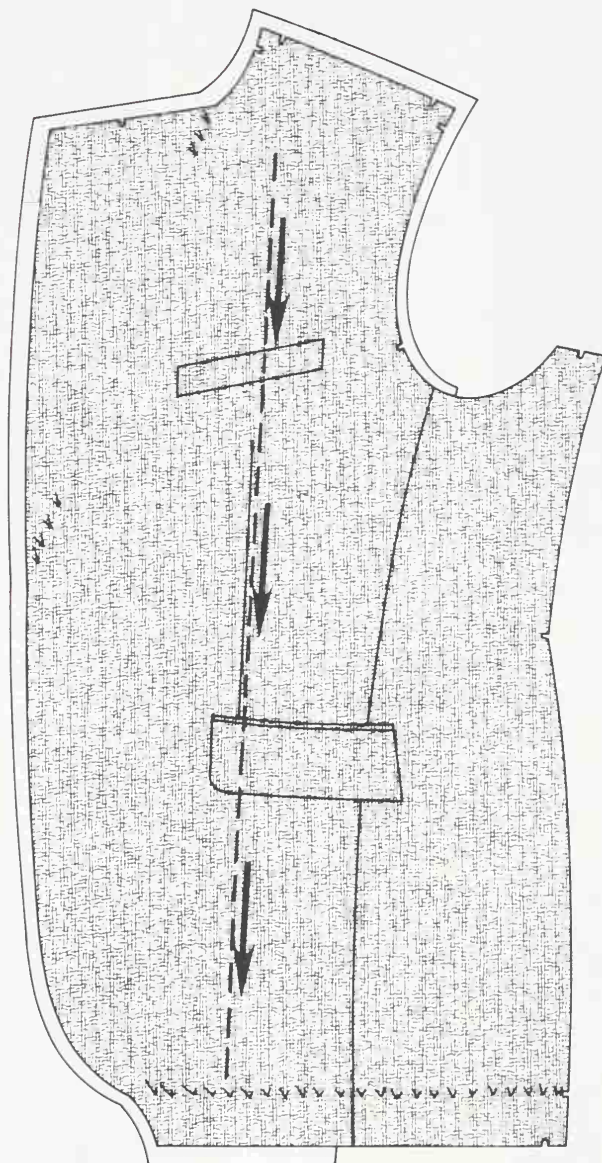

The canvas and jacket front are now basted together so that they may be handled as one unit during the construction of the jacket. It is important that the jacket front lay smoothly over the canvas. Any rippling visible on the garment fabric after it has been basted to the canvas, will be impossible to press out. Therefore, several rows of stitching are used to control the two layers of fabric, and great care is taken to gently smooth the fabric ahead of the needle as you baste. The arrows in the sketches indicate the direction in which the fabric is smoothed.

On a flat surface, place the jacket front and canvas together with the wrong side of the jacket to the right side of the canvas. The canvas

and jacket darts should meet. Since the canvas darts are longer (page 100), however, they will extend above and below the jacket darts. A $1\frac{1}{2}$ " (1.3 cm) margin of canvas should be visible around the outer edges of the jacket.

Beginning above the front dart, about 3" (7.6 cm) below the shoulder, baste down the front of the jacket, catching the canvas and smoothing the garment fabric gently ahead in the direction of the arrows. The stitches are about $1\frac{1}{2}$ " (3.8 cm) long and are left comfortably without tension. Baste through the pockets, using dart as guideline, and finish at the hem foldline.

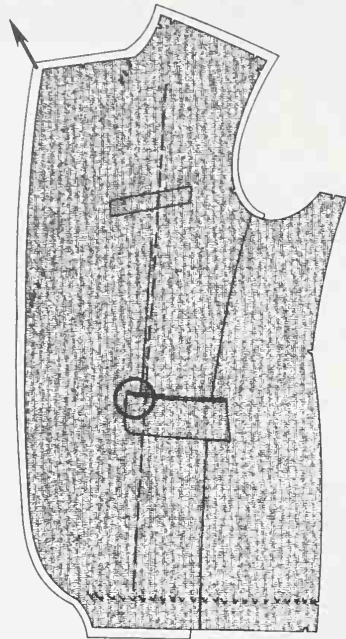

Before proceeding with the outside basting, the pockets must be secured into the canvas. With one hand on the hip pocket to prevent the garment fabric from shifting, tug gently upwards at the tip of the canvas lapel. *Gently* is the word. This should eliminate any rippling in the canvas on the diagonal from the hip pocket to the lapel tip.

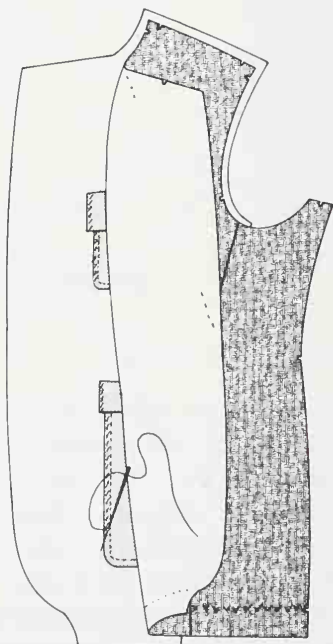

Carefully fold back the garment fabric until the ends of the pockets are visible. Baste one edge of the pocket seam allowance, and the reinforcement ends into the canvas using diagonal stitches.

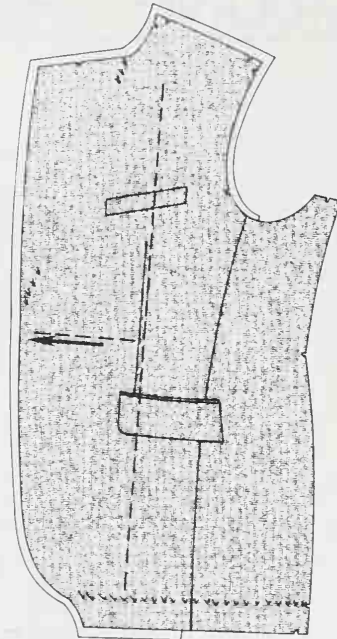

Fold the garment fabric back in place. Smooth and baste the fabric across the waistline from the dart to 1" (2.5 cm) from the edge of the jacket.

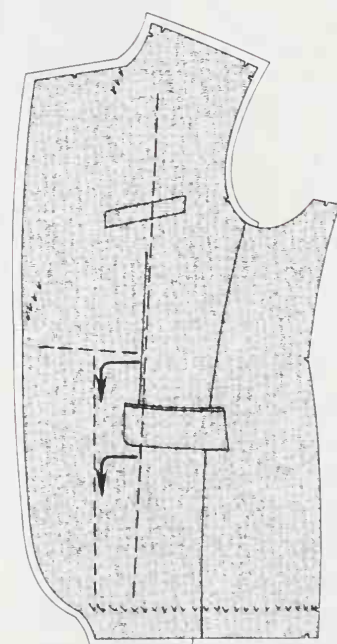

Below the waistline, at approximately mid-way on the second stitchline, baste down from waist to hem smoothing the fabric as indicated by the arrows.

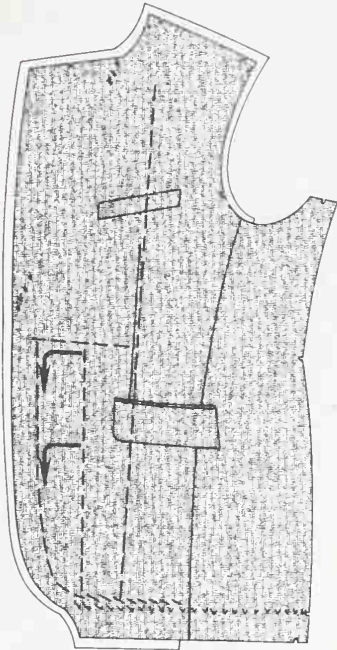

Approximately 1" (2.5 cm) from the jacket edge, baste down from the waist to just above the hem, and continue across to the end of the canvas.

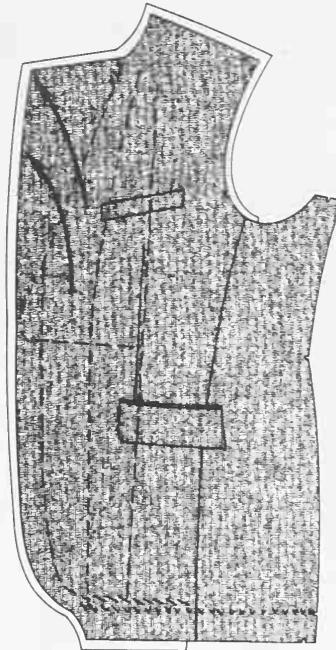

Using the tailor tacks as a guide, chalkmark the roll line on the right side of the jacket. Stitchline #6 moves up from the waist into the roll line. The fabric is smoothed up and out between stitchlines #5 and #6 as the roll line is basted.

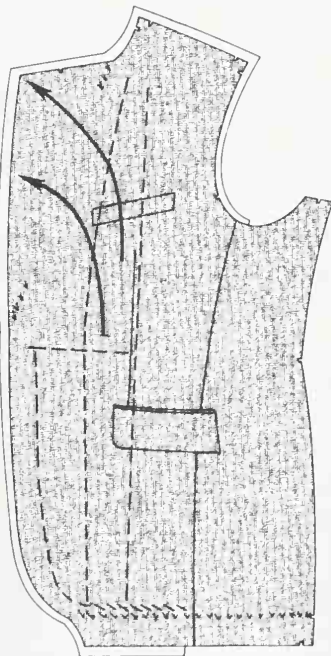

Above the waist, the fabric is smoothed up and out, as stitchline #5 rises from the waist to 3" (7.6 cm) below the shoulder.

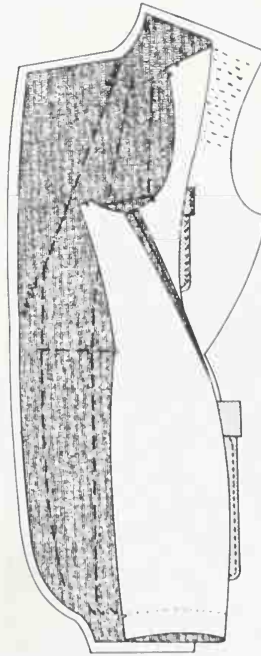

If you are working on the left front of the jacket, carefully fold back the fabric until the inside of the welt pocket is visible. One side of the pocket has already been basted into the canvas (page 104). Now, following the same procedure as above, baste the second side of the pocket into the canvas. This side of the hip pocket cannot be basted, since it overshoots the canvas. Fold the garment fabric back in place.

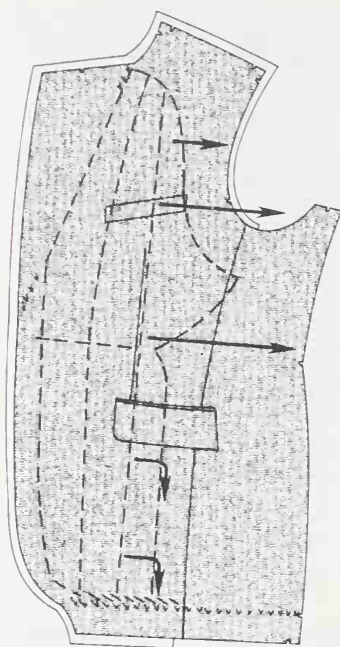

Stitchline #7 runs across the top of the other stitchlines, and traces the armhole, remaining 3" (7.6 cm) away from the edge. The basting curves into the waist, then out and down to the hem. Smooth the fabric gently, following the direction of the arrows.

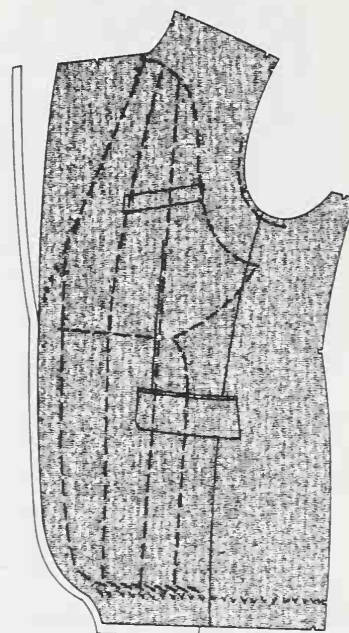

With the basting completed, hold the jacket front up and check that there is no rippling in the garment fabric between the lines of basting. Slight rippling is to be expected on the canvas side, and serves as ease for the garment fabric. Trim the canvas even with the jacket front.

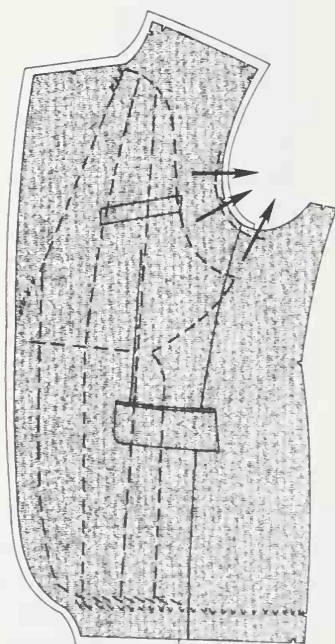

The bias curve of the jacket armhole is basted into the canvas. Care should be taken not to stretch the fabric in this area.

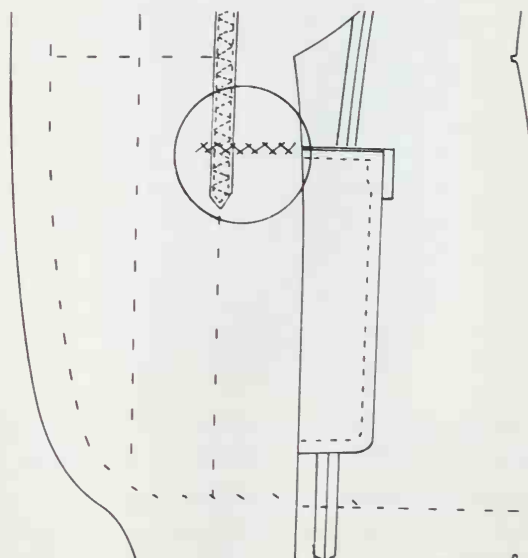

Cross-stitch the canvas into the seam allowance at the top of the pocket. The assembly of canvas and jacket front is complete.

PADSTITCHING THE LAPELS

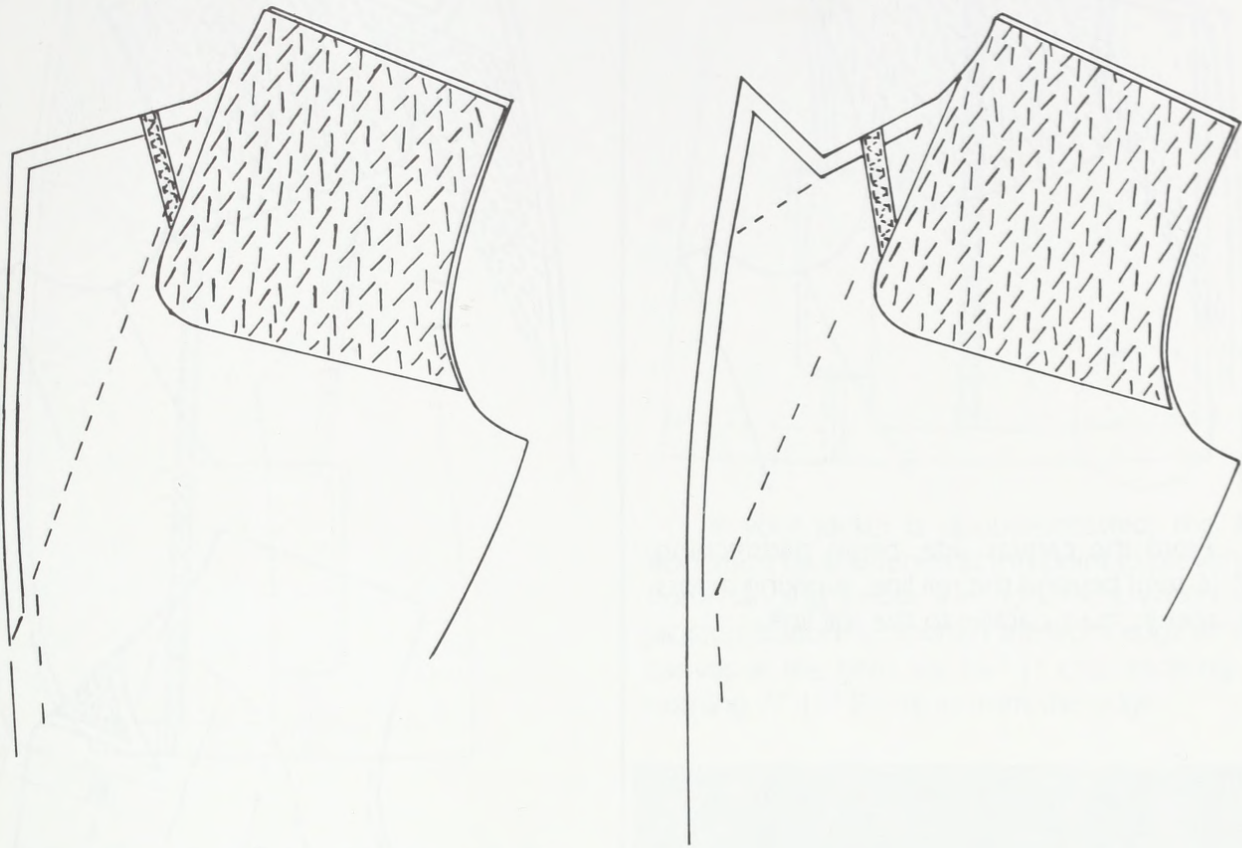

In order to give the jacket lapel the crisp body it will need in the finished jacket, the canvas lapel is now padstitched (page 102) into the jacket lapel.

Since these stitches will show through on the underside of the lapel in the finished jacket, use silk thread in a color that matches the garment fabric. The stitches on the canvas side should be about $\frac{3}{8}$ " (1 cm) long. On the jacket side, they should be tiny pinpricks.

As previously discussed, if the stitches are pulled too tightly while padding, the canvas will pucker and create ridges which will be obvious through the facing on the finished garment.

Draw a chalkline on the canvas lapel indicating the seam allowance. If you are working on a *peak lapel*, add a line across the bottom of the peak.

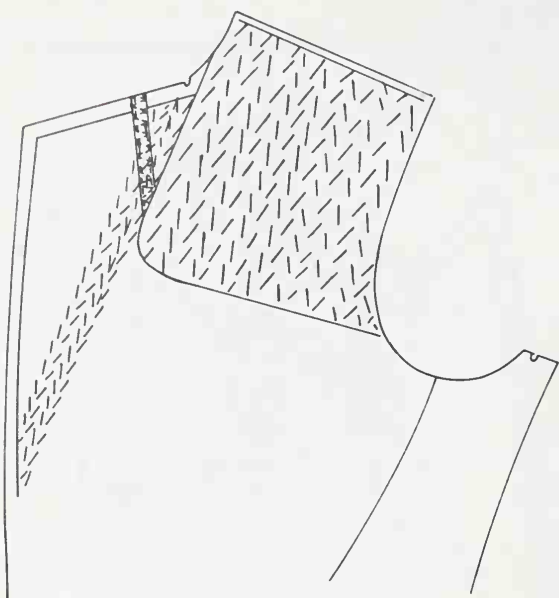

From the canvas side, begin padstitching $\frac{1}{4}$ " (6 mm) beyond the roll line, working across the lapel in rows parallel to the roll line.

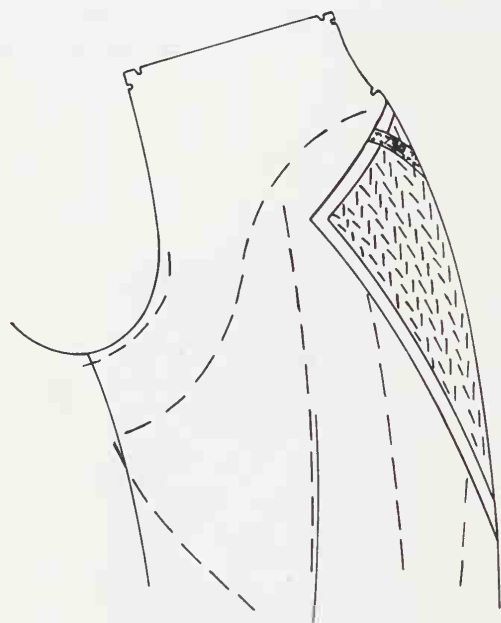
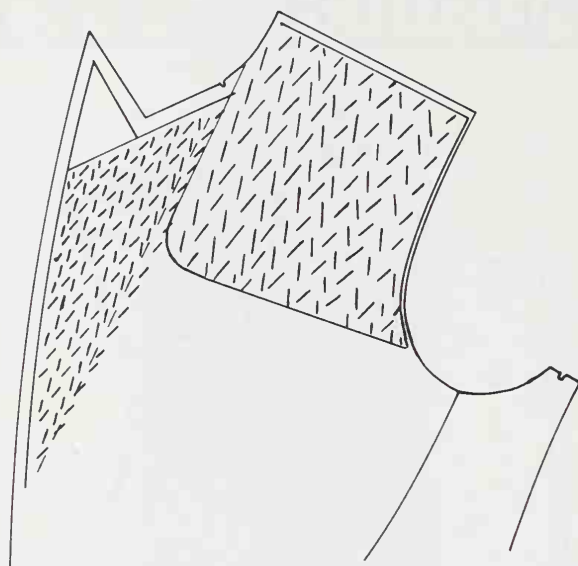

About $1\frac{1}{2}$ " (3.8 cm) past the roll line, turn the lapel so that it takes the position it will have in the finished jacket. Continue to padstitch with the lapel held in this position. This procedure of rolling the lapel while padstitching ensures that the garment fabric lapel will end up slightly smaller than the canvas lapel, and will, therefore, pull towards the jacket. It is exactly this inclination or pulling towards the jacket that we are trying to create for a natural roll of the lapel.

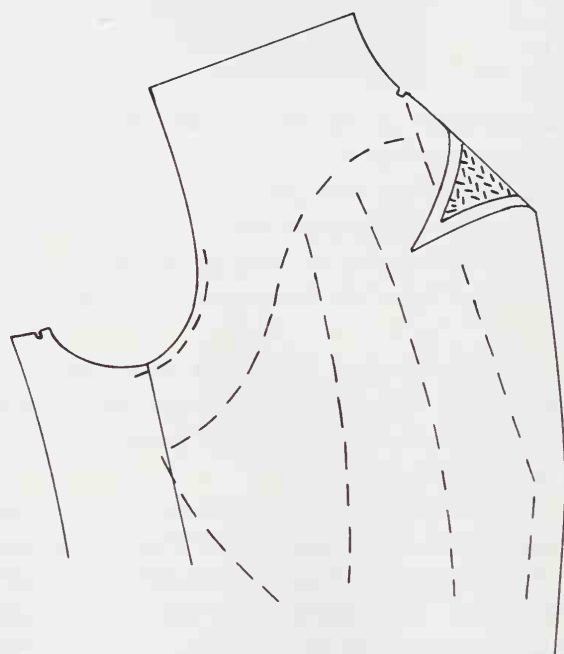

If you are working on a peak lapel, a second rolling is suggested. To prevent the peak from drooping forward in the finished garment, it is padstitched while held rolled towards the jacket body.

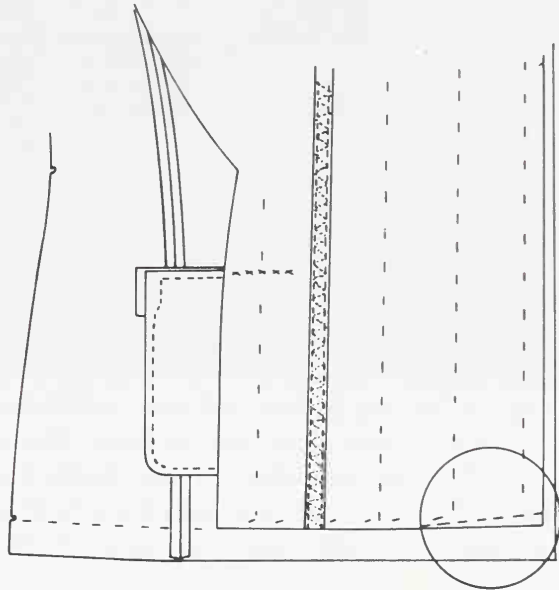
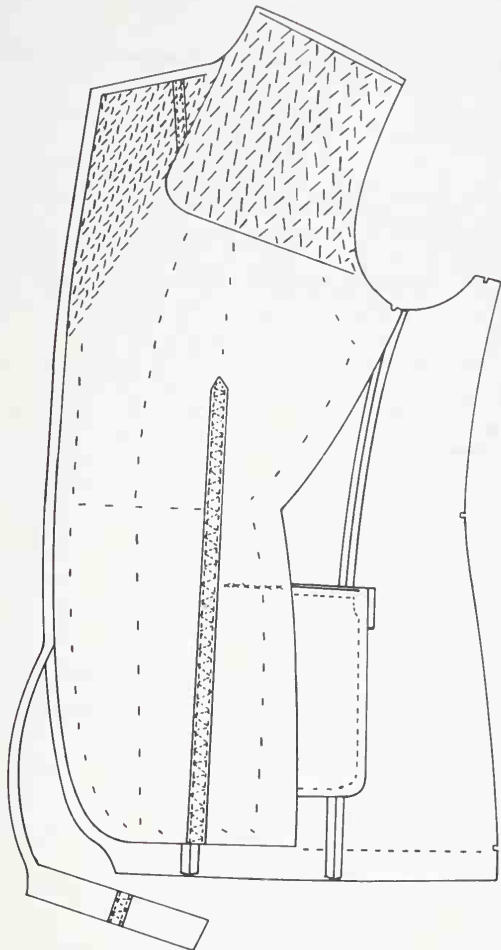

If your jacket is double-breasted, the *left front* must be shortened at this point to prevent it from hanging below the *right front* when the jacket is buttoned. Shorten the front edge of the canvas at the hem, by $\frac{3}{8}$ " (1 cm), tapering to nothing 7 " (17.8 cm) in from the edge.

Beginning $\frac{1}{2}$ " (1.3 cm) past the roll line, draw the seam allowance on the canvas—across the top of the lapel, down the jacket front, and across the hemline at the bottom of the canvas.

Trim away the canvas in the seam allowance. *Be very careful* as you cut the canvas, *not* to cut the garment fabric.

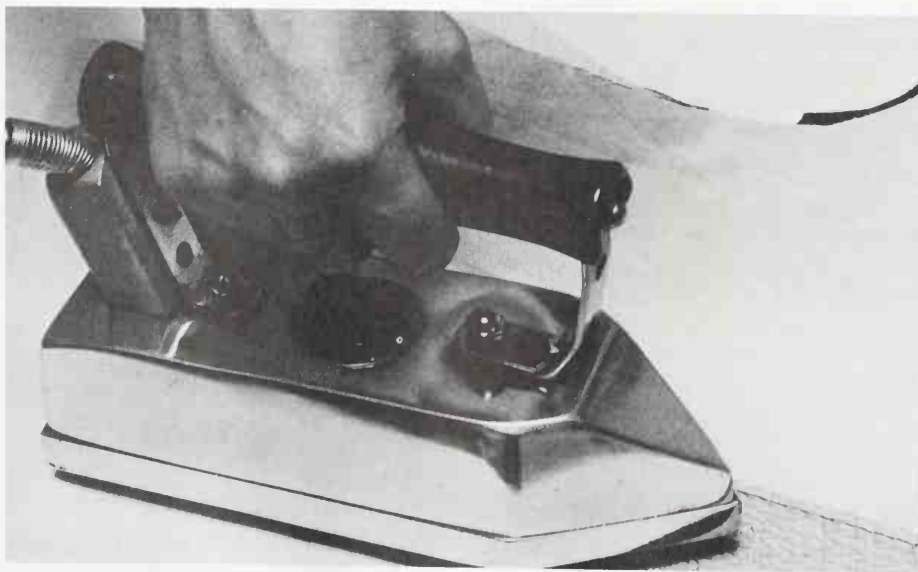
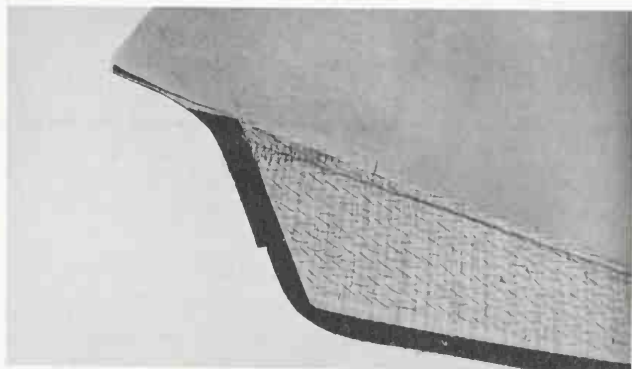

The lapel is now pressed from the canvas side.

THE TAPING

Tape is now applied along the outer edge of the lapel and jacket front to give a crisp, defined edge to the jacket. The tape is also run along the bias of the roll line, as additional support.

Use $\frac{3}{8}$ " (1 cm) cotton twill tape which has been soaked in cool water and pressed. Beginning $\frac{1}{2}$ " (1.3 cm) past the roll line, baste the tape along the top of the lapel with the top edge of the tape flush with the top edge of the canvas.

At the tip of the lapel, slash the tape almost to the end, and bring it down along the edge of the lapel.

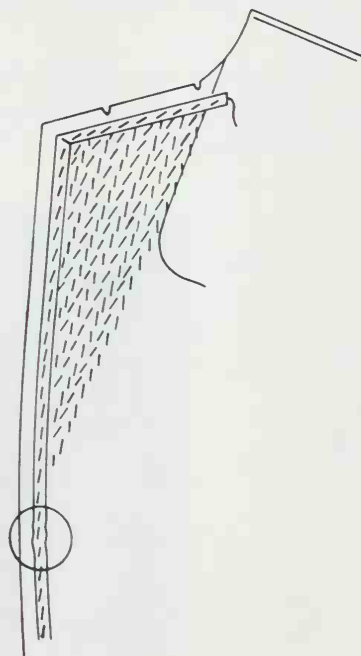
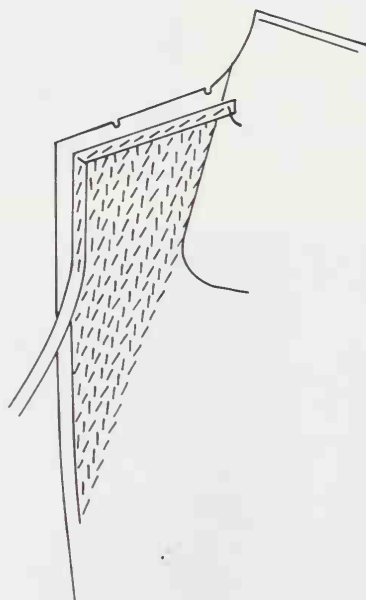
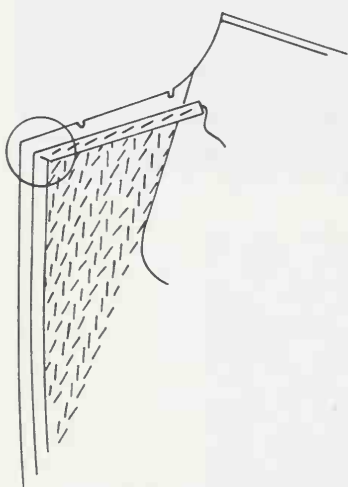
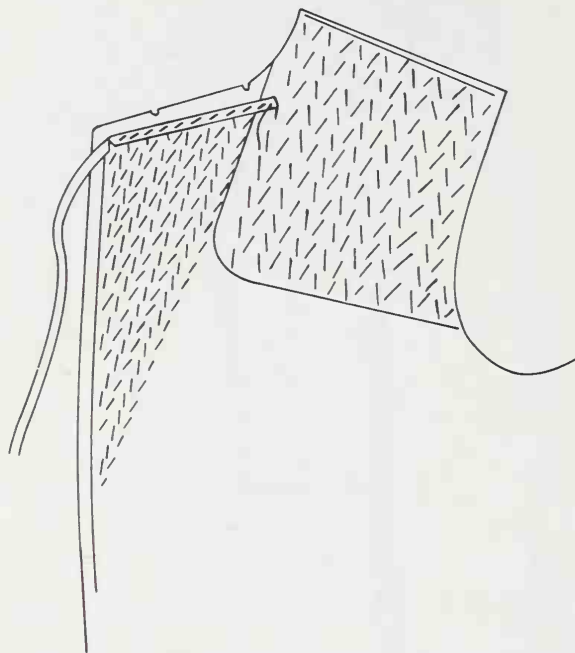

Snip away the overlap of tape at the lapel tip, and baste down the lapel and the jacket front. Extend the tape into the seam allowance, beyond the canvas, about $\frac{1}{16}$ " (1.5 mm).

At the bottom of the roll line, place $\frac{1}{4}$ " (6 mm) ease in the tape, so that the lapel will be free to fold over without restriction.

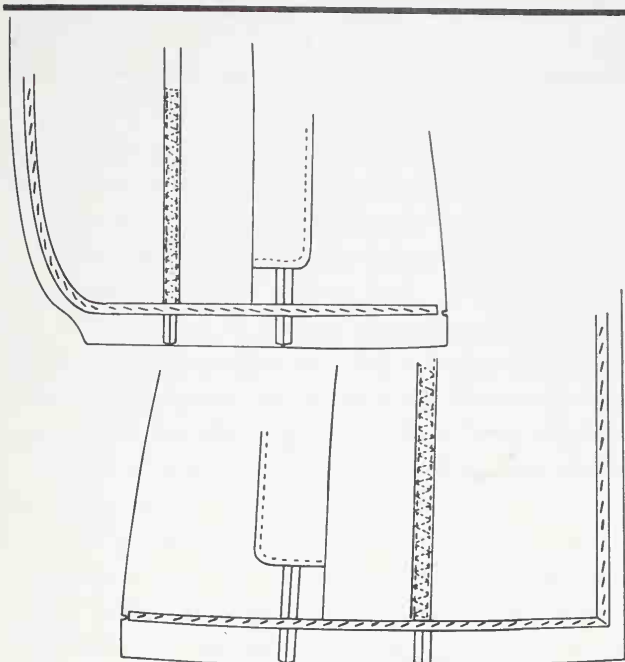

Tape across the top of the hem foldline with the bottom edge of the tape *on* the hemline.

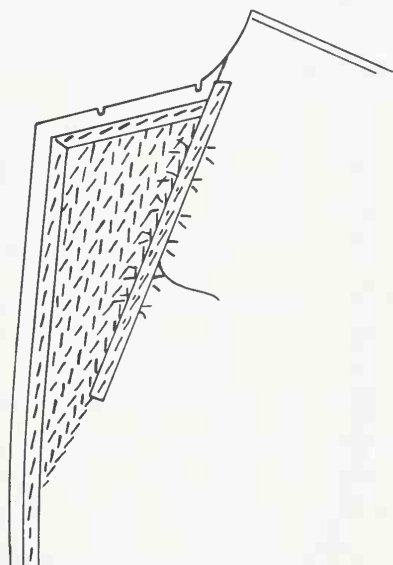

Tape is also applied, $\frac{1}{4}$ " (6 mm) beyond the roll line. Baste the tape, through all layers of fabric, from the neck edge down for about 3" (7.6 cm). Take a couple of backstitches, and then begin pulling the tape as you baste for the next 3" (7.6 cm) or so. Rippling should appear on either side of the tape. Take a couple of backstitches at the end of the 3" (7.6 cm) span to keep the rippling in place and continue basting without pulling the tape.

Only the top two-thirds of the roll line area is taped. The bottom third is left free to allow the lapel to roll easily.

Pulling the roll-line tape creates the equivalent of a dart through the roll line. In the finished jacket, the effect is a roll line less inclined to pull away from the body.

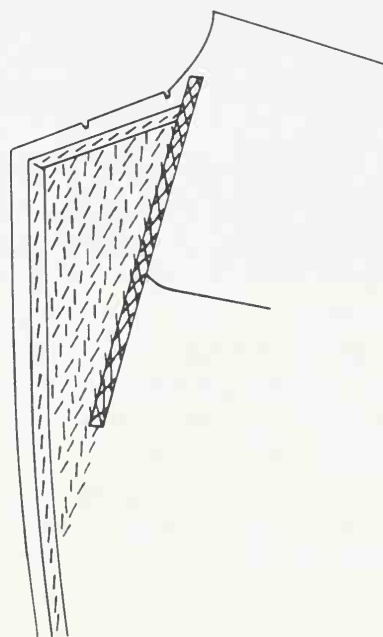
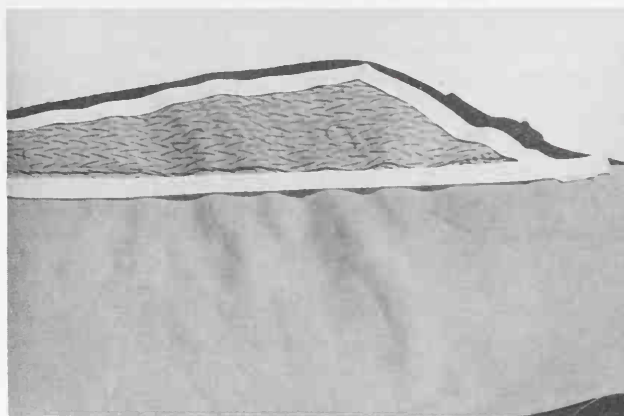

Using silk thread, cross-stitch along the roll-line tape, stitching through all layers of fabric. The stitches should be along the very edge of the tape to prevent it from curling up. You will notice that the rippling in the jacket at the center of the roll line disappears as the tape is cross-stitched to the jacket.

Press the roll-line tape, allowing the lapel to fall free.

The rest of the tape is secured by slip-stitching along both edges, using silk thread. Along the outer edge of the tape, stitch through to the right side of the fabric. The stitches should be very small and sewn without pulling. On the inner edge of the tape, stitching through all layers can only be done in the lapel area. Below the lapel catch only the canvas. If you were to stitch through all layers on the inner edge of the tape below the lapel, these stitches would be visible and unwelcomed down the front of the finished jacket.

Trim the seam allowance along the jacket front and at the top of the lapel, so that only $\frac{1}{2}$ " (1.3 cm) seam allowance shows beyond the tape.

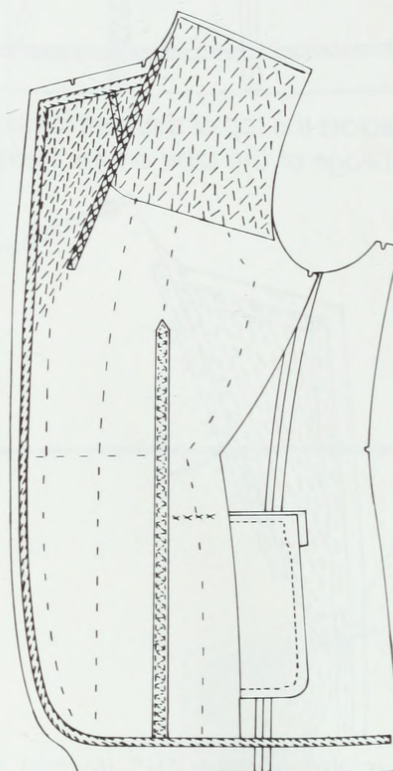

FIRST FITTING

At this point in the jacket construction, the first fitting is taken. Any minor discrepancies in fit (due to the differences in the hang of the muslin and the hang of the garment fabric) may be foreseen and corrected.

The jacket is basted together at the back and shoulder seams, and tried on by the client. Place well-constructed shoulder pads in the jacket for this fitting (page 137), so that the true contour of the shoulder, as it will appear in the finished jacket, may be observed.

With the front of the jacket pinned closed at the buttonhole markings, check the entire front, back, and side of the jacket with a keen eye for the creases we observed during the muslin fitting.

Chalkmark, or pin, any minor fitting adjustments. Check the shoulder width! If the cutting edge at the top of the shoulder extends out well beyond the shoulder edge, the fabric may need trimming. As a guide, place a ruler at the bicep and let it extend up towards the shoulder. If the fabric extends out beyond the ruler at the shoulder, the jacket shoulder is too wide and should be trimmed before attaching the shoulder pad.

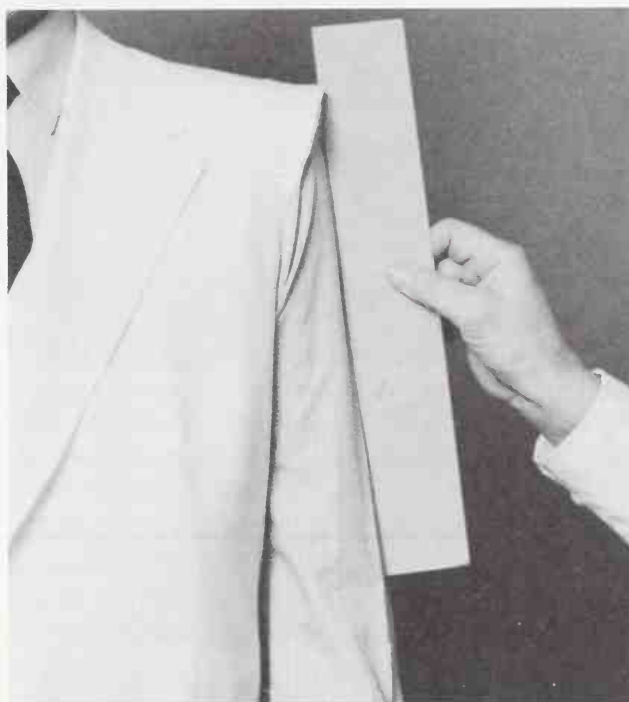

Give special attention to the armhole. With the client's arm resting comfortably at her side, see if there is any wrinkling or pulling in the front notch area of the armhole. If there is, the jacket fabric must be trimmed in this area (a small amount at a time).

With the arm still resting naturally at the client's side, chalkmark on the hip-level pocket, a line indicating the natural placement of the arm. This chalkmark will be used in setting the sleeve to fall either forward or backward, in accordance with the position of the client's arm.

Remove the basting at the back and shoulder seams, and make whatever adjustments are necessary.

The back seams will not be sewn until after the facing is attached.

The shoulder seams will be sewn after the body of the jacket has been lined.

If you have decided to make bound buttonholes on your jacket, they must be constructed now, before the facing is attached. Handworked buttonholes can wait until the jacket is completed.

The buttonhole section, which begins on page 177 includes instructions for two types of bound buttonholes and for the classic handworked buttonhole constructed with gimp.

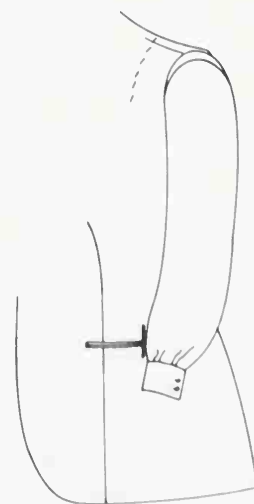
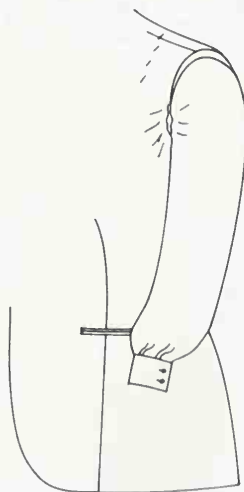

THE FACING

The facing plays a prominent role in the finished jacket. It must be carefully cut and shaped, and laid gracefully over the lapel, with enough ease to allow the lapel to roll freely. If the grain is off, or the ease is missing, there will be either ripples or strain on the front of the jacket.

The facing can be attached to the jacket either by hand or by machine. (Read through both procedures and decide which one you would like to learn first.) The difference in the amount of time it takes to complete either method does not seem to be significant, although one might expect this to be the case. The

hand application of the facing seems to require a "feel" for the fabric—more confidence in one's ability to control the fabric.

Many tailors use the hand application exclusively, because of the complete control it affords. Others, use it only for a plaid or striped fabric, where matching the design requires precision. There are also tailors who consider the hand application inferior to the machine application, because a facing seam, stitched by machine, may be a more definite line, and more secure than one stitched by hand. You decide which method to use.

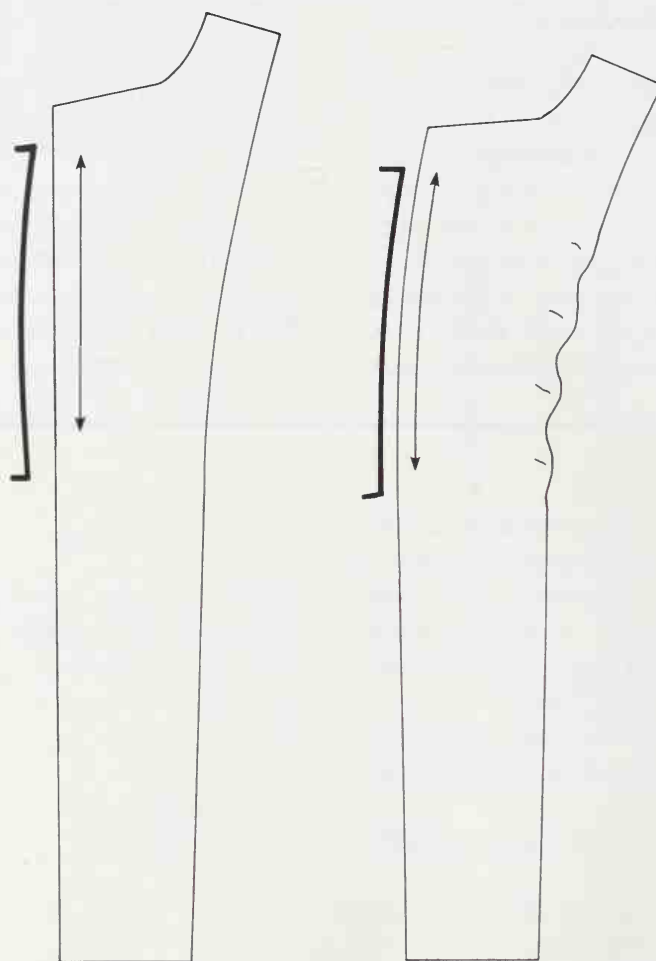

The outer edge of the facing, which you have cut using the revised facing pattern (page 13), is a straight line, and, therefore, not shaped to match the front of the jacket. Before attaching the facing to the jacket, it will be necessary to steam press the lapel area of the facing into a curve which matches that of the jacket lapel.

If, in the beginning, you hesitate to trust your eye to match the curve of lapel and facing,

create a guideline for yourself by drawing the lapel curve on a piece of paper and pinning the paper to your ironing board.

Place the raw edge of the lapel area of the facing along the guideline. Rippling will appear at the center, inner edge of the facing, if we shrink these ripples away, the front edge of the facing will maintain the curve we have given it.

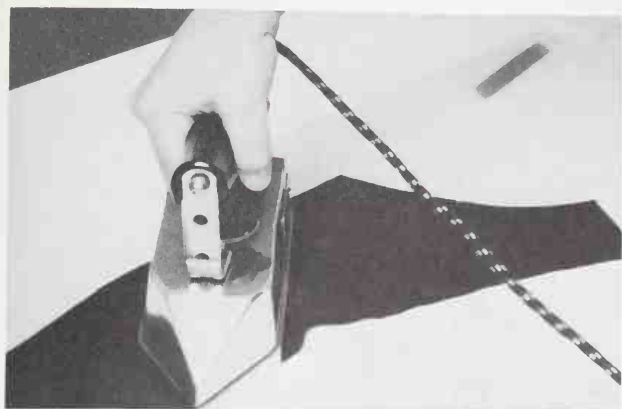

Here is where the flexibility of natural fibers can be appreciated. On the wrong side of the fabric, and using steam liberally, iron from the outer edge of the lapel in, using progressively smaller arcs. Depending on your fabric, this will require more or less effort; worsteds being a greater challenge than more loosely woven fibers.

The whole purpose of this effort is to maintain the straight of the grain at the lapel edge.

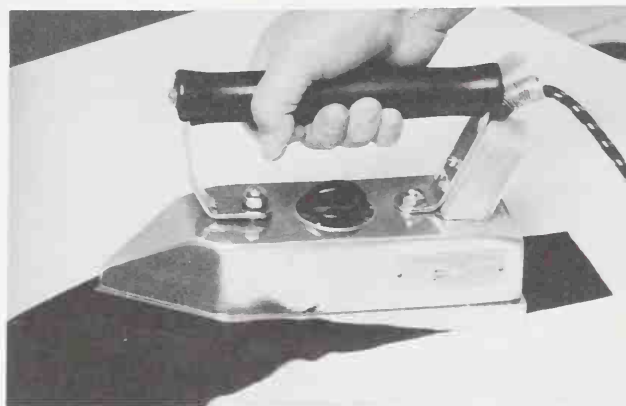

The benefit of this is obvious in a striped or plaid fabric, since it allows the pattern to continue uninterrupted from the top to bottom of the lapel. Less obvious, but no less important, is the fact that having the strongest grain at the outer edge of the lapel will be a safeguard against stretching and rippling in this area.

ATTACHING FACING BY MACHINE

Place the right side of the facing to the right side of the jacket front, allowing $\frac{1}{2}$ " (1.3 cm) facing to extend beyond the jacket at the top of the lapel and down the front of the jacket. Beginning at the tip of the lapel, baste down through the center of the tape, attaching the facing to the jacket. Just below the bottom of the roll line, place about $\frac{1}{4}$ " (6 mm) ease in the facing to accommodate the roll of the lapel. Tack the ease into the tape so that it will remain where you've placed it.

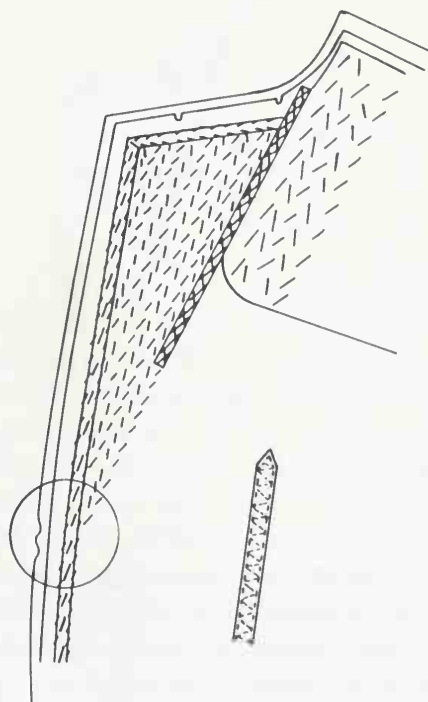

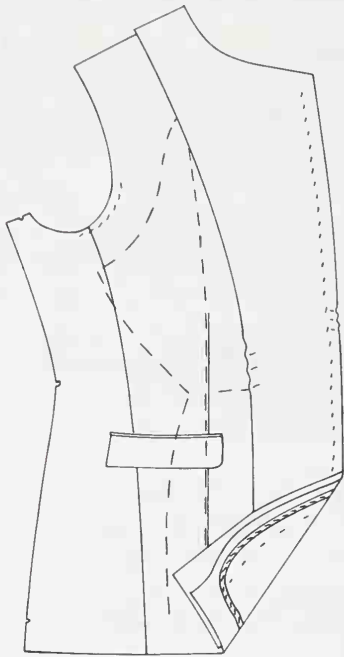

If the front of the jacket curves in at the hem, the facing should be basted to the curve using a slightly different technique. Since this area may be inclined to curl outwards, away from the body, in the finished jacket, roll the bottom of the jacket towards the facing as you baste. This will shorten the facing slightly, and ensure that in the finished jacket the curved edge will incline gently towards the body, rather than curling outwards.

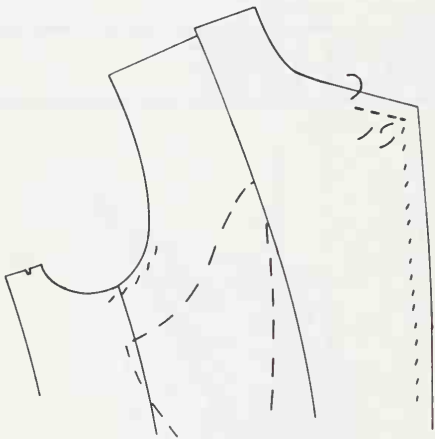

The tip of the lapel in the finished jacket should also incline comfortably towards the body, rather than curling upwards. For that reason, a small bubble of ease is now placed in the facing at the tip of the lapel. This will prevent the possibility of the facing pulling the lapel tip forward. At the top of the lapel, lower the facing slightly to create the ease, about $\frac{1}{4}$ " (6 mm). When the slight excess of fabric is visible at the lapel tip, baste across the lapel, from the tip to just beyond the collar notch.

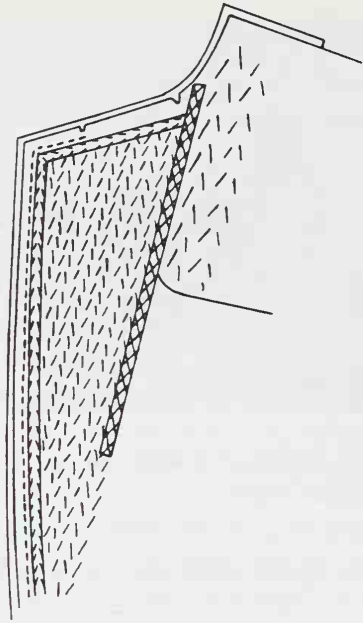

Machine stitch from the collar notch to the bottom of the jacket, using the tape as a guideline. Stitch about $\frac{1}{16}$ " (1.5 mm) beyond the tape, in the seam allowance.

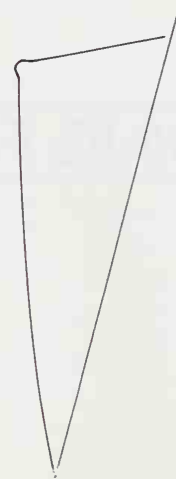

For a good point at the tip of the lapel, take one or two stitches on the diagonal as you turn. A sharp pivot at the tip will result in a misshapen, lumpy lapel tip, because there will not be enough room for the seam allowance to settle in.

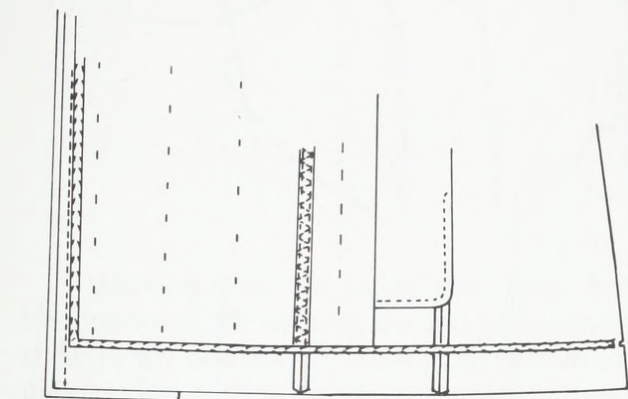
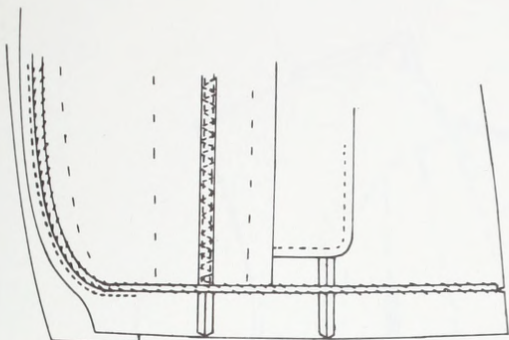

If the front of the jacket is rounded at the hem, stitch with the curve to the end of the facing.

If the front of the jacket is straight at the hem, stitch down to the bottom edge.

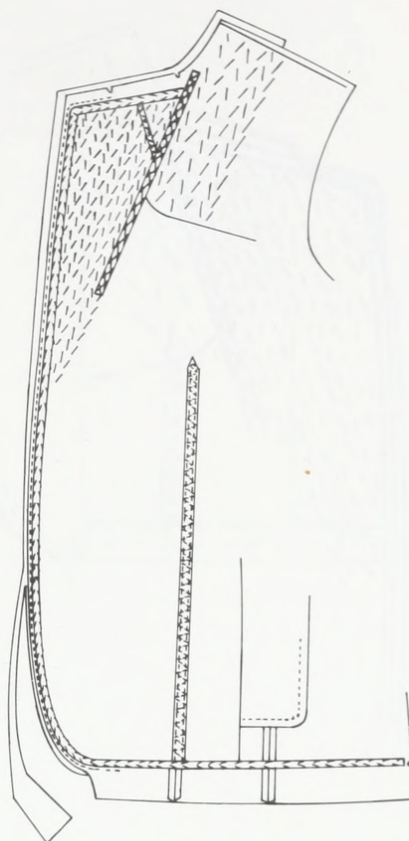

Remove the basting, and layer the seam allowances. From the bottom of the jacket to the tip of the lapel, trim the jacket seam allowance to $\frac{3}{8}$ " (1 cm) and the facing to $\frac{1}{2}$ " (1.3 cm).

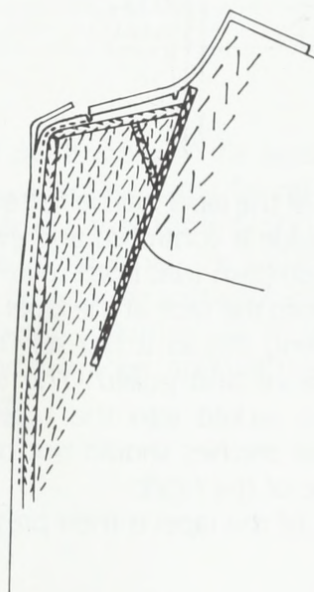

From the collar notch and around the lapel tip, trim a bit closer. Leave about $\frac{1}{4}$ " (6 mm) jacket seam allowance and $\frac{3}{8}$ " (1 cm) facing.

Press the facing seam open.

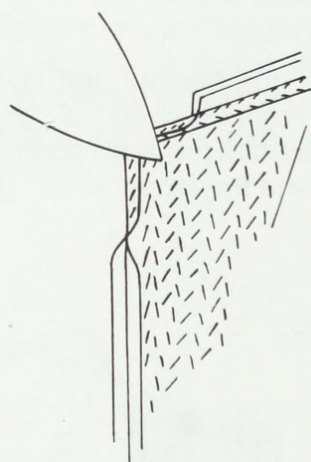
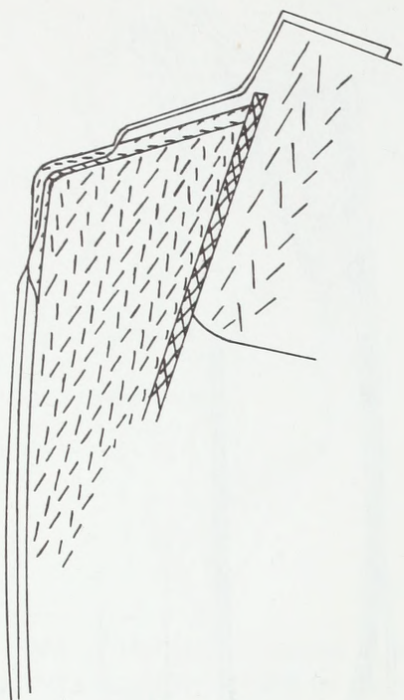

The tip of the lapel will be flatter if the seam allowance inside is controlled and evenly distributed. To accomplish this, both seam allowances are drawn onto the tape at the lapel tip, one at a time. A shirring thread is first run through the seam allowance and pulled. The seam allowance is then tacked into the tape, using silk thread. These stitches should not be visible on the right side of the fabric.

The tip of the lapel is then pressed flat.

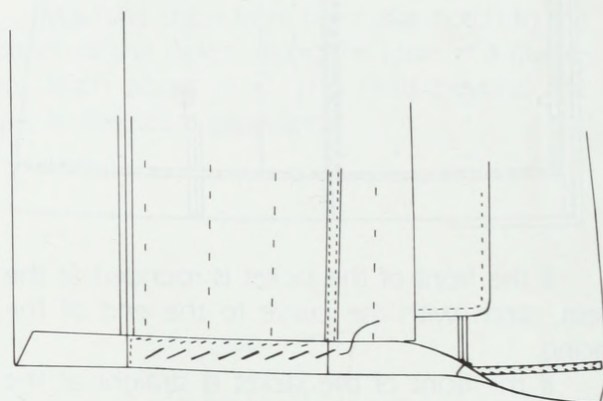
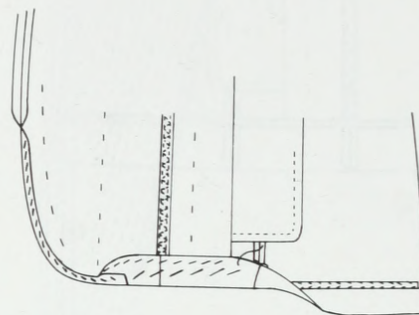

If the front of the jacket is rounded at the hem, the seam allowance at the curve is also tacked into the tape.

If the front of the jacket is straight at the hem, the facing seam allowance is tacked into itself at the hem.

The hem, on both straight and rounded jackets fronts, is now basted up with large diagonal stitches, and then stitched into the canvas with a smaller diagonal stitch. (We'll leave the hem beyond the canvas for the moment.)

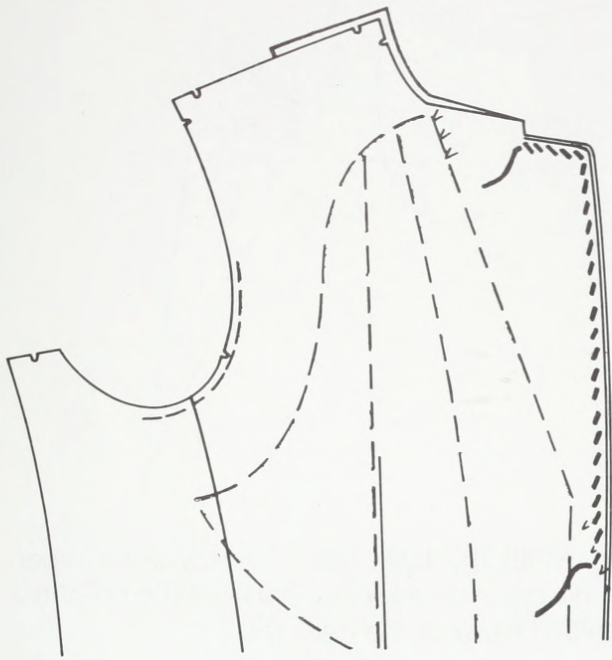

Working from the jacket side, baste from the bottom of the roll line, up and across to the collar notch or from the collar notch down (depending on which hand you sew with and which side of the jacket you are preparing). As you baste, bring the facing seam to the jacket side, so that it will not be seen when the jacket is worn.

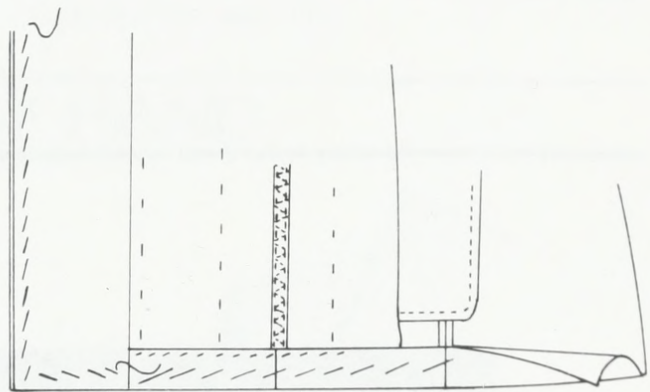
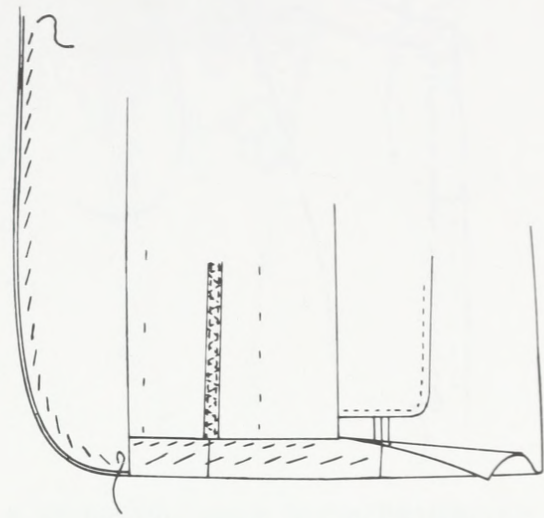

From the bottom of the lapel to the hem, the basting is done on the facing side, and the seam is drawn towards the facing side so that it will not be visible when the jacket is worn.

On a jacket with a straight front, make sure that the facing is turned up so that it is a bit shorter than the jacket, and will not be seen from the outside.

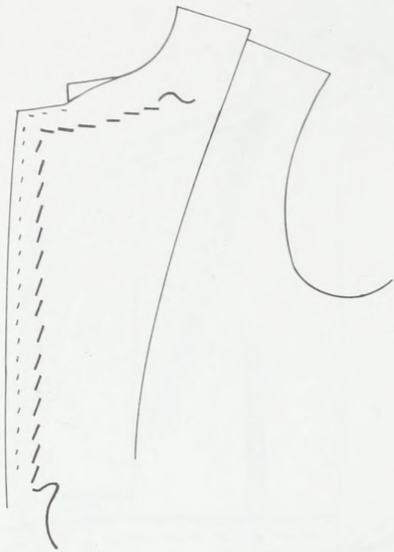

On the facing side, baste up from the bottom of the roll line once more and continue across, about 1" (2.5 cm) below the top of the tape. These stitches are about 1/2" (1.3 cm) long and are placed comfortably, without pulling or tautness.



With the lapel rolled, as it will be when worn, baste on the diagonal from the tip of the lapel, in towards the roll line.

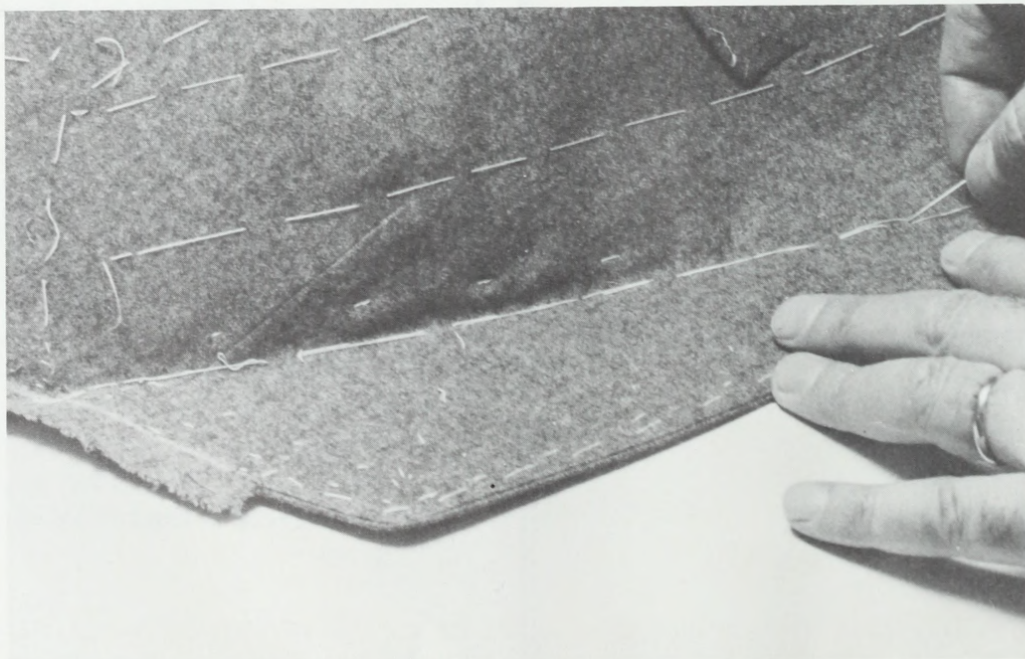

From the jacket side, baste the length of the roll line, catching the facing underneath.

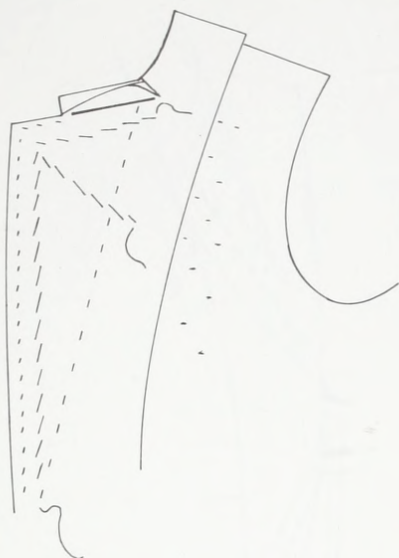

Chalkmark a straight line across the top of the lapel from the collar notch to $\frac{1}{2}$ " (1.3 cm) past the roll line. The top of the tape should be directly under this chalkline.

Slash the facing (not the jacket) from the neck edge to this $\frac{1}{2}$ " (1.3 cm) point.

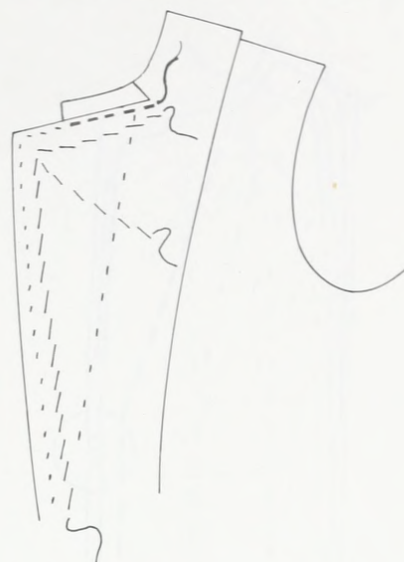

Fold the facing along the chalkline and baste it in place, just covering the tape underneath. Trim, if necessary before folding.

Press the top of the lapel and slip stitch from the collar notch to $\frac{1}{2}$ " (1.3 cm) past the roll line. The facing is now pressed before continuing (see illustration on page 115).

ATTACHING FACING BY HAND

To attach the facing by hand, the seam allowance at the outer edge of the lapel and down the front of the jacket should be trimmed to $\frac{3}{8}$ " (1 cm). The seam allowance from the tip of the lapel to the collar notch should be $\frac{1}{4}$ " (6 mm).

Snip the collar notch "almost" to the tape, and using the edge of the tape as a foldline, begin stitching the seam allowance onto the tape. Use a diagonal stitch, with silk finishing thread, catching the tape and the canvas.

Be gentle with the fabric. The seam allowance should simply fold onto the tape, and not be pulled tightly.

The hem is also folded up, using the tape as a guide, and diagonal-stitched into the canvas.

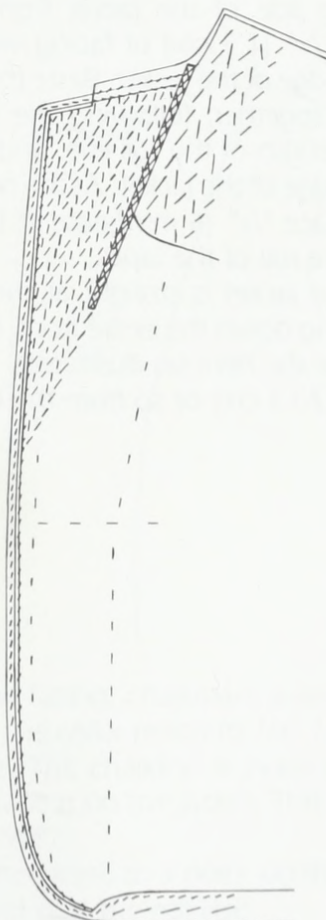

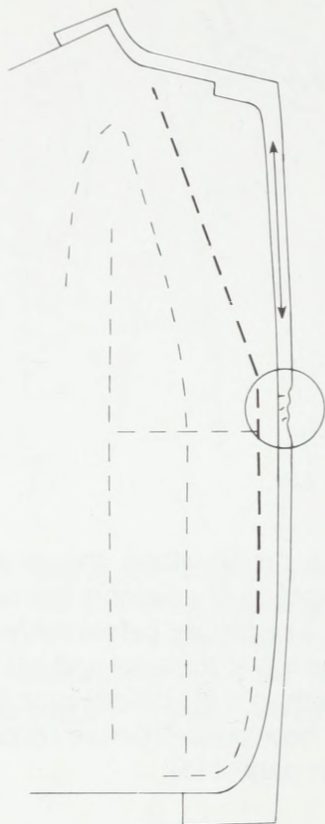

Place the wrong side of the facing (which has been steam pressed into shape, page 115) to the wrong side of the jacket front, leaving a generous $\frac{1}{2}$ " (1.3 cm) of facing visible around the outer edge of the jacket. Baste the facing and the jacket together, following the stitches that mark the length of the roll line, and then down the front edge of the jacket. At the bottom of the roll line, place $\frac{1}{4}$ " (6 mm) ease in the facing to facilitate the roll of the lapel.

If your jacket is straight at the hem, continue basting down the entire front. If your jacket curves in at the hem (as illustrated), stop basting about 8" (20.3 cm) or so from the bottom.



Jackets which are shaped at the bottom front will be inclined to curl outwards, away from the body, unless the facing is manipulated to prevent this. If the bottom edge of the jacket is curled inwards, and basted to the facing while held in this position, the finished jacket will incline gently towards the body at the front edge.

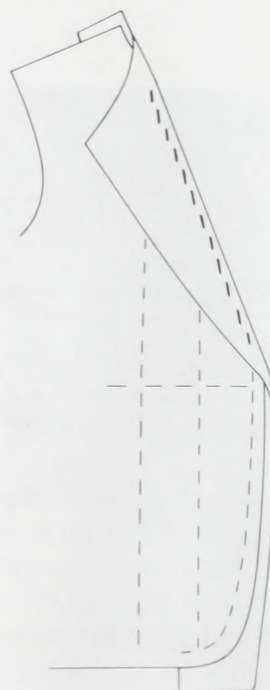

With the lapel rolled in the position it will take in the finished jacket, baste a row of diagonal stitches, parallel to the roll line.



Baste across the top of the lapel, and down to the bottom of the roll line, keeping the stitches about 1" (2.5 cm) away from the edge of the jacket lapel.

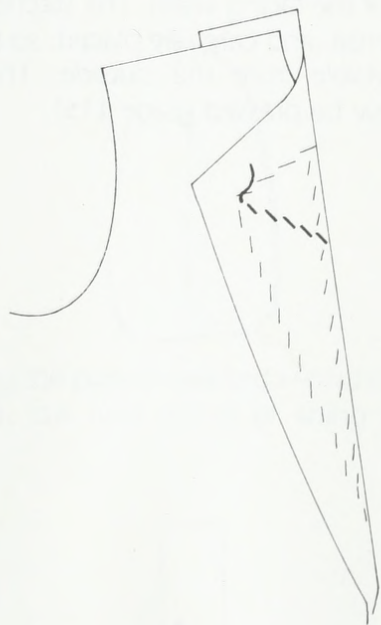

With the lapel still rolled, baste a diagonal line of stitches from the tip of the lapel basting stitches, to just past the roll line.

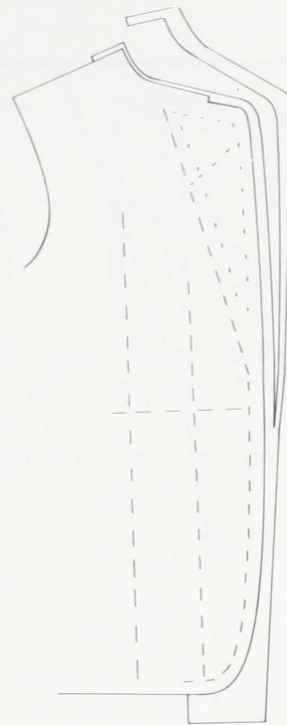

Trim facing seam allowance to $\frac{3}{8}$ " (1 cm) from collar notch to the bottom of the jacket. The facing from collar notch to shoulder is just about even with the jacket.



On the facing, chalkmark a line which extends from the collar notch to $\frac{1}{2}$ " (1.3 cm) past the roll line. The chalkline is exactly where the top of the tape is on the jacket. This line is called the *gorge line*.

Snip the facing to a point on the gorge line $\frac{1}{2}$ " (1.3 cm) past the roll line.

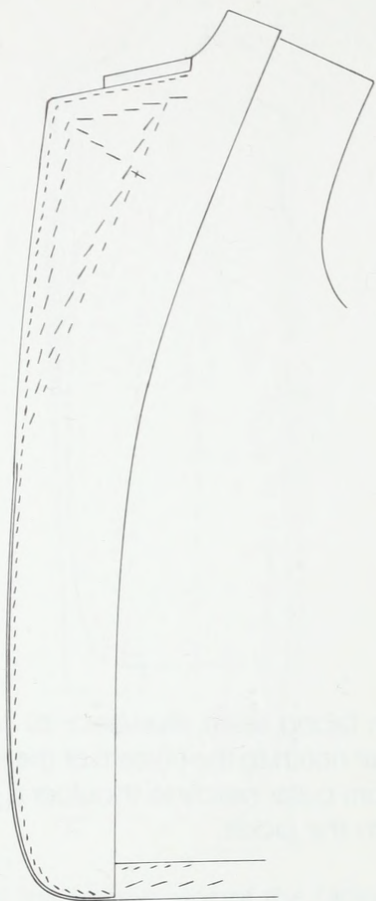

Fold and baste the facing seam allowance along the gorge line and down the front of the lapel. Allow facing to extend about $\frac{1}{16}$ " (1.5 mm) beyond the jacket lapel, so that the facing seam will not be visible when the jacket is worn.

The facing seam, from the bottom of the roll line to the bottom of the jacket, should not be visible on the right side of the jacket. Therefore, as you baste on the facing side in this area, allow about $\frac{1}{16}$ " (1.5 mm) of the jacket to extend beyond the facing.



Using silk finishing thread, slipstitch along the edge of the facing seam. The stitches should be quite small, and carefully placed, so that they are not visible from the outside. The facing should now be pressed (page 115).

THE FACING POCKET

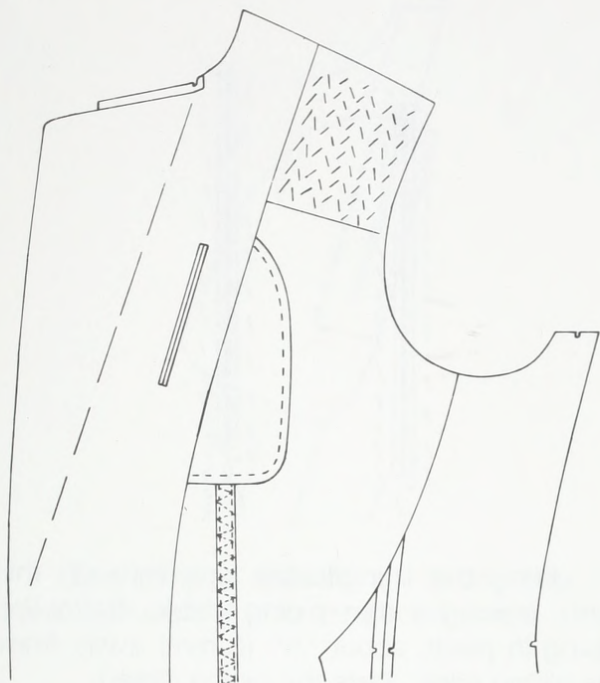

A small double-piping pocket may be constructed in the facing if you wish, to be used for small flat objects such as theatre tickets, or paper money. (Also see LINING POCKET on page 134.)

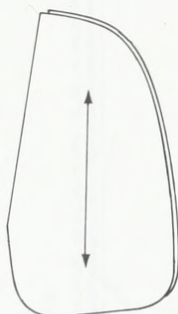

Using the pattern marked FACING POCKET on page 305, cut two pieces of lining for each pocket.



For a facing pocket with a 5" (12.7 cm) opening, cut a bias strip of lining 7" by 3" (17.8 by 7.6 cm).



Cut a bias strip of woven fusible interfacing, 6" by 2" (15.2 by 5 cm). Press the fusible to the lining strip, $\frac{3}{8}$ " (1 cm) from the left edge, and $\frac{1}{2}$ " (1.3 cm) from top and bottom.



Draw a 5" (12.7 cm) pocket opening line down the center of the fusible, and press the right-hand margin of lining up onto the fusible.

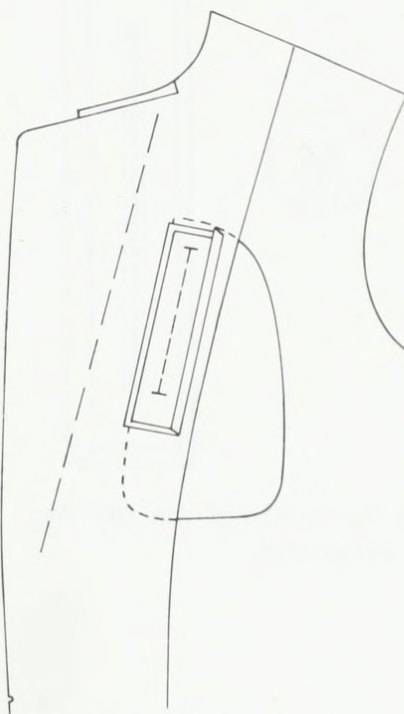

Place one of the lining pieces under the facing at the center of the lapel. Place the lining/fusible unit on top of the facing with the pocket opening line extending at least $1\frac{1}{2}$ " (3.8 cm) beyond the lapel roll line, and the fold on the lining/fusible unit away from the roll line.

Baste the lining/fusible unit to the facing, catching the pocket shape underneath. Baste on the pocket opening line.

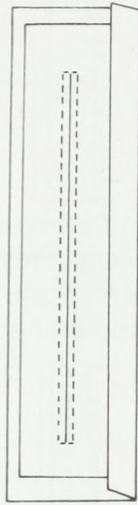

Using a small machine stitch, sew around the pocket opening line, $\frac{1}{8}$ " (3 mm) from the line.

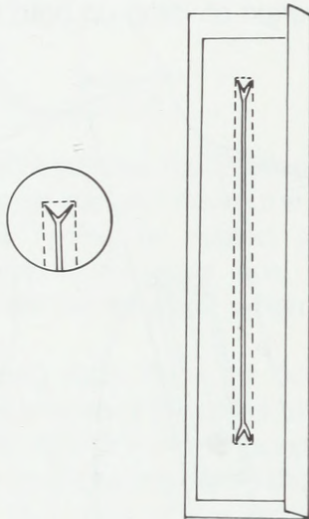

Slash the center of the stitching, and cut prongs at either end.

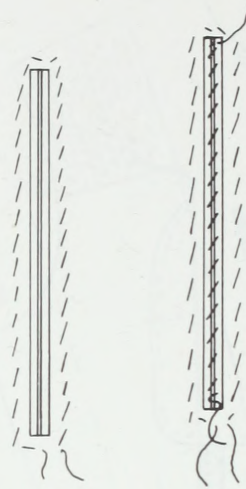

Bring the lining/fusible unit through the slash, leaving a thin piping visible. Baste the piping in place, about $\frac{1}{4}$ " (6 mm) away from the piping edge. Baste the piping closed.



Machine-stitch on the seamline at the top and bottom of the piping, and along the side of the piping *furthest* from the lapel roll line.

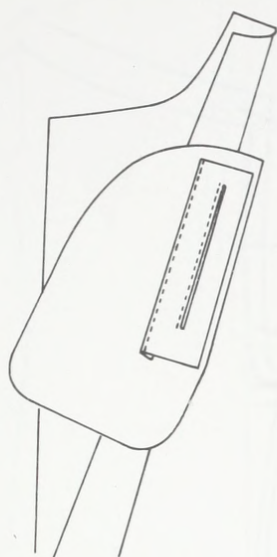

On the inside, topstitch the folded edge of the lining/fusible unit to the pocket shape.



On the inside, sew around the outer edge of the pocket shapes.
The facing pocket is complete.

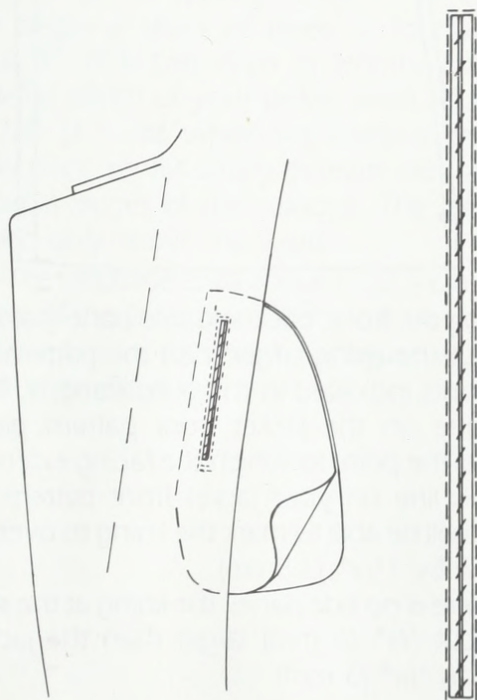

Place the second pocket shape under the first, matching the edges.

Machine-stitch on the seamline at the top and bottom of the piping, and along the side of the piping *nearest* to the lapel roll line.

THE LINING

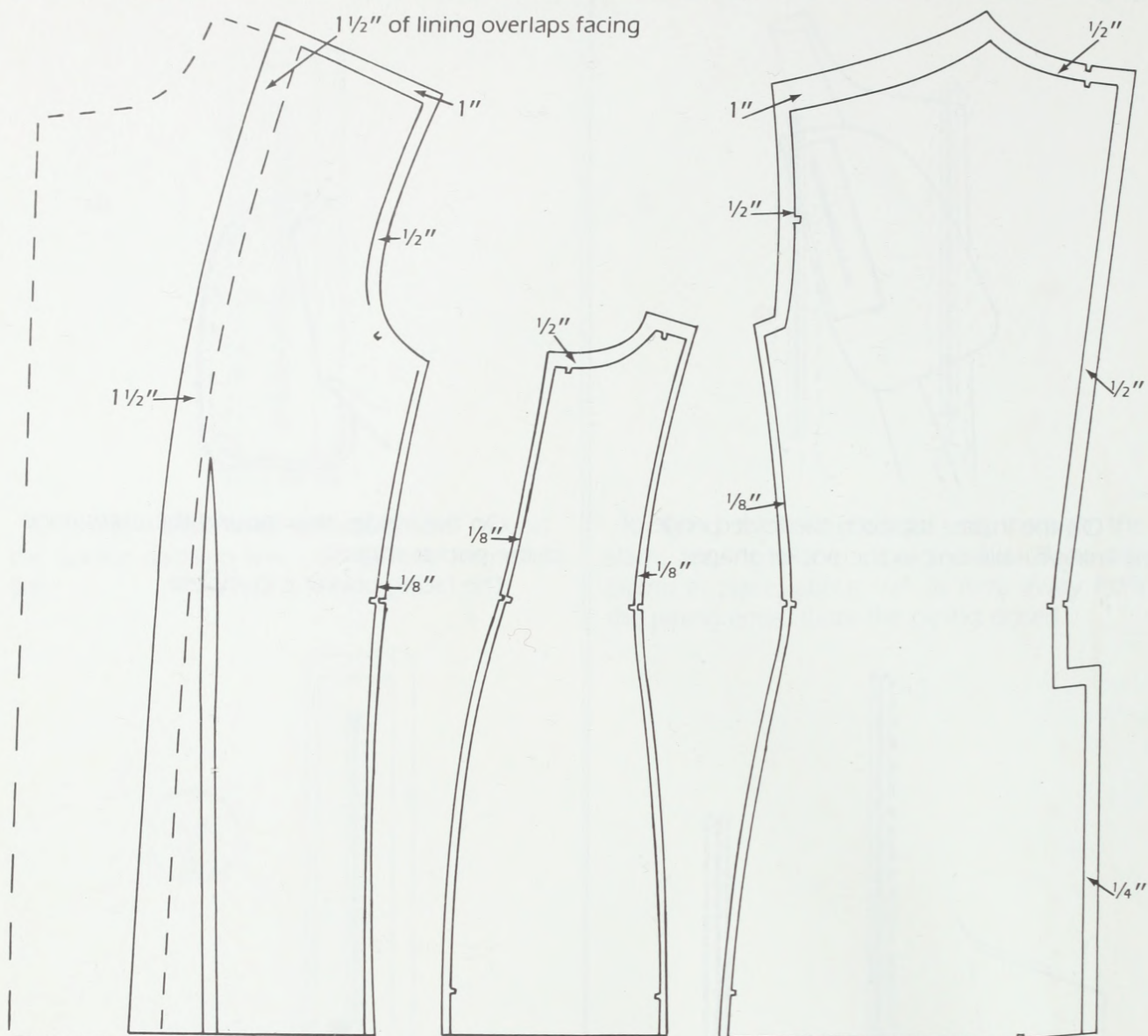

The purpose of a lining is to hide all the threads and seams and layers of canvas that have gone into the jacket's construction to this point. It also helps in sliding the jacket on and off without difficulty, and feels much better through a blouse than wool canvas does.

The lining should be cut slightly larger than the jacket, in both length and width, even though it is placed inside. The constant pulling and friction which the lining is subject to will cause tears in the lining fabric if there is not sufficient living ease.

Using the front, back and side panel pattern pieces, cut the lining larger than the pattern by the amounts indicated in these illustrations. The broken line on the jacket front pattern piece represents the point to which the facing extends. Draw this line on your jacket front pattern so that you will be able to mark the lining to overlap the facing by 1 1/2" (3.8 cm).

If there is no side panel, the lining at the side seam is cut 1/4" (6 mm) larger than the jacket rather than 1/8" (3 mm).



To afford added ease in the back lining, the seam at the center back is sewn in a scalloped fashion. This creates a controlled pleat which will open out only when required to by the body's movement. The seamline begins at the lining neck edge, at what was the seamline on the jacket pattern.

Sew down approximately 2" (5 cm) and then begin a series of three or four scallops, about 3" (7.6 cm) each in length, extending back the depth of your jacket seam allowance. The 1/2" (1.3 cm), which we added to the lining center back, serves simply as seam allowance for the inner edges of the scallops. The pleats are needed only above the waist.

The stitchline ends about 1" (2.5 cm) below the top of the lining vent. If there is no vent, the stitchline below the waist continues along the jacket seam allowance.

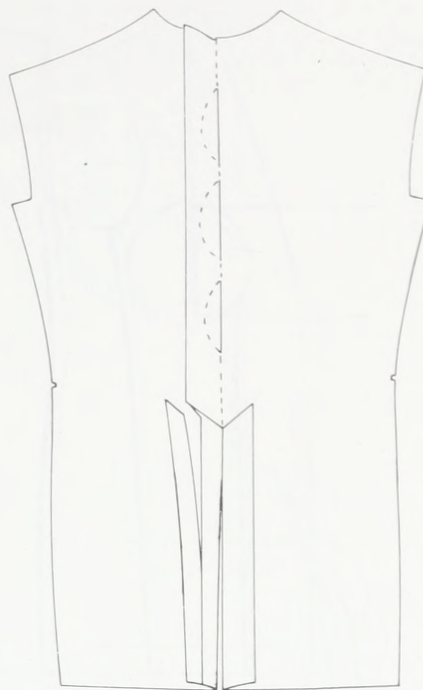

Above the vent, press the center back lining seam allowance to the left. Slash the top of the right vent almost to the stitchline. Trim 1" (2.5 cm) lengthwise from the left vent.

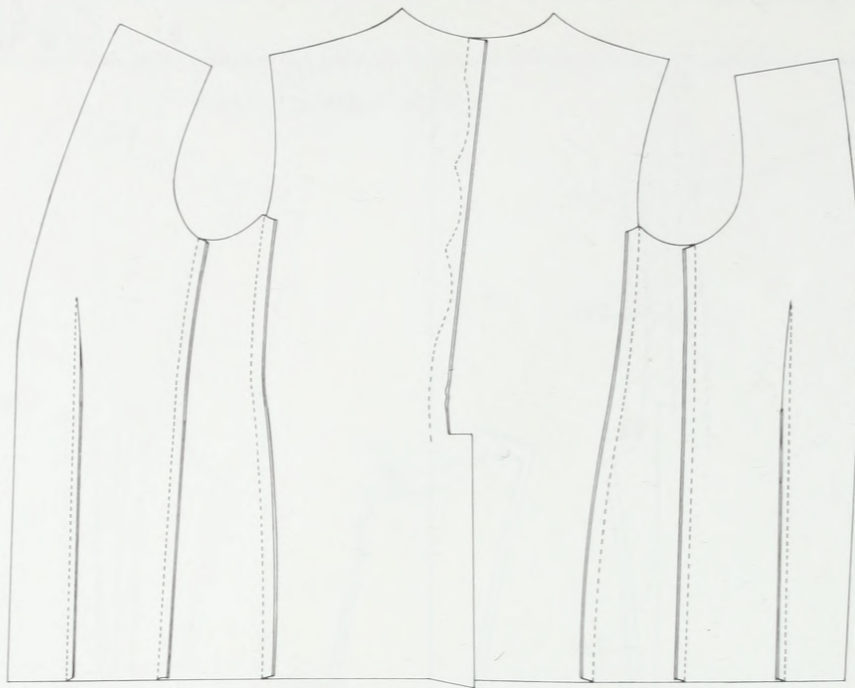

Sew the front, back, and side lining pieces together, using the same amount of seam allowance as in the jacket. Leave the shoulder seam open. Press all seams to the side rather than pressing them open.

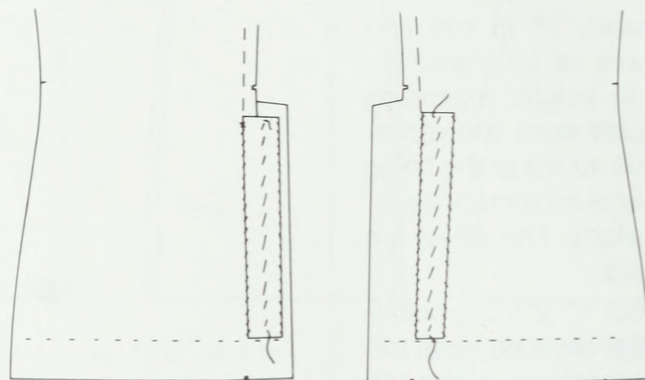

Before stitching the jacket center back seam, we'll reinforce the vent area with cross-grain strips of pocketing, about 2" (5 cm) wide, from the top of the vent to the hem foldline. Draw a chalkline from the bottom of the center back stitchline to the vent notch at the bottom of the jacket. Use the chalkline as a guide for the placement of the pocketing reinforcement pieces.

Because the left side of the vent will fold and the right side will lie flat in the finished jacket, the pocketing pieces are placed in slightly different positions on either side, to accommodate that difference. (You will note that left and right sides of the jacket are reversed in the illustra-

tions, since we are viewing the jacket from the inside.)

On the right side of the jacket back, place the reinforcement on the vent extension, flush with the chalkline. Leave $\frac{1}{2}$ " (1.3 cm) of the garment fabric visible at the edge.

On the left side of the jacket back, the reinforcement is placed, not on the vent extension, but directly to the right of it, flush with the vent chalkline.

Baste the reinforcement pieces in place and slip-stitch the sides using silk finishing thread. The stitches should not be visible on the right side of the garment fabric.

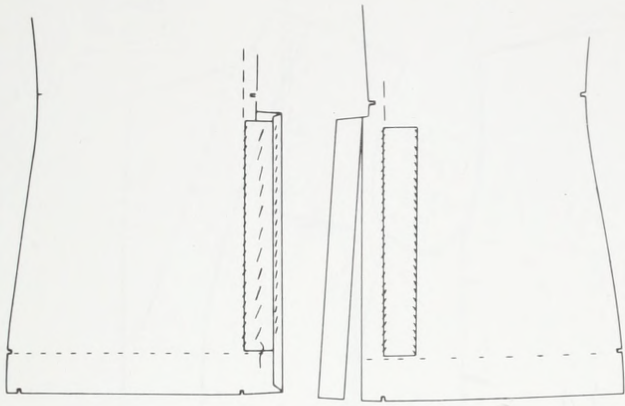

On the right vent, fold over the 1/2" (1.3 cm) of garment fabric at the vent edge, and diagonal stitch it in place. The stitches should not show through on the right side.

Trim the left vent extension completely, so that the seam allowance down the center back is even from top to bottom.

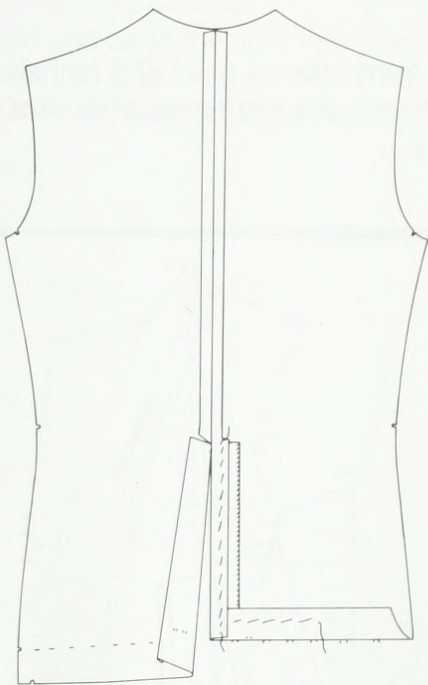

Machine-stitch the center back seam to 1" (2.5 cm) below the top of the vent. At the top of the right vent, slash the garment fabric almost to the stitchline.

Baste up about half the hem on either side of the jacket back, and fold the vent in place.

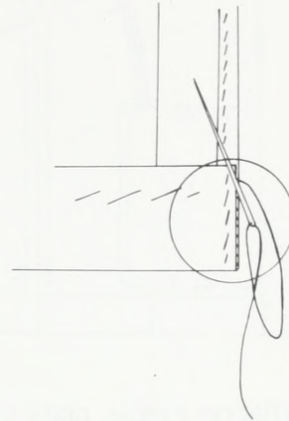
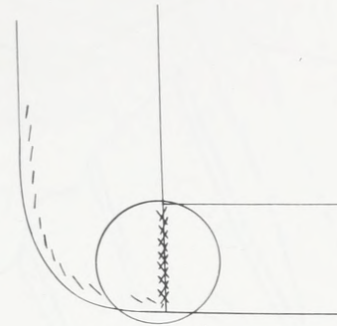

Machine-stitch the back of the jacket to the side panels, and press the seams open.

Baste up the jacket hem and press.

Fold the top edge of the jacket hem forward and hem-stitch it in place.

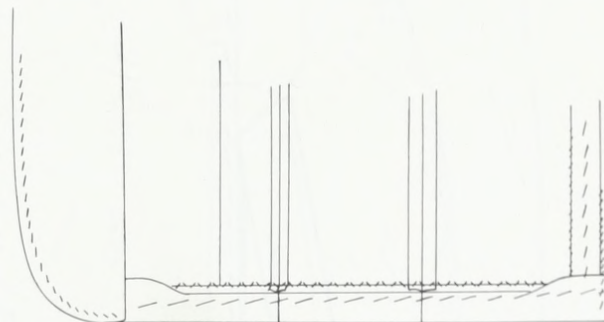

The raw edge of the facing, and that of the left vent, are double cross-stitched to the hem.

Slip-stitch the hem along the edge of the right vent.

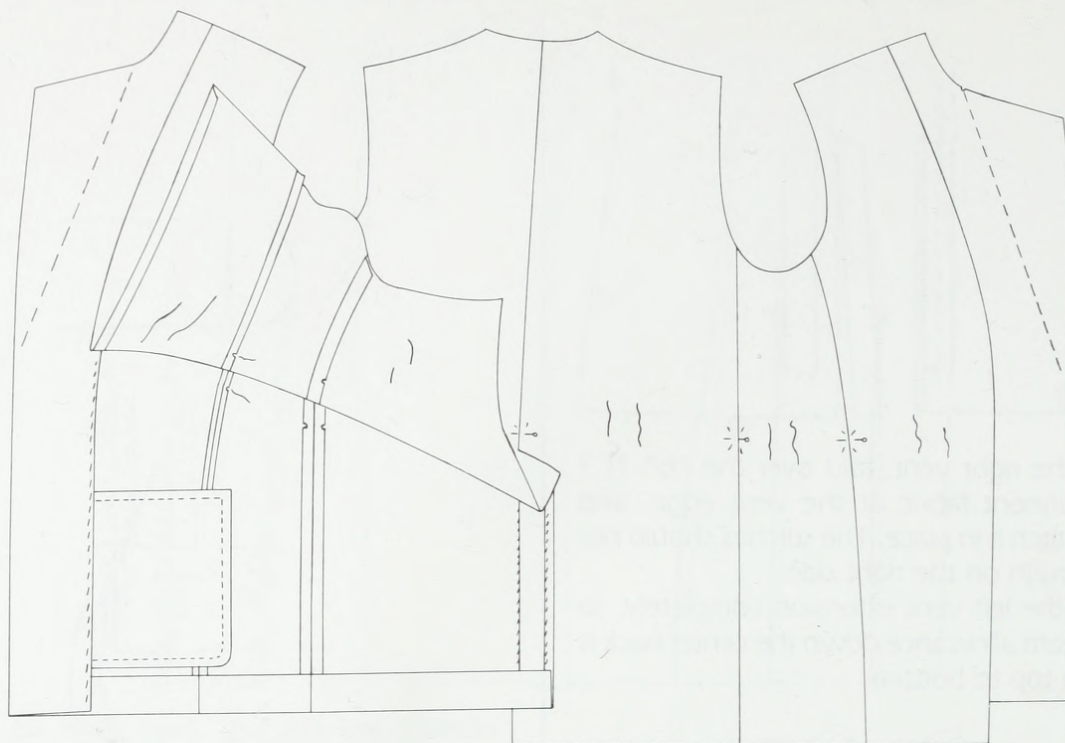

Working flat on a table, place the lining and the jacket together, wrong side to wrong side, matching waistline notches. Pin the lining to the jacket at the waistline. Baste the lining and jacket

together from neckline to 1" (2.5 cm) above the top of the vent, placing a small amount of ease in the lining.

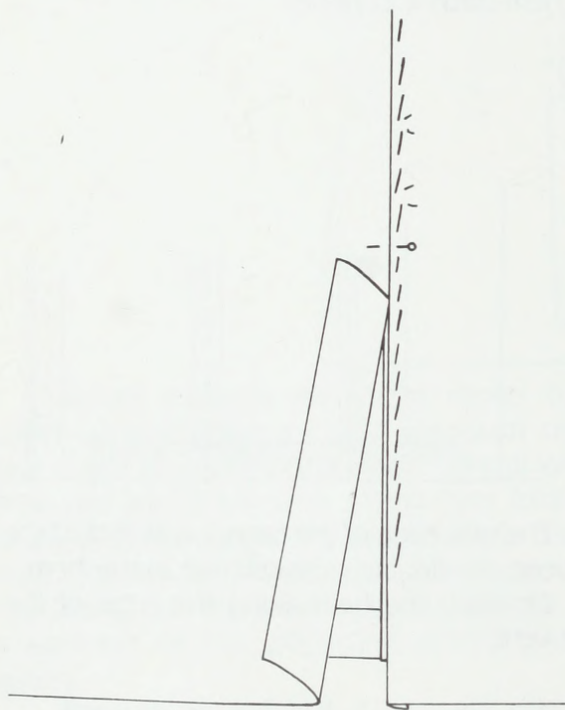

Fold the lining over the left vent, leaving about 1/4" (6 mm) of garment fabric showing at the edge. Baste the lining in place to just above the top of the hem.

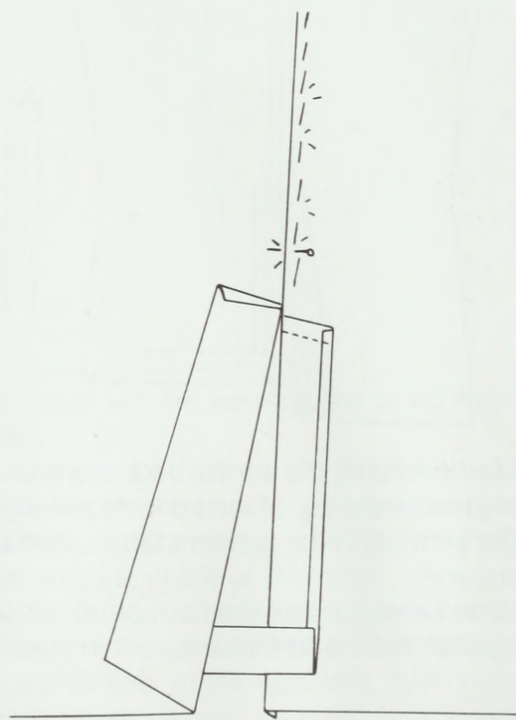

The right vent is now placed on top of the left vent, and back-stitched securely along the top. Stitch through to the top of the left vent, which is underneath, but do not go through to the right side of the fabric.

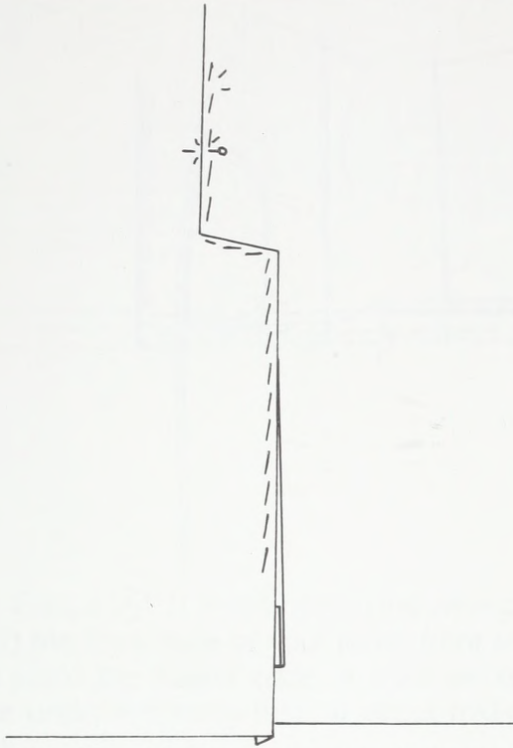

Fold and baste the right vent lining over the right vent, so that only a narrow edge of garment fabric is visible at the vent edge.

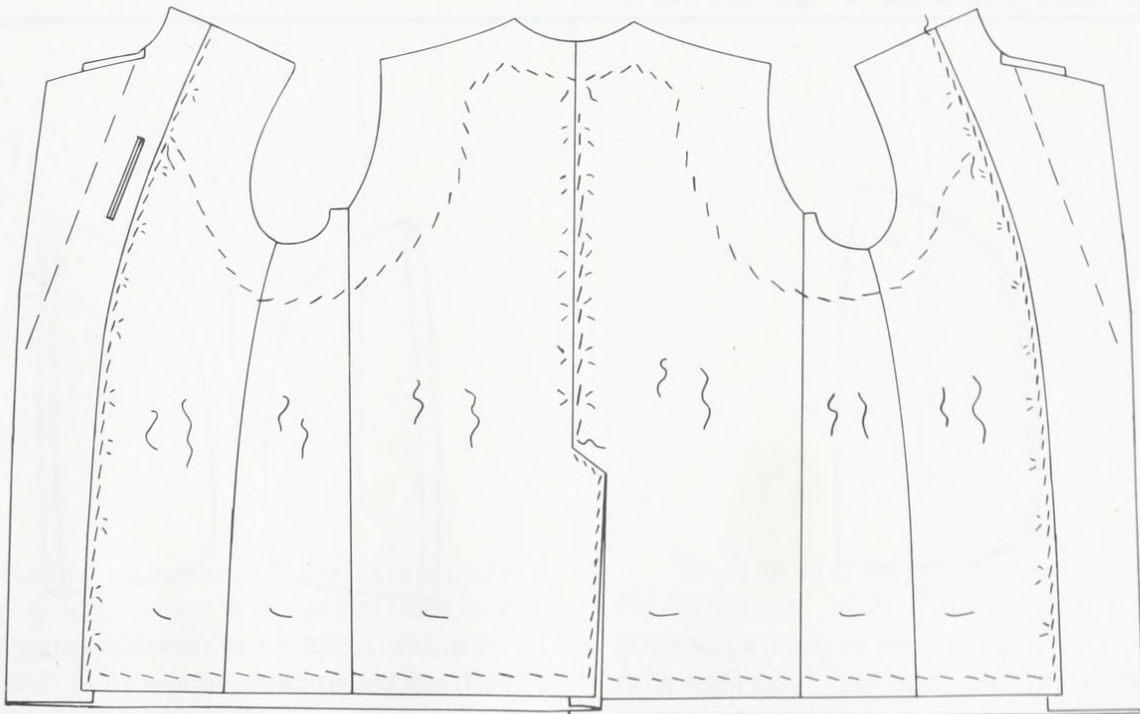

The lining is now basted to the jacket as illustrated, maintaining sufficient room around the shoulder and armhole for the sleeve to be set without interference. The lining is simply folded along the edge of the facing and basted.

Baste up the lining hem so that it ends about $\frac{3}{4}$ " (1.9 cm) above the jacket hem. Place your stitches about 1" (2.5 cm) above the lining hem fold, so that you will be able to lift the lining and hem-stitch one layer of it into the jacket hem. This procedure creates a fold at the lining hem, which affords the lining lengthwise ease.

The lining at the edge of the vent is finished with a prick-stitch.

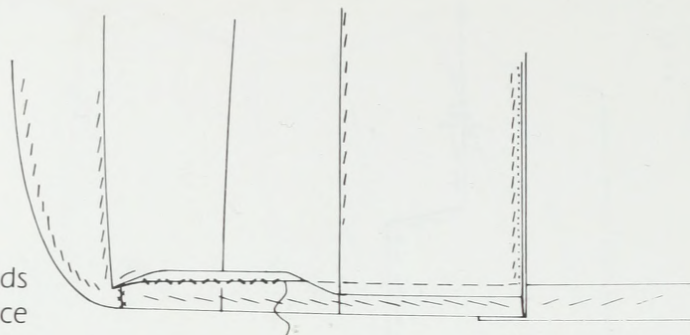

THE LINING POCKET

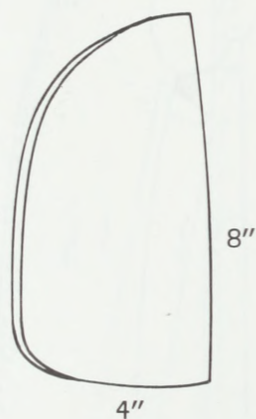

If you have not chosen to place a pocket in the jacket facing (see page 125), you may wish to create a small pocket in the lining on one or both sides of the jacket front.

From lining fabric, on the straight grain, cut two pieces of pocketing, 8" (20.3 cm) long and 4" (10.2 cm) wide. Taper the pocketing so that it is narrower at the top, as illustrated.

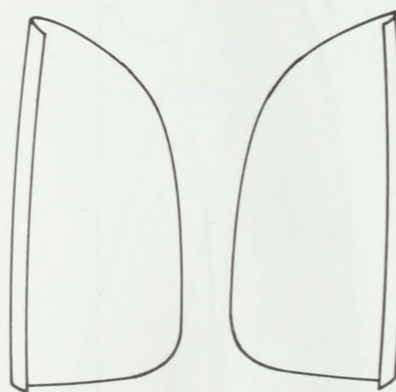

Press a $\frac{1}{2}$ " (1.3 cm) hem along the length of each pocketing piece.



Press a $1/2$ " (1.3 cm) hem to the wrong side along the front edge of your jacket front lining; and place the folded edge of your pocketing piece under the lining fold, at about mid-chest level.

Prick-stitch along the edge of the lining fold, beginning about $1\ 1/2$ " (3.8 cm) below the top of the pocketing piece, continuing for 5" (12.7 cm). Both the pocketing piece and the lining are caught in these stitches.

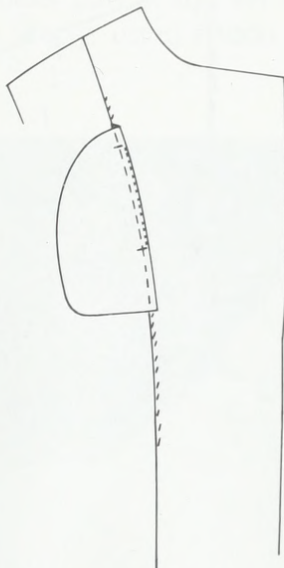

Place the folded edge of the second piece of pocketing on the edge of the jacket front facing. The placement level here must coincide with that chosen for the lining, since these two pieces will soon be placed together.

Prick-stitch along the edge of the pocketing fold, beginning about $1\ 1/2$ " (3.8 cm) below the top of the pocketing piece, and continuing for 5" (12.7 cm). Both the pocketing piece and the facing edge are caught in these stitches.

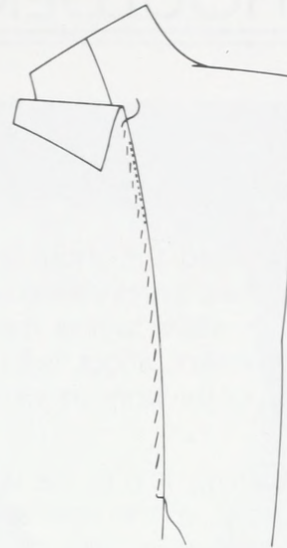

Baste the folded edge of the jacket front lining along the edge of the jacket facing, matching the 5" (12.7 cm) rows of stitching on both facing and lining.

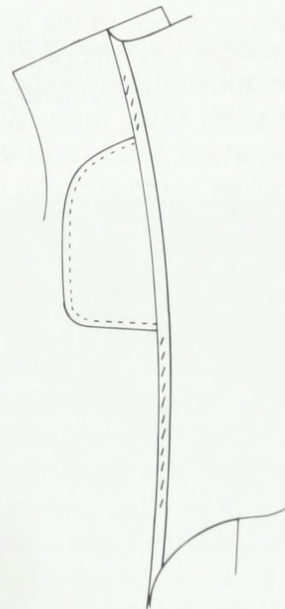

Stitch around the edges of the two pocketing pieces, to finish the inside of the lining pocket.

THE SHOULDER SEAMS

Before stitching the shoulder seams, the front shoulder must be reinforced with a strip of lining. Cut a semi-bias strip of the lining to be used as reinforcement, about $\frac{3}{4}$ " (1.9 cm) wide and the length of the front shoulder seam.

Baste the lining strip to the wrong side of the garment fabric, at the front shoulder edge. Catch the garment fabric only, allowing the canvas and the lining to fall freely.

Baste the front and back of the jacket together at the shoulder seams. Since the back shoulder edge is about $\frac{1}{2}$ " (1.3 cm) longer than the front (page 12), there will be rippling along the edge of the back seam when the shoulder is basted. Bring the ease to the center of the shoulder, leaving 1" (2.5 cm) or so at either end without rippling.

The extra ease at the back of the shoulder is there to provide added room for the curve of the back in the shoulder blade area. We can eliminate the rippling at the seam, and still retain the ease in the shoulder blade area, by steam pressing carefully, before the shoulder seam is machine-stitched.

Steam press on a flat surface, allowing the iron to extend onto the fabric no more than $1\frac{1}{2}$ " (3.8 cm) or so. Bring the iron flat down on top of the ripples at the shoulder edge. The combination of heat and moisture on the flat surface, should cause the ripples to shrink away.

If the iron is allowed to extend further onto the shoulder area, while still on a flat surface, the ease in the shoulder blade area will also shrink away, and the whole process will have been useless.

It is essential that this pressing be done while the shoulder seam is basted, and not yet machine-stitched. Once the seam has been machine-stitched, it will be impossible to eliminate the ripples.

Machine-stitch the shoulder seam, remove the basting, and press the seam open. Use a tailor's ham for pressing here, in order to protect the shape you have created.

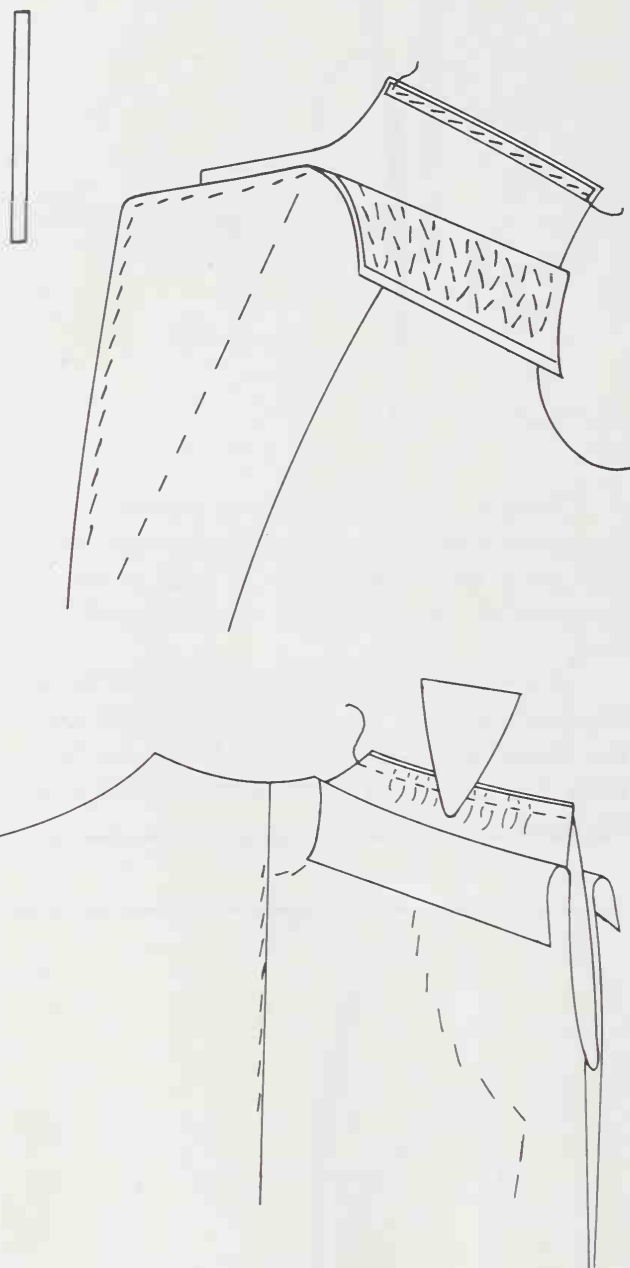

THE SHOULDER PADS

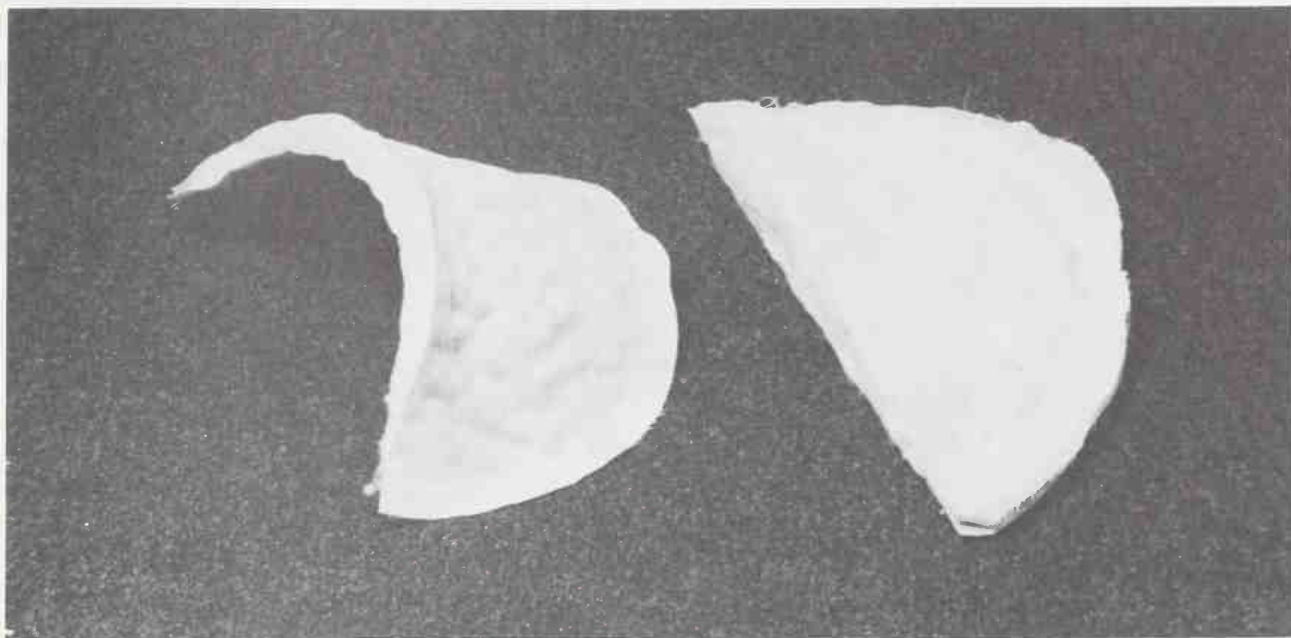

The shoulder pad at the right in this photograph is the best ready-made shoulder pad available. As you can see, it is flat and heavy, and does not coincide with the natural contour of the shoulder.

The shoulder pad at the left can be constructed quite simply, using cotton wadding as

the filler, and bias muslin as the top and bottom covering. (Use the SHOULDER PAD pattern on page 299 to cut the muslin coverings.)

Cotton wadding is available in bulk at upholstery supply stores; or, if you prefer, simply take the wadding from a pair of ready-made shoulder pads and reshape it.



Separate the wadding into thin layers, and create on the muslin shoulder-pad pattern, a smooth, sloping mound which tapers to nothing at the sides and back.

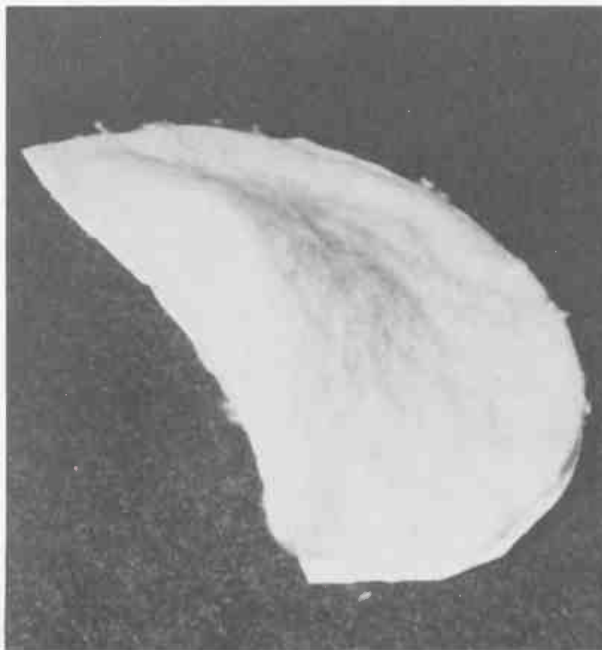

Press down gently at the front centermost edge of the pad and measure the thickness. The amount of padding most flattering to your shoulder has been determined at the muslin fitting.

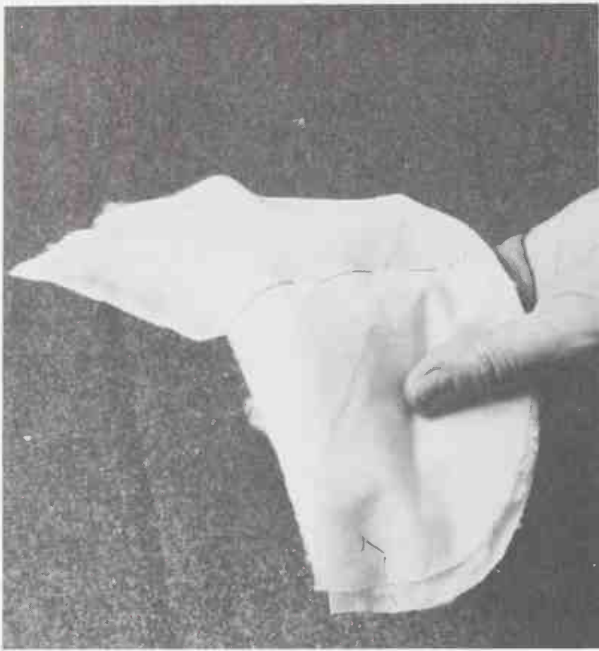

Cover the wadding with a second piece of muslin and baste across the top of the pad to anchor the layers together. By pulling the bottom layer of the muslin cover down a bit, and tacking at either end, the pad begins to take shape.



Pad-stitch the shoulder pad from end to end, beginning at the center and working in rows, first towards the front, and then, from the center, towards the back. The stitches go right through all layers of the filling, and should be left comfortably without pulling.



Trim slightly across the front of the pad and around the edges.

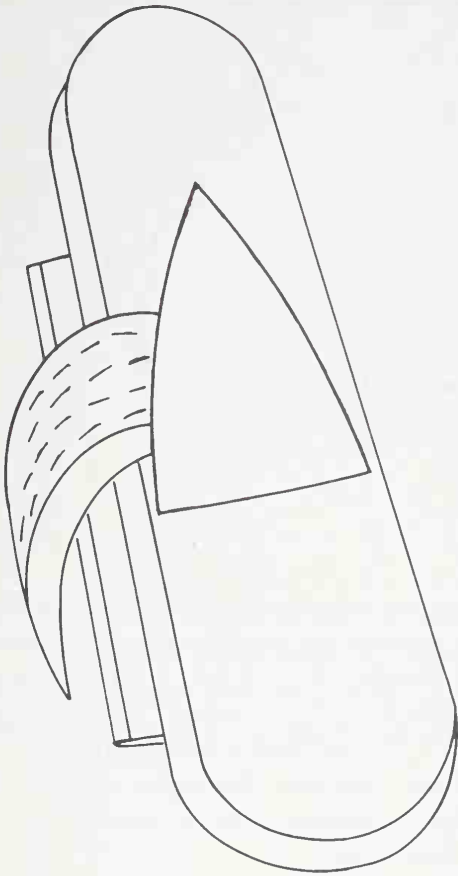

Press the shoulder pad, maintaining the curve you have created.

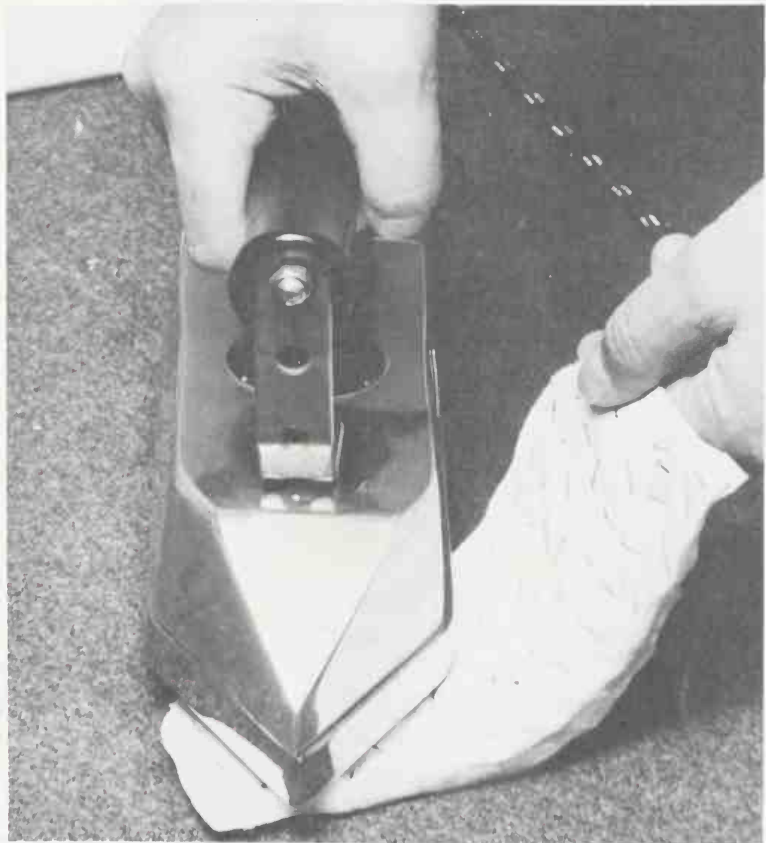
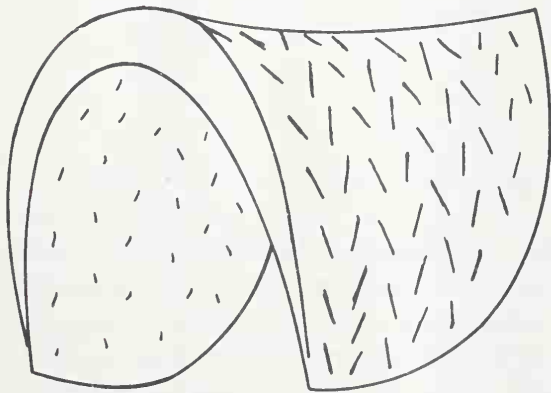

INSERTING SHOULDER PADS

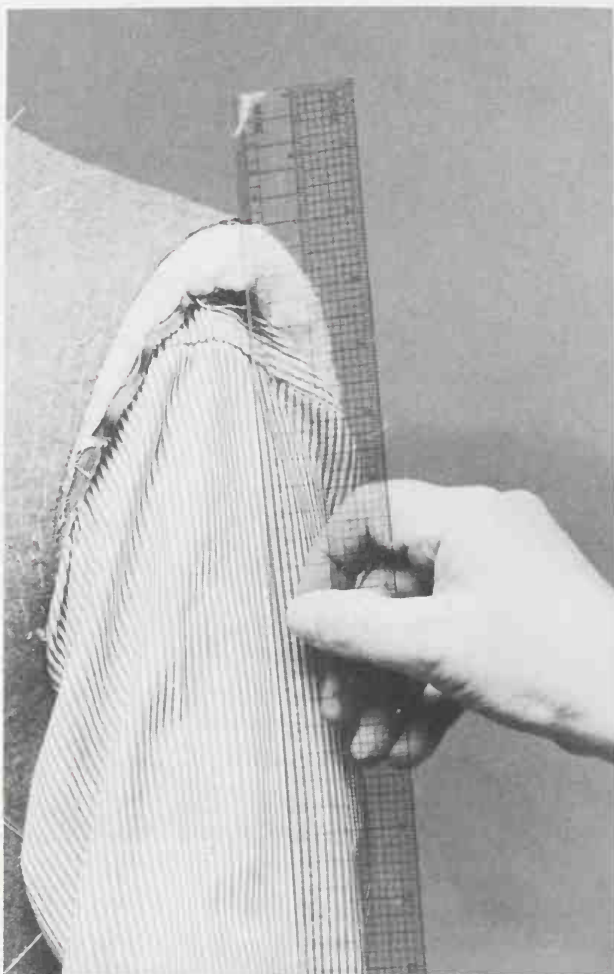

Before the shoulder pad is sewn into the jacket, check the shoulder width once more, with the pad in place.

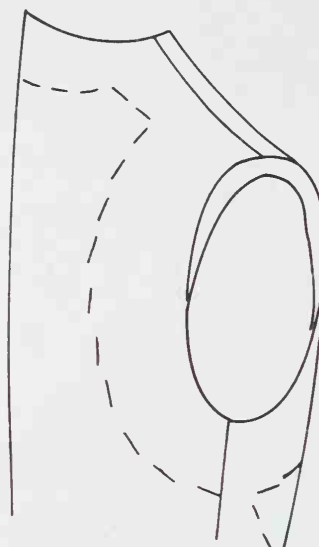

If the cutting edge at the top of the shoulder extends out beyond the shoulder edge, the fabric may need trimming. As a guide, place a ruler at the bicep, extending up towards the shoulder (see page 112). If the fabric extends out beyond the ruler at the shoulder, the jacket shoulder is too wide and should be trimmed before attaching the shoulder pad.

The shoulder pad is placed into the armhole of the jacket, so that the center of the pad is at the shoulder seam.

The pad should be between the lining and the canvas, at the armhole cutting edge.

Sometimes, when the top of the shoulder pad is at the armhole cutting edge, the ends of the pad are not. Pull the shoulder pad out until the ends of the pad are at the armhole cutting edge. You can trim the excess later.

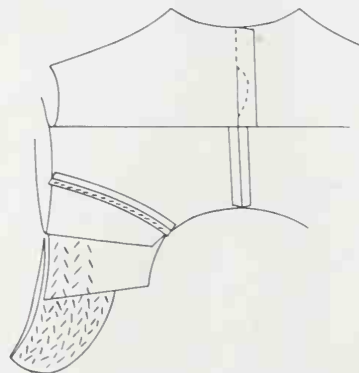

With the shoulder pad exactly in place, reach into the armhole and pin the shoulder pad to the canvas. The shoulder pad is now pad-stitched to the canvas, the stitches covering the entire area of the canvas touched by the pad. Stitch through all layers of padding.

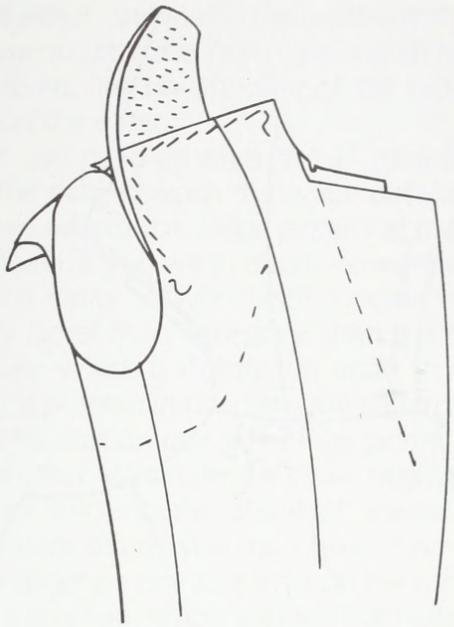

Smooth the front lining up over the shoulder pad and baste the lining to the pad along the armhole and across the top of the lining.

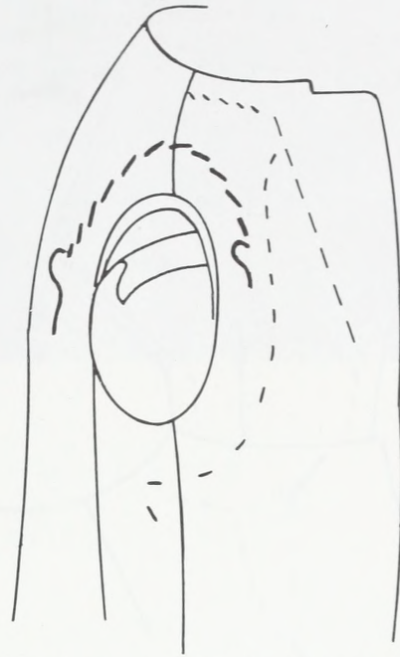

Smooth the jacket fabric out towards the armhole, and baste the entire length of the shoulder pad, about 3" (7.6 cm) in from the armhole edge. Catch the top layer of the shoulder pad as you baste.

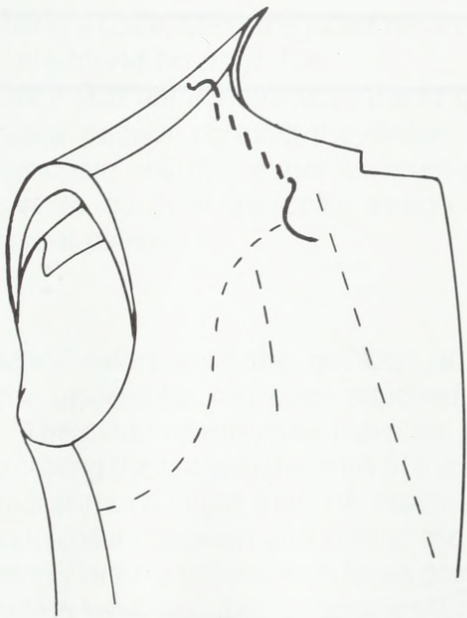

With one hand inside the shoulder area, give the shoulder a concave shape and baste along the front neck edge of the jacket, catching the facing.



The lining at the back of the jacket is still hanging loose at the shoulder. Smooth the back lining up over the shoulder pad and baste from the outside, right through the shoulder pad, to catch the lining. Baste from the bottom end of the shoulder pad up, stopping about 1" (2.5 cm) from the shoulder seam; and bring the needle through to the inside.

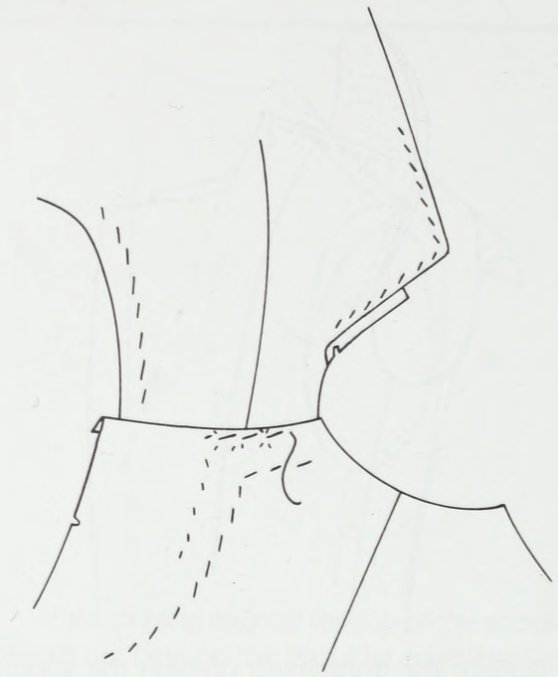
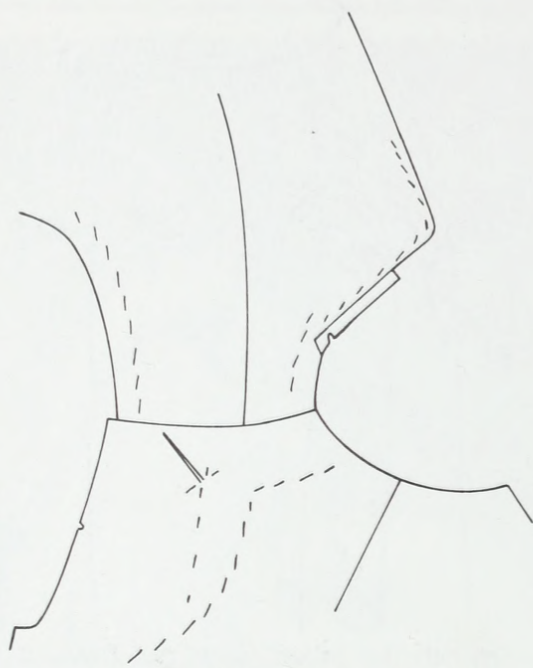

Fold the back lining across the shoulder, and baste across the fold, towards the neck edge. Place a bit of ease into the back lining as you baste. The lining is left loose, 3" (7.6 cm) in from the armhole edge.

THE COLLAR

The collar can be constructed by following the design lines of your pattern, or in a way that leaves room for a bit of your own designing. Essential to both methods of construction is the fit of the undercollar at the jacket neckline, from collar notch to collar notch.

If during the muslin fitting, you adjusted any of the seams that extend into the neckline, you are already aware that your undercollar pattern needs adjusting. You may, however, have "unintentionally" adjusted some of the neckline seams. The first step is to check the fit of the undercollar pattern.

To do this, first trim away the seam allowance on the undercollar paper pattern. You will eventually need this seam allowance, but it is much easier to check the fit of the paper pattern if the seam allowance is not in the way.

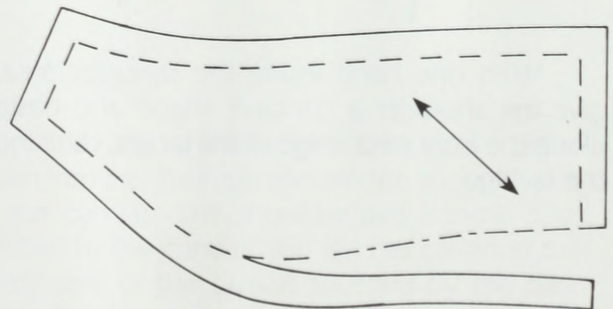

Chalkmark the neck edge seam allowance on the jacket, and match the undercollar pattern, stitchline to stitchline, from collar notch to center back seam, first on one side of the jacket, and then on the other.

If you need an extra $\frac{1}{8}$ " (3 mm) or so, to help the pattern reach the entire distance comfortably, add to the collar pattern at the center back seam. If you are in doubt, remember that it is much easier to work with a collar which is slightly larger than necessary, than it is to work with one which is slightly too small.

It is possible in checking the pattern, to find that it fits well on one side of the jacket, but not on the other. Whatever the cause (slight inaccuracies in stitching the shoulder seams, or the center back seam), you must now make a collar that is larger on one side than on the other. This is not a problem. Simply prepare both sides of the collar using the larger dimensions, and we'll adjust it later.

If you have made extensive alterations in your jacket pattern at the neckline and shoulder, it may be necessary to discard the collar pattern and to draft a completely new one. Instructions for drafting a collar, using the jacket neck edge as guide, are found on page 156.

Once you are content with the fit of your undercollar pattern, consider the design. At this point you are still free either to redesign the collar, or to go with the collar design of the commercial pattern.

Many tailors leave the question of design until the undercollar has been attached to the jacket. They leave themselves room for designing by cutting the top and the ends of the melton undercollar much larger than necessary. When the undercollar has been attached to the jacket, they simply draw a collar which looks good with the existing lapel, and trim the excess away. This is a simple procedure, and quite exciting if you have the desire to branch out a bit on your own.

On the other hand, the collars designed by commercial patternmakers are usually in tasteful balance with the jacket lapel, and you may have chosen this pattern largely because of this style. Know your options, make your choice and forge ahead.

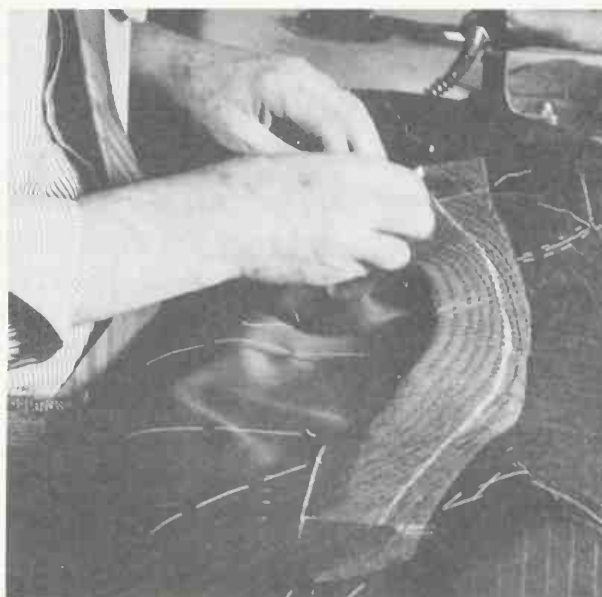

Our instructions for the construction of the undercollar will assume that you are following the lines of the commercial pattern. However, the instructions are appropriate for both methods of collar construction. The careful measurement of seam allowances at the top of the collar is not important if you are designing your own collar; however, the shape and seam allowances at the neck edge of the undercollar should be adhered to carefully.

CONSTRUCTING THE UNDERCOLLAR

The undercollar is constructed of collar melton and French canvas, pad-stitched together. If you can find good quality prepadded collar melton, in the color that you need, by all means use it instead of pad-stitching the melton

and French canvas together yourself. Because the quality of the prepadded collar melton varies greatly and the color choice is often limited, we give directions here for preparing and pad-stitching the undercollar yourself.

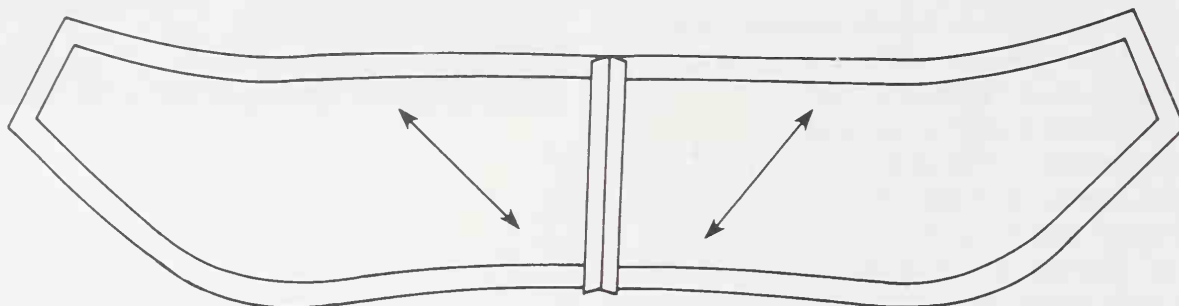

Cut from collar melton, in a color which coordinates with your garment fabric, two bias undercollar pieces. Leave $\frac{1}{2}$ " (1.3 cm) seam allowance at the outer edges and $\frac{1}{4}$ " (6 mm) seam allowance at the center back. Machine-stitch the center back seam and press it open.

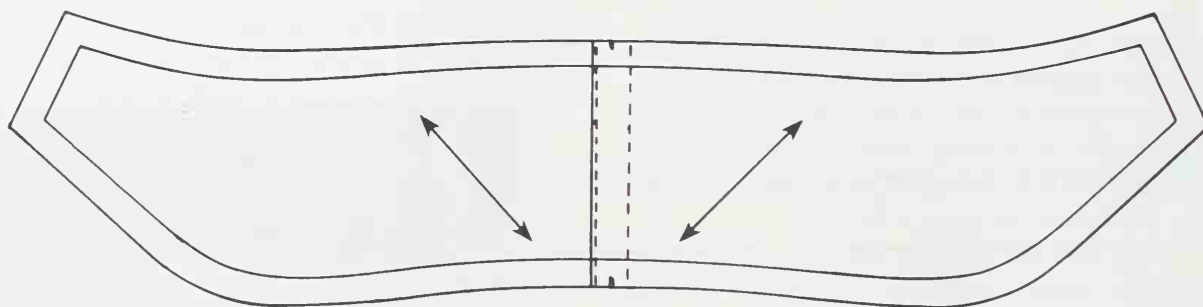

Using the same dimensions as in the collar melton, cut from French collar canvas, two bias undercollar pieces. Overlap the center back seam and topstitch by machine.

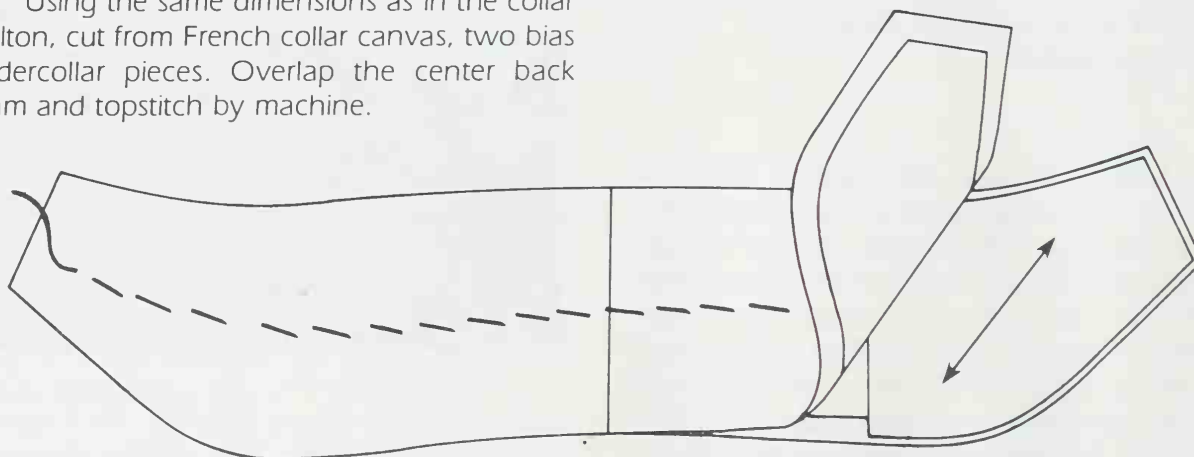

Place the French canvas on the wrong side of the collar melton, and between the two, at either end, place a bias piece of pocketing to add body to the front of the collar. The pocketing covers about one half of either side of the undercollar. Baste the French canvas, the pocketing, and the melton together.

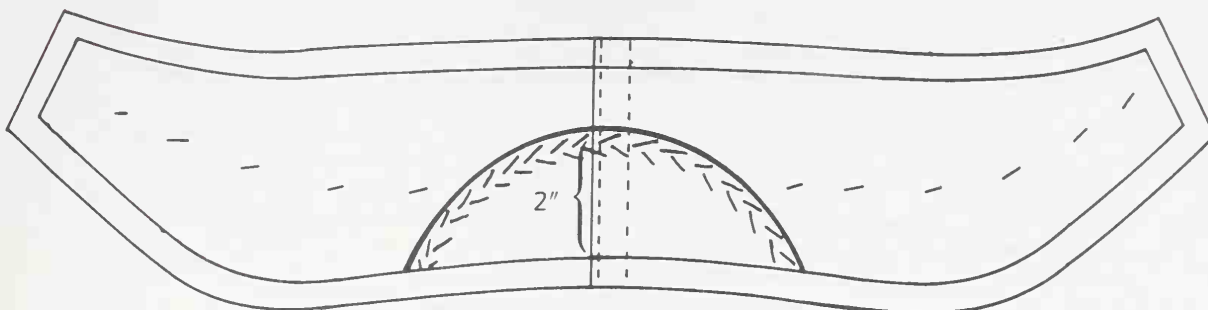

The French canvas is now pad-stitched (page 102) to the melton undercollar. We want the two fabrics joined, but still flexible enough to be shaped with the iron. To maintain this controlled flexibility, we'll pad-stitch in a semi-circular pattern, which coincides with the bias cut of the fabric.

Using a radius of about 2" (5 cm), draw a semi-circle at the neck edge stitchline of the

canvas undercollar. Pad-stitch inside and then, beyond the semi-circle, maintaining the circular pattern of stitches. Use silk finishing thread close in color to the collar melton, so that the stitches will not be noticeable on the right side of the undercollar. Pad-stitch only within the limits of the seam allowance which is drawn on the canvas.

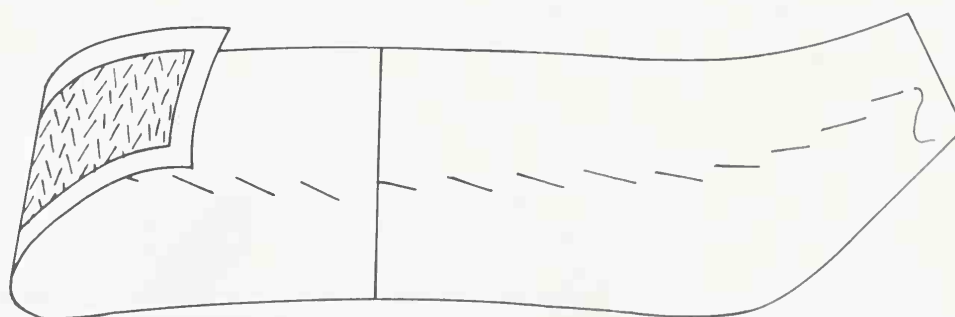
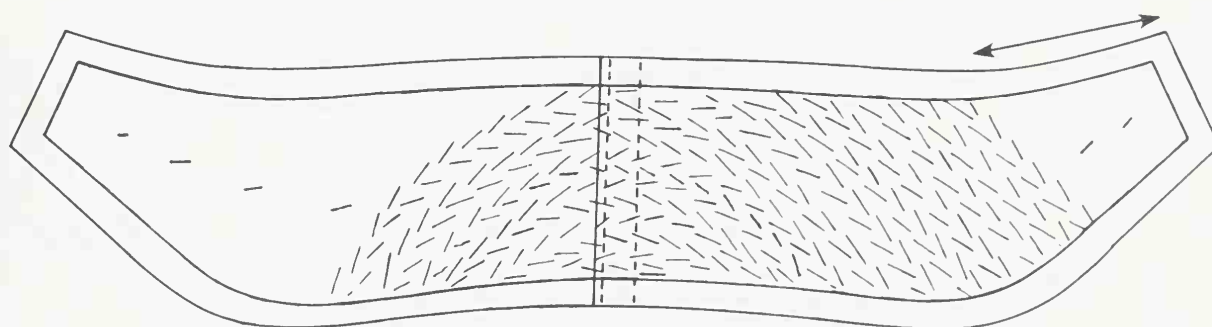

The tips of the collar, about 2" (5 cm) from either end, are pad-stitched while held in a rolled position (as illustrated). This technique ensures that, in the finished jacket, the collar tips will incline downwards towards the shoulder, rather than curling up.

Press the undercollar on the canvas side, on a flat surface.

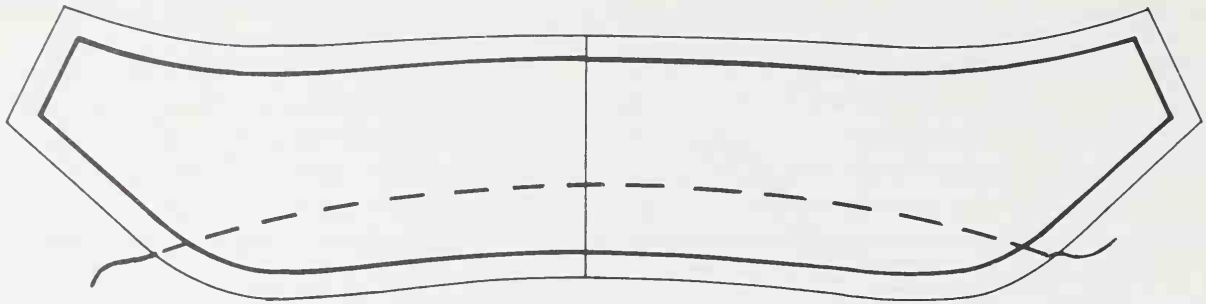

Since both the melton and the canvas are cut on the bias, a certain amount of stretching will occur during the pad-stitching. Our next step, therefore, is to redraw the undercollar stitchline, this time on the right side of the collar.

Sharpen the chalk so that you get a clean, accurate line. Begin at the center back, and draw first one side of the undercollar and then the other. Also mark the undercollar roll line, in chalk, and then in basting thread.

If your measurement of the jacket neck edge showed one side slightly smaller than the other, the adjustment in the collar can be made at this point. Before drawing the smaller of the two sides of the collar, fold back the necessary amount on the paper pattern, at center back. Place the folded edge of the pattern at the center back of the melton undercollar, and trace the outline.

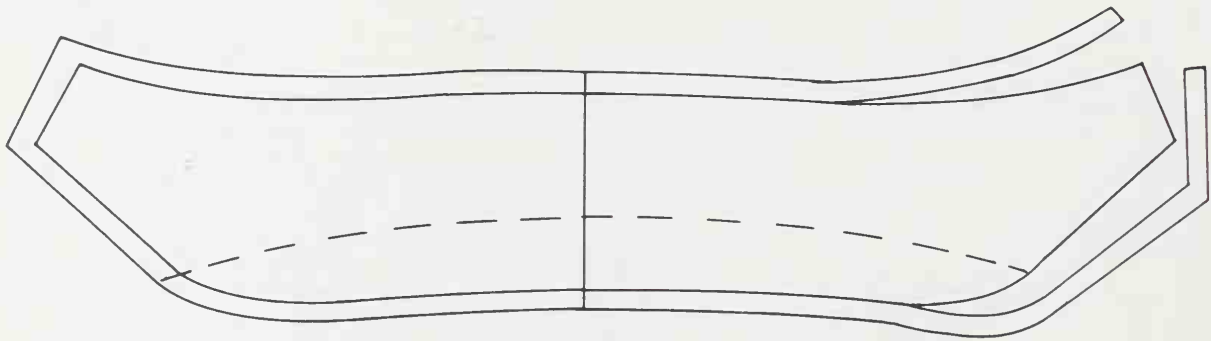

From the melton side, trim away the seam allowance completely—top, bottom, sides.

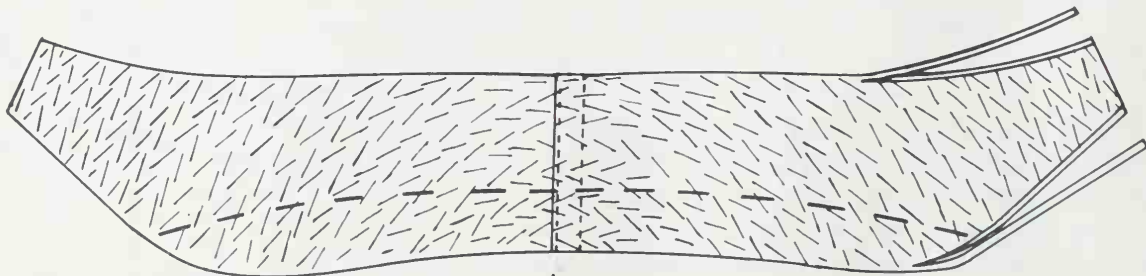

Trim a $\frac{1}{8}$ " (3 mm) margin of canvas from the top and bottom edges of the undercollar. We're doing this to prevent the raw edges of the canvas from peeking through to the outside. There is no need to trim the canvas at the ends of the undercollar, since the topcollar will eventually hide any stray canvas threads in this area.

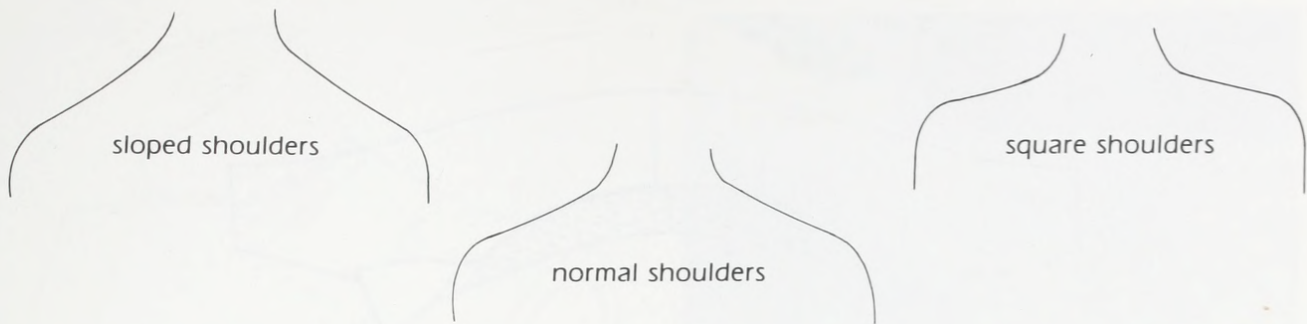

The undercollar is now pressed into shape, taking into consideration the slope of the client's shoulder.

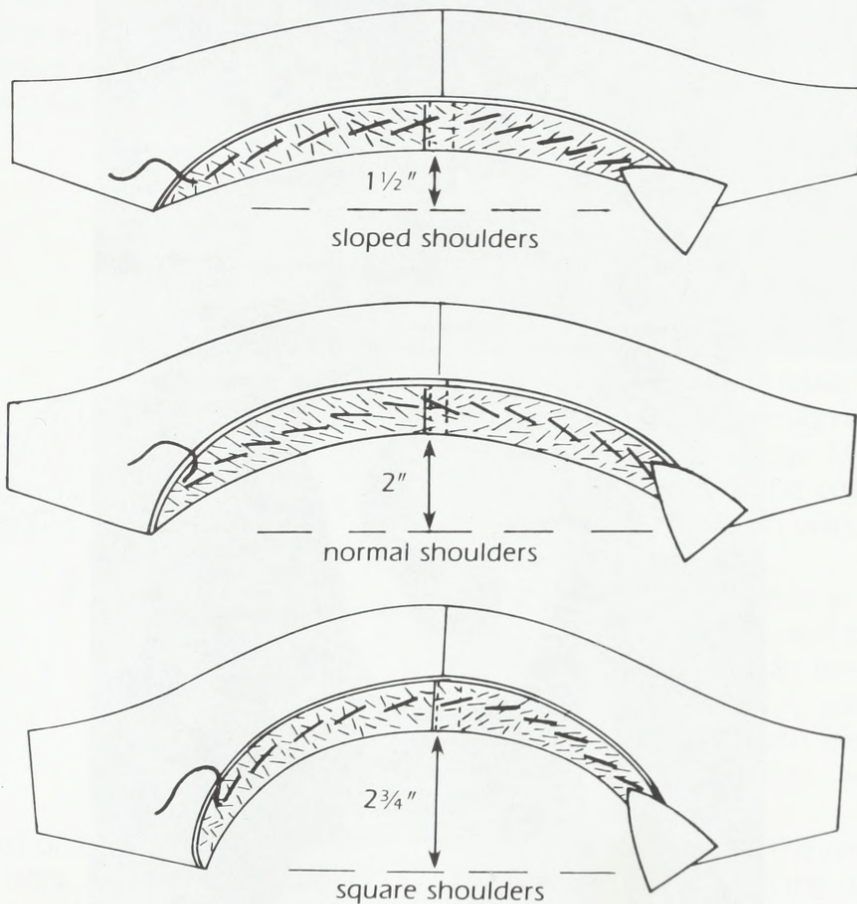

Fold the collar on the roll line and baste it in place.

Using a moderate amount of steam, press the folded edge into an arc, the depth of which depends on your determination of the client's shoulders as *sloped*, *normal*, or *square*. For *sloped shoulders*, the depth of the arc is about 1 1/2" (3.8 cm); for *normal shoulders*, 2" (5 cm), and for *square shoulders*, 2 3/4" (7 cm). This shaping is a fine point in the fit of the collar and

lapel. If, for example, a collar shaped to fit normal shoulders was set on a jacket shaped to fit sloped shoulders, the lapel would not lie flat. It would lift up, away from the jacket. A "sloped collar" placed on a normal neckline would cause the jacket to pull away from the body at the lapel roll line. These are slight inclinations in one direction or another, but they are there, and they make a significant difference in comfort and fit.

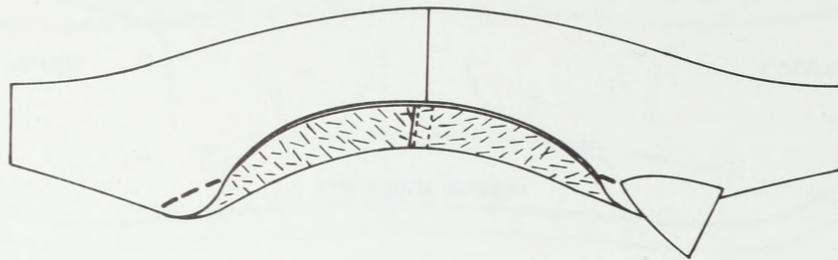

While shaping the undercollar you will have pressed a crease in the roll line. Now, remove the basting which held the neck edge back, and for a few inches at either end of the roll line, press the crease out.

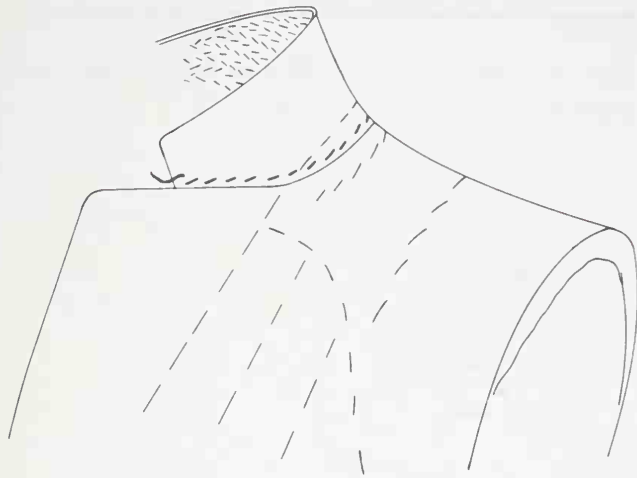

Begin basting the undercollar to the jacket at the center back seam. The raw edge of one side of the undercollar is placed along the chalk guideline which you've drawn at the neckline. The front end of the collar should fall at the collar notch.

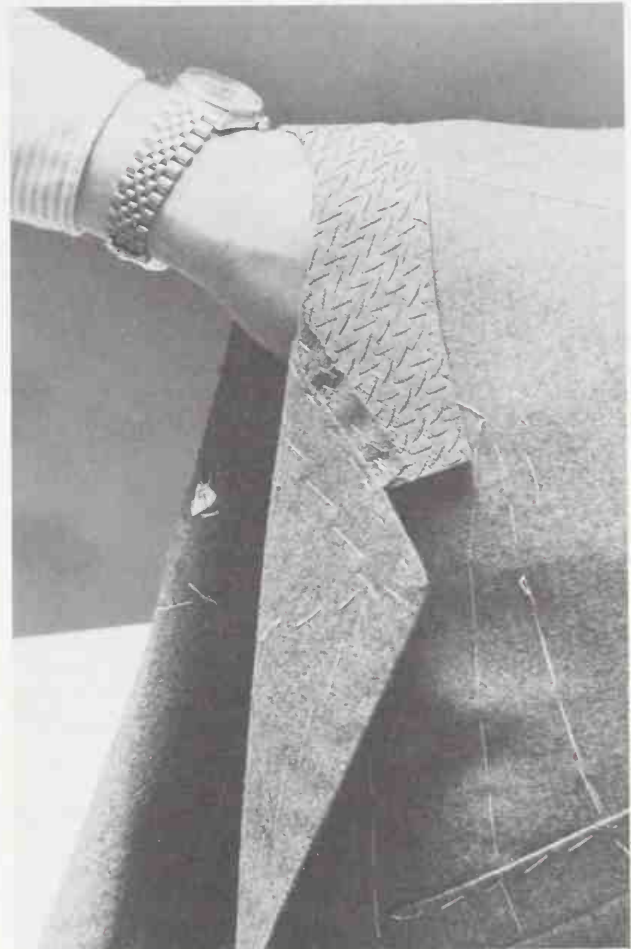

If you have left extra fabric in your undercollar in order to be free to design the collar shape in reference to the lapel (page 144), do that now. Measure both sides of the collar accurately, as any discrepancy in length will be in full view on the front of the jacket.

It is customary to stop at this point in the construction of the collar, and to move ahead to the sleeve. Once a muslin sleeve has been set into the jacket, the client is called in for the *final fitting*. At the fitting, both the collar and the sleeve are checked for fit, and the collar is checked for style.

If you are making the jacket for yourself, and you are pleased with the collar shape, by all means, finish it now. If you are working for someone else, you can reduce the number of fittings by moving ahead to the sleeve at this point.

After the fitting, the collar is finished before the garment fabric sleeve is set.

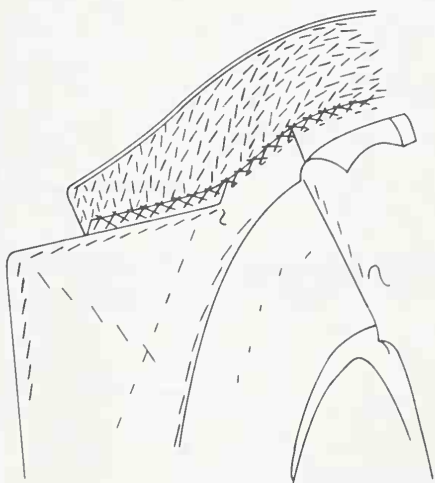

The second half of the undercollar is basted beginning at the front, and working around towards the center back. Before beginning to baste the second half of the undercollar make sure that the distance from the tip of the lapel to the beginning of the collar is identical on each lapel.

Working on the canvas side, cross-stitch the undercollar to the jacket neckline. Use silk finishing thread, and stitch along the gorge line seam allowance, across the top of the facing, and the back neckline. Do not catch the back lining in this stitch.

CONSTRUCTING THE TOPCOLLAR

To create the topcollar, cut a piece of garment fabric on the fold, straight grain, nap up, $1\frac{1}{2}$ " (3.8 cm) longer than the undercollar pat-

tern and about $1\frac{1}{2}$ " (3.8 cm) larger than the pattern, on top and bottom.

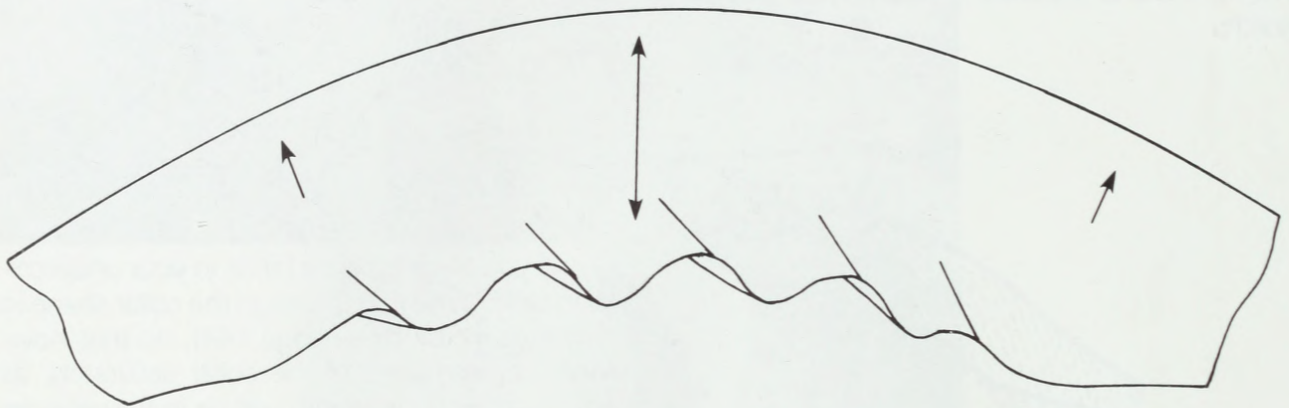
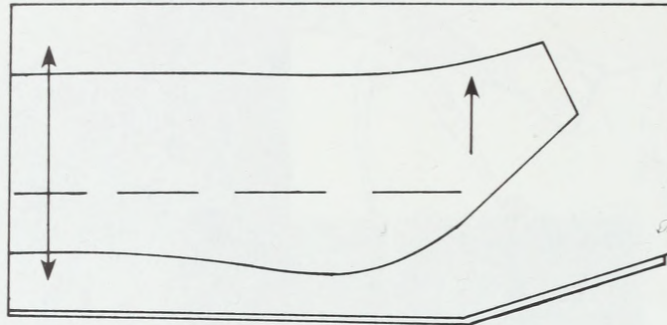

Using a steam iron, stretch the fabric top and bottom.



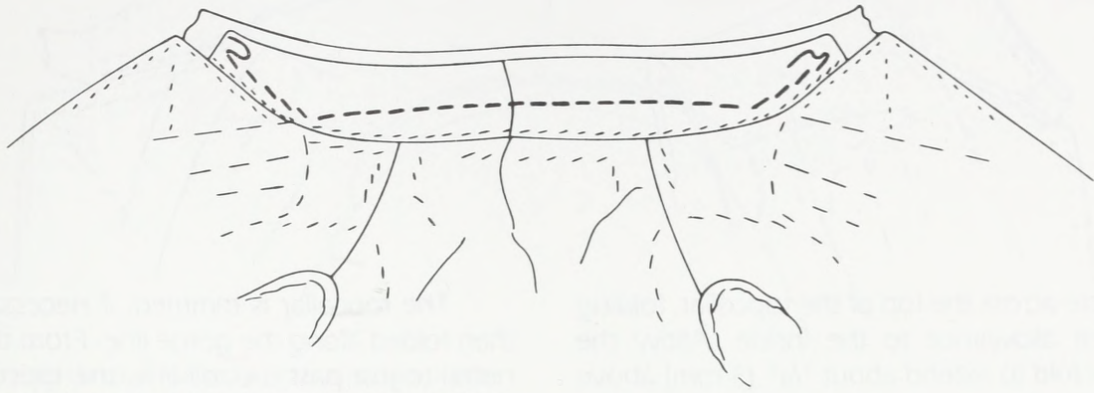

Place the undercollar face down on the wrong side of the topcollar, and baste the two together, from gorge line to gorge line, across the undercollar roll line.

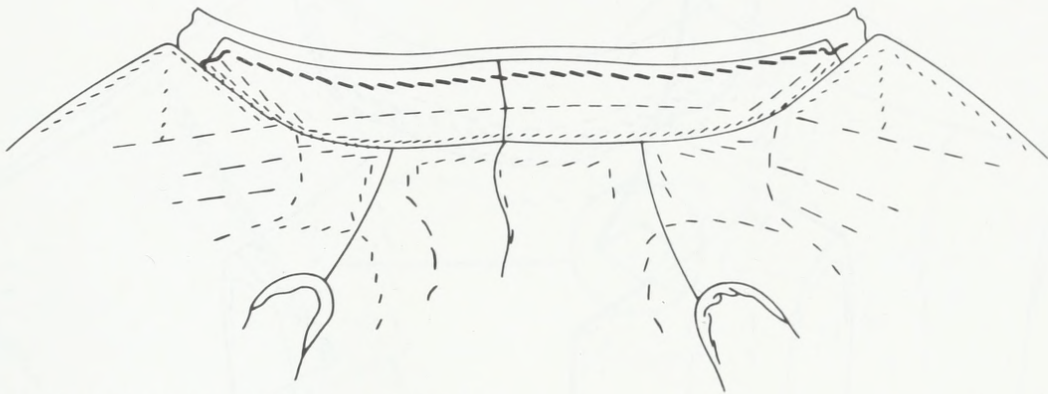

Baste across the top of the undercollar, about 1" (2.5 cm) from the edge.

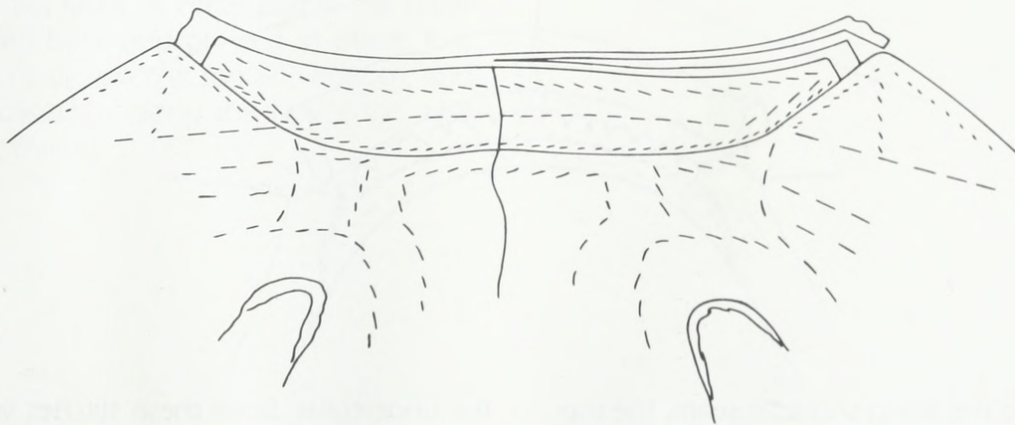

Trim the topcollar, leaving $\frac{3}{8}$ " (1 cm) seam allowance visible above the top of the undercollar, and 1" (2.5 cm) at the sides.

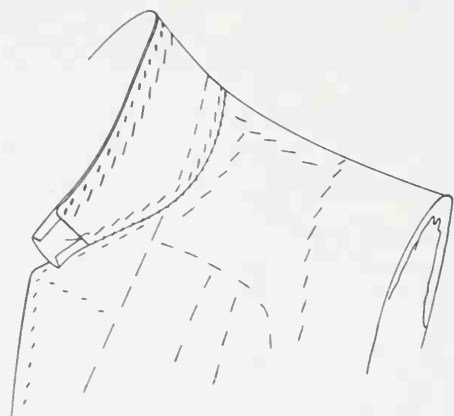

Baste across the top of the topcollar, folding the seam allowance to the inside. Allow the topcollar fold to extend about $\frac{1}{8}$ " (3 mm) above the undercollar, so that the seam will not be visible when the jacket is worn. Both the top edge and the neck edge of the undercollar are finished with a slip-stitch, using silk thread.

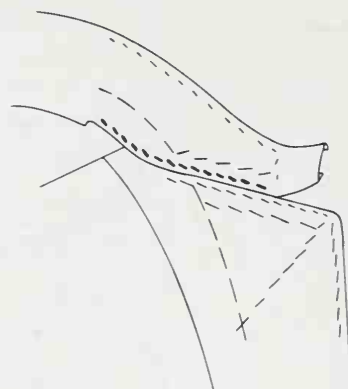

The topcollar is trimmed, if necessary, and then folded along the gorge line. From the collar notch to just past the roll line, the topcollar fold meets flush with the fold of fabric on the facing lapel. Beginning just past the roll line and continuing to just past the lining shoulder seam, the topcollar fold overlaps onto the facing.

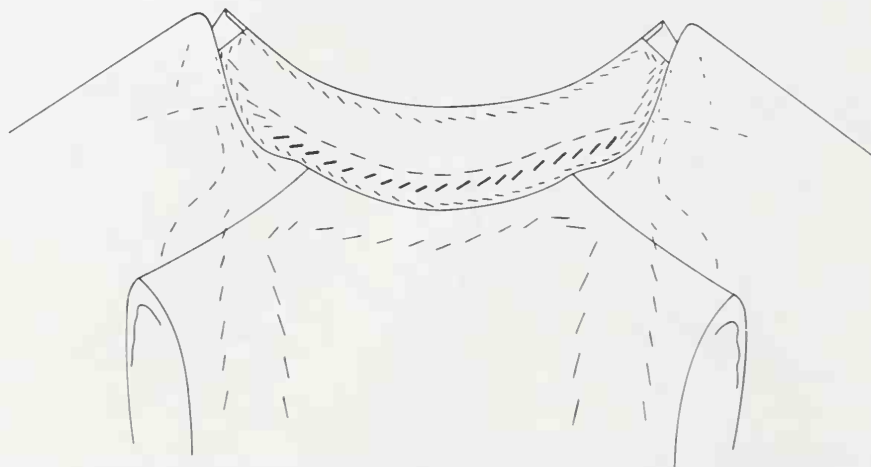

With the topcollar flat on the table, baste across the undercollar just below the roll line, catching the topcollar fabric underneath.

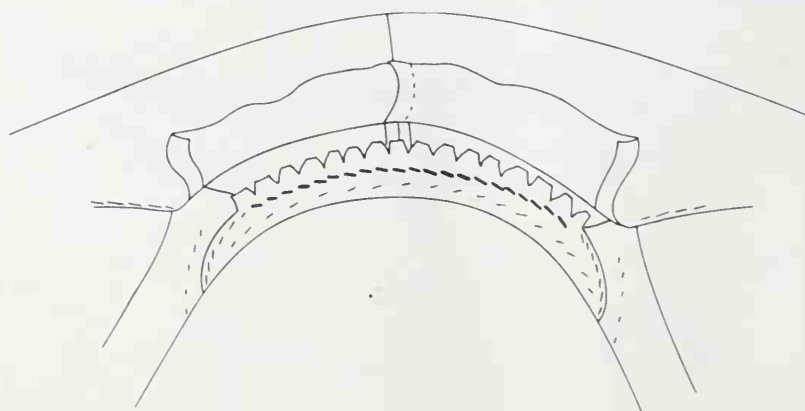

Just past the lining shoulder seam, the topcollar is slashed several times so that it will be able to take the curve of the neckline without pulling. Baste along the back neckline, catching

the undercollar. Since these stitches will remain in the jacket, make sure that they do not show through to the right side.

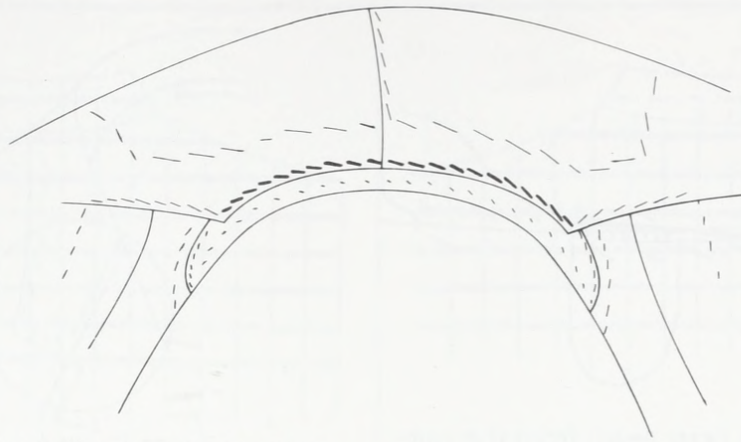

The lining is now folded and basted in place along the neckline. Finish the lining neck edge with a prick-stitch, using silk thread.

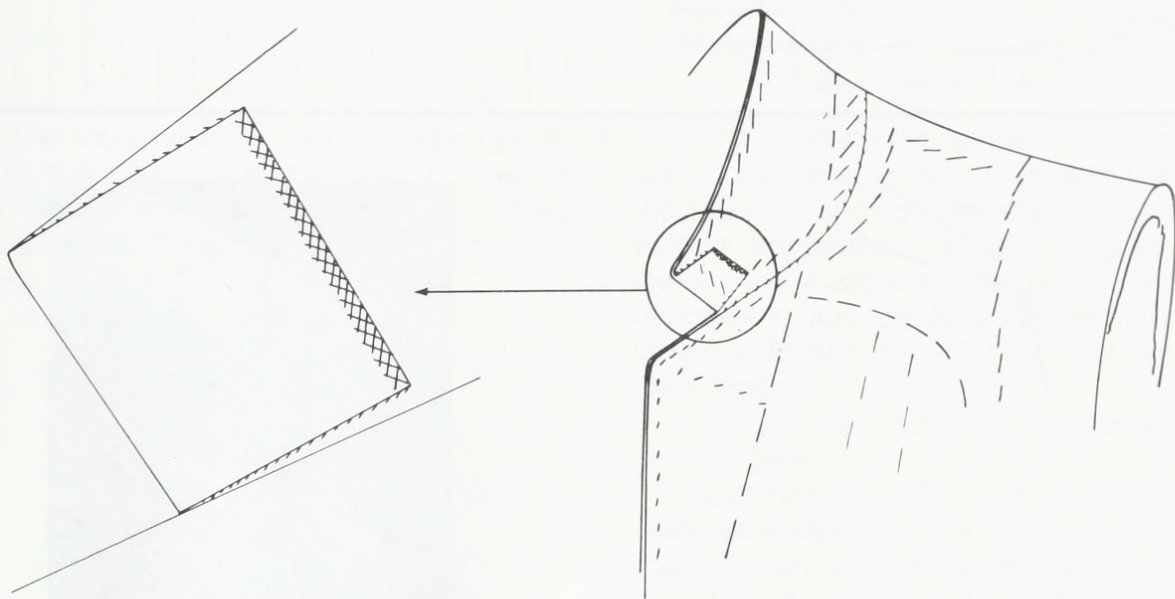

The excess fabric at either end of the collar is now folded back and pressed in place. It is finished with a slip-stitch at top and bottom, and a double-cross-stitch along the raw edge. Use silk finishing thread.

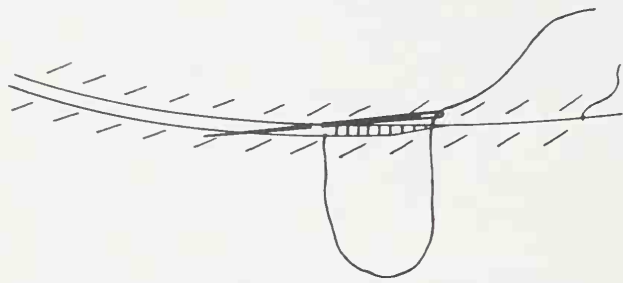

The gorge line is now sewn from the outside using a ladder stitch, to bring the topcollar fold and the facing fold together without visible stitching. The stitch is taken at the side of the fold rather than on top, and runs back and forth from facing to topcollar. After each three or four stitches, one stitch is taken at the center, between the two folds, anchoring the thread into the canvas.

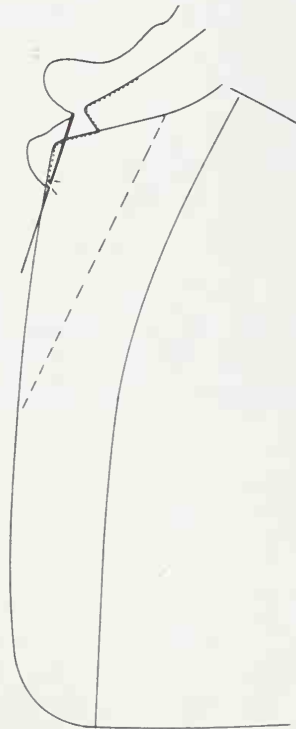
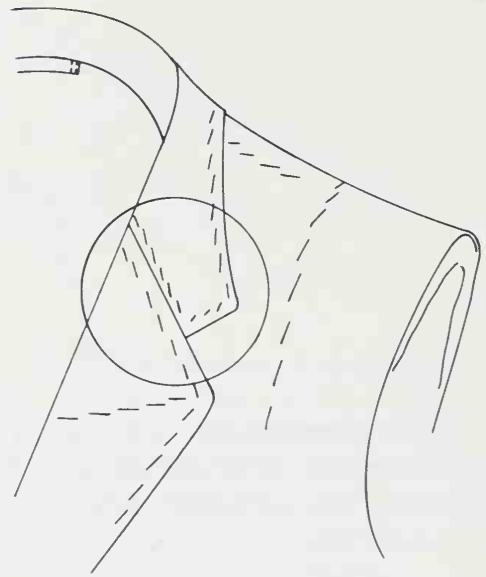

With the collar complete, a final touch is added to the jacket front. Using #A silk thread, prick-stitch along the very edge of the collar, the lapel, and the jacket front, on the topside of the fabric. These stitches should be *tiny* and *unnoticed*. Their purpose is to guarantee a permanently crisp edge.

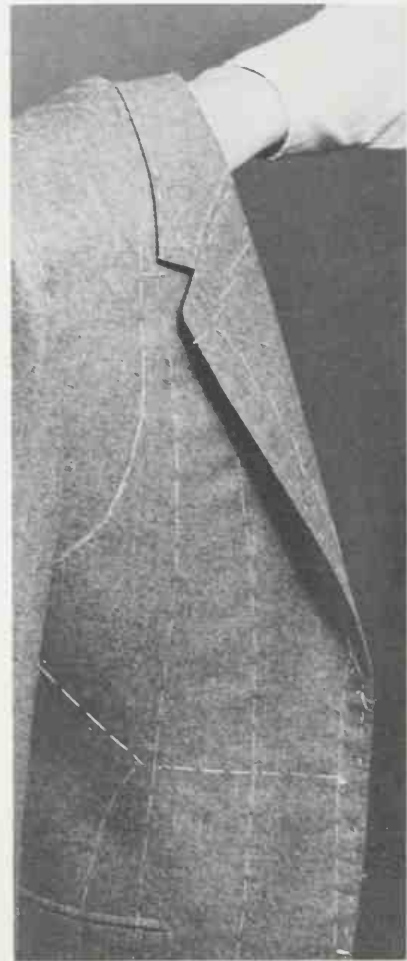

PLAID AND STRIPED COLLARS

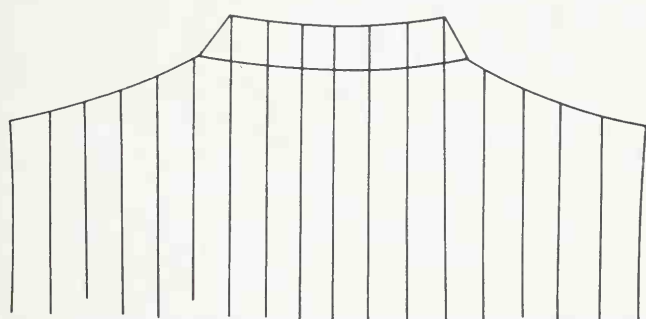
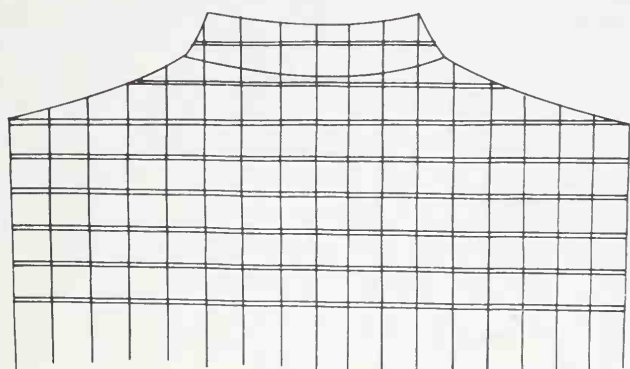

The topcollar on a plaid or striped jacket should match the design at the top of the jacket back. Note that in a plaid fabric this matching should be both horizontal as well as vertical.

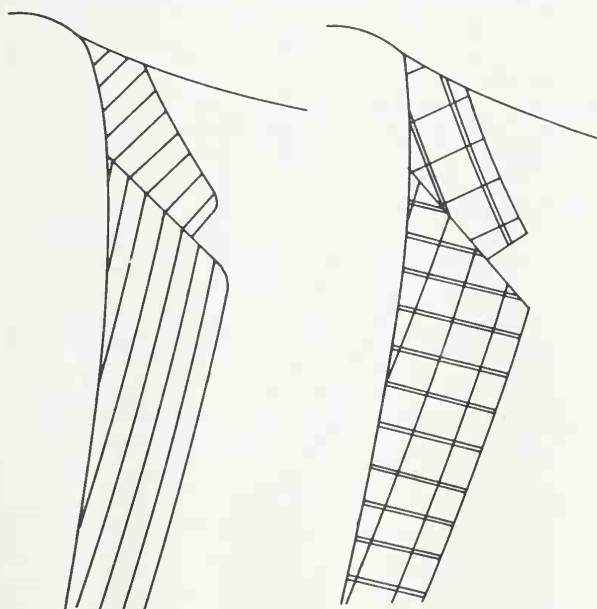

You will be able to match striped fabric at the gorge line if the stripes in the fabric are $\frac{3}{8}$ " (1 cm) or less apart. To match stripes, which are farther apart than $\frac{3}{8}$ " (1 cm) or so, would require excessive shrinking of the top collar at the neck edge.

In a plaid, matching the design at the gorge line is virtually impossible.

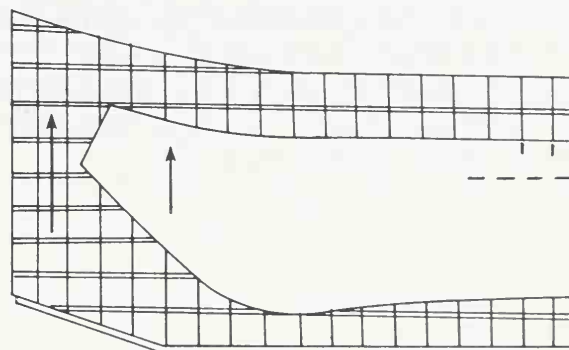
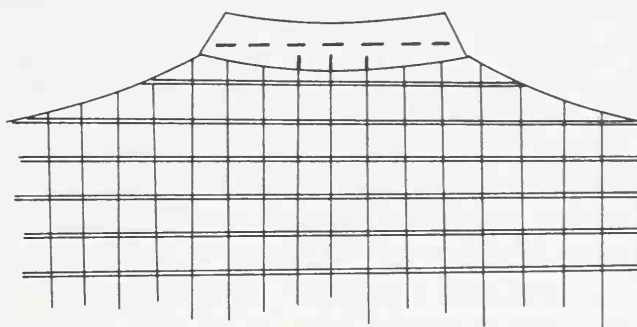

Chalkmark on the canvas of the completed undercollar, short vertical lines which indicate the position of the centermost vertical bars in the plaid or striped fabric design. If a plaid fabric, rather than a stripe is being used, it is also necessary to draw on the undercollar a horizontal line, indicating the next horizontal bar of the plaid design.

Transfer these guidelines to your paper undercollar pattern.

Use the undercollar pattern, from which all seam allowance has been trimmed, to cut the topcollar from garment fabric. With the fold of the fabric at center back, carefully match the design guidelines, which are on the paper pattern, with those on the fabric. Cut the topcollar $1\frac{1}{2}$ " (3.8 cm) larger than the pattern all around.

The attachment of the plaid topcollar continues according to the instructions which begin on page 150. The one point to remember is to match the design guidelines which were drawn on the canvas undercollar, with the topcollar fabric design, before beginning to baste.

The striped topcollar must be pinned in place before being basted, so that the topcollar fabric can be placed to match not only at the center back of the jacket, but also at the gorge line. If the stripes in the pattern are not too far apart, this match of stripes at the gorge line can usually be accomplished by a slight movement of the topcollar fabric downwards.

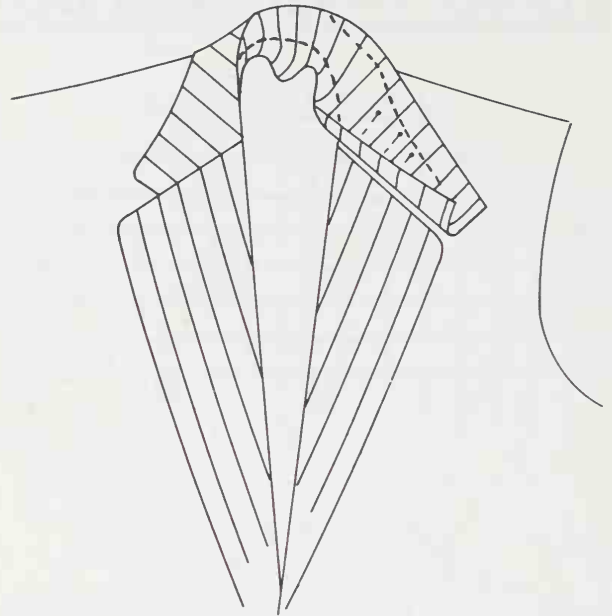

THE COLLAR DRAFT

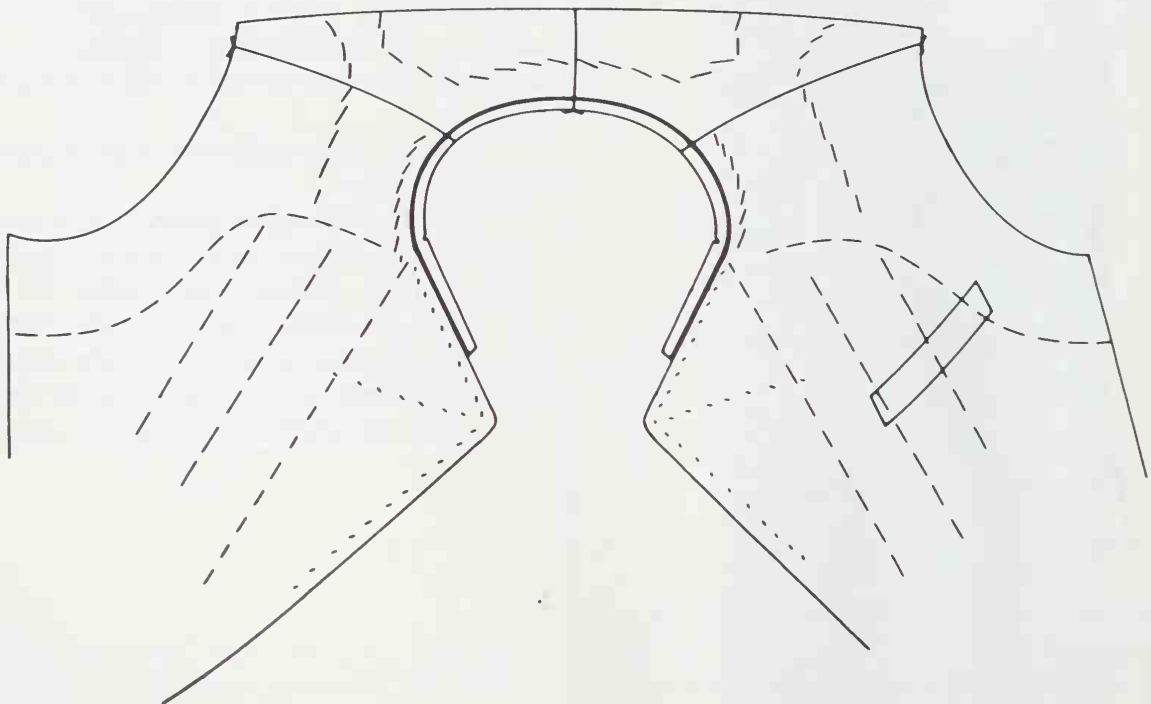

If you have made extensive pattern alterations involving the jacket neckline, it may be necessary to draft a new collar pattern, using the jacket neck edge as guide.

With the jacket folded flat on the table, and the neckline in full view, draw a chalkline indicating the neckline seam allowance, from collar notch to collar notch.

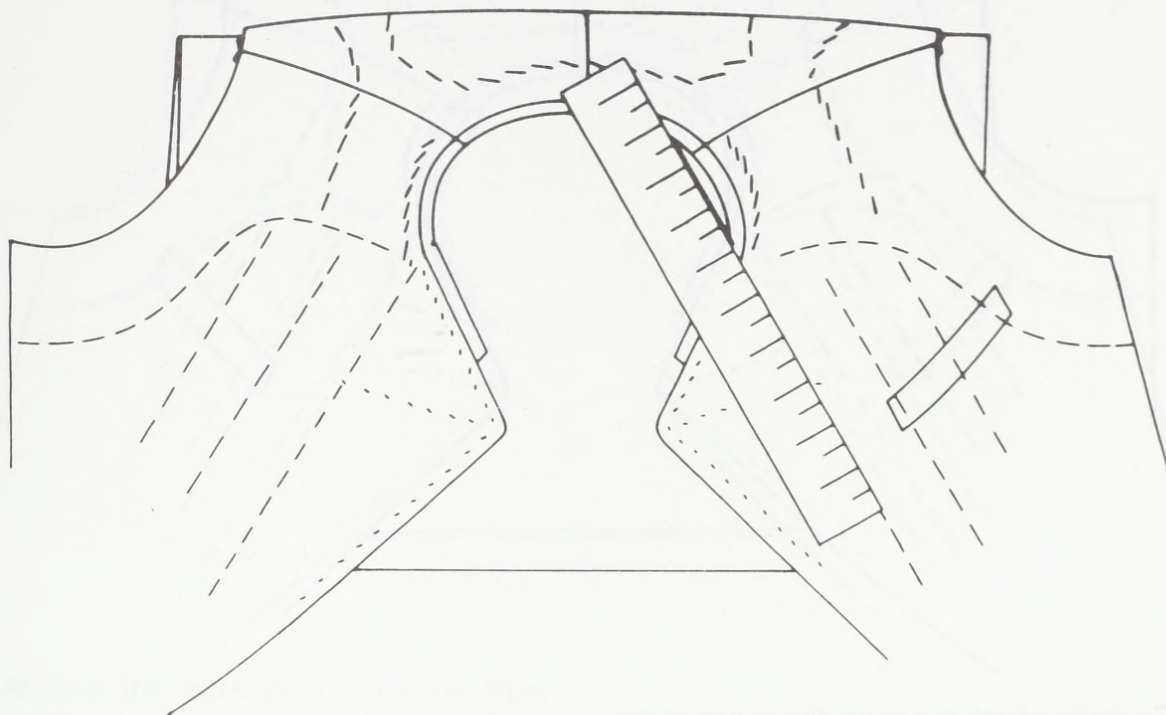

Place a folded piece of paper inside the jacket, large enough to reach just below the lapel.

On one side of the jacket place a ruler along the lapel roll line, and draw on the paper, a short

line indicating the extension of the roll line into the neck area. It is important that the jacket not be shifted at all once this guideline has been noted.

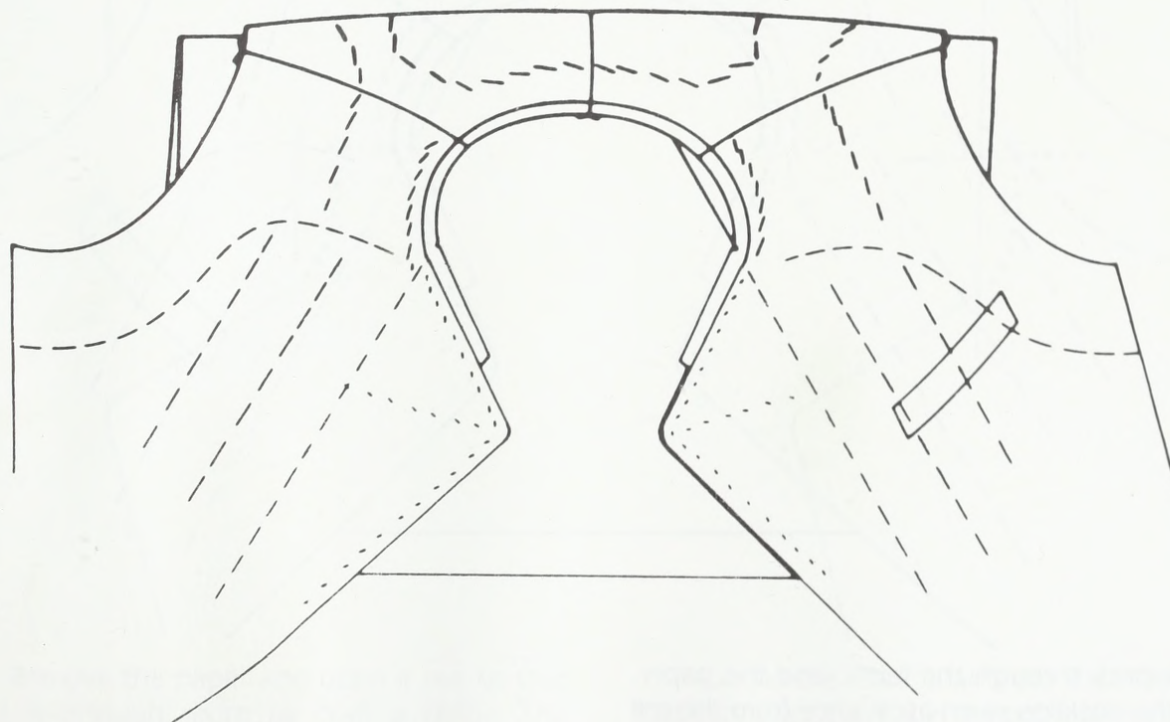

Trace around the lapel as far as the collar notch. Be careful not to mark the fabric.

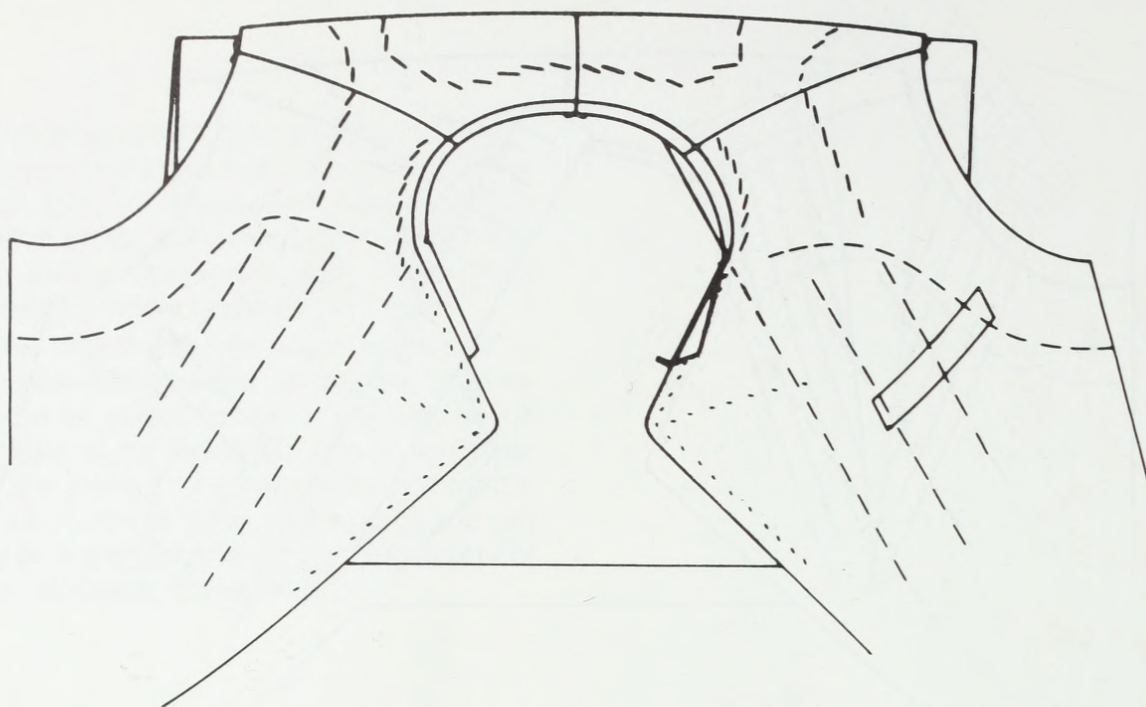

Gently fold back the seam allowance at the gorge line. Mark the collar notch, and the gorge line.

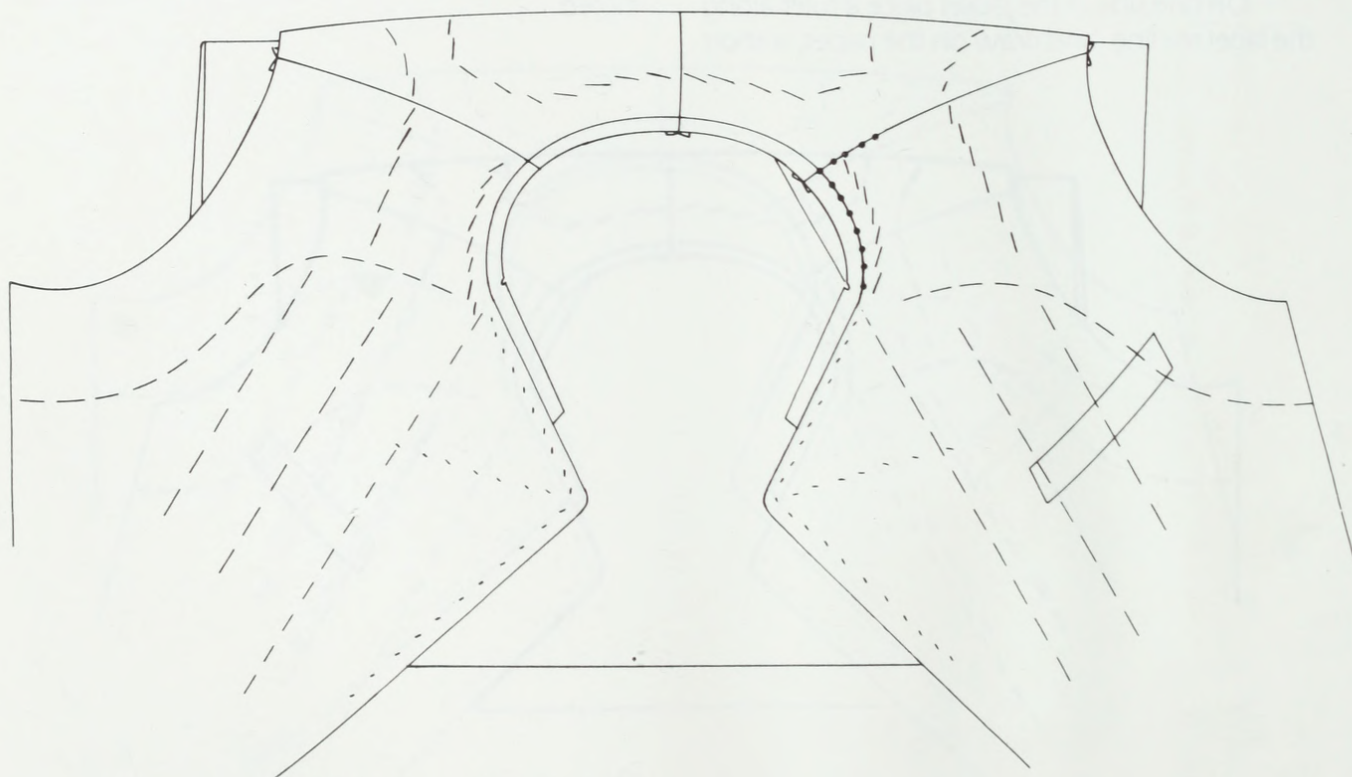

Pinprick through the fabric and the paper, along the neckline seam allowance from the roll line to the shoulder seam. Continue a few inches across the shoulder seam.

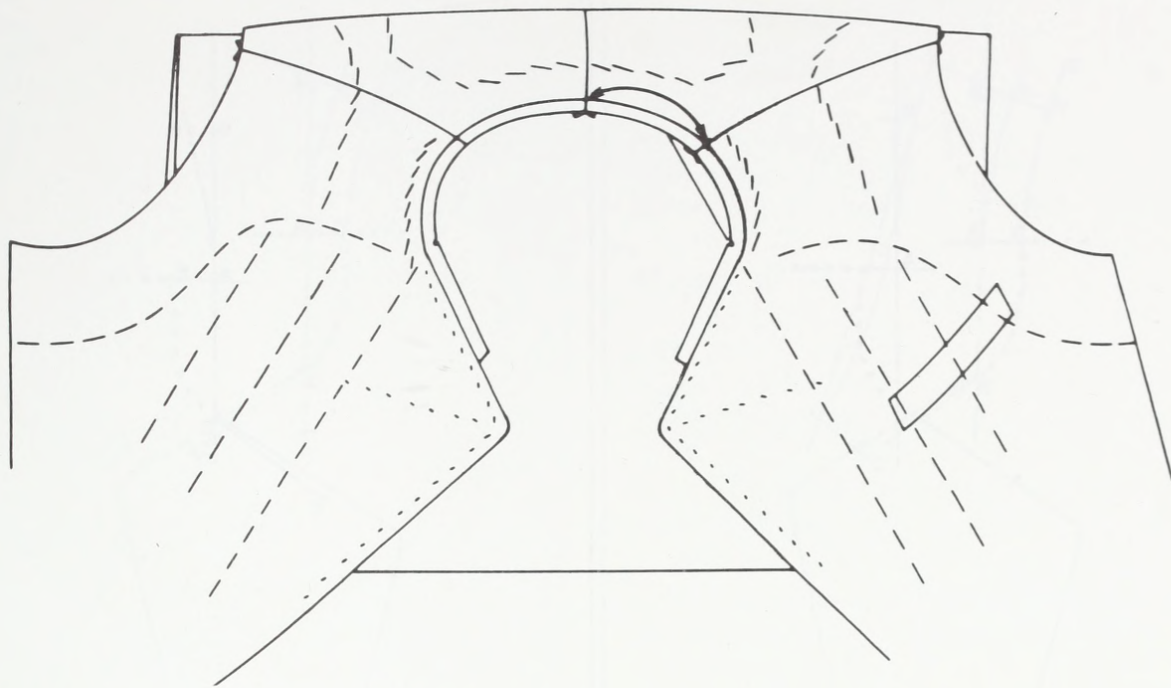

Measure the back neck stitchline from shoulder to center back. Use a ruler which you can curve, or a tapemeasure standing on end, to get an accurate measurement.

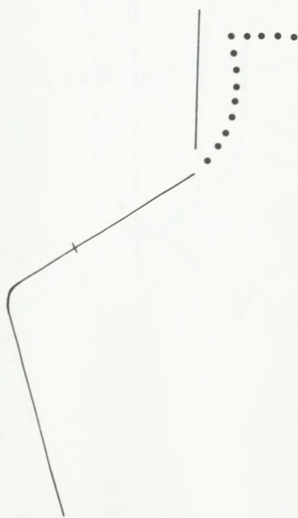

Remove the paper and open it out so that there is enough room to draft a collar. The information on the paper should look something like the markings in the illustration.

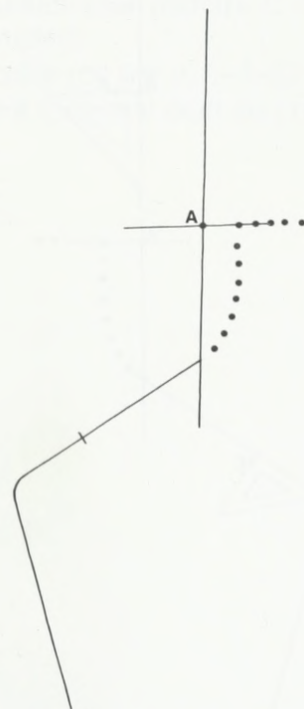

Extend the roll line and the shoulderline so that they intersect. Label the point of intersection A.

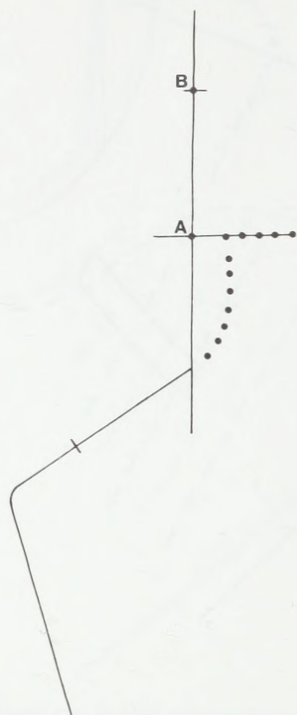

Measure up from A to a distance equal to the back neck measurement. Label B.

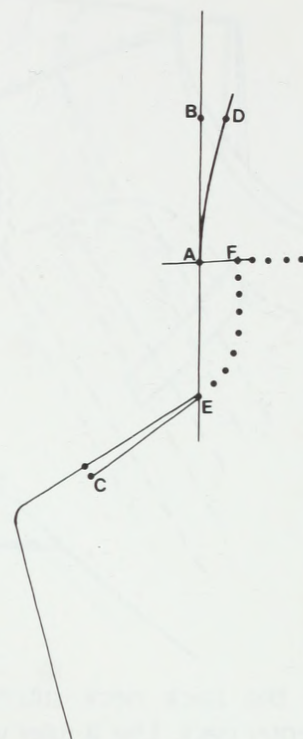

Label E, the point at which the neckline pinpricks meet the lapel. Draw a curved line, E-F, following the pinpricks. Draw a straight line from C to E, and a curved line from A to D.

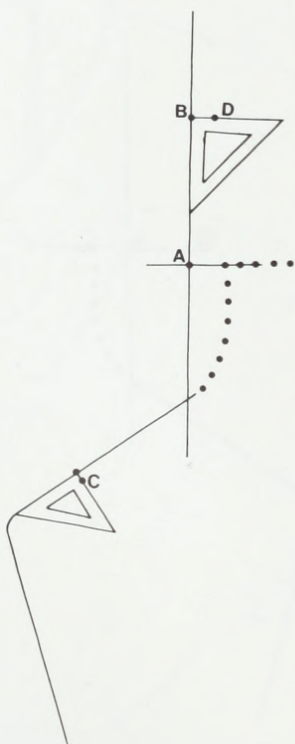

Square out from collar notch, $\frac{1}{4}$ " (6 mm). Label C. Square out from the center back, $\frac{1}{2}$ " (1.3 cm). Label D.

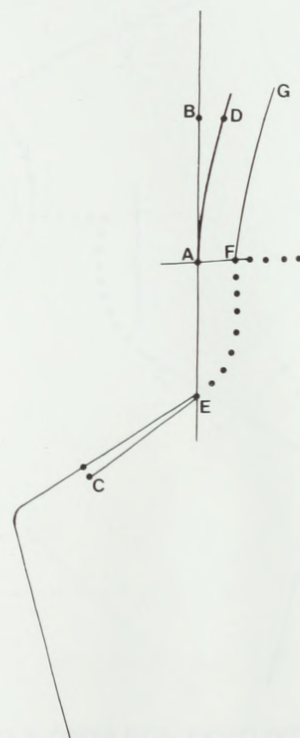

Draw a curved line, F to G, parallel to line A-D.

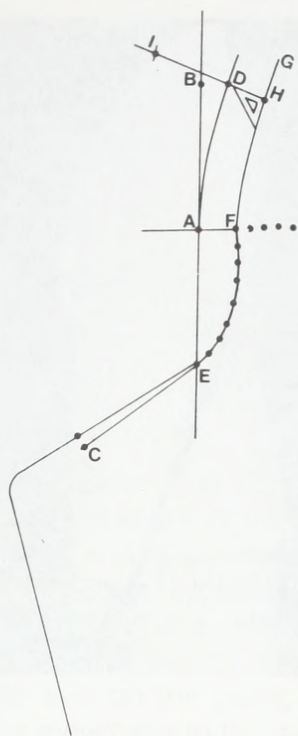

On line F-G find a point (H) from which you can square up through D and beyond. Label a point (I) on the line about 1 1/2" (3.8 cm) above point D. This measurement D-I is the width of the collar at center back above the roll line.

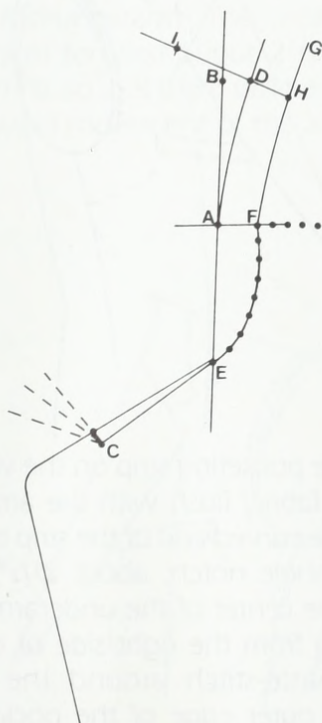

The neck edge of your collar pattern, C-E-F-H, is now complete.

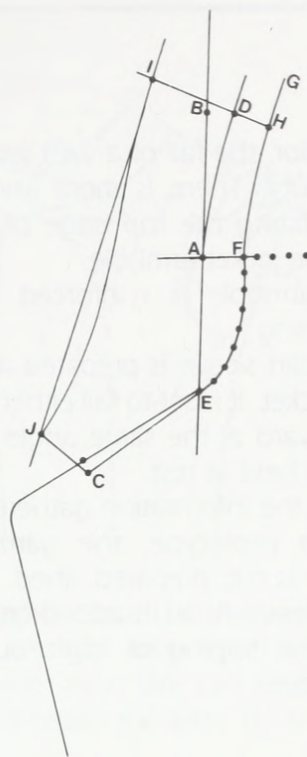

Draw out from point C, a style line for the front of the collar (J).

Draw a straight line from I to J, as a guide for the top of the collar, and then curve the line gracefully at the front.

The undercollar pattern, C-J-I-H-F-E-C, is now complete.

The collar roll line is E-A-D.

Cut out the collar draft and check the fit on the jacket.

THE SLEEVE

For a tailor, the fall of a well-set sleeve is a thing of beauty. There is more involved here than simply fitting the top edge of the sleeve neatly into the jacket armhole.

- The armhole is reinforced to prevent stretching.
- A muslin sleeve is prepared and set into the jacket. It is set to fall either forward or backward at the same angle the client's arm is held at rest.
- Using the information gathered from the muslin prototype, the garment fabric sleeve is cut, prepared, lined, and set.
- The sleeve head is added to produce a graceful draping of fabric out over the shoulder.



REINFORCING THE ARMHOLES

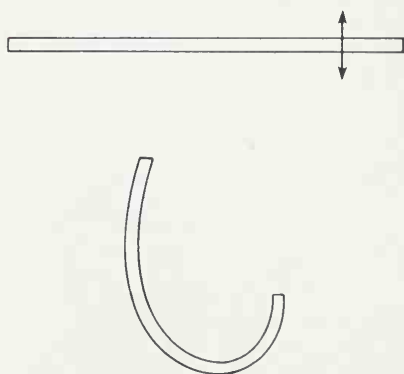

Before the sleeve is set, the armhole must be reinforced with a strip of pocketing to ensure against stretching. Cut a crossgrain strip of pocketing about $\frac{3}{4}$ " (1.9 cm) wide and 20" (50.8 cm) long. Press it into a curve (as illustrated).

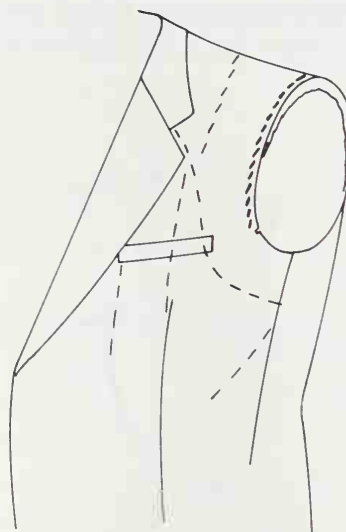

Place the pocketing strip on the wrong side of the jacket fabric, flush with the armhole cutting edge. The curved end of the strip is placed at the front armhole notch, about $2\frac{1}{2}$ " (6.4 cm) forward of the center of the underarm.

Working from the right side of the jacket, diagonally baste-stitch around the armhole, catching the outer edge of the pocketing strip underneath. Catch *only* the garment fabric and the pocketing, *avoiding* the shoulder pad completely.

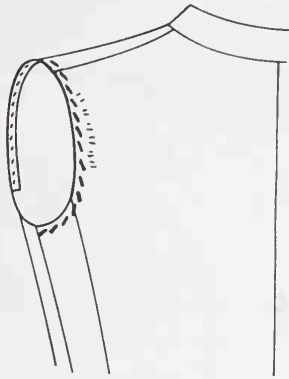

At a point about 1 1/2" (3.8 cm) beyond the shoulder seam, at the back of the jacket, back-stitch on the tape and then begin basting tiny ripples of ease into the jacket fabric. This process continues to about 1 1/2" (3.8 cm) above the side panel seam, so that the rippled area is at shoulder-blade level on the jacket, and affords added ease for movement in this area.

The total amount of ease should not be more than 3/8" (1 cm). On gabardines, or other tightly woven fabrics, the ease amount should be closer to 1/4" (6 mm). The ease is basted into the pocketing strip and tacked, top and bottom, so that it will stay where you have placed it.

Continue basting the pocketing strip down to about mid-underarm. The area from about mid-underarm forward about 2 1/2" (6.4 cm) is not reinforced, so that there will be no restriction of the forward movement of the arm.

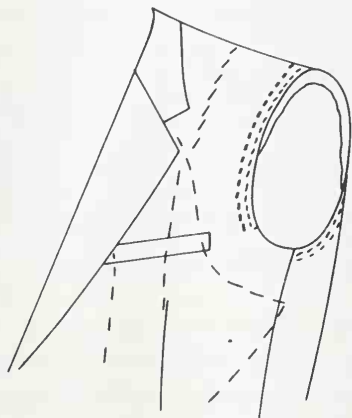

Baste around the armhole from the outside of the jacket a second time, this time catching the inner edge of the pocketing.

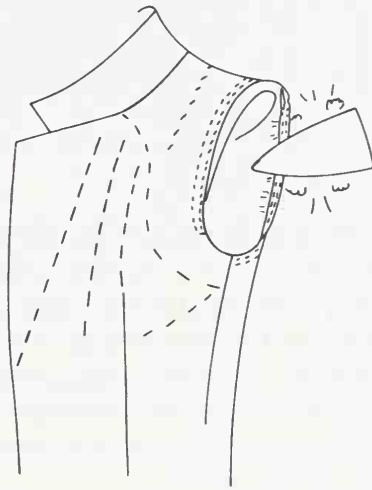

The ripples placed at the back of the armhole have brought extra ease beyond, to the shoulder-blade area. We can eliminate the ripples and still retain the ease by steam pressing carefully.

Steam press the rippled area, on the wrong side of the fabric, on a flat surface. Be careful to allow the iron to extend in from the armhole edge no more than about 1 1/2" (3.8 cm) or so. A moderate amount of steam, applied flat and on top of the ripples, should shrink them away.

If you were to press further in on the fabric, while still on a flat surface, you would shrink away the ease which the ripples represent, and render the entire process useless.

Keep the iron out and at the edge of the armhole for now.

If you have trouble getting the ripples to disappear, you have probably placed too much ease in the area, and are dealing with a tightly woven fabric. If necessary, remove the pocketing strip and adjust the amount of ease. Do take care of the problem before continuing. Once the sleeve is sewn in, the ripples will be a permanent distraction.

THE MUSLIN SLEEVE

You'll notice we haven't cut the sleeve yet. We haven't even cut a muslin sleeve. We've been waiting until the shoulder pads are placed in the jacket, and the armholes are reinforced, in order to get an accurate measurement of the jacket armholes. Once we have this measurement, we can cut a muslin sleeve with the right amount of ease all around.

On the right side of the jacket, measure around the armhole cutting edge. It is somewhat difficult to measure a curved area, therefore, do it carefully, and double check your measurement.

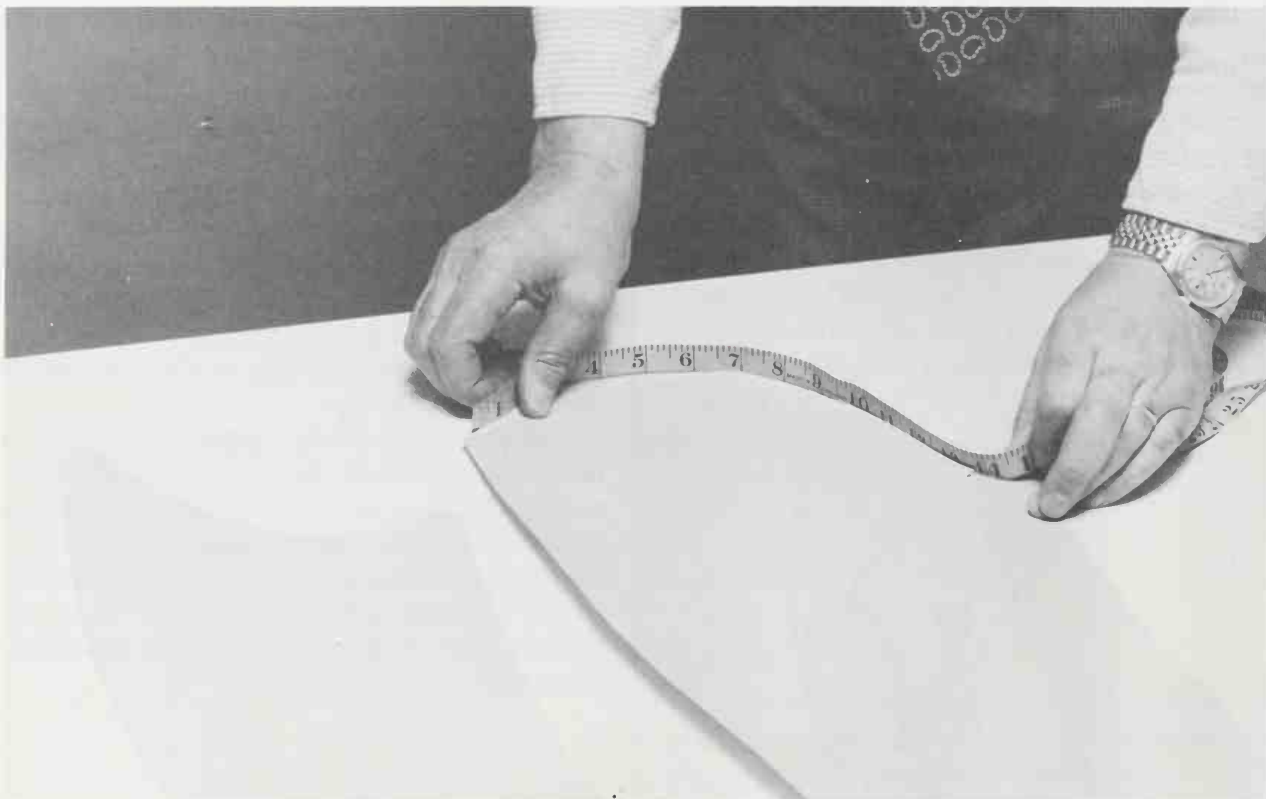
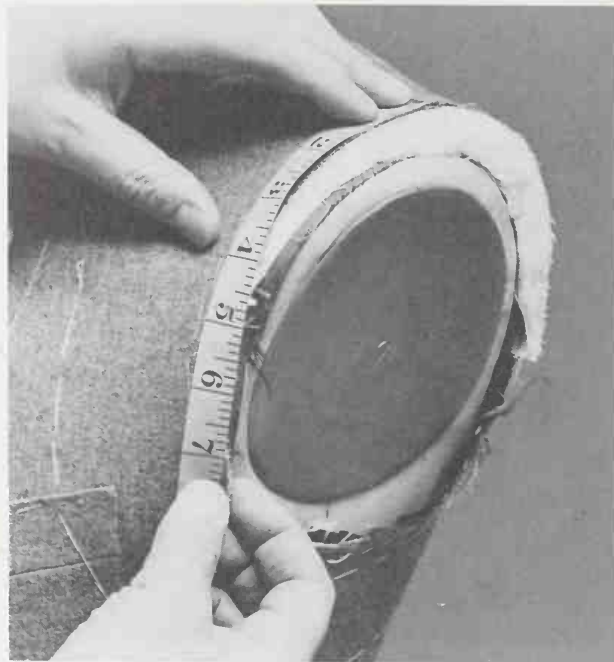

Compare this measurement with that of the cutting edge around the top of your sleeve pattern. Measure both the undersleeve and the topsleeve, being careful not to include your side seam allowances in this measurement.

The cutting edge around the top of the sleeve pattern should measure 2" (5 cm) to 2¹/₄"

(5.7 cm) larger than the cutting edge around the jacket armhole. (For gabardines and other tightly woven fabrics, the measurement should not be more than 2" (5 cm).) This amount of ease is necessary to allow the sleeve to fall gracefully from the shoulder.

If the top edge of your sleeve pattern is not at least 2" (5 cm) larger than your armhole measurement, adjust the sleeve pattern by adding to or subtracting from the top edge of the topsleeve, tapering to nothing at the side seam allowances. The undersleeve is not adjusted. The maximum adjustment possible at the top of the topsleeve, before distorting the cap shape, is $\frac{3}{8}$ " (1 cm).



If further adjustment of the sleeve cap is necessary, it must now also involve the width of both the topsleeve and undersleeve in order to maintain the overall balance. Again, an adjustment of $\frac{3}{8}$ " (1 cm) is the maximum suggested.

Adjust the pattern according to the illustrations, using a hip curve to taper your new lines gracefully.

If this adjustment should still prove insufficient, the answer is an entirely new sleeve pattern, one size larger or smaller.

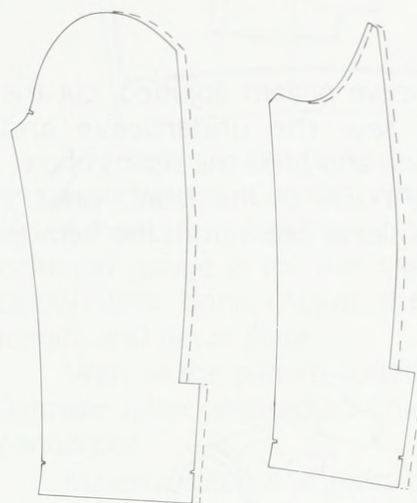

Check the sleeve length, measuring down the center of the topsleeve, from stitchline to hem fold. Using the sleeve measurement taken on page 16 as a guide, lengthen or shorten the sleeve by cutting the sleeve pattern at approximately elbow level. Separate or overlap the topsleeve pattern to achieve the correct length; and then blend the sides of the pattern using a hip curve. The undersleeve pattern is adjusted by the same amount as the topsleeve.

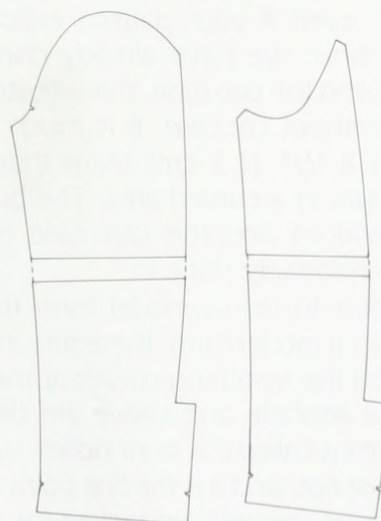



With the sleeve pattern adjusted, cut the muslin sleeve, sew the undersleeve and topsleeve together, and press the seams open.

On the right side of the fabric, press a crease in the topsleeve seam from the hem to about elbow level.

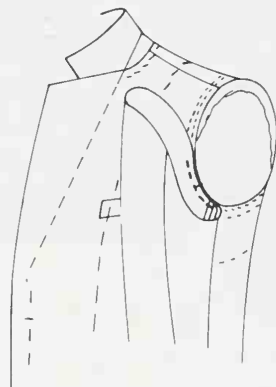

Use a $\frac{1}{2}$ " (1.3 cm) seam allowance to set the sleeve, even if your pattern indicates $\frac{5}{8}$ " (1.6 mm). Since we have already checked the armhole fit and the cap ease, this adjustment can be made without concern. It is much easier to work with a $\frac{1}{2}$ " (1.3 cm) seam than with a larger amount in a curved area. The bulk in the seam is reduced and the cap ease has more room to comfortably settle in.

It is best to use a model form to set the sleeve. With a model form, the entire armhole is in view, and the matching curves at the bottom front of the armhole and sleeve are clearly visible. This area is called the *front notch*, whether it is notched or not, and it is the first point at which the sleeve and armhole are tacked for a fitting.

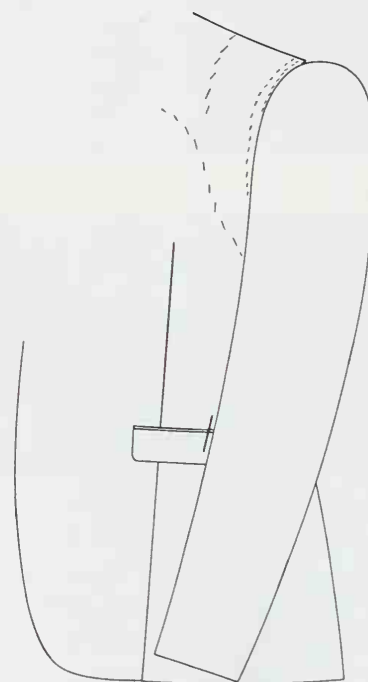
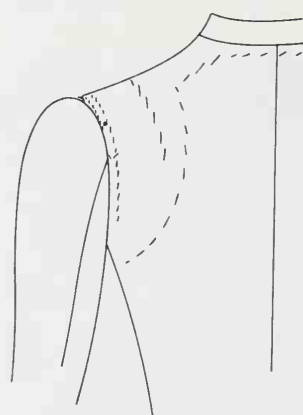

The point at which the back seam in the sleeve falls on the armholes, is called the *back notch*. In order to determine this point, hold the sleeve at the top, and allow it to fall forward until the hem touches the chalk guideline on the pocket. This chalkmark indicates how far forward your arm falls when held naturally. The sleeve must hang in that same position to be without creases when it is worn. Tack the back notch into the armhole at the point which allows the sleeve to fall forward to the chalk guideline.

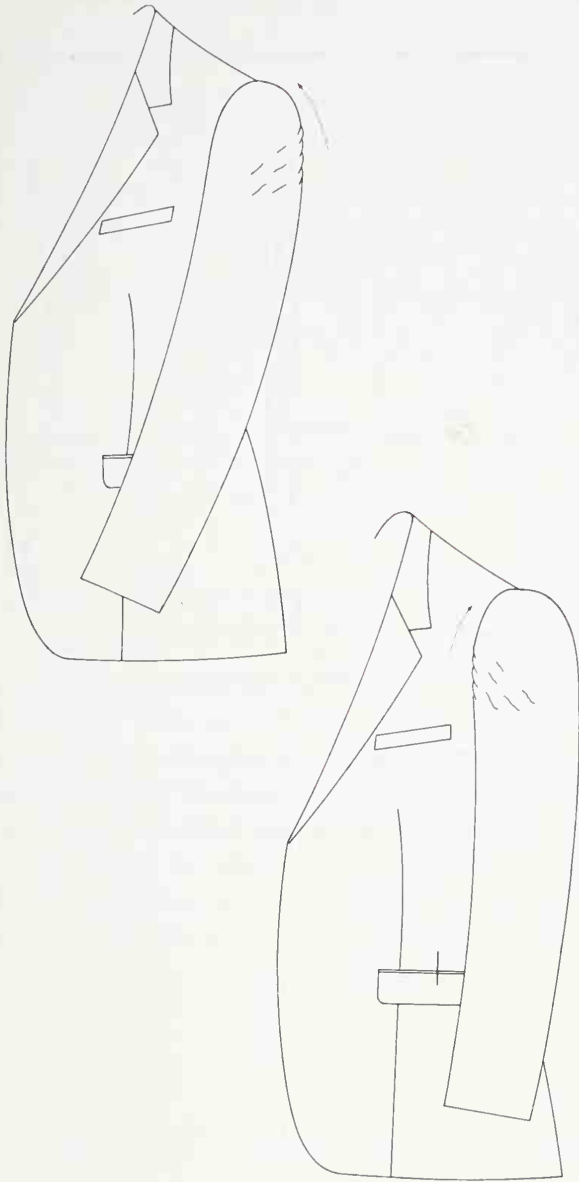

With the front and back notches tentatively tacked, baste around the armhole, distributing the 2"–2¼" (5–5.7 cm) ease around the entire reinforced area of the armhole. Only the 2½" (6.4 cm) area from center underarm forward is without ease in the sleeve. There may be some puckering at the cap of the muslin sleeve. However, if you have measured your armhole correctly, these puckers will be easy to control in the garment fabric.

Check the sleeve side view. If there are diagonal creases from the front or back of the sleeve pointing upwards, the sleeve should be set so that it falls a bit more forward or back, until the creases disappear. When the sleeve falls comfortably without these creases, chalkmark the front and back notches on the jacket, and the front notch on the sleeve. These notches should also be transferred to your pattern. (For plaid sleeves see page 177.)

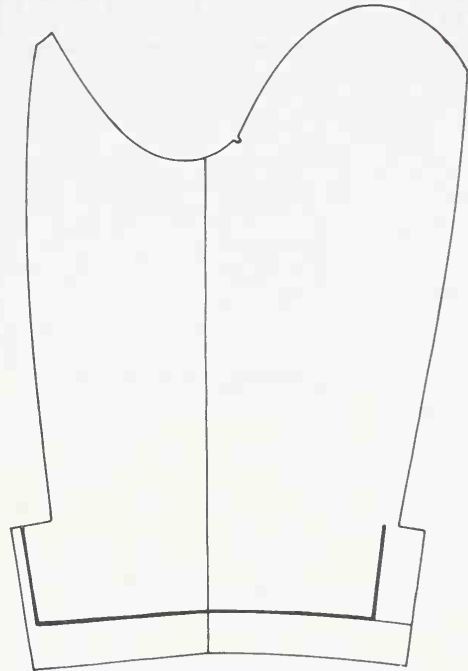

The sleeve length is to some degree a matter of preference. Comfort when wearing the jacket should be your main criterion. The most common gauge is for the sleeve to end just below wrist bone. Adjust the muslin sleeve length, and pin in place.

With all the pattern corrections made, the garment fabric sleeve can finally be cut with confidence.

Machine-stitch and press open the underseam. On the right side of the fabric, chalkmark the hem and vent foldlines. The foldline on the topvent is a continuation of the sleeve seamline. On the undervent, the foldline is ¾" (1 cm) from the edge.

THE SLEEVE VENTS

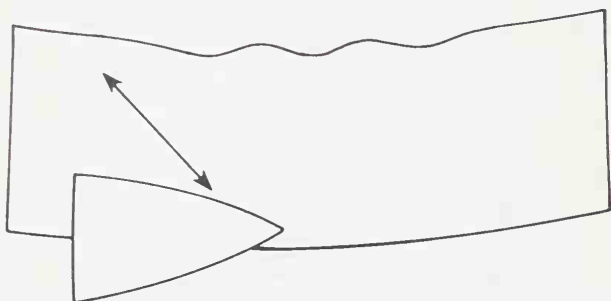

Cut a bias piece of pocketing to be used as reinforcement, 5" (12.7 cm) wide and long enough to extend from vent edge to vent edge at the bottom of the sleeve. Stream press the pocketing into a slight curve so that it will lie comfortably at the bottom of the sleeve, on the wrong side of the garment fabric.

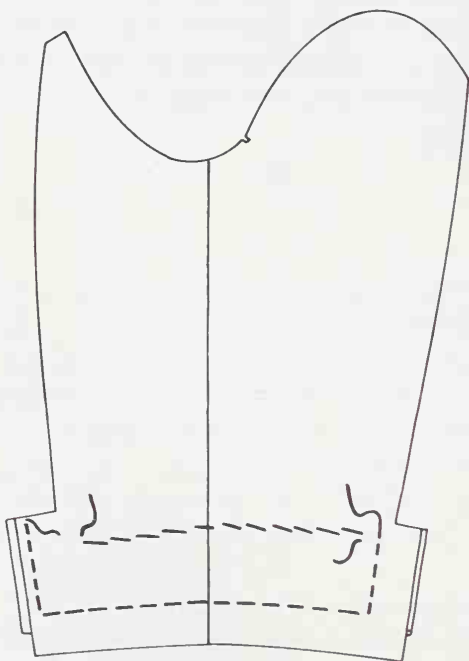

Baste along the chalklines at the bottom of the sleeve, catching the pocketing reinforcement, and diagonally baste-stitch across the top of the reinforcement.

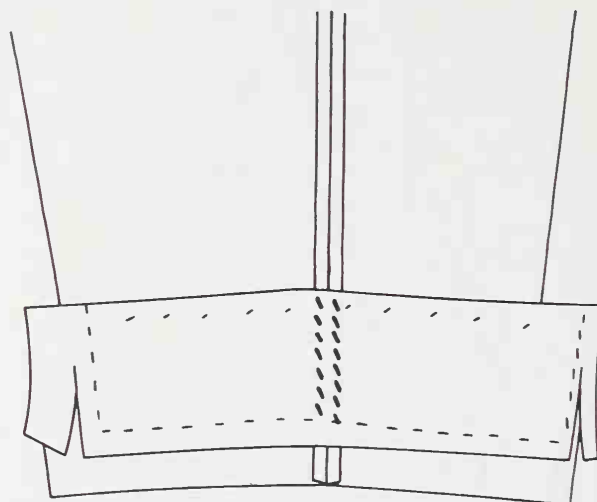

Trim the sides of the pocketing very close to the basting on the undersleeve vent, and about 1/2" (1.3 cm) from the basting on the topvent. Diagonal-stitch the reinforcement into the sleeve seam allowance, above the hem.

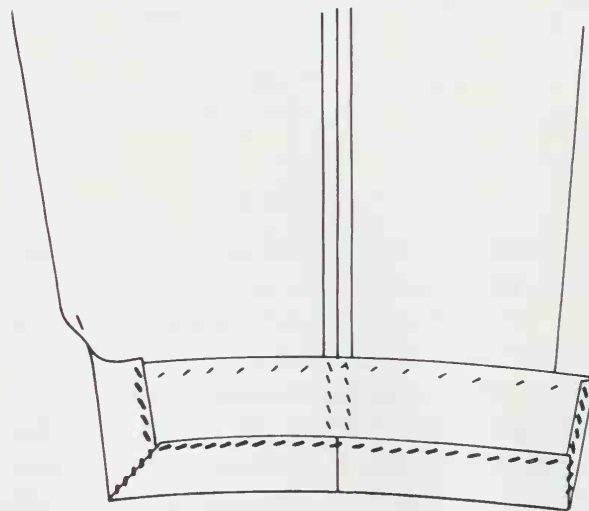

Fold and press, first the vents, and then the hem, using the basting lines as guides. Fold the bottom of the topvent into a miter, and press well. Unless the fabric is extremely bulky, we suggest that you do not trim the excess fabric in the corner. The fold will give a certain amount of appropriate body to the topvent. It will also afford you the option of lengthening the sleeve, should this be desirable sometime in the future.

Diagonal-stitch the vents and hem into the pocketing, using silk finishing thread, and slip-stitch the sides.

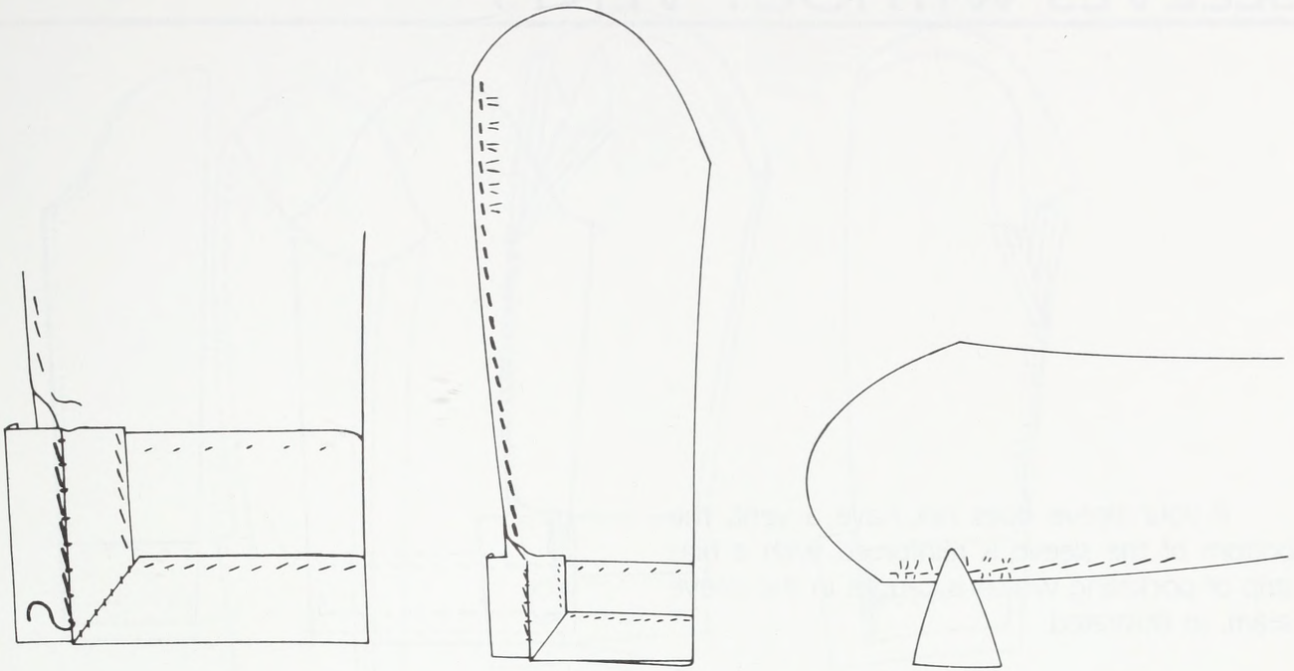

With the topvent about $1/16''$ (1.5 mm) longer than the undervent, baste first the vent, and then the sleeve seam closed. The topsleeve seam should be about $3/8''$ (1 cm) longer than the undersleeve. (For gabardine, or other tightly woven fabrics, $1/4''$ (6 mm) is better.) Place this

ease in the top third of the topsleeve seam, and steam press the puckers out, before machine-stitching the seam. Press on a flat surface, making sure that the iron extends onto the fabric no more than about $1\ 1/2''$ (3.8 cm).

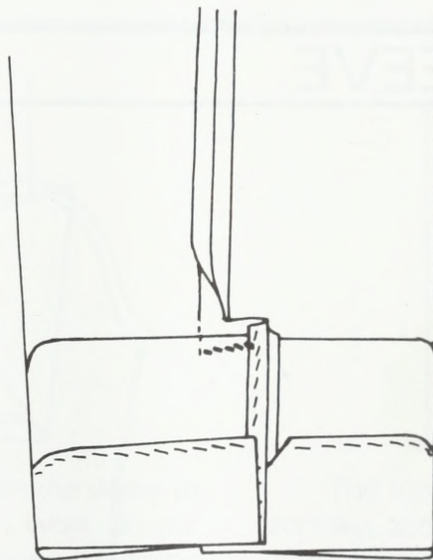

Machine-stitch the topseam to $1/4''$ (6 mm) below the top of the vent, and press the seam open. Fold and press the seam allowance on a diagonal just above the top of the vent, instead of clipping the seam allowance here and weakening the area.

Back-stitch the tops of the vent together using silk finishing thread. The sleeve is now ready to be lined.

SLEEVES WITHOUT VENTS

If your sleeve does not have a vent, the bottom of the sleeve is reinforced with a bias strip of pocketing which is caught in the sleeve seam, as illustrated.

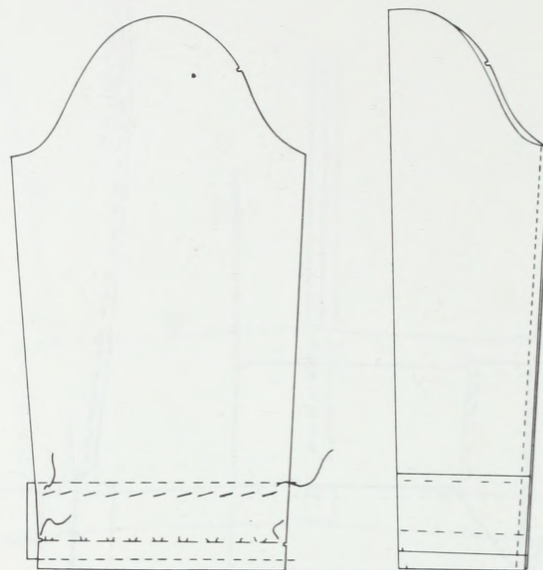

LINING THE SLEEVE

The sleeve lining is cut using the sleeve pattern. Trace around the sleeve pattern, cutting the lining larger than the sleeve by the amounts indicated. Note that the vent on the topsleeve is eliminated.

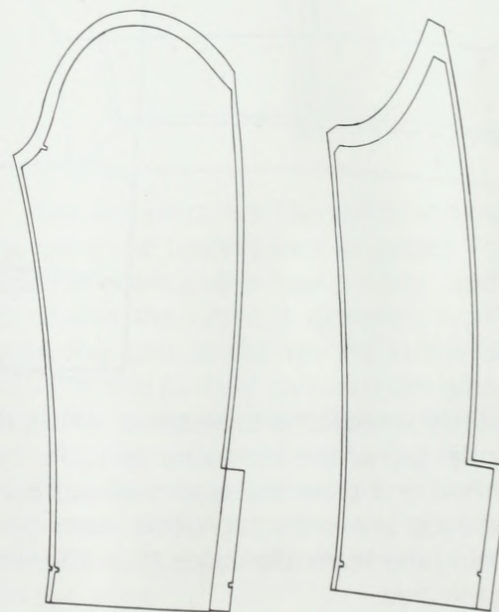

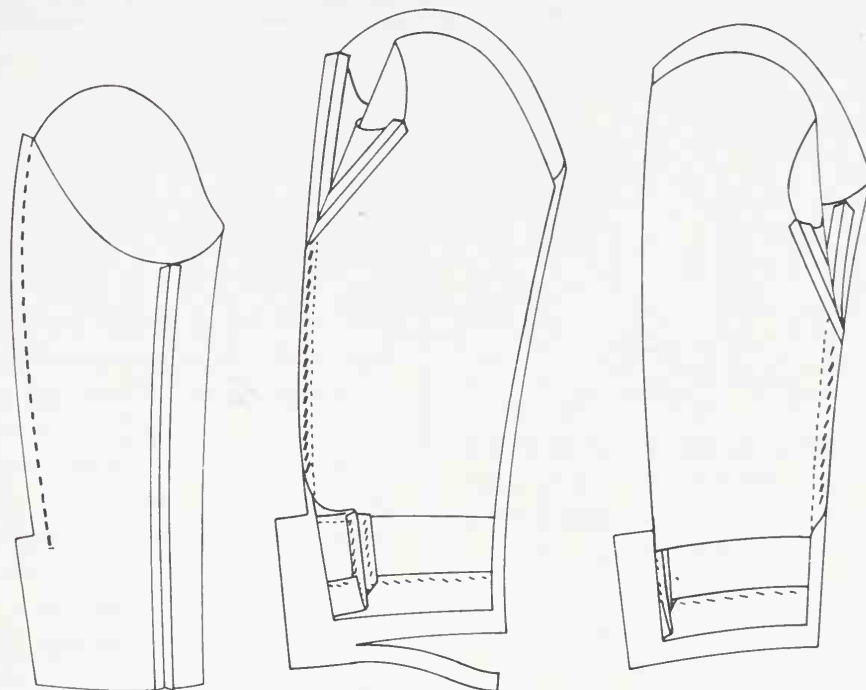

Machine-stitch the lining topsleeve and undersleeve together, and press the seams open.

With both the lining and sleeve inside out, place the two together, undersleeve to undersleeve. A $\frac{3}{4}$ " (1.9 cm) margin of lining should be visible above the sleeve. Beginning about 4" (10.2 cm) from the top of the top seam, diagonally

baste one layer of lining seam allowance to one layer of sleeve seam allowance. Baste to just above the top of the vent. Trim the lining to 1" (2.5 cm) below the sleeve hem fold.

Repeat the process at the undersleeve seam.

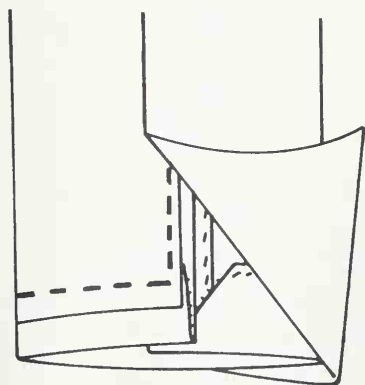

Reach into the lining, and turn the sleeve to the lining side, so that you can work on the lining hem and vent. Fold and baste the lining along the edge of the undervent (the undervent is on top when viewed from this side); and fold the lining hem about $\frac{3}{4}$ " (1.9 cm) above the hem of the sleeve. Baste the lining hem about 1" (2.5 cm) above its fold, so that you will be able to lift it up for hand-stitching, shortly.

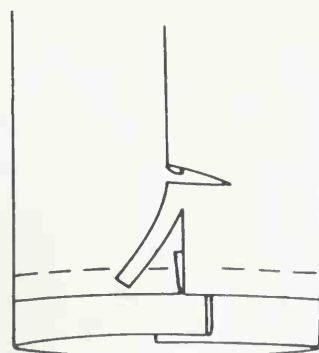

The top layer of lining is now slashed horizontally, about $\frac{1}{2}$ " (1.3 cm) below the bottom of the lining seam. The slash extends across, just past the edge of the undervent. This frees the lining to be folded along the garment fabric at the edge of the topvent.

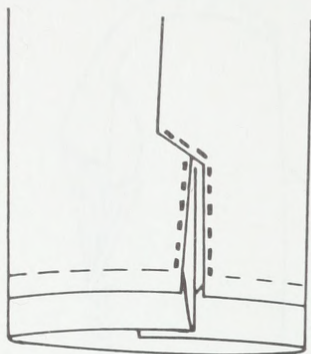

The lining is folded on the diagonal at the top of the vent and basted in place. The sides and top of the vent lining are finished with a hand back-stitch, using silk thread.

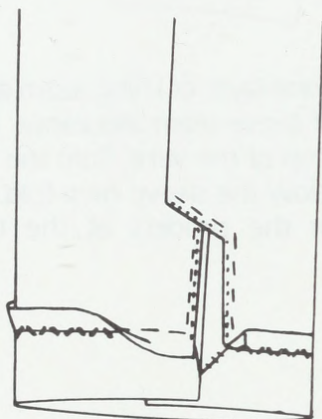

Lift the lining at the hem, and hem-stitch one layer of lining into the garment fabric hem.

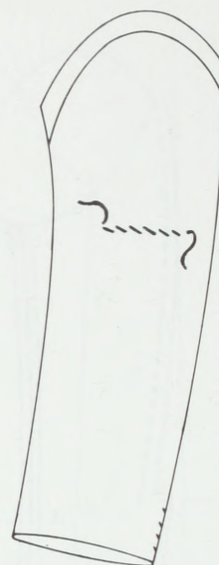

Turn the sleeve to the right side, and with the lining settled in place, baste across the topsleeve about 8" (20.3 cm) or so from the top, catching the topsleeve lining. This will hold the lining in place while you set the sleeve. Press the sleeve on the right side, on a flat surface, using a presscloth. Press a light crease in the topseam from elbow to hem.

SETTING THE SLEEVE



The garment fabric sleeve is set into the jacket just as the muslin sleeve was set. This time, however, you have the benefit of the front and back notches as guides.

Baste the sleeve using a straight running-stitch about $\frac{1}{4}$ " (6 mm) long, with spaces of about the same length in between. If your stitches are too small, the ease will have no room to settle in. *Do not* be discouraged if it takes two or three attempts to baste the sleeve in so that it hangs without rippling at the cap when viewed from the outside.

Once you are pleased with the hang of the sleeve, baste around the armhole a second time, stitching between the first stitches. This *lock-stitch* is done to hold the ease securely in place, and to prevent the possibility of the sleeve shifting during machine-stitching.

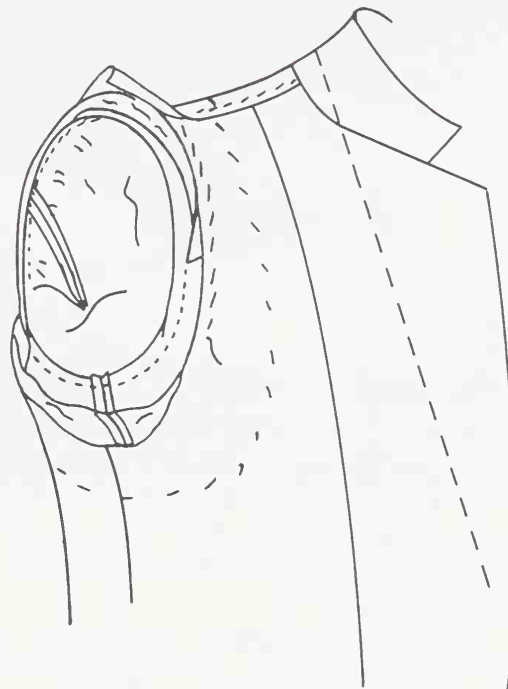

There is one more step to take before machine-stitching the sleeve. On the wrong side of the fabric, steam press on a flat surface, and shrink away the ripples at the top of the sleeve seam allowance. Be careful to press in from the armhole edge no more than one inch or so. If you steam press further, you will be shrinking the ease in the sleeve cap which you have so carefully created. You need the ease. Shrink away *only* the ripples.

Tuck the shoulder pad out of the way and machine-stitch around the armhole, catching only the garment fabric of the sleeve and armhole, and the pocketing reinforcement strip.

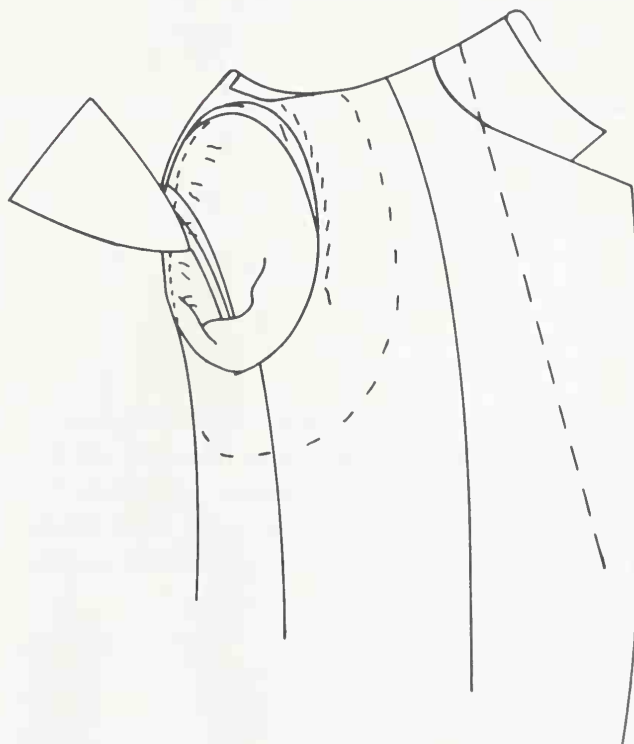

TACKING THE ARMHOLES

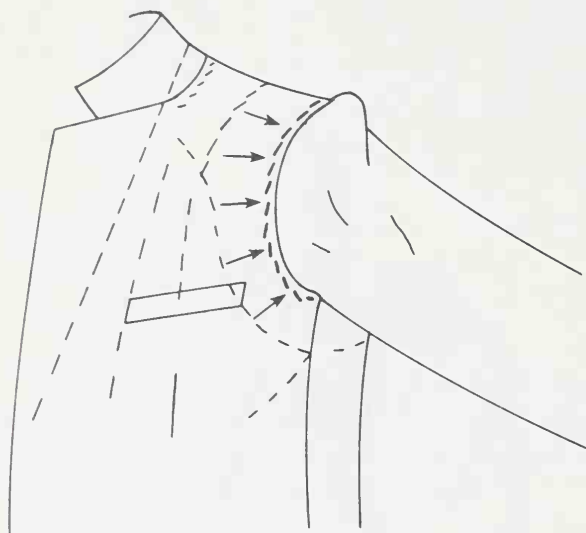

The sleeve is set, but the shoulder and armhole area still needs some attention. The jacket lining is loose at the back armhole, and the shoulder pad needs to be tacked into the armhole seam allowance. With this completed, you'll be able to attach the *sleeve head*, and close the sleeve lining.

With one hand inside the jacket, giving shape to the shoulder area, smooth the fabric



around the armhole towards the sleeve seam. Baste from the front notch up and over the shoulder, to the end of the shoulder pad. As you baste from the front notch to the beginning of the shoulder pad, catch the lining. As you continue up and over the shoulder, catch one layer of the shoulder pad.

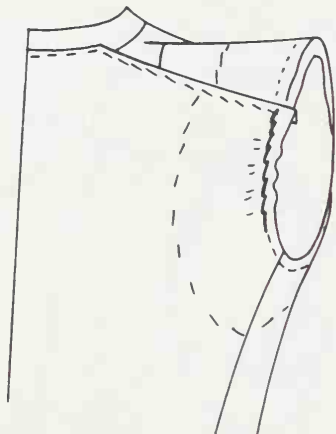

On the inside of the jacket back, the lining is still loose at the armhole. Baste from the underarm up the back of the armhole, as far as the lining shoulder seam. Use a large back-stitch, and place a bit of ease in the back lining as you baste.

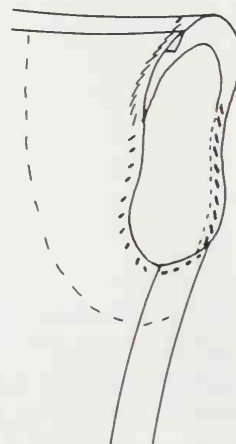

Shoulder pad, jacket lining, pocketing, sleeve, and jacket, all meet in the armhole seam allowance. Baste around the armhole, tacking all these layers together, so that the shoulder seam becomes a firm unshifting line. Tack first, the area of seam allowance untouched by the shoulder pad. The stitch is a diagonal-stitch, $\frac{1}{8}$ " (3 mm) beyond the machine stitchline, in the seam allowance.

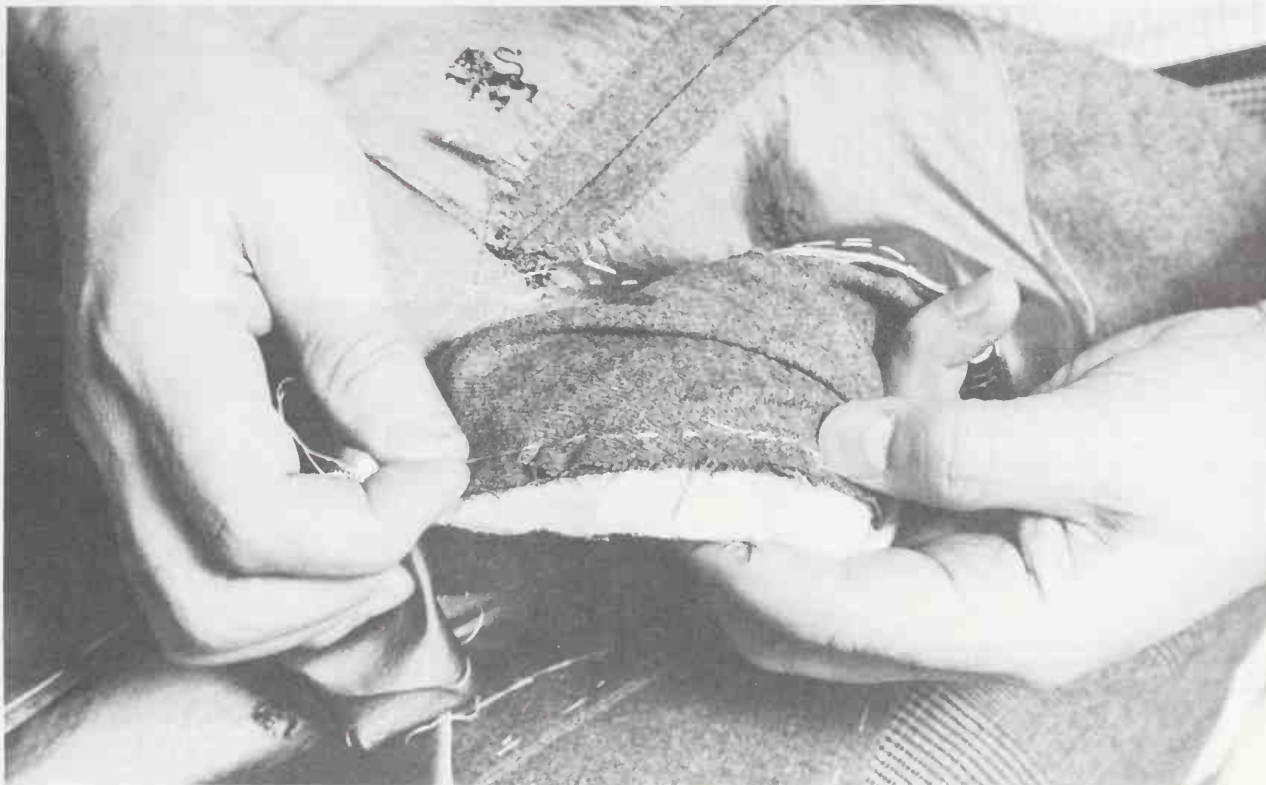

Since you are working with the jacket inside out, be aware that the shoulder pad is now curving in a direction opposite to that which it will take when the jacket is worn. Before you baste the shoulder pad into the armhole seam allowance, force the shoulder pad into the correct curve. Experiment, by turning the jacket right side out, in order to be sure of the proper direction of the curve. It is not necessary to baste through the entire shoulder pad. One layer of the padding caught in the seam allowance is sufficient.

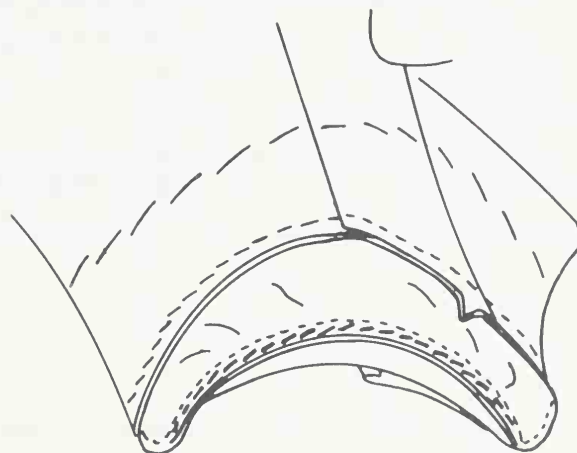

If necessary, the shoulder pad and lining are now trimmed flush with the garment fabric seam allowance. Be careful not to trim away the small edge of seam allowance from the side panel back seam. If you do, you eliminate the possibility of ever letting the jacket out in this area.

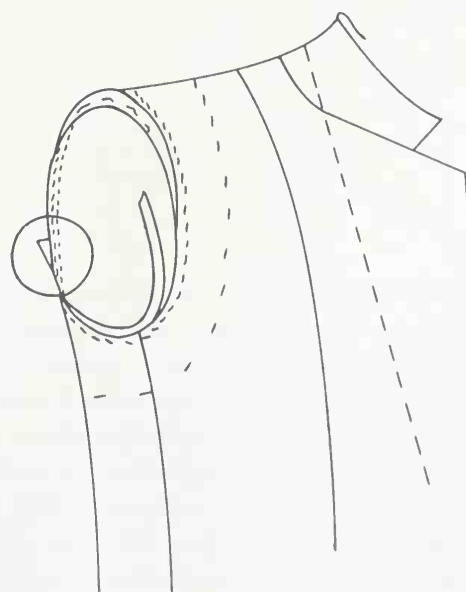

THE SLEEVE HEAD

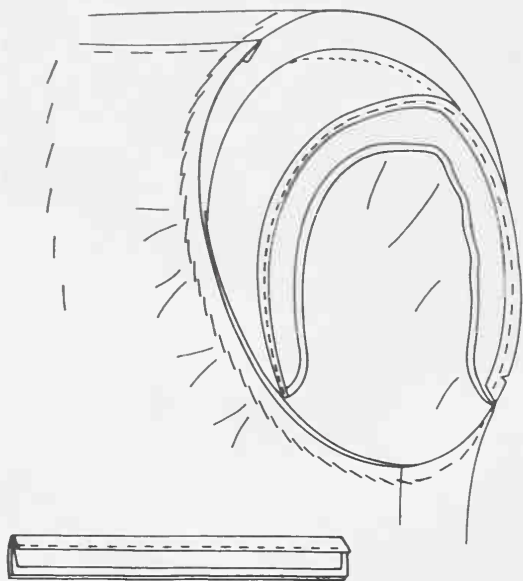

The sleeve head is a strip of cotton wadding, covered with muslin and with a strip of bias canvas interfacing. Its job is to fill out the cap of the sleeve a bit, and to create a graceful fall of the fabric at the top of the sleeve.

The head is inserted into the sleeve with the canvas facing up, and hand-stitched into the

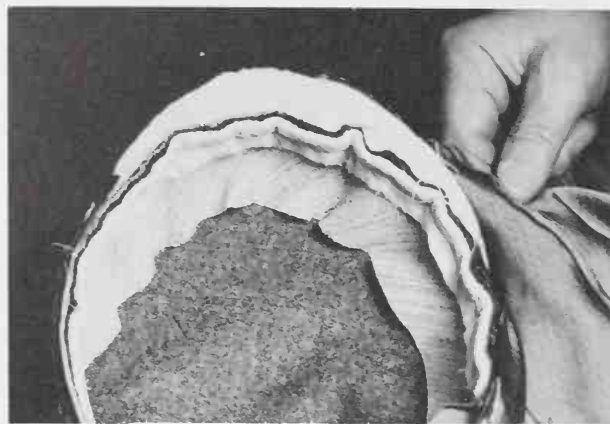

seam allowance using silk thread. Place the edge of the head even with the edge of the seam allowance, from the front notch, over the shoulder and down to about 2" (5 cm) below the back notch.

The sleeve lining is now brought up to be basted along the armhole edge, just covering the basting already there. Fold back about $\frac{1}{4}$ " (6 mm) at the top of the lining and check that the seams in the lining are aligned with the seams in the sleeve. A twisted lining will distort the hang of the sleeve, and will be very uncomfortable to wear. Slip-stitch the sleeve lining into the armhole seam allowance using silk finishing thread.

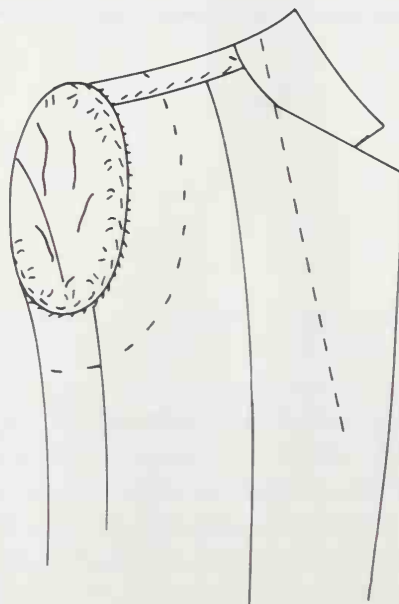

THE PLAID SLEEVE

If you are working with a plaid fabric, the sleeve must be cut so that the horizontal design lines on the sleeve match those across the jacket front. (Because of the ease in the sleeve cap, the horizontal lines on the sleeve will *not* match those on the jacket back.)

With the muslin sleeve well set, draw two or three horizontal guidelines on the front of the muslin to indicate the placement of the horizontal bars of the plaid design. Transfer these guidelines to the front of your sleeve front paper pattern, and use them as a layout guide.

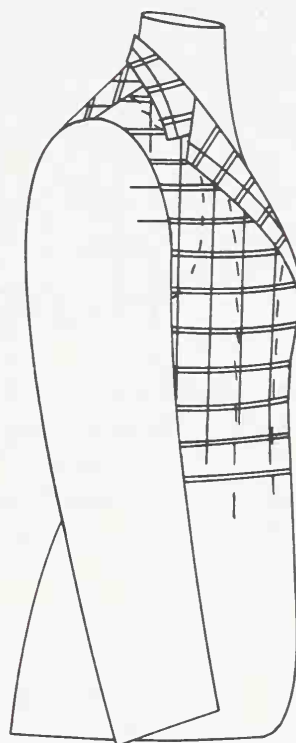

BUTTONS AND BUTTONHOLES

The choice of buttons for a fine tailored jacket should be in keeping with the high quality of the rest of the garment.

Dull horn or bone buttons, close in color to the jacket fabric, are most traditional. Shiny plastic buttons are glaringly inappropriate on fine fabric.

The jacket button is 30-line, the sleeve button is 24-line.

The top buttonhole on a jacket which has a lapel, should be placed about $\frac{5}{8}$ " (1.6 cm) below the bottom of the lapel roll line. If the button is placed lower or higher, the lapel will begin to roll just above whatever point that happens to be.

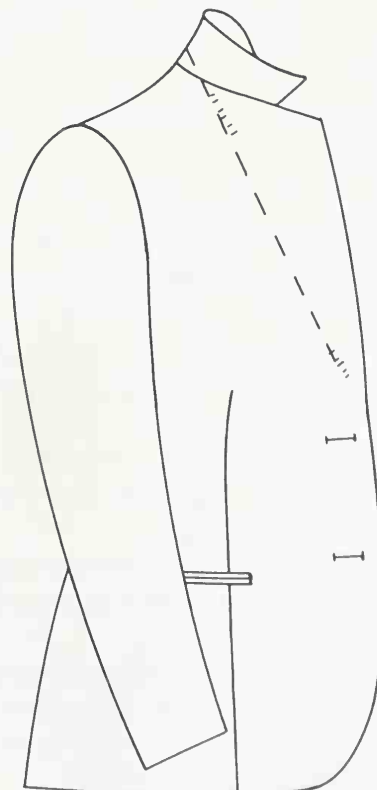

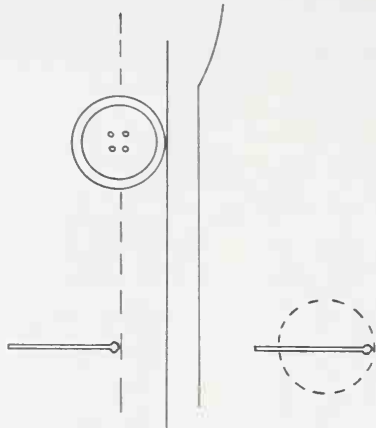

The buttonhole begins in from the edge of the finished jacket a distance equal to one half the diameter of the button, plus $\frac{1}{4}$ " (6 mm).

The size of the jacket buttonhole is equal to the diameter of the button, plus a "small" $\frac{1}{4}$ " (6 mm).

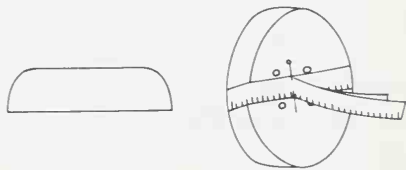

For a flat button, the size of the jacket buttonhole is equal to the diameter of the button, plus a "small" $\frac{1}{4}$ " (6 mm). If your button is not flat, the length of the buttonhole should equal one-half the circumference of the button.

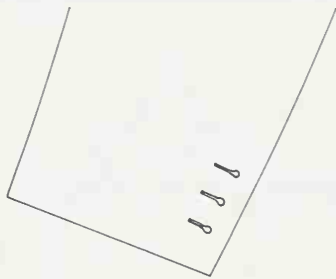

On the sleeve, real buttonholes are a distinctly custom touch. The buttonholes begin $1\frac{1}{4}$ " (3.2 cm) above the hem fold, and $\frac{1}{2}$ " (1.3 cm) away from the fold at the edge of the topvent. If three buttons are used on the sleeve, the buttonholes are placed $\frac{3}{4}$ " (1.9 cm) apart. If four buttons are preferred, the buttonholes are placed $\frac{5}{8}$ " (1.6 cm) apart, so that the buttons will be almost touching.

The size of the sleeve buttonhole is equal to one half the diameter of the button, plus $\frac{1}{8}$ " (3 mm).

Handworked buttonholes, reinforced with gimp, or bound buttonholes, are a custom touch in tailoring. Machine buttonholes work as well, but are not nearly as beautiful.

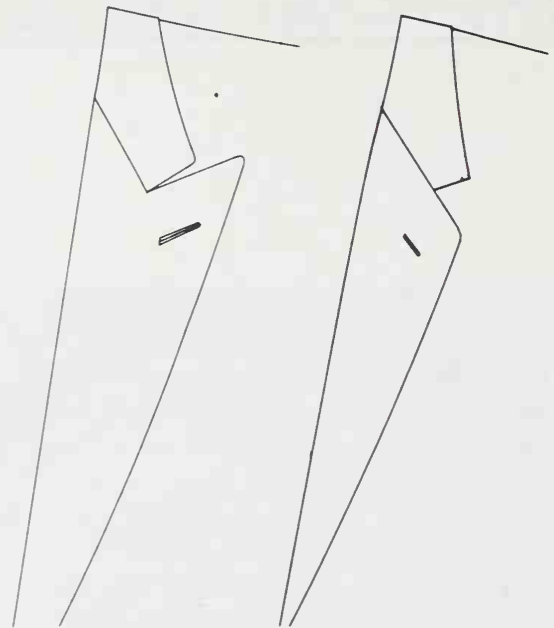

If you choose to add a lapel buttonhole, it should be cut parallel to the top of the lapel. The buttonhole on a *peak lapel* will, therefore, slant *upward*. On a *square lapel* it will slant *downward*.

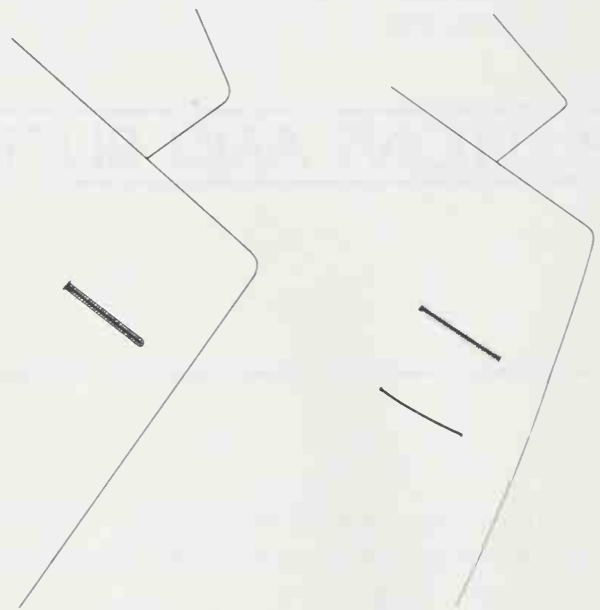

The length of the buttonhole is between $\frac{3}{4}$ " (1.9 cm) and 1" (2.5 cm) depending on the width of the lapel, and since it will not actually be used for a button, there is no keyhole cut at the end.

The buttonhole is placed about $1\frac{1}{2}$ " (3.8 cm) below the top of the lapel and $\frac{1}{2}$ " (1.3 cm) in from the edge.

On the wrong side of the lapel, about 1" (2.5 cm) below the buttonhole, a thread loop is sewn. This serves to hold the stem of a small flower boutonnière.

CONSTRUCTING THE BUTTONHOLES

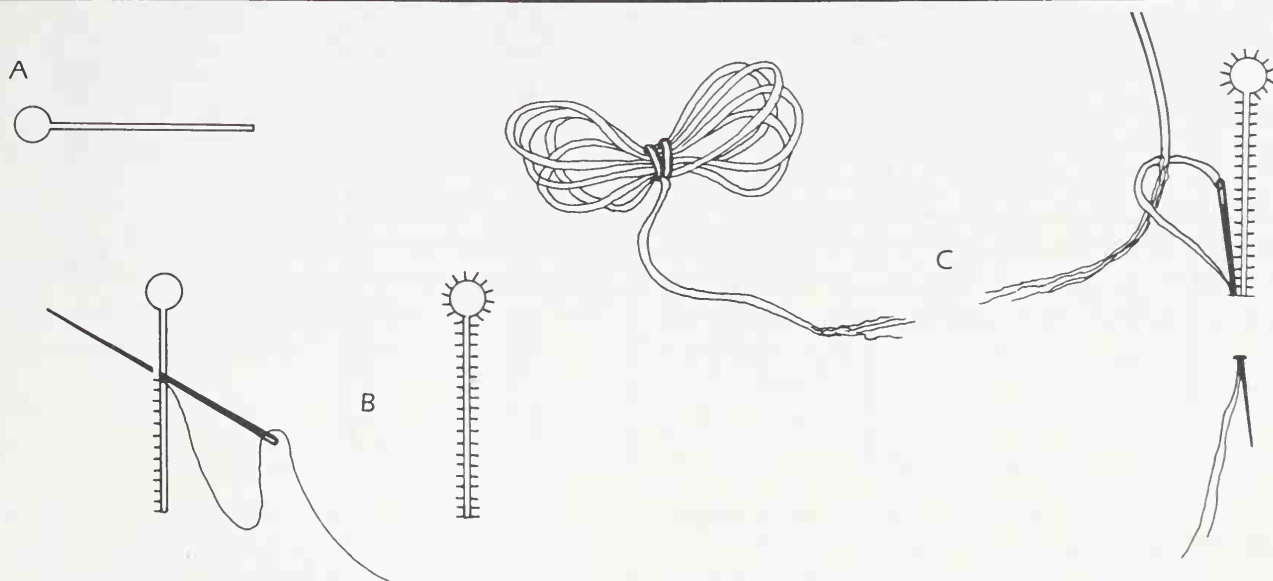

The Handworked Buttonhole

Snip the buttonhole through the jacket front, the canvas, and the facing. At the end of the buttonhole closest to the jacket edge, cut a small keyhole.

Trim away the canvas around the very edge of the buttonhole, so that stray white canvas threads do not find their way into the buttonhole stitches.

Using silk finishing thread, blanket-stitch around the buttonhole to control the fraying threads. These stitches will not be seen in the finished buttonhole.

Insert a threaded needle, eye first, under the jacket fabric and the canvas, and have it exit about $\frac{1}{16}$ " (1.5 mm) before the end of the buttonhole.

Peel away about $1\frac{1}{2}$ " (3.8 cm) of the outer layer at the end of the gimp, so that the end is thinner than the rest; and insert the peeled end of the gimp into the thread loop.

You needn't cut a small piece of gimp for the buttonhole. Use the end of the entire yard or so you have purchased, and cut the gimp only after the buttonhole is complete.

Pull the sharp end of the needle, and the thread ends, and draw the gimp through the fabric. Anchored in this position, the gimp will lie on top of the buttonhole, right at the edge, while the buttonhole is stitched. *Do not* allow the gimp to fall into the slit in the fabric, as this will produce a wider opening than you want.

Cut one yard of silk buttonhole twist, wax it well, and press the twist between two sheets of paper. The heat will melt the wax into the thread and give it added body.

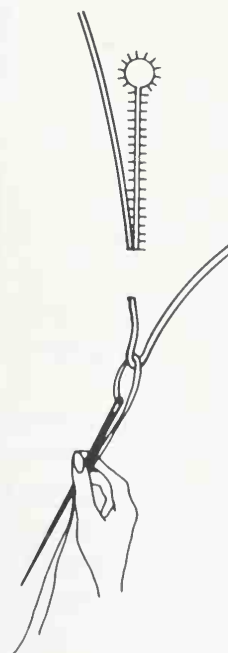

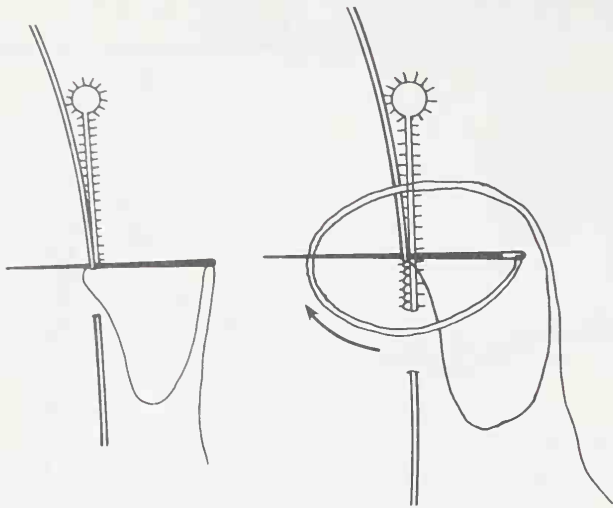

The buttonhole twist is used as a single thread, knotted at the bottom.

Hold the jacket so that the keyhole in the buttonhole is at the top, and take the first stitch at the base of the buttonhole. Hide the knot between the layers of fabric.

For each stitch, bring the double end of the thread in a clockwise movement, across the bottom of the buttonhole and up under the needle.

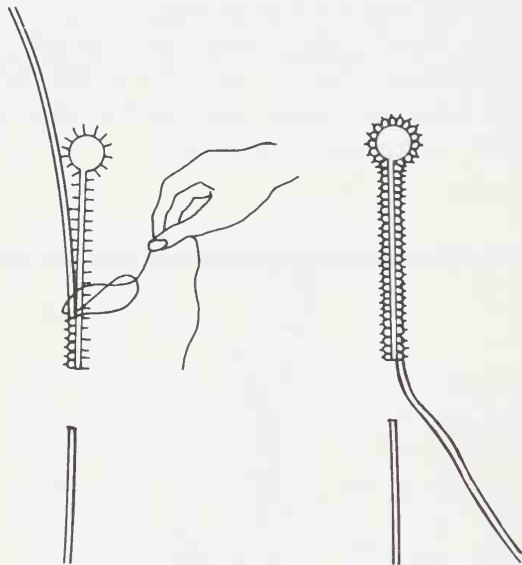

Place the knot, which this movement produces, right on top of the gimp with a firm pull of the thread.

Stitch around the buttonhole, encircling the gimp with thread. The stitches should be about $\frac{1}{8}$ " (3 mm) deep and quite close to one another, but not necessarily touching.

At the keyhole, the stitches should fan out, the outer ends of the stitches being a bit farther apart than the inner ends.

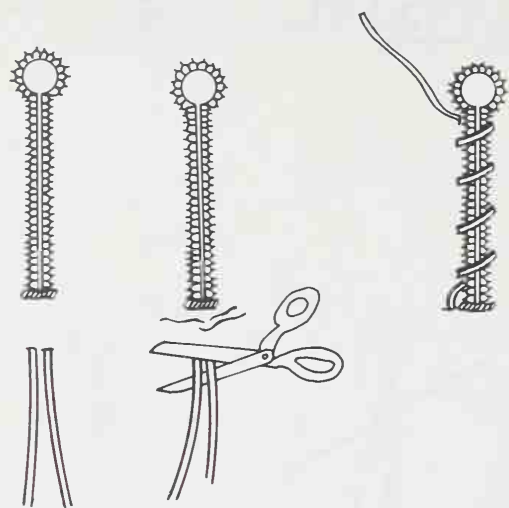

When you have stitched around the entire buttonhole, cut the gimp and bring the end under the canvas and out, as you did before, using the threaded needle.

Bartack at the base of the buttonhole and secure the stitch on the inside.

The ends of the gimp are pulled until a ripple appears in the fabric between the buttonhole and the gimp. If you snip the gimp close to the fabric, the ends will disappear under the canvas.

Whip-stitch the buttonhole closed until after the final pressing.

The Bound Keyhole Buttonhole

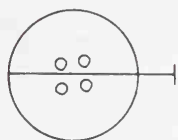

Draw the buttonhole placement line on the jacket canvas using the same dimensions for length and for placement as were used for the handworked buttonhole.



Draw a line $\frac{1}{8}$ " (3 mm) above and $\frac{1}{8}$ " (3 mm) below the placement line, and round off the end of the line closest to the jacket front edge.

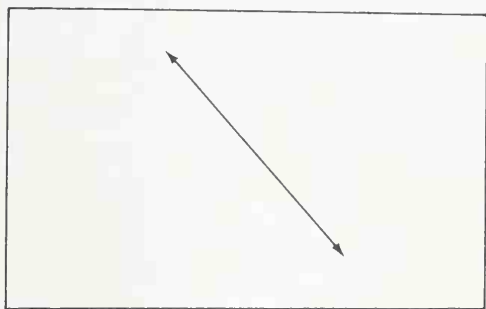

Cut a bias patch of garment fabric 2" (5 cm) wide and 2" (5 cm) longer than the buttonhole placement line.

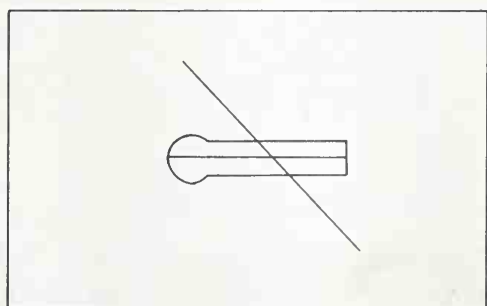

On the right side of the jacket front, center and baste the bias patch over the buttonhole markings.



Working from the canvas side, and using a small machine stitch, sew around the buttonhole top, keyhole and bottom. *Do not* sew across the straight end of the buttonhole.

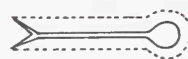

Working from the canvas side, slash through the center of the buttonhole. Cut out the keyhole, but *be careful* of cutting too close to the stitches. Cut a prong at the straight end of the buttonhole.



Trim the canvas in the buttonhole, but leave the canvas in the prong.

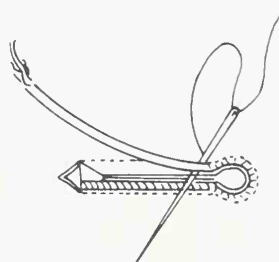

Whip-stitch a piece of gimp around the inside of the buttonhole stitchline. You may use basting thread, if you like, since these stitches will not be seen in the finished buttonhole.

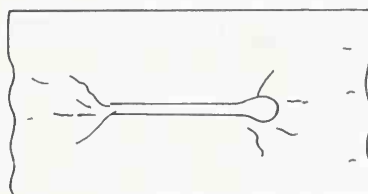

Bring the bias patch through the buttonhole to the wrong side of the jacket.

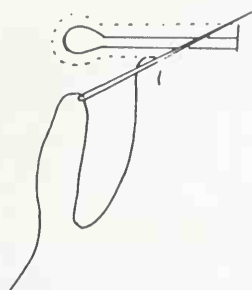

On the right side, prick-stitch around the buttonhole using silk finishing thread. The stitches are taken just beyond the gimp on the jacket front, and should be small enough to be barely visible.

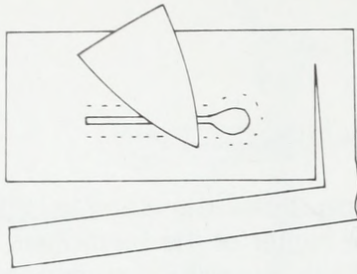

Trim the bias patch, and press the buttonhole on the wrong side.

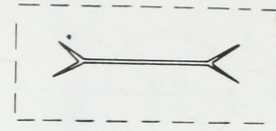

Working from the right side, slash through the center of the buttonhole, snipping the facing fabric.

On the wrong side extend the slash, and cut prongs at either end of the buttonhole.



Place the jacket facing over the buttonhole, and baste around the buttonhole.

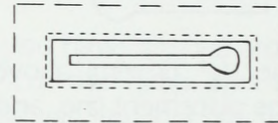

Fold under, and baste the facing around the edge of the buttonhole. Prick-stitch along the folded edge, using silk-finishing thread.

The Bias Bound Buttonhole

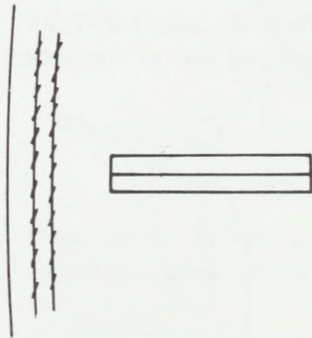

Draw the buttonhole placement line on the jacket canvas, using the same dimensions for length and for placement as were used for the handworked buttonhole.

Draw a line $\frac{1}{8}$ " (3 mm) above and $\frac{1}{8}$ " (3 mm) below the placement line.

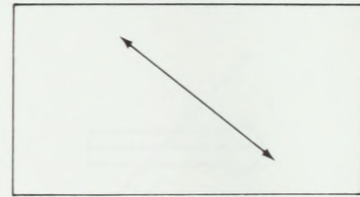

Cut a bias patch of garment fabric 2" (5 cm) wide and 2" (5 cm) longer than the buttonhole placement line.

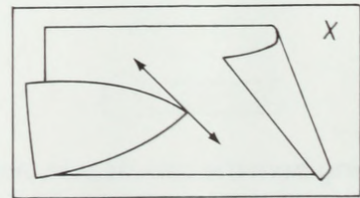

Press a bias strip of very thin fusible to the center of the patch.

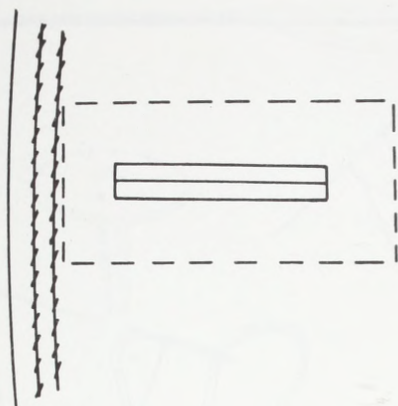

On the right side of the jacket front, center and baste the bias patch over the buttonhole marking.

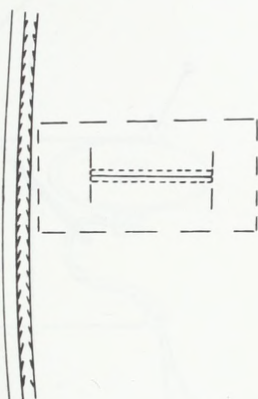

Working from the canvas side, and using a small machine stitch, sew a rectangle completely around the buttonhole placement line.

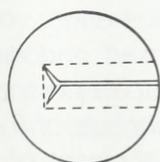
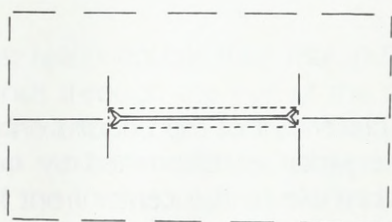

From the canvas side, slash through the center of the buttonhole and cut prongs at either end.

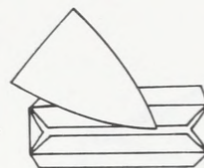

Press the seam open along the top and bottom of the buttonhole.

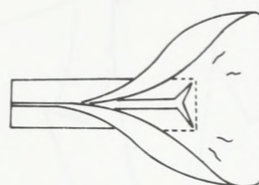

Bring the bias patch through the buttonhole to the wrong side of the jacket.

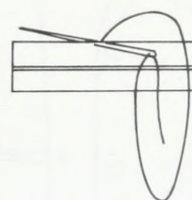

Working from the right side of the jacket, and using silk finishing thread, stitch on the buttonhole seamline top and bottom. The piping should be evenly distributed at top and bottom.

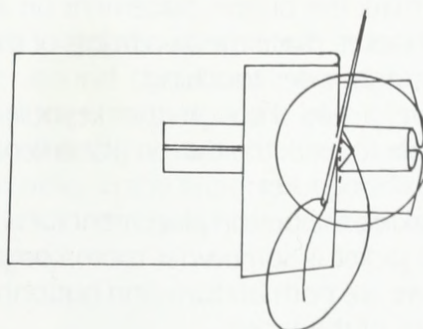

At either end of the buttonhole, tack the prong into the bias patch.

The facing side of the buttonhole is completed following instructions on page 182.

SETTING THE BUTTONS

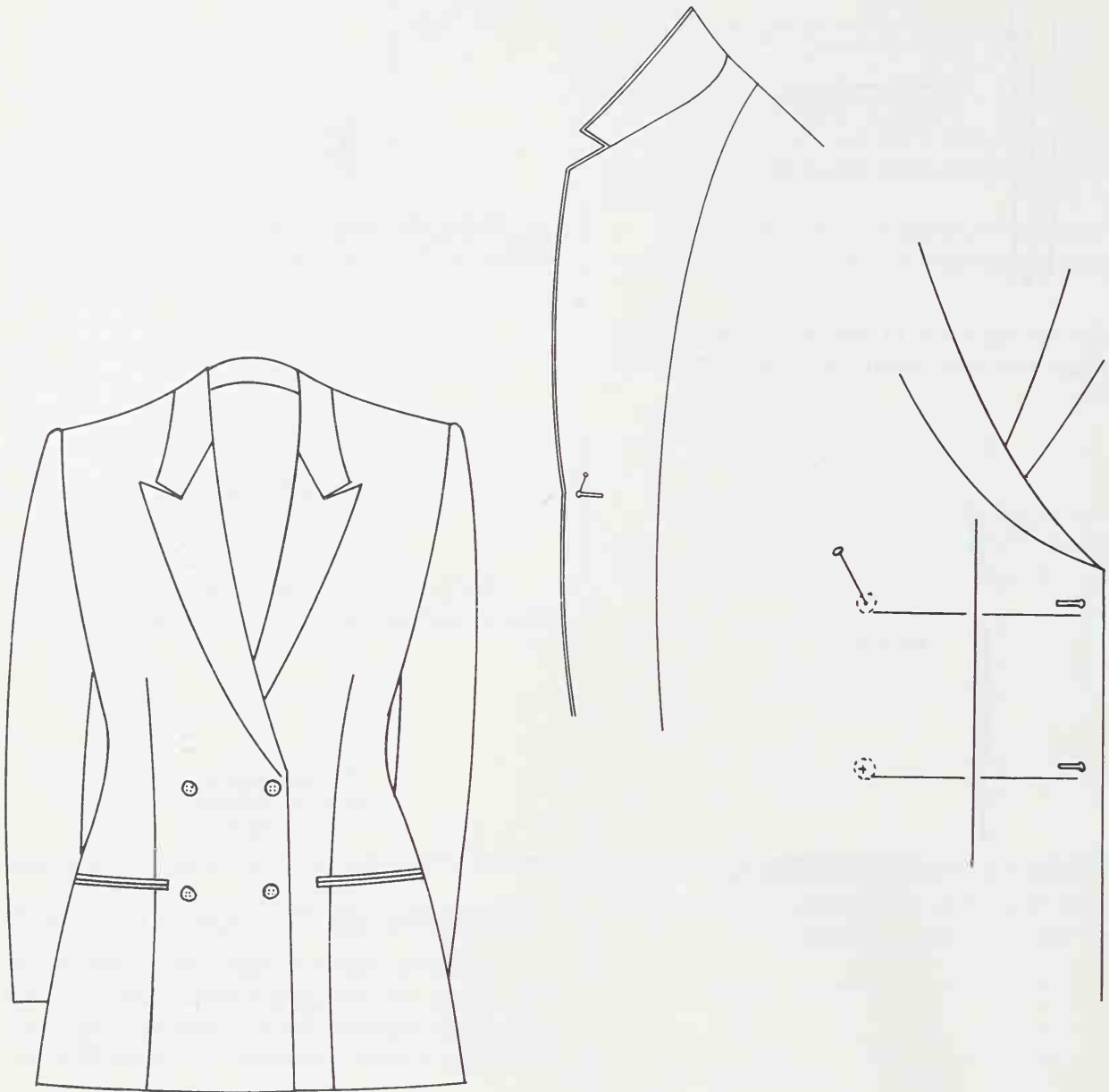

To mark the button placement on a single-breasted jacket, place the two fronts of the jacket together, right sides touching.

Place a pin through the keyhole of the buttonhole to mark the button placement on the left side of the jacket.

Marking the button placement for a double-breasted jacket is somewhat more complicated, since there are both buttons and buttonholes on both sides of the jacket.

The buttonholes are placed on the right side of a double-breasted jacket using the same measurements as were used for the single-breasted jacket.

The placement of the buttons on the *right* side of the jacket is determined by measuring from the keyhole to the center front line, and applying this measurement from the center front line away from the jacket edge.

With the jacket closed, and the center front guidelines matching, place a pin through the top button mark on the *right* side of the jacket. This pin will indicate the placement of the one buttonhole which is needed on the *left* side of the jacket. It also indicates the placement of the one button which must be placed on the inside of the right side of the jacket.

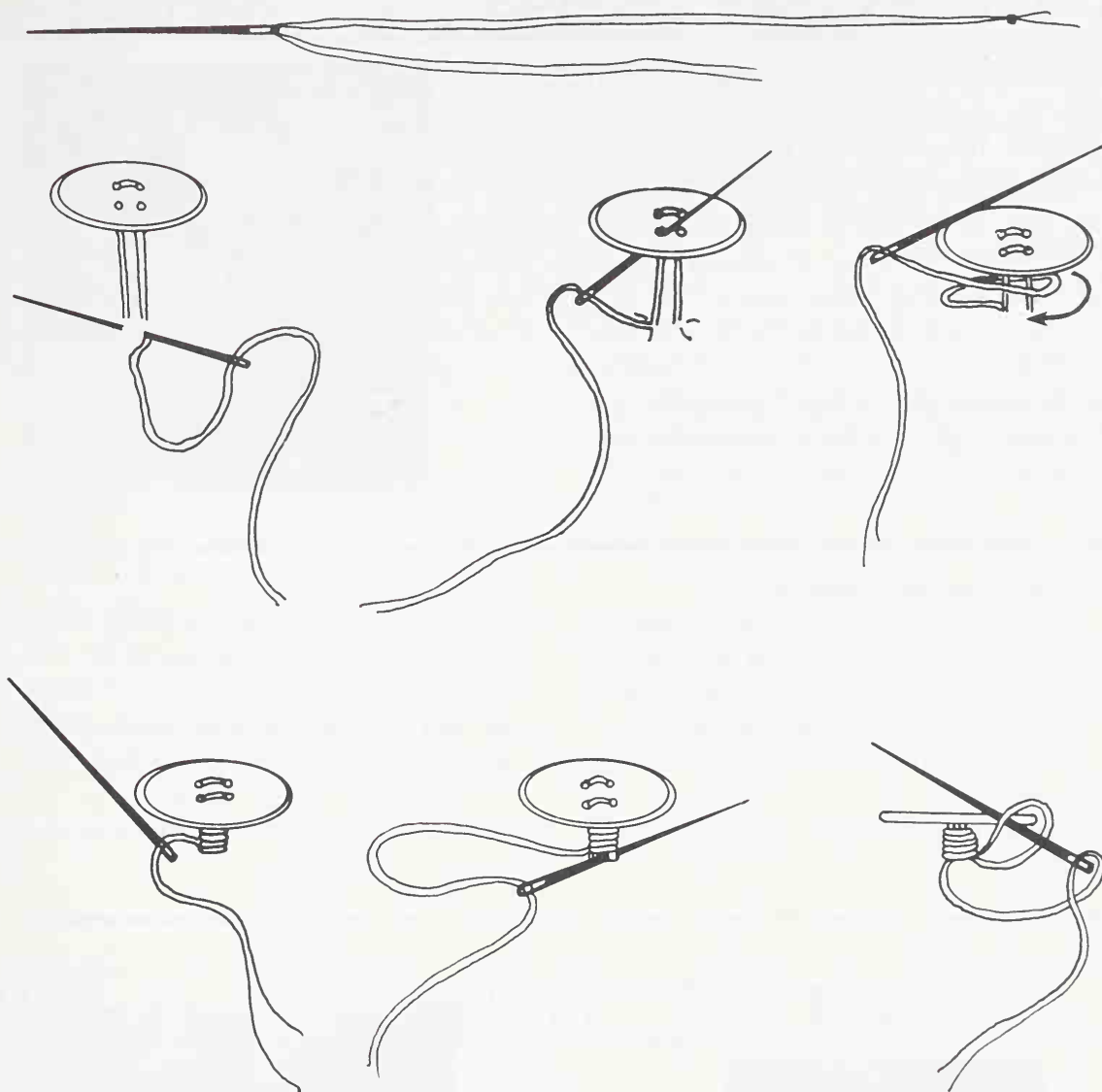

After the final pressing of the jacket, the buttons are sewn to the jacket using a double strand of waxed, pressed, silk buttonhole twist thread.

Most tailors double their thread by placing two strands through the eye of the needle (as illustrated)—a challenge, indeed. This allows the needle to move to different points along the length of the thread as you sew, thus reducing the probability of the thread being weakened, by being pulled by the needle, over and over again, at the same spot.

The stitches taken on the front of the jacket to attach the button, do not go through all the

layers of the fabric, and therefore, do not show through the facing. The needle is brought through each hole in the button twice, anchoring each side of the button with four strands of thread. A $\frac{1}{4}$ " (6 mm) shank is created by holding the button away from the jacket as you stitch.

The stitches completed, the thread is wound around the shank several times. Four knots are then stitched at the base of the shank, catching the thread which comes from each of the four holes in the button. A button secured to the jacket in this way is not likely to be lost without warning.

FINAL PRESSING

Following the pressing techniques outlined on page 8, the jacket is now carefully and completely pressed. The pressing is done before the buttons have been sewn on, to permit the iron greater access. The pressing proceeds step by step, as follows:

1. The underside of one lapel, the underside of the collar, and the underside of the second lapel.



On the Inside of the Jacket

2. The facing, from the bottom of the lapel to the hem on one side of the jacket; and the lining below the waist, first on one side of the jacket, and then on the other. Be careful to use a tailor's ham to press shaped areas of the jacket.
3. The lining in the chest area on both sides of the jacket.

4. Across the hem on the lining side, from one side of the jacket to the other.

On the Outside of the Jacket

5. Each front of the jacket from shoulder to hem, and the side seam.
6. The jacket back from shoulder to hem.

Sleeves

7. On the right side of the fabric, the front seam, and the undersleeve.

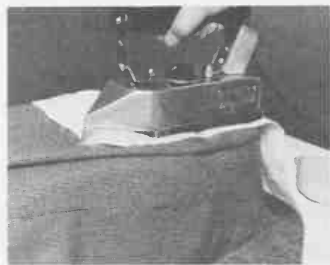

8. With the sleeve board inside the jacket, the topsleeve, from biceps to hem, creasing the sleeve lightly from elbow to hem.
9. The lining underarm area.

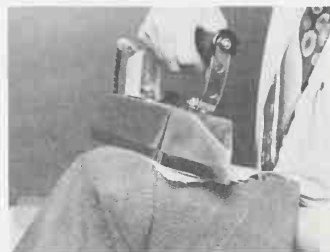

10. Holding a press mitt inside the shoulder of the jacket, press each shoulder and sleeve cap on the right side of the fabric.

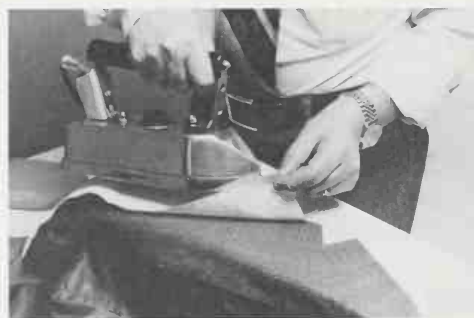

11. The right side of each lapel.



12. With the lapel and collar lying flat over the pressing board, press the gorge line, and a light crease at the neck edge of the gorge line.

THE UNLINED JACKET

The lining in a tailored jacket serves to conceal the construction details on the inside of the jacket; layers of canvas, pocketing, and cotton wadding. There are, however, some unlined versions of the tailored jacket that have been designed especially for tropical climates. The version demonstrated here is most suitable for a loose-fitting jacket with little dart shaping.

In the absence of a lining, the inner construction details must be tidied up, or concealed by means other than a full lining. In the unlined jacket presented here:

- All darts and seam allowances are finished so that there are no raw edges of fabric visible on the inside of the jacket.
- The inner construction details of the jacket pockets are covered with garment fabric patches.

- The facing is extended to conceal the canvas.
- The shoulder pads are covered by a lining yoke at the back, and by the extended facing in the front.

Even when the rest of the jacket is unlined, the sleeves are lined for the wearer's comfort, and to control excessive wrinkling in the sleeve.

In presenting the construction of this jacket, we will assume that the reader is familiar with the tailoring techniques demonstrated previously in the construction of the classic jacket.

DARTS IN THE UNLINED JACKET

In an unlined jacket, the darts are *not* slashed open. They are pressed toward the side seam, and are secured in place by a row of tiny prick stitches on the right side of the fabric.

All seam allowances are also finished with Hong Kong piping (see page 187).

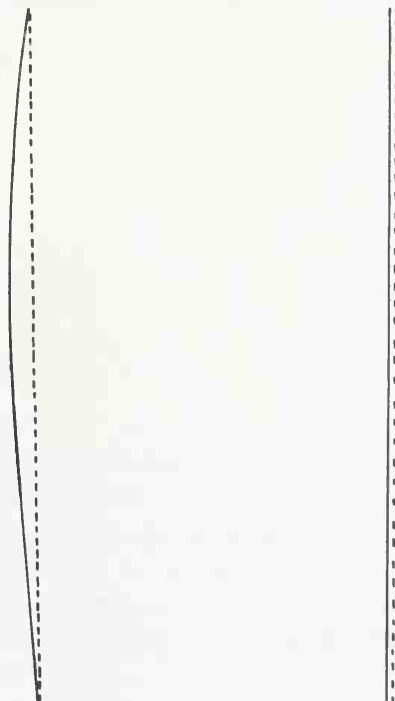

POCKETS IN THE UNLINED JACKET

In an unlined jacket the most convenient pocket to use is the *patch pocket*. The patch pocket is simply tacked on to the front of the jacket and does not involve construction that would be visible, and therefore necessary to hide, on the inside of the jacket.

Other pockets, however, can be adjusted slightly to suit the unlined jacket. We'll demonstrate these modifications in the double-piping pocket.

With the darts and front seams sewn, draw the pocket opening line on the jacket front, using tailor's chalk and a hip curve ruler. The hip-level pocket opening on a woman's jacket runs between 5½" to 5¾" (14 to 14.6 cm) in length.

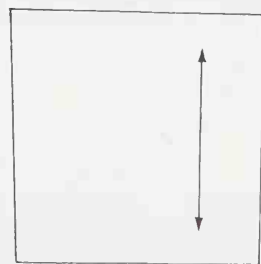
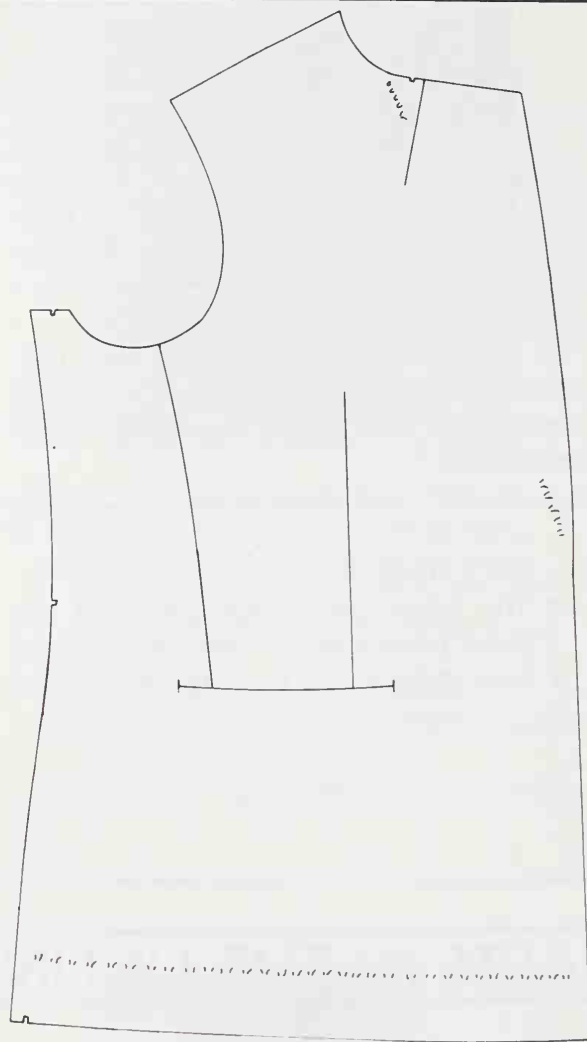

Cut one piece of garment fabric as a patch for the back of each pocket, straight grain, 1½" (3.8 cm) wider than your pocket opening and about 7½" (19.1 cm) long.

This patch will be used on the inside of the jacket as a backing for the pocket.

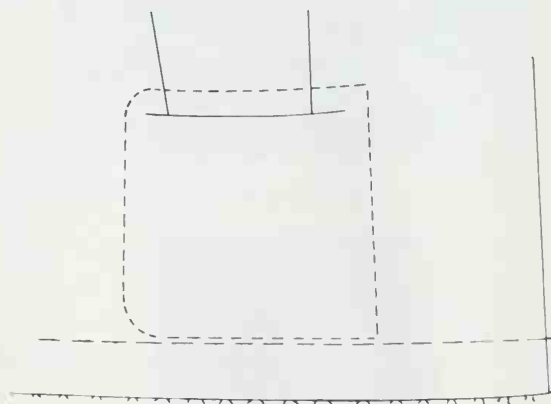

Check the length of the patch by placing the top edge ¾" (1.9 cm) above your pocket opening line. The bottom edge of the patch should extend no lower than the top of the hem, when the hem is turned up.

Trim the length of the patch, if necessary, and round off the two corners closest to the side seam of the jacket.

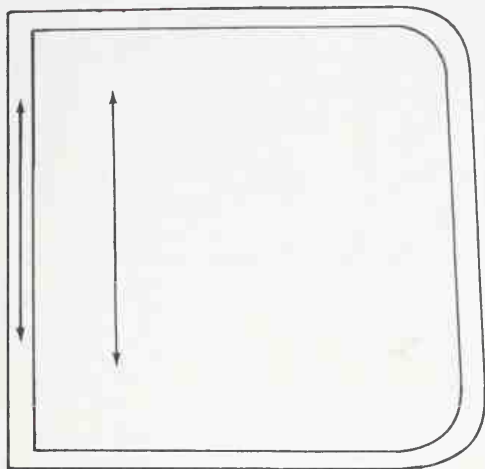

Cut one piece of pocketing for each pocket, straight grain, $\frac{1}{2}$ " (1.3 cm) larger than the garment fabric patch all around.

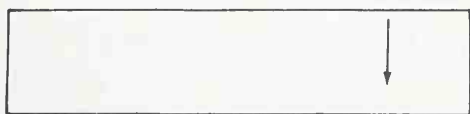

Cut two pieces of garment fabric, straight grain, nap down, to be used as piping. Each piece of piping is cut 2" (5 cm) longer than the pocket opening. One piece is $1\frac{1}{2}$ " (3.8 cm) wide, the other is 2" (5 cm) wide.

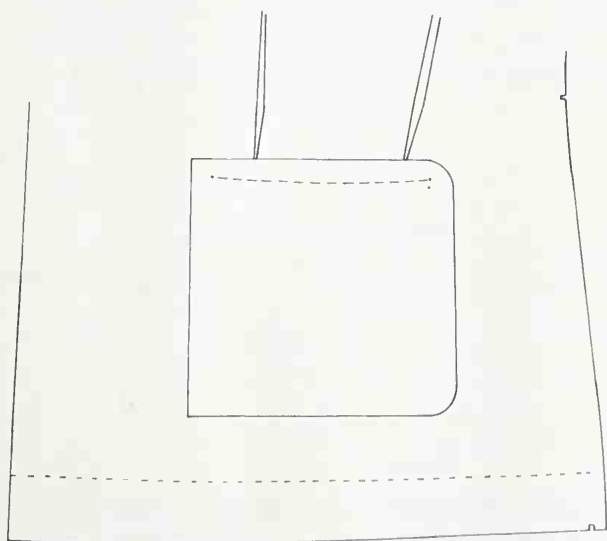

Place the pocketing patch on the wrong side of the jacket, its top edge $\frac{3}{4}$ " (1.9 cm) above the pocket opening line.

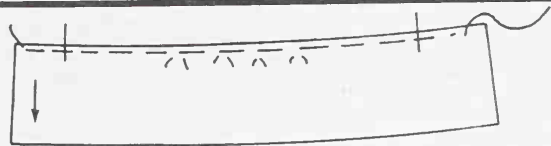

Place the wider piece of piping face down on the right side of the jacket front, nap up. The top edge of the piping should be flush with the pocket opening line. Baste very close to the edge, catching the piping, the jacket, and the pocketing patch.

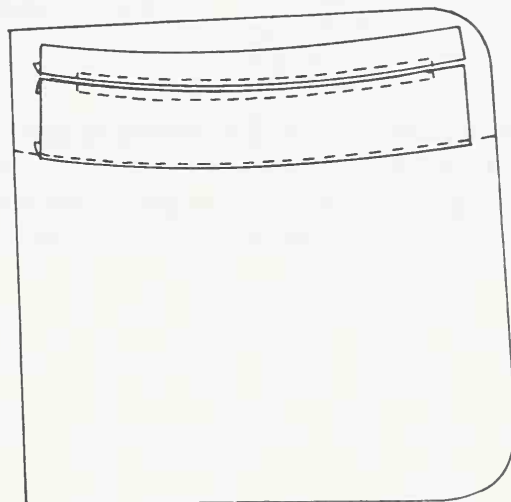

Turn to page 84, and continue the construction of the pocket following instructions through to the bottom of page 85.

Press back a $\frac{1}{4}$ " (6 mm) hem on the bottom edge of the bottom piping, and machine-topstitch the folded edge to the pocketing patch.

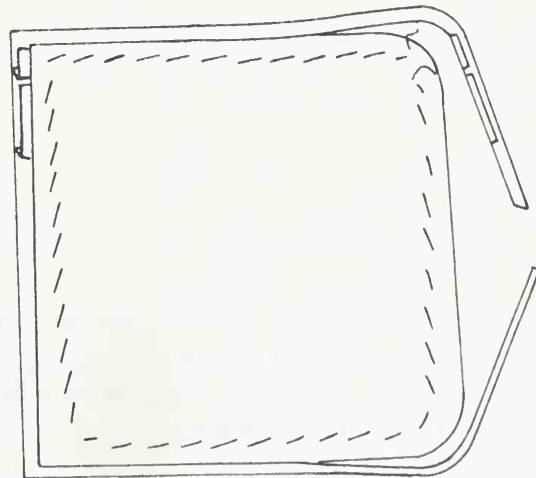

On the wrong side of the jacket, center the garment fabric patch on top of the pocket. The top edge of the garment fabric patch should be at the top edge of the piping. Baste the patch in place around the edges, catching all layers of the pocket.

Catch only the pocket and not the jacket in these stitches. Trim the pocketing even with the garment fabric patch.

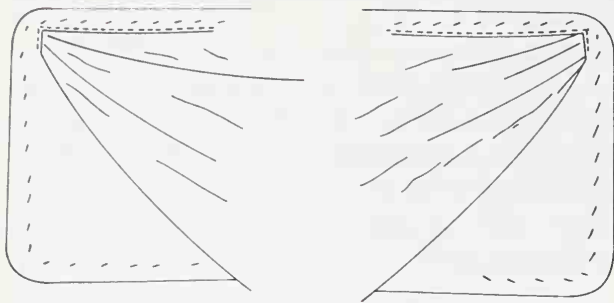

Machine-stitch on the pocketing patch, as close as possible to the jacket at the top of the pocket opening. Stitch the length of the pocket opening and pivot at either end to catch the prong area.

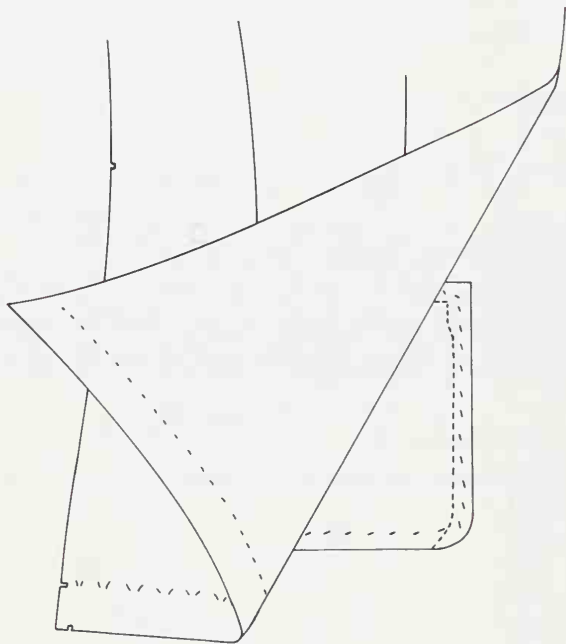

On the pocket edge which is closest to the center front of the jacket, continue stitching out from the prong and down the edge of the patch, about $\frac{1}{2}$ " (1.3 cm) from the edge.

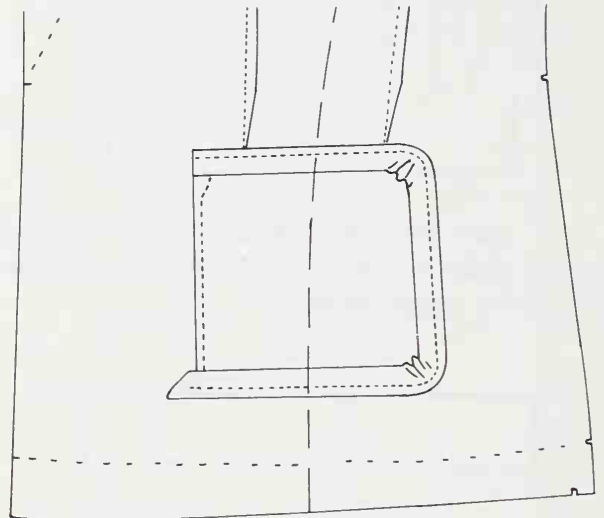
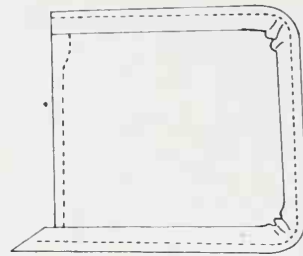
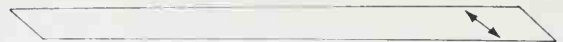

Cut a bias strip of lining about 1" (2.5 cm) wide, and long enough to extend around three sides of the pocket. This lining strip will be used as a piping finish around the edge of the garment fabric patch on the wrong side of the jacket.

Because the edge of the patch closest to the front will eventually be covered by the jacket facing, the piping is placed only along three edges—unnecessary bulk being undesirable.

Using a $\frac{1}{4}$ " (6 mm) seam, machine-stitch the lining strip along the edge of the patch.

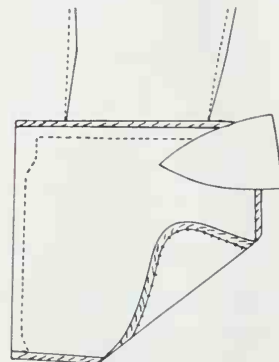

Bring the piping to the pocketing side of the patch, and fold the raw edge under. Slip-stitch along the folded edge of the piping, on the pocketing side of the patch. Press the piping.

The pocket is complete.

THE FACING IN THE UNLINED JACKET

In an unlined jacket, the facing takes on the added role of concealing the entire canvas. The facing is cut using the same dimensions as for the canvas, however, the darts are eliminated in the facing.

The facing in an unlined jacket is handled essentially as it was in the lined jacket. The inner edges of both canvas and facing are basted together, and finished with a Hong Kong piping.

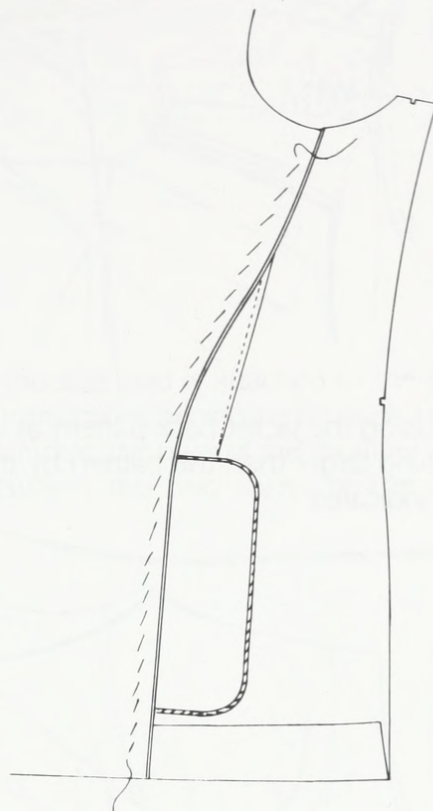

COVERING SHOULDER PADS IN THE UNLINED JACKET

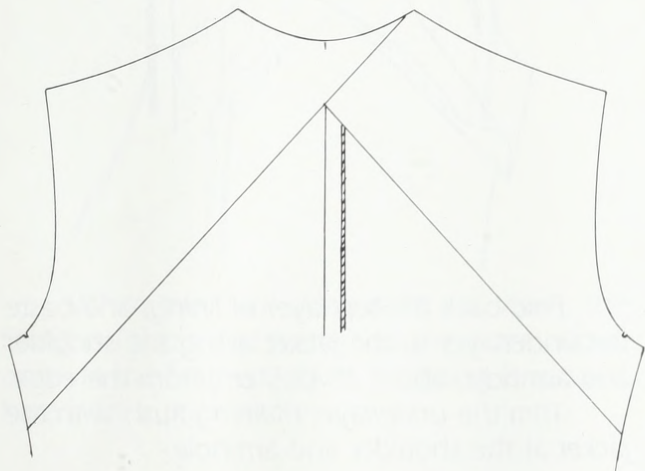

Since the jacket is unlined, the shoulder pads will be covered by a double-layered lining yoke, on either side of the jacket back. The front of the shoulder pads will be covered by the extended facing.

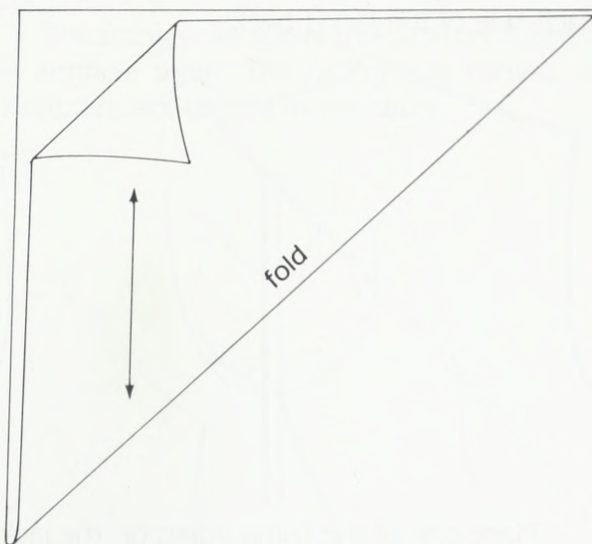

To create the yoke, fold a piece of lining, maintaining the grainline as illustrated.

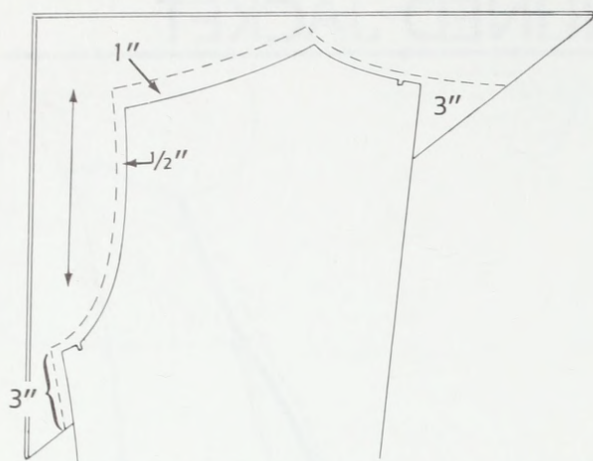

Using the jacket back pattern as guide, cut the lining larger than the pattern by the dimensions indicated.

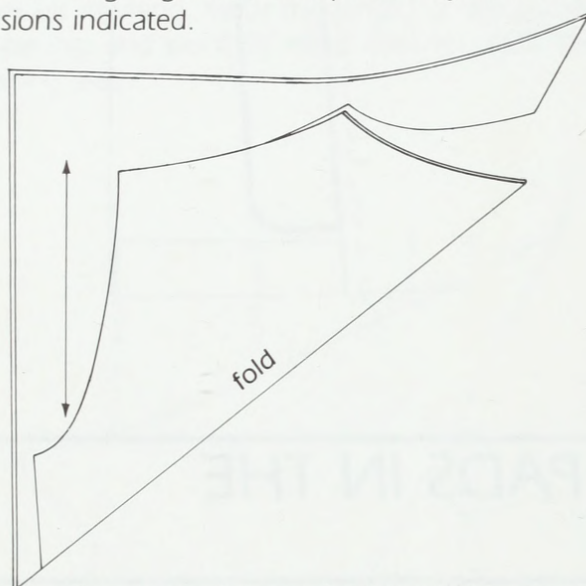

Cut two of these folded pieces, one for each side of the jacket back.

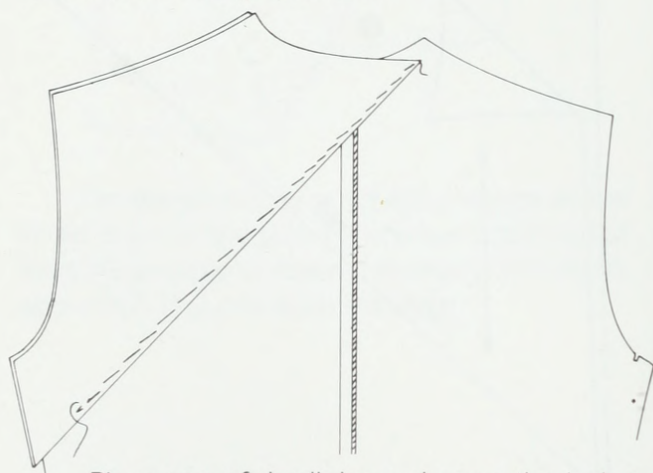

Place one of the lining yokes on the jacket back. The lining should be 1" (2.5 cm) above the jacket at the shoulder, and 1/2" (1.3 cm) beyond the jacket at the side seam.

Baste the lining to the jacket along the diagonal fold.

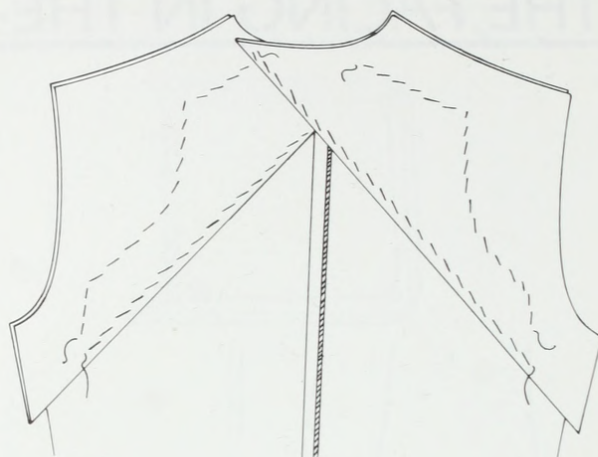

Baste the second lining yoke on the jacket back, using the same placement dimensions as the first.

Above the diagonal fold on each lining yoke, place a second row of basting. These stitches should remain at least 2" (5 cm) below the jacket shoulder edge, and at least 4" (10.2 cm) away from the armhole, to leave room for the shoulder pad.

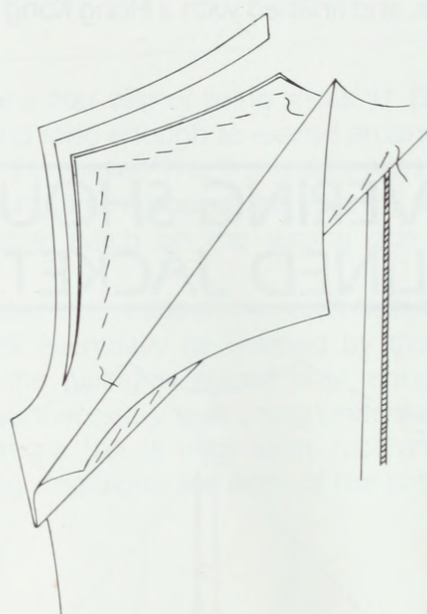

Fold back the top layer of lining, and baste the underlayer to the jacket along the shoulder and armhole, about 1" (2.5 cm) from the edge.

Trim the *underlayer* of lining flush with the jacket at the shoulder and armhole.

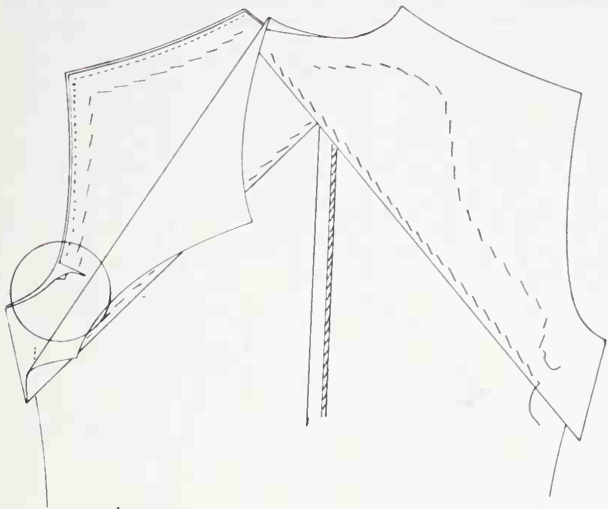

Machine-stitch the underlayer of lining to the jacket along the shoulder and armhole, about $\frac{1}{4}$ " (6 mm) from the edge. Your stitches on the armhole should stop at least 2" (5 cm) above the side seam stitchline.

Cut a $1\frac{1}{2}$ " (3.8 cm) deep slash into the underlayer of lining, just below your stitches in the armhole. This slash will eventually free the lining which is below it from being caught in the armhole seam when the sleeve is set.

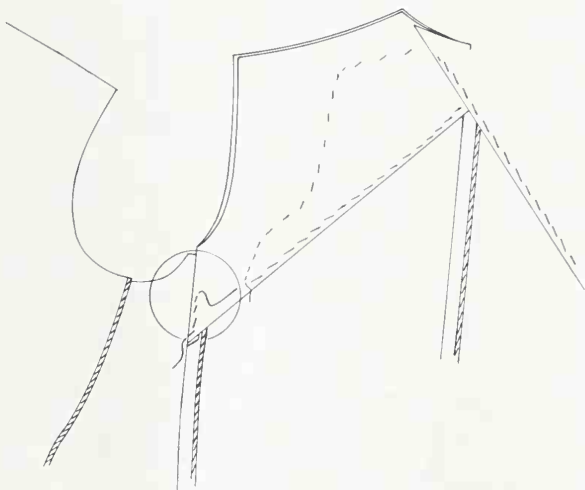

When the back side seams are sewn, the lining is folded and basted to the seam allowance. In the finished jacket, the lining is secured here with a prick stitch.

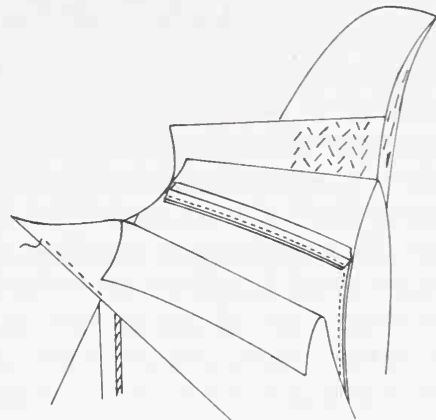

The shoulder pad is attached to the jacket following instructions beginning on page 140. In an unlined jacket, the back of the shoulder pad is placed between the two layers of the lining yoke.

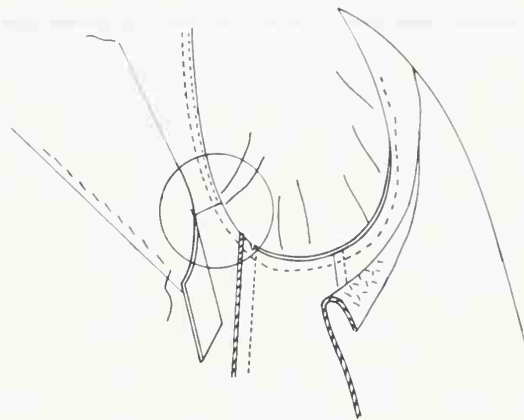

The sleeve is lined and attached to the unlined jacket as it was in the lined jacket (page 170).

The lining yoke above the slash is caught in the armhole seam. The facing and canvas, of course, are not caught in the seam.

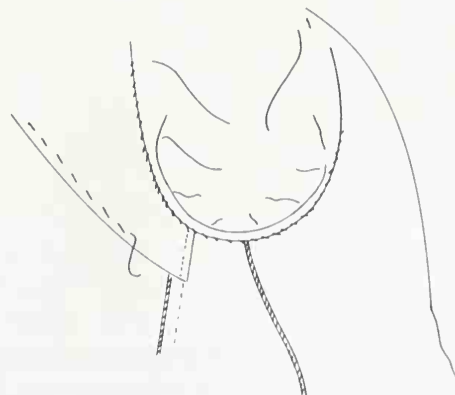

After tacking the armhole (page 174), and attaching the sleeve head (page 176), the sleeve lining is brought up and attached along the armhole. The folded edge of the lining yoke is tacked along the side seam allowance.

THE PEPLUM JACKET

A peplum is a flounce, or short flared attachment at the waist of a garment.

We have chosen to demonstrate a pattern in which the peplum begins at the front princess line, rather than at the center front. This style provides for a continuous grainline down the front of the jacket; places the straight of the grain at the center back of the peplum to prevent stretching from sitting; and places the bias of the peplum at the side seam for best draping over the hip. The shaping in the peplum is created by darts at the side seam and at the back princess line. This peplum jacket will also include:

- Full canvas interlining
- Peplum reinforcement
- Mandarin collar

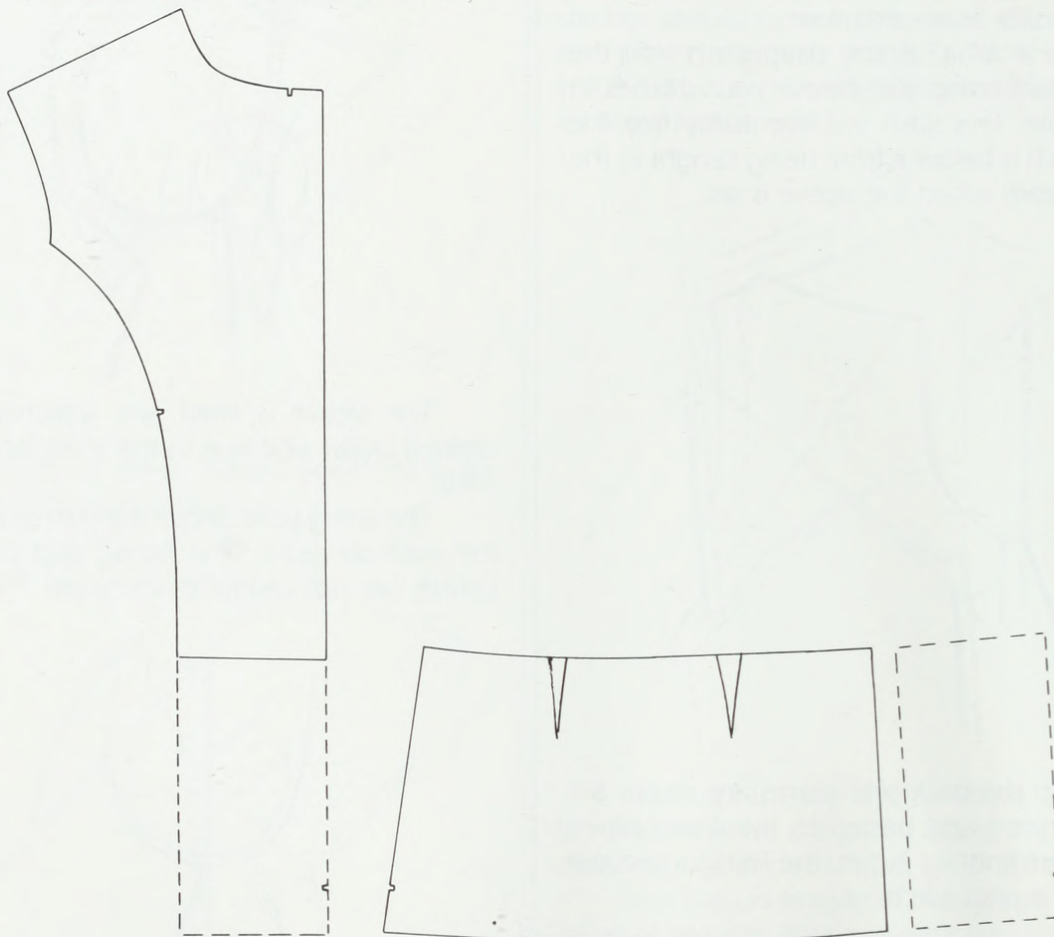
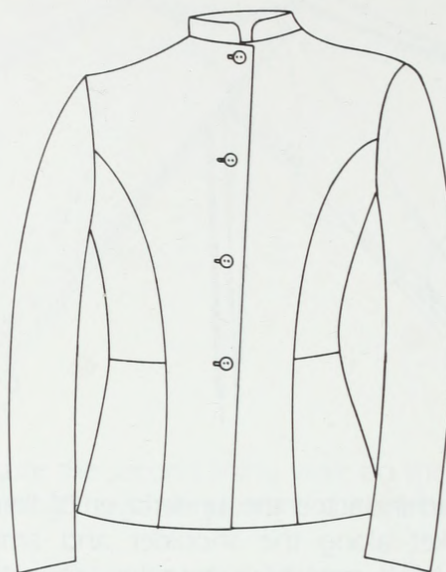

If you would like to create this pattern from one in which the peplum extends to center front, simply:

- Extend your jacket front pattern piece from waist to hem at center front.
- Measure the width of the extension, excluding seam allowances.
- Cut from the peplum pattern piece, center front, an amount equal to this width.
- Place the center back seamline on the fold, straight grain, and cut the peplum.

THE FULL CANVAS INTERLINING



A full canvas interlining is often used to provide uniform body in jackets that are very form fitting. For this purpose a lightweight canvas is used, made of wool, cotton, and hair. Full canvas interlining is also used in coats and heavy jackets to provide extra warmth. If warmth is your aim, use average-weight canvas interfacing.

Using the major pattern pieces for front and back of the jacket, cut the canvas $\frac{3}{8}$ " (1 cm) larger than the pattern all around. Canvas inter-

facing is *not* used in the sleeve. The same grainline is followed for jacket and canvas. Transfer all pattern markings onto the canvas.

Baste each fabric and canvas piece together, beginning at the top, and smoothing the fabric gently downwards. The basting should be about $\frac{1}{4}$ " (6 mm) inside the seam allowance, and above the hem.

Trim the excess canvas at the edge of the fabric.

THE PEPLUM

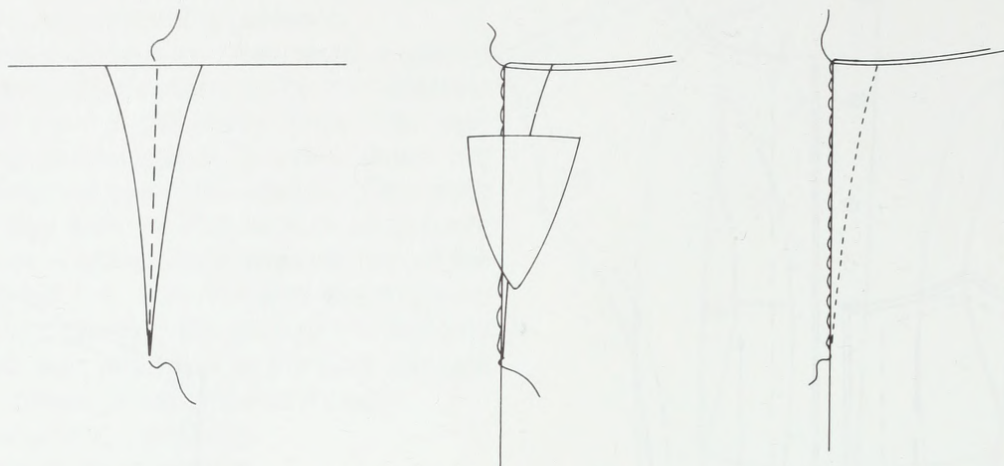

Baste down the center of each peplum dart, in order to control the two layers of fabric while the darts are being sewn.

On the wrong side of the fabric, press a crease along the basted center line of each dart.

Machine-stitch the dart, tapering gracefully at the bottom.

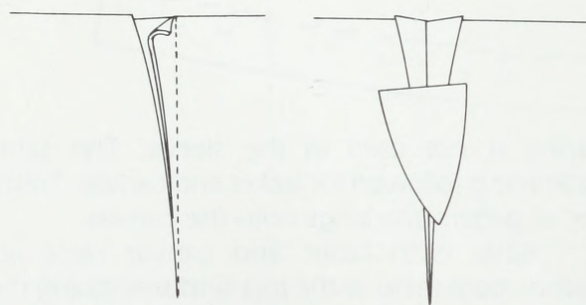

Slash the dart open along the center basted line, and trim the canvas very close to the stitch-line.

Press the darts open.

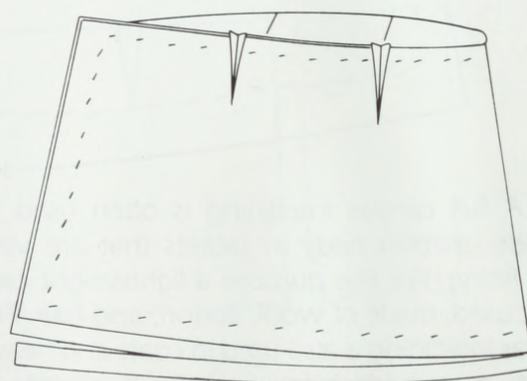

Trim about half of the canvas peplum hem.

THE PEPLUM REINFORCEMENT

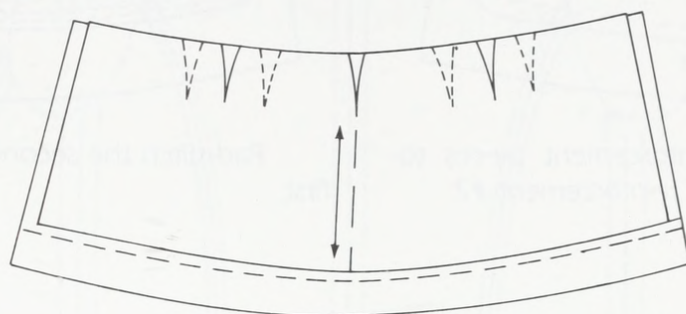

Using the peplum pattern as guide, cut a piece of canvas $\frac{1}{2}$ " (1.3 cm) above the pattern hem foldline, 1" (2.5 cm) shorter than the pattern at the sides, and even with the pattern at the top. This will serve as a canvas reinforcement for the peplum.

Draw three darts on the peplum canvas reinforcement; one at the center back, and one at the center of each side. The side darts on the peplum reinforcement should fall between the darts on the peplum pattern. Draw the darts $\frac{3}{4}$ " (1.9 cm) wide and 3" (7.6 cm) long.

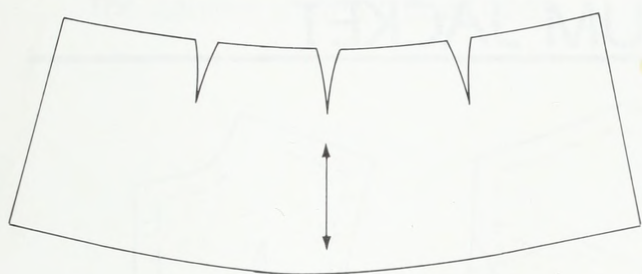

Cut the darts out.

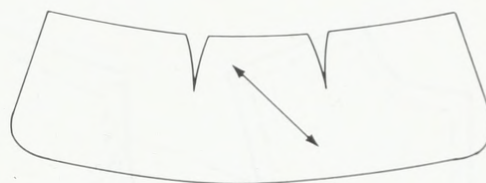

Cut the darts out.

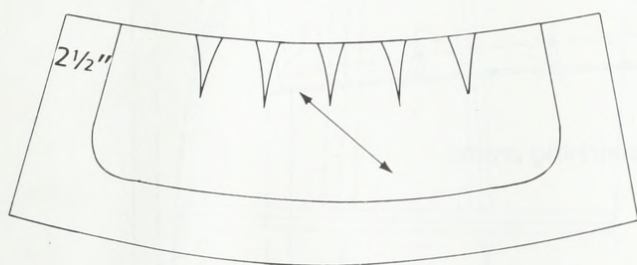

Using the peplum reinforcement as a guide cut a second reinforcement, on the bias this time, $2\frac{1}{2}$ " (6.4 cm) smaller than the first at the bottom and the sides, and even at the top.

Draw two $\frac{3}{4}$ " (1.9 cm) darts on this second canvas reinforcement, evenly placed between the existing darts. The darts are 3" (7.6 cm) long.

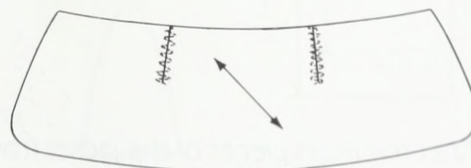
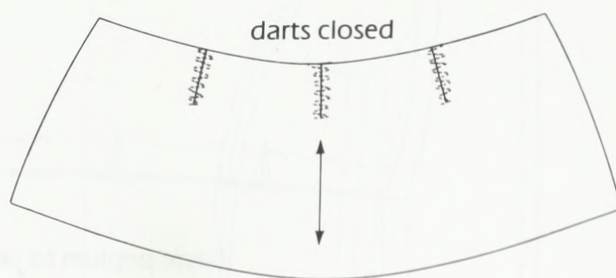

The darts on both the canvas reinforcements are closed by butting the edges together and zigzag stitching across.

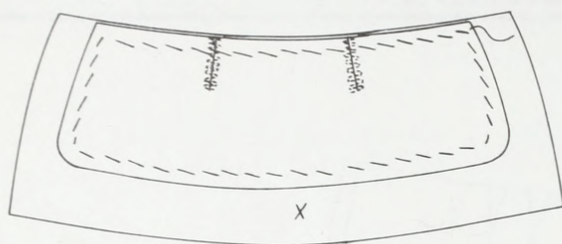

Baste the two reinforcement pieces together along the edge of reinforcement #2.

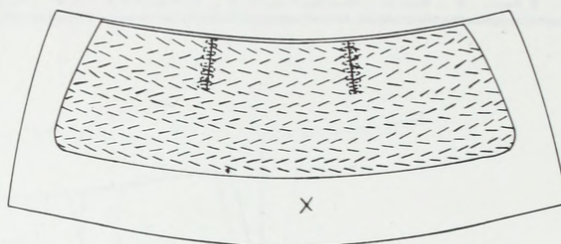

Pad-stitch the second reinforcement to the first.

ASSEMBLING THE PEPLUM JACKET

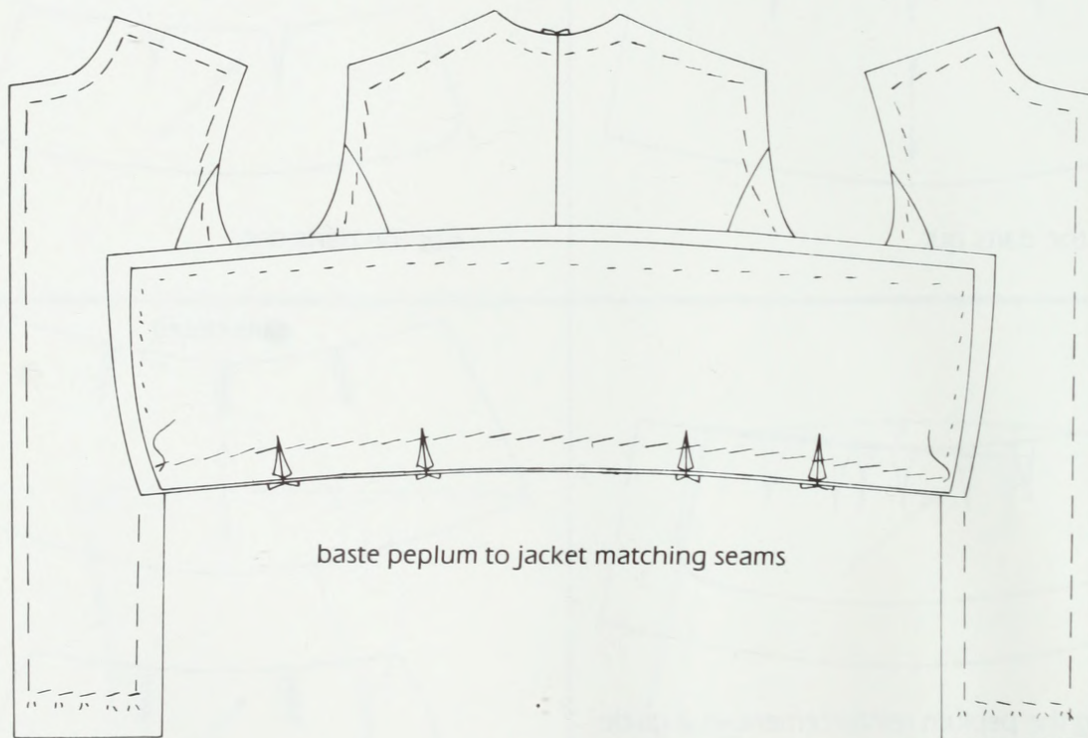

After the main pieces of the jacket front and back have been basted together and machine-stitched, the peplum is stitched to the jacket along the waistline. The darts on the peplum are aligned with the jacket side seam, and the back princess line, respectively.

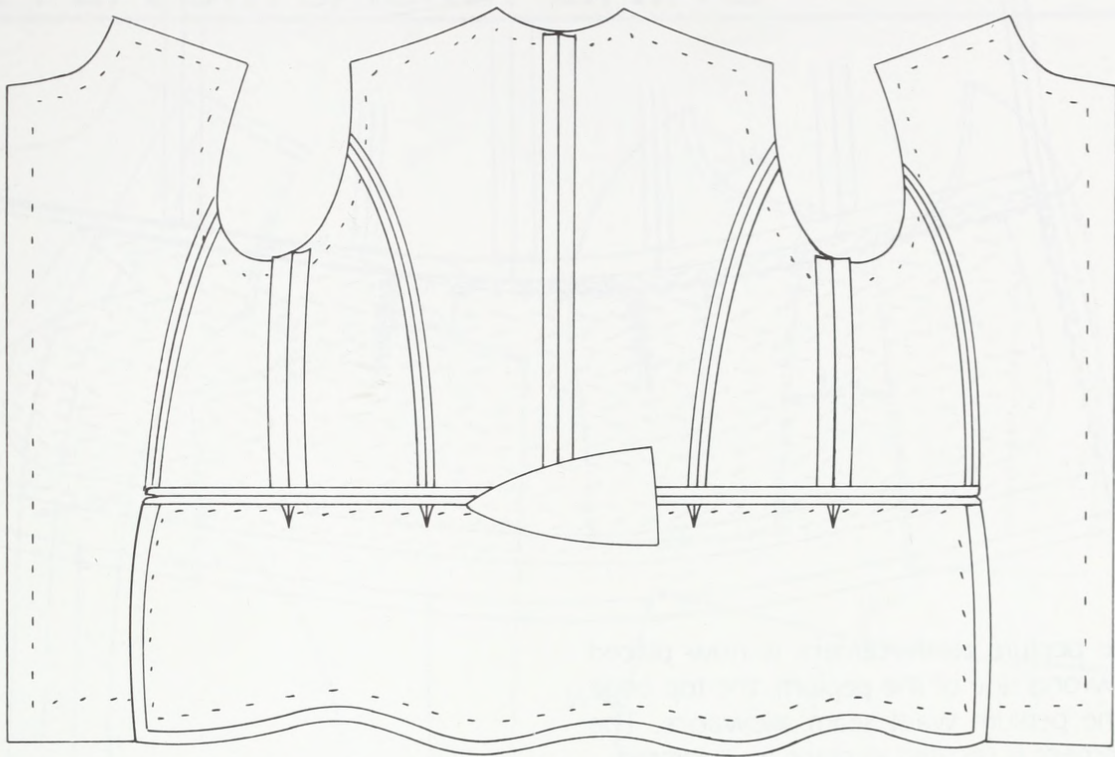

The waistline seam is pressed open.

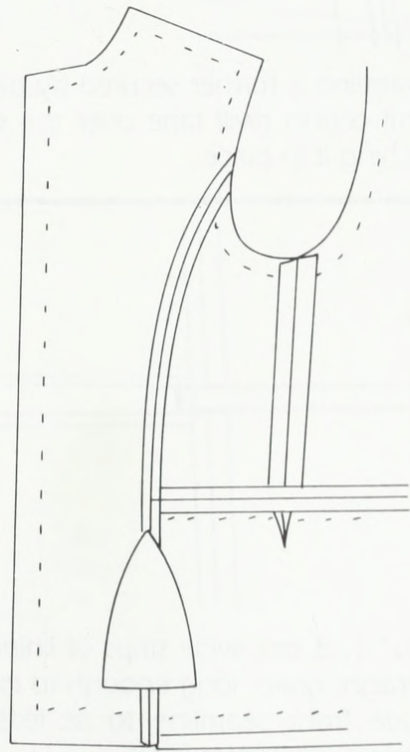
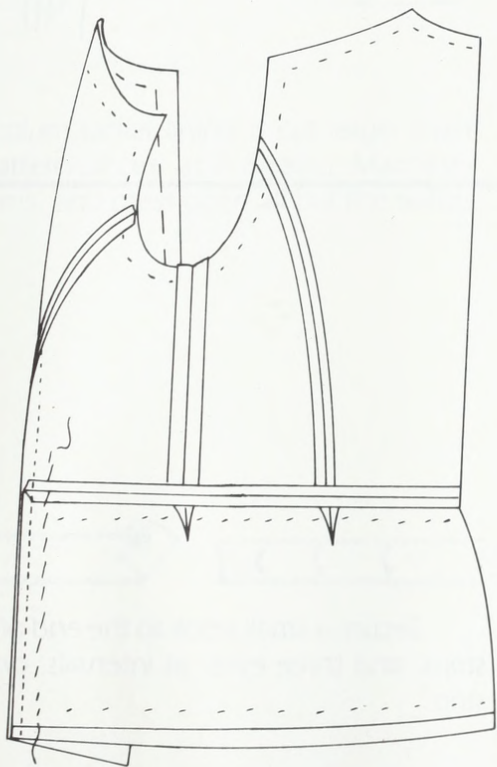

The peplum side seams are then sewn and pressed open.

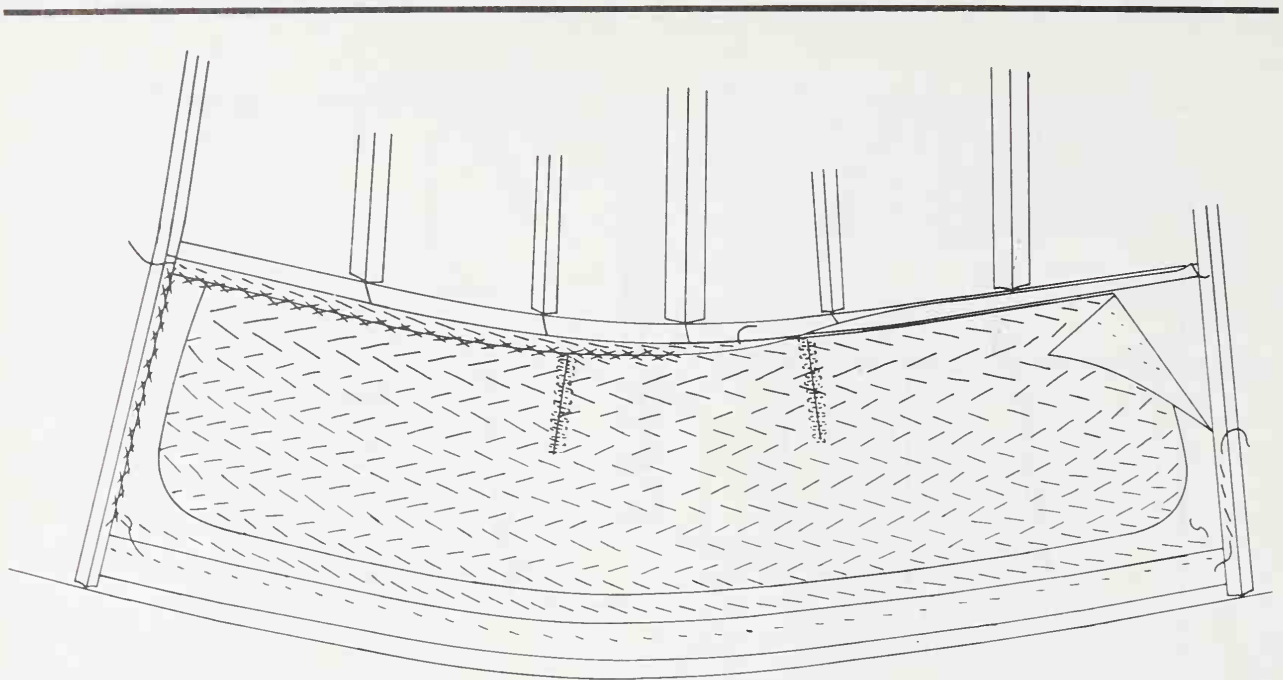

The peplum reinforcement is now placed on the wrong side of the peplum, the top edge under the peplum waist seam allowance. The reinforcement is secured in place as illustrated.

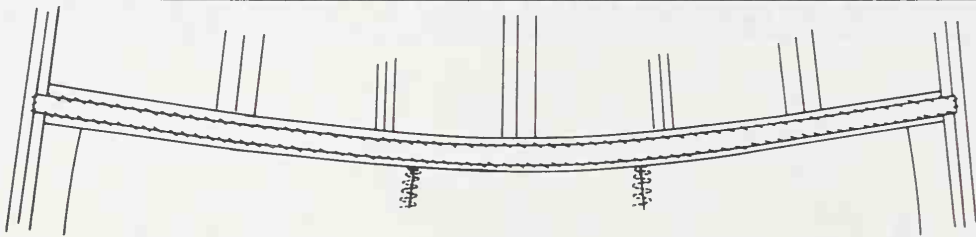

The waistline is further secured by basting $\frac{1}{2}$ " (1.3 cm) cotton twill tape over the seam, and slip-stitching it in place.

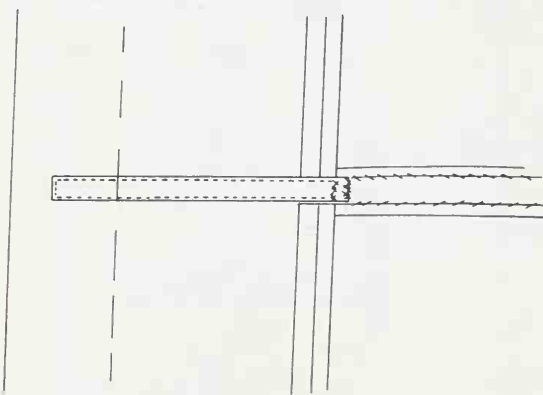

Two $\frac{1}{2}$ " (1.3 cm) wide strips of lining are prepared, straight grain, long enough to extend from the side front seamline to at least 1" (2.5 cm) beyond the center front.

Secure the end of each strip of lining to the tape and seam allowance at the waistline, side front seam.



Secure a small hook to the end of one of the strips, and three eyes, at intervals, on the other strip.

THE PEPLUM JACKET LINING

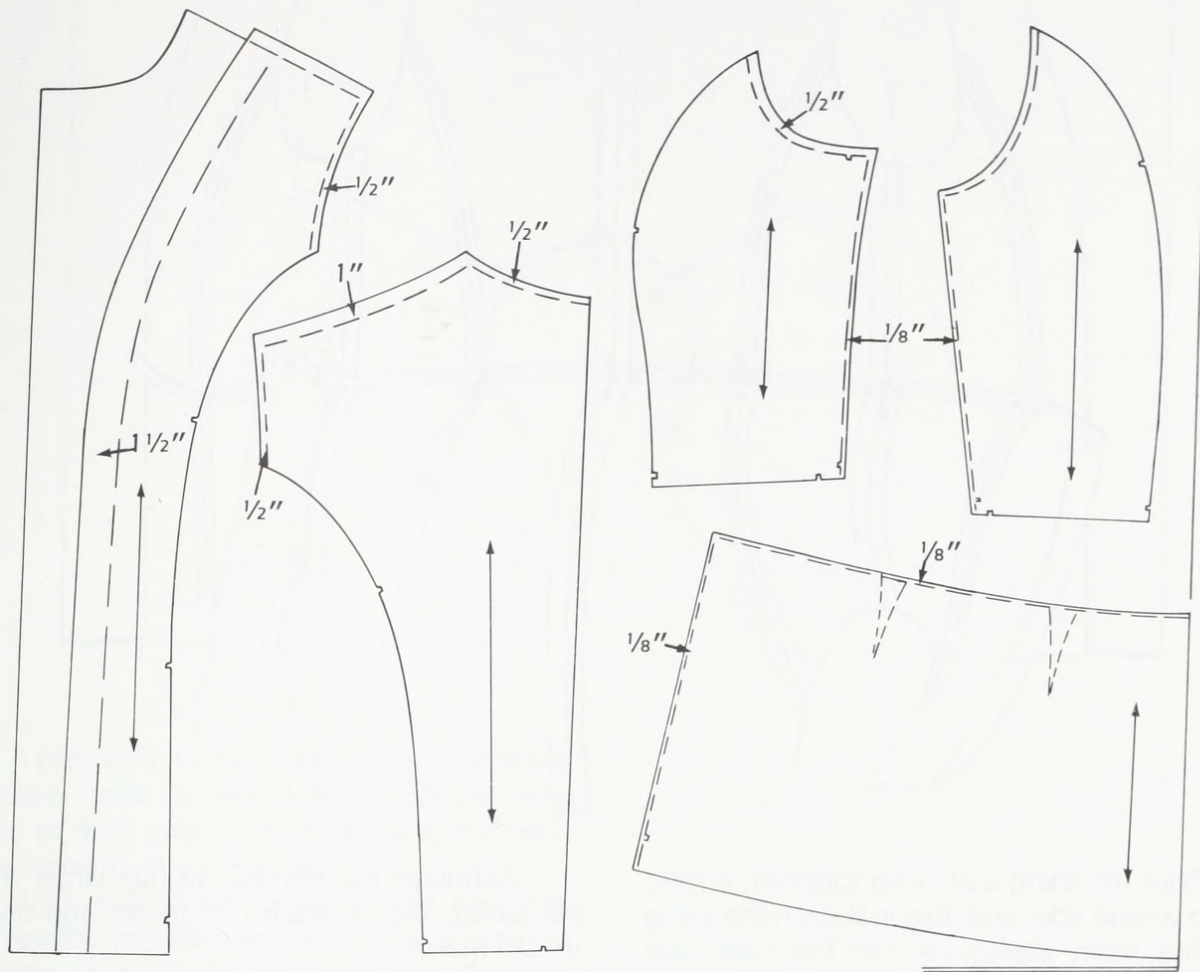

The peplum jacket lining is cut larger than the jacket pattern pieces, as illustrated. Machine-stitch all seams, and press open all but the waistline seam.

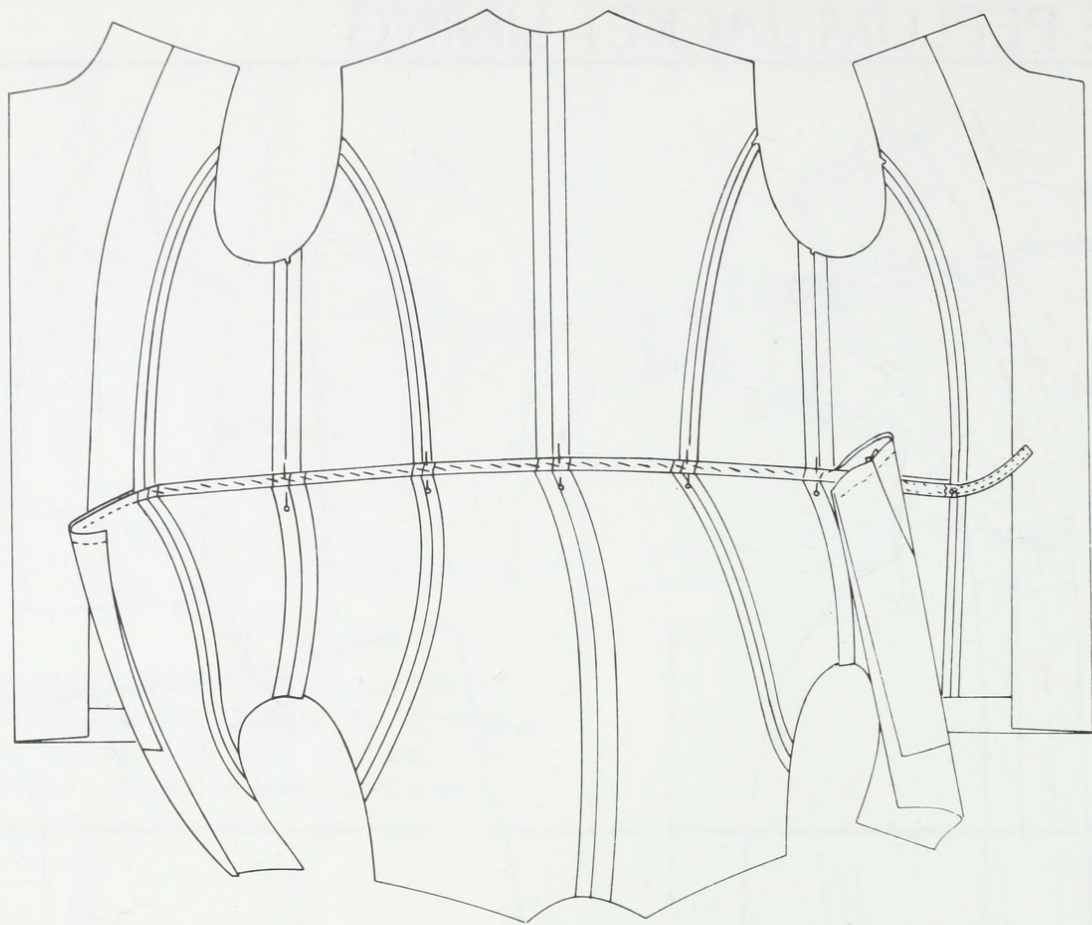

Place the lining and jacket together, wrong side to wrong side, and diagonal-stitch the lining waistline seam allowance into the twill tape which reinforces the jacket waistline.

Although the lining is slightly larger than the jacket, the seamlines of jacket and lining should match.

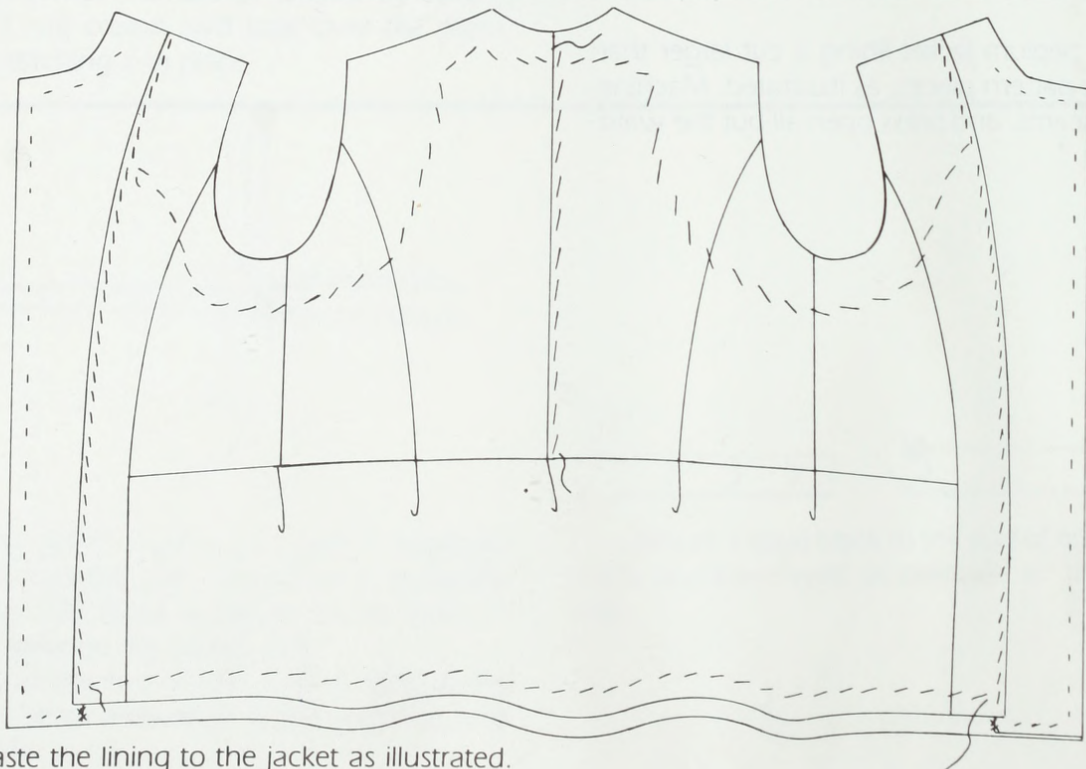

Baste the lining to the jacket as illustrated.

THE MANDARIN COLLAR

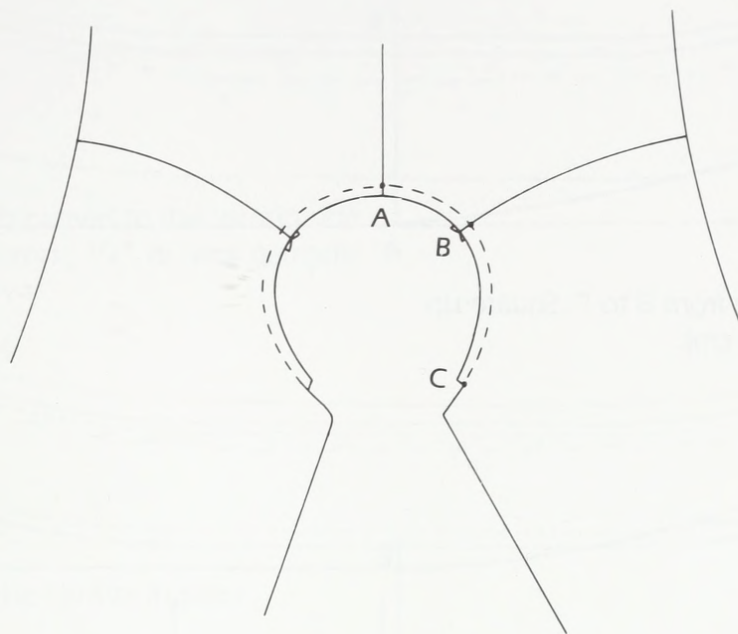

A precise fit is essential to the beauty of the mandarin collar. It would be wise, and very simple to draft your own collar using the neck measurements of your jacket.

With your jacket folded so that the neck area lies flat, measure from center back seam to shoulder seam (A-B) and from the shoulder seam to the collar notch (B-C).

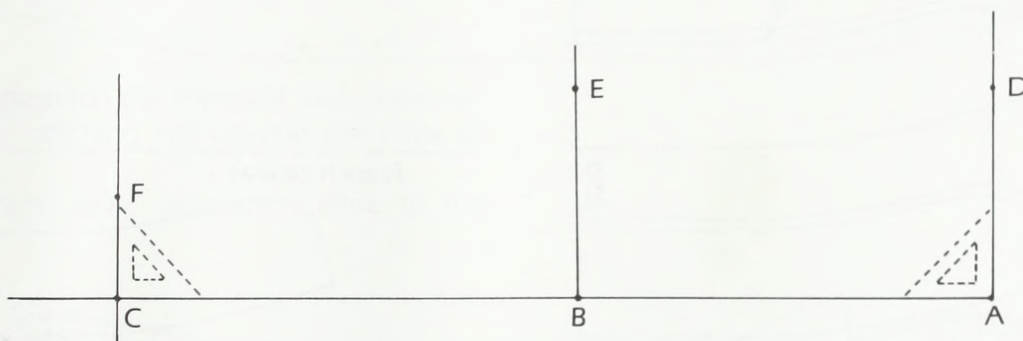

Draw a straight line A-B-C using the neck-line measurements. Square a line up from A $1\frac{3}{4}$ " (4.5 cm), and label point D.

Square a line up from B $1\frac{3}{4}$ " (4.5 cm), and label point E.

Square a line up from C $\frac{3}{4}$ " (1.9 cm), and label point F.

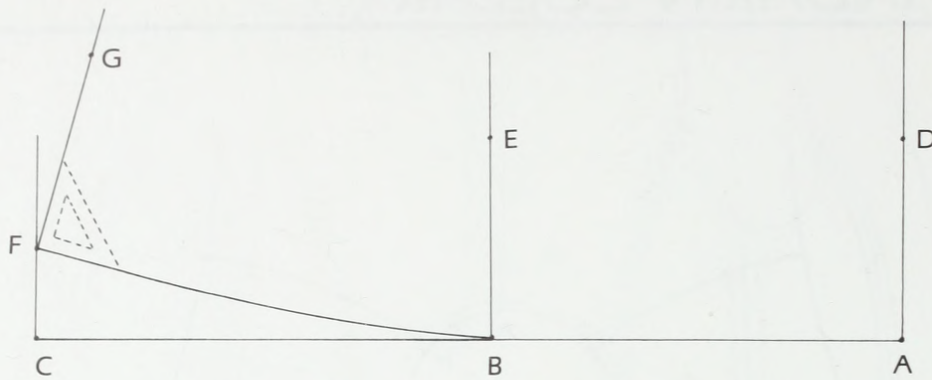

Draw a curved line from B to F. Square up from F to G, $1\frac{3}{4}$ " (4.5 cm).

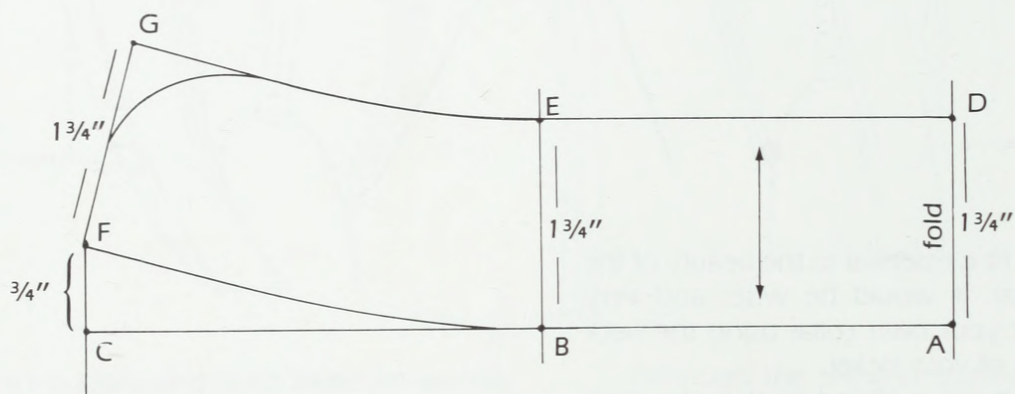

Draw line G-E parallel to line F-B and round off the corner at G. Connect E-D with a straight line.

The pattern is complete.

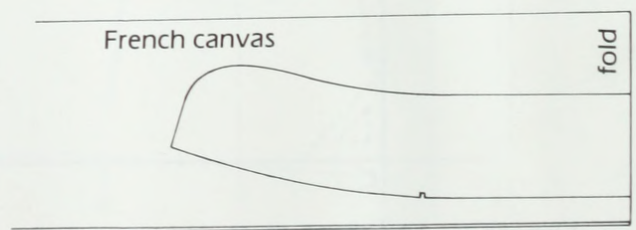
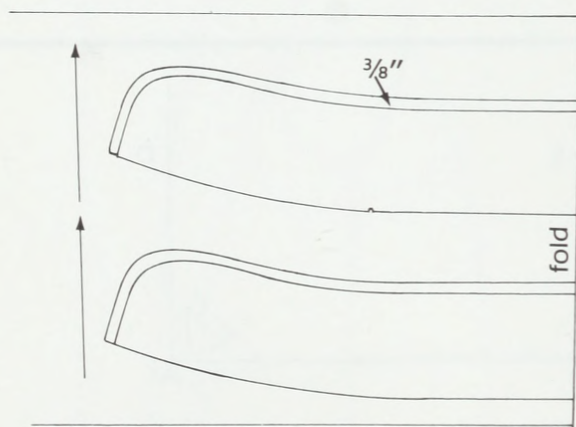

Using your collar pattern, draw two collars on the wrong side of your garment fabric, straight grain. Since the collar pattern we have created includes seam allowance only at the neck edge, draw a $\frac{3}{8}$ " (1 cm) seam allowance along the top and front edge of both collars.

Cut one collar from French canvas—no additional seam allowance is necessary here.

CONSTRUCTING THE MANDARIN COLLAR

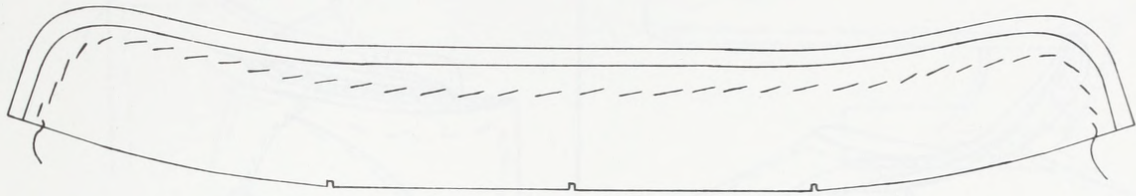

Baste the French canvas to the wrong side of the undercollar, leaving $\frac{1}{4}$ " (6 mm) garment fabric above the canvas.

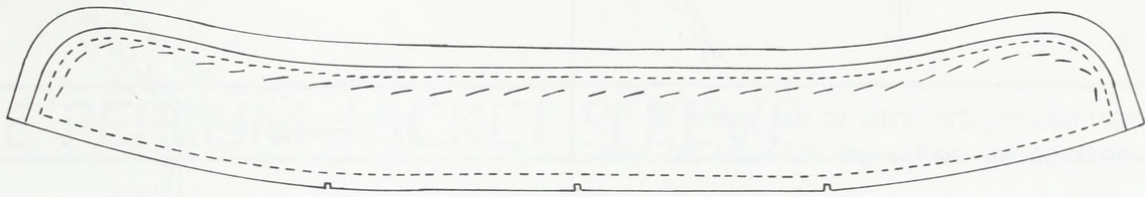

Machine-stitch the canvas in place.

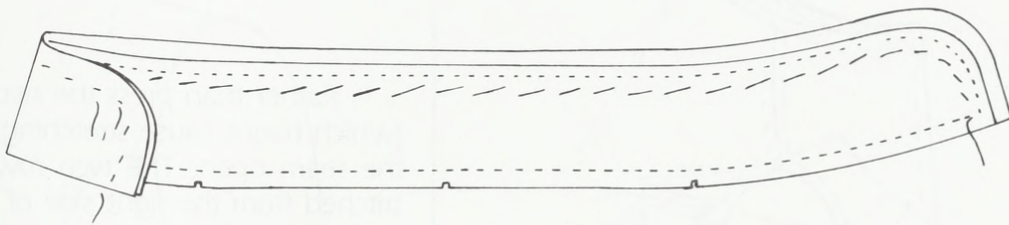

Baste the undercollar and topcollar together, placing a small amount of ease at the center front topcollar.

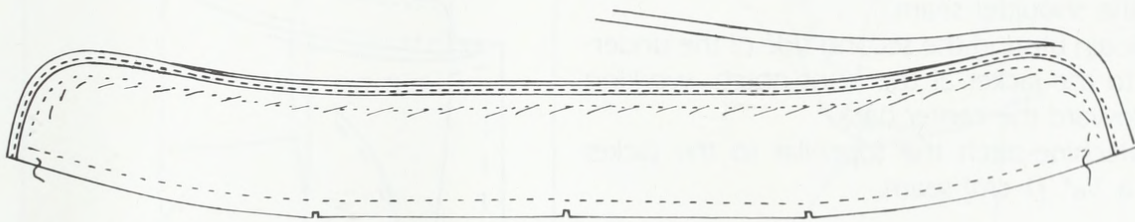

Machine-stitch the topcollar and undercollar together, stitching just beyond the edge of the canvas.

Trim both seam allowances close to the stitchline.

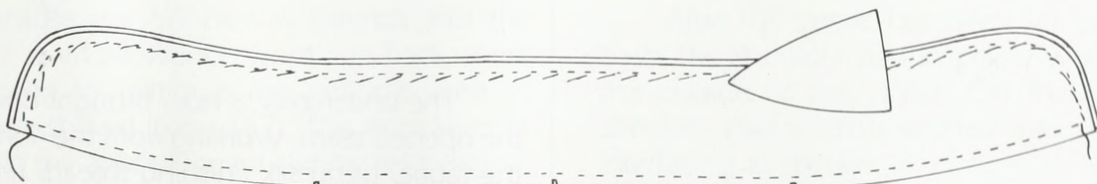

Turn the collar to the right side and baste along the top and sides, bringing the seamline to the undercollar side. Press.

ATTACHING THE MANDARIN COLLAR

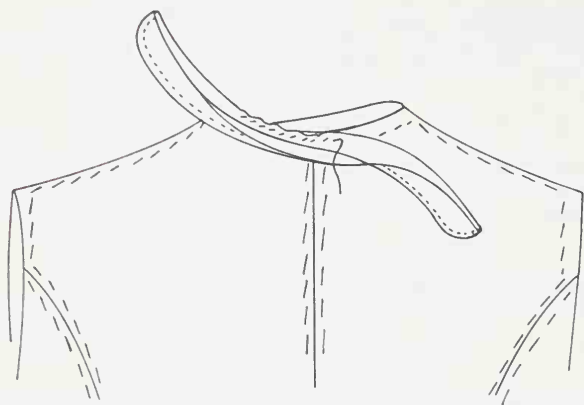

Begin basting the collar to the jacket at the center back seam, and work forward on one side.

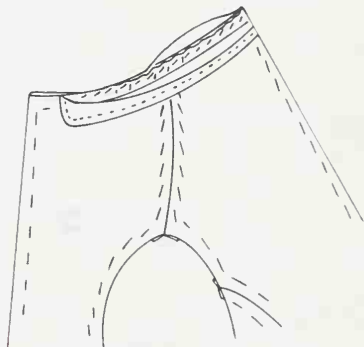

Place a slight amount of ease in the top collar at the shoulder seam.

Begin basting the second side of the undercollar to the jacket at the front notch, working back toward the center back.

Machine-stitch the top collar to the jacket using a $\frac{3}{8}$ " (1 cm) seam.

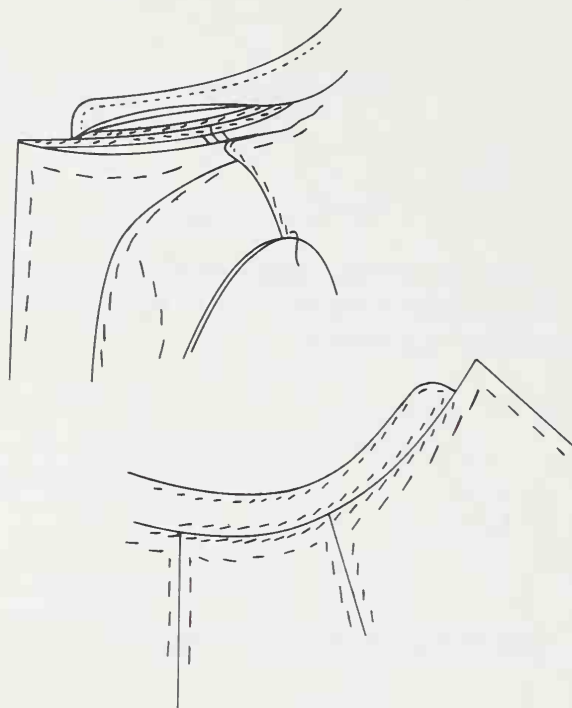

Rather than press the neckline seam open (which might cause stretching), we now baste the seam open. The two rows of basting are stitched from the right side of the fabric, while the seam allowance is held open from underneath.

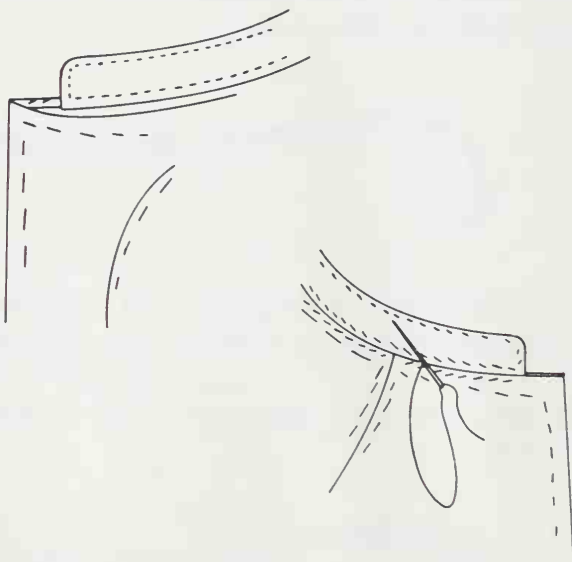

The undercollar is now brought down over the opened seam. Working from the right side of the fabric, using silk finishing thread, tiny backstitches are taken in the neckline seamline. The undercollar fabric is caught in place on the other side. These stitches should be in the seamline, and completely imperceptible.

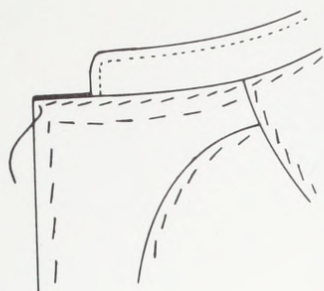

The facing and lining are folded up over the raw edge of the undercollar, and basted in place.

Slip-stitch along the top edge of the facing and lining.

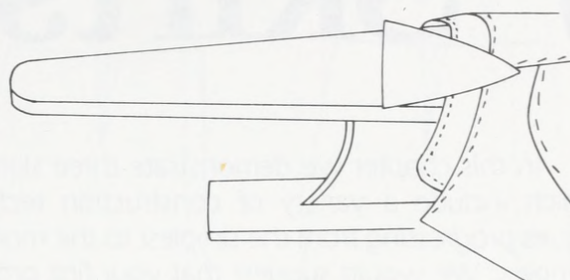

Press carefully maintaining the shape.

THE PEPLUM JACKET SLEEVE

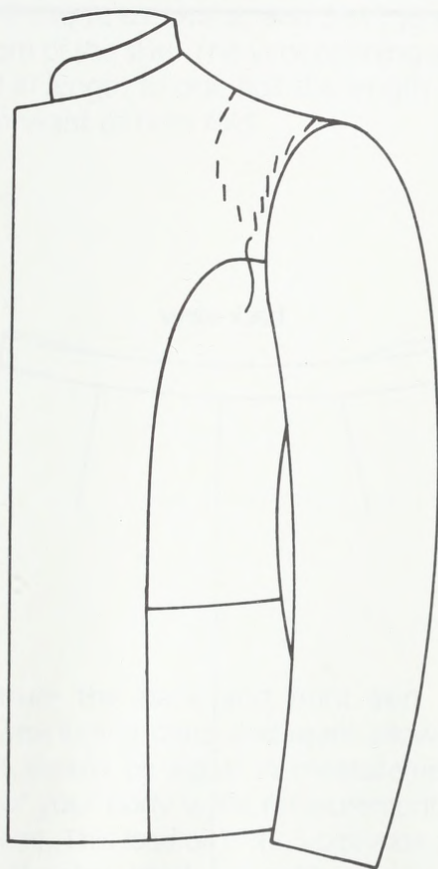

Because the full canvas extends into the armhole seam allowance, front and back, there is no need to reinforce the armhole area as previously shown (page 162). This extra layer of canvas in the armhole seam also makes it advisable to set the sleeve *before* attaching the shoulder pad. This reversal of procedure whenever a full canvas is used ensures better control of the armhole.

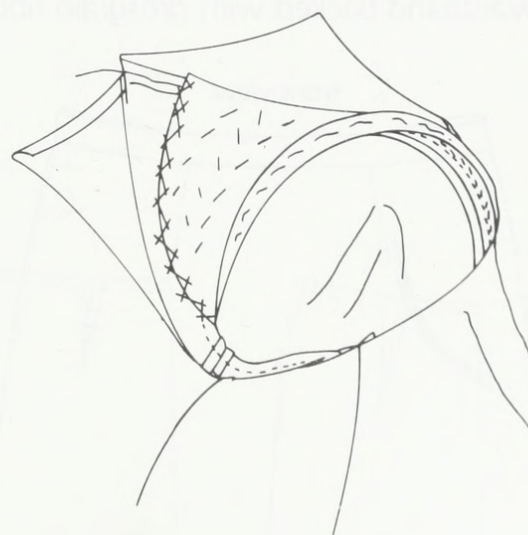

After the sleeve has been set (page 173), baste the shoulder pad in place, working from the outside of the jacket. On the inside, the shoulder pad is cross-stitched into the canvas interfacing as shown.

The shoulder pad, the lining, and the canvas are then tacked into the armhole seam allowance following the instructions on page 174.

7 Skirts

In this chapter we demonstrate three skirts which include a variety of construction techniques progressing from the simplest to the more complex. We would suggest that your first project be a *basic straight skirt*. Once you have accomplished this, the variations in style and in construction that we suggest should present no more than a minor challenge.

1. BASIC STRAIGHT SKIRT

- Curved double-piping pocket on front
- Side zipper closing
- Hong Kong piping hem finish
- Overlap vent at center back
- Waistband backed with grosgrain ribbon

front view

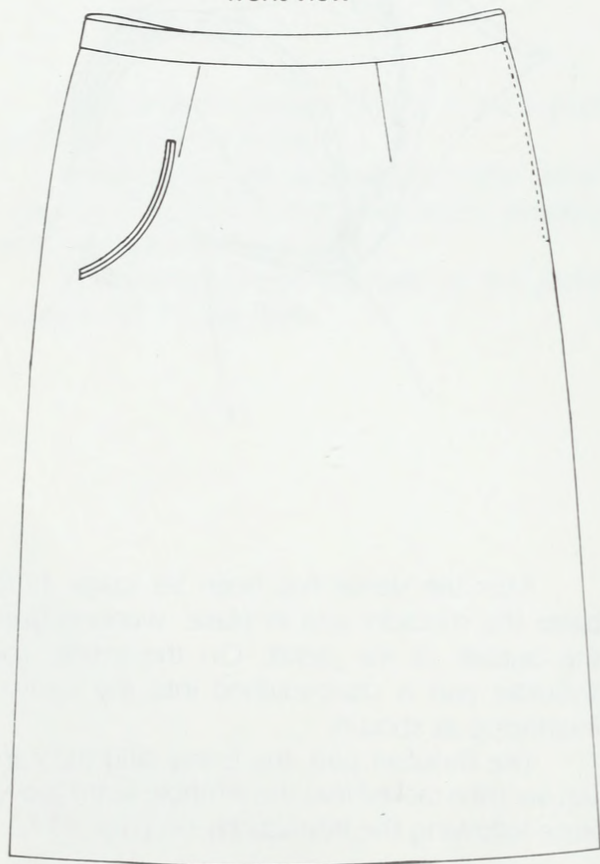

back view



Use your basic straight skirt pattern to cut this skirt, but check the following.

If your pattern has no center back vent, or one which appears in an "L" shape, as in the figure on the left, adjust your pattern. The vent will hang better if the fabric extends up to the waist where it can be secured into the waistline seam.

Adjust your pattern so that the vent allowance extends out from the center back seam $1\frac{1}{2}$ " (3.8 cm) at the waist, and $3\frac{1}{4}$ " (8 cm) at the bottom of the skirt. The vent opening should be equal in length to one half the length of the skirt from waist to hem fold.

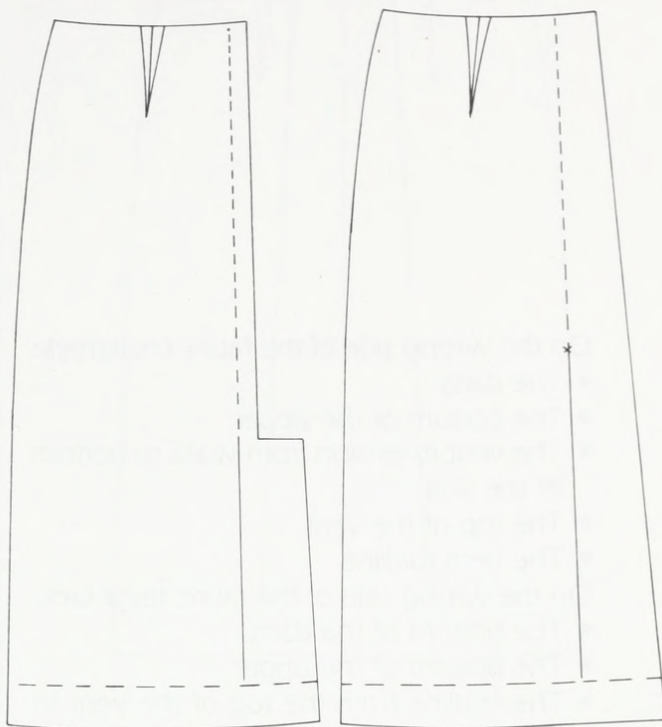

Measure the back and front skirt waist seamline, excluding darts and seam allowance. Each half should be equal in measurement to one half of your body waist measurement, plus $\frac{1}{2}$ " (1.3 cm). This total of 1" (2.5 cm) ease at the waistline of a skirt which has neither shirring nor open pleats, is necessary for a graceful fall of the fabric directly below the waistband.

If your pattern does not include this ease, add $\frac{1}{4}$ " (6 mm) to the waist at the side seam of the skirt back and front. Use a hip curve to taper the $\frac{1}{4}$ " (6 mm) to nothing at the hipline.

Use the layout and cutting instructions in Chapter 5 to cut the front and back of the skirt. *Do not* cut the waistband at this time.

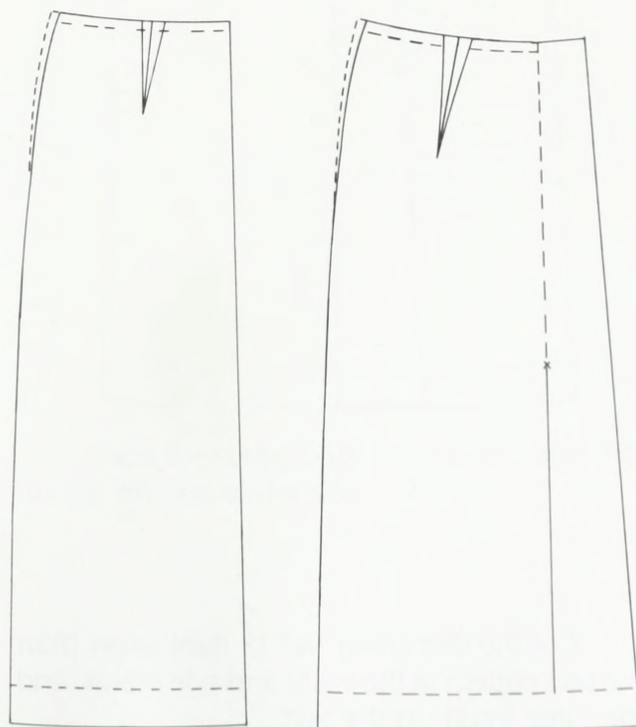

On the wrong side of the fabric chalkmark:

- The darts
- The bottom of the zipper
- The vent extension from waist to bottom of the skirt
- The top of the vent
- The hem foldline

On the wrong side of the fabric tailor tack:

- The bottom of the darts
- The bottom of the zipper
- The foldline from the top of the vent to the hem
- The hem foldline

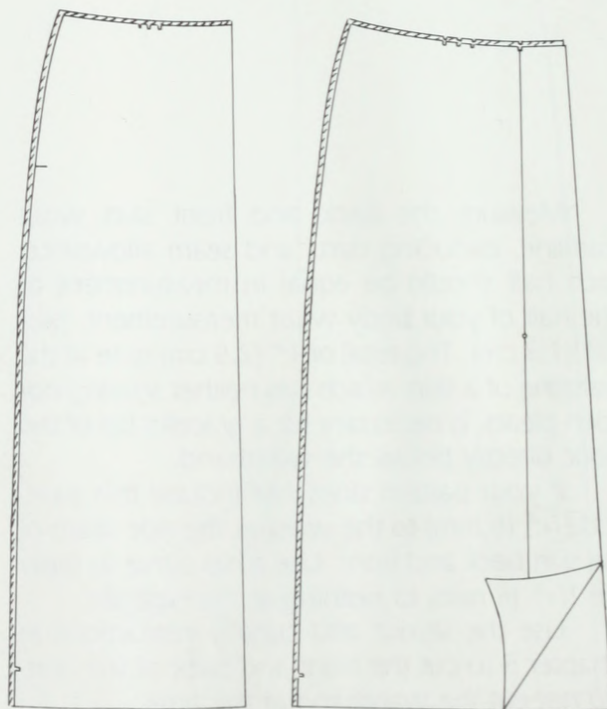
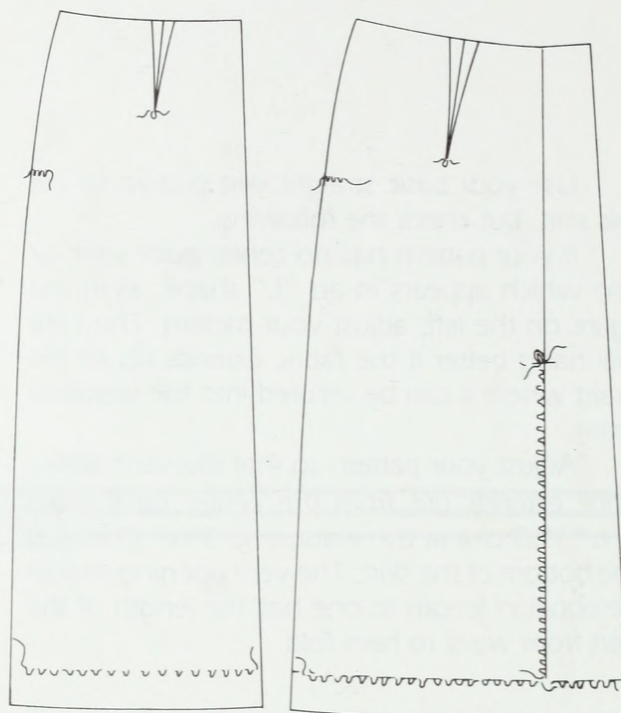

Cut the skirt lining $\frac{1}{8}$ " (3 mm) larger than the skirt pattern at the waist and side seams, and the same length as the skirt.

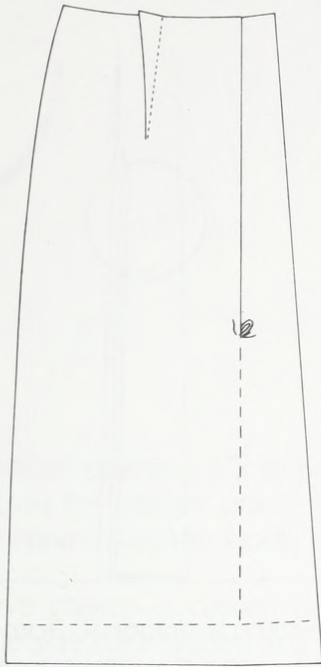

Prepare the front and back waistline darts as per instructions on page 77, and press the darts toward the side seams.

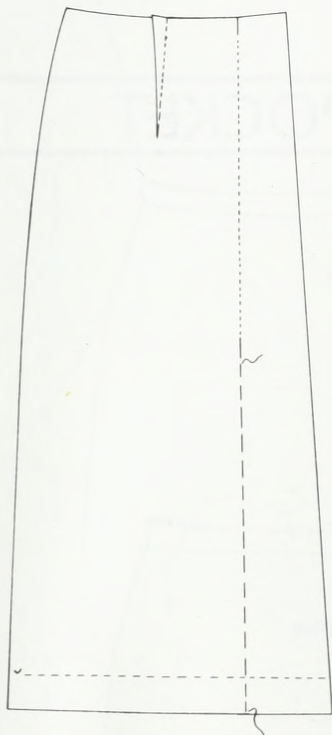
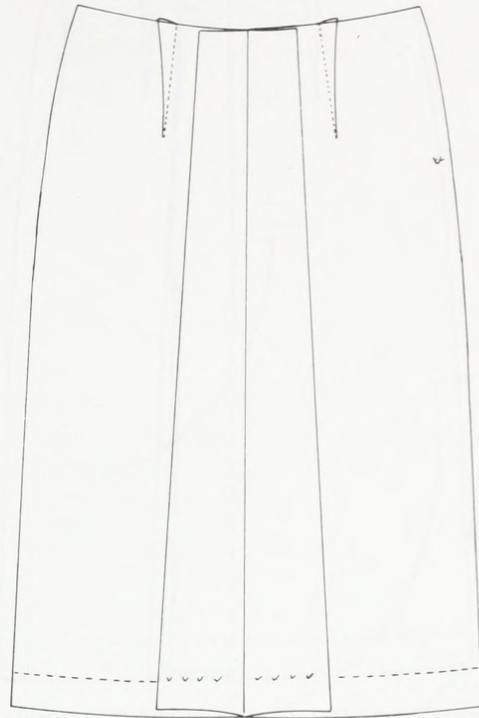

Baste the center back seam from the waist to the bottom of the skirt. Machine-stitch the center back seam from the waist to the top of the vent, tacking well at the top of the vent. Leave the basting stitches in the vent opening for the moment.

Machine-stitch the center back seam of the skirt lining in the same manner as the skirt back.

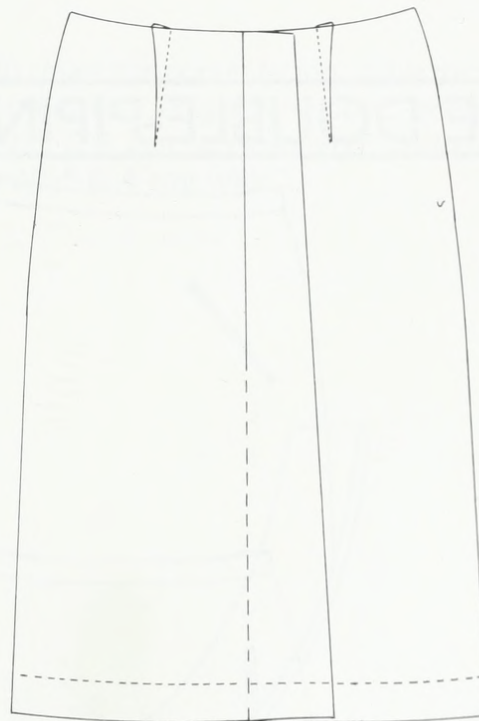

Press the center back seam open, and then to the left side of the skirt.

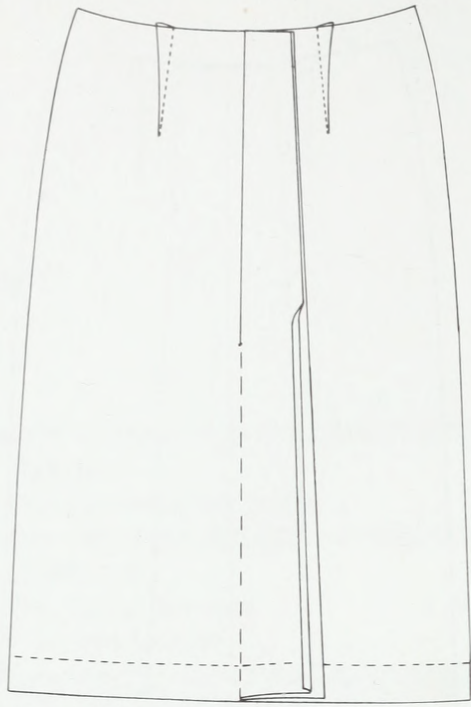

Press back $\frac{3}{8}$ " (1 cm) along the edge of the top layer of the vent, tapering to nothing just above the top of the vent.

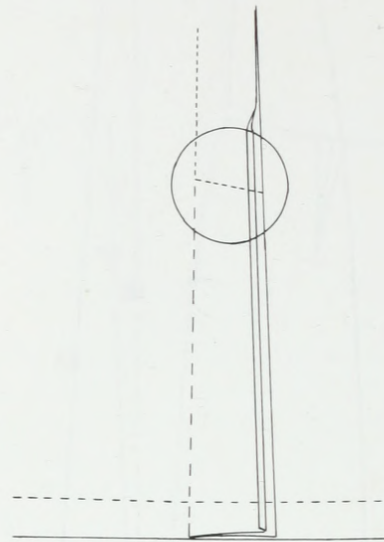

Machine-stitch a diagonal, from the top of the vent down, across the vent extension. Catch only the two layers of the vent in this stitchline, and not the outside of the fabric.

We'll leave the back of the skirt for the moment and move on to the front pocket.

THE DOUBLE-PIPING SKIRT POCKET

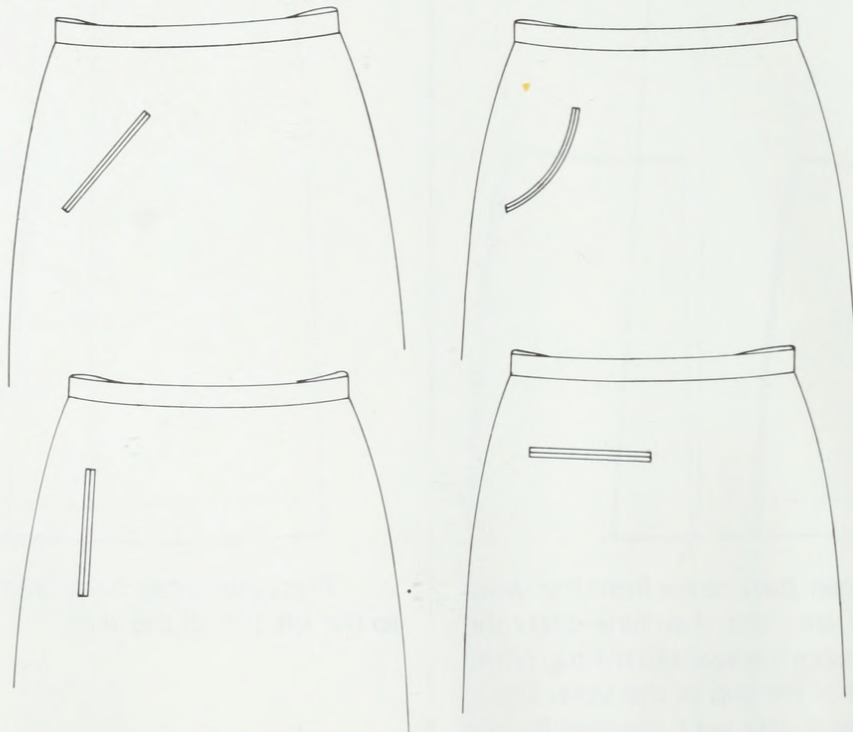

The double-piping pocket may be designed as a straight or a curved line, and placed according to your preference on the skirt front or back.

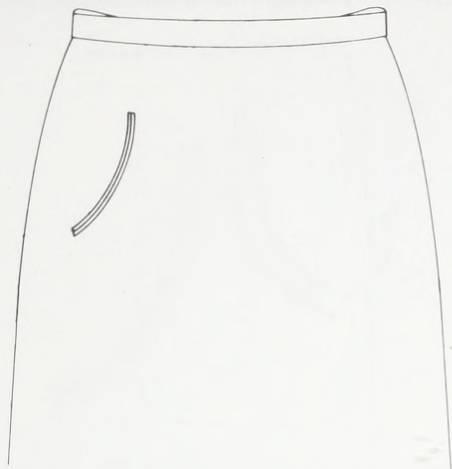

If the pocket opening is a straight line, the piping is cut on the straight grain. If the pocket opening is a curved line, the piping is cut on the bias.

We have chosen a curved double-piping pocket for the skirt front, placed at a comfortable level just below the waistline. The end of the curve should be kept at least 2" (5 cm) away from the side seam, so that it will not interfere in possible future alterations.

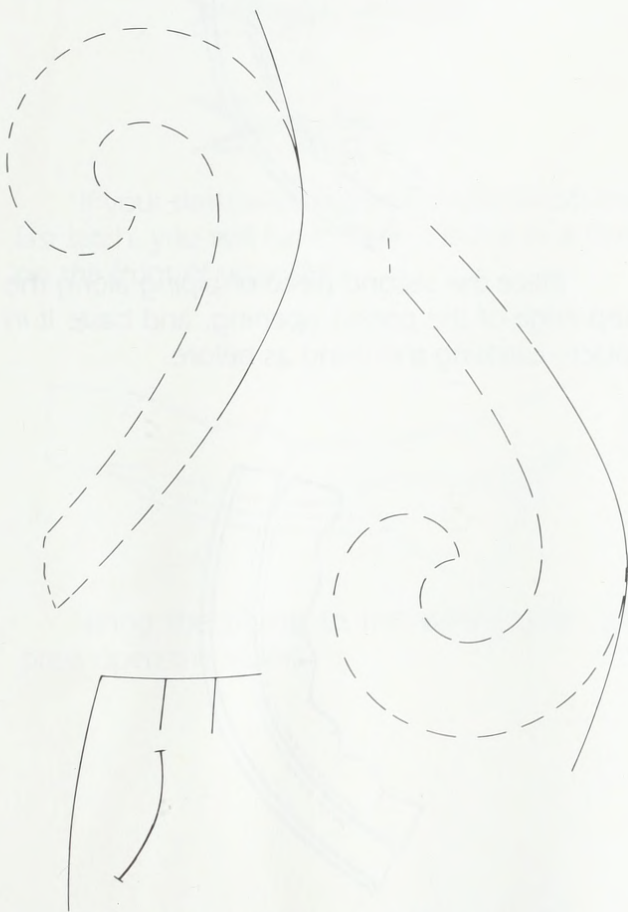

Using a French curve ruler, and tailors' chalk, draw the pocket opening line on your skirt front, about 6" (15.2 cm) in length.

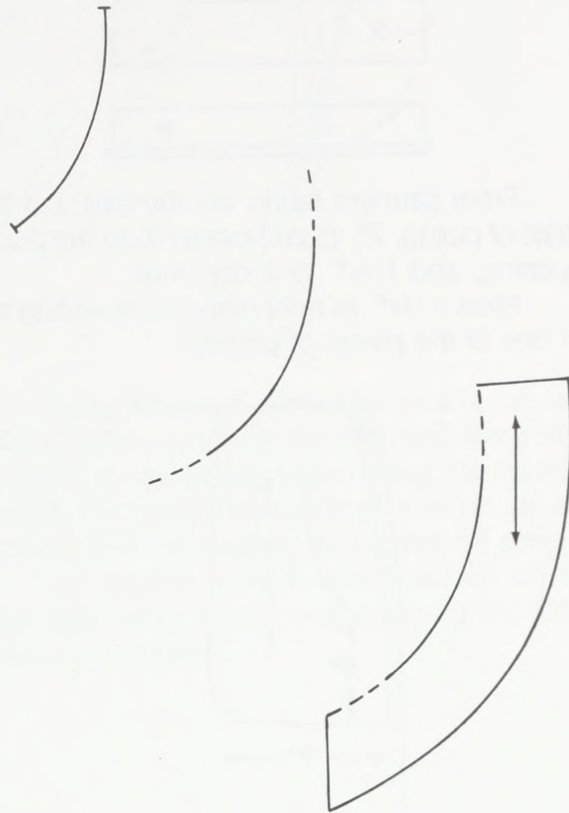

To create the pocket facing, draw the same curve on a piece of garment fabric; extend the line 1 1/2" (3.8 cm) at either end; and cut the facing 2 1/2" (6.4 cm) wide.



Press a 1/4" (6 mm) hem to the wrong side of the facing along the outside curve. If you are working with a heavyweight fabric, it would be better to overcast this outer edge instead of folding it in order to avoid bulk.

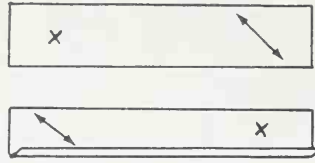

From garment fabric, on the bias, cut two strips of piping, 2" (5 cm) longer than the pocket opening, and 1 1/4" (3.2 cm) wide.

Press a 1/4" (6 mm) hem to the wrong side of one of the pieces of piping.

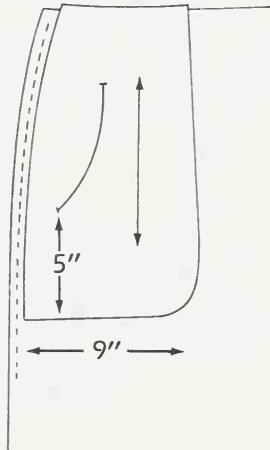

Cut two pieces of lining to be used as pocketing, 9" (22.9 cm) wide and long enough to extend from 3/8" (1 cm) above the top of the skirt, to 5" (12.7 cm) below the lowest point on the pocket opening line.

The side of the pocketing is trimmed to the curve of the skirt side seam.

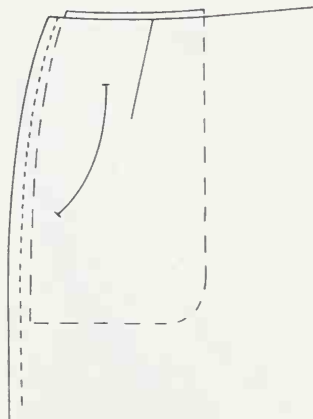

Place one piece of pocketing under the skirt front so that it extends above the top of the skirt by 3/8" (1 cm), and out beyond the lowest point on the pocket opening line by 1 1/2" (3.8 cm).

Placed in this manner, there will remain about 1/2" (1.3 cm) distance between the skirt side seam stitchline and edge of the pocketing.

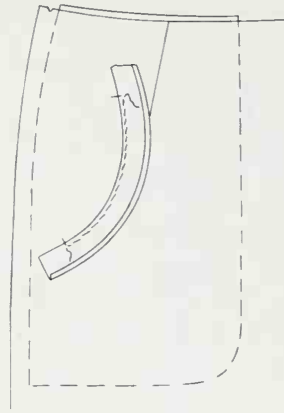

The piping which has the folded edge is now basted just below the pocket opening, the top edge of the piping flush with the chalkline. The lining is caught in these basting stitches.

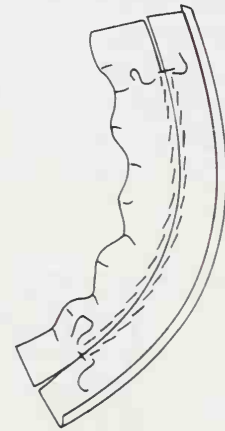

Place the second piece of piping along the top edge of the pocket opening, and baste it in place, catching the lining as before.



Machine-stitch the piping to the skirt 1/4" (6 mm) above and below the pocket opening line, tacking well at either end of the rows of stitching.

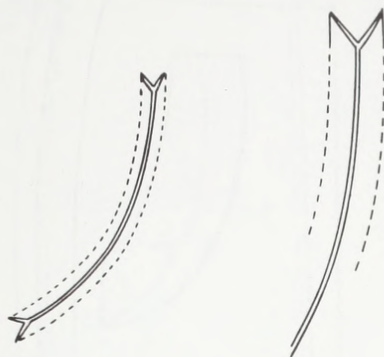

Working from the wrong side of the skirt, slash through the skirt and the pocketing fabric, down the center of the two rows of stitching. Hold the piping out of the way so that it is not slashed inadvertently.

At $\frac{3}{8}$ " (1 cm) from either end of the opening, cut prongs that extend directly to the last secure stitch in each row of stitching.

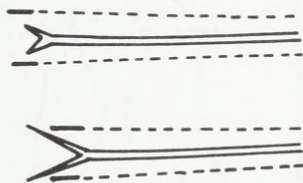

If your slash overshoots or undershoots this last stitch, you will have either a bulge or a hole on the front of your skirt.

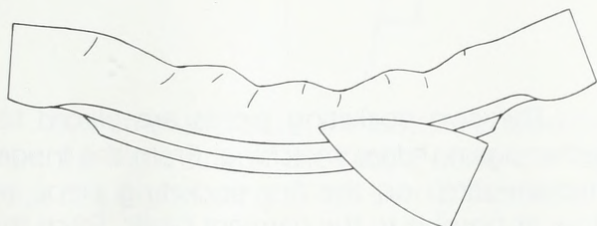

Bring the piping to the wrong side, and press open the seams.



Using the seam allowance as a guide, and ignoring the prongs for the moment, back-stitch by hand in the piping seam, using silk finishing thread. The piping must be kept even on top and bottom, and the stitches should not be seen.

The pocket is now steam-pressed on the right side using a ham and covering the fabric with a presscloth.

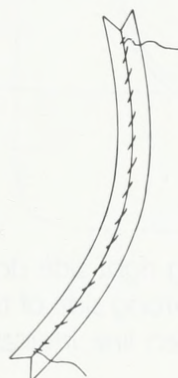

Whip-stitch the piping closed so that it will not shift while we attend to the prongs.

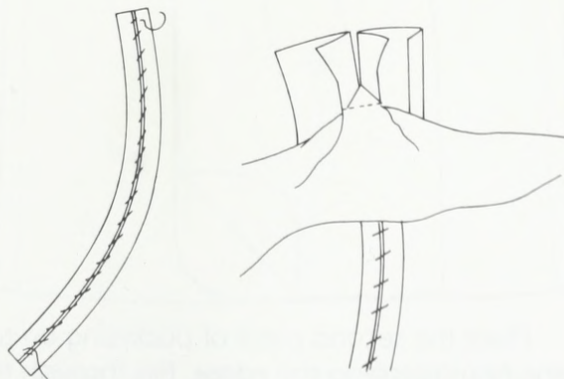

Tuck each prong to the inside, and hold it so that the end of the pocket is a straight line. By hand back-stitch the prong to the piping.

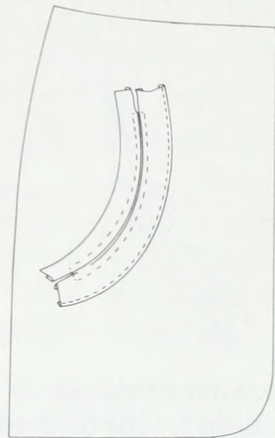

On the inside, machine-stitch the folded edge of the bottom piping to the pocketing.

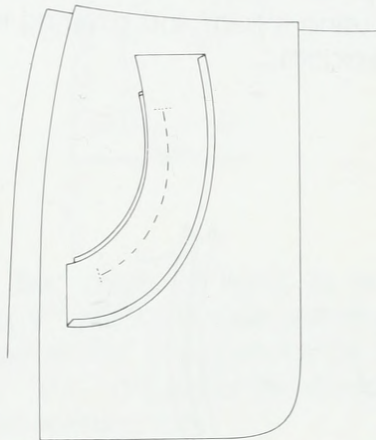

Place the facing right side down on top of the piping, on the wrong side of the skirt. In this illustration, the broken line indicates the pocket opening line.

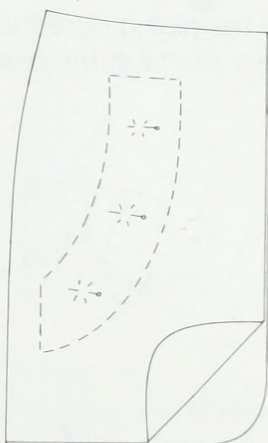

Place the second piece of pocketing on top of the first, matching the edges. Pin through the second piece of pocketing and catch the facing. The broken line in this illustration indicates the position of the facing under the pocketing.

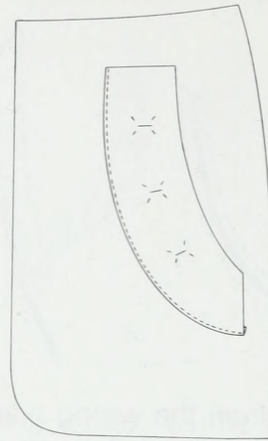

Now that the exact placement of the facing has been determined, the second piece of pocketing is removed, so that the facing can be machine-stitched to it. Top-stitch along the bottom edge of the facing.

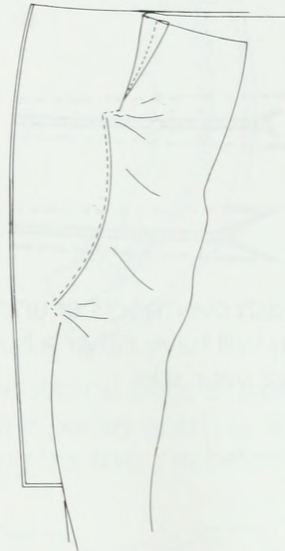

The two pocketing pieces are placed together again, edges matching. From the inside, machine-stitch on the first pocketing piece, as close as possible to the garment fabric. Stitch the length of the pocket opening, and pivot to catch the prongs at either end.

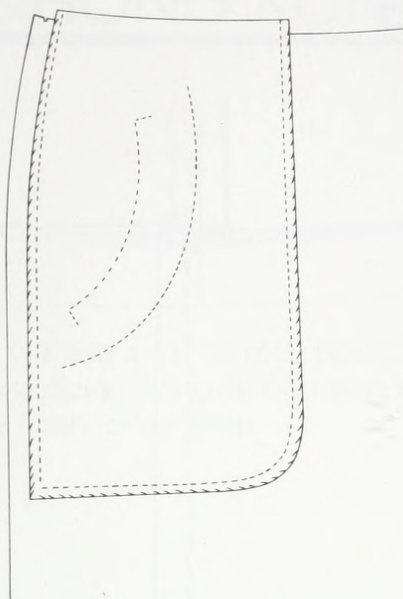

Continue to stitch around the edge of the pocketing, closing the inside of the pocket. Overcast the raw edge of the pocketing by hand or machine.

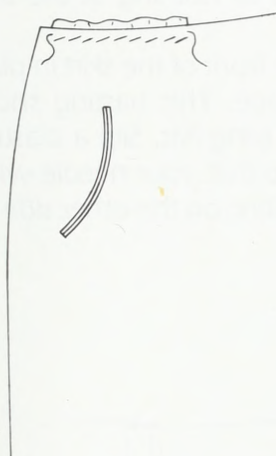

With the skirt flat on the table, and working from the right side of the fabric, baste the top edge of the pocketing to the skirt at the waist.



Baste and then machine-stitch the side seams of the skirt and the lining, separately. Tack well at the bottom of the zipper area on both skirt and lining. Press the seams open.

THE SKIRT ZIPPER CLOSING

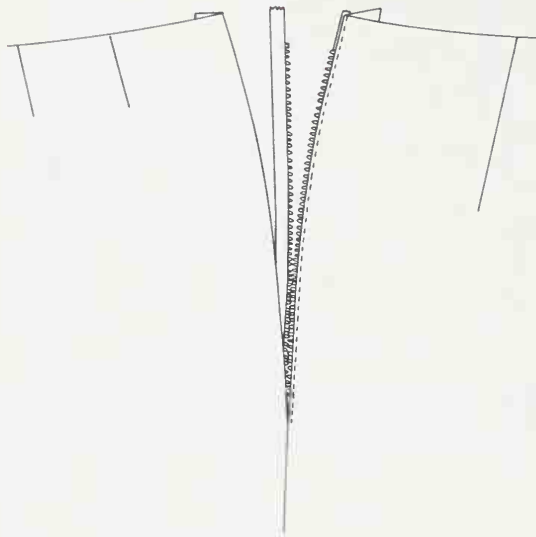

Remove the basting stitches in the zipper area and place the opened zipper along the fold at the skirt back. The metal zipper stop should be placed just below the bottom of the seam opening. Only the zipper teeth should be visible along the edge of the fold.

Using size A silk thread, back-stitch the zipper to the fold, by hand, from the waist to just above the zipper stop. The stitches should be small and evenly placed, close to the edge of the fold.

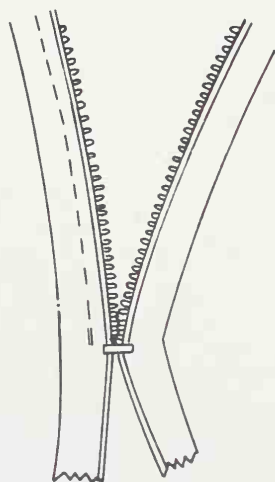

Bring the thread to the inside and tack the stitches well at the bottom of the zipper.

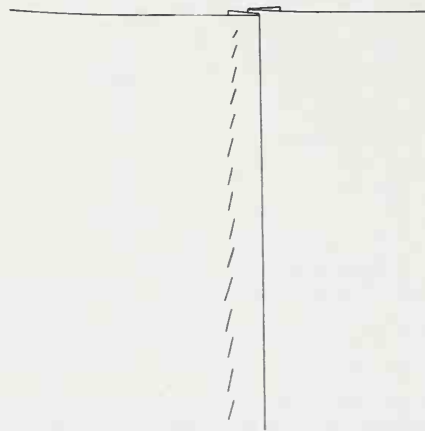

Close the zipper and place the front fold $\frac{1}{8}$ " (3 mm) over the back fold at the waist. This overlap tapers to nothing at the bottom of the zipper.

Baste the front of the skirt in place along the front zipper tape. This basting should be done with the skirt lying flat. Slip a plastic ruler under your zipper, so that your needle will hit the ruler and not the fabric on the other side of the skirt as you baste.

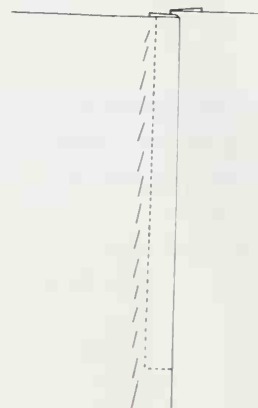

From the right side of the fabric and with zipper closed, backstitch by hand across the bottom of the zipper, just above the zipper stop.

Open the zipper, and continue backstitching along the zipper tape, up to the waistline. The stitches should be small, evenly placed, and equidistant from the fold.

THE HONG KONG PIPING

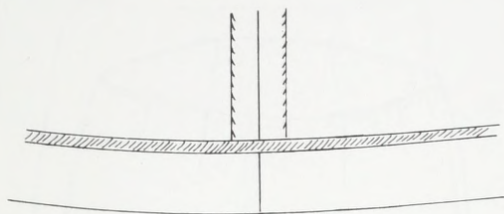

We will add a $\frac{1}{4}$ " (6 mm) piping, called a *Hong Kong piping*, along the bottom edge of the skirt, as a finish for the hem.

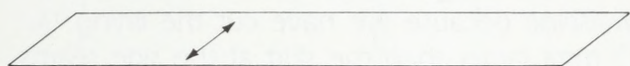

Cut a bias strip of lining, 1" (2.5 cm) wide and long enough to extend around the skirt hem.

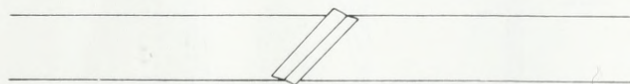
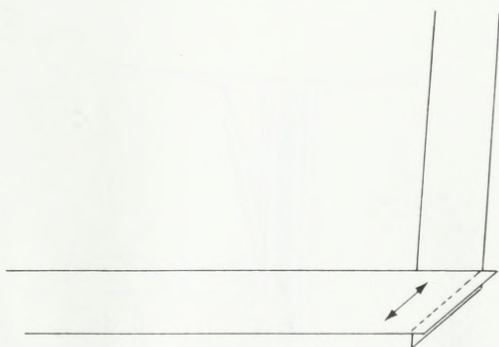

If your lining strip must be pieced, stitch the pieces together following the grainline, and press the seam open.

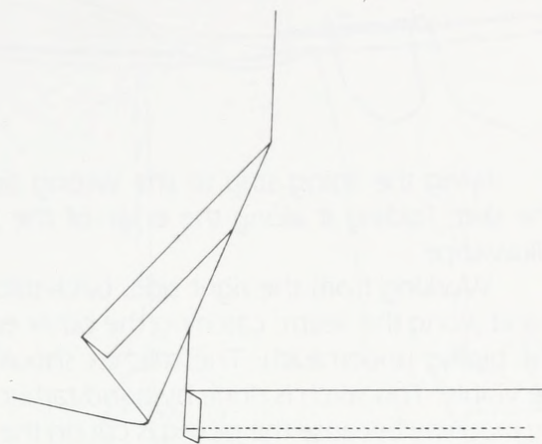

Beginning at the vent, and using a $\frac{1}{4}$ " (6 mm) seam, machine-stitch the piping to the bottom edge of the skirt, right side to right side.

Pull the piping toward you very gently as you sew. This will help prevent ripples of ease in the finished piping. If you pull the piping too much, however, the top of the hem will not lie flat.

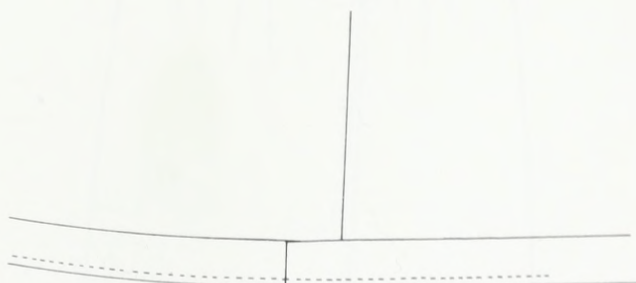
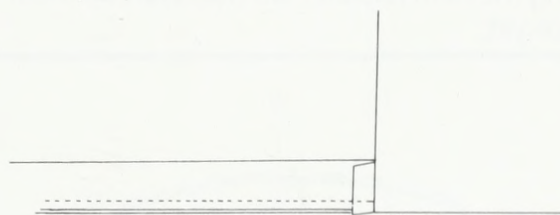

On a skirt without a vent opening, begin sewing the piping at the side seam, with a fold in the piping, and end by sewing the end of the piping flat on top of the fold.

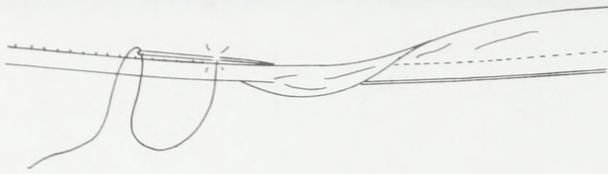

Bring the lining strip to the wrong side of the skirt, folding it along the edge of the seam allowance.

Working from the right side, back-stitch by hand along the seam, catching the other end of the piping underneath. The stitches should not be visible. This stitch is done by hand rather than by machine because the piping is cut on the bias, and is difficult to control neatly by machine. If you can manage a flat, unrippled piping by machine, by all means do.

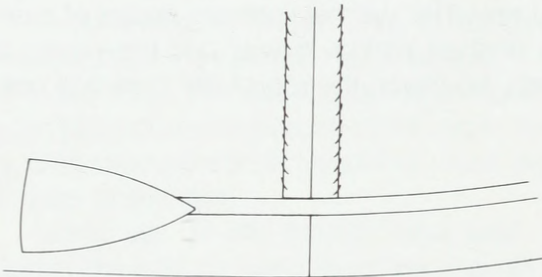

Press the piping, and press the hem up along the hem foldline. *Do not* stitch the hem in place yet.

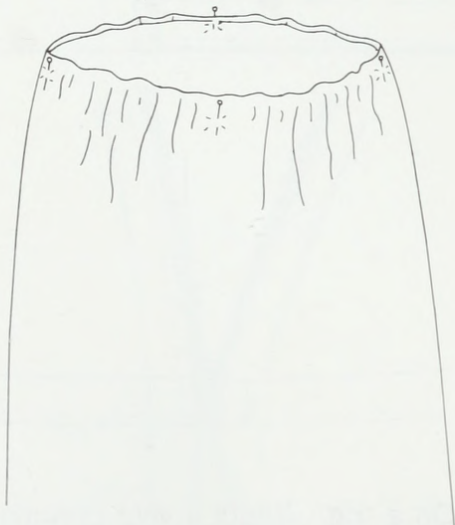

With wrong sides touching pin the lining and the skirt together at the waistline, matching side seams, and center front and back.

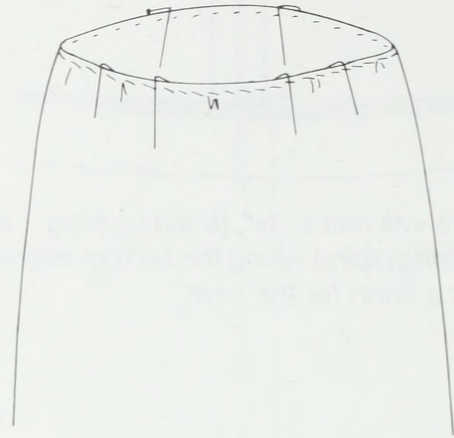

The lining is larger than the skirt at the waistline because we have cut the lining $\frac{1}{8}$ " (3 mm) larger than the skirt at the side seams, and because we have not sewn darts in the lining. Baste along the waistline, distributing the ease in the lining evenly within each quarter, by making small, flat pleats.

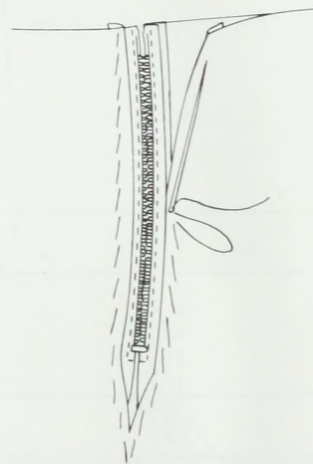

Remove the basting stitches in the zipper area of the lining, and baste the lining fold along the zipper tape. Keep the lining a safe distance from the zipper teeth, to avoid the possibility of being caught in the zipper mechanism. Back-stitch the lining to the zipper tape.

THE OVERLAP VENT AT CENTER BACK

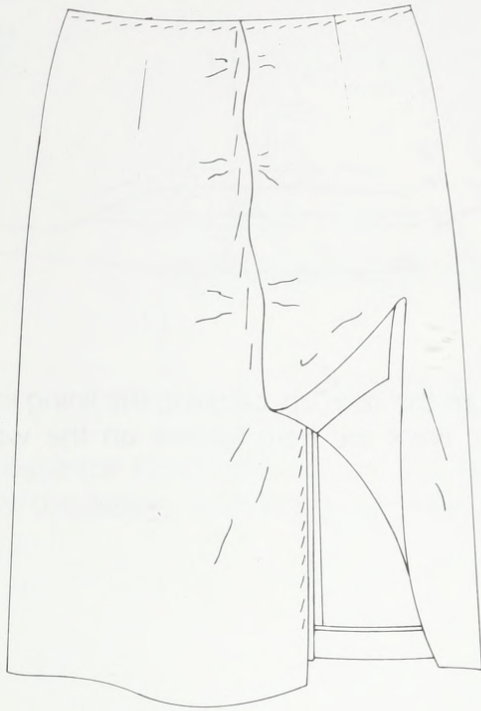

Baste the skirt back and the lining back together along the center back seam, placing small ripples of ease in the lining, from the waist to the top of the vent.

Fold and baste the lining along the edge of the vent, $\frac{1}{8}$ " (3 mm) from the edge. Continue down as far as the top of the hem.

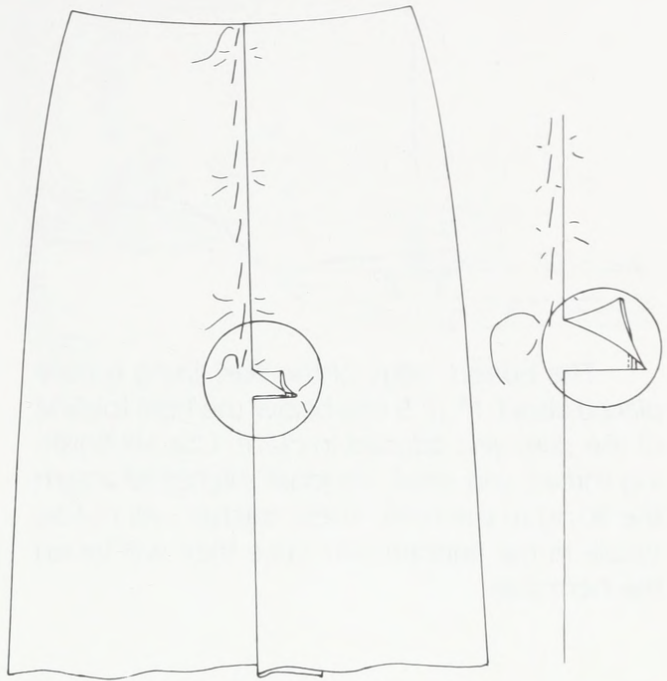

Beginning about 1" (2.5 cm) below the top of the vent, slash the top layer of the vent *lining* horizontally. Extend the slash to just past the vent opening.

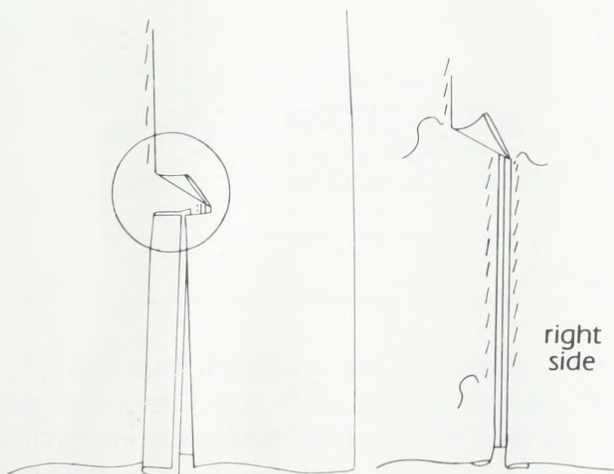

Trim some of the lining vertically, leaving only about 1" (2.5 cm) to be folded back along the second side of the vent. Fold and baste the lining along what we indicate as the right side of the vent.

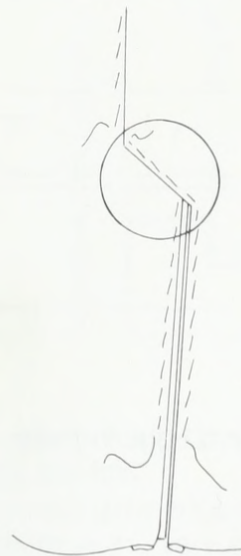

Fold the top of the vent lining underneath on the diagonal, and baste in place.

THE SKIRT HEM

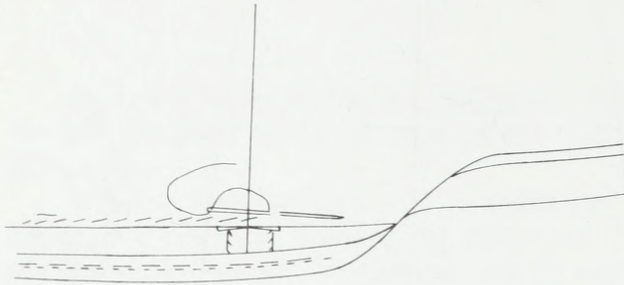

The bottom edge of the skirt lining is now placed about 1" (2.5 cm) below the hem foldline of the skirt, and stitched in place. Use silk finishing thread and small diagonal stitches to attach the lining to the hem. These stitches will not be visible in the finished skirt since they will be on the hem side.

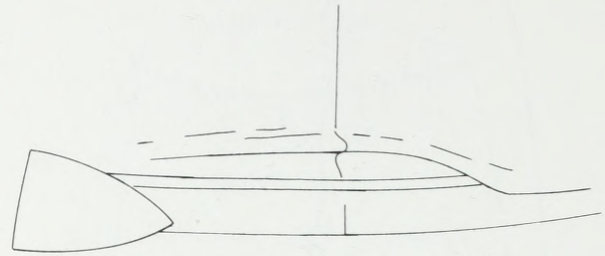

Turn the hem up, catching the lining in the foldline. Press the hem foldline on the wrong side.

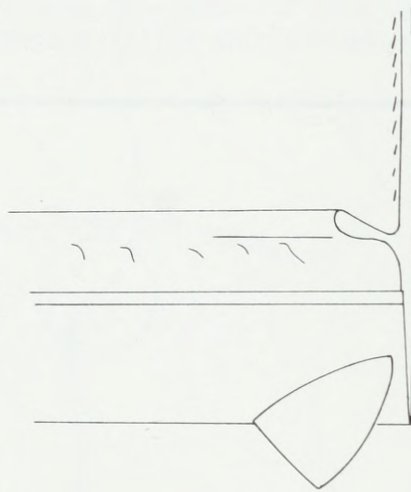

Press the vent edge in place.

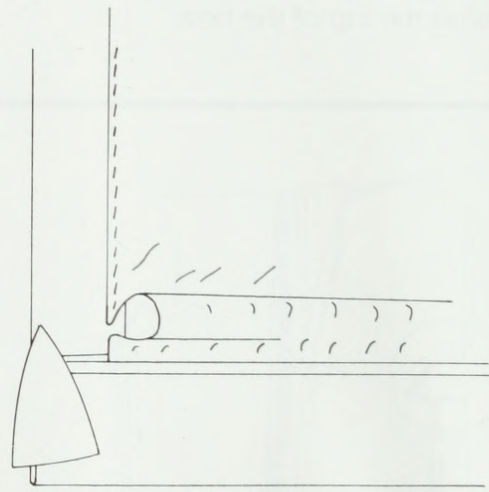

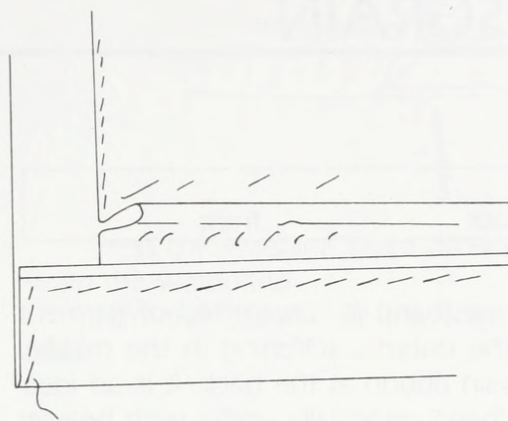
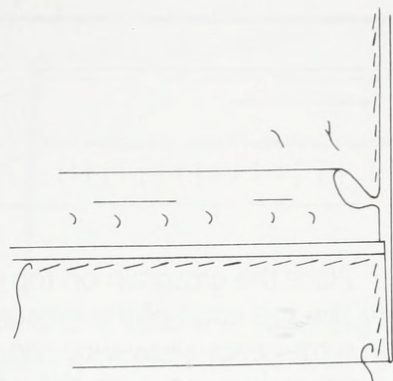

Baste the hem in place about $\frac{1}{2}$ " (1.3 cm) below the piping, and along the edge of the vent.

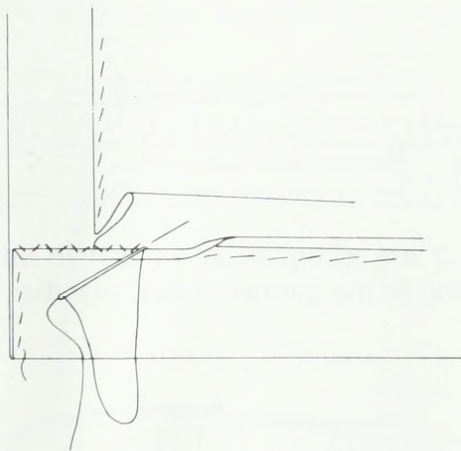

Turn back the piping and hem-stitch, catching the skirt fabric through the lining. The stitches should not be visible on the right side of the fabric.

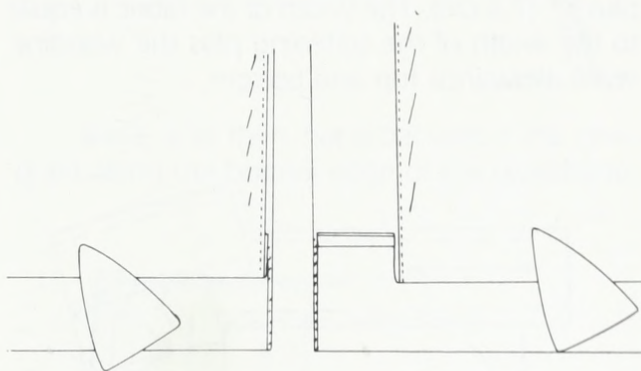

Fold the excess lining down on top of the hem, and press the fold.

Back-stitch along the edge of the lining, and slip-stitch the hem at the vent edge.

THE WAISTBAND BACKED WITH GROSGRAIN



This waistband is constructed of garment fabric on the outside, stiffening in the middle, and grosgrain ribbon at the back. It is an ideal basic waistband, especially useful with heavier fabrics, since the grosgrain eliminates one layer of the garment fabric.

Cut a strip of waistband stiffening equal in length to the body waist measurement plus 1 1/2" (3.8 cm). We suggest 1" (2.5 cm) wide stiffening, since it is less inclined to buckle.

Working from right to left, mark off one-half the body waist measurement for the front of the waistband, one-half the body waist measurement for the back of the waistband, and a 1 1/2" (3.8 cm) underlap extension.



Cut a piece of garment fabric crossgrain, equal in length to the body waist measurement plus 3" (7.6 cm). The width of the fabric is equal to the width of the stiffening plus the waistline seam allowance top and bottom.

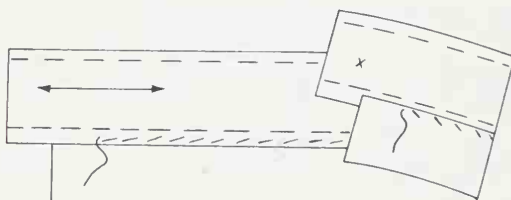

Cut a piece of grosgrain ribbon the same width as the stiffening, and the same length as the garment fabric waistband—3" (7.6 cm) longer than the body waist measurement.

Place the top edge of the stiffening under the waistband so that it is even with the seam allowance, and baste the stiffening in place stopping 1/2" (1.3 cm) from either end. There should be 3/4" (1.9 cm) extension of waistband fabric beyond either end of the stiffening.

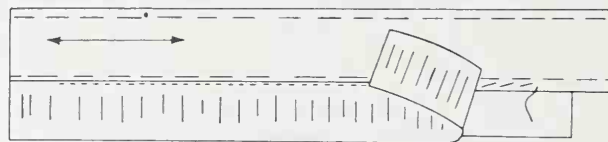

Place the grosgrain on top of the stiffening, with the top edge of the grosgrain 1/8" (3 mm) below the seam allowance line, and the end of the grosgrain even with the end of the waistband.

Machine-topstitch along the top edge of the grosgrain, attaching the grosgrain to both the waistband and the stiffening—stopping 1/2" (1.3 cm) from either end of the stiffening.

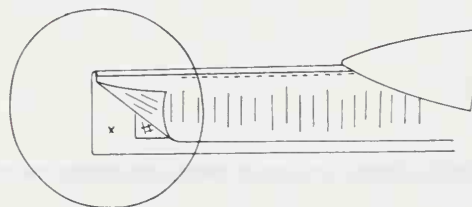

Fold the garment fabric back over the stiffening and press the fold in the waistband along the top edge of the stiffening.

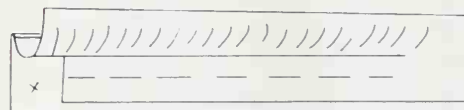

Lift the grosgrain and machine baste the stiffening to the garment fabric waistband.

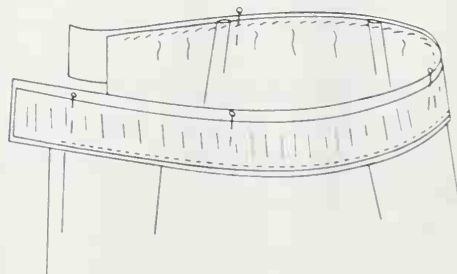

Pin the waistband to the skirt with right sides touching, matching side seams, and center front and back.

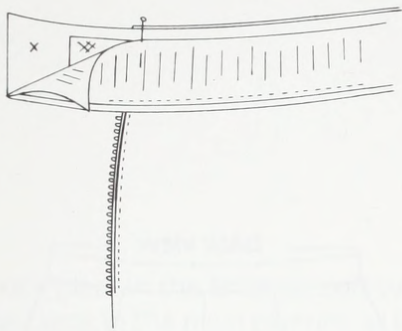

At the back of the skirt, the stiffening beneath the grosgrain extends 1 1/2" (3.8 cm) beyond the zipper edge.

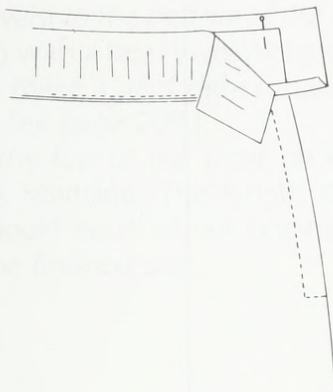

At the front of the skirt, the stiffening beneath the grosgrain is flush with the zipper fold edge.

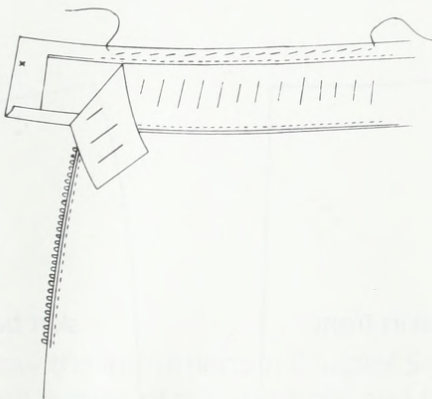

Baste the waistband to the skirt, distributing the ease evenly within each quarter. (You will recall that we have intentionally made the top edge of the skirt 1" (2.5 cm) larger than the waistband. See page 209.)

Using a ham, steam press the skirt waistline to eliminate any ripples or puckers of ease.

Machine-stitch along the garment fabric waistband, just beyond the edge of the stiffening.

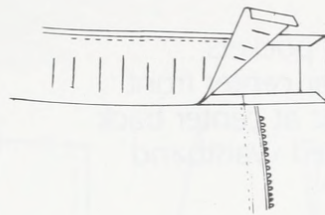

Press the waistline seam allowance up toward the waistband.

Trim the corners of the folded garment fabric.

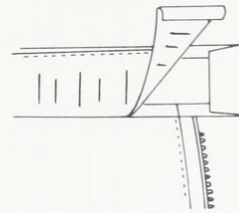

At either end of the waistband, fold and press the ends of the fabric along the edge of the stiffening.

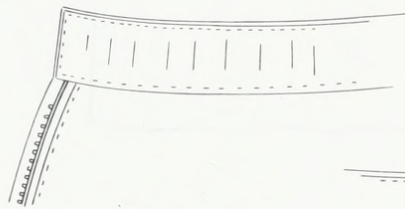

Baste and then hand-backstitch the grosgrain along the bottom edge of the waistband.

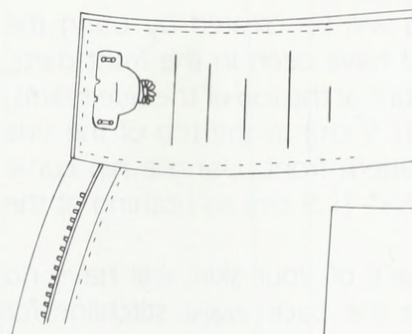
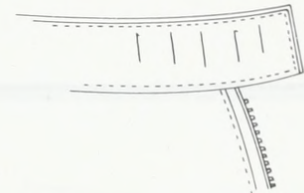

Attach a skirt hook and eye.

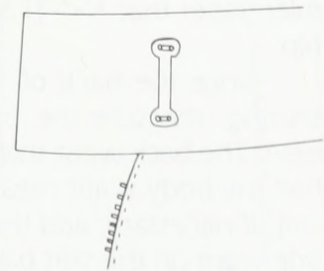

2. STRAIGHT SKIRT WITH SHIRRING

- Crescent pockets
- Shirring at center front
- Kick pleat at center back
- Self-backed waistband

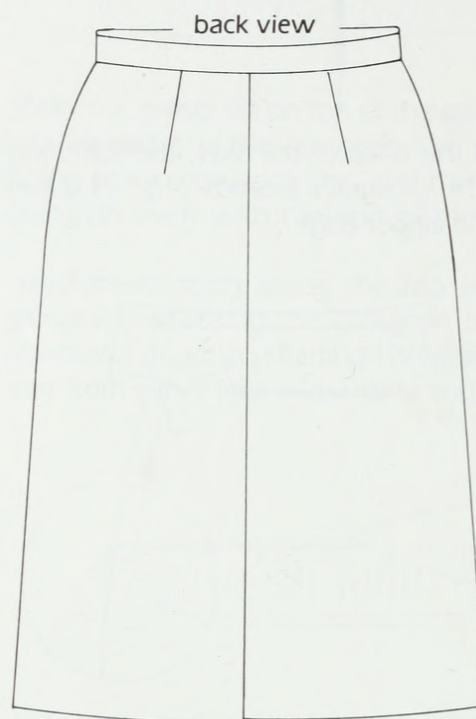
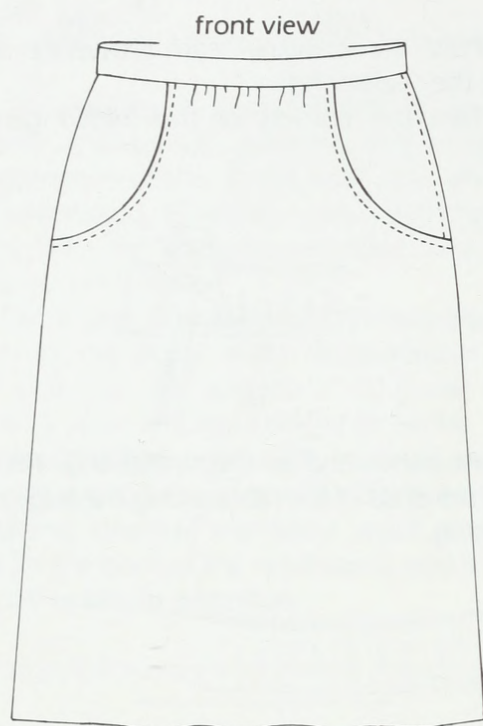

This skirt can be adapted from a pattern for a straight skirt that has neither pockets, nor shirring nor kick pleat.

The shirring will be created by using the fabric that would have been in the front darts, and by adding fabric at the top of the side seams. Add about $\frac{3}{4}$ " (1.9 cm) to the top of the side seam on your pattern front. Using a hip curve ruler, taper that $\frac{3}{4}$ " (1.9 cm) to nothing at the hip.

Since the back of your skirt will have no shirring, measure the back waist stitchline for ease. The back waist stitchline should equal one-half the body waist measurement plus $\frac{1}{2}$ " (1.3 cm). If necessary, add the ease at the top of the side seam on the skirt back pattern, and taper to nothing at the hip.

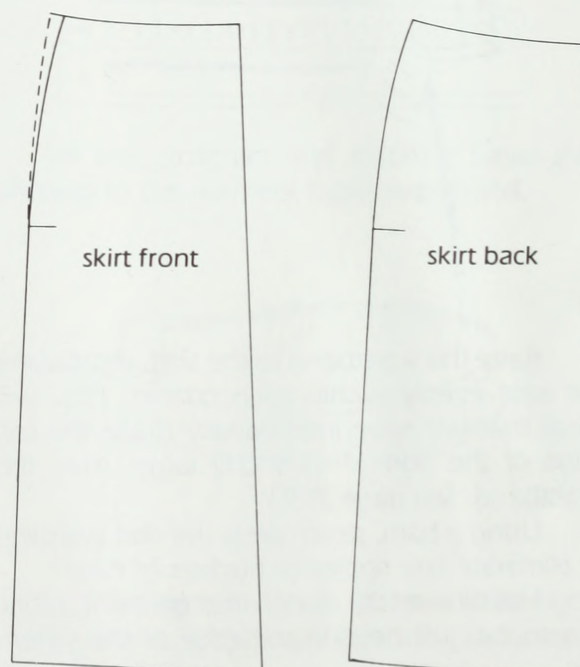

The kick pleat in the finished skirt will hang better if the fabric in the pleat extends all the way to the waistline, where it can be secured into the waistline seam. If the pleat in your pattern appears as in the illustration on the left, adjust your pattern.

Add 3" (7.6 cm) to your pattern at center back from waist to the bottom of the skirt. (If you are working with a heavyweight fabric, it would be wiser to make a vent rather than a pleat, to avoid bulk. See page 209.)

Mark the top of the pleat on the original center back seamline. The length of the pleat opening should equal about one-half the total length of the finished skirt.

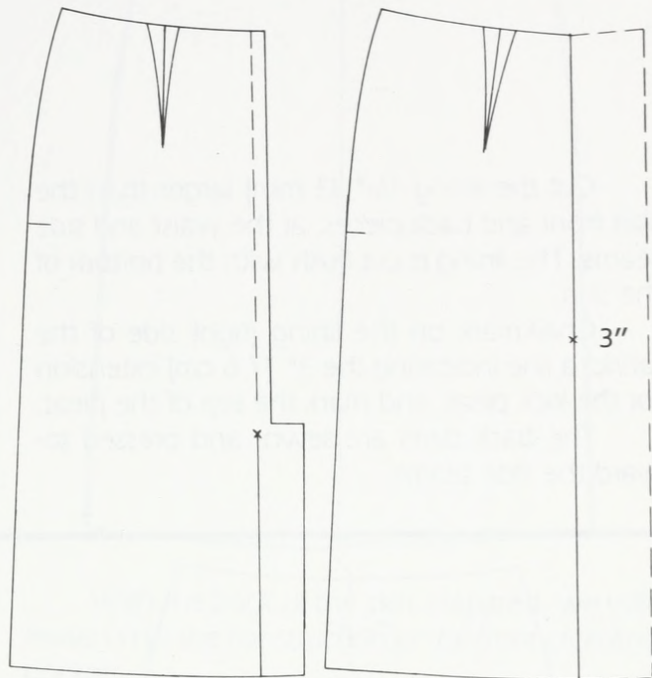

Follow the instructions in Chapter 5 for the layout and cutting of the skirt front and back.

On the wrong side of the fabric, chalkmark

- The darts
- The bottom of the zipper
- The 3" (7.6 cm) kick-pleat extension
- The hem foldline

On the wrong side of the fabric, tailor tack

- The bottom of the darts
- The foldline from the top of the pleat to the hem
- The hem foldline

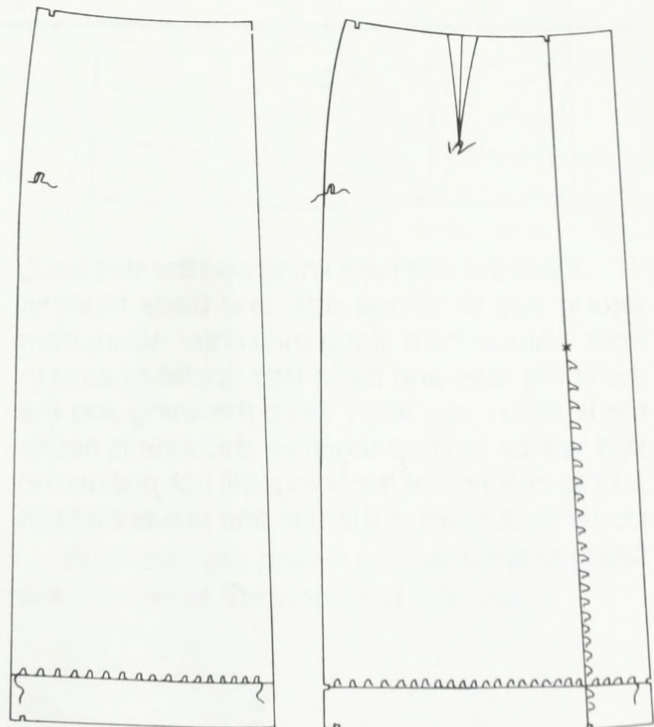

Cut the lining $\frac{1}{8}$ " (3 mm) larger than the skirt front and back pieces, at the waist and side seams. The lining is cut flush with the bottom of the skirt.

Chalkmark on the lining (right side of the fabric) a line indicating the 3" (7.6 cm) extension for the kick pleat, and mark the top of the pleat.

The back darts are sewn, and pressed toward the side seams.

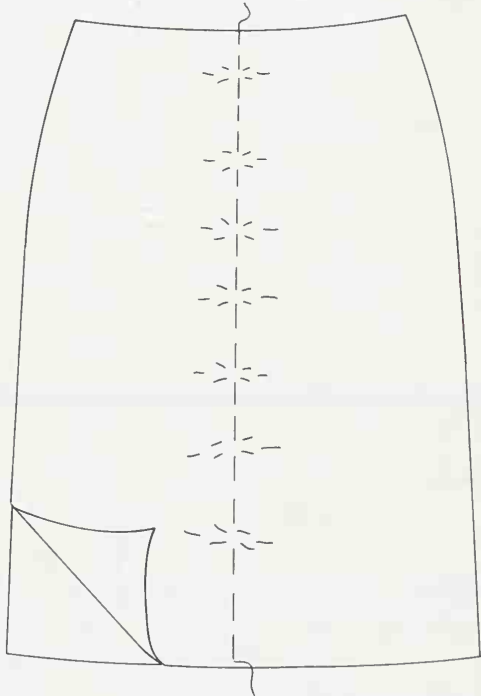
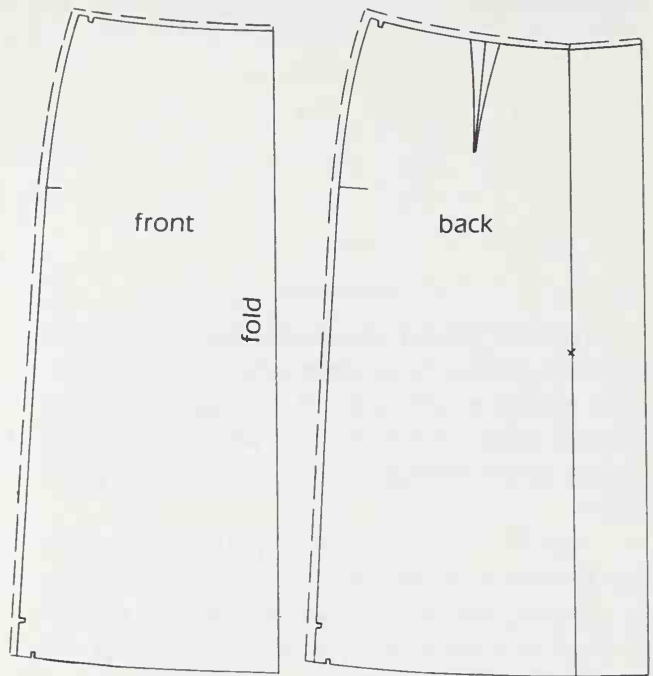

Place the skirt back lining and the skirt back, wrong side to wrong side, and baste together from waist to hem along the center. Work from the lining side, and baste little ripples of ease in the lining as you stitch. Since the lining and the skirt will be stitched together, this ease is necessary to ensure that the lining will not pull on the center back seam of the skirt and prevent it from falling gracefully.

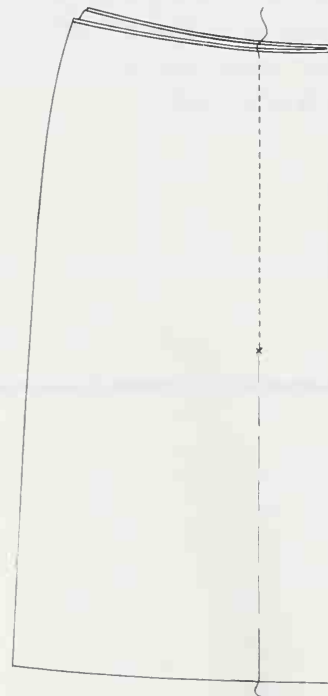

Fold the skirt and lining fabric using the center back line of basting as a guide, right sides of the garment fabric touching. Press the fold, and then baste along the 3" (7.6 cm) kick pleat extension from waist to skirt bottom. This basting catches two layers of lining and two layers of garment fabric. Machine-stitch from the waist to the top of the kick pleat, tacking well at the top of the pleat.

The basting stitches which run from the top of the pleat to the hem, are left in the fabric for the moment in order to guarantee accuracy in pressing the pleat foldline.

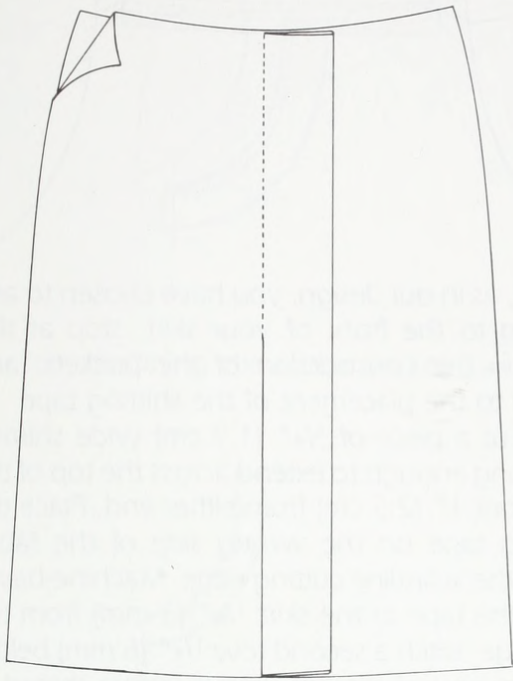

Press the pleat to the left side of the skirt.

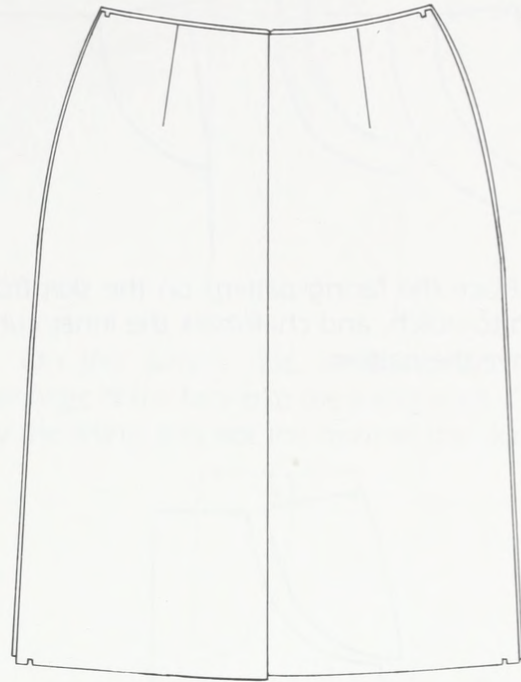

With the back of the skirt prepared, we will move on to the construction of the front crescent pockets.

THE CRESCENT POCKET

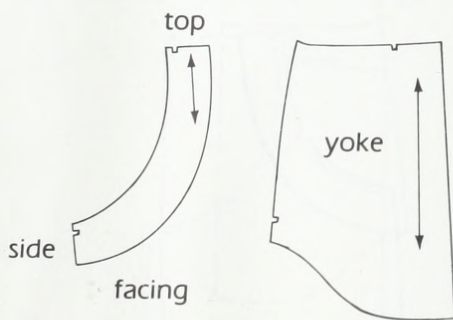

For these pockets you will need patterns labelled CRESCENT POCKET FACING and CRESCENT POCKET YOKE, found on pages 301 and 303. Trace these patterns onto oaktag or sturdy paper for use.

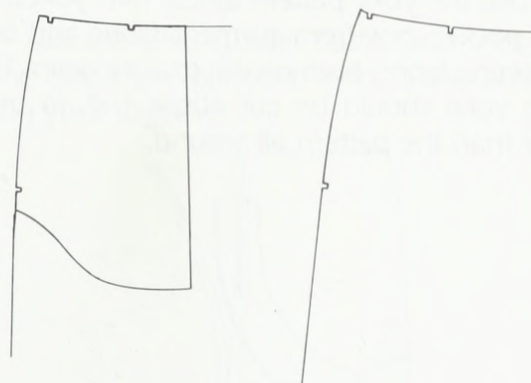

Place the yoke pattern on the skirt front and mark notches at the waist and side seams.

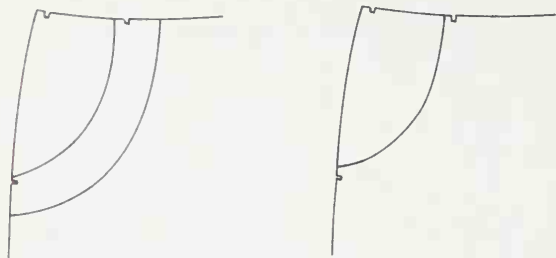

Place the facing pattern on the skirt front, notch to notch, and chalkmark the inner curve. Remove the pattern.

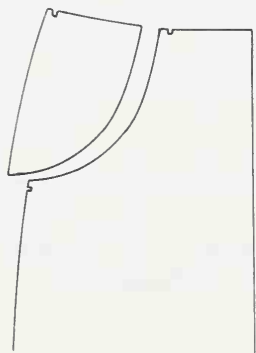

Trim the fabric above the curve.

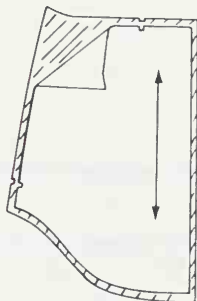

Use the yoke pattern to cut two yokes for each pocket, one from garment fabric and one from lining fabric, both on the straight grain. The lining yoke should be cut about $\frac{1}{4}$ " (6 mm) larger than the pattern all around.

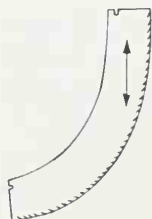

Use the crescent pocket facing pattern and cut from garment fabric, one facing for each pocket. Overcast the outer edge of the facing by machine or by hand, or press a $\frac{1}{4}$ " (6 mm) hem to the wrong side.

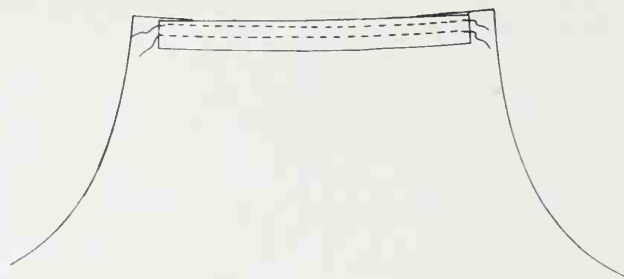

If, as in our design, you have chosen to add shirring to the front of your skirt, stop at this point in the construction of the pockets, and attend to the placement of the shirring tape.

Cut a piece of $\frac{3}{4}$ " (1.9 cm) wide shirring tape long enough to extend across the top of the skirt front 1" (2.5 cm) from either end. Place the shirring tape on the wrong side of the fabric along the waistline cutting edge. Machine-baste-stitch the tape to the skirt $\frac{1}{8}$ " (3 mm) from the top edge. Stitch a second row $\frac{1}{4}$ " (6 mm) below the first row of stitches. Leave excess thread at the end of each row. These threads will eventually be pulled to create the shirring.

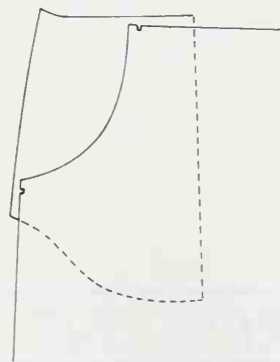

Now continue with the pocket construction. Place the lining yoke on the wrong side of the skirt, to extend $\frac{1}{4}$ " (6 mm) above the waist, and $\frac{1}{4}$ " (6 mm) out at the side seam.

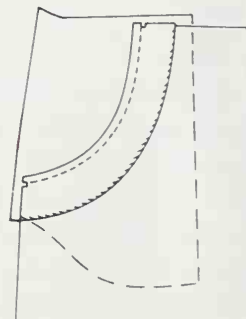

Place the facing at the pocket curve, right sides touching, and baste it in place, catching the lining yoke as you baste.

Machine-stitch the facing and the lining yoke to the skirt using a $\frac{1}{8}$ " (3 mm) seam along the pocket curve.

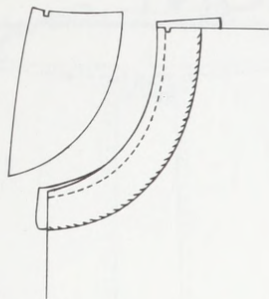

Trim the lining above the pocket curve.

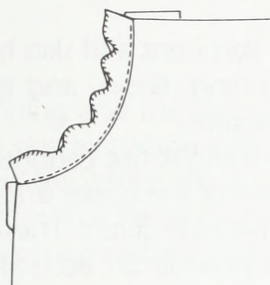

Turn the facing and stay stitch it to the seam allowance. Stitch close to the seam.

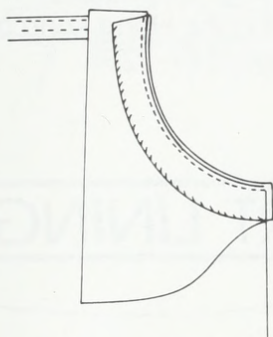

Bring the stay-stitching and the seam about $\frac{1}{16}$ " (1.5 mm) to the wrong side, so that the seam will not be visible from the right side.

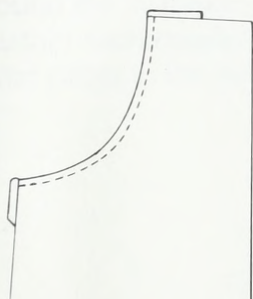

Press the facing in place, being careful not to stretch the bias pocket curve.

On the right side of the fabric, topstitch by hand or by machine, $\frac{1}{4}$ " (6 mm) from the edge of the pocket.



On the wrong side, machine stitch the outer edge of the facing to the lining yoke. Catch only the lining and not the front of the skirt.

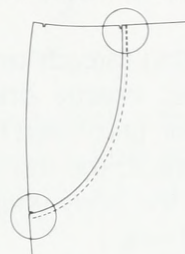

Place the right side of the garment fabric yoke to the wrong side of the skirt, the notches on the yoke matching the top and the side of the pocket curve. Baste in place.

Stitch on top of the topstitching for about $\frac{3}{4}$ " (1.9 cm) at the top and at the side of the pocket curve to secure the yoke to the skirt.



On the wrong side, baste, and then machine stitch the garment fabric yoke and the lining yoke together.



Trim the seam allowance evenly around the inside of the pocket, and overcast the edges.

The pocket is complete. We now move on to the shirring at the skirt's center front.

SHIRRING AT THE CENTER FRONT

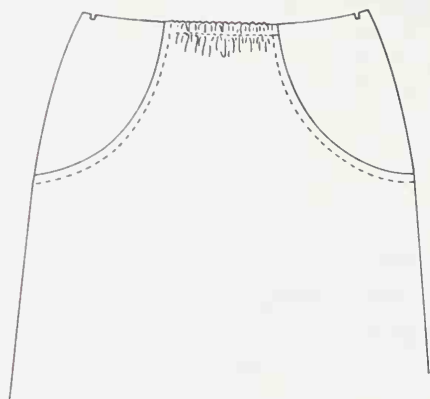

Pull the shirring threads until the skirt front waistline measures exactly one-half the body waist measurement. (If the skirt has no shirring or pleats at the waistline, the front would have to measure one-half the body waist measurement, plus $\frac{1}{2}$ " (1.3 cm) ease.)



Place the skirt front and skirt back together, right sides touching. Baste, and then machine stitch the side seams.

The back lining is not caught in this seam. From the bottom of the zipper area to the waist use a longer machine stitch. These stitches are placed only to provide an accurate foldline for pressing the seam in this area.

Press the side seams open.

The zipper is now inserted following instructions on page 218. Finish the bottom edge of the skirt using the Hong Kong piping demonstrated on pages 219–220.

ASSEMBLING SKIRT AND SKIRT LINING

Place the skirt front to the skirt back lining, right sides touching. Baste, and then machine stitch the side seams. Tack well at the bottom of the zipper, using a longer machine stitch from the zipper to the waist.

Press the lining seams open.

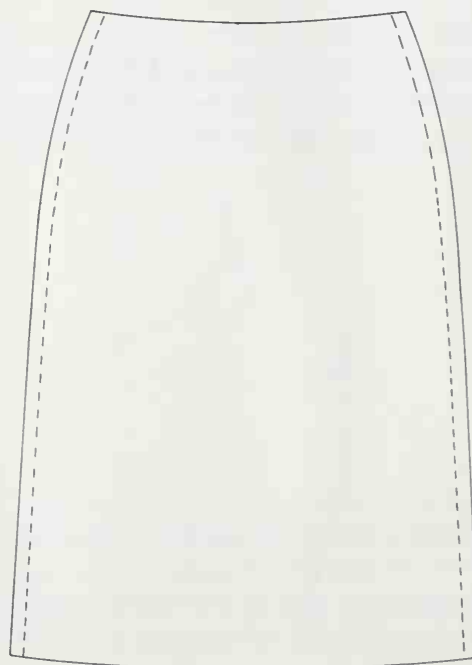

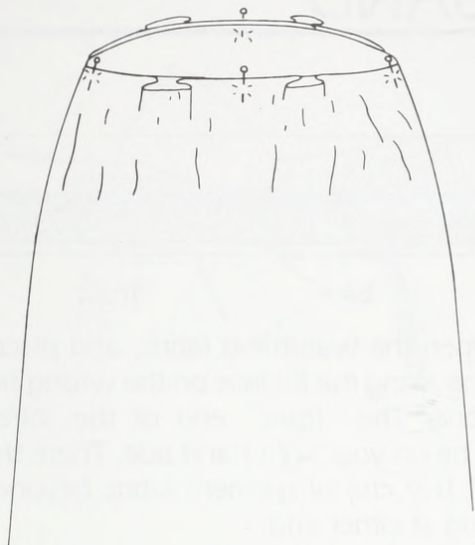

Pin the lining and the skirt together at the waist, wrong side to wrong side, matching the side seams and the center front and back.

The lining will be larger than the skirt at the waist, since we have neither shirring nor darts in the lining.

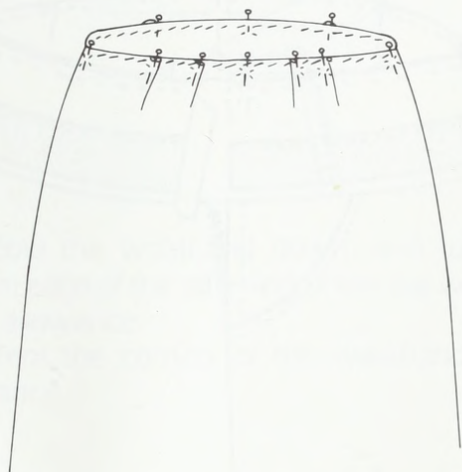

Baste around the waistline distributing the ease evenly within each quarter of the skirt, by folding small flat pleats in the lining.

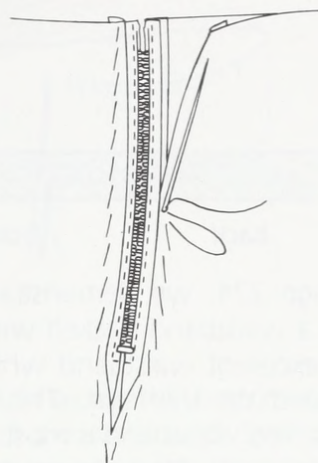

Remove the basting stitches in the zipper area of the lining, and baste the lining fold along the zipper tape. Keep the lining a safe distance from the zipper teeth, to avoid the possibility of being caught in the mechanism.

Back stitch the lining to the zipper tape.

The bottom of the lining, and the skirt hem are completed as per instructions beginning on page 222.

THE SELF-BACKED WAISTBAND



1 1/2" back front

On page 224, we demonstrate the construction of a waistband backed with grosgrain ribbon, an excellent waistband which can certainly be used on this skirt. The use of the grosgrain-backed waistband is most valuable on skirts made of bulky fabric, since the grosgrain eliminates one layer of the bulky fabric in the waistband. If your fabric is not bulky, or if you do not have grosgrain, or simply as an alternative, we here demonstrate the self-backed waistband.

Cut a strip of waistband stiffening equal in length to the waist measurement plus 1 1/2" (3.8 cm). We suggest 1" (2.5 cm) wide stiffening, since it is less likely to buckle with wear.

Working from right to left, measure and mark off one-half the body waist measurement for the front of the waistband, one-half the body waist measurement for the back of the waistband, and 1 1/2" (3.8 cm) as an underlap extension.

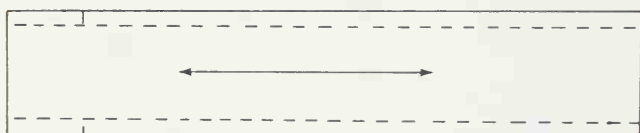

Cut a piece of garment fabric, on cross-grain, equal in length to the body waist measurement, plus 3" (7.6 cm). The width of the fabric is twice the width of the stiffening, plus your waistline seam allowance top and bottom.



Fold the waistband fabric in half lengthwise, wrong sides touching, and press the fold.

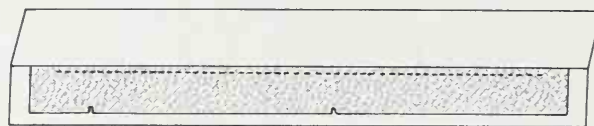

3/4" back front 3/4"

Open the waistband fabric, and place the stiffening along the foldline on the wrong side of the fabric. The "front" end of the stiffening should be on your right-hand side. There should be 3/4" (1.9 cm) of garment fabric beyond the stiffening at either end.

Machine-stitch the stiffening to the garment fabric 1/4" (6 mm) below the fold. Stop stitching 3/4" (1.9 cm) before either end of the stiffening.



Place the waistband at the top edge of the skirt, right side to right side. On the skirt front, the edge of the stiffening should fall at the zipper seam. On the skirt back, the stiffening extends beyond the zipper by 1 1/2" (3.8 cm). Pin the waistband to the skirt at the side seams, the center front and back. Baste the waistband to the skirt, distributing the 1/2" (1.3 cm) waistline ease evenly at the back.

Machine-stitch the waistband to the skirt using a 1/2" (1.3 cm) seam.

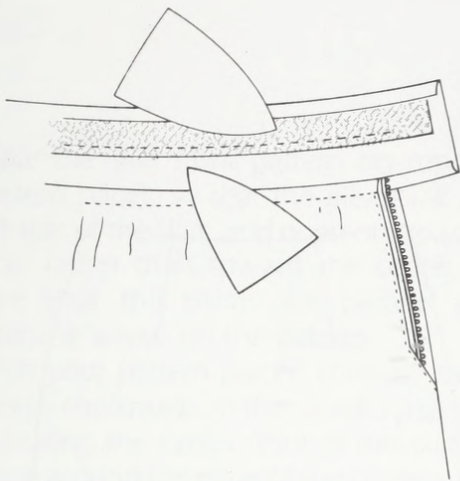

Working from the wrong side of the skirt, press the waistline seam up toward the waistband; and press the top seam allowance down on top of the stiffening.

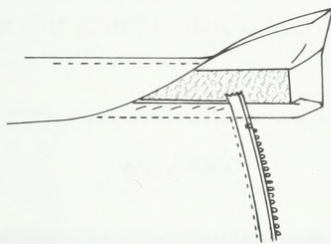

Fold the waistband down, and tuck the bottom edge of the stiffening under the waistline seam allowance.

Trim the corners of the waistband seam allowance.

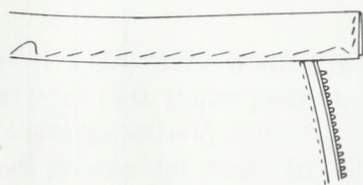

At either end of the waistband, fold the garment fabric neatly along the stiffening, and press.

On the wrong side of the garment, baste the waistband in place along the waist seamline.

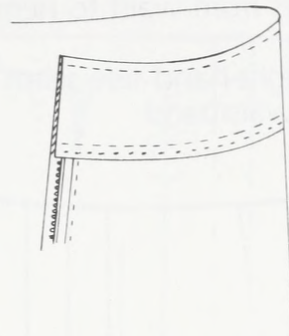

Prick-stitch along the bottom edge of the wrong side of the waistband. Stitch through all layers, but do not allow the stitches to show on the right side of the waistband. Press the waistband from the inside.

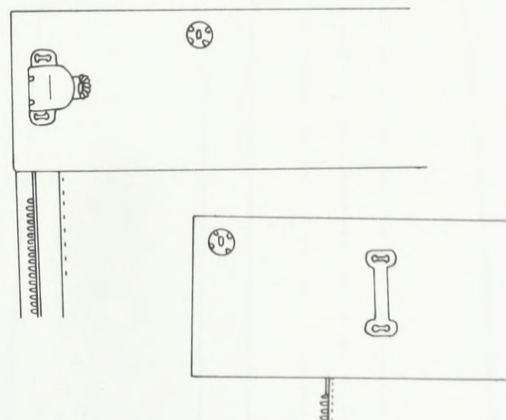
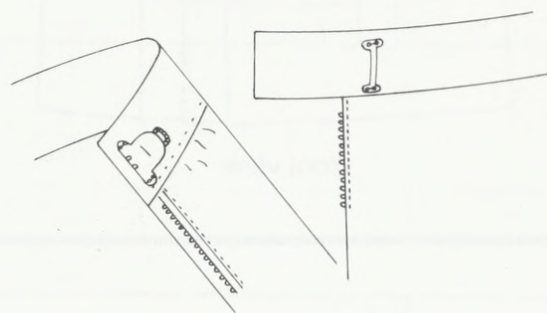

Use a blanket stitch to secure a skirt hook and eye. A small snap will hold the extension in place.

3. SKIRT WITH PLEATS

- Three pleats from waist to hem at left front
- Pocket in right-hand side seam
- Grosgrain waistband

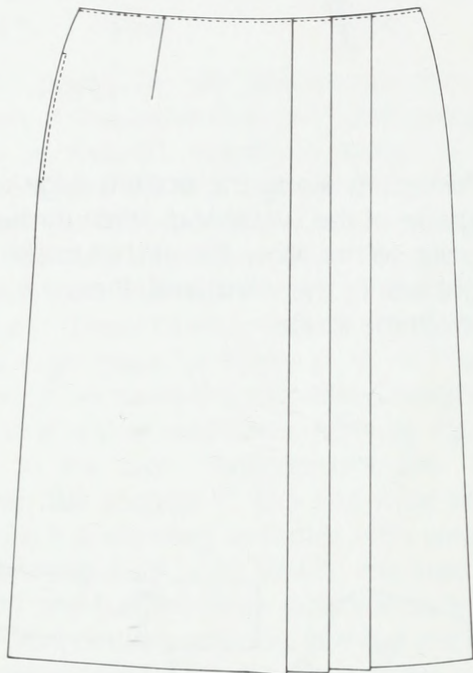

front view

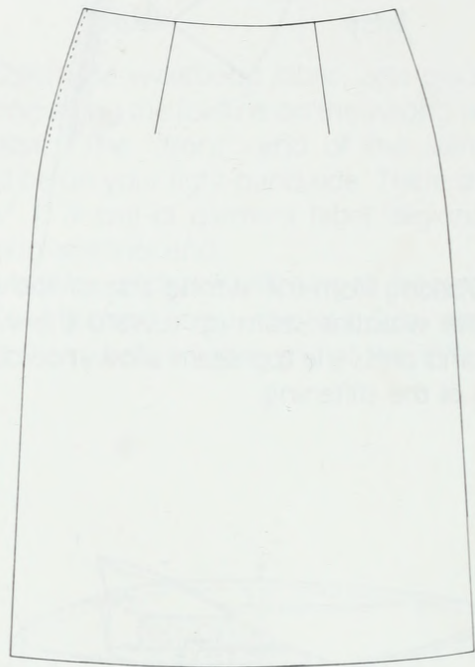

back view

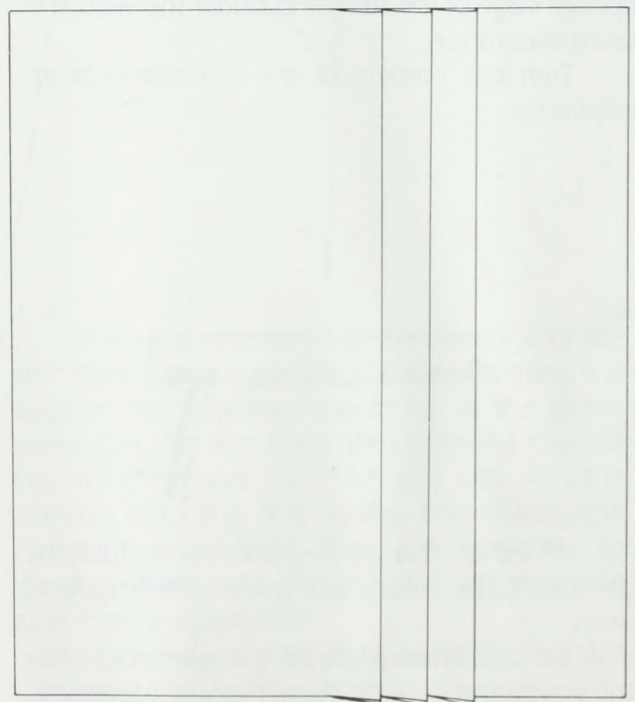

Choose a commercial pattern for this skirt, or, if you wish, modify the front of any straight skirt pattern as follows:

1. Press three pleats, each about 1" (2.5 cm) deep, into a large piece of brown paper.

2. Place the skirt front pattern on top of the pleated paper, so that the pleats fall on the left side of the skirt, and open out toward the side, rather than toward the center. Make sure that the pleats are parallel to the grainline arrow on the pattern.
3. With your pattern placed correctly over the pleats, chalkmark on the pleated paper a line indicating the center front of the skirt.
4. Trace around the edge of the pattern, first on the left (pleated) side of the skirt, then on the right side.
5. Transfer onto the pleated paper, markings indicating the hemline, the bottom of the zipper, and the dart on the right side of the skirt front. The dart on the left side of the skirt is not marked at this time. It will be handled during the construction of the skirt.
6. Remove the straight skirt pattern.

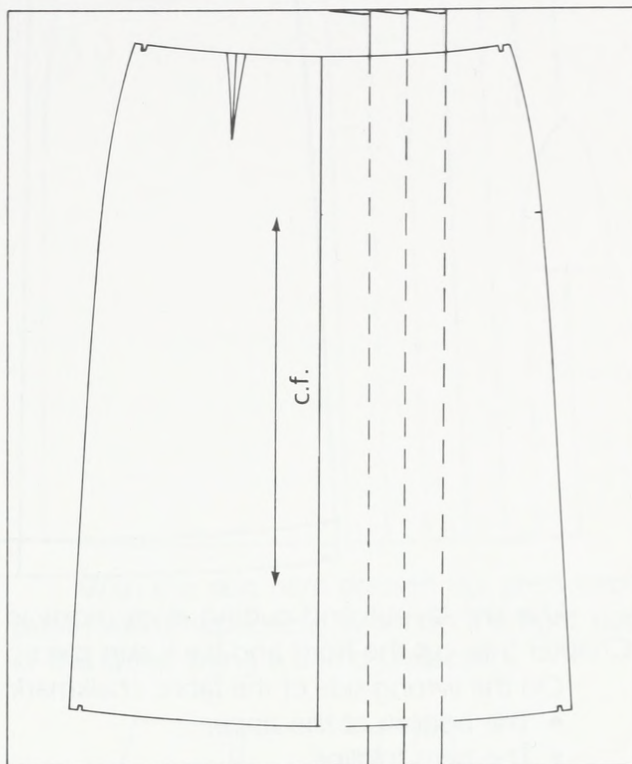

7. Add $\frac{1}{2}$ " (1.3 cm) at the bottom of each side seam on your new paper pattern. Taper the $\frac{1}{2}$ " (1.3 cm) to nothing at the hip. This extra fabric will enable the pleats to fall comfortably, and make them less inclined to open out.

Make the same addition at the bottom of the side seams on the skirt back pattern.

8. Cut out your new paper pattern, and open out the pleats.

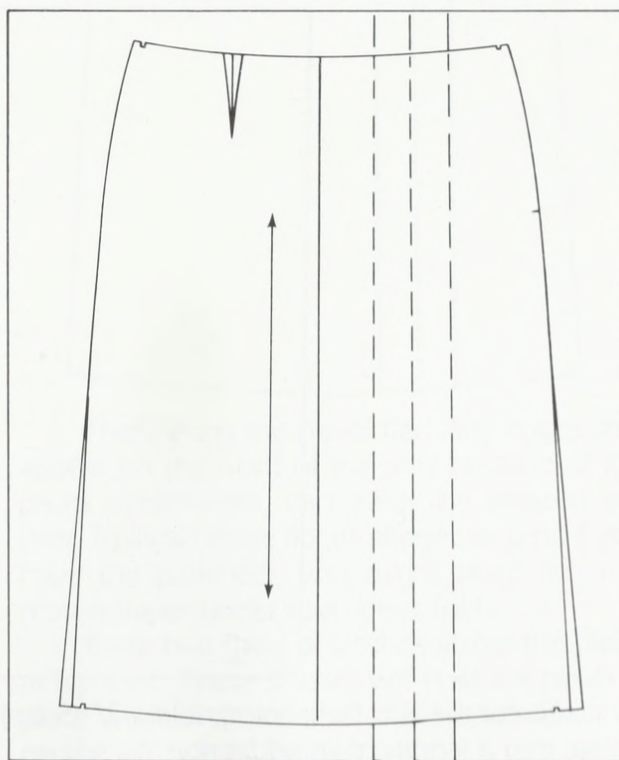

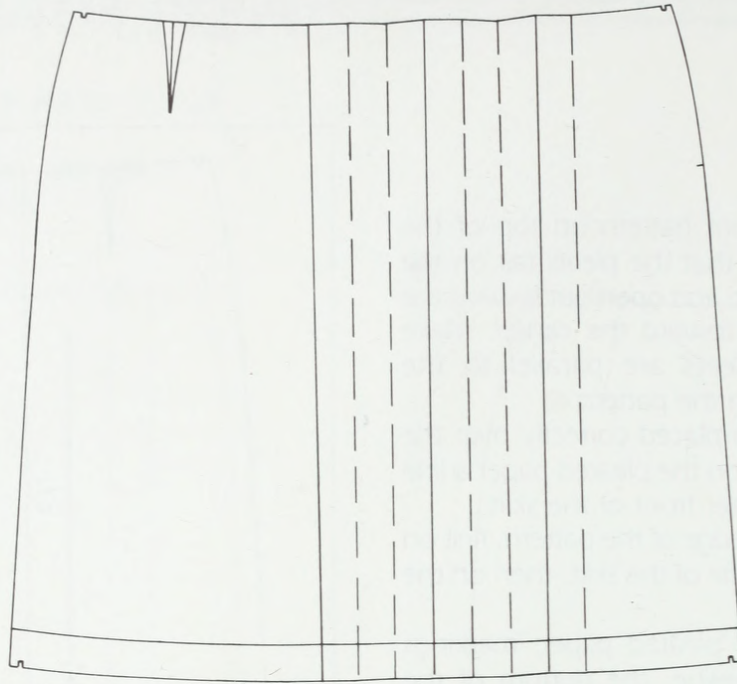

Use the layout and cutting instructions in Chapter 5 to cut the front and back skirt pieces.

On the wrong side of the fabric chalkmark:

- The bottom of the zipper
- The hem foldline

On the right side of the fabric chalkmark, *lightly*:

- The dart
- The pleat foldlines

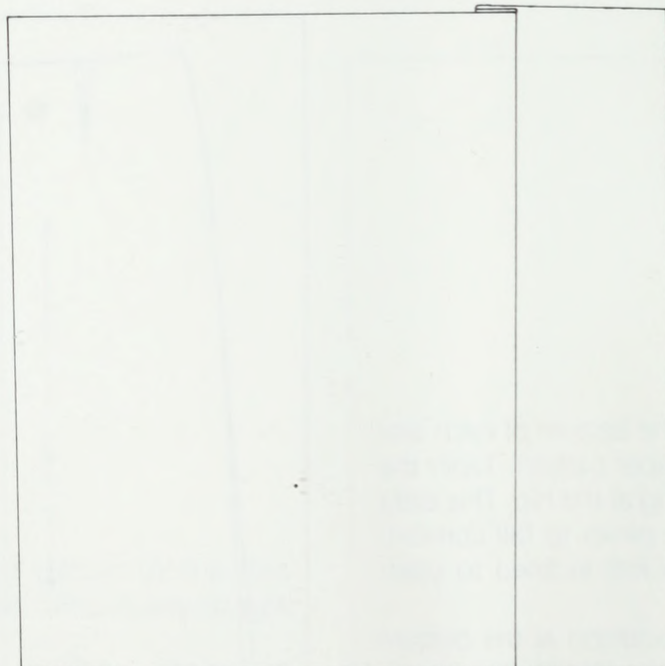

To cut the skirt front lining, fold a 2" (5 cm) pleat into a length of lining fabric.

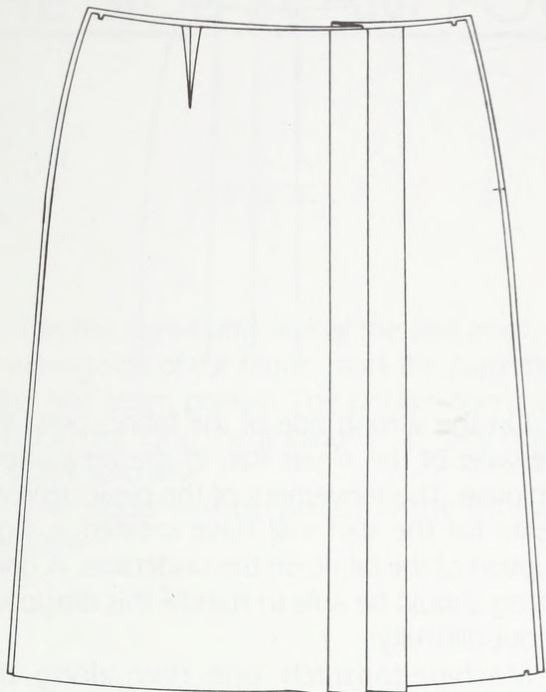

With the pleats in your skirt front pattern folded closed, place the pattern on top of the lining, so that the pleats in the pattern fall directly on top of the pleat in the lining.

There is no need for a pleat in the skirt back lining.

Cut the front and back lining $\frac{1}{8}$ " (3 mm) larger than the pattern at the waist and side seams, and flush with the pattern at the hem.

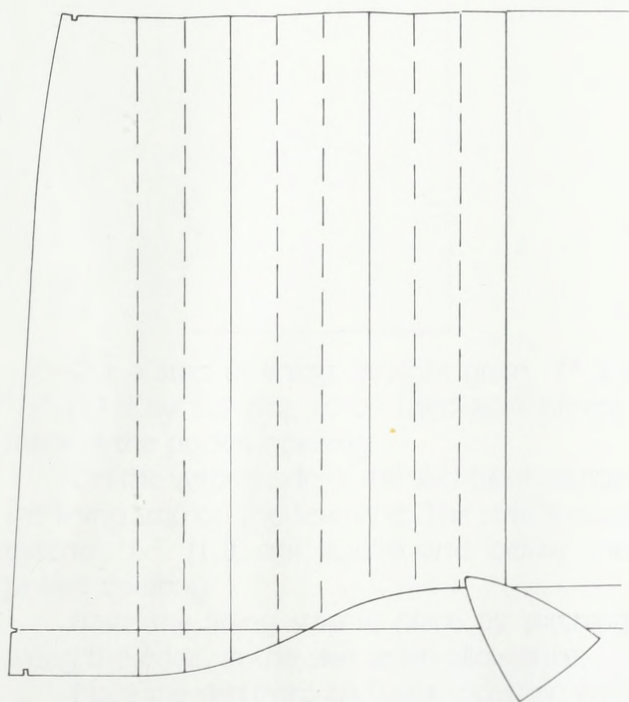

Fold and press the hem on the skirt front.

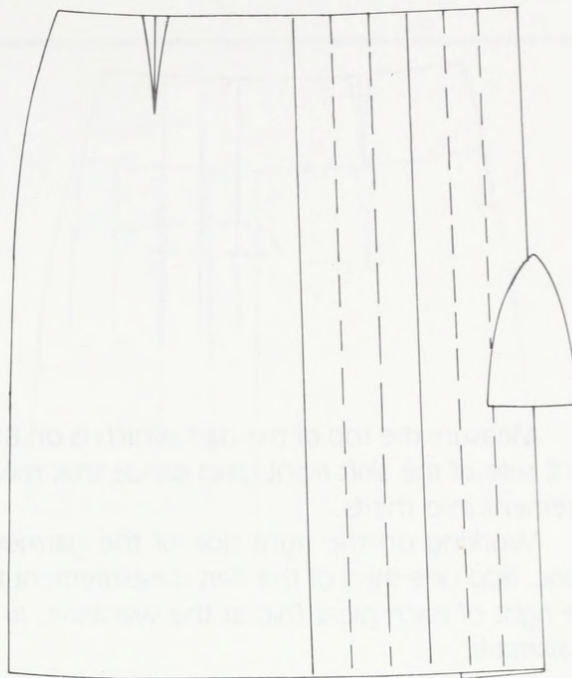

With the skirt hem pressed up, press each pleat foldline separately. Work on the right side of the fabric, using a damp presscloth.

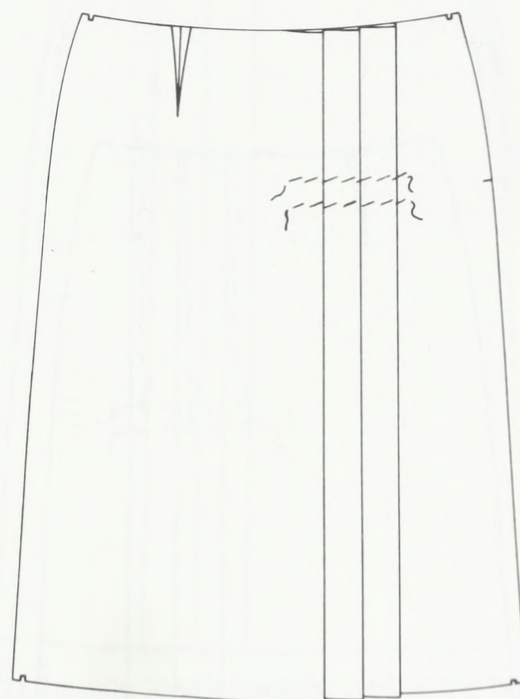

Then, press the pleats flat. Any ridges that appear on the front of the skirt because of the pleats underneath, can easily be pressed out later. To avoid these ridges altogether (and if you have the patience), you might place strips of brown paper under each pleat fold.

Baste two rows of stitches across the pleats at hip level. These stitches will hold the pleats in place while we take care of the dart allowance on the left side of the skirt front.



Measure the top of the dart which is on the right side of the skirt front, and divide that measurement into thirds.

Working on the right side of the garment fabric, add one-third of the dart measurement to the right of each pleat fold at the waistline, and chalkmark.

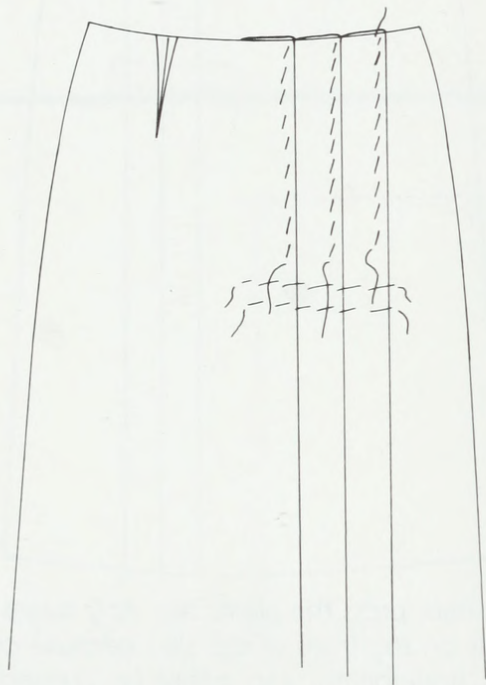

Move the top of each pleat over to the chalkmark, and baste the pleat smoothly in place, from waist to hipline. This procedure reproduces on the left side of the skirt, the shaping that will be produced by the dart on the right side of the skirt.

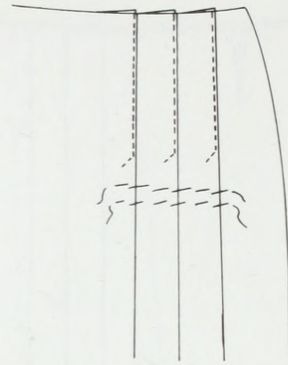

On the wrong side of the fabric, press the underlayer of the pleats flat, in the area above the hipline. The movement of the pleats to compensate for the dart will have created a slight disruption of the fabric on the underside. A good pressing should be able to handle this disruption without difficulty.

Machine-topstitch one row along the foldline of each pleat, from waist to hipline. End the stitchline at the fold, or take three or four stitches onto the pleat. Secure the end of the stitchline, by bringing the threads to the inside and knotting them.

The dart on the right side of the skirt front is sewn, and pressed toward the side seam.

THE SIDE SEAM POCKET

On the right-hand side of the skirt front, on the wrong side of the fabric, mark the placement of the side seam pocket. The pocket opening is 6" (15.2 cm) long, beginning 2" (5 cm) below the waist stitchline.

The zipper will be placed in the left-hand side seam.

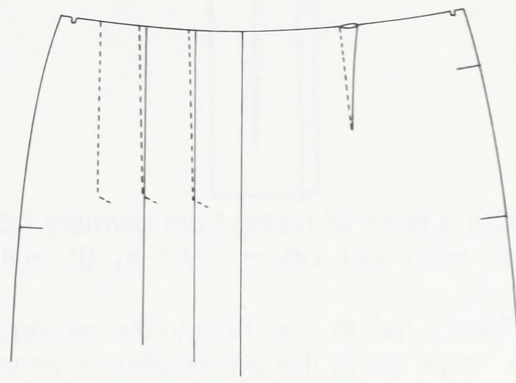

Cut a strip of lining, straight grain, 7" by 1/2" (17.8 by 1.3 cm), to be used as reinforcement at the pocket opening.

On the wrong side of the skirt front, center the lining strip on the seamline. The strip should extend 1/2" (1.3 cm) above and below the pocket opening.

Baste the lining strip in place by stitching along the edge, in the skirt seam allowance.

Place the skirt front and back together, with right sides touching. Baste and then machine-

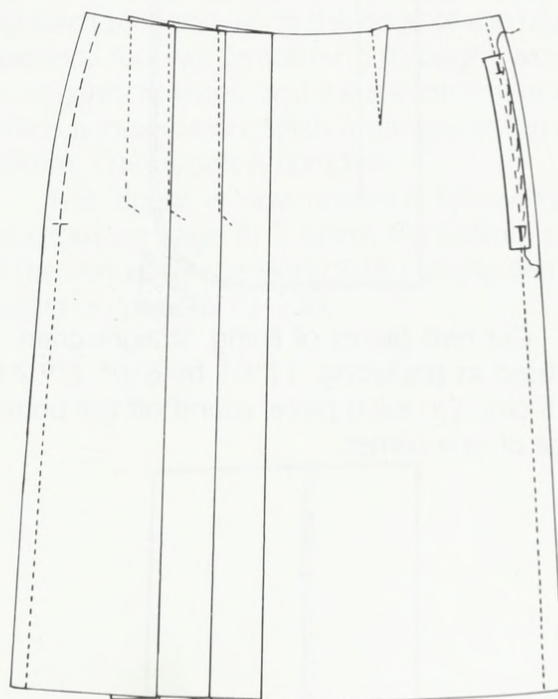

stitch the side seams, tacking well at the bottom of the zipper, and at the top and bottom of the pocket opening.

From the bottom of the zipper area to the waist, and in the pocket opening area, use a larger machine stitch. These larger stitches are placed in the zipper and pocket area only to provide an accurate foldline for pressing the seam, and will be removed shortly.

Press the side seams open.



Cut a piece of facing from garment fabric, straight grain, nap down, 2½" by 8" (6.4 by 20.3 cm).

Press a ¼" (6 mm) hem to the wrong side of the fabric along the left lengthwise edge. (If your fabric is heavyweight, overcast the edge instead of folding it, to avoid bulk.)

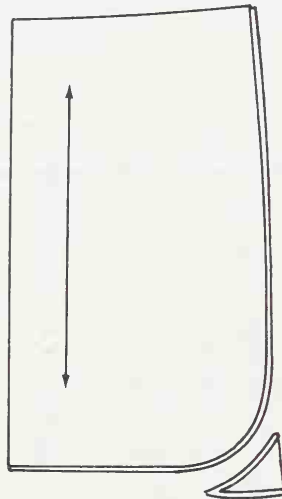

Cut two pieces of lining, straight grain, to be used as pocketing, 11½" by 6½" (29.2 by 16.5 cm). On each piece, round off the bottom edge of one corner.

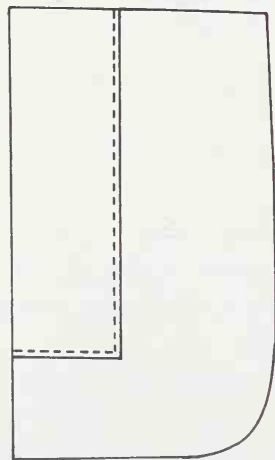

Place the raw edge of the facing along the straight edge of one of the pocketing pieces, with the curved edge of the pocketing on your right-hand side. Machine-topstitch the facing to the pocketing.

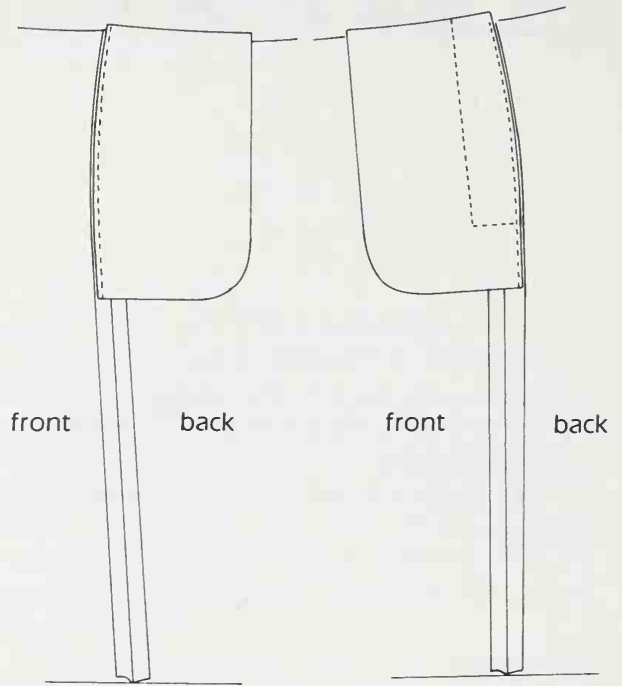

To create the pocket, machine-stitch the unfaced piece of pocketing to the front seam allowance of the skirt, and the faced piece of pocketing, facing down, to the back seam allowance. Use a ¼" (6 mm) seam.

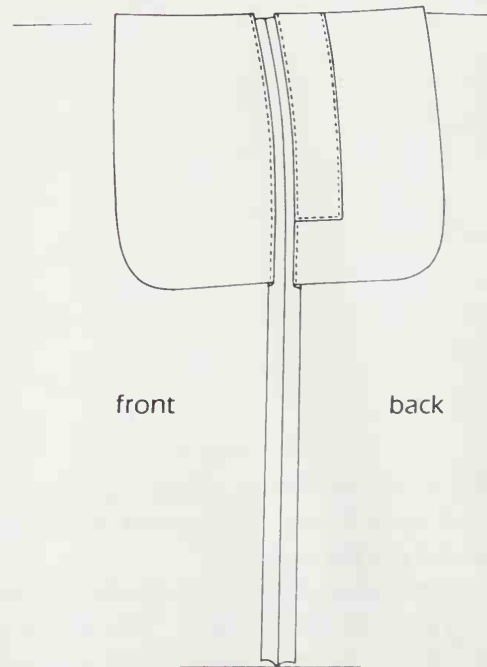

Press the pocketing back, and machine-staystitch along the folded edge of each piece of pocketing. Catch only the lining and the seam allowance. These stitches *do not* go through to the front of the fabric.

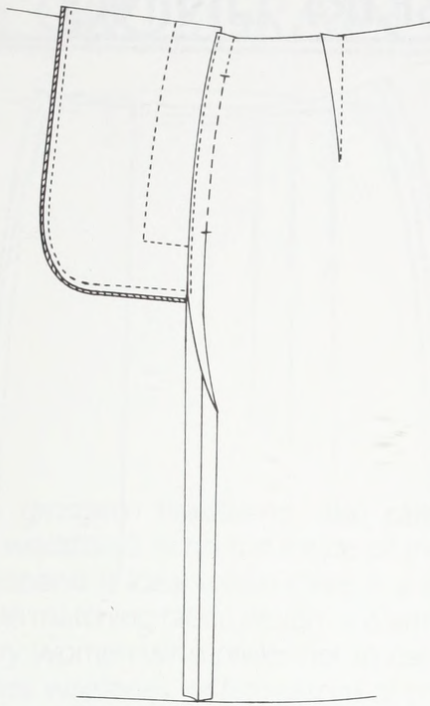

Press both pieces of pocketing toward the front of the skirt. Rather than slash the back seam allowance in order to let the pocket fall forward, simply overlap the seam allowance and press it flat.

Stitch around the outer edge of the pocketing and into the seam allowance. To prevent raveling overcast the outer edge of the pocketing by machine or by hand, or use pinking shears.

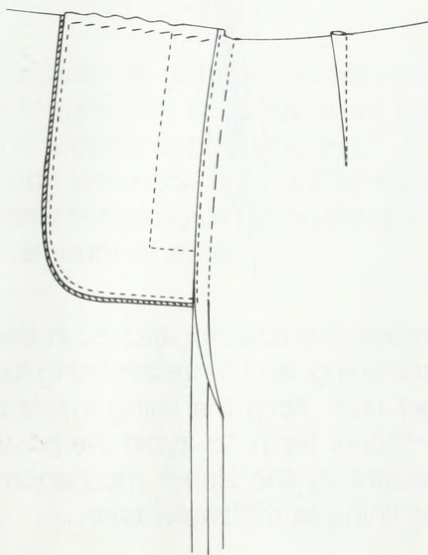

Baste the top of the pocketing across the skirt waistline, placing a small amount of ease in the pocketing.

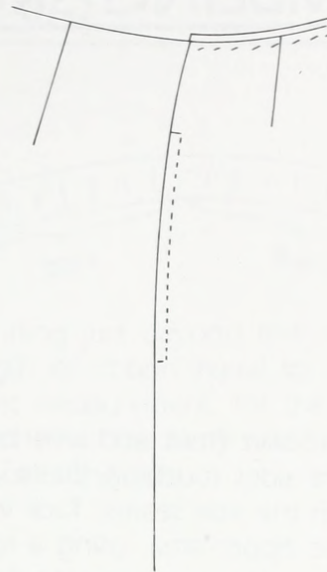

On the right side of the skirt front fabric, remove the basting at the pocket opening, and top-stitch by hand along the edge of the pocket opening. You will be stitching through two layers of garment fabric, and the reinforcement strip which is in-between. Stitch a bartack at top and bottom. The pocket is complete.

The zipper is now inserted following instructions on page 218. Finish the bottom edge of the skirt using the Hong Kong piping demonstrated on pages 219–220.

ASSEMBLING SKIRT AND SKIRT LINING

Place the skirt front and skirt back lining together, right sides touching. Baste, and then machine-stitch the side seams. Tack well at the bottom of the zipper area, using a longer machine stitch from the zipper area to the waist.

Press the side seams open.

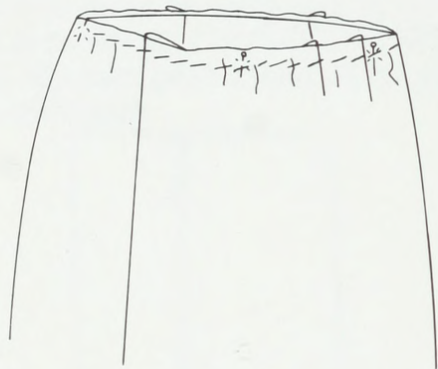
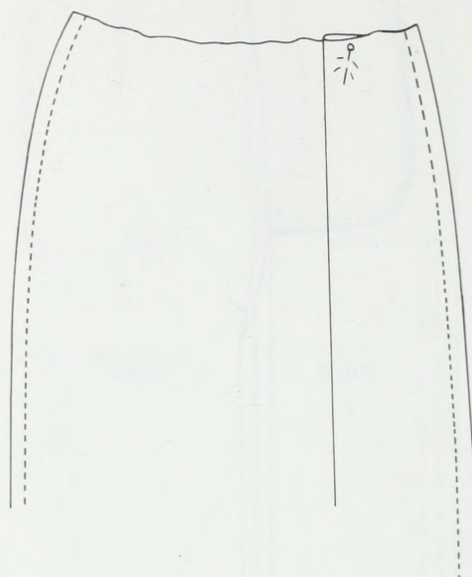

Pin the lining and skirt together at the waist, with wrong sides touching, matching the side seams and the center front and back.

The pleat which was folded into the skirt front lining should fall at the same position as the pleats on the skirt. Since there are no darts in the lining, the lining will be slightly larger than the skirt at the waist. Baste around the waistline, distributing the ease evenly by folding small, flat pleats in the lining.

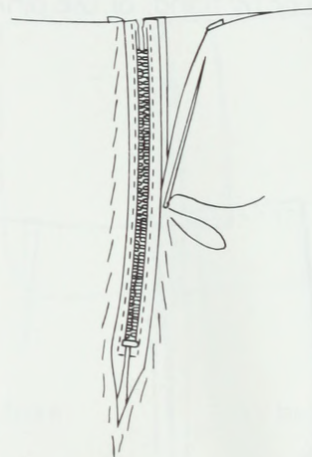

Remove the basting stitches in the zipper area of the lining, and baste the lining fold along the zipper tape. Keep the lining a safe distance from the zipper teeth, to avoid the possibility of being caught in the zipper mechanism. Back-stitch the lining to the zipper tape.

THE GROSGRAIN WAISTBAND

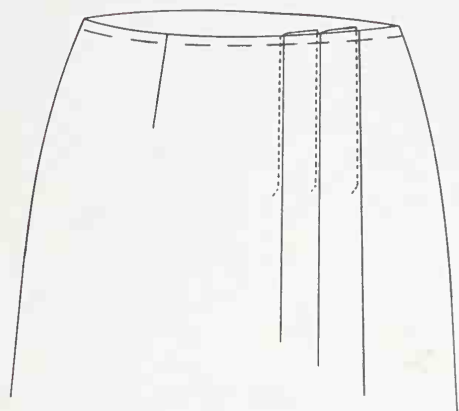

The grosgrain waistband, also called the *invisible waistband*, is on the inside of the skirt. This waistband is ideal when there is a difficult problem in matching fabric design. It is also often chosen by women who prefer not to call attention to their waistslines, or for reasons of comfort.

The measurement of the skirt at the waist stitchline should equal the body waist measurement plus 1" (2.5 cm) ease.

Chalkmark the waist stitchline at the top edge of the skirt.

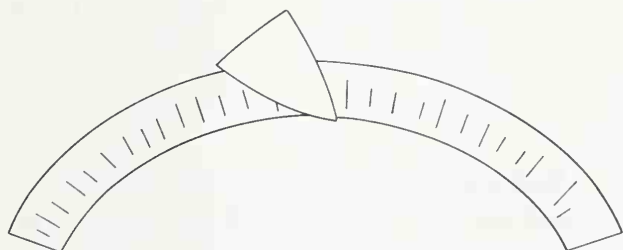

Cut a piece of grosgrain ribbon about 5" (12.7 cm) longer than the body waist measurement. We suggest ribbon about 1" (2.5 cm) wide. Ribbon wider than this will be inclined to buckle. Shape the grosgrain using the iron, and a moderate amount of steam.

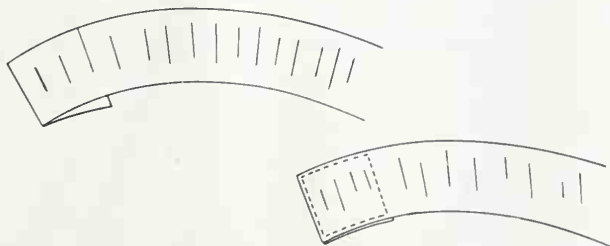

With the outer edge of the curve at the top, fold back 1" (2.5 cm) at the left end of the grosgrain. Machine-stitch the overlap of ribbon in place.

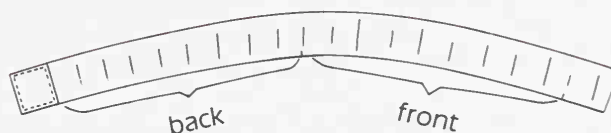

Beginning just beyond the overlap, mark off a length of ribbon equal to one half the body waist measurement, for the back of the skirt, and one half the body waist measurement for the front of the skirt.

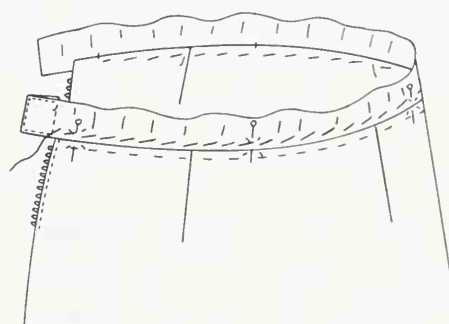

Place the inner curve of the grosgrain $\frac{1}{8}$ " (3 mm) above the waist chalkline, on the right side of the fabric. Pin the grosgrain to the skirt, matching side seams and center front and back.

Baste the grosgrain to the skirt, distributing the ease in the skirt evenly.

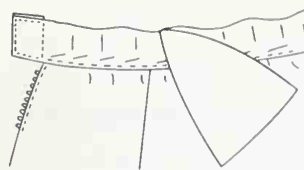

Steam press the skirt waistline on the right side of the fabric, using a ham. This pressing should eliminate any ripples in the garment fabric at the waistline, due to the fact that we have deliberately made the top of the skirt 1" (2.5 cm) larger than the waistband. It is necessary to press these ripples out before we machine-stitch the waistband to the skirt.

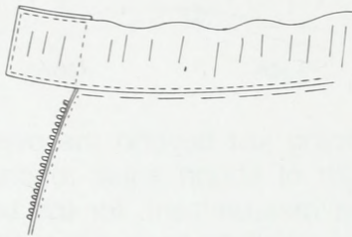

Machine-topstitch along the edge of the grosgrain, being very careful not to stretch the waistline of the skirt as you sew.

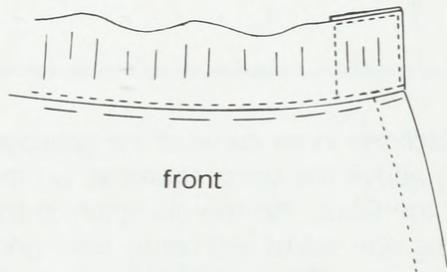

The grosgrain which extends beyond the zipper at the front of the skirt is folded in half, and then, in half again, and machine-stitched in place.

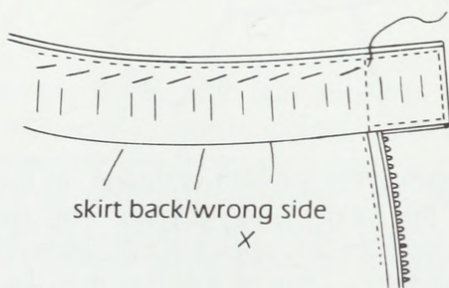

Using the waist chalkline as foldline, bring the grosgrain to the wrong side of the skirt. Baste along the top edge of the grosgrain, to hold it in place.

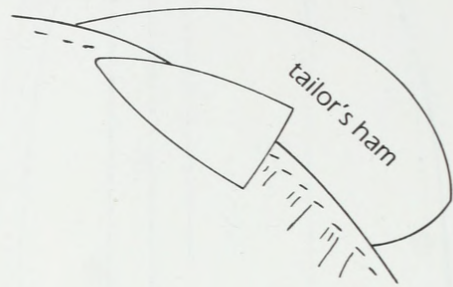

On the right side of the fabric, ripples of ease will again be visible at the top edge of the skirt. Place the waistline over a ham, and steam press the ripples away. It is essential to use a ham, in order to maintain the shape of the garment while eliminating the ripples.

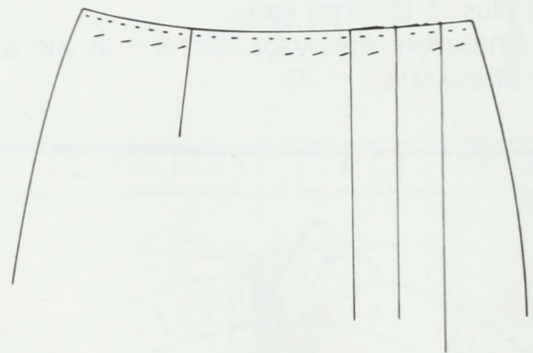

Back-stitch by hand along the top edge of the skirt on the right side of the fabric. This stitchline will keep the grosgrain in place, and will produce a firm edge at the waistline.

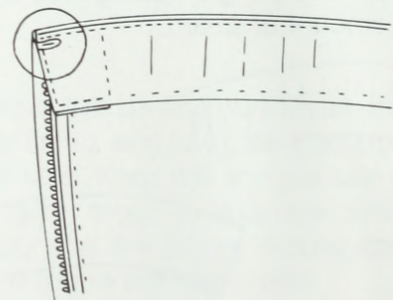

On the wrong side of the skirt front, place a small hook on the grosgrain fold at the zipper edge. Half of the hook is under the grosgrain, and half on top. Stitch the hook in place.

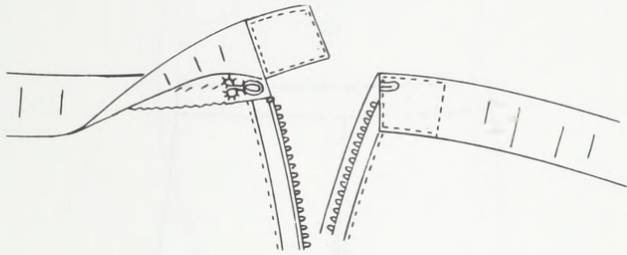

An eye is placed on the wrong side of the skirt back, underneath the grosgrain. The front end of the grosgrain is now stitched securely to the zipper tape, clear of the zipper teeth.

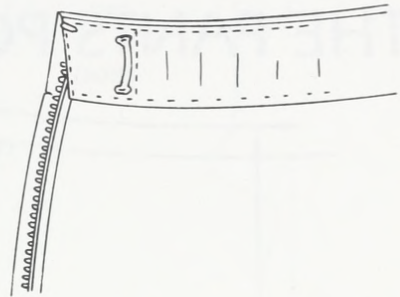
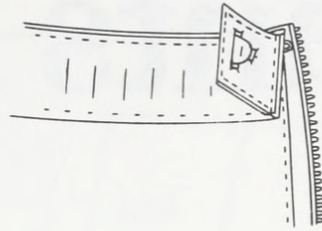

A larger, skirt hook and eye is added to the grosgrain to secure the extension. The waistband is complete.

8 Pants

THE PANTS POCKETS

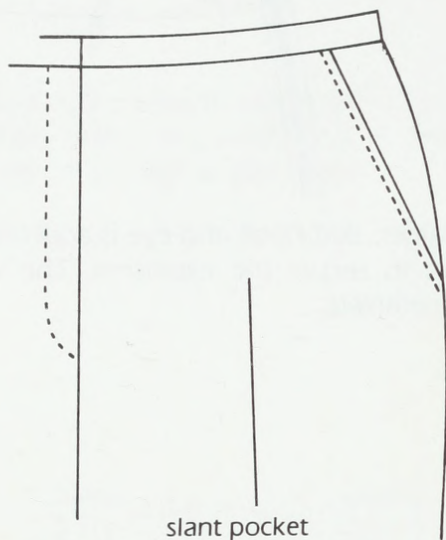

slant pocket

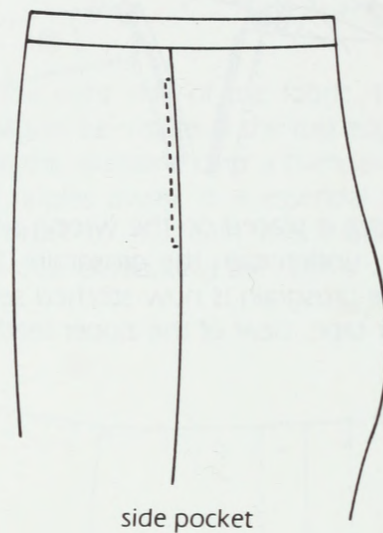

side pocket

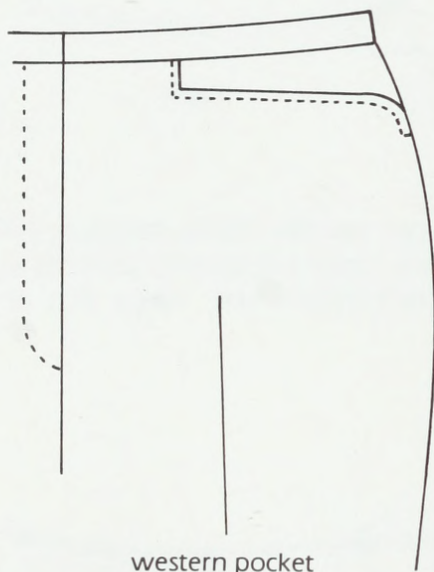

western pocket



back pocket

If, as suggested in the Pattern unit (page 11), you have chosen a pants pattern designed for side pockets, you will now be able to create any of the three basic front pockets detailed here—the *slant* pocket, the *Western* pocket or the *side* pocket.

The back pocket, shown here, is a double-piping pocket, with or without a buttonhole tab.

Patterns for all four pockets discussed here are found beginning on page 291.

THE SLANT POCKET

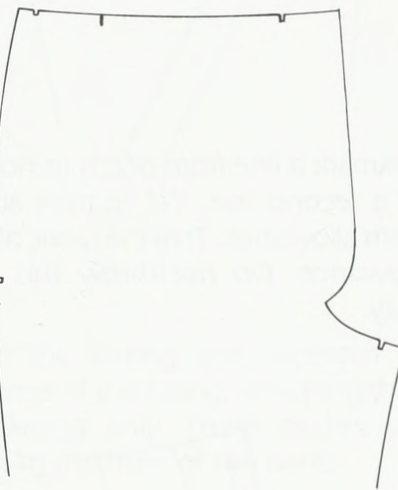
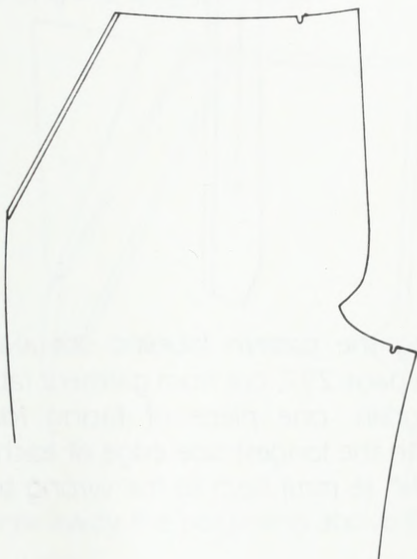
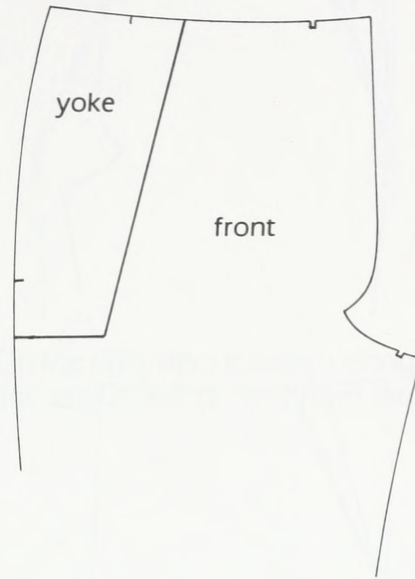
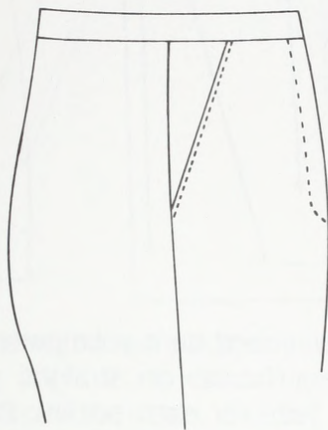

If your pattern is designed for slant pockets, the pants front pattern has probably been cut on the diagonal at the top of the side seam.

If you would like to put slant pockets in trousers which have been designed for side pockets, you can adjust your pattern by using the *SLANT YOKE* pattern on page 295.

Place the *slant yoke* on the pants front fabric, at the top of the side seam. Chalkmark the notches at the waist and side seam, and remove the pattern. The pattern assumes a pants side seam allowance of $\frac{5}{8}$ " (1.9 cm).

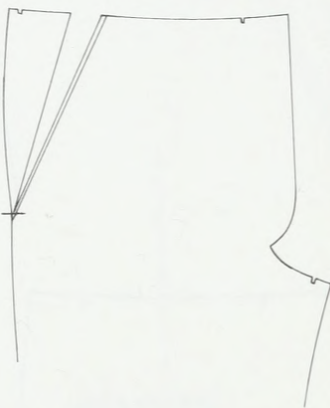
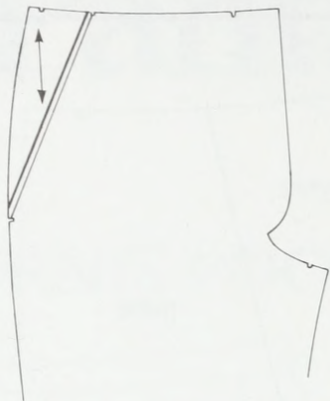

Chalkmark a line from notch to notch, and then add a second line, $\frac{1}{4}$ " (6 mm) above the first as seam allowance. Trim the fabric above the seam allowance. *Do not* throw this trimmed piece away.



Pin the trimmed piece of fabric to the slant yoke pattern, aligning the fabric to the notches on the yoke.

The side edge of the fabric will most likely be different from the side edge of the yoke pattern. If the pants pattern fits you, the fabric edge will coincide more closely to the contour of your body. Therefore, use this revised version of the yoke as you continue to work.

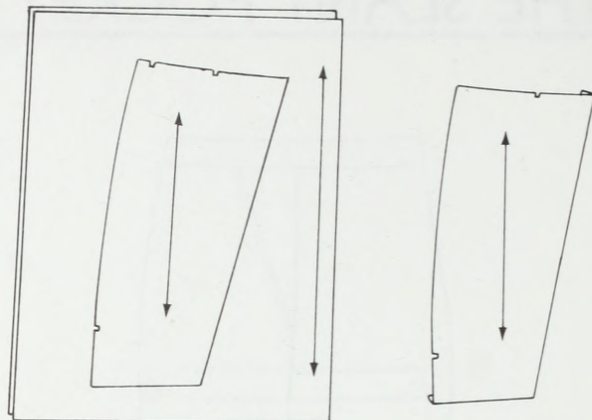

Use the revised slant yoke pattern and cut from garment fabric, on straight grain, nap down, one yoke for each pocket. Press to the wrong side of the fabric $\frac{1}{4}$ " (6 mm) hems at the bottom of the yoke and at the unnotched side.



Using the pattern labelled *SIDE AND SLANT FACING* on page 297, cut from garment fabric, on straight grain, one piece of facing for each pocket. On the longest side edge of each piece, press a $\frac{1}{4}$ " (6 mm) hem to the wrong side.

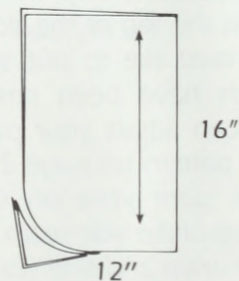

Cut one piece of pocketing for each pocket, 16" (40.6 cm) wide and 12" (30.5 cm) long, on straight grain. Fold the pocketing in half and trim the bottom outer corners to a curve.

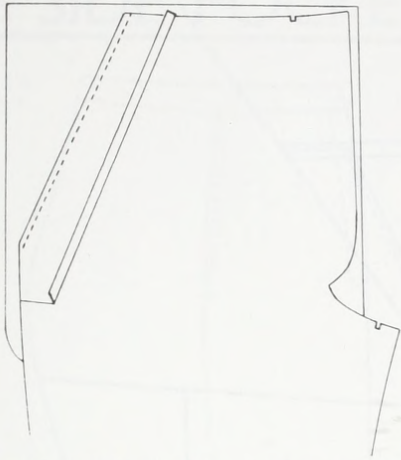

Place one piece of pocketing on the wrong side of the pants front, extending $\frac{1}{4}$ " (6 mm) above the top of the pants, and $\frac{5}{8}$ " (1.6 cm) out at the side seam. Place the facing right side down on the pants front, the unfolded edge of the facing flush with the diagonal cut at the top of the pants. Machine-stitch the facing, pants, and pocketing together, using a $\frac{1}{4}$ " (6 mm) seam along the diagonal edge.

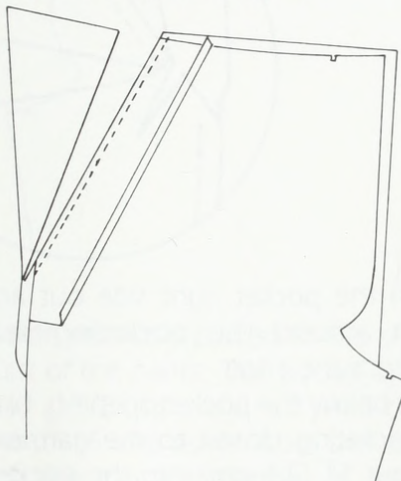

Trim away the pocketing above the facing.

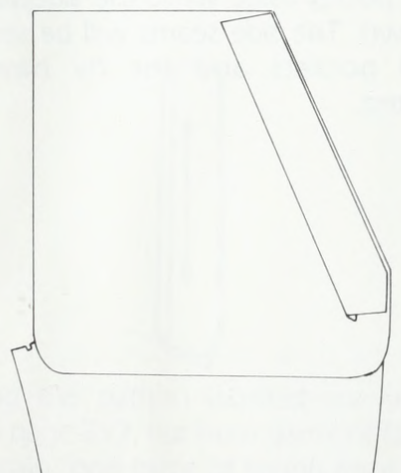

Bring the facing and the facing seam to the wrong side of the pants, and press in place.

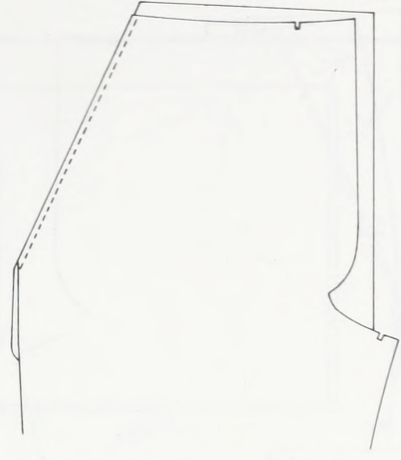

On the right side, topstitch along the diagonal edge about $\frac{1}{4}$ " (6 mm) from the fold.

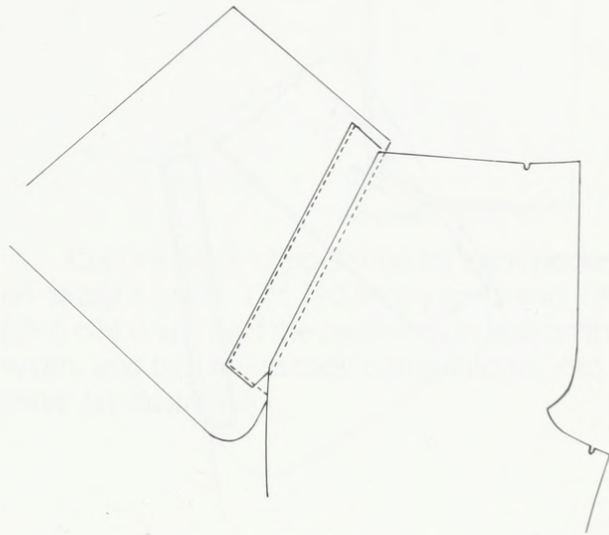

On the wrong side, topstitch along the folded edge of the facing, attaching the facing to the pocketing only. These stitches do not go through to the front of the pants.

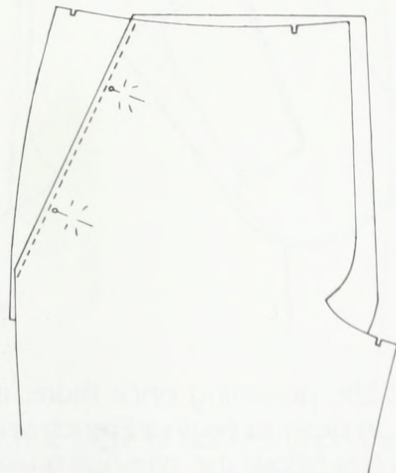

Place the yoke, notch to notch, at the top of the pants side seam, and pin it in place.

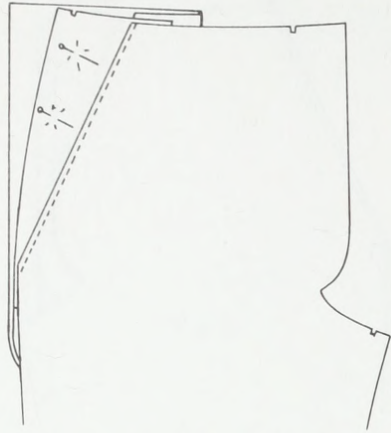

Fold the pocketing in half, matching the curved edges. Pin the yoke to the pocketing.



Open out the pocketing and topstitch the yoke to the pocketing.

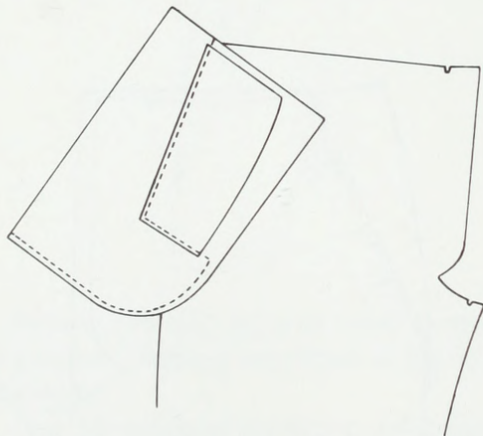

Fold the pocketing once more, inside out this time, in order to begin a French seam. Begin $\frac{1}{2}$ " (1.3 cm) below the side notch using a $\frac{3}{8}$ " (1 cm) seam, and taper the seam to $\frac{1}{8}$ " (3 mm) at the curve and across the bottom of the jacket.

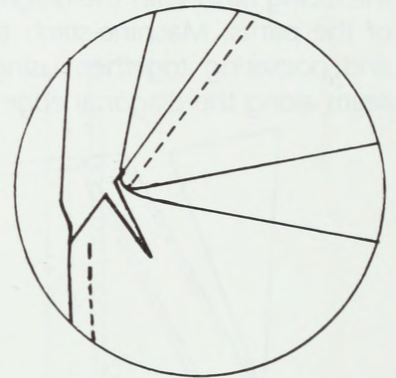
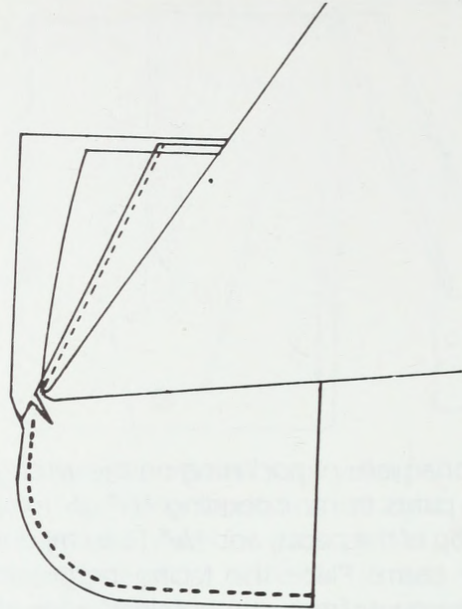

Turn the pocket right side out and press. Topstitch around the pocketing seam $\frac{1}{4}$ " (6 mm) from the edge.

Just below the pocket opening, on the side of the pocketing closest to the garment fabric, slash about 1" (2.5 cm) into the pocketing and facing. This slash will eventually enable you to hold the pocket aside while the side seams are being sewn. The side seams will be sewn only after all pockets and the fly have been constructed.

THE SIDE POCKET

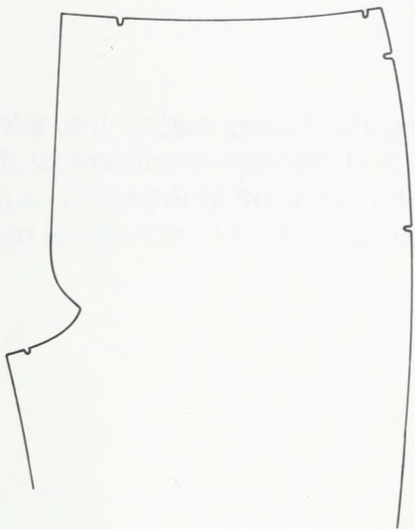

The side pocket is placed in the side seam on the front of the pants. The pocket opening is between 6" (15.2 cm) and 6½" (16.5 cm) long, and begins 2" (5 cm) down from the top edge.

Notch the top and bottom of the pocket opening. The notches should be no deeper than ¼" (3 mm).



Using the pattern labelled *SIDE AND SLANT FACING* on page 297, cut from garment fabric, on straight grain, one piece of facing for each side pocket. On the longest edge of each piece, press a ¼" (6 mm) hem to the wrong side.

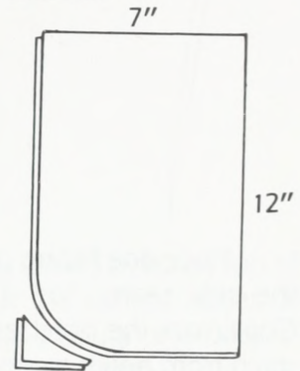
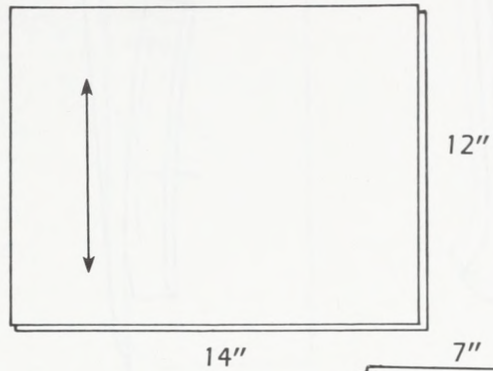

Cut one piece of pocketing for each pocket, on straight grain, 12" (30.5 cm) long and 14" (35.6 cm) wide. Fold the pocketing in half on the width, and trim the outside bottom edges into a curve (as illustrated).

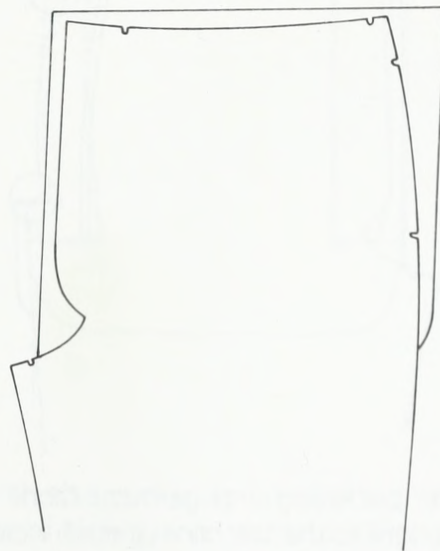

Place one piece of pocketing on the wrong side of the trouser front, allowing ⅝" (1.6 cm) pocketing to extend beyond the lower notch, and ⅜" (1 cm) at the center of the waistline.

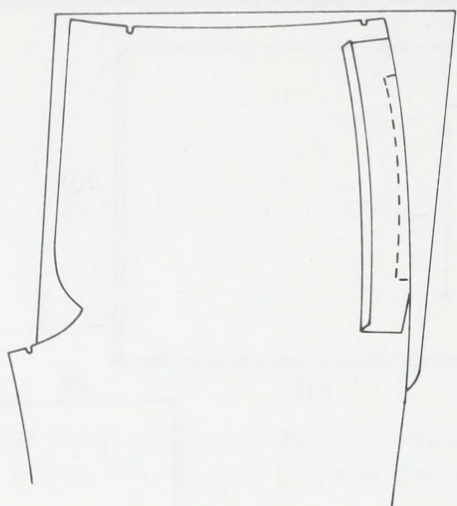

Place one facing piece face down on top of the side seam, $\frac{1}{2}$ " (1.3 cm) below the top. Chalkmark the notches on the facing. Machine-stitch from notch to notch, using a $\frac{5}{8}$ " (1.6 cm) seam allowance at the top and bottom of the pocket opening, tapering to a $\frac{3}{8}$ " (1 cm) seam allowance at the center. Tack well at the top and bottom of the stitchline.

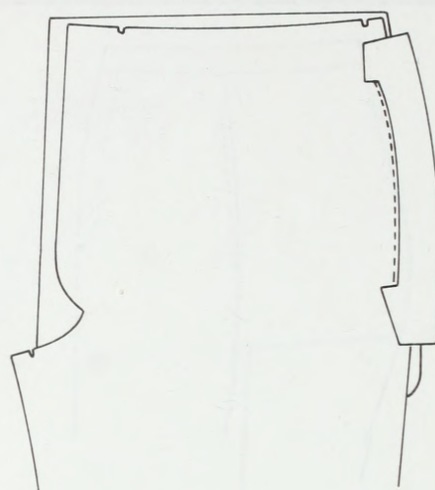

Bring the facing out to the side of the trousers, and topstitch the facing to the seam allowance, *very close to the seam*.

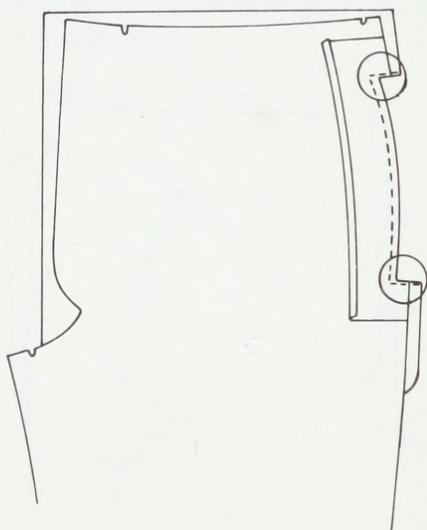

The pocketing and garment fabric is now slashed right to the stitchline at each notch. The excess fabric is trimmed away, leaving a $\frac{1}{4}$ " (6 mm) seam allowance along the stitchline.

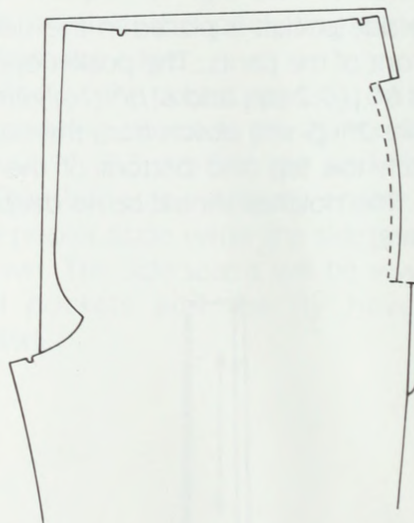

Bring the facing to the wrong side of the pants front. The facing seam should also be drawn to the edge of the wrong side, so that it is not visible from the front. On the right side, topstitch along the pocket opening, $\frac{1}{4}$ " (6 mm) from the edge. Tack well at the top and bottom.

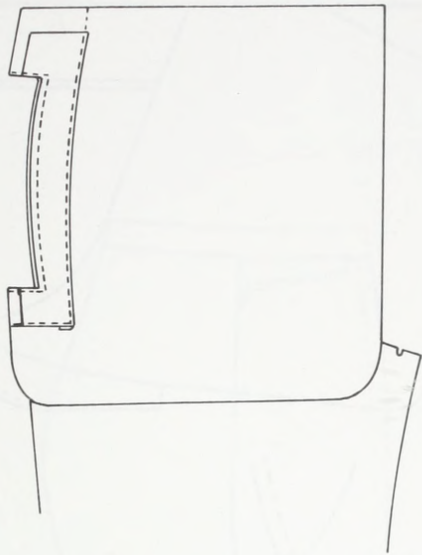

On the wrong side, the folded edge of the facing is topstitched to the pocketing. Catch the pocketing and facing only. These stitches *do not* go through to the right side of the pants.

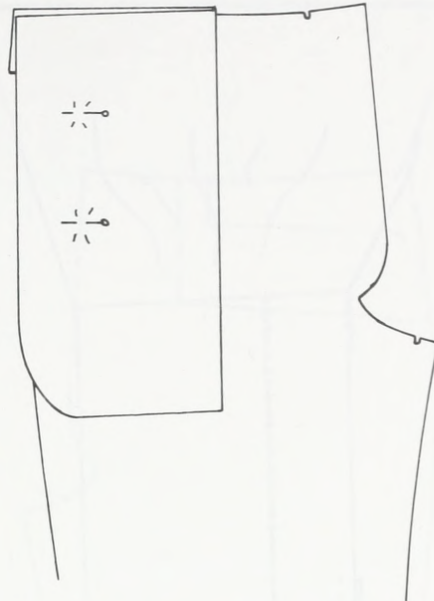

The pocketing is now folded over, on top of the facing. Make sure that the curved edges of the pocketing are even. Pin through the pocketing and catch the facing underneath.

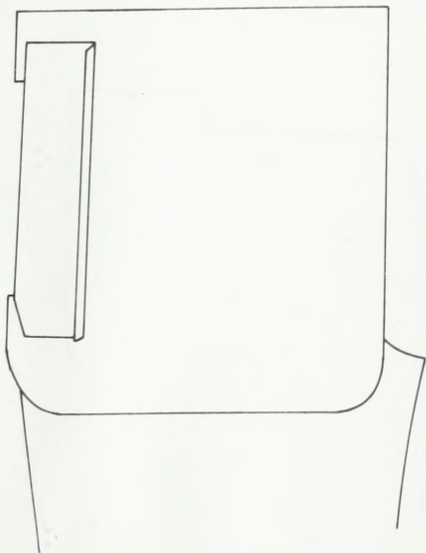

Place the second facing piece, face down on top of the first, matching edges at the top and bottom. The folded edge should be facing up.

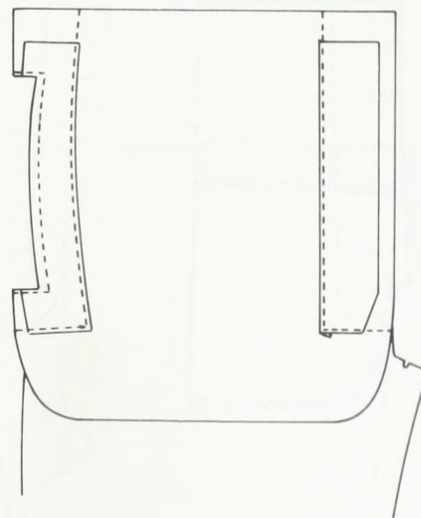

With the pocketing opened out, topstitch the second facing piece to the pocketing.

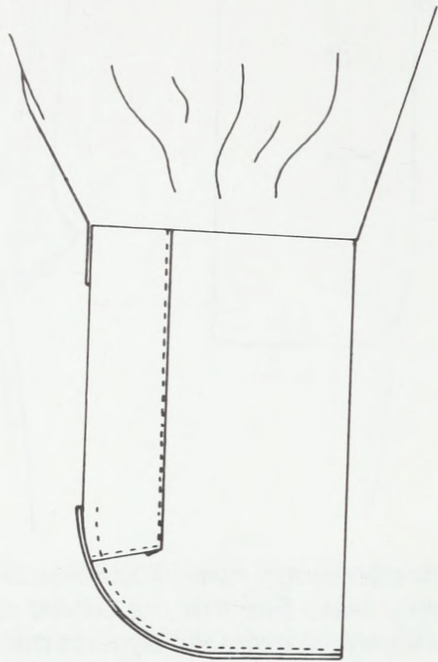

The pocketing is again folded, this time inside out, in order to begin a French seam. Pull the trouser leg up and out of your way. Begin with a $\frac{3}{8}$ " (1 cm) seam at the bottom of the pocket opening, and taper to $\frac{1}{8}$ " (3 mm) as you stitch around the curve and across the bottom of the pocketing.

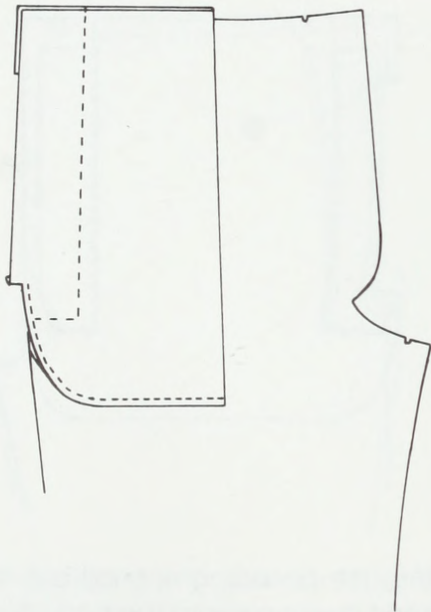

Turn the pocketing and press. Topstitch around the bottom of the pocketing again, $\frac{1}{4}$ " (6 mm) from the edge to complete the French seam.

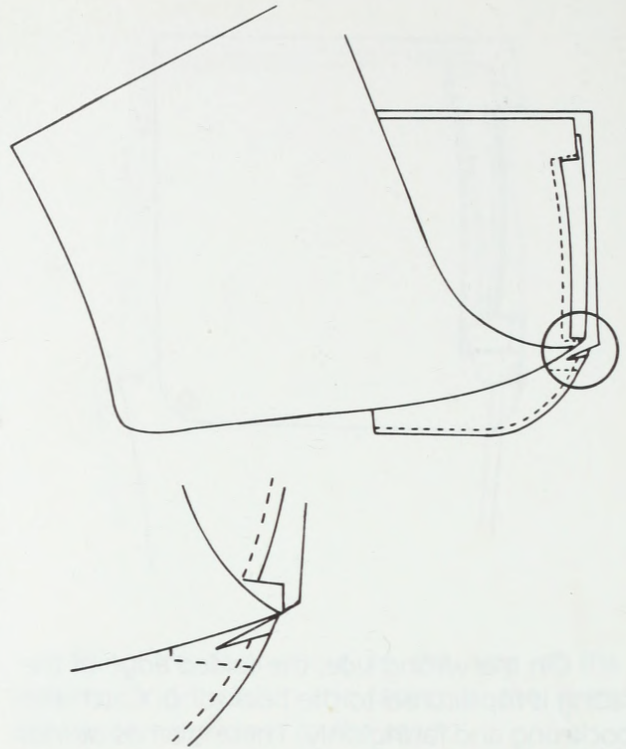

Just below the pocket opening, on the side of the pocketing closest to the garment fabric, slash about 1" (2.5 cm) into the pocketing and the facing. This slash will eventually enable you to hold the pocket aside as the side seam is being sewn. The pocketing is *not* to be caught in the side seam.

The side seam will be sewn only after all the pockets and the fly have been constructed.

THE WESTERN POCKET

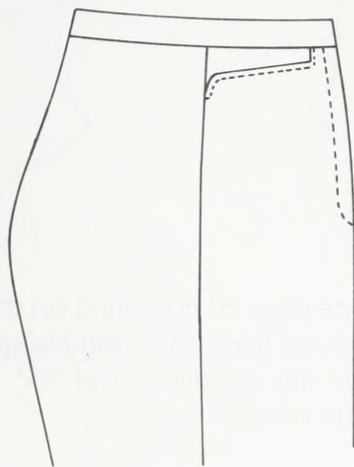

The western pants pocket opens at the top of the trousers, just below the waistband.

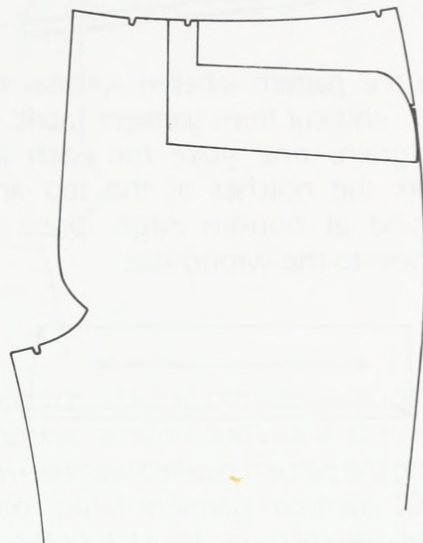

If, however, you would like to put a western pocket on a pair of pants which was designed for a side pocket, use the pattern marked WESTERN SHAPER on page 293. Place the pattern on the front of the trousers, and chalkmark the notches at the waistline and side cutting edges. Chalkmark, also, along top edge of the pattern.

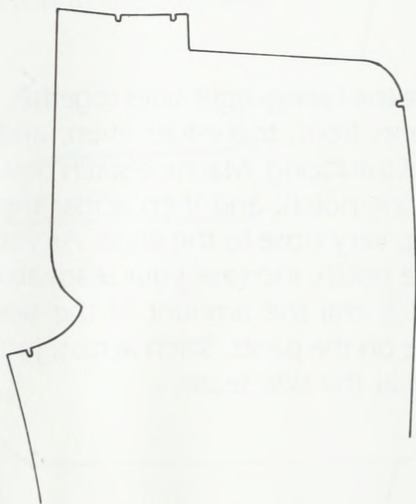

If your pants pattern was designed for a western pocket, the top edge of the trousers will most likely have been cut away (as illustrated).

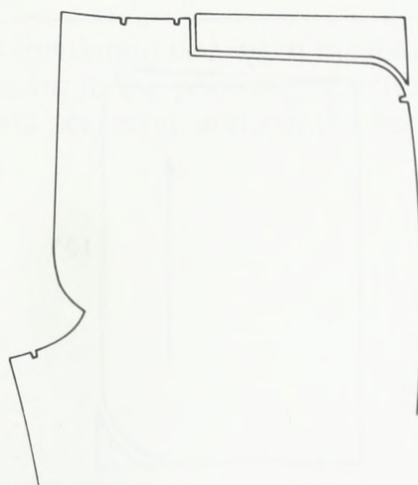

Remove the pattern and trim away the top of the pants, cutting along the chalk guideline.

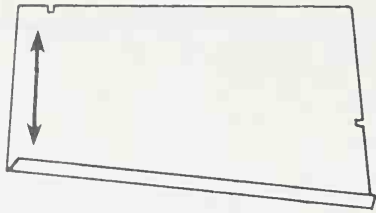

Use the pattern labelled WESTERN YOKE on page 291, and cut from garment fabric, on the straight grain, one yoke for each pocket. Chalkmark the notches at the top and side edges; and at bottom edge, press a $\frac{1}{4}$ " (6 mm) hem to the wrong side.

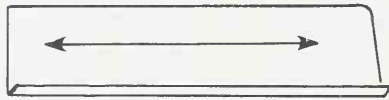

Using the pattern labelled WESTERN FACING ON page 293, cut from garment fabric, on cross-grain, one piece of facing for each pocket. At the longest edge, press a $\frac{1}{4}$ " (6 mm) hem to the wrong side.

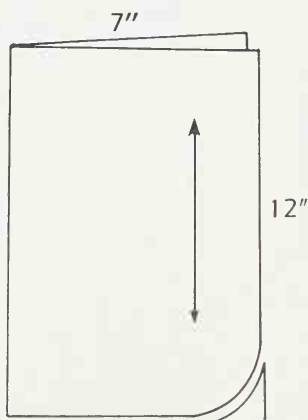
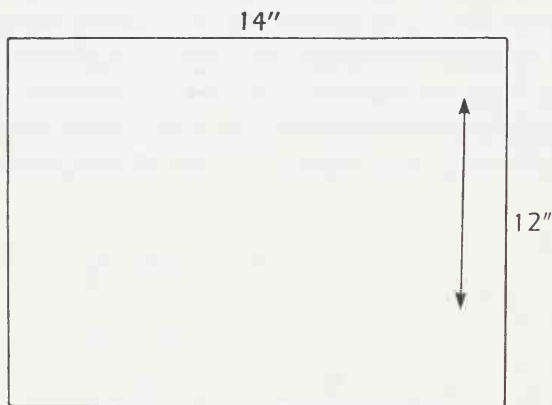

From pocketing material, 12" (30.5 cm) by 14" (35.6 cm), on the straight grain, cut one piece for each pocket.

Fold the pocketing on the width and trim the outer bottom edges into a curve.

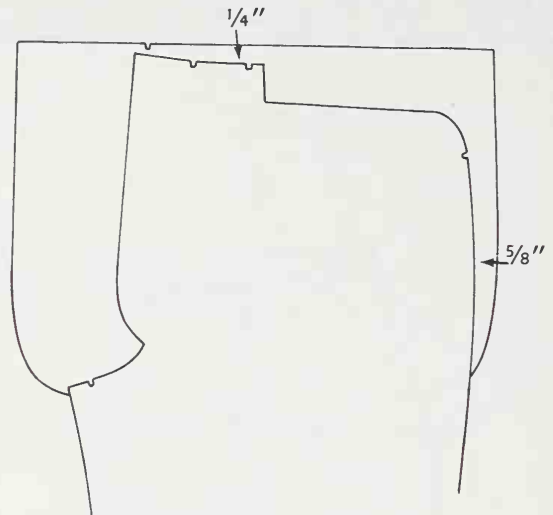

Place one piece of pocketing on the wrong side of the trouser front, allowing $\frac{1}{4}$ " (6 mm) to extend above the waistline, and $\frac{5}{8}$ " (1.6 cm) out at the side notch.

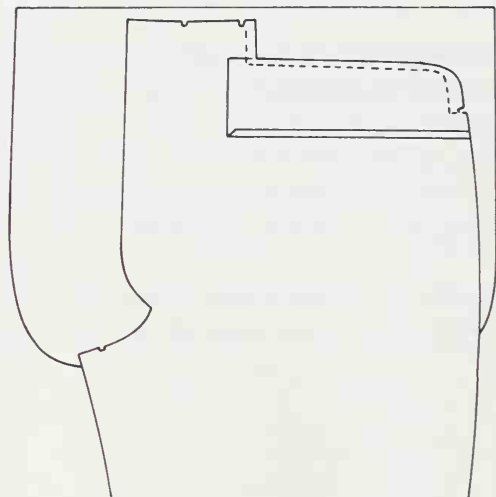

Place the facing, right sides together, on top of the pants front, top edges even, and notch the side of the facing. Machine-stitch down from the waistline notch, and then across the top of the facing, very close to the edge. As you curve to the side notch, increase your seam allowance to $\frac{5}{8}$ " (1.6 cm) the amount of the side seam allowance on the pants. Stitch across, just below the notch at the side seam.

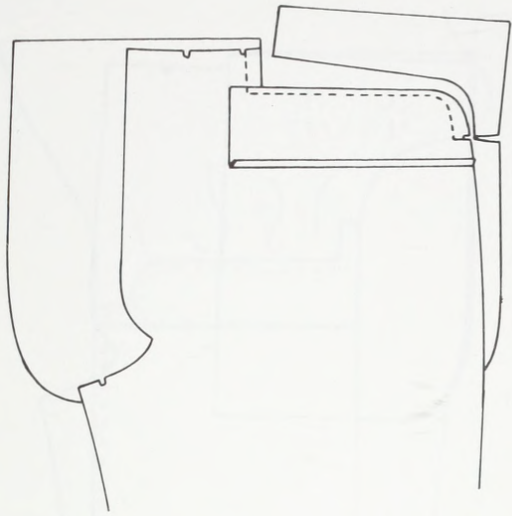

Trim away the pocketing at the top of the trousers.

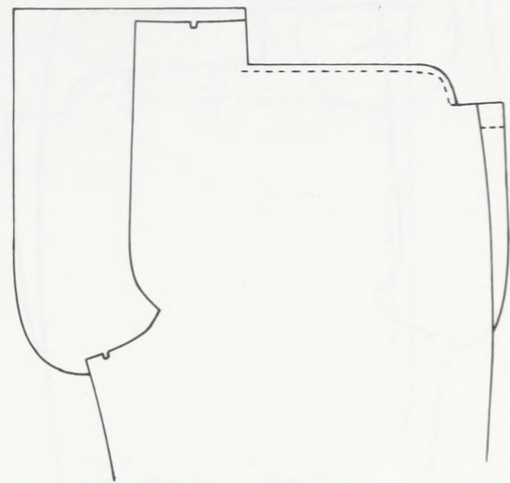

Topstitch a $\frac{1}{4}$ " (6 mm) seam across the top of the pocket, around and out at the notch.

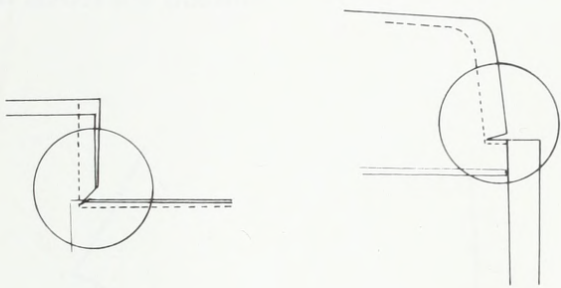

At the top of the facing, and at the side notch, slash to the stitchline.

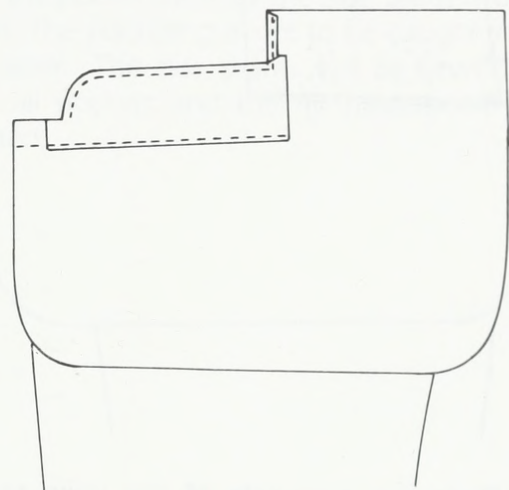

On the wrong side, stitch the folded edge of the facing to the pocketing. Catch only the facing and pocketing, and *not* the front of the trousers.

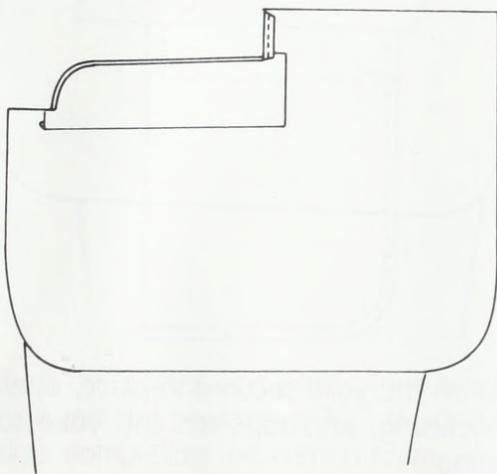

Turn the facing to the wrong side and press in place, so that the facing seamline is not visible from the right side of the fabric.

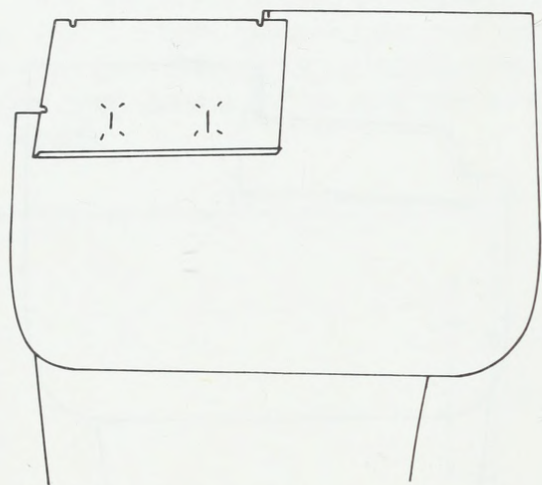
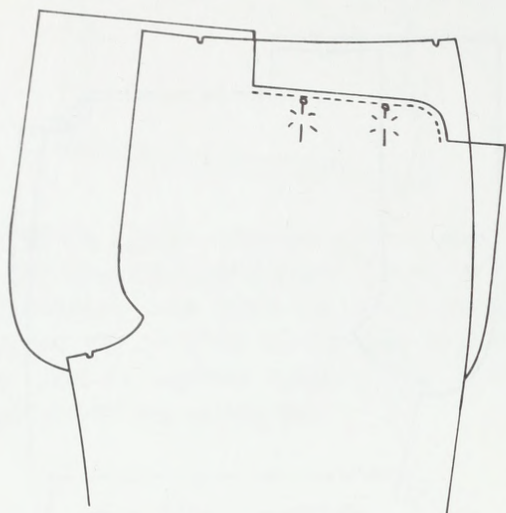

Place the right side of the yoke to the wrong side of the pants front, notch to notch, and pin the yoke in place. The folded hem at the bottom of the yoke should be visible from the wrong side.

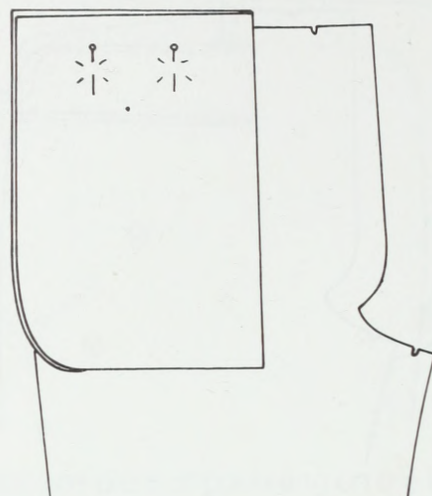

Fold the pocketing on top of the yoke, matching the curves at the bottom edges of the pocketing. Pin through the top layer of pocketing to catch the yoke underneath.

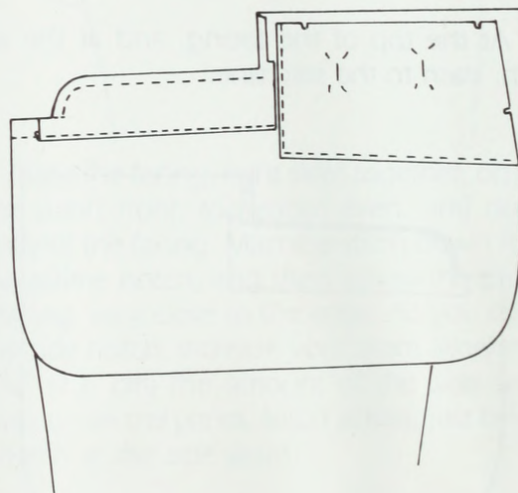

With the yoke secured in place, open out the pocketing, and topstitch the yoke to the pocketing.

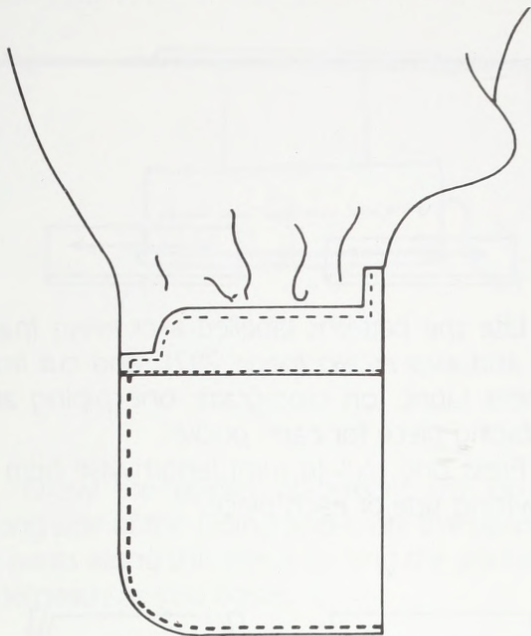

Fold the pocketing once more, this time, inside out, in order to begin a French seam. Begin a $\frac{3}{8}$ " (1 cm) seam at the side of the pocket, and taper to $\frac{1}{8}$ " (3 mm) at the curve and across the bottom.

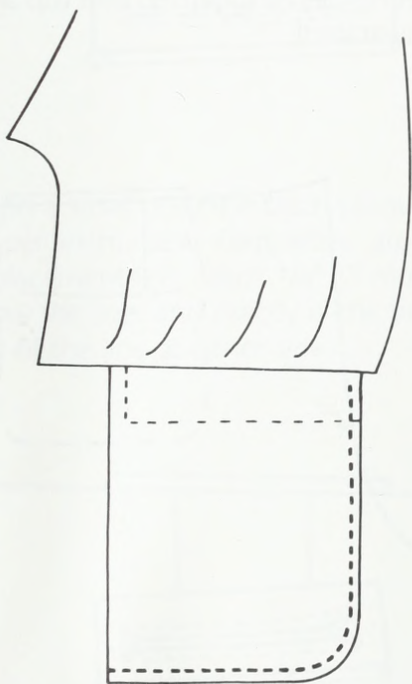

Turn the pocket and press. Topstitch once more around the pocketing, $\frac{1}{4}$ " (6 mm) from the edge, completing the French seam.

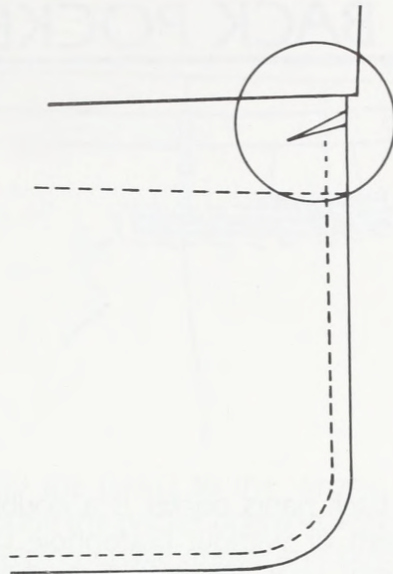

Just below the pocket opening, on the side of the pocketing closest to the garment fabric, slash about 1" (2.5 cm) into the pocketing and facing. This slash will eventually enable you to hold the pocket aside as the side seam is being sewn. The pocketing is not to be caught in the side seam. The side seams will be sewn only after all pockets and the fly have been constructed.

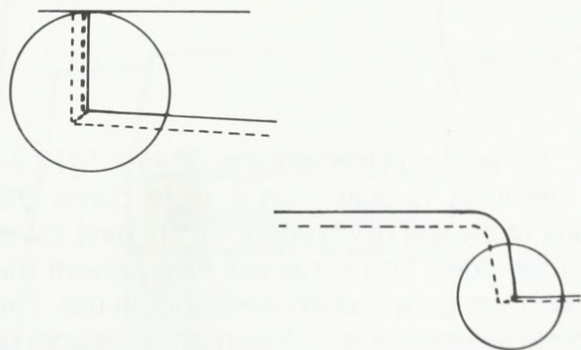

On the right side of the pocket, topstitch two vertical rows of stitching attaching the yoke to the pants front. Tack one diagonal row of stitching at the bottom of these stitchlines.

At the side notch, topstitch the pants front into the pocketing, using one diagonal row of stitching. The western pocket is complete.

THE BACK POCKET

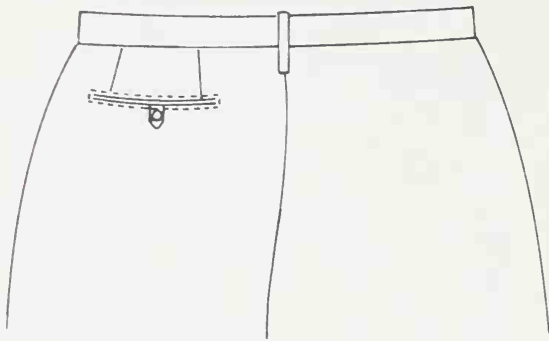

The back pants pocket is a double-piping pocket, with or without buttonhole tab, constructed somewhat differently from the double-piping pocket for jackets.

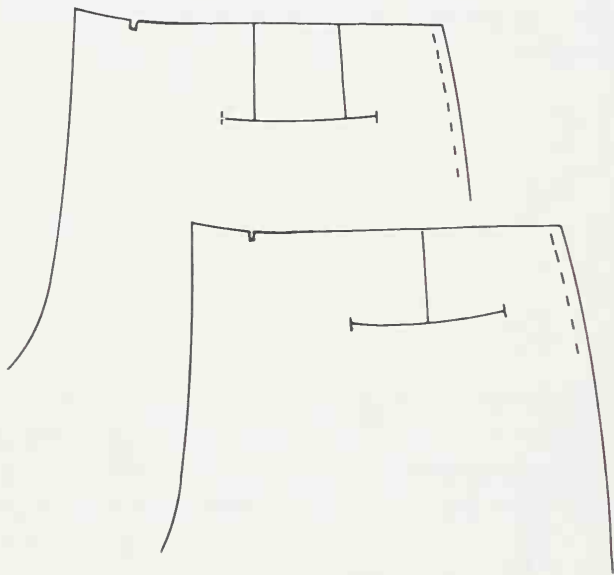

The pocket placement line, 5"–5½" (12.7–14 cm) long, is drawn on a slight curve, the center of the line being about ⅛" (3 mm) lower than the sides. This curve will help prevent the pocket from gaping open when not in use. The pocket placement line is drawn at the bottom of the darts, and 2" (5 cm) from the side stitchline. Check the length of the darts. If they are longer than 3½" (8.9 cm), the pocket will be too low, and you will end up sitting on whatever you keep in the back pocket. Simply shorten the darts to 3½" (8.9 cm) to avoid the possibility of this discomfort.

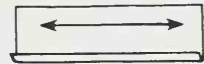

Use the patterns labelled BACK PIPING (page 295) and BACK FACING (page 297), and cut from garment fabric, on crossgrain, one piping and one facing piece for each pocket.

Press one ¼" (6 mm) lengthwise hem to the wrong side of each piece.

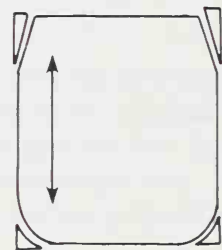
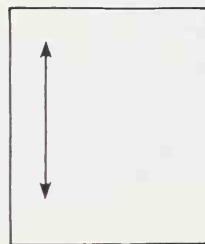

From pocketing material, cut two pieces, 8" (20.3 cm) by 7" (17.8 cm), straight grain. With the pocketing pieces together, trim top and bottom (as illustrated).

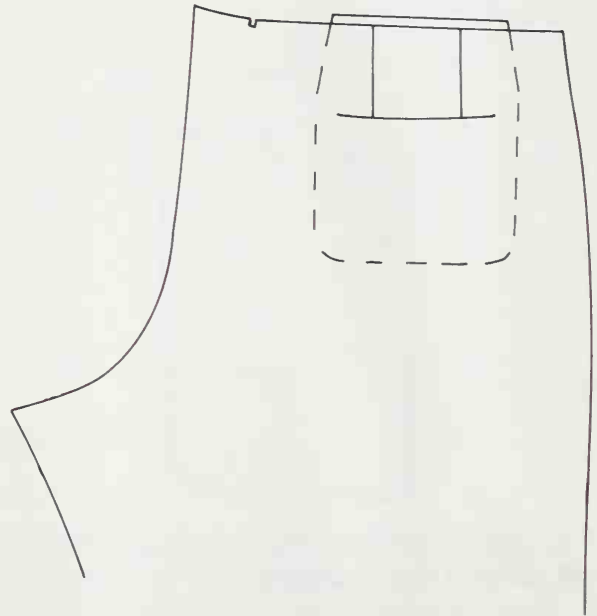

Place one piece of pocketing on the wrong side of the pants back, allowing ¼" (6 mm) of pocketing to show above the pants at the center of the pocket.

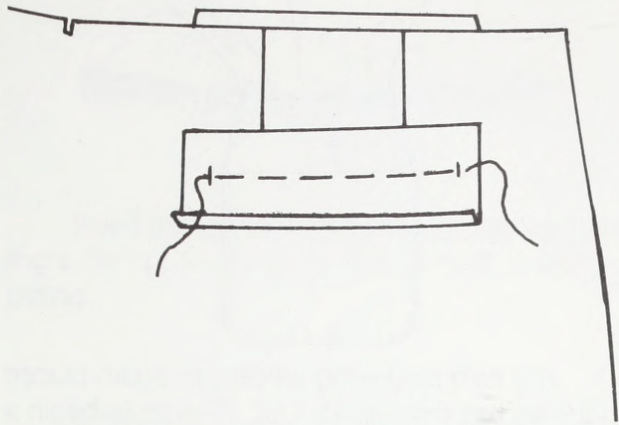

Draw the pocket placement line on the wrong side of the piping and baste the piping to the pants along this line, catching the pocketing underneath as you baste.

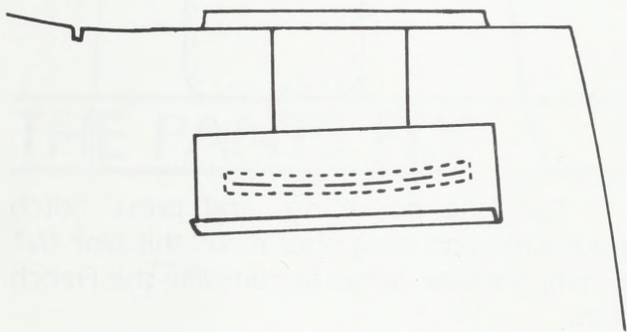

Using a small machine-stitch (about sixteen stitches per inch), sew completely around the pocket placement line. Stitch $\frac{1}{8}$ " (3 mm) above and below the line, and exactly at the beginning and end of the line at either side.

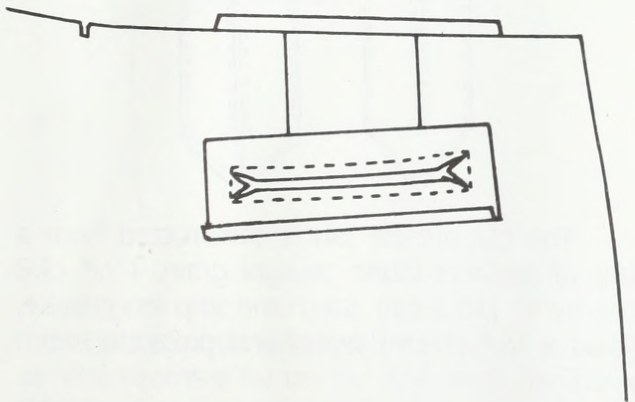

Slash through the center of the stitchlines, and cut $\frac{3}{8}$ " (1 cm) prongs at either end.

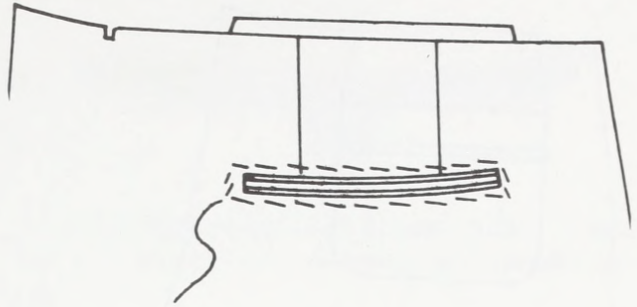

Draw the piping to the wrong side, and baste around the pocket opening, leaving a thin edge of piping visible above and below. Steam press the pocket from the right side.

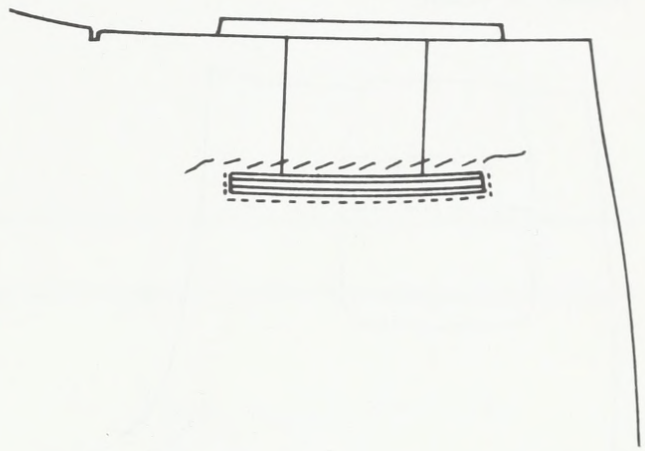

Machine-stitch on the right side of the trousers, very close to the sides and bottom edge of the piping.

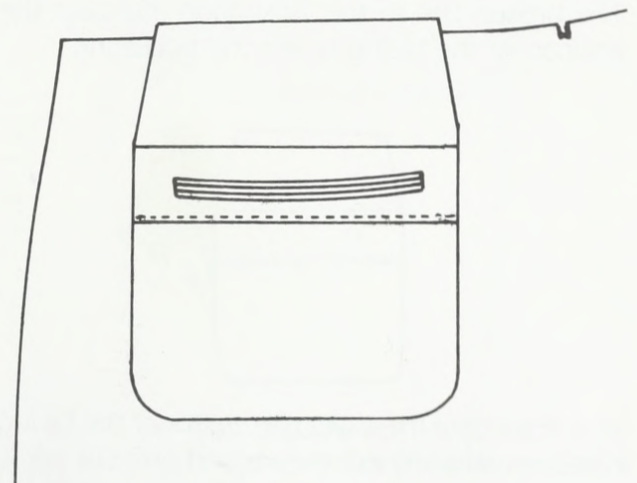

On the wrong side, machine topstitch the folded edge of the piping to the pocketing.

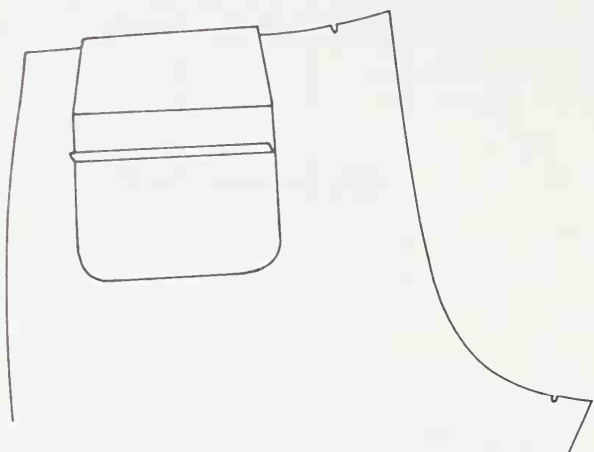

On the inside of the pants, place the facing right side down, and center it on top of the pocket opening. The folded edge on the facing should be visible.

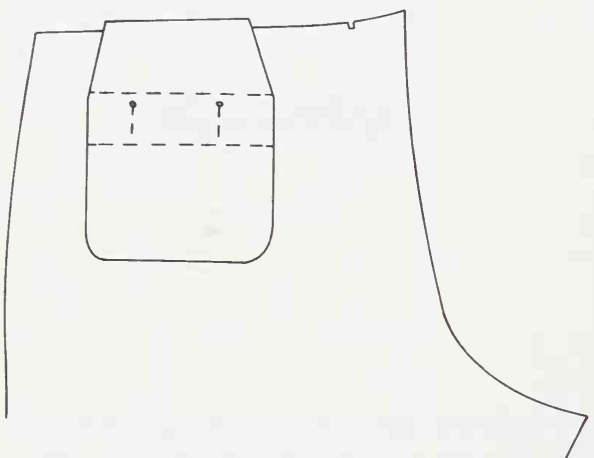

Place the second piece of pocketing on top of the first, matching the edges. Pin through the second piece of pocketing and catch the facing. The broken line in this illustration indicates the position of the facing under the pocketing.

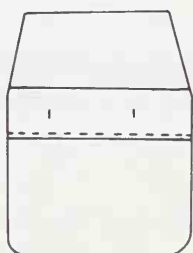

Now that the exact placement of the facing has been determined, the second piece of pocketing is removed, so that the facing can be machine-stitched to it. Topstitch across the bottom edge of the facing, along the folded edge.

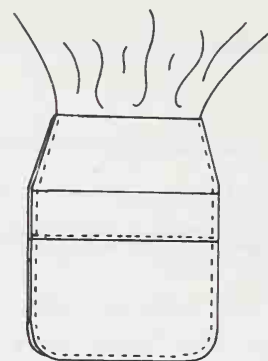

The two pocketing pieces are again placed together, this time, inside out, in order to begin a French seam. The trouser leg will have to be pulled up and out of your way. Stitch around the pocket using a $\frac{1}{8}$ " (3 mm) seam.

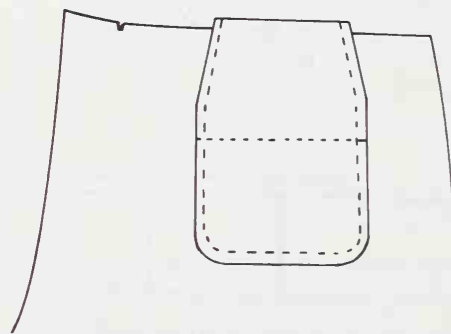

Turn the pocketing, and press. Stitch around the pocketing once more, this time $\frac{1}{4}$ " (6 mm) from the edge, to complete the French seam.

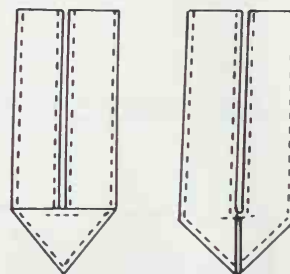
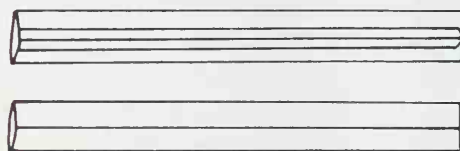

The buttonhole tab is constructed from a strip of garment fabric, straight grain, $1\frac{1}{2}$ " (3.8 cm) by 4" (10.2 cm). Stitch the strip lengthwise, using a $\frac{3}{8}$ " (1 cm) seam, and press the seam open.

Turn the strip to the right side, and press the seam to the center. The strip is now folded into an arrow shape and topstitched (as illustrated).

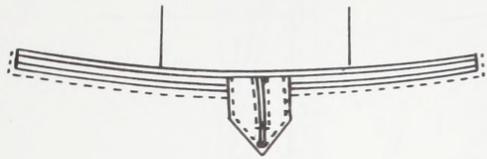

Insert the tab into the pocket opening, leaving a $\frac{5}{8}$ " (1.6 cm) slit in the tab below the top piping.

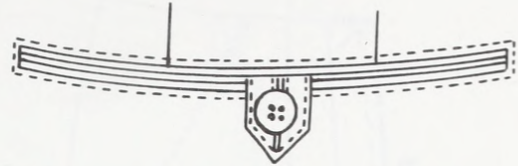

To complete the back trouser pocket, sew a $\frac{1}{2}$ " (1.3 cm) button just below the bottom piping.

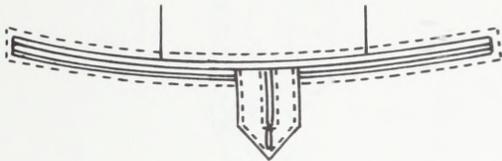

Topstitch at the sides and across the top of the pocket, very close to the piping.

THE PANTS FLY

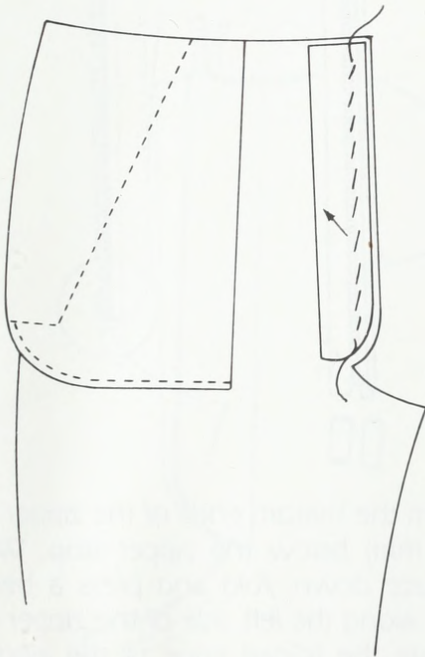

Cut two bias strips of pocketing to be used as reinforcement for the fly. The strips should be wide enough to extend $\frac{1}{2}$ " (1.3 cm) beyond the fly foldline, and long enough to extend from the waist to the bottom of the fly.

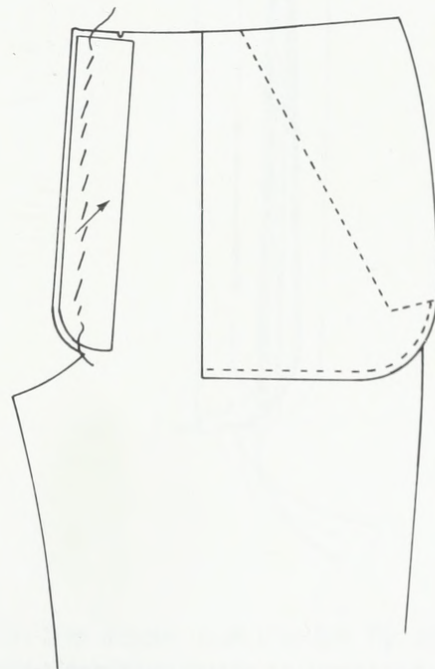

Trim the bias strips to the shape of the fly extension, and baste them to the wrong side of each fly, $\frac{1}{4}$ " (6 mm) from the edge of the garment fabric.

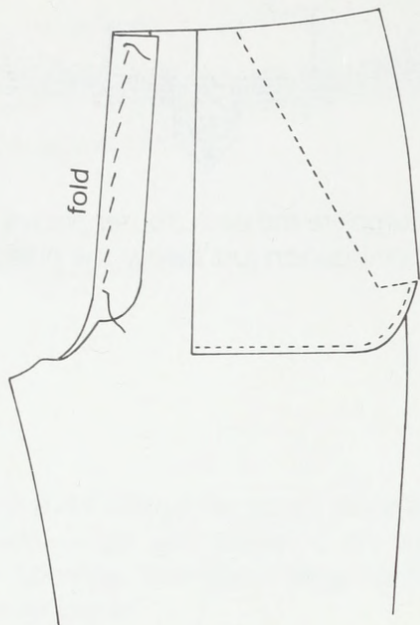

On the right front, fold and press the fly along the fly foldline. The reinforcement will be caught in the fold. Baste the fly in place.

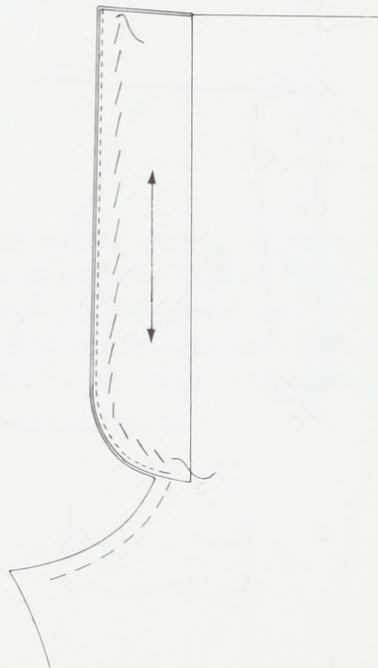

On the right side of the left front, baste and then machine-stitch a straight-grain strip of lining to the outer edge of the fly, using a $\frac{1}{8}$ " (3 mm) seam. The lining strip should extend about 1" (2.5 cm) beyond the fly foldline. This strip will serve as facing.

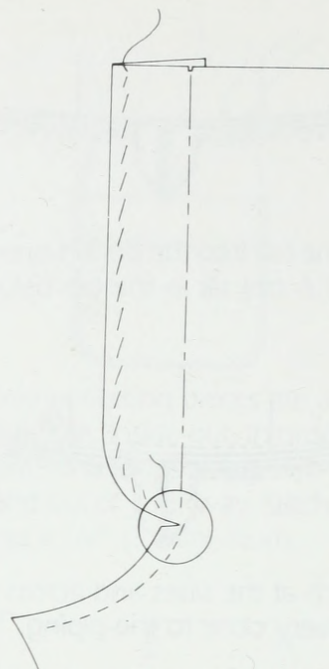

At the bottom of the left fly, slash into the crotch seam allowance. Slash very close to what will be the crotch stitchline.

Turn and press the lining to the wrong side of the fly, and baste along the outer edge.

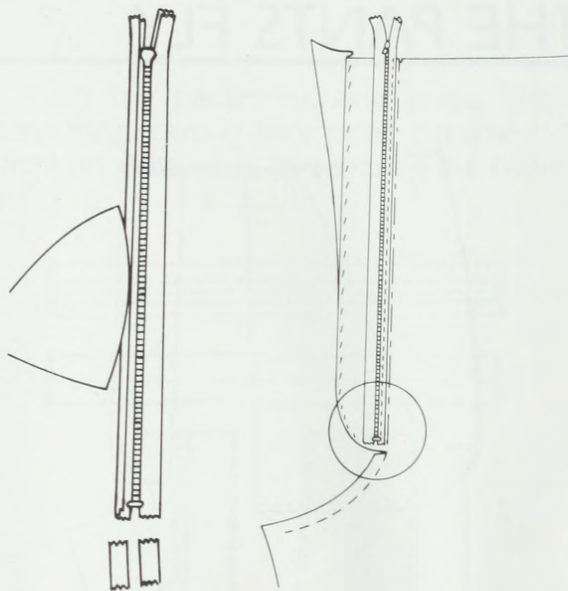

Trim the bottom ends of the zipper tape to $\frac{1}{4}$ " (6 mm) below the zipper stop. With the zipper face down, fold and press a hem, $\frac{1}{4}$ " (6 mm), along the left side of the zipper tape.

Baste the folded edge of the zipper tape along the edge of the fly foldline. The metal stop at the bottom of the zipper should be $\frac{1}{2}$ " (1.3 cm) above the notch which we cut at the bottom of the fly. Using a zipper foot, machine-stitch the zipper to the fly, tacking well at top and bottom.

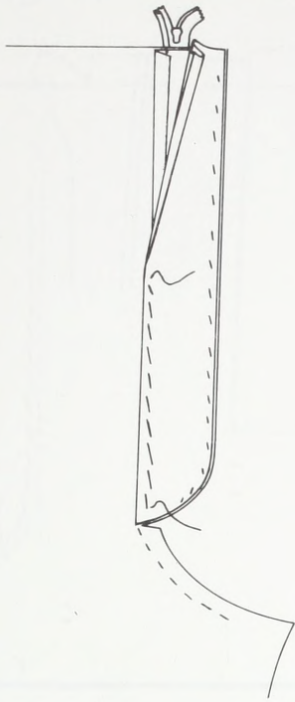

On the wrong side, the zipper seam allowance is concealed by folding first the reinforcement, and then the fly-facing on top of the reinforcement. The lining and reinforcement are basted and then machine-stitched or slip-stitched along the edge. The garment fabric is *not* caught in these stitches.

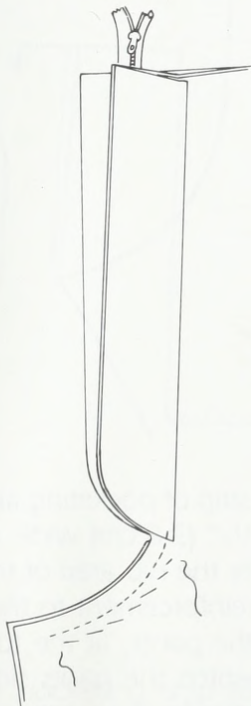

Place the two pants fronts together, right sides touching, and stitch along the crotch seam from the notch to 1" (2.5 cm) from the inseams. Tack well at either end.

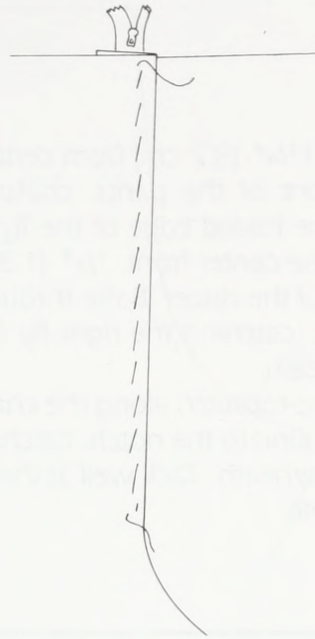

At the waistline, the right front should overlap the left by $\frac{1}{4}$ " (6 mm), and taper naturally to the bottom of the zipper. Baste the fly closed; basting close to the fold on the edge of the right front.

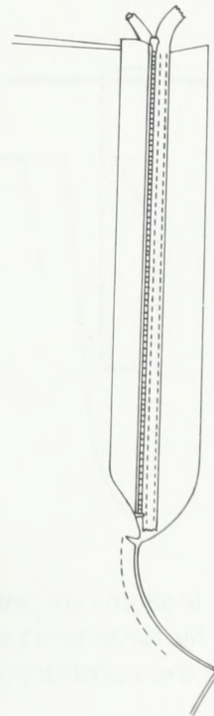

On the inside, pull the left fly aside, and machine-stitch the zipper to the right fly. *Only* the fly and the zipper are caught in these stitches, and *not* the front of the pants. Machine-stitch two rows on the zipper tape; one very close to the zipper teeth, the other at the edge of the tape.

About 1 1/4" (3.2 cm) from center front, on the right front of the pants, chalkmark a line parallel to the folded edge of the fly, and curve the line to the center front, 1/2" (1.3 cm) below the bottom of the zipper. Baste through the front of the pants, catching the right fly (*but not the left*) underneath.

Machine-topstitch along the chalkline, from the waist around to the notch, catching only the right fly underneath. Tack well at the notch. The fly is complete.

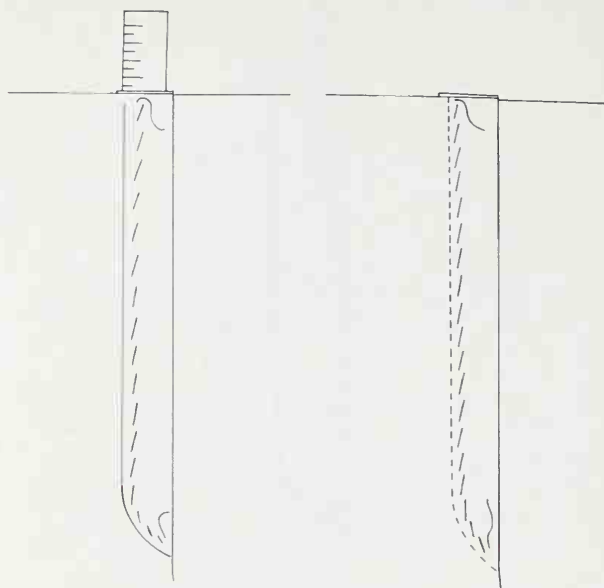

THE PANTS SIDE SEAMS

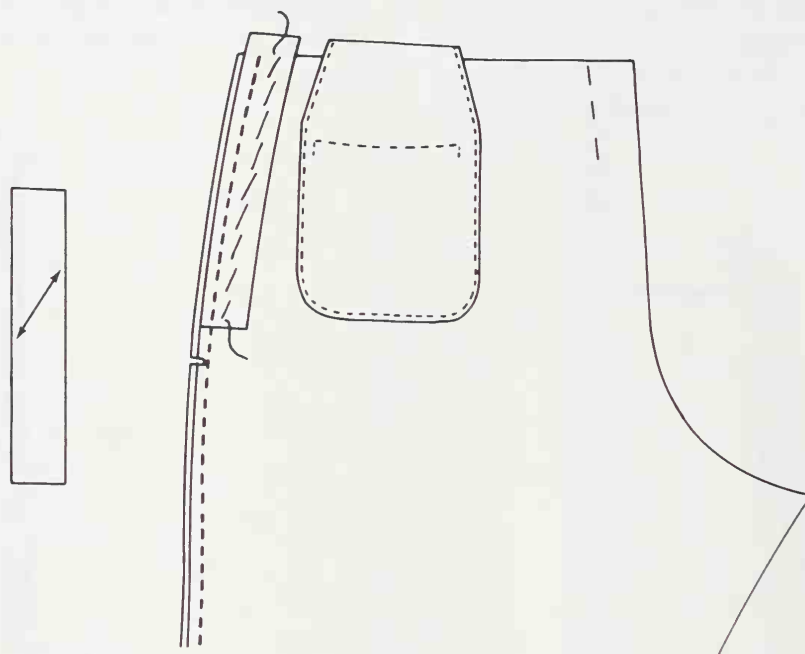

The pants side seams are sewn only after all pockets and the fly have been completed, and before beginning the construction of the waistband.

If you are not lining the pants, follow the instructions given here for reinforcing the top of the side seam, and finishing the edge of the pocket.

If the pants will be lined, the reinforcement and pocket finishing is not necessary. Simply stitch the side seams and press them open.

Cut a bias strip of pocketing about 8" (20.3 cm) long and 1 1/2" (3.8 cm) wide, to be used as reinforcement for the hip area of the side seam.

Baste the reinforcement to the wrong side of the back of the pants, at the top of the side seam. Machine-stitch the pants side seams, being sure to keep the front pockets out of the way as you stitch. The reinforcement is caught in the stitchline.

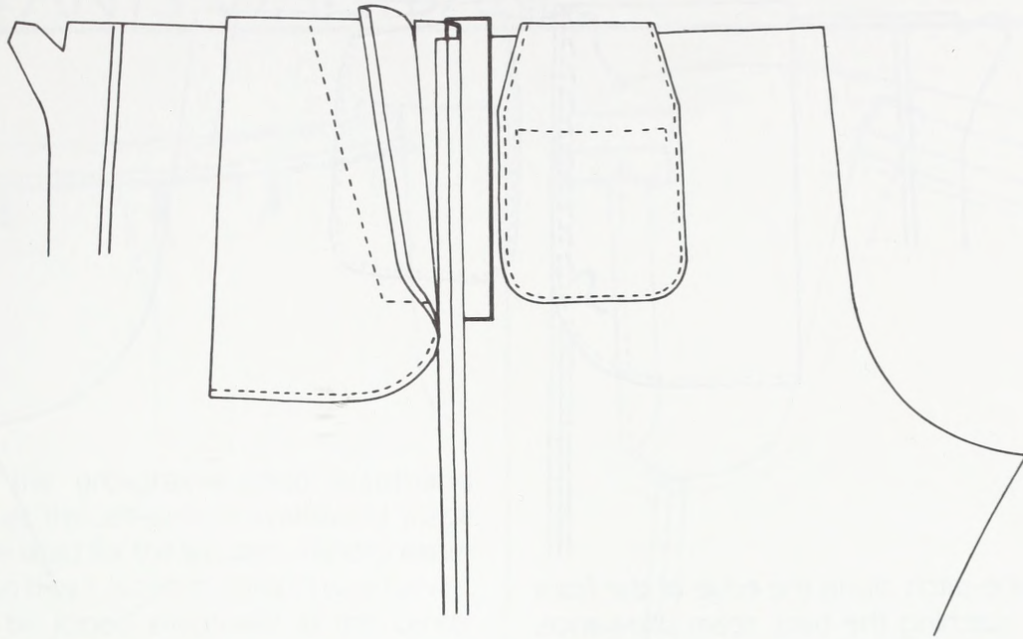

Press the seam open.

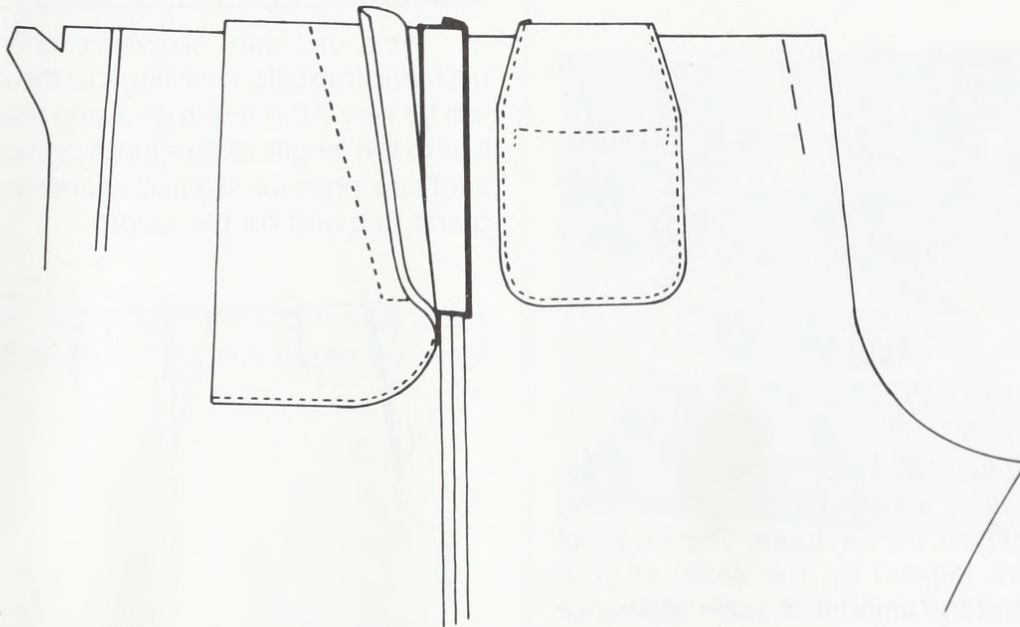

Bring the pocketing strip forward, fold it over the pants seam allowance, and press it in place.

Fold and press the edge of the front pocketing so that it reaches just to the edge of the back seam allowance.

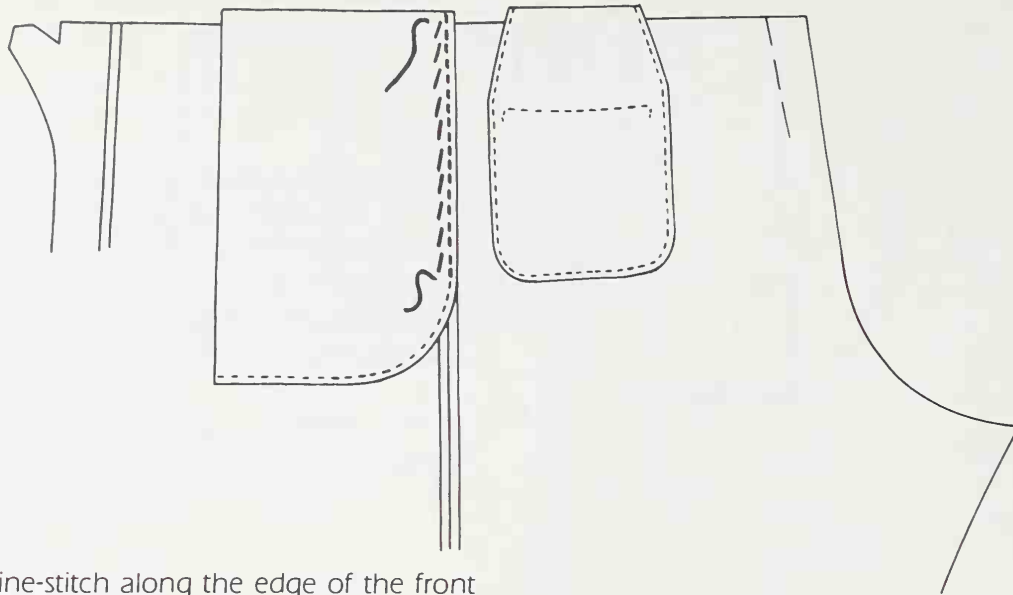

Machine-stitch along the edge of the front pocketing, catching the back seam allowance, and the reinforcement strip. *Do not* catch the outside of the trousers in this stitch.

BELT LOOPS



Press the seam allowance open, and cut the fabric strip before turning it to the right side. It will be very difficult to turn a strip that is equivalent to the length of four loops or more. On the right side, press the seam allowance to the center of the strip and cut the loops.

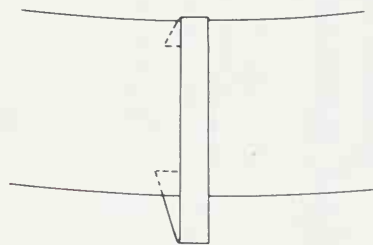

If you wish belt loops, or carriers at the waistband, cut a strip of garment fabric long enough to construct seven loops. The length of each loop will depend on the width of your waistband, and the amount of seam allowance you are using at the waistline. The loops must be long enough to extend from the top of the waistline seam allowance down to $\frac{1}{4}$ " (6 mm) below the waist stitchline, and then extend up and over the top of the waistband by about $\frac{1}{2}$ " (1.3 cm). The finished loops should be about $\frac{3}{8}$ " (1 cm) wide.

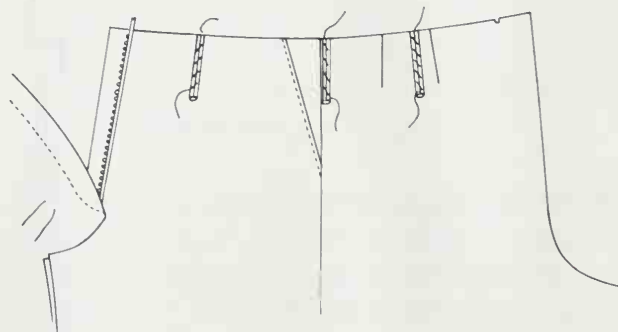

Baste the belt loops on the right side of the pants, at the center of each pants front section, at the side seam, and at the center of each pants back section. The seams on the loops should be facing up. The loop for the center back seamline will be attached after the waistband is attached to the pants.

THE PANTS WAISTBAND

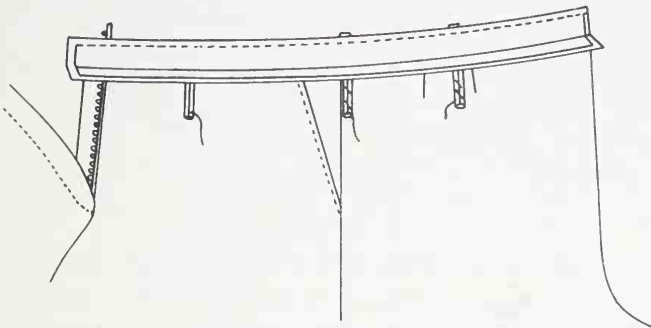

Either the grosgrain-backed waistband (page 224) or the self-backed waistband (page 234) may be used for the trousers. Modify either waistband so that it is constructed in two halves, which will be joined eventually at the center back seam.

A center-back waistband seam is most convenient for alterations in trousers.

The belt loops are caught in the waistline seam.

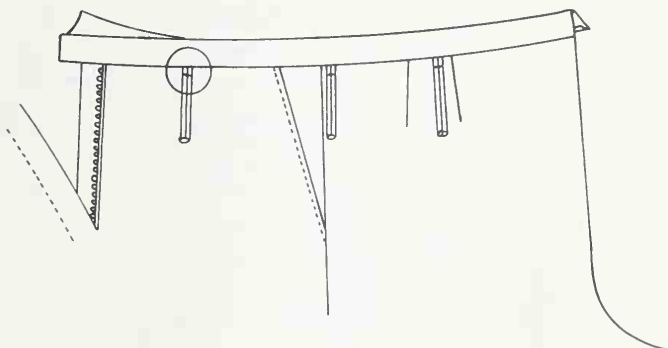

On the right side of the fabric each loop is topstitched down $\frac{1}{4}$ " (6 mm) below the waistline seam.

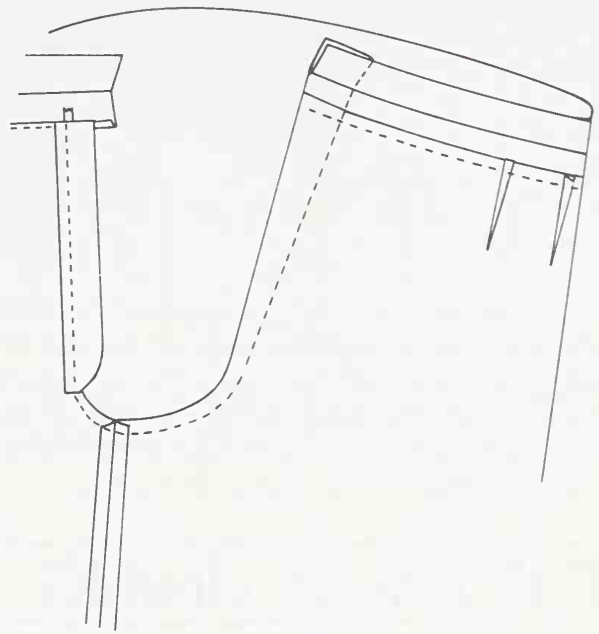

At this point the inseams are sewn and pressed open. The center back seam is sewn from the top of the waistband, along the crotch, to the fly. Press the seam open.

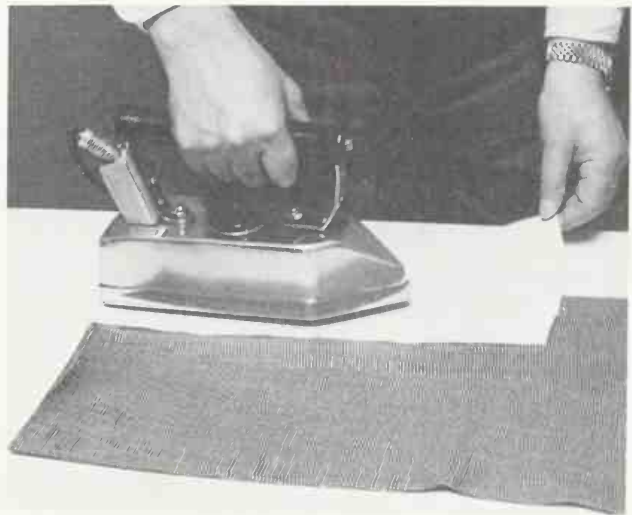

With the pants turned right side out, and the inseam and outseam of each leg aligned, press a crease from hem to about hip level, front and back. Press first on the inseam and then on the outseam side of each leg.

If there are front pleats, the front crease meets the deeper of the two pleats at the waistline (see page 278).

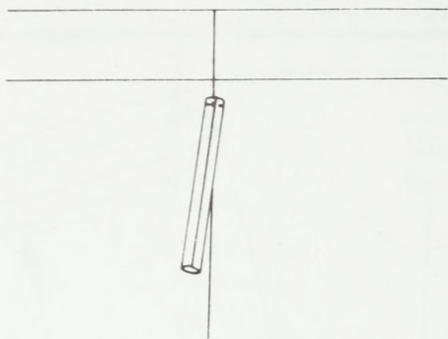

At center back, $\frac{3}{8}$ " (1 cm) below the waistline seam, place the raw edge of the last belt loop, seam facing up. Back-stitch the top edge of the loop into the pants. Bring the loop up and back-stitch once more, far enough above the first stitches to hide the raw edge of the loop.

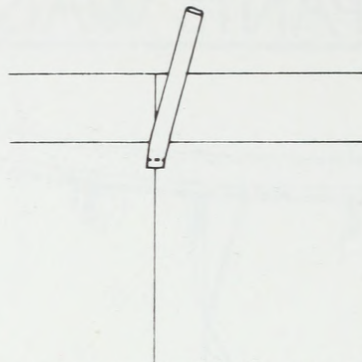

If you have decided to line the trousers, the lining must be constructed and attached now, before the completion of the waistband and belt loops.

If you will not be lining the trousers, move ahead to the last instruction on page 273.

THE PANTS LINING

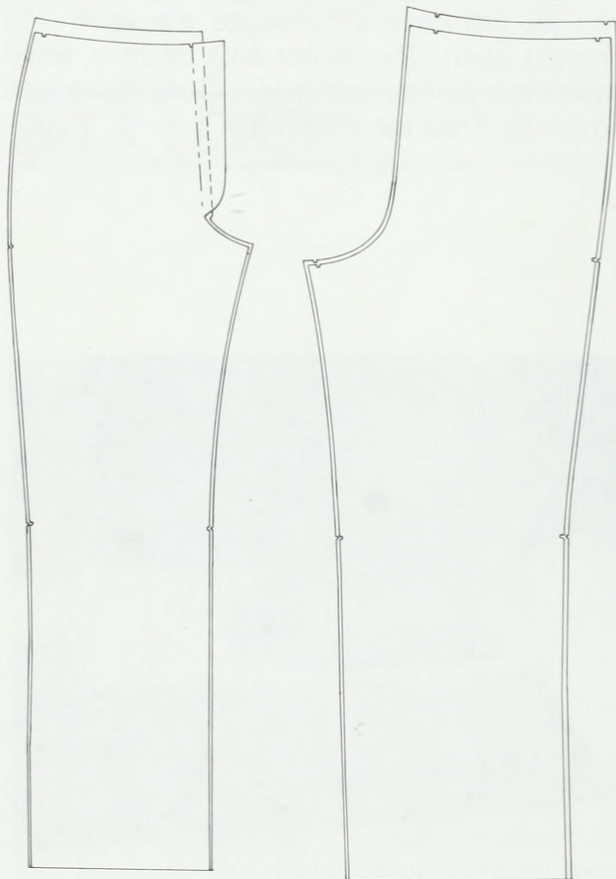

Cut the pants lining $\frac{1}{8}$ " (3 mm) larger than the pants pattern at the side seams, crotch, and center back; $\frac{1}{2}$ " (1.3 cm) beyond the fly foldline, and 1" (2.5 cm) beyond the waist cutting line.

Sew all lining seams, using the same seam allowances as used for the pants. Press the seams open.

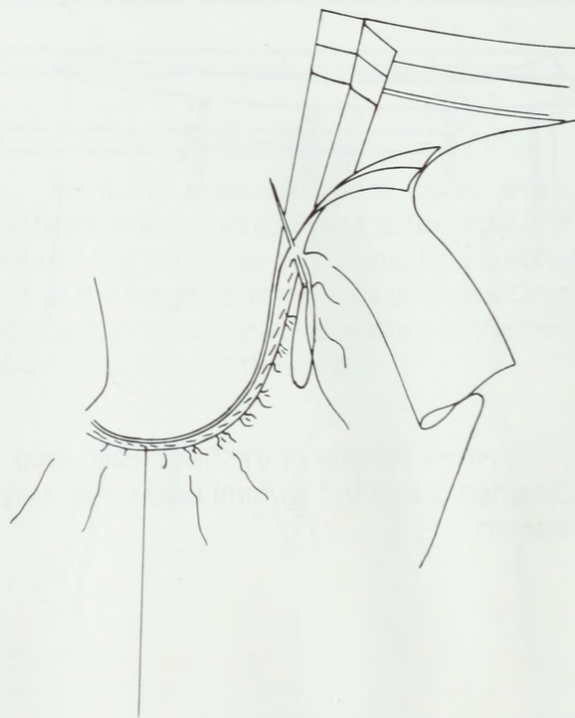

With the pants and the pants lining, wrong sides touching, baste one layer of lining seam allowance, and one layer of pants seam allowance together along the crotch and center back seam. Finish basting about 2" (5 cm) below the waistline

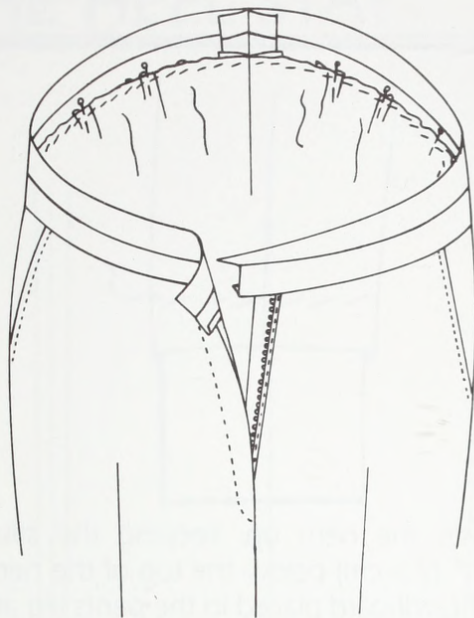

With the legs of the lining placed inside the pants legs, pin the lining and pants waistline together at the side seams, the center back seam, and at the center of each side of the pants front.

Distribute the ease in the back of the lining, by folding small pleats on each side of the pants.

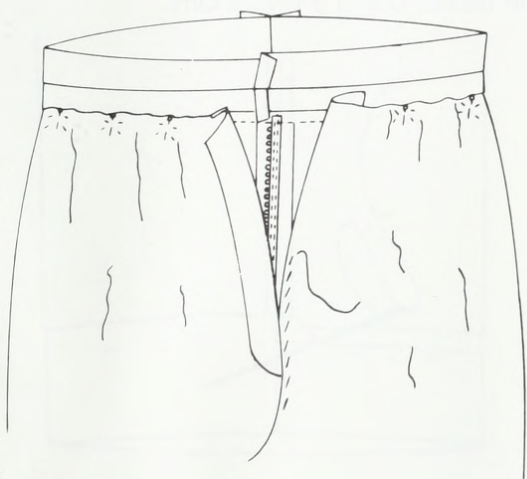

Baste the front lining along the edge of the zipper on the right side of the pants, and then baste across the waistline, distributing the lining ease in small ripples.



On the left side of the pants the lining is basted along the lining which already covers the fly.

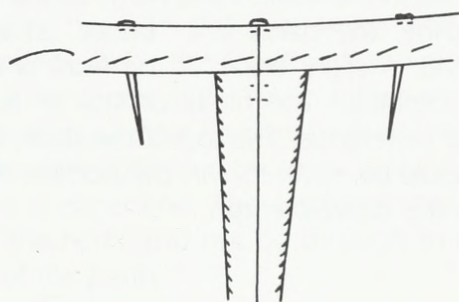
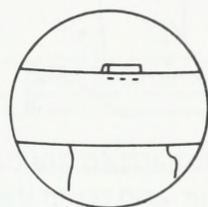

The waistband is carefully basted in place, and the belt loops are secured by hand at the top of the wrong side of the waistband.

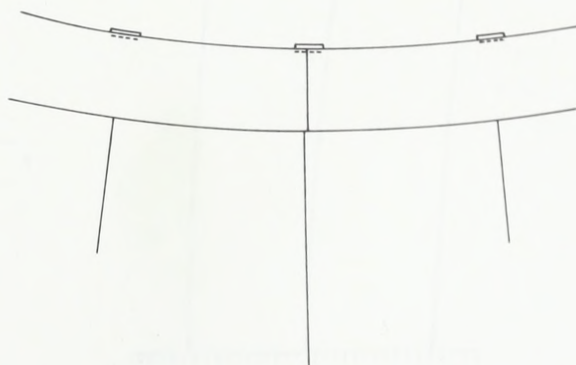

With the pants inside out, baste the front lining along the edge of the zipper on the right side of the pants, and then baste across the waistline, distributing the lining ease in small ripples.

THE PANTS HEM

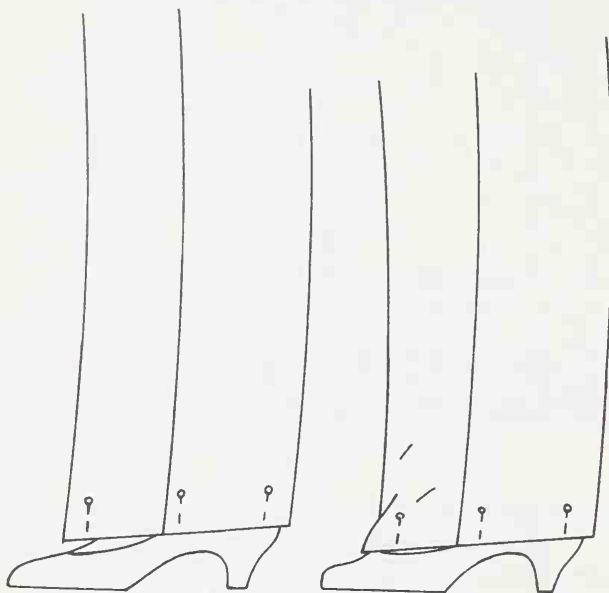

The pants hem should reach to about the middle of the back of the shoe, and cover the top of the shoe in the front. If the hem hits the front of the shoe, the pants will "break" at about ankle level. A slight break at the front is absolutely acceptable. The break or lack of it, is a matter of preference. The top of the shoe, however, should be covered. Pin the bottom of the pants to the desired length.

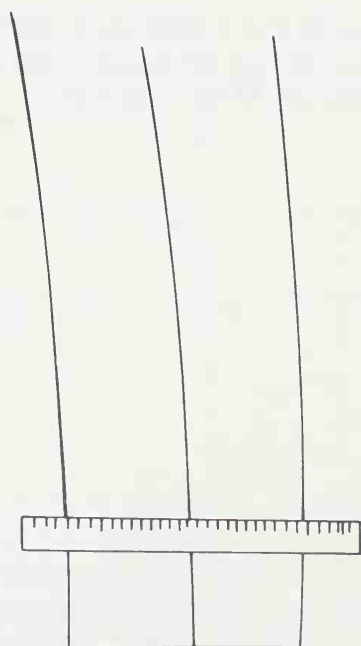

Chalkmark the hem foldline on the right side of the fabric.

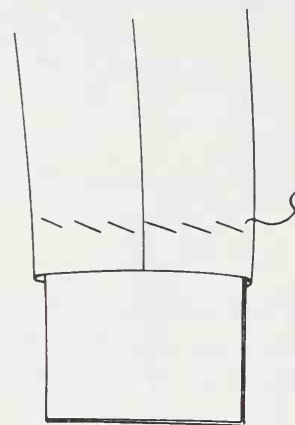

Baste the hem up, keeping the stitches about 1" (2.5 cm) below the top of the hem. A piece of cardboard placed in the pants leg at the hem, will facilitate the basting and prevent the stitches from catching the other side of the pants.

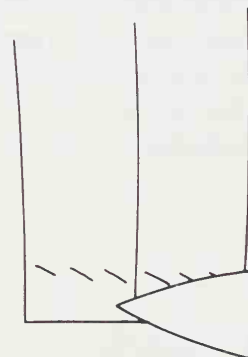

Steam press the hem flat, on the right side of the fabric, using a presscloth.

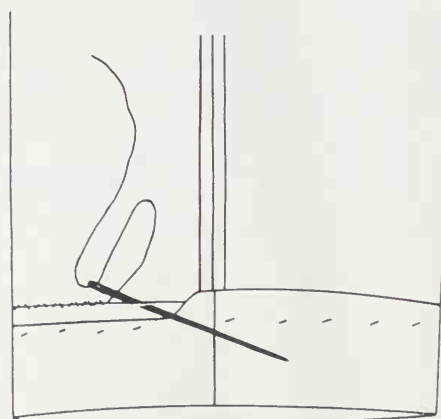

Fold back about $\frac{3}{8}$ " (1 cm) at the top of the hem and hem-stitch the hem into the pants, using silk finishing thread. These stitches should not be visible on the right side of the garment; nor should any puckering be visible, from having pulled the thread unnecessarily tight. If the pants are lined, the lining at the hem is handled as was the jacket (page 128) or the skirt (page 232).

THE HEEL STAY

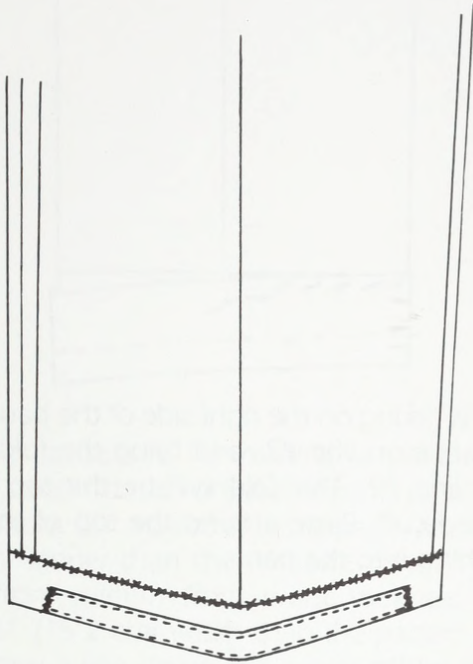

A strip of fabric, called a *heel stay*, is now applied to the hem at the back of the pants. Its purpose is to protect the hem from wear in the area that will come into contact with the back of the shoe.

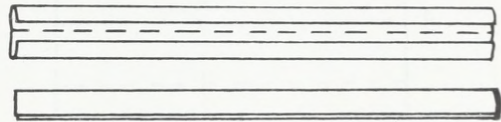

Cut a strip of garment fabric, about 7" (17.8 cm) long and 3" (7.6 cm) wide, and fold (as illustrated). Place the fabric just above the hem fold at the center of the back of the pants. Secure the heel stay to the hem by back-stitching along the folded edges, and by cross-stitching the raw edges at either end. These stitches should catch only the hem, and not go through to the right side of the pants.

THE PANTS CUFFS

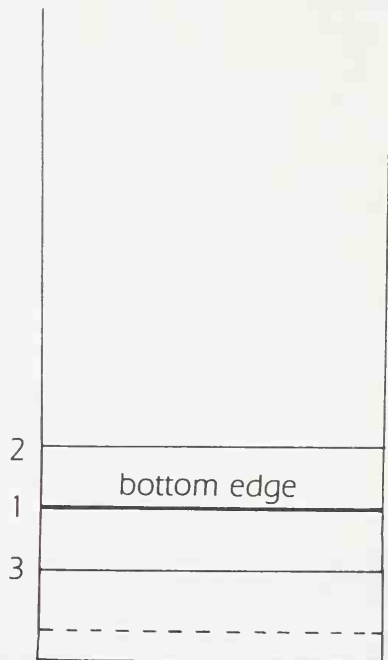

If you have chosen cuffs instead of a straight hem for the bottom of the pants, you will have left quite a bit of fabric below what you determined to be the bottom edge of the pants (page 14). Now, several lines are drawn on the right side of the fabric, as guides in creating the cuff.

First, draw a line indicating what will be the bottom edge of the pants; keeping in mind that cuffed pants need to start out slightly longer $\frac{1}{4}$ " (6 mm) than those with straight hems. Some of the length always gets lost in the folds.

Draw one line above the first, and two lines below it, all at a distance equal to the width of the cuff. An average cuff is about $1\frac{1}{2}$ " (3.8 cm) wide.

Below the last line leave about $\frac{3}{4}$ " (1.9 cm) hem, and trim away whatever fabric is left at the bottom of the pants.

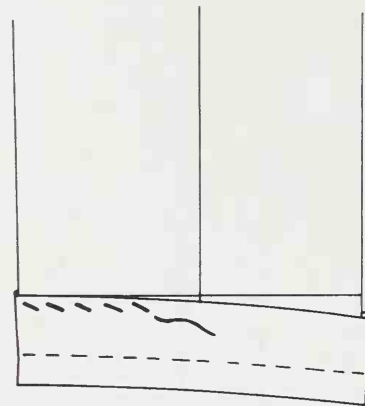

Working on the right side of the pants, fold the fabric on line #3, and bring the fold up to meet line #2. This fold will be the top of the finished cuff. Baste around the top of the cuff, attaching it to the pants.

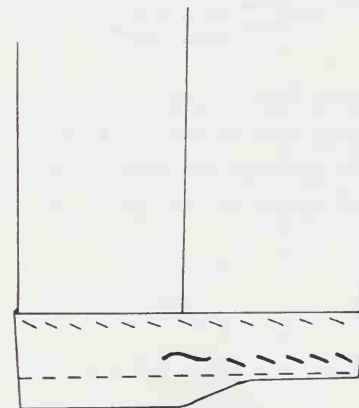

Fold the $\frac{3}{4}$ " (1.9 cm) hem to the wrong side of the pants, and baste around the bottom of the cuff, attaching the hem to the pants.

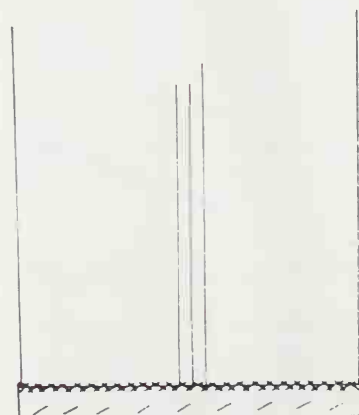

On the wrong side of the pants, cross-stitch along the top of the hem, catching the inner layer of the cuff as you stitch.

Press the cuff flat from the right side.

PLEATED PANTS

The procedure for making a pattern for pleated pants from an unpleated pants pattern, is quite simple. Cut a piece of tissue paper about 3" (7.6 cm) longer than the measurement of your pants front pattern from waist to knee, and about 6" (15.2 cm) wider than the pattern.

Draw a line down the center of the tissue from top to bottom. This line will represent the crease line at the center front of the pants.

Draw three additional lines to the right of the crease line, at distances indicated in the illustration. Label the lines, *A*, *B*, *C*, and *D*.

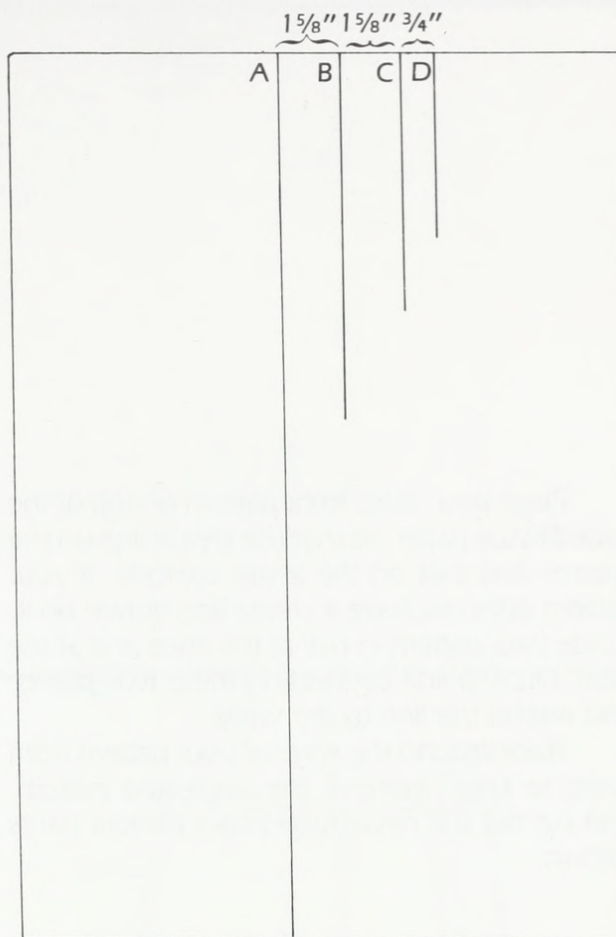

Crease the paper along the length of *line A*, and then bring *line A* over so that it touches *line B* at the top of the paper.

Smooth the paper downwards, so that the pleat disappears in the paper at a level just above the knee.

Fold *line C* over onto *line D* at the top of the paper, and smooth the paper so that the pleat disappears a short distance from the waistline.

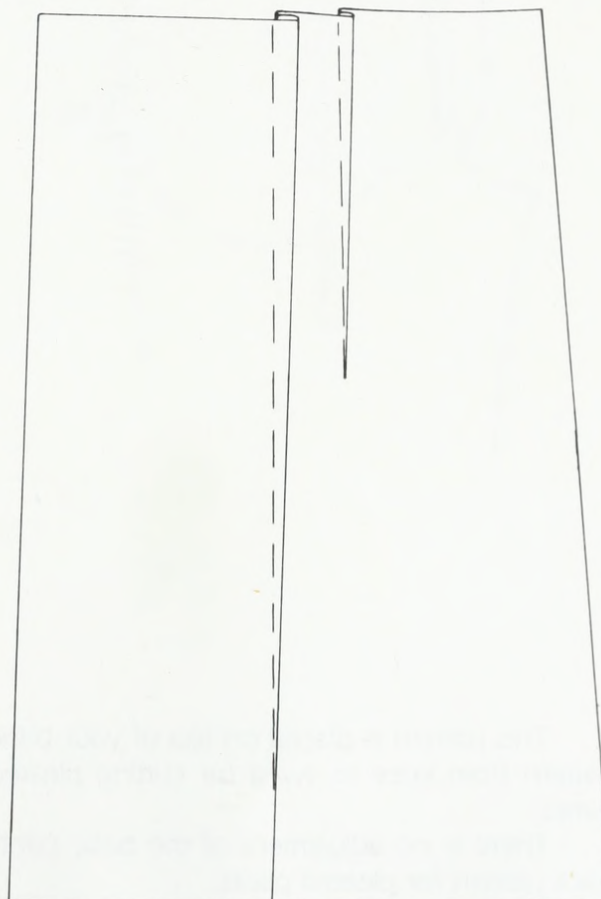

Place your pants front pattern on top of the folded tissue paper, so that the crease line on the pattern and that on the tissue coincide. If your pattern does not have a crease line drawn on it, divide your pattern in half at the knee and at the hem. Draw a line connecting these two points, and extend the line to the waist.

Trace around the edge of your pattern from waist to knee. Remove the unpleated pattern, and cut out the new tissue-paper pleated pants pattern.

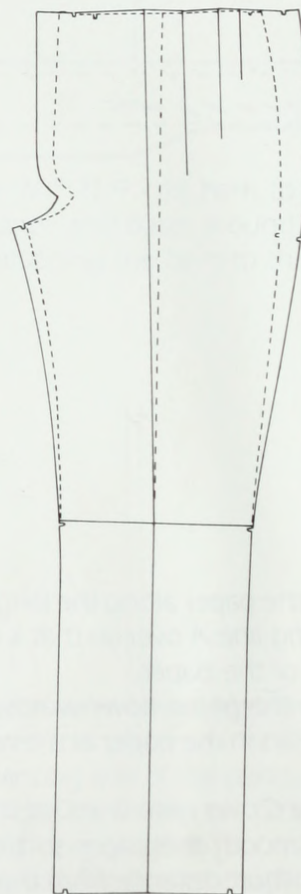
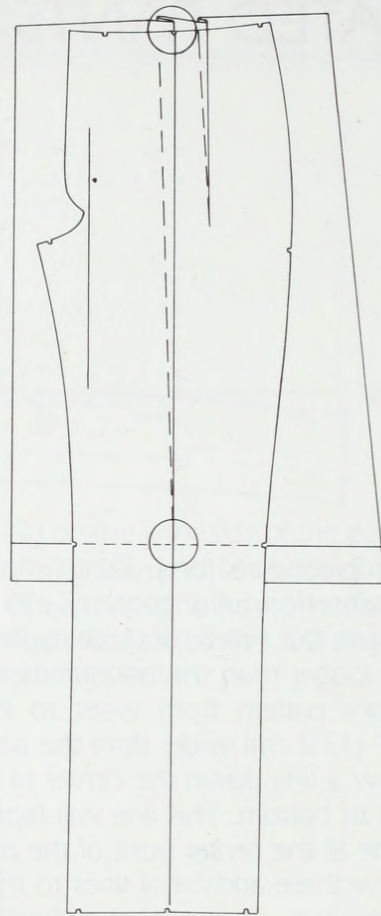

This pattern is placed on top of your basic pattern from knee to waist for cutting pleated pants.

There is *no* adjustment of the basic pants back pattern for pleated pants.

POCKETS IN PLEATED PANTS

There is a variation often used when constructing front pockets in women's pleated trousers. It involves the insertion of a panel on the inside of the front trousers, for the purpose of controlling the graceful fall of the pleats. The panel, which doubles as the back of the pockets, extends from side seam to zipper. It controls the pleats from underneath, by restricting the width of the pants front, to the width it would be if there were no pleats. Let us demonstrate.

With the pleats in your pants front pattern folded closed, place a piece of paper over the pattern and cut the paper as illustrated by the broken line:

- $\frac{1}{4}$ " (6 mm) beyond the pattern cutting line at the waist and side seam.
- $\frac{1}{2}$ " (1.3 cm) beyond the fly foldline, from waist to fly notch.
- 12" (30.5 cm) long at the center of the pattern.
- 2" (5 cm) longer than the bottom of the pocket opening at the side seam.

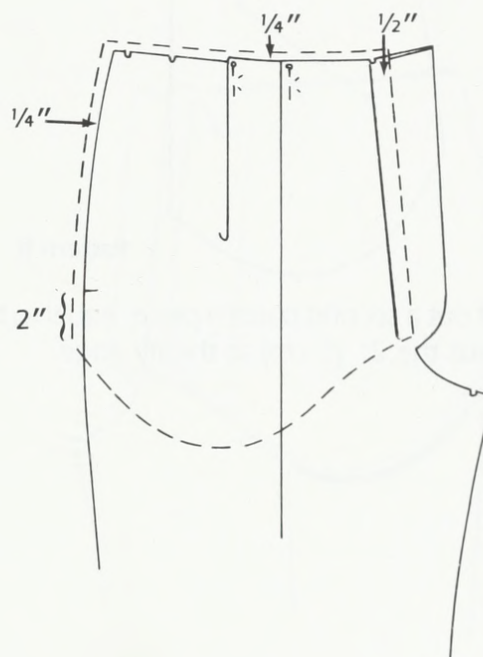

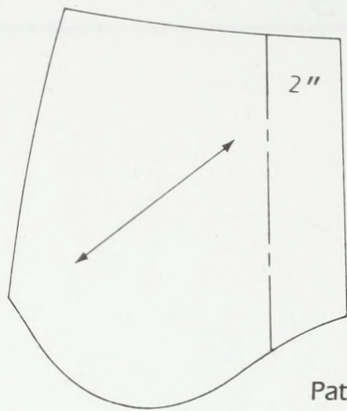

Pattern A

Cut out the pocket pattern and draw a line 2" (5 cm) in from the fly edge. Draw the grainline as indicated.

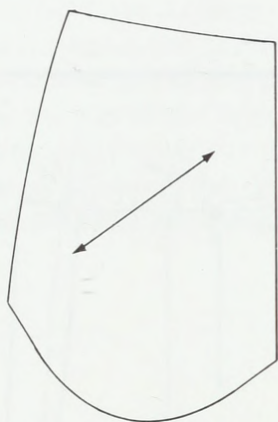

Pattern B

Cut out a second pattern piece, equal to the first, minus the 2" (5 cm) at the fly edge.

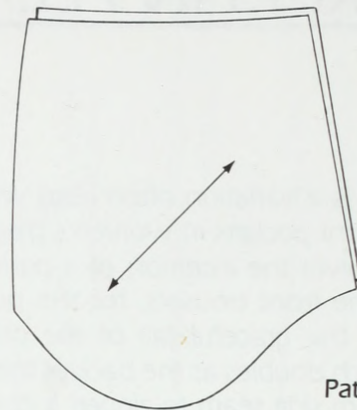

Pattern A

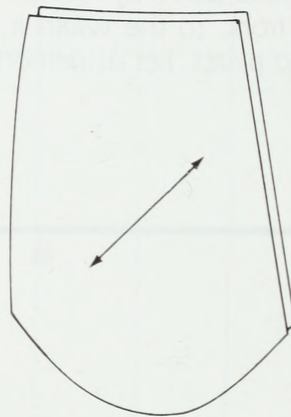

Pattern B

From pocketing fabric, on the bias, cut one piece from pattern A, and one from pattern B for each pocket.

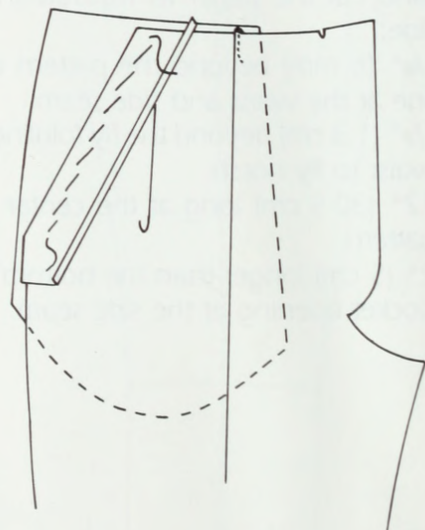

The slant pocket is then constructed according to instructions beginning on page 249, with the substitution of one pattern B piece as the pocketing.

Follow the instructions up to the right-hand column on page 251.

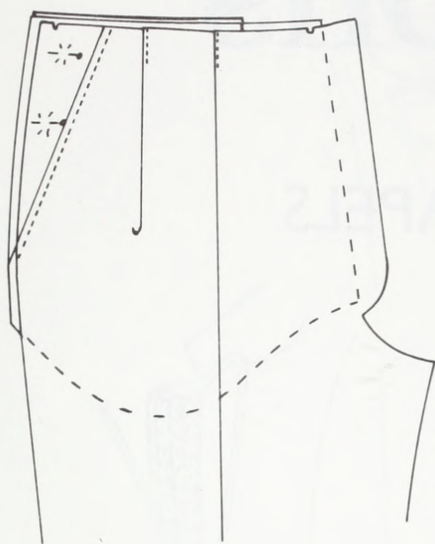

Instead of folding the pocketing in half, as indicated on page 252, place the pattern A pocketing under the pattern B pocketing, matching the side and waistline edges.

Move the pins *up* carefully, and attach the yoke to the pattern A pocketing.

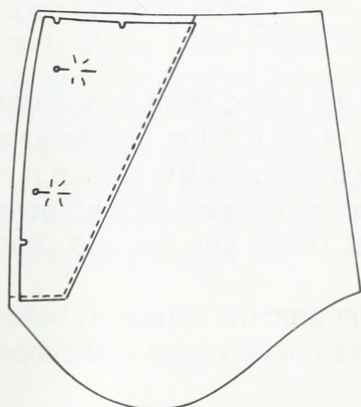

Topstitch the yoke to the "A" pocketing.

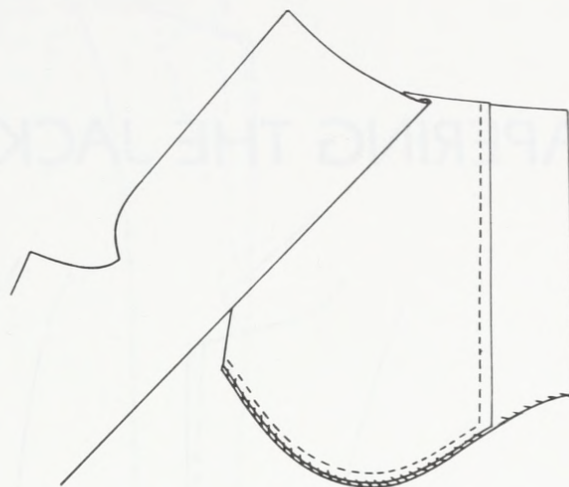

Stitch the two pieces of pocketing together, and overcast the bottom edge.

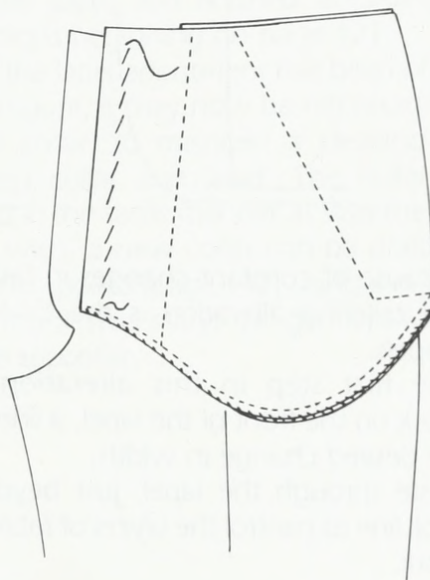

Baste the edge of the pocketing to the pants front, $\frac{1}{2}$ " (1.3 cm) beyond the fly foldline. The pocket is complete.

Just below the pocket opening, on the side of the pocketing closest to the garment fabric, slash about 1" (2.5 cm) into the pocketing and facing. This slash will eventually enable you to hold the pocket aside while the side seams are being sewn.

The side seams will be sewn only after all pockets and the fly have been constructed (see pages 265–270).

9 Alterations

TAPERING THE JACKET LAPELS

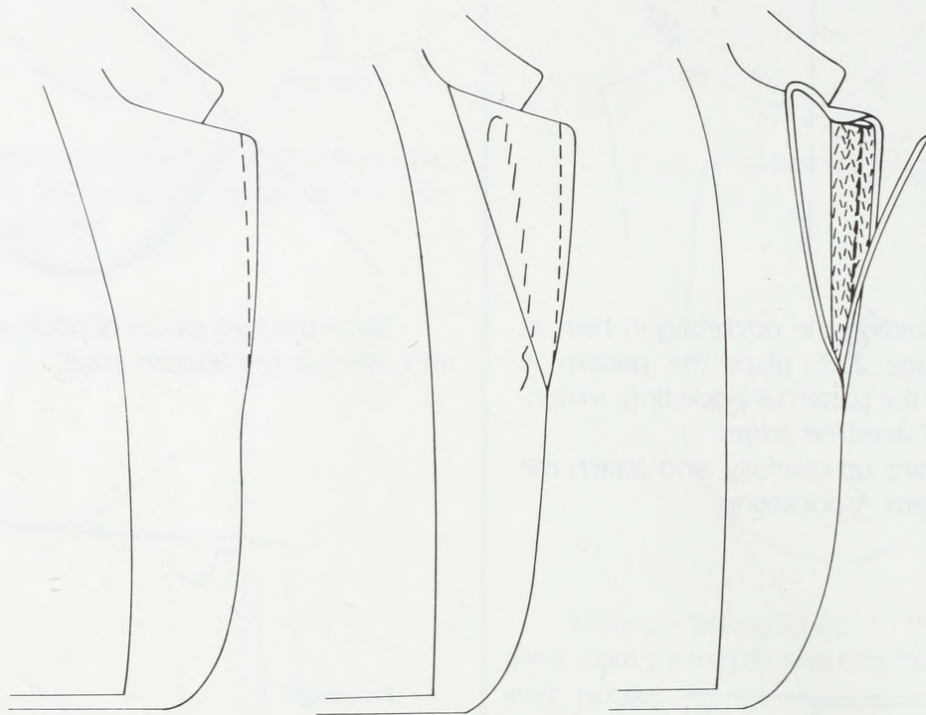

Because of constant changes in fashion, a frequent tailoring alteration is the tapering of jacket lapels.

The first step in this alteration, is to chalkmark on the front of the lapel, a line indicating the desired change in width.

Baste through the lapel, just beyond the jacket roll line to control the layers of fabric while you work.

Open the facing seam from collar notch to the bottom of the roll line, and remove the tape from the outer edge of the lapel. It is not necessary to remove the tape which lies across the top of the lapel, unless you are also changing this line.

Transfer onto the canvas a chalkline indicating the new finished edge of the lapel.

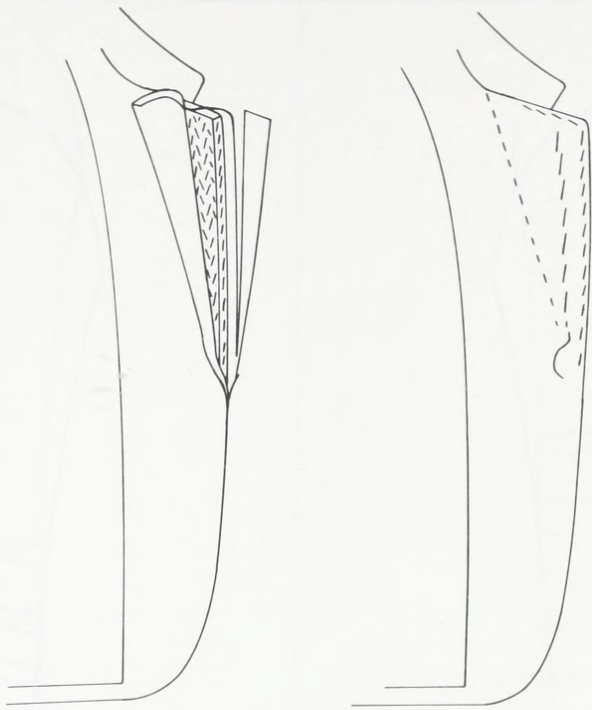

Trim the canvas (but not the garment fabric) along the chalkline, and baste $\frac{3}{8}$ " (1 cm) cotton twill tape (which has been soaked in cool water and pressed) along the length of the lapel. Allow the tape to extend into the seam allowance, beyond the canvas, by about $\frac{1}{16}$ " (1.5 mm), to give the lapel a thinner edge.

Slip-stitch along both edges of the tape, using silk thread. The stitches should go through to the underside of the lapel, but should be small enough to be all but imperceptible.

Trim the garment fabric seam allowance to $\frac{3}{8}$ " (1 cm) beyond the tape, and trim slightly closer at the tip of the lapel.

The lapel seam allowance is now folded up onto the tape, and finished according to the instructions beginning on page 121.

If the lapel adjustment has been of a significant amount, it may now be necessary to modify the collar, to maintain a pleasing balance between collar and lapel. The collar can be tapered in the same manner as was the lapel, or, if you wish, a new collar can be drafted (page 156) and applied (page 142) using a new under-collar and (if necessary) the garment fabric from the old topcollar.

ADJUSTING THE SLEEVE LENGTH



The jacket alteration done most often is probably the adjustment of the sleeve length. The length of the sleeve is primarily a matter of preference, and of comfort. The jacket sleeve may be as short as $\frac{1}{2}$ " (1.3 cm) above the bottom of the shirt cuff, or as long as is comfortable to your client.

Because of the layers of fabric at the sleeve vent, the cuff is too bulky to be folded up and pinned accurately to determine the correct length. Chalkmark on the cuff the amount to be shortened, or make note of the amount to be lengthened.

Baste around the sleeve about 8" (20.3 cm) above the hem, to control the lining while you work.

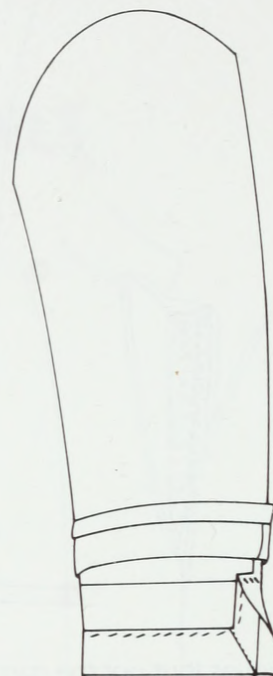

Remove the cuff buttons, and, with the sleeve inside out, loosen the lining at the hem and along the vent. Bring the lining up out of your work area.

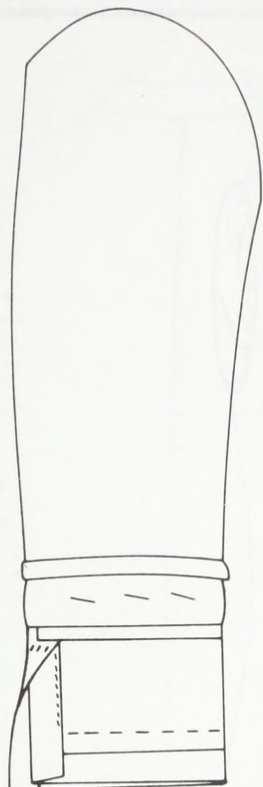

Remove the hem stitches and press out the original hem foldline. Use a sleeve board for this pressing, or insert a press mitt into the bottom of the sleeve.

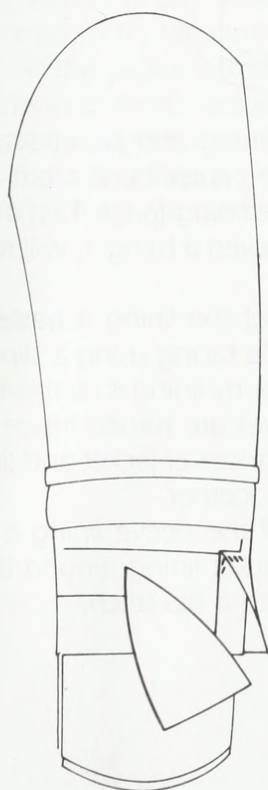

Fold and press the new hemline and press a miter at the bottom of the topvent (page 168).

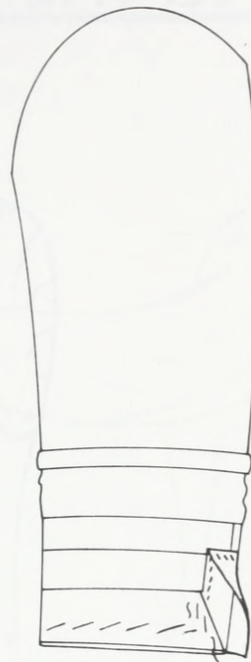

Diagonal-stitch the hem into the reinforcement and slip-stitch the ends of the vent closed.



Baste the lining in place along the vent (page 170), and place the lining hem fold about $\frac{3}{4}$ " (1.9 cm) above the sleeve hem. Keep the hem basting about 1" (2.5 cm) above the lining hem fold.

Fold back the lining hem and hem-stitch one layer of lining into one layer of garment fabric.

Replace the sleeve buttons (page 184) and press the sleeve (page 186).

RE-LINING THE JACKET

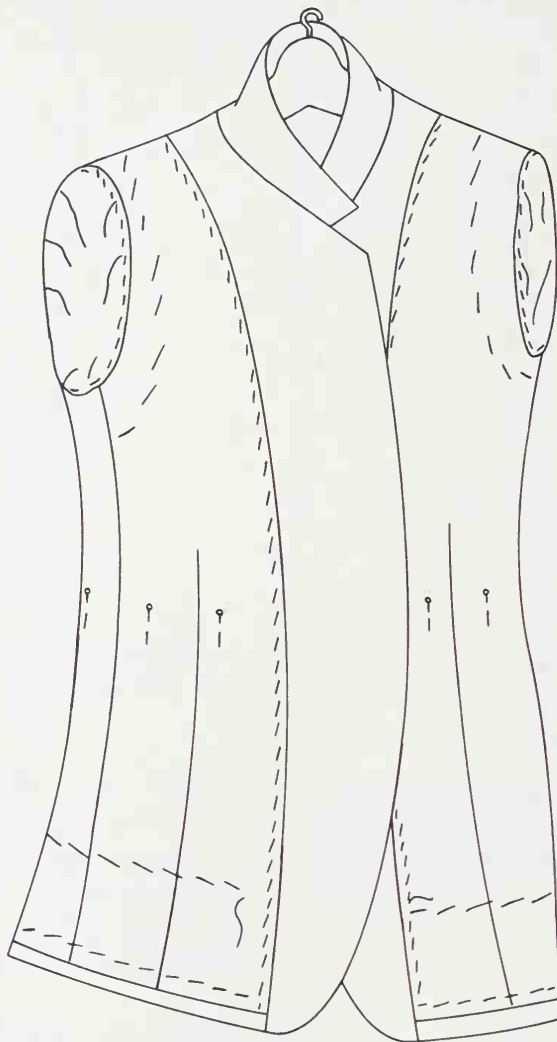

To re-line a jacket for which the pattern is not available, remove the old lining carefully. Separate the lining pieces into front, back, side, and sleeves; and press each well.

The old lining is now used as a pattern for the new one.

If there is reason to believe that the lining's poor condition is due to its being too small for the jacket, add an extra $\frac{1}{8}$ " (3 mm) to all vertical seams, and leave enough fabric at center back to create a controlled pleat (page 129).

Sew the front and back of the lining together at the side seams and anchor this lining shell into the jacket at the waistline notches.

With the lining and jacket seams aligned, baste down the center back seam and around the edges of the lining (page 131). The use of a mannequin, or even a hanger, will make this job easier.

The front of the lining is basted and then attached into the facing using a slip-stitch.

Once the body lining is complete, the jacket and lining sleeves are turned inside out so that the seam allowances of jacket and lining sleeves can be basted together.

The top of the sleeve lining is folded and basted to the jacket lining around the armhole, and finished with a slip-stitch.

ALTERING THE JACKET WIDTH

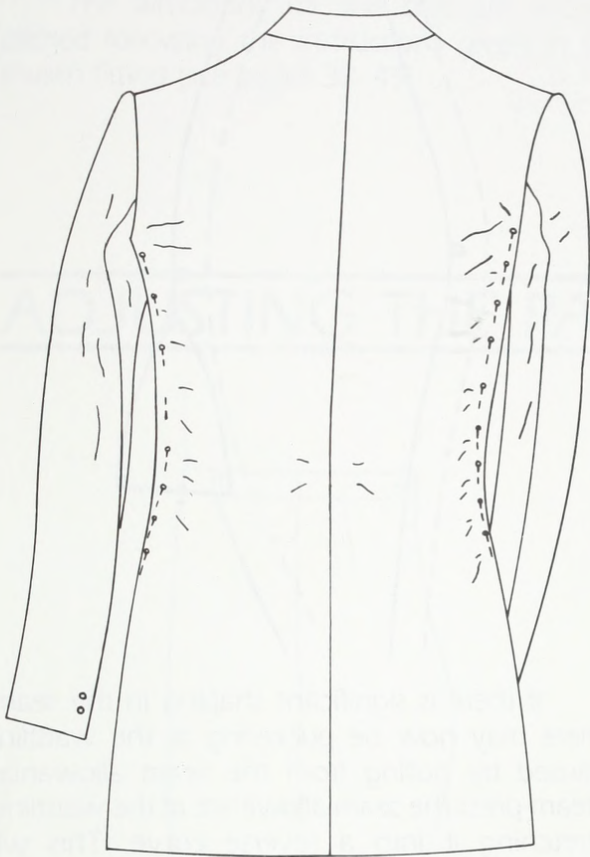

A jacket which is too wide in the body should be pinned to fit, tapering gradually into the seamline. If the jacket is too tight, do not open the seams in order to decide how much of the seam allowance to let out. You have more control over the alterations if you remove old stitches only after the new ones are in.

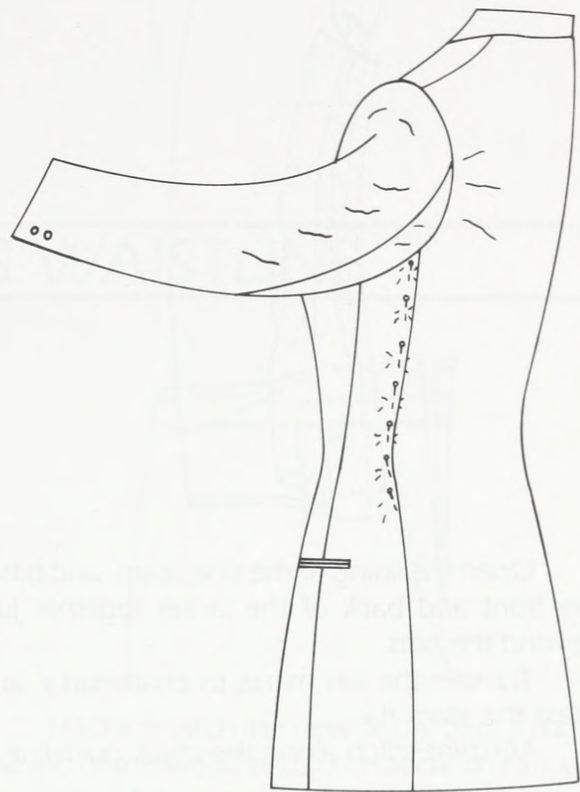

If the alteration cannot possibly avoid the underarm, open the armhole seam, just in the underarm area.

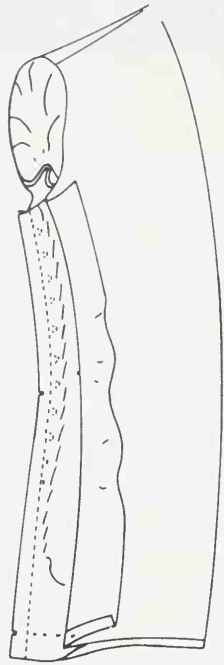

Open the lining at the side seam, and baste the front and back of the jacket together just beyond the pins.

Transfer the pin marks to chalkmarks, and press the seam flat.

Machine-stitch along the chalk guideline.

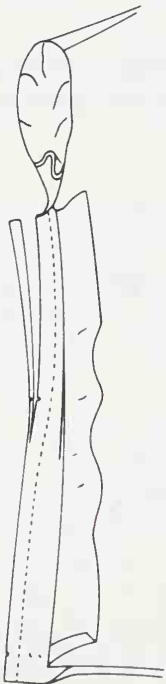

Remove the old stitches, and trim the seam allowance. Press the seam open.

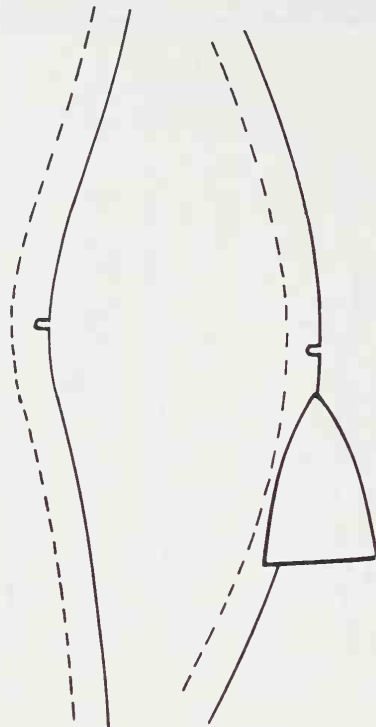

If there is significant shaping in the seam, there may now be puckering at the waistline caused by pulling from the seam allowance. Steam-press the seam allowance at the waistline, stretching it into a reverse curve. This will lengthen the seam allowance in the shaped area and relieve the puckering.

If the alteration has involved less than 1" (2.5 cm), it may be possible to ease the sleeve back into the armhole without adjusting the sleeve.

If, however, despite valiant effort, you find it impossible to gracefully fit the sleeve into the now smaller armhole, reduce the ease by tapering the sleeve underarm seam. *Do not* taper the back seam. This would distort the shape of the sleeve.

With the armhole finished, replace the jacket lining (page 174) and the sleeve lining (page 173).

ALTERING SKIRTS

The alterations for the skirt are accomplished following the instructions given in the muslin fitting (see pages 38–45).

ADJUSTING THE PANTS WAISTLINE



If the pants are too loose at the waistline, pin them to fit (as illustrated), without opening the center back seam. If the pants are too tight, the seam must be opened first, and then pinned.

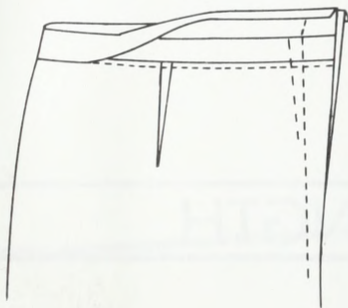

Remove the center back belt loop. Transfer the pin marks to chalkmarks, and press the center back seam allowance flat.

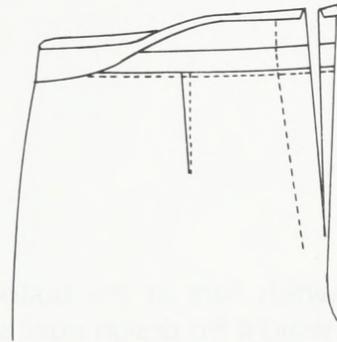

Machine-stitch the new seam, beginning at the top of the waistband, and tapering gradually into the crotch. Remove the old seamline, and trim the seam allowance. If you have the fabric, leave as much as 1 1/2" (3.8 cm) seam allowance at the top of the center back seam to allow for future alterations. Press the seam open.

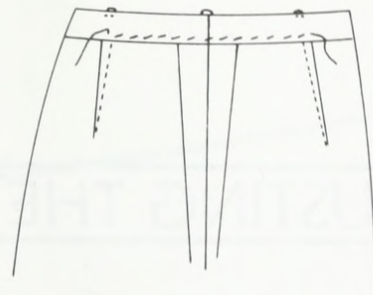
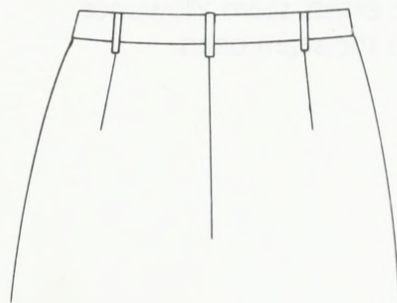

Attach the center back belt loop (page 272). Back-stitch along the basted edges, using silk finishing thread.

TAPERING THE PANTS LEG

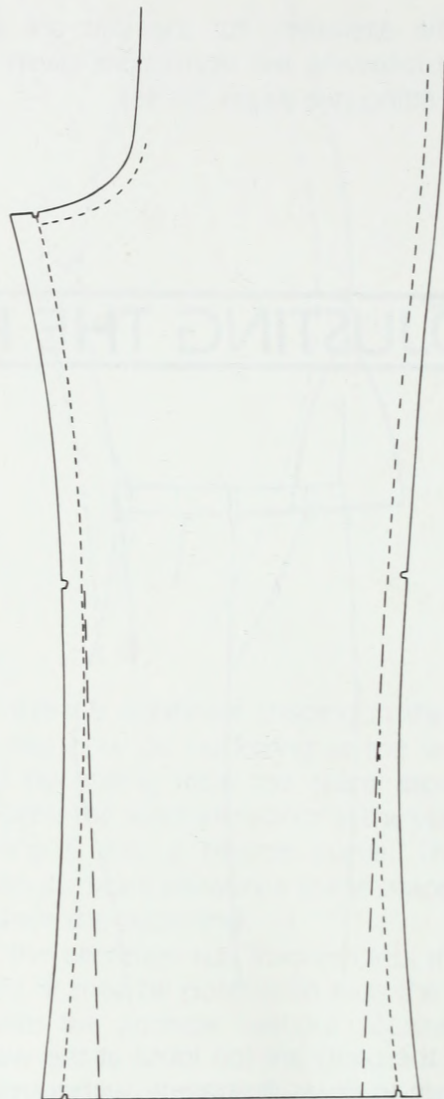

Pants which flare at the bottom can be altered to a straight leg design quite simply.

With the pants inside out, and the hem down, press the seam allowances flat. The stitchlines which produce the flare will be obvious below the knee, at both the inseam and outseam. Draw chalklines from the knee to the bottom of the pants, narrowing the pants leg the same amount at the inseam and outseam.

Machine-stitch along the chalkline and trim away the excess seam allowance.

Press the seam open.

ADJUSTING THE PANTS LENGTH

The adjustment of the pants length is done following the directions on page 274. Before beginning, let down the old hem and press well.

Patterns

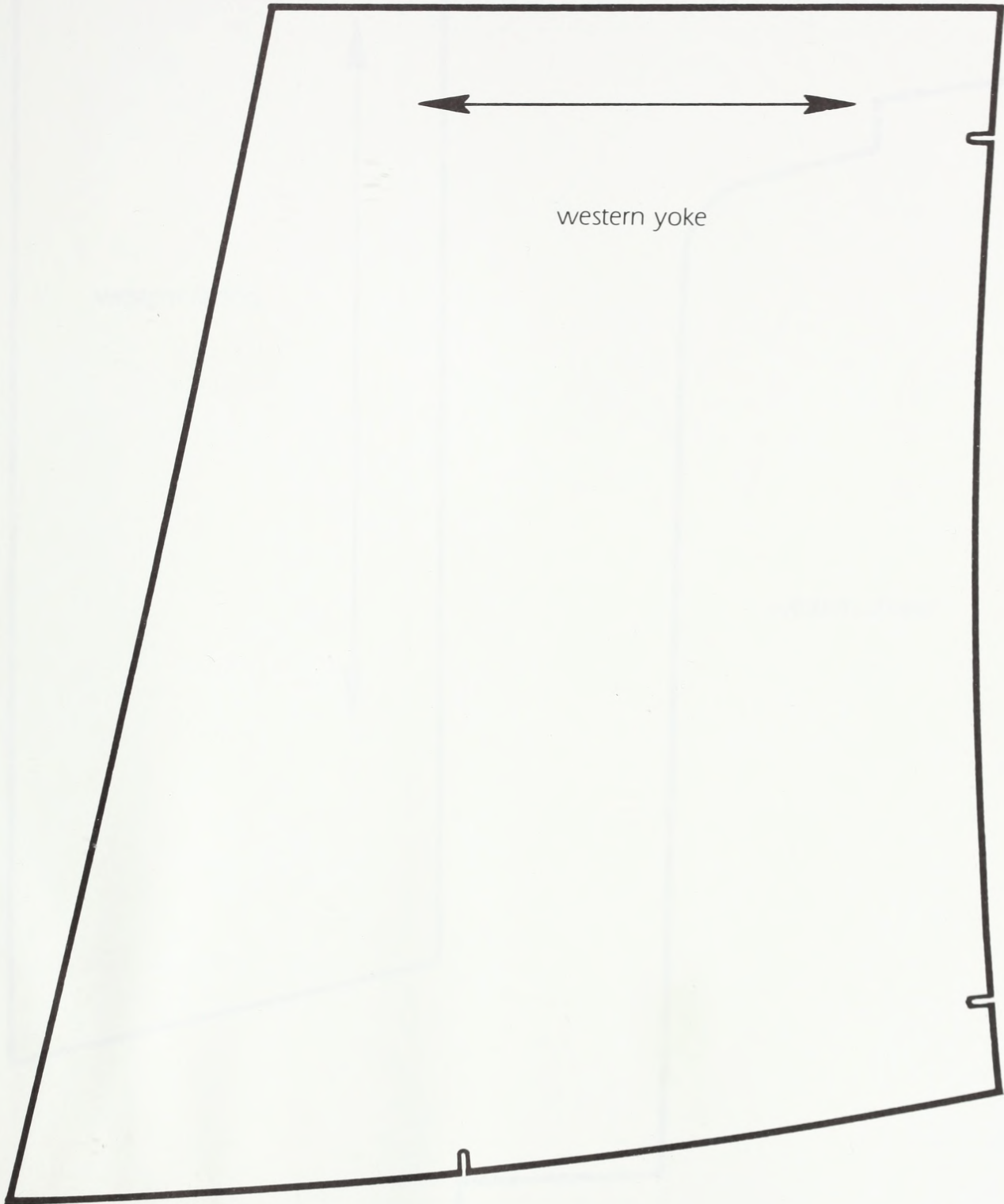

Patterns



ADJUSTING THE PATTERN LENGTH

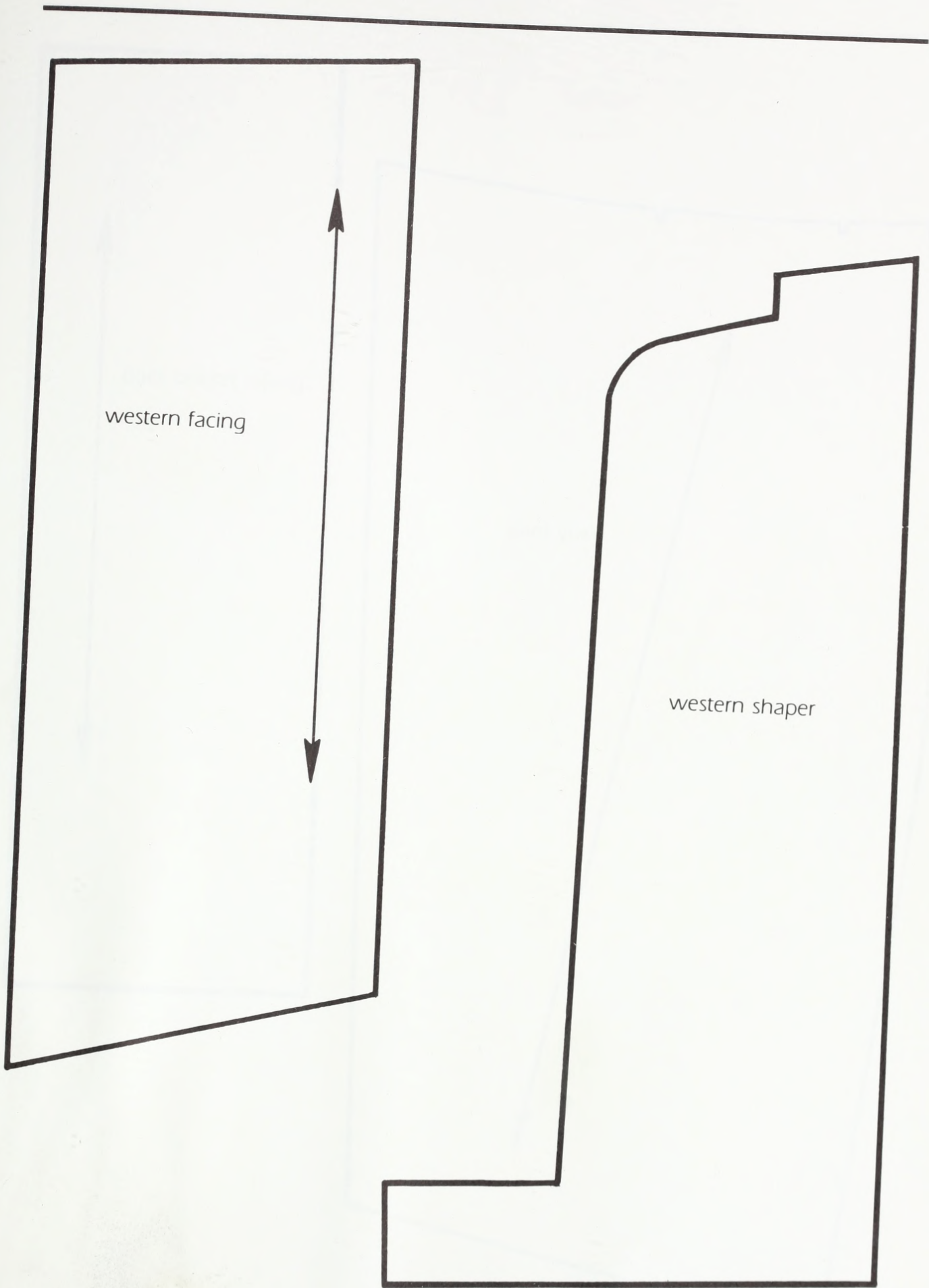

western facing

western shaper



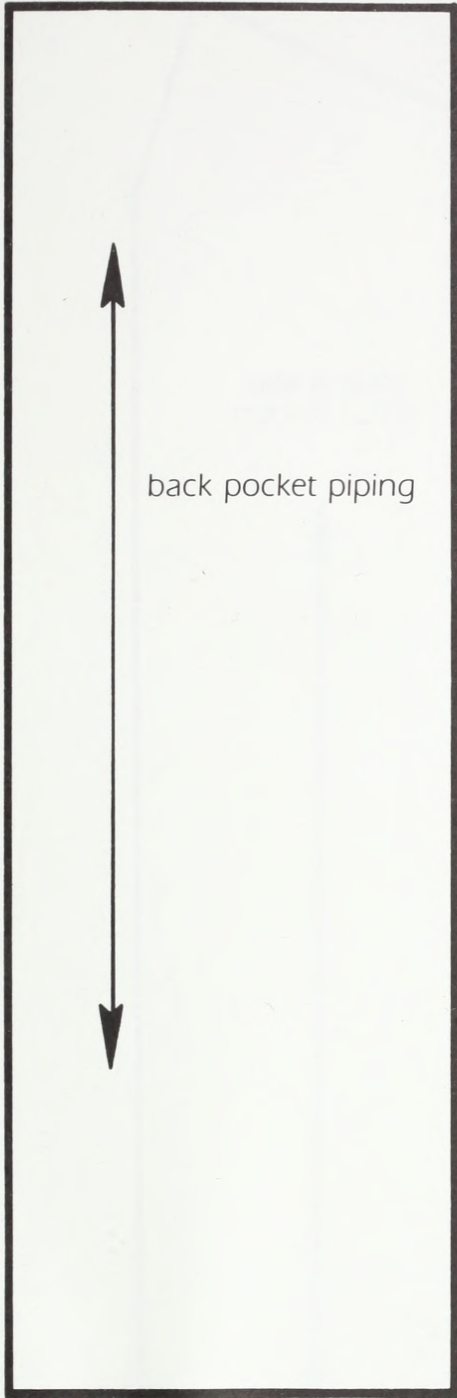

back pocket piping

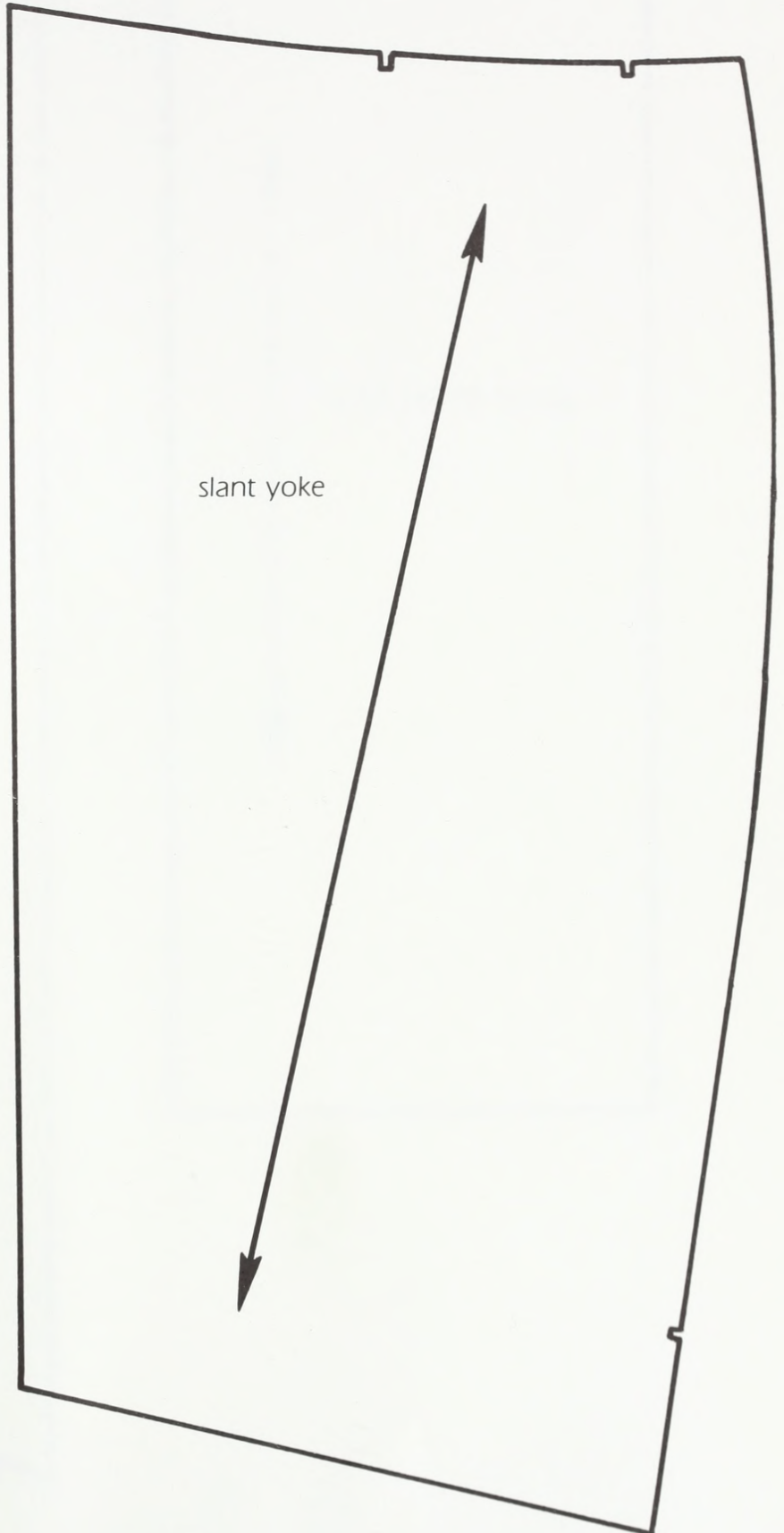

slant yoke





Back to front

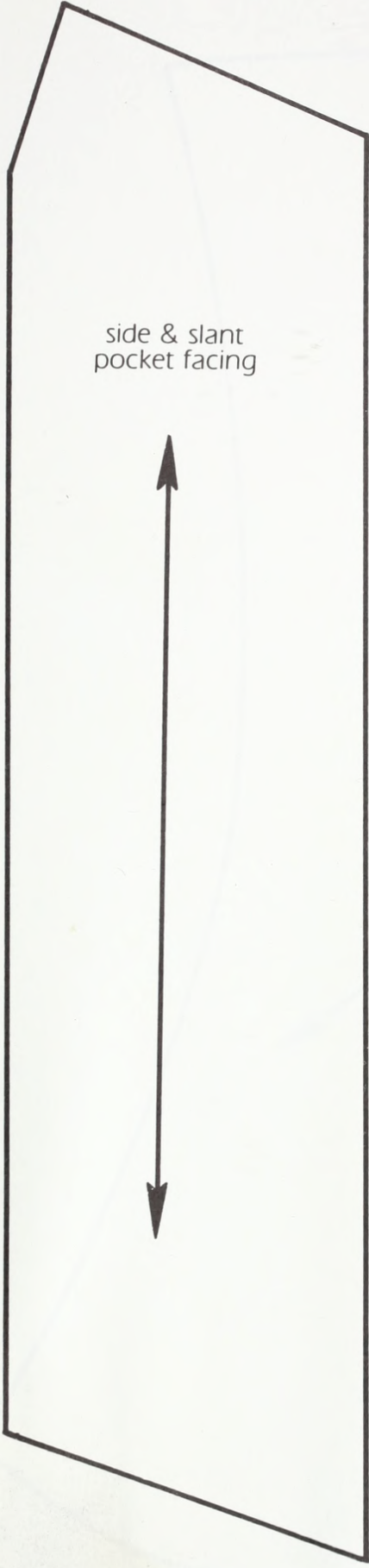

side & slant
pocket facing

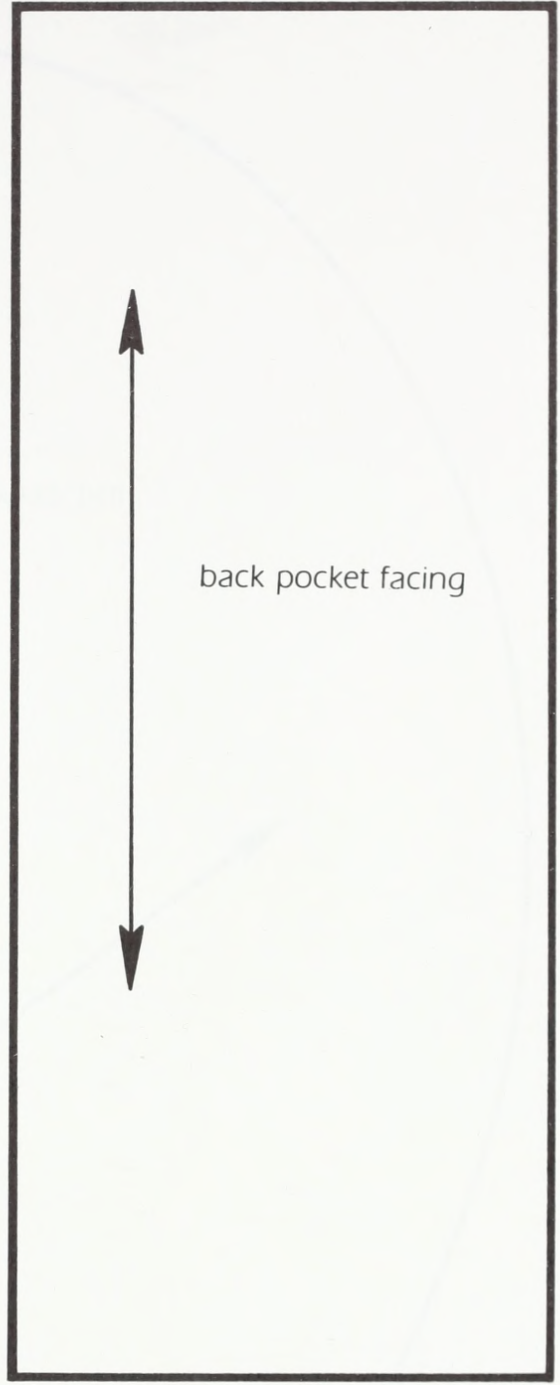

back pocket facing

Faint header text at the top of the page, possibly a title or page number.



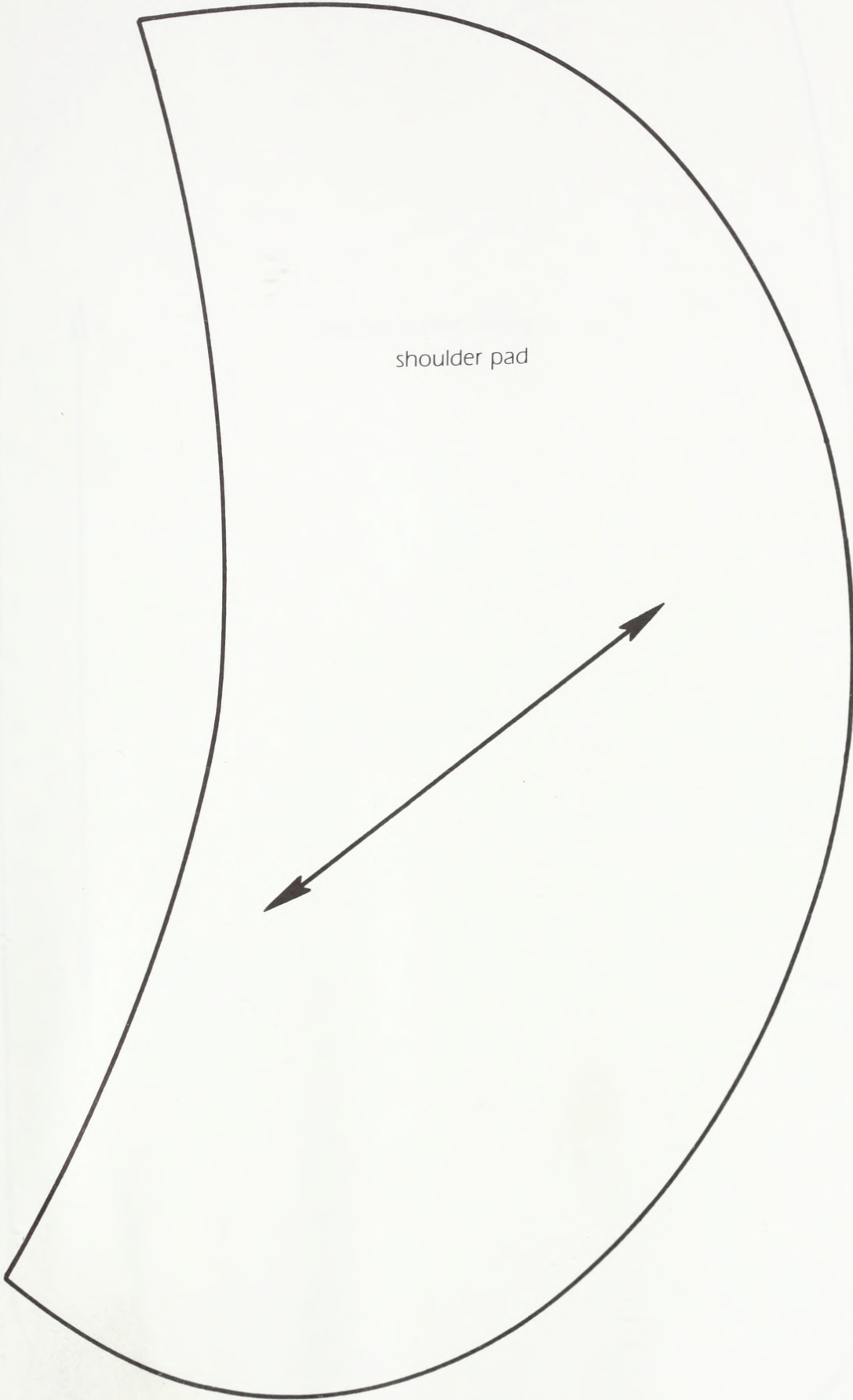

shoulder pad

Handwritten text at the top of the page, possibly a title or header, which is mostly illegible due to fading.



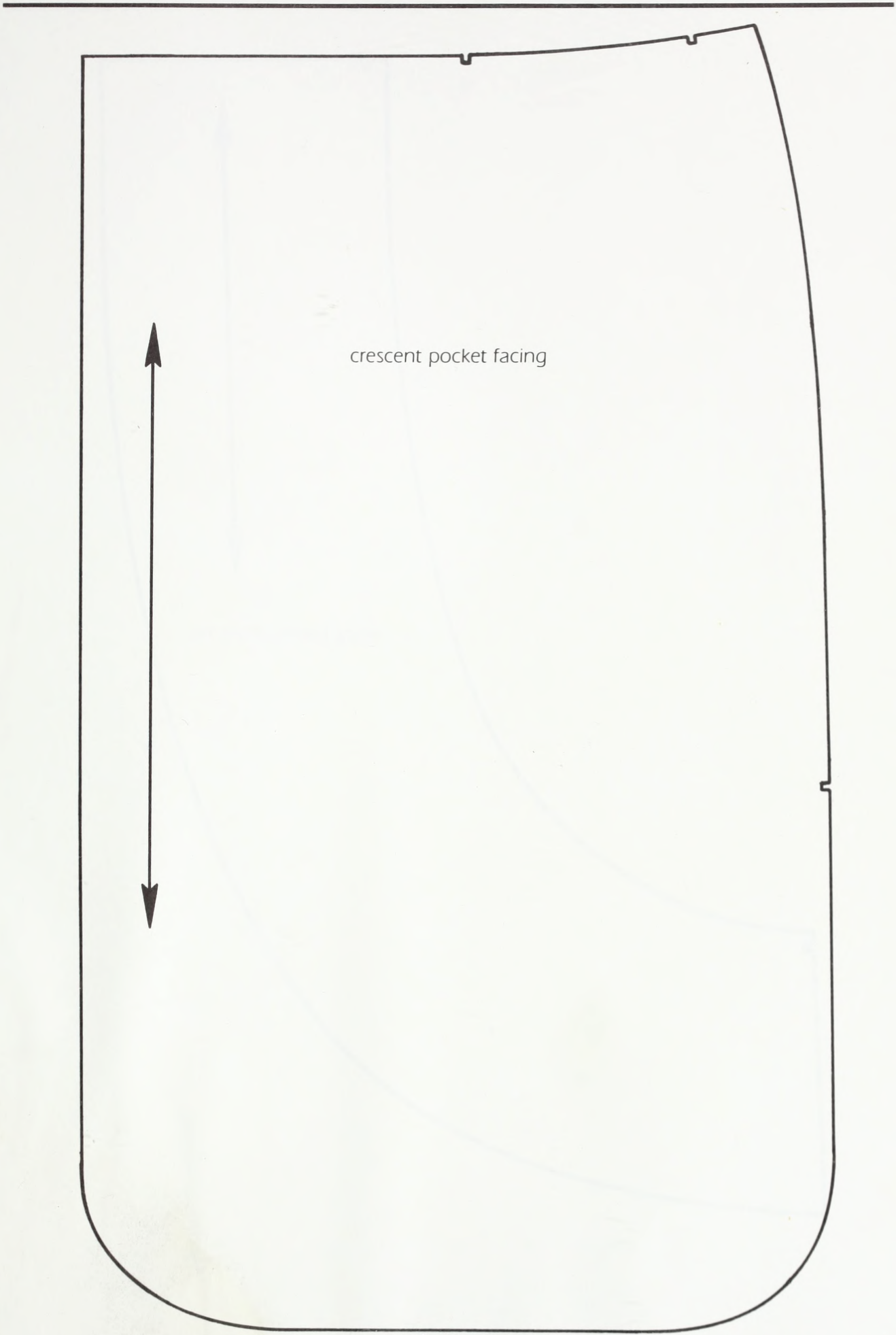



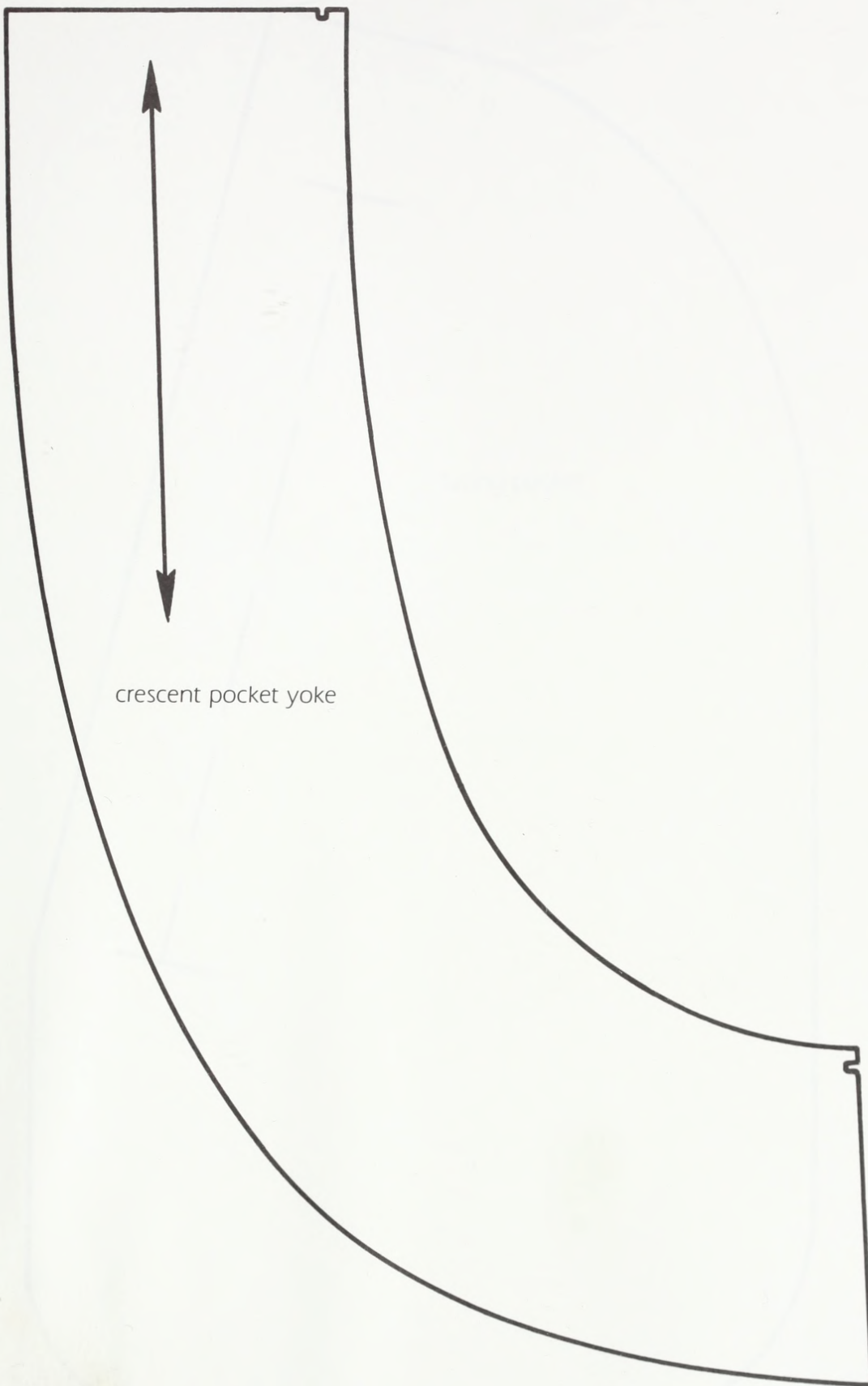

crescent pocket yoke



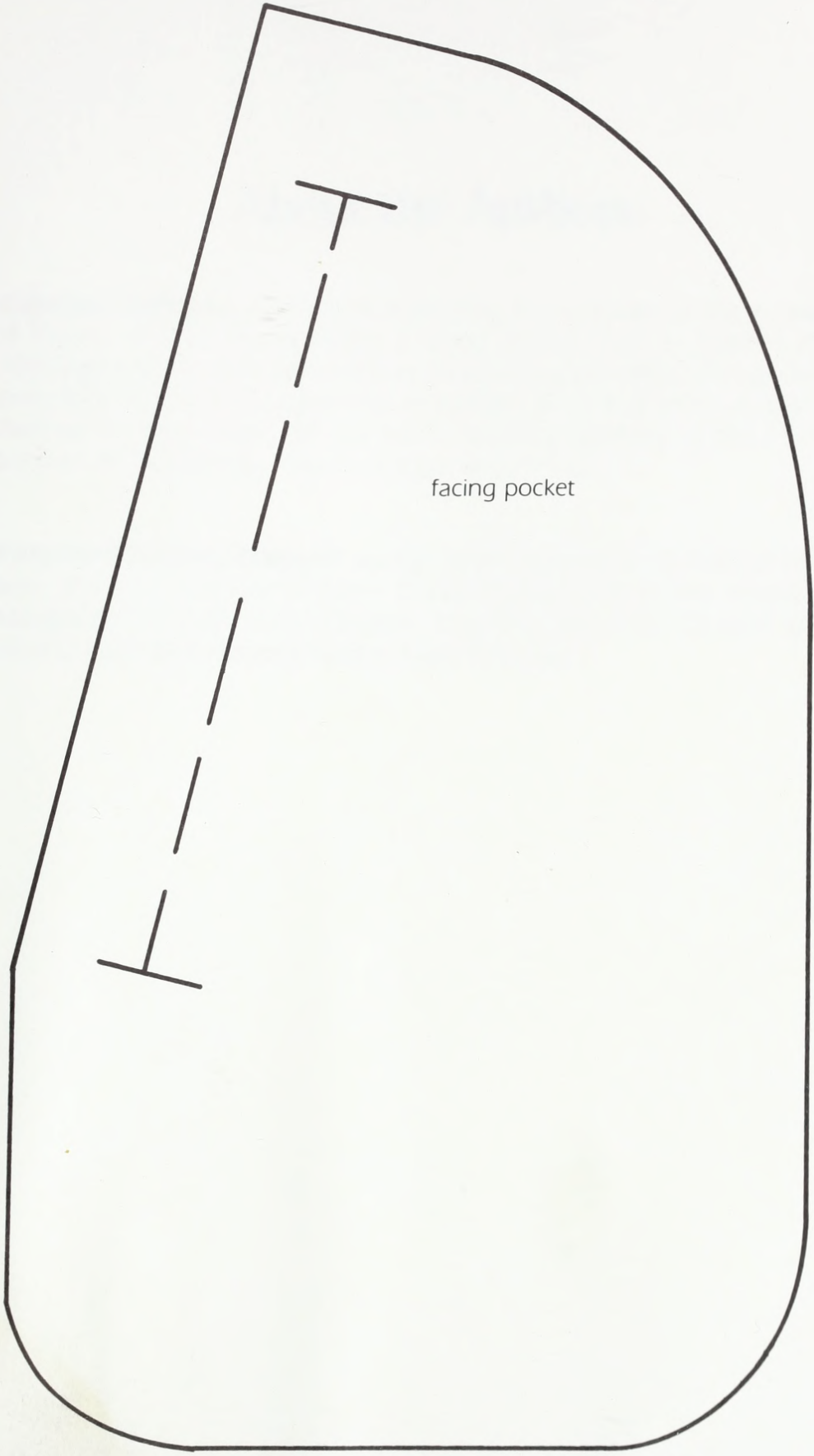

facing pocket



About the Authors

Roberto Cabrera, a native of Argentina, is a graduate of the Academy of Design and the French-Italian Fashion School, both in Buenos Aires. After apprenticing with tailors in Europe and South America, he opened his own firm—Cabrera Couture—first in Buenos Aires, and then on Madison Avenue in New York. He has been teaching tailoring at the Fashion Institute of Technology, New York City, since 1970.

Patricia Flaherty Meyers' background has been in the field of education. She is a graduate of Notre Dame College and of the Association Montessori International in London, England. She is the Director of the Vera Gander Montessori School in New York City.

About the Authors

Roberto Cabrera, Director of the Center for the Study of the History of the Americas, and the first author of this book, is a professor of history at the University of California, Los Angeles. He has published several books on the history of the Americas and is a frequent speaker at international conferences. He is also a member of the American Historical Association and the American Society for the History of the Americas.

Patricia Fitzpatrick, the second author of this book, is a professor of history at the University of California, Los Angeles. She has published several books on the history of the Americas and is a frequent speaker at international conferences. She is also a member of the American Historical Association and the American Society for the History of the Americas.







