

# Highway Surveying Manual

M 22-97

January 2005



**Washington State Department of Transportation**

Environmental and Engineering Service Center

Design Office



***Alternate Formats:*** Persons with disabilities may request this information be prepared and supplied in alternate formats by calling the Washington State Department of Transportation ADA Accommodation Hotline collect 206-389-2839.

Persons with hearing impairments may access Washington State Telecommunications Relay Service (TTY) at 1-800-833-6388, or Tele-Braille at 1-800-833-6385, or Voice at 1-800-833-6384, and ask to be connected to 360-705-7097.

Additional copies may be purchased from:

Washington State Department of Transportation  
Directional Documents and Engineering Publications  
PO Box 47408  
Olympia, WA 98504-7408  
Phone: 360-705-7430  
Fax: 360-705-6861  
E-mail: [engrpubs@wsdot.wa.gov](mailto:engrpubs@wsdot.wa.gov)

This publication is also available on CD-ROM or via Internet on the WSDOT homepage at <http://www.wsdot.wa.gov/>

This Highway Surveying Manual presents surveyors' methods and departmental rules that apply to highway surveying operations of the Washington State Department of Transportation. The manual is intended to help standardize surveying practices throughout the Department and to be a useful tool for WSDOT survey crews.

Updating the manual is a continuing process and revisions are issued periodically. Questions, observations, and recommendations are invited. The next page is provided to encourage comments and assure their prompt delivery. Use copies of it to transmit comments and attachments, such as marked copies of manual pages. For clarification of the content of the manual, contact the Computer Aided Engineering Branch.

---

HAROLD PETERFESO  
State Design Engineer



|                  |   |      |
|------------------|---|------|
| <b>Chapter 1</b> | <b>Survey Team</b>  | 1-1  |
| 1-01             | General   | 1-1  |
| 1-02             | Responsibilities  | 1-2  |
|                  | 1-02.1 Responsibilities to the Public                                   | 1-2  |
|                  | 1-02.2 Responsibilities to the Contractor                               | 1-2  |
|                  | 1-02.3 Relations with Other Departments and Agencies                    | 1-3  |
|                  | 1-02.4 Right of Entry   | 1-3  |
| <hr/>            |   |      |
| <b>Chapter 2</b> | <b>Safety</b>   | 2-1  |
| 2-01             | Introduction  | 2-1  |
|                  | 2-01.1 Education and Training   | 2-1  |
|                  | 2-01.2 Planning   | 2-1  |
|                  | 2-01.3 Accidents  | 2-2  |
| 2-02             | Working in Traffic  | 2-2  |
|                  | 2-02.1 Wearing Of Personal Protective Equipment                         | 2-2  |
|                  | 2-02.2 Use Of Traffic Control Devices                                   | 2-3  |
|                  | 2-02.3 Safety While Working in Traffic                                  | 2-6  |
| 2-03             | Using Tools   | 2-7  |
|                  | 2-03.1 Machetes   | 2-7  |
|                  | 2-03.2 Axes and Brush Hooks   | 2-7  |
|                  | 2-03.3 Digging Tools, Hand  | 2-7  |
|                  | 2-03.4 Driving Tools, Hand  | 2-8  |
|                  | 2-03.5 Chain Saws   | 2-8  |
|                  | 2-03.6 Pressurized Spray Cans   | 2-9  |
|                  | 2-03.7 Miscellaneous Power Tools  | 2-9  |
| 2-04             | Working Near Railroads  | 2-9  |
| 2-05             | Fence Crossings   | 2-10 |
| 2-06             | Animal Hazards  | 2-10 |
| 2-07             | Snakebites  | 2-10 |
| 2-08             | Poisonous Plants  | 2-11 |
| 2-09             | Power Lines   | 2-12 |
| 2-10             | Electrical Storms   | 2-12 |
| 2-11             | Confined Space Entry  | 2-12 |
|                  | 2-11.1 Definitions  | 2-12 |
|                  | 2-11.2 General Requirements   | 2-12 |
|                  | 2-11.3 Scope  | 2-13 |
| 2-12             | Working in Water  | 2-13 |
|                  | 2-12.1 Boating Operations   | 2-13 |
|                  | 2-12.2 General Responsibilities (For boats less than 26 feet in length) | 2-13 |
|                  | 2-12.3 Operator's Responsibilities                                      | 2-14 |
|                  | 2-12.4 Overloading  | 2-14 |
|                  | 2-12.5 Anchoring  | 2-14 |
|                  | 2-12.6 Fueling Precautions  | 2-14 |
|                  | 2-12.7 Float Plan   | 2-15 |
|                  | 2-12.8 Weather  | 2-15 |

**Contents**

|                  |   |            |
|------------------|---|------------|
| 2-13             | Lifting   | 2-15       |
| 2-14             | Conclusion  | 2-16       |
| 2-15             | Training  | 2-16       |
| <hr/>            |   |            |
| <b>Chapter 3</b> | <b>Equipment</b>  | <b>3-1</b> |
| 3-01             | General   | 3-1        |
| 3-02             | Care of Equipment   | 3-1        |
| 3-02.1           | Total Station and Level                                     | 3-1        |
| 3-02.2           | Hand Level, Clinometer, Compass and Other Small Instruments | 3-1        |
| 3-02.3           | Level Rod and Prism Pole                                    | 3-1        |
| 3-02.4           | Steel Chain   | 3-2        |
| 3-03             | Adjustment of Equipment                                     | 3-2        |
| 3-03.1           | Preadjustment steps   | 3-2        |
| 3-03.2           | Testing and Adjusting the Optical Plummet                   | 3-2        |
| 3-03.3           | Testing and Adjusting the Self-Leveling Level               | 3-3        |
| 3-03.4           | Testing and Adjusting the Hand Level and Clinometer         | 3-4        |
| 3-03.5           | Verification of Calibration of the EDM                      | 3-5        |
| <hr/>            |   |            |
| <b>Chapter 4</b> | <b>Electronic Data Controllers</b>                          | <b>4-1</b> |
| 4-01             | General   | 4-1        |
| 4-02             | Accuracy  | 4-1        |
| 4-03             | Data Controller Setup                                       | 4-2        |
| 4-04             | Gathering Digital Terrain Model Data                        | 4-3        |
| <hr/>            |   |            |
| <b>Chapter 5</b> | <b>Public Lands Survey System</b>                           | <b>5-1</b> |
| 5-01             | History and Background                                      | 5-1        |
| 5-02             | Township Subdivision  | 5-2        |
| 5-03             | Section Subdivision   | 5-4        |
| 5-04             | Restoring Lost or Obliterated Corners                       | 5-7        |
| <hr/>            |   |            |
| <b>Chapter 6</b> | <b>Survey Datums</b>  | <b>6-1</b> |
| 6-01             | General   | 6-1        |
| 6-02             | Horizontal Datum  | 6-1        |
| 6-02.1           | Policy  | 6-1        |
| 6-02.2           | Description of NAD83 (1991)                                 | 6-2        |
| 6-02.3           | Datum Conversions   | 6-2        |
| 6-03             | Vertical Datum  | 6-2        |
| 6-03.1           | Policy  | 6-2        |
| 6-03.2           | Description of NAVD88                                       | 6-3        |
| 6-03.3           | GPS Determined Heights                                      | 6-3        |
| 6-03.4           | Datum Conversions   | 6-4        |
| 6-04             | The Washington Coordinate System of 1983 (WCS83)            | 6-4        |
| 6-04.1           | Policy  | 6-4        |
| 6-04.2           | Description of WCS83  | 6-5        |
| 6-04.3           | Coordinate Conversions                                      | 6-9        |
| 6-04.4           | Computing Project Datum Coordinates From State Plane        | 6-10       |
| APPENDIX A       |   | 6-14       |

|  |      |
|--|------|
| <b>Chapter 7 Accuracy Classifications and Standards</b>  | 7-1  |
| 7-01 Classifications of Accuracy   | 7-1  |
| 7-02 Precision and Accuracy  | 7-1  |
| 7-02.1 Significant Figures   | 7-4  |
| 7-03 Errors  | 7-5  |
| 7-03.1 Types of Errors   | 7-5  |
| 7-04 Least Squares Adjustment  | 7-5  |
| 7-04.1 Data Preparation  | 7-6  |
| 7-04.2 Unconstrained Adjustment  | 7-7  |
| 7-04.3 Constrained Adjustment Procedure  | 7-9  |
| <hr/>  |      |
| <b>Chapter 8 Global Positioning System (GPS) Survey Specifications</b>                           | 8-1  |
| 8-01 General   | 8-1  |
| 8-02 Post Processed GPS Survey Specifications  | 8-1  |
| 8-02.2 Equipment   | 8-2  |
| 8-02.3 General Post Processed GPS Survey Specifications  | 8-3  |
| 8-02.4 Order A and B GPS Surveys   | 8-10 |
| 8-02.5 Primary (Horizontal) GPS Surveys  | 8-11 |
| 8-02.6 Secondary (Horizontal) GPS Surveys  | 8-13 |
| 8-02.7 Tertiary (Horizontal) GPS Surveys   | 8-15 |
| 8-02.8 WSDOT General-Order (Horizontal and Vertical) Post Processed<br>GPS Survey Specifications | 8-18 |
| 8-02.9 Vertical GPS Surveys  | 8-19 |
| 8-03 Real Time Kinematic (RTK) GPS Survey Specifications   | 8-24 |
| 8-03.1 Method  | 8-24 |
| 8-03.2 Equipment   | 8-24 |
| 8-03.3 General RTK Survey Specifications   | 8-25 |
| 8-03.4 Tertiary RTK Surveys  | 8-32 |
| 8-03.5 General-Order RTK Surveys   | 8-33 |
| <hr/>  |      |
| <b>Chapter 9 Total Station System (TSS) Survey Specification</b>                                 | 9-1  |
| 9-01 General   | 9-1  |
| 9-02 The TSS Method  | 9-1  |
| 9-03 General TSS Survey Specifications   | 9-1  |
| 9-03.1 Redundancy  | 9-1  |
| 9-03.2 Equipment Checks  | 9-2  |
| 9-03.3 Set Up  | 9-2  |
| 9-03.4 Field Notes   | 9-2  |
| 9-03.5 Survey Adjustments  | 9-2  |
| 9-04 Second Order Surveys  | 9-3  |
| 9-04.1 Applications  | 9-3  |
| 9-04.2 Horizontal Specifications   | 9-3  |
| 9-04.3 Vertical Specifications   | 9-3  |
| 9-05 Third Order Surveys (Tertiary)  | 9-5  |
| 9-05.1 Applications  | 9-5  |
| 9-05.2 Specifications  | 9-5  |
| 9-06 General Order Surveys   | 9-6  |
| 9-06.1 Applications  | 9-6  |
| 9-06.2 Specifications  | 9-6  |

## Contents

|   |       |
|---|-------|
| <b>Chapter 10 Differential Leveling Survey Specifications</b>         | 10-1  |
| 10-01 General   | 10-1  |
| 10-02 Differential Leveling Method                                    | 10-1  |
| 10-03 General Differential Leveling Survey Specifications             | 10-1  |
| 10-03.1 Sight Distances   | 10-1  |
| 10-03.2 Turning Points  | 10-2  |
| 10-03.3 Benchmarks  | 10-2  |
| 10-03.4 Differential Leveling Survey Notes                            | 10-2  |
| 10-03.5 Adjustment of Differential Leveling Surveys                   | 10-2  |
| 10-04 Second-Order Differential Leveling Surveys                      | 10-3  |
| 10-04.1 Application   | 10-3  |
| 10-04.2 Equipment   | 10-3  |
| 10-04.3 Second-Order Three-Wire Differential Leveling Surveys         | 10-3  |
| 10-04.5 Second Order, Electronic Digital/Bar Code Rod Leveling System | 10-3  |
| 10-05 Third-Order Differential Leveling Surveys                       | 10-5  |
| 10-05.1 Applications  | 10-5  |
| 10-05.2 Specifications  | 10-5  |
| 10-06 Order G (General) Differential Leveling Surveys                 | 10-5  |
| 10-6.1 Applications   | 10-5  |
| 10-6.2 Specifications   | 10-6  |
| <hr/>   |       |
| <b>Chapter 11 Geometrics</b>  | 11-1  |
| Circular Curves   | 11-1  |
| Nomenclature For Circular Curves                                      | 11-1  |
| Circular Curve Equations  | 11-2  |
| Example Calculations for Curve Stationing                             | 11-3  |
| Deflections   | 11-4  |
| Example Calculations for Curve Data                                   | 11-4  |
| Curve Data  | 11-6  |
| Running the Curve   | 11-6  |
| Radial Layout Method  | 11-7  |
| Instrument Set At POC   | 11-7  |
| Offset Curves   | 11-8  |
| Degree of Curvature   | 11-8  |
| Field Record  | 11-9  |
| Spiral Curves   | 11-9  |
| Spiral Curve Elements   | 11-10 |
| Spiral Deflections  | 11-16 |
| Field Procedures  | 11-17 |
| Offset Curves   | 11-17 |
| Vertical Alignment and Superelevation                                 | 11-18 |
| Profile Grade   | 11-18 |
| Vertical Curves   | 11-19 |
| Equations for Crest Vertical Curve                                    | 11-20 |
| Equations for Sag Vertical Curve                                      | 11-20 |
| Equations for Nonsymmetrical Vertical Curve                           | 11-21 |
| Superelevation  | 11-21 |



|   |      |
|---|------|
| <b>Chapter 12 Photogrammetry</b>                                    | 12-1 |
| 12-01 General   | 12-1 |
| 12-02 Glossary  | 12-1 |
| 12-03 Mapping   | 12-1 |
| 12-03.1 Reconnaissance  | 12-2 |
| 12-03.2 Location Design   | 12-2 |
| 12-03.3 PS&E  | 12-2 |
| 12-04 Photography   | 12-3 |
| 12-04.1 Aerial Photograph Section                                   | 12-3 |
| 12-04.2 Aerial Photography  | 12-3 |
| 12-04.3 Print Mosaicking, Mounting, and Framing                     | 12-3 |
| 12-04.4 Placing An Order  | 12-4 |
| 12-05 Field Surveys   | 12-4 |
| 12-05.1 Premarking  | 12-4 |
| 12-05.2 Establishing Control Photogrammetrically                    | 12-4 |
| 12-06 Programming   | 12-5 |
| 12-06.1 Mapping   | 12-5 |
| 12-06.2 Photographic Products                                       | 12-5 |
| 12-06.3 Field Surveys   | 12-5 |
| 12-07 Procedures for Ordering                                       | 12-5 |
| <hr/>   |      |
| <b>Chapter 13 Control Survey Procedures</b>                         | 13-1 |
| 13-01 General   | 13-1 |
| 13-02 Policy  | 13-1 |
| 13-03 Planning and Research   | 13-2 |
| 13-03.1 Responsibility  | 13-2 |
| 13-03.2 Planning  | 13-2 |
| 13-03.3 Research  | 13-3 |
| 13-04 Office Preparation  | 13-3 |
| 13-05 Field Work  | 13-4 |
| 13-05.1 Reconnaissance  | 13-4 |
| 13-05.2 Horizontal Corridor Control (HPGN-D) Surveys                | 13-4 |
| 13-05.3 Horizontal Project Control Surveys                          | 13-5 |
| 13-05.4 Vertical Project Control Surveys                            | 13-6 |
| 13-05.5 Supplemental Control  | 13-7 |
| 13-06 Office Data Processing and Documentation                      | 13-7 |
| 13-06.1 Project Control Diagram                                     | 13-7 |
| 13-06.2 Project Control Report                                      | 13-8 |
| 13-06.3 Special Consideration for Corridor Control (HPGN-D) Surveys | 13-9 |
| <hr/>   |      |
| <b>Chapter 14 Location Survey Procedures</b>                        | 14-1 |
| 14-01 Responsibilities  | 14-1 |
| 14-02 Preliminary Survey Meeting                                    | 14-1 |
| 14-03 Location Survey Request                                       | 14-2 |
| 14-04 Planning  | 14-4 |
| 14-04.1 Safety Planning   | 14-4 |
| 14-05 Research  | 14-4 |
| 14-06 Office Preparation  | 14-5 |

## Contents

|                   |  |             |
|-------------------|--|-------------|
| 14-07             | Field Work   | 14-5        |
|                   | 14-07.1 General  | 14-5        |
|                   | 14-07.2 Topographic Survey   | 14-6        |
|                   | 14-07.3 Pavement Elevation Surveys   | 14-8        |
|                   | 14-07.4 Pavement Elevation Survey Methods                                  | 14-9        |
|                   | 14-07.5 Utility Surveys  | 14-11       |
|                   | 14-07.6 Archaeological Site/Environmentally Sensitive Area Survey          | 14-12       |
|                   | 14-07.7 Spot Location or Monitoring Surveys                                | 14-13       |
|                   | 14-07.8 Vertical Clearance Surveys   | 14-13       |
| 14-08             | Office Data Processing   | 14-14       |
|                   | 14-08.1 DTM Processing   | 14-14       |
| <hr/>             |  |             |
| <b>Chapter 15</b> | <b>Construction Survey Procedures</b>                                      | <b>15-1</b> |
| 15-01             | General  | 15-1        |
| 15-02             | Earthwork and Surfacing  | 15-1        |
|                   | 15-02.1 Clearing and Grubbing  | 15-2        |
|                   | 15-02.2 Slope Staking  | 15-3        |
|                   | 15-02.3 Manual Method  | 15-5        |
|                   | 15-02.4 Conventional Method  | 15-6        |
|                   | 15-02.5 Modified Conventional Method                                       | 15-6        |
|                   | 15-02.6 Global positioning System (GPS) /Real Time Kinematics (RTK) Method | 15-7        |
|                   | 15-02.7 Stake Markings   | 15-7        |
|                   | 15-02.8 Additional Notes   | 15-7        |
|                   | 15-02.9 Grade Control  | 15-8        |
|                   | 15-02.10 Procedure   | 15-9        |
| 15-03             | Drainage   | 15-10       |
|                   | 15-03.1 Culverts   | 15-10       |
|                   | 15-03.2 Sewers   | 15-11       |
| 15-04             | Structure Layout   | 15-12       |
|                   | 15-04.1 Horizontal Control   | 15-12       |
|                   | 15-04.2 Staking  | 15-13       |
|                   | 15-04.3 Vertical Control   | 15-13       |
|                   | 15-04.4 Layout and References  | 15-13       |
|                   | 15-04.5 Checking Layout  | 15-14       |
|                   | 15-04.6 Superstructure   | 15-14       |
|                   | 15-04.7 Documentation  | 15-15       |
| 15-05             | Miscellaneous Construction Surveying                                       | 15-15       |
|                   | 15-05.1 Pit Site/Quarry Site, Stockpiles, Sundry Site, and Reclamation     | 15-15       |
|                   | 15-05.2 Erosion control  | 15-17       |
|                   | 15-05.3 Guide Post   | 15-17       |
|                   | 15-05.4 Guardrail  | 15-18       |
|                   | 15-05.5 Fencing  | 15-18       |
|                   | 15-05.6 Illumination and Traffic Signals                                   | 15-18       |
|                   | 15-05.7 Signing  | 15-19       |
|                   | 15-05.8 Pavement Marking   | 15-19       |
|                   | 15-05.9 Concrete Curb  | 15-20       |
| 15-06             | WSDOT Standard Color Codes   | 15-20       |
| 15-7              | Post Construction Survey   | 15-21       |
| 15-8              | Equipment Table  | 15-21       |
|                   | 15-08.1 Equipment  | 15-21       |

|  |       |
|--|-------|
| <b>Chapter 16 Monumentation and Survey Records</b>   | 16-1  |
| 16-01 Monumentation and Survey Records   | 16-1  |
| 16-02 Monumentation and Survey Records   | 16-1  |
| 16-03 Geodetic Control Monuments   | 16-2  |
| 16-04 Horizontal Control Monuments   | 16-2  |
| 16-05 Vertical Control Monuments   | 16-3  |
| 16-06 Public Land Survey System Monuments  | 16-3  |
| 16-07 Alignment, R/W, and Property Corner Monuments  | 16-4  |
| 16-08 Documentation  | 16-5  |
| 16-09 Post Construction Monumentation  | 16-6  |
| 16-10 Guidelines For When A Survey Document is Prepared  | 16-7  |
| 16-10.1 What is a survey document?   | 16-7  |
| 16-10.2 What is a preliminary land survey?   | 16-7  |
| 16-10.3 What does a monumentation inventory consist of?  | 16-8  |
| 16-10.4 What determines a need for a Record of Survey or Type 1 Monumentation Map?                     | 16-8  |
| 16-10.5 What determines the need for a Type 2 Monumentation Map?                                       | 16-9  |
| 16-10.6 What determines a need for a Record of Survey on Sundry Site Plans?                            | 16-9  |
| 16-10.7 Who is qualified to prepare the Application For Permit to Remove or Destroy a Survey Monument? | 16-9  |
| 16-10.8 What are WSDOT's Responsibilities of Maintaining a Monument?                                   | 16-10 |
| 16-10.9 What does a Preliminary Land Survey consist of?  | 16-11 |
| 16-11 Survey Monumentation   | 16-12 |
| 16-12 Record of Survey/Monumentation Map Policy  | 16-12 |
| 16-13 Record of Survey or a Type 1 Monumentation Map   | 16-12 |
| 16-14 Type 2 Monumentation Map   | 16-13 |
| 16-15 Monument Markers   | 16-13 |
| 16-16 Definitions of WSDOT Horizontal Control Hierarchy  | 16-14 |
| Exhibit A  | 16-16 |
| Exhibit B  | 16-17 |
| Exhibit C  | 16-18 |
| Exhibit D  | 16-20 |
| 16-17 State Responsibility of Survey Markers – RCW 47.36.010   | 16-20 |



## 1-01 General

Survey teams in the Washington State Department of Transportation (WSDOT) are comprised of office and field personnel. Survey teams perform many important functions.

- Take part in review projects in scoping phase
- Determine survey requirements
- Take part in presurvey conferences
- Survey records research and review
- Evaluate control and monumentation
- Reconnaissance
- Mathematical modeling of Survey Records
- Field work
- Analysis of field and modeled data
- Prepare Survey Maps (work maps, exhibit maps, Monumentation Maps, Record of Surveys, ...)

All this is done to an appropriate level of accuracy for efficient utilization of time, manpower, and equipment.

Survey team members regularly review the following publications:

- Highway Engineering Field Formulas (M 22-24)
- Highway Surveying Manual (M 22-97)
- Design Manual (M 22-01)
- Construction Manual (M 41-01)
- Standard Specifications (M 41-10)
- Standard Plans (M 21-01)
- Contract plans and specifications
- WA state law pertaining to surveying

A Survey Team Leader directs the Survey Party Chiefs. The Survey Team Leader will provide management, oversight and is an integral part of the quality assurance and quality checking process for all survey data. The team leader will provide assurance to the Project Engineer that land surveying work is done in compliance with RCW 58.09, WAC 332-130. A portion of the survey team is the field survey crew. The field survey crew varies in the number of members, but generally consists of a party chief, instrument operator, and a rod person.

## **Survey Team**

The party chief shall have extensive experience on a survey crew and is the person who supervises the crew. The party chief directs the crew, does the planning on how to complete the day's assignment, and usually records the work. The party chief also is required to complete the proper safety training as outlined in Chapter 2 of this manual. The party chief reports to the project engineer or the project engineer's delegate. The delegate would be the assistant project engineer, the chief of parties, or the project inspector.

The instrument operator, appointed by the party chief is responsible for the efficient setup and operation of all the survey instruments. The instrument operator, in the temporary absence of the party chief, directs the crews' activities. Other considerations should be made when the party chief is absent for an extensive period of time.

The other member(s) of the crew are survey team members who are generally less experienced, but willing to learn. Their duties are to set up signs and control the traffic, make measurements with a tape or chain, set up reflector prisms on tripods or staffs, hold the leveling rod, and performs other tasks as directed by the party chief.

In addition to the individual duties of each member, the survey field crew is required to document daily survey activities for project records. Documentation may be in the form of a Daily Diary or a Survey Field Book. Basic entries include the date, names of the crewmembers, weather, equipment, work order number, and a brief description of the job request, point number and H.I. information for all instrument setups and backsights.

All members of the crew are required to pass the WSDOT Basic Survey Training Course. Whenever possible, the party chief should rotate the duties of the crewmembers so that each receives varied training and experience. This is to everyone's benefit and professional growth.

## **1-02 Responsibilities**

### **1-02.1 Responsibilities to the Public**

The public sees WSDOT survey teams as representatives of the department. They are knowledgeable concerning the department's policies and the project at hand. They answer inquiries and requests honestly, openly, and accurately; assuring that the department is well represented. Courtesy, patience, attentive listening, accuracy, truthfulness, and driving practices are all responsibilities of the survey team when in the public eye as a representative of the department and the state.

### **1-02.2 Responsibilities to the Contractor**

On a construction project, the team typically reports to the project inspector or chief of parties or the project engineer's delegate. Section 1-05 of the Standard Specifications basically states that the engineer will set stakes one time and that the contractor will provide safe and sufficient facilities for setting points and elevations. The timing of contractor requests for stakes is addressed in the *Standard Specifications*. Identify all stakes as provided in Chapter 15, Construction Survey Procedures.

### 1-02.3 Relations with Other Departments and Agencies

There are several state laws having to do with the relationship between WSDOT and other agencies as regards surveying activities. State law requires that a permit be obtained from DNR before any existing monument may be disturbed. WSDOT surveyors must, as required by state law, provide survey information to either to the county engineer or auditor. Chapter 16 of this manual, and Chapters 1440 and 1450 of the *Design Manual*, describes these requirements in detail.

The Department of Natural Resources (DNR) maintains a public record of the surveys performed in the state of Washington. WSDOT Geographic Services maintains a web based database of Geodetic Control.

### 1-02.4 Right of Entry

According to RCW 47.01.170 the Department of Transportation has a right to enter upon public or private property for specific purposes. It states in part “The department or its duly authorized and acting assistants, agent, or appointees have the right to enter upon any land, real estate, or premises in this State, whether public or private, for the purposes of making examinations, location, surveys, and appraisals for highway purposes. The making of any such entry for those purposes does not constitute any trespass by the department or by its duly authorized and acting assistant, agents, or appointees.”

Employees entering onto private property should use good judgment and display respect for the owner’s property, such as:

- a) Littering is **NOT** allowed. Obtain permission before setting any survey points, aerial targets, etc. Always remember to clean up the site after the project is complete. (Picking up aerial targets, etc.) In some states it is considered littering leaving a hub and tack. Getting permission from the owners also ensures a much longer life span of the survey marker left on their property.
- b) When entering planted fields, seek permission for vehicular use and acceptable routes of travel to minimize crop damage. Try to use the same tire tracks when leaving.
- c) A rule of thumb for gates: **Leave them as you found them.** When passing through a gate, if it is shut, always make sure it is shut again after you have passed through it. Ranchers are not “happy campers” with surveyors who leave a gate open and allow the livestock to roam freely.
- d) Out of consideration of being neighbors, it is recommended that the Real Estate Services Department or the Project Engineers office send a notice of entry to specific parcels of interest, at a minimum, stating when a survey crew will be in the area. The notice of entry would not be contingent upon prior notice to the owner or tenant, but would specify that notice of the proposed time of entry shall be given to the owner or tenant where practicable. Stopping by the house or office of a parcel, before entering, to gain permission will improve public relations and provides the owner or tenant the opportunity to provide areas of access and areas to avoid.





## 2-01 Introduction

The purpose of this chapter is to provide information regarding acceptable safety and health practices in the performance of assigned, contracted, and permitted surveying operations within areas under the jurisdiction of the Washington State Department of Transportation (WSDOT). Survey personnel need a fundamental understanding of basic safety requirements. They have to recognize possible serious problems and get them corrected to protect employees as well as the public.

Accidents do not happen without cause. The identification, isolation, and control of these causes are underlying principles of all accident prevention techniques. Even accidents caused by natural elements can be controlled to some extent. Accidents caused by phenomena such as lightning, storms, earthquakes, or floods are extremely difficult to prevent. However, even the effects of these can be minimized by taking preventive measures when forewarned. Accidents resulting from extreme forces of nature (natural phenomena) are estimated to be only two percent of all accidents.

### 2-01.1 Education and Training

Just as safety engineering is the most effective way to prevent environmental accident causes (unsafe conditions), safety education is the most effective tool in the prevention of unsafe acts by humans. Through adequate training, survey personnel gain useful knowledge and develop safe attitudes. Safety consciousness developed through education will be supplemented and broadened by specific additional instruction in safe working habits, practices, and skills. Training is a particularly important accident prevention control by developing habits of safe practice and operation.

This chapter is a brief overview of some general safety regulations for surveyors. Surveyors are encouraged to become familiar with the information in:

- *Employee Safety and Health Orientation Handbook*, November 2002, WSDOT Safety Office
- *Safety Manual*, WSDOT, M 75-01, (Safety Office)
- 1-1, “Safety,” of the *Construction Manual*, WSDOT, M 41-01
- K series in the *Standard Plans for Road, Bridge, and Municipal Construction* (Standard Plans), WSDOT, M 21-01
- *Work Zone Traffic Control Guidelines*, WSDOT, M 54-44
- Part VI of the *Manual on Uniform Traffic Control Devices* (MUTCD), AASHTO, and the Washington amendments
- Other pertinent safety standards that are adopted by the department

### 2-01.2 Planning

Advance planning will minimize the survey crew’s exposure to hazardous situations and minimize the delays to the public. Plan to set monuments in the safest possible locations and be completely prepared before setting up the equipment to save time. However, do not sacrifice safety to reduce the time to complete a task.

During any time when the normal function of a roadway is suspended, temporary traffic control planning provides for continuity of function (movement of traffic, pedestrians, cycles, transit operations, and access to property/utilities). The location where the normal function of the roadway is suspended is defined as the work space. The work space is that portion of the roadway closed to traffic and set aside for workers, equipment, and material. Sometimes there are several work spaces within the project limits. This can be confusing to drivers because several miles may separate the work spaces. Adequately sign and delineate each work space to inform drivers of what to expect.

Effective temporary traffic control enhances traffic safety and efficiency, regardless of whether street construction, maintenance, utility work, or roadway incidents are taking place in the work space. Effective temporary traffic control provides for the safety of workers, road users, and pedestrians. At the same time, it effectively provides for the efficient completion of whatever activity suspended normal use of the roadway.

Base the traffic control selected for each situation on type of highway, traffic conditions, duration of operation, physical constraints, and the nearness of the work space to traffic. Typically, no single set of signs or other traffic control devices can satisfy all conditions for a given project. Several may be needed.

No single publication defines detailed standards that will be adequate to cover all applications. The references in 2-01.1, above, contain many layouts for work zone traffic control and custom designs might still be needed.

### **2-01.3 Accidents**

If all else fails and there is an accident, the survey crew is required to have at least one member possessing a first aid card and the crew rig must contain a first aid kit.

As part of the planning phase, identify emergency services in the vicinity and be sure to have plans for things like the best route to the nearest hospital.

The Safety Office equips WSDOT vehicles with vehicle accident packets that contain a cover letter with step-by-step instructions for filling out the forms. Also, they provide all new employees with an *Employee Safety and Health Orientation Handbook* that contains the instructions for personal injury reporting.

## **2-02 Working in Traffic**

### **2-02.1 Wearing Of Personal Protective Equipment**

As stated in the *Safety and Health Policies and Procedures Manual*, all personnel are required to wear the appropriate personal protective equipment during all operations where exposure to hazardous conditions exists.

Frequently, surveyors operate tools that, if not used correctly, can cause harm. Where there is a possibility that an eye injury can occur during the performance of assigned duties, the department is required to supply its employees suitable face shields or goggles. Generally, the department does not provide individuals with prescription safety glasses.

Safety footwear is a substantial boot or shoe, made of leather or other equally firm materials, with the sole and heel designed and constructed for slip resistance. Safety footwear is used for work activities that present foot injury hazards from falling or moving objects, or from other hazards such as burning, scalding, cutting, and penetration. Acceptable safety footwear meets the safety shoe requirements established by the Occupational Safety and Health Act [OSHA] or the American National Standards Institute [ANSI]. Footwear that has deteriorated to the point where it does not provide adequate protection is not acceptable.

Safety-toe footwear is a boot that meets the definition above and extends above the ankle, with a defined heel, slip resistant sole, and a puncture resistant shank, and either steel or composite protection for the toe areas built into the boot. Safety-toe footwear is used for work activities that present frequent exposure to foot injury from heavy objects or equipment. Acceptable safety-toe footwear must have a label attached indicating it meets the specifications of ANSI Z41.

For safety footwear responsibilities, compliance, who must wear safety footwear, allowance reimbursement procedure, etc., please see the “Safety Footwear” Instructional Letter IL 4014.00.

All personnel working or visiting locations designated as “Hard Hat Areas” are to wear approved protective helmets. Inspect these helmets on a regular basis and immediately replace any found to be defective. Helmets are also to be worn any time a supervisor deems it necessary.

Personnel are required to wear high-visibility safety vests and rain gear of approved color whenever working within the right of way, at any time when exposed to traffic, such as driveways, parking lots, and construction sites, and at any other time deemed necessary by the supervisor on-site. At employee option, a T-shirt may be purchased out-of-pocket by WSDOT employees and worn in lieu of the WSDOT Safety Vest by employees during **daylight hours and when not working as a flagger**. T-shirts shall not have any words or “ads” affixed to them. Also, the supervisor and/or Region Safety Officer shall have final approval authority over both the T-shirt itself and its use. The safety VESTs must be worn when flagging and during nighttime operations. In addition, during night operations reflectorized safety vests are required. If rain gear or other outer garment is being worn, the reflectorized vest must be worn as the outer layer.

**T-shirt Standards**

- Standard crew neck
- Base color orange
- Minimum 2 each 2” horizontal yellow bar on front and back at least 2” apart vertically

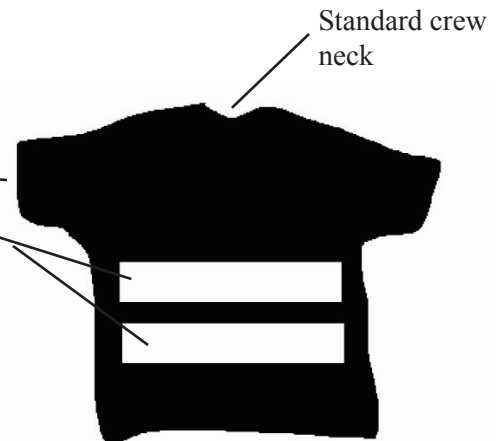

**Note:** Shirt does **not** have to be reflective as the safety VEST must be worn for all night time operations.

**Front and Back**

**2-02.2 Use Of Traffic Control Devices**

Basically, there are two categories: signs and channelizing devices.

**2-02.2a Warning Signs**

Install warning signs prior to the start of all survey work that is on pavement and within 15 feet of the edge of the traveled way. Use them all the time you are working in traffic. Since surveyors are constantly moving on the highway, it is important that warning signs be moved as the work progresses. When you are through for the day, or at any time that work ceases; turn, remove, or cover them. This simple procedure will prevent a host

of potential problems for surveyors as well as motorists. Whenever the activities are changed such that a particular sign or other warning device is no longer appropriate, turn, remove, or cover them and replace if necessary with the appropriate device.

There are three signs used most frequently: WORKERS, SURVEY CREW, and FLAGGER. Signs warning of lane closings ahead, may also be used as appropriate.

See Part VI of the MUTCD for sign sizes and placement height SURVEY CREW symbol or sign is the principle advance warning sign used for traffic control through survey work zones and may replace the ROADWORK AHEAD or ROADWORK sign when lane closures occur, at the discretion of the party chief. Use Type B light or dual orange flags at all times to enhance the SURVEY CREW sign or symbol.

Use advance warning signs at an extended distance of one-half mile or more when limited sight distance or the nature of the obstruction might require a motorist to bring the vehicle to a stop. Extended distance Advance Warning Signs might be required on any type roadway, but particularly on multilane divided highways where vehicle speed is generally in the higher range (45 mph or more). Color, sizes, wording, and placement of signs must conform to approved standards as specified in Part VI of the MUTCD and other safety standards that are adopted by the department. See 2-01.1.

The placement of warning signs is critical to the effectiveness of their individual messages and therefore is customized to meet roadway design and alignment. Mount all signs at right angles to the direction of and facing the traffic they are to serve. Proper positioning gives the driver adequate time to adjust to rapidly changing traffic conditions.

Under certain conditions, it might be necessary to use a series of advance warning signs. In these instances, place the warning sign nearest the work site approximately 500 feet from the point of restriction with additional signs placed at 500 to 1000 foot intervals. On high-speed highways, increase the advance warning distance to one mile or more. On city streets where more restrictive conditions generally exist, warning signs in the immediate vicinity of the work area may be placed at closer intervals to meet the needs of individual survey crews.

Depending on the type of roadway being surveyed, refer to one or more of the references in 2-01.1.

### **2-02.2b Channelizing Devices**

The function of channelizing devices is to warn and alert drivers of conditions created by work activities in or near the traveled way, to protect workers in the temporary traffic control zone, and to guide drivers, cyclists, and pedestrians safely. Channelizing devices include but are not limited to cones, tubular markers, vertical panels, drums, barricades, temporary raised islands, and barriers.

Channelizing devices are elements in a total system of traffic control devices for use in temporary traffic control zones. Precede these elements by a subsystem of warning devices that are adequate in size, number, and placement for the type of highway on which the work is to take place.

For further description and uses of channelizing devices see one or more of the references in 2-01.1.

For the most part, cones that meet department requirements are used to channel traffic through and around a work area. Occasionally, the need arises for the surveyor to close off or separate traffic. Cones are one method used to accomplish this.

If it is necessary to place an instrument or tripod within the traveled way or within 15 feet of the traveled way, protect the tripod with cones according to field conditions. The party chief determines cone spacing to fit roadway and traffic conditions.

### **2-02.2c Arrow Displays**

Arrow display signs are intended to supplement other traffic control devices when closing a lane. See M 21-01, M 54-44, and the MUTCD for arrow display sign placement and specifications.

### **2-02.2d Variable Message Signs (VMS)**

Surveyors may use variable message signs to advise the traveling public of survey work being done on the highway. The information on these signs is to make the drivers more aware of surveyors on the highway and increase the surveyors' safety. They are used to supplement the standard signing in the survey work zone.

### **2-02.2e Flagging Operations**

When operations are such that signs, signals, and barricades do not provide adequate protection on or adjacent to a highway or street, provide flaggers or other appropriate traffic control.

Ensure that all flaggers are well trained and possess valid flagging cards.

Position flaggers far enough ahead of the work zone so that approaching traffic has sufficient distance to stop before entering the work zone.

STOP/SLOW paddles are the primary hand-signaling device.

To control traffic, use the FLAGGER symbol sign before any point where a flagger is stationed. A distance legend may be displayed on a supplemental plate below the symbol sign. The sign may be used in conjunction with appropriate legends or with other warning signs, such as BE PREPARED TO STOP. The FLAGGER word message sign with distance legends may be substituted for the flagger symbol sign.

The party chief may request the support of the State Patrol. A State Patrol car with flashing lights at the beginning of the work zone is one of the most effective ways to reduce speed in the work zone and get the attention of drivers.

### **2-02.2f Vehicle Warning Lights**

The use of flashing amber lights is another tool used by surveyors to let motorists know that they are working in the area. Temporary traffic control activities often create conditions on or near the traveled way that are particularly unexpected at night, when drivers' visibility is sharply reduced. It is often desirable and necessary to supplement retro-reflectorized signs, barriers, and channelizing devices with lighting devices during daytime and nighttime operations. During work operations, use amber lights during the following conditions:

1. When your vehicle is parked in the median without closure of the adjacent traffic lane.
2. When your vehicle is parked on the shoulder and work is being done in the immediate vicinity.
3. When your vehicle is accelerating to move from the shoulder, median, or lane closure into traffic, and when your vehicle is slowing down in preparation to pull off the road onto a shoulder, median, or lane closure.
4. When highway conditions exist which, in the operator's opinion, warrant the use of amber warning lights to protect workers and the public during conditions of reduced visibility such as fog or heavy rain.

## **Safety**

5. Use of amber lights can be required at any other time at the discretion of the supervisor on site.

### **2-02.3 Safety While Working in Traffic**

#### **2-02.3a Safety Rules**

The following safety guidelines will be beneficial for surveyor's working in traffic.

1. Always face traffic when working on the traveled way of a divided road or on shoulders of highways. If you cannot do this yourself, have a coworker act as a lookout. When working in a zone between two-way traffic, stand parallel to the traveled way and again use a lookout.
2. Do not make sudden movements that might confuse a motorist and cause evasive action that can result in injury to the motorist or to surveyors.
3. Avoid interrupting traffic as much as possible.
4. Minimize the crossing of traffic lanes on undivided highways. However, the best way to cross is with your vehicle by way of a ramp or service road to assure a safe crossing. If traffic lanes must be crossed on foot, wait for a natural break in traffic. A break in traffic in this instance is defined as all lanes being clear.
5. On high-speed, heavily traveled divided highways, do not walk or run across traffic lanes. The way to cross is with your vehicle by way of a ramp or service road to assure a safe crossing.
6. Protect your crew with the use of an approved barrier to shield them from traffic. Whenever possible, place a truck-mounted attenuator between your workers and traffic.
7. Proper equipment carrying procedures: When working near a heavily traveled highway, or when working parallel to traffic, be careful to keep level rods, range poles, and such, from extending into a lane of traffic.
8. Take special care when working on wet pavement in an active traffic area.
9. When working on or near high-speed highways, use of a Truck Mounted Attenuator (TMA) to protect the survey crew is strongly recommended. TMA's may be provided by WSDOT (Maintenance) or the contractor.

#### **2-02.3b Inspections**

To ensure that surveyors, contractors, and consultants are following the proper safety procedures, the department will make random safety visits/inspections of WSDOT survey operations. The WSDOT Regional Safety and Health Manager or a designee will make the visit/inspection. The inspector or a supervisor in the Party Chief's supervisory chain has the right and responsibility to cease work until all safety requirements are met. If a party chief repeats safety procedure violations, disciplinary action may be taken.

It is important to note that this rule is for consultants as well as WSDOT personnel. Violating safety procedures and rules can constitute a breach of contract by a contractors or consultant. Fines can be levied against those consultants found to be habitually violating safety procedures and rules. It can also affect his qualification grade since it adversely reflects willingness to cooperate and abide by the department's policies and procedures.

## 2-03 Using Tools

### 2-03.1 *Machetes*

1. Sharpen machete blades only from six (6) inches from the butt of the handle to within two (2) inches of the point.
2. Station machete users at no closer than ten (10) feet intervals. Protect yourself by retaining this minimum safety zone.
3. While chopping, if possible, lean forward.
4. Always chop away from the body.
5. Swing with a full swing at an approximate 45° angle, but do not over swing or swing too hard.
6. Clear small vines, and the like, before cutting larger vegetation.
7. Do not use machetes for heavy cutting.
8. Use long-handled lopping shears or brush hooks instead of machetes for cutting thorny bushes and briars.
9. Wear eye protection/face shield.

### 2-03.2 *Axes and Brush Hooks*

1. Clear away any impeding, light growth with a machete or a hatchet before chopping.
2. Allow ample space between adjacent chopping and keep unessential persons outside the area.
3. Carry with the handle grip behind the head and the cutting edge facing outward.
4. Do not use double-bit axes.
5. Cut extended heavy brush with a chain saw.
6. Wear eye protection/face shield.

### 2-03.3 *Digging Tools, Hand*

1. Picks
  - a. Do not use a pick head that is either sharply pointed or badly blunted.
  - b. Make sure the head is “bound” tightly to a good handle before swinging.
  - c. Allow ample space for swinging.
  - d. Do not over swing on the back swing.
  - e. Use eye protection/face shield when digging in very hard material.
  - f. As you swing, squat by flexing the knees so the pick handle will be horizontal when the point strikes the earth (this will keep the point away from your feet).
2. Shovels
  - a. Use a round-pointed shovel for digging in hard earth.
  - b. Do not use the shovel in the same manner as you use a digging bar. Place the blade of the shovel on the earth and force it into the earth with your foot.
  - c. Keep one foot on the ground at all times.
  - d. Discard a cracked shovel. “Dress” one that has a blunted blade.

## **Safety**

- e. Do not use the shovel as a pry bar.
3. Digging Bars
  - a. Work with the feet widespread.
  - b. Hold the bar close to the body and lift and drop it vertically.
  - c. Keep the point sharp enough to do the job without having to lift bar excessively high.
  - d. Do not use a bar that is bent.
4. Roto Hammers and Power Augers
  - a. Inspect equipment to ensure proper working condition.
  - b. Wear appropriate personal protective equipment while operating equipment.

Operate equipment per manufactures recommended procedures.

### **2-03.4 Driving Tools, Hand**

1. Use the right type and right size tool for each driving operation.
2. Check for defects before using.
3. Do not use hatchets, axes, and other woodcutting or driving tools for driving or hammering metal.
4. Avoid striking brittle or mushroomed metal with a hammer because bits of steel might chip off and cause serious flesh or eye injuries.
5. Use safety glasses/face shield when driving metal objects or cutting anything except paper.
6. Do not use tools with splintered or loose handles or with mushroomed or cracked heads (this includes the driving tools and the implement being driven).
7. Allow ample space for the swinging required. When squatting, use either a short-handled tool, or keep the long handle from between your legs (groin injury can result).
8. When swinging, have the handle horizontal when the face of the driving head contacts the object being driven. Use of long-handled sledges requires flexing the knees to lower the body during the swing.
9. Do not use a full swing to drive objects that are more than waist high.
10. Do not hold an object for someone to drive by full swinging.
11. When driving masonry nails, spikes, or stakes into pavement or very hard earth, use extra care. Be sure the object being driven is well started before releasing it and driving it with full swings of the hammer.
12. Be sure, when setting an object in the roadway surface, to set it flush to the ground to prevent the possibility of it being struck by a snowplow, becoming dislodged, and becoming a hazard.

### **2-03.5 Chain Saws**

1. Employees must be given proper instructions before being allowed to operate chain saws.
2. Chain sawyers wear hard hats, eye protection, gloves, and chaps.



3. Chain sawyers do not wear any jewelry or excessively loose-fitting clothing that can become entangled in the machine's operating parts.
4. Inspect chain saws prior to each use to assure that all handles and guards are in place and functioning correctly, that all controls function properly, and that the muffler is in good condition.
5. Follow all of the manufacturer's instructions.
6. Fuel chain saws only in safe areas, and not under conditions conducive to fire, such as near smoking areas, hot engines, and the like.
7. Store and dispense from approved, plainly marked safety containers.
8. Start chain saws at least 10 feet away from refueling areas.
9. Start chain saws only on the ground or when otherwise firmly supported.
10. Be certain of footing and clear away all brush that might interfere with cutting prior to starting a cut.
11. Hold chain saws with both hands in order to maintain control of saws during operation.
12. Turn off chain saws when carried in hazardous conditions such as slippery surfaces or heavy underbrush.
13. Do not use chain saws to cut directly overhead or at a distance that will require the operator to lose a safe grip on the saw.
14. Falling of trees, if allowed, may only be done by experienced, trained personnel.

#### **2-03.6 Pressurized Spray Cans**

Serious injuries and costly cleanup have resulted from improper handling of pressurized spray cans.

1. Do not puncture or incinerate.
2. Store at temperature lower than 120° F.
3. Do not carry in vehicle passenger compartments.

Dispose of empty containers properly. Do not discard any spray cans in a receptacle that is normally accessible to children.

#### **2-03.7 Miscellaneous Power Tools**

When using other power tools, always follow the manufacturer's safety procedures.

#### **2-04 Working Near Railroads**

These railroad guidelines are to be used when working within an "operating right of way" and are for the safety of the surveyor and the railroad. The general rules are:

1. Always notify railroad company or authority of survey work to be done within the railroad right of way. (Contact Railroad Liaison in Headquarters Real Estate Services for help.)
2. Always be alert around railroads. Railroad equipment is not always heard, especially if there is other noise. If a railroad car or locomotive is coasting, or if a train is moving slowly, hearing alone might not provide adequate protection. When necessary, use a lookout.

## **Safety**

3. Never crawl under stopped cars and do not cross tracks between closely spaced cars, they might be bumped at any time (the engineer and brakemen work only one side of the train).
4. Do not leave protruding stakes or any holes within 10 feet of the center line of the tracks.
5. Do not park vehicle within 10 feet of the tracks; train crews need this area for their operations.
6. When taping across railroad tracks, support steel tapes above the rails at all times. The contact of both rails simultaneously by a steel tape can activate signals even when laid parallel to the rails. Therefore, only nonmetallic tapes when grounded.

### **2-05 Fence Crossings**

1. Use gates when possible and avoid crossings.
2. Use portable chain link fence climber steps or a trestle ladder.
3. Do not attempt to carry anything when climbing on or over obstacles.
4. Cross barbed wire fences at the center of a span and have a trusted coworker hold the wire(s) for you.
5. When stepping over a barbed wire fence, lay a piece of heavy canvas, such as an empty material bag, over the top strand.

### **2-06 Animal Hazards**

1. Assume that all animals are potentially dangerous.
2. Have owners secure hostile-acting animals before entering enclosures containing such animals.
3. Do not enter an enclosure with high fences if a hazardous animal is within.
4. Carry a pointed lath or a range pole to ward off an attacking animal. Retreat is usually advisable but do not turn your back and run unless you can reach a haven before the animal reaches you.
5. Do not approach, attempt to capture or kill, or attempt to pet either domesticated or wild creatures (this includes snakes and other reptiles).
6. Be especially wary of sick-appearing animals, animals with young, stallions, bulls, bears, and guard dogs.
7. Do not handle dead or seemingly dead animals.

### **2-07 Snakebites**

Snakebites of surveyors are quite rare. Even if preventive measures fail, current knowledge and treatment offer the best prognosis ever for snakebite victims.

Though poisonous snakes are rare, they can be found in the Eastern part of Washington State. Poisonous snakes annually bite 6,500 to 7,000 Americans. Always take the following precautions:

1. Always assume snakes are active. Do not relax your vigil on sunny winter days.
2. Do not make “solo” trips across snake country, which is remote from habitations and frequently used roads.

3. When traversing brush or grassy terrain, use a “decoy” such as a level rod or a lath, alongside your legs. Walk heavily to create vibrations that can be felt by snakes (a snake does not hear).
4. Walk away from the shaded side of clumps and bushes when the weather is hot and sunny.
5. Step atop logs and large rocks, instead of stepping over them and into unseen areas. The safest policy is to walk around such obstacles.
6. Do not jump down from overhangs onto areas where snakes might be hidden from view.
7. Avoid steep climbs if possible where a snake, uphill from you, can strike the upper portions of your body. Bites on the torso, the neck, and the head are much more damaging and more difficult to treat than those on the limbs.
8. Never climb vertical or near vertical faces where handholds on unseen areas above your head are required.
9. Do not attempt, under any circumstances, to capture snakes.
10. Do not try to kill a snake unless it is a positive threat to safety.
11. When necessary to move low-lying logs, large rocks, and boards, use a pry bar, not your hands.
12. Double your precautions at night, especially in warm weather.
13. Keep vehicles near your work area for rapid transport if a snakebite should occur.
14. If at all possible, maintain radio contact with an isolated employee.
15. Know the location of the nearest medical facility where antivenin is available - and the quickest route there.
16. Do not collect rattles. A fine and highly abrasive dust often accumulates inside the rattles and can cause lasting damage to the eyes.
17. Wear high leather boots or snake-leggings in high-hazard areas.
18. Remember that rattlesnakes do not always signal their presence by rattling.

## **2-08 Poisonous Plants**

Poison ivy, poison oak, and poison sumac can cause skin irritation. Learn to recognize these plants so that you can avoid them. Furthermore, if you know when you have touched them, you can start first aid before symptoms appear. The sooner first aid is given for exposure, the milder the effects will be.

Poison ivy is a creeper plant having three leaves on each stem. The leaves are shiny and pointed and have prominent veins. Poison ivy grows along fences and stonewalls and in wooded areas.

Poison oak is a vine similar to poison ivy in appearance, except that the edges of the leaves are more deeply notched. The leaves are arranged in characteristic groups of three.

Poison sumac is a shrub or small tree. Clusters of white berries distinguish the poison sumac from the nonpoisonous sumac.

If exposed to a poisonous plant, wash the affected area of your body promptly and thoroughly with water and soap. The rash starts with redness and intense itching. Later, little blisters appear. If a rash had already developed, do not wash it. Avoid scratching. Get medical attention.

## Safety

### 2-09 Power Lines

1. Regard all power lines as dangerous.
2. Avoid actual contact with or possible arcing to any equipment from electrical lines. In damp conditions, double your precautions.
3. Do not tape across terrain where a tape might possibly be pulled up, into, or lowered atop a power line. Use an E.D.M. instead of taping.
4. Power line elevations - do not make a “direct” measurement of the height of a power line, even with a fiberglass rod.

### 2-10 Electrical Storms

If an electrical storm approaches while you are working, discontinue working and seek shelter.

Do not use any metal objects, such as chains, transits, E.D.M.'s, levels, range poles, or Philadelphia rods during an electrical storm.

The best thing to do is to get into your vehicle or building and wait out the storm.

### 2-11 Confined Space Entry

#### 2-11.1 Definitions

There are two types of confined spaces: permit and nonpermit.

1. **Permit-required confined space (permit space)** A confined space that has one or more of the following characteristics:
  - Contains or has a potential to contain a hazardous atmosphere.
  - Contains a material that has the potential for engulfing an entrant.
  - Has an internal configuration such that an entrant might be trapped or asphyxiated by inwardly converging walls or by a floor that slopes downward and tapers to a smaller cross-section.
  - Contains any other recognized serious safety or health hazard.
2. **Non permit confined space** means a confined space that does not contain any physical hazards or any actual or potential atmospheric hazards capable of causing death or serious physical harm.

#### 2-11.2 General Requirements

The employer evaluates the workplace to determine if confined spaces are present. A confined space is assumed to be a permit-required space unless it can be documented to be a non permit confined space.

The Project Engineer shall ensure that the following are conducted:

1. Confined space awareness training.
2. A survey of their respective areas of responsibility to identify all potential permit-required confined spaces (PRCS).
3. An evaluation of the potential PRCS to identify hazards for each confined space.

4. An evaluation of the hazards, considering the scope of hazard exposure, magnitude of hazard; likelihood and consequences of hazard occurrence, changing conditions/activities, and impact on the need for emergency response.
5. Based on the evaluation of hazards, classify and list confined spaces as either permit-required or non permit confined spaces.

### **2-11.3 Scope**

Practices and procedures to protect employees from hazards of entry and/or work in permit-required confined spaces must be followed without exception.

Entry means the action by which a person passes through an opening into a permit-required confined space and includes work activities in that space. Entry is considered to have occurred as soon as any part of the entrant's body breaks the plane of an opening into the space.

**Note:**

If the opening is large enough for the worker to fully enter the space, a permit is required even for partial body entry. Permits are not required for partial body entry where the opening is not large enough for full entry, although other requirements such as lockout-tagout or respiratory protection might apply.

Some confined spaces are "Immediately dangerous to life or health" (IDLH). IDLH means any of the following conditions:

- Poses an immediate or delayed threat to life.
- Causes irreversible adverse health effects.
- Interferes with an individual's ability to escape unaided from a permit space.

Confined spaces are dangerous work areas and require strict compliance for entry and conducting work operations. Surveyors' work tasks that include work in a confined space, either permit or non permit, must refer to 296-62 WAC, Part M, Confined Spaces, the department's *Safety and Health Policies and Procedures Manual* and the Regional or Headquarters Safety and Health Manager or the Industrial Hygiene Program Manager for further direction and guidance on confined space operations.

## **2-12 Working in Water**

### **2-12.1 Boating Operations**

Technically, a boat is classified as a vessel, but for department purposes they will also be classified as vehicles.

### **2-12.2 General Responsibilities (For boats less than 26 feet in length)**

1. Smoking in boats is prohibited.
2. Employees will only be authorized to use a boat if they have successfully completed an approved safety course.
3. Wear U.S. Coast Guard approved life vests in the boat.
4. Carry a first aid kit in the boat.
5. Avoid standing up in small utility boats.
6. Secure all equipment in the boat before getting underway.

**2-12.3 Operator's Responsibilities**

1. Make sure the boat is in top operating condition and free of tripping and fire hazards.
2. Safety equipment, required by law, is on board, maintained in good condition, and you know how to properly use these devices. Safety equipment:
  - a. Life jackets worn by each person on board.
  - b. Visual distress signal, one electric distress light or three combination (day/night) red flares, or comparable devices.
  - c. Fire extinguisher, Type B-1.
  - d. Sound producing device, some means of making an "efficient" sound signal audible at ½ mile for 4 to 6 seconds (horn, whistle, bell).
  - e. Navigational lights required to be displayed (on) from sunset to sunrise and in or near areas of reduced visibility.
3. File a float plan with a coworker or friend. (See Float Plan below.)
4. Have complete knowledge of the operation and handling characteristics of the boat and know your position and where you are going at all times.
5. Maintain a safe speed at all times to avoid collisions and keep an eye out for changing weather conditions, and act accordingly.
6. Know and practice the Rules of the Road (Navigational Rules) and obey federal and state regulations and waterway markers.

**2-12.4 Overloading**

Never overload your boat with passengers and cargo beyond its safe carrying capacity. Too many people and/or equipment will cause the boat to become unstable. Always balance the load so that the boat maintains proper trim.

**2-12.5 Anchoring**

Anchoring is done from the bow of the boat only.

**2-12.6 Fueling Precautions**

1. Most fires and explosions happen during or after fueling. To prevent an accident follow these rules:
  - a. Refuel portable tanks ashore.
  - b. Extinguish all smoking materials.
  - c. Turn off engines and all electrical equipment.
  - d. Remove all passengers.
  - e. Keep the fill nozzle in contact with the fuel tank and wipe away any spilled fuel.
  - f. Do the "sniff test." Sniff around to make sure there is no odor of gasoline anywhere in the boat.
2. Fuel management - Practice the "One-third Rule" by using: one-third of the fuel going out; one-third to get back, and one-third in reserve.

### 2-12.7 Float Plan

1. Be safe and file a float plan. In case of emergency, pertinent information will be right at their fingertips to enable them to contact the local marine police or Coast Guard with necessary details. A word of caution: in case you're delayed, and it's not an emergency, inform those with your float plan, and be sure to notify them when you return so the float plan can be "closed out" and an unnecessary and costly search is avoided.
2. Include the following in a float plan:
  - a. Type of boat, hull and trim color, fuel capacity, engine type, number of engines, any distinguishing features.
  - b. Name of each person on board.
  - c. Survival equipment on board.
  - d. Communications available, marine radios, cellular phone.
  - e. Trip expectations, depart from, time of departure, proposed route, type of work, return time, return location.
  - f. If operator has not arrived/returned by (date and time) call the Coast Guard or local authority at the following number (give number).

### 2-12.8 Weather

Never leave the dock without first checking the local weather forecast. At certain times of the year, weather can change rapidly and it is important to continually keep a "weather eye" out. If suspected stormy or severe weather is anticipated, return to shore or dock the boat as soon as possible.

Call and close out your float plan when you return.

### 2-13 Lifting

The right way to lift: back injuries are the most common [and most severe] workplace injury. Approximately one-fourth of all on-the-job accidents reported each year involves back injuries and usually happens when the employee is lifting something incorrectly. The following tips can help you lift safely.

Lift, push, and pull with your legs, not your arms or back.

Avoid lifting higher than your shoulder height. Use a step stool or ladder to move objects at these heights.

Use a mechanical aid, such as a dolly, hand truck, or forklift, when you need to move heavy or bulky objects.

Turn by moving your feet, not your hips or shoulders. Twisting can overload your spine and lead to serious injury.

Carry heavy objects close to your body and avoid carrying them in one hand. Avoid a long reach to pick up an object.

Back injuries can be debilitating. Stay on the safe side and lift correctly.

## 2-14 Conclusion

No survey operation is so important or urgent as to compromise safe practice. When any operation becomes hazardous beyond reason due to unforeseen or uncontrollable circumstances, operations will cease until normal conditions have been restored.

Field employees are expected to do everything reasonable to protect the health and safety of themselves, their coworkers, and the public.

Party chiefs are responsible for ensuring safe operating procedures by crew members, instructing subordinates on safe work practices, enforcing safety policy, and setting a positive and safe example.

When planning survey operations, give safety considerations first priority. Such considerations will include, but not be limited to, the optimum time of day (or season) to accomplish a particular job, assignment of more experienced personnel for more hazardous jobs, the use of the “buddy system,” special work zone protection and traffic control requirements, setting monuments in the safest possible locations, and discussion of any recent accident, its cause, and appropriate corrective action.

Each survey party will have at least one member trained in basic first aid. All crewmembers are advised to be familiar with first aid. Each crew will have a first aid kit with them in the field.

Flaggers will be well trained and carry a valid flagging card.

Crewmembers will conform to the department’s policies on use of personal protective equipment, including hard hats, and approved high visibility garments.

When working with others, always be aware of their presence and condition, and be alert for their well-being.

The performance evaluation of all field survey personnel will contain a performance element regarding conduct as it relates to safety and health on the job.

This chapter has given you a brief introduction to some of the safety guidelines established by the Washington State Department of Transportation for surveyors. Other important guidance is in the references in 2-01.1.

The word *safety* can be interpreted in many different ways. To some it can mean to be free from injury, to others it means to be secure from danger. These are both good definitions, but the one WSDOT likes best is “The giving of protection.”

We hope these safety guidelines will give you a little more protection on the highways and roads. There will always be risk for surveyors working in traffic. The odds, however, can be made more favorable.

## 2-15 Training

New field personnel are required to have a definite understanding of what will be expected of them concerning on-the-job safety.

This training is to be accomplished by the supervisor to familiarize new, promoted, transferred, or reassigned employees that will be involved in surveying activities with WSDOT. This instructional training is to be accomplished prior to working on a survey crew.



The (instructional training) may be accomplished through a personal interview, group discussion, or lecture. A training form (Exhibit "A") will be used by the supervisor conducting the instructional training.

Upon completion of the training, the employee is required to sign the form acknowledging the supervisor's briefing.

The form will be forwarded to the Regional or Headquarters Safety Manager to remain on file for the duration of employment. Forms are to be updated every five years.

EXHIBIT "A"  
SAFETY TRAINING CHECKLIST

**Check those items that were reviewed.**

**Ch. 1**

**Working in Traffic**

- The wearing of personal protective equipment
- The use of traffic control devices
- Flagging Operations
- Surveying safety procedures in traffic
  1. Finding old base lines on pavement and then offsetting them.
  2. Tying in a section corner, which is between active traffic lanes.
  3. Bench runs.
  4. Finding utilities on a design survey.
  5. Obtaining elevations for a DTM between active traffic lanes or in a shared turn lane.
  6. Obtaining elevations for a DTM on high-speed highways.
  7. Recovering line monuments from an old base line and placing a new base line in its original position.
  8. Auxiliary lane and lane closures.
  9. Working in intersections.
- Safety inspections
- Use of vehicle warning lights
- Safety rules while working in traffic

**Ch. 2**

**Proper Use of Each Tool**

- Machetes
- Axes and brush hooks
- Digging tools, hand
  1. Picks
  2. Shovels
  3. Digging bars
  4. Roto-hammers, power augers and chain saws
- Driving tools, hand
- Chain Saws
- Pressurized spray cans

**Ch. 3**

- Railroads, working near**

**Ch. 4**

- Fence Crossings**

- Ch. 5            **Animal hazards**
- Ch. 6            **Snakebite**
- Ch. 7            **Poisonous plants**
- Ch. 8            **Power lines  
Electrical storms**
- Ch. 9            **Confined space entry**
- Ch. 10           **Working in water**
- Ch. 11           **Proper lifting procedures**

I hereby acknowledge that I have been briefed on the contents of DOT’s handbook, “Safety for Surveyors” and the above subjects were discussed and explained to me.

I further certify that it is my responsibility to comply with the provisions of department safety procedures and I understand that my own safety as well as the safety of my coworkers, the general public, and department equipment is an inherent obligation and that it is a part of my duties and responsibilities to identify, correct, eliminate, remove, and report hazardous conditions and unsafe practices that might result in an accident. The employee should have in their possession a valid Certified Flagging and First Aid Card within six months of employment or transfer.

Conducted By:

|   |                    |
|---|--------------------|
| Immediate Supervisor Signature              | Employee Signature |
| Immediate Supervisors name                  | Employee name      |
| Job Title                                   | Job Title          |
| Unit  | Date               |
| cc:    Regional/Headquarters Safety Manager |                    |
| Supervisor and/or Field Office              |                    |
| Employee                                    |                    |



## 3-01 General

Tools, supplies, and equipment will be required for nearly all surveying operations. Some tasks may require more specialized equipment, such as GPS packages. See Figures 3-3 for a list of equipment and supplies.

## 3-02 Care of Equipment

If the equipment you use is to function as it is intended, you must take proper care of it. All survey equipment used for horizontal and vertical control must be checked against a standard. Keep records of survey instrument checks and calibrations in the project office, and in the Surveyor's Daily Report (Form 237-010 EF).

### 3-02.1 Total Station and Level

Total stations and levels are delicate and precise tools and should be handled accordingly. When an instrument is being removed from its case or tripod, it should never be lifted by the scope or horizontal axis. The only exception is that a level may be lifted by the scope.

Never leave the instrument unattended when not in use. Never set an instrument behind a vehicle. If it is to be left near a vehicle, set it in view where the driver can easily see it.

When the tripod is not in use, the cap should be fastened snugly. The threads on the tripod head should be kept clean. The graphite from a black stake pencil makes a good lubricant for the threads on the tripod and the instrument. Use a dry lubricant if available, not oil or grease that will trap grit and result in unnecessary wear on the threads. A plastic cover should be placed over the instrument when it is not being used or if it is raining. A hot sun will affect the instrument. Use shade to protect the instrument. Use an umbrella if you must measure in the rain. If the instrument does become wet, air dry it (out of its case) overnight.

### 3-02.2 Hand Level, Clinometer, Compass and Other Small Instruments

Hand levels, clinometers, and right-angle prisms should be kept in their cases when not in use. Right-angle prisms should be closed when not in use. Hand levels should be taken apart and cleaned when they become wet or dirty. Check hand levels and clinometers periodically for accuracy. Especially when these items are new, or dropped. To clean a lens, use a lens cloth or tissue, not a cotton swab. Remove dried concrete with a piece of copper wire. Check compass declination; refer to the latest appropriate USGS quad map for correct declination.

### 3-02.3 Level Rod and Prism Pole

The leveling rod and prism pole must be properly maintained if good quality data are to be collected. The rod-person should guard the rod against physical damage and protect it from the effects of exposure to the outdoor environment. Rods should be placed in a dry place at night if they have been used in wet conditions. Rods should be stored in a vertical position or lying fully supported in a horizontal position. Do not use the rod for a pole vault or to beat down brush. Keep fingers off the face of the level rod as much as possible. Excessive handling will wear off the numbers. Striking the rod against rocks, trees, signs, vehicles, etc., can chip the special material used for rod scales, making it

## **Equipment**

difficult to continue observing precisely and efficiently. Keep the screws on the level rod hardware snug, but do not over tighten. The tape on the Lenker rod should be checked frequently. If a tear develops, the tape should be replaced. Check multi-section rods occasionally and adjust as needed.

### **3-02.4 Steel Chain**

- Never pull a chain around a post, stake, or other sharp object.
- Do not allow the chain to be run over by any vehicles.
- Be very careful to avoid kinks or sharp bends in the chain.
- Do not hold the chain by bending it around your hand or standing on it.
- Use the chaining clamps.

When the chain gets wet, it should be wiped dry and treated with a rust preventive spray. A chain on a reel should be wound backwards until the chain is loose and then be sprayed. The chain does not have to be dry since the spray will displace the water. If the chain is muddy, wash it before treatment. After a while, the spray will cause the chain to get oily and hard to read; therefore, periodically wipe it with a clean dry cloth. A chain cared for in this manner will last for many years, even when it is used daily in coastal areas.

## **3-03 Adjustment of Equipment**

In order to obtain consistent results from your survey instruments they must be kept in good adjustment. Trained personnel must do some adjustments in a shop. Total stations should be sent in once a year for cleaning and adjustment. However, most common adjustments can be taken care of in the field. The following data is generally applicable to most instruments. For individual brands and types consult the manufacturer's recommendations, if available.

### **3-03.1 Preadjustment steps**

Before you decide to adjust your instrument you should test it in the proper manner to make sure adjustment is necessary. The following steps are recommended. Choose a cloudy day if possible. Heat waves make it nearly impossible to obtain accurate readings. See that the tripod is in good condition. Tighten the shoes and all other hardware. Set up on firm ground where you can see at least 200 feet in each direction and where the ground is fairly level. Do not set up on asphalt on a warm day as the instrument may settle during the test. Spread the legs uniformly and set them firmly in the ground. Set up so that the tripod is nearly level. Level up the instrument. Allow the instrument to set up for a few minutes to allow it to adjust to the outside temperature.

### **3-03.2 Testing and Adjusting the Optical Plummet**

The method of adjusting an optical plummet involves moving the adjusting screws. The configuration of adjusting screws is not standard among the manufacturers. The adjusting screws are either capstan screws with four holes in the caps that allow you to insert an adjusting pin, or slotted screws that can be turned with a screwdriver. Whatever configuration the adjusting screws, the process of adjusting the optical plummet is as follows:

Mount one tribrach on the tripod with the adjusting adapter in place. Mark a point on the ceiling above the tripod. Place the tribrach to be adjusted on the adapter in an inverted position. Using the lower tribrach put the cross line on a point directly on the ceiling point. Rotate the upper tribrach  $180^\circ$ . Adjust one half of the error with the adjusting screws. The other half of the error is adjusted with the lower tribrach (foot) screws. Check in each quadrant and adjust as necessary. The above procedure is for use with a special adapter and two tribrachs. Other optical plummet adjustments (an alidade with a plumb bob or without a special adapter) are out lined in the instrument manual.

### 3-03.3 **Testing and Adjusting the Self-Leveling Level**

There are several different makes in use throughout the state. You should consult the manufacturer's instructions before any adjustments are made. Most procedures are the same for all makes but the adjusting screws may be in different locations. Before adjusting the level, follow the pre-adjustment steps shown above. Now you are ready to make the tests to see if adjustment is required.

**(a) To see if the circular bubble stays centered when the level is rotated**

This is very important because to get the maximum benefit out of the compensator mechanism the bubble should be in adjustment.

TEST: Turn the telescope until it is parallel with two leveling screws. Center the bubble as close as you can. Turn the telescope  $180^\circ$  until it is parallel with the same leveling screws. The bubble should remain centered.

ADJUSTMENT: You will have to check the individual instrument for the location of the adjusting screws. For example on the Zeiss level, you remove the observation prism or unscrew the flat guard ring around the bubble. There are three screws for adjustment. Loosen each screw and then retighten each one evenly, finger tight. Repeat the test. If the bubble is not centered, bring it half way to center with the leveling screws. Bring it the rest of the way by tightening the most logical screw. Do not loosen any of them. Repeat the test. If it does not center, repeat the adjustment until the bubble remains centered when the level is rotated.

**(b) To make the line of sight level**

These are the adjustments usually performed in the field. If you have dropped or otherwise damaged your instrument and cannot get it to come into proper adjustment do not try to take it apart and fix it. Send it to an authorized shop for repairs and adjustment.

TEST: The peg method is described below:

Set up the level on fairly level ground. The test is best done on a cloudy cool day. Drive two stakes 100 feet in each direction from the level. These are points A and C in Figure 3-1.

## Equipment

Take a rod reading in each direction (with the same rod or a matched pair). Read the rod carefully estimating to the nearest 0.001 foot. Compute the difference between the two readings. This is the true difference in elevation between the two stakes. In Figure 3-1 the true difference in elevations is  $4.027 - 3.875 = 0.152$ . Next, set up about 20 feet (10 percent of total distance) behind one of the stakes. See Figure 3-2. Read the rod on the near stake. In the example, 4.132 at A. The rod reading at C should equal the rod reading at A plus the true difference in elevation ( $4.132 + 0.152 = 4.284$ ). The difference between this number and the actual rod reading at C is the error to be corrected by adjustment. Loosen the top (or bottom) capstan screw holding the cross hairs of the eyepiece, and tighten the bottom (or top) screw to move the horizontal hair up or down and give the required reading on the rod at C. Several trials may be necessary to get an exact reading.

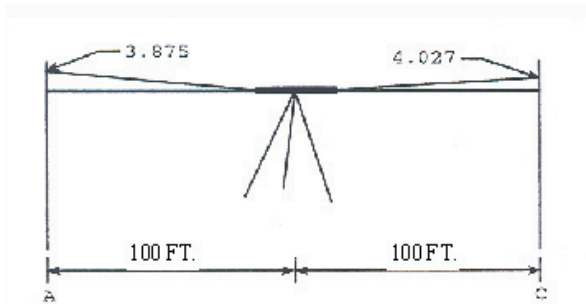

**Peg Method, Setup #1**  
**Adjusting the Self-Leveling Level**  
*Figure 3-1*

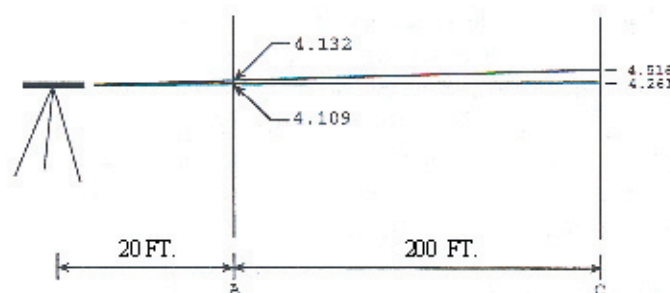

**Peg Method, Setup #2**  
**Adjusting the Self-Leveling Level**  
*Figure 3-2*

### 3-03.4 Testing and Adjusting the Hand Level and Clinometer

The hand level can be adjusted by the peg method. You should check it frequently. Peg the hand level at 50 feet as follows:

- Set two stakes 50 feet apart.
- Position yourself halfway between them to determine difference in elevation. Do not hold the hand level.
- Use a stand.
- Stand at one stake and shoot the other. Adjust the adjusting screw until the same difference in elevation is read. The screw is located in the objective end. You will have to remove the glass lens. You can also check your hand level against a level when this is convenient.



The clinometer should be pegged or checked against a level when you use it. Set the vernier at zero degrees and peg it the same as a hand level. If it requires adjustment there are adjusting screws on the level bubble tube.

### **3-03.5 Verification of Calibration of the EDM**

If the electronics of an EDM require adjustment or repair, only a qualified technician with the proper equipment should do it.

WAC 332-130-100 requires annual calibration of distance measuring devices. To calibrate an EDM, follow the procedures in NOAA Technical Memorandum NOS NGS-10.

Set the instrument up on a calibrated test range and check the distances measured to the different distance monuments. If the measured distances fall within the manufacturer's tolerances, note the measurement differences for correcting field measurements. If the measured distances exceed the tolerances, have the instrument checked for faulty electronics. Make sure that the errors are not due to faulty field procedures. Some of these errors are:

- Instrument or prism not exactly above points.
- Prism not matched to instrument.
- Atmospheric corrections not set in.
- Errors in height of instruments or reflectors.
- Instrument has not been given sufficient time to adjust to local temperature/pressure/humidity. Let the instrument warm up before measuring.

To adjust the optical plummet of the tribrach, see Testing and Adjusting the Optical Plummet earlier in this chapter. Before checking an EDM on a certified calibration base line, consider the following:

- Legs on the tripod tight?
- Tribrachs in adjustment?
- Barometer set correctly? (not corrected to sea level)
- Thermometer correct? (1° C can change reading by 1 PPM)
- Atmosphere corrections set in EDM?
- EDM given time to warm up and adjust to local atmospheric conditions?
- Prism matched to EDM?
- Prism and EDM at same HI? (If not, EDM with slope correction)

## Equipment

### Surveying Equipment

|   |  |
|---|--|
| Survey vehicle with adequate storage capacity | 100' steel chain                               |
| Total station with a minimum of two batteries | Chain clamps                                   |
| Automatic electronic digital level with -     | 50' and 100' fiberglass reinforced cloth tapes |
| 2 rods and turtles                            | Range poles or pickets                         |
| Automatic level                               | Clinometer                                     |
| Data collector (2)                            | Fiberglass rod (25') w/prism adapter           |
| Tripod legs (5)                               | Magnetic compass w/declination adjustment      |
| Tribrachs (5)                                 | Right angle prism                              |
| Single prisms with targets (5)                | Calculator with trig functions                 |
| Triple prism with targets (1)                 | Thermometer                                    |
| Extendable prism poles (3)                    | Barometer                                      |
| Rain covers for survey instruments            | Rod fisheye-level                              |
| Umbrella sun shade                            | Plastic targets                                |
| Two-way radios with -                         | 1 foot targets                                 |
| Speaker mikes 1½ mile range (3)               | Plumb bob with sheath                          |
| Philadelphia rods (2)                         | Hand level with sheath                         |
| Lenker rods (2)                               | Metal locator                                  |
| 25' pocket tape (3)                           | Carsonite markers w/driver                     |
|   | Stamping dyes                                  |

### Supplies

|   |                                       |
|---|---------------------------------------|
| Spray paint (PINK)                      | Railroad spikes                       |
| P.K. nails                              | RP aluminum tags                      |
| Plumb bob string                        | Aluminum nails                        |
| Keel (blue, yellow)                     | Box nails and double headed nails     |
| Hub tacks                               | Oil or silicone spray (WD-40)         |
| Wooden guineas                          | Dry lubricant (for instrument screws) |
| Duct tape                               | Extra plumb bob points                |
| Hubs – 4 inch, 6 inch, 12 inch          | Lens cloth/tissue(s)                  |
| Wooden stakes                           | Plastic target                        |
| Wooden lath                             | Tack container                        |
| Ribbon (red, white, blue, yellow, etc.) | 5-gal. water container (potable)      |
|   | # 5 rebar and caps                    |

### Office Equipment / Library

|   |                   |
|---|-------------------|
| <i>Highway Surveying Manual</i>         | All-weather paper |
| <i>Highway Engineering Field Tables</i> | Pencils           |
| <i>Standard Plans</i>                   | Pens              |
| <i>Construction Manuals</i>             | IDR               |
| Field book w/codes-tips                 | Scale             |
| State road map(s)                       | Paper pad         |
| Project package (plans/grades, etc.)    | WSDOT field forms |
| Laptop w/ survey/engineering software   | Stapler           |
| Portable printer                        | Hole punch        |
| Cell phone                              | Rubber bands      |

### Surveying Equipment List

Figure 3-3a

**Tools**

|  |                      |
|--|----------------------|
| Tool kit                                     | Pick                 |
| Digital camera                               | Claw hammer          |
| Tribrach adjusting hub                       | Hand saw             |
| Axe  | Files                |
| 2 lb. hammer                                 | Small whisk broom    |
| 8-12 lb sledge hammers (2) and extra handles | Machete or brush axe |
| Frost pins                                   | Jumper cables        |
| Shovel, digging bar                          | Tow cable            |

**Personal Equipment**

|              |              |
|--------------|--------------|
| Toilet paper | Boots        |
| Rain gear    | Pocket knife |

**Emergency Protocol Procedure(s)**

|                                    |                                      |
|------------------------------------|--------------------------------------|
| Phone list/regional emergency list | Railroad-certified                   |
| First aid-certified                | S.F. 136 Vehicle Accident Checklist* |
| Flagger-certified                  | S.F. 137 Vehicle Accident Report     |

**Safety Equipment**

|                                 |                                |
|---------------------------------|--------------------------------|
| Flares                          | Survey vest (reflectorized)    |
| STOP and SLOW paddles           | Eye and ear protection         |
| Flashlight                      | Gloves (leather and cloth)     |
| First aid kit (16-unit minimum) | Required signs and standards   |
| Fire extinguisher               | Insect repellent               |
| Traffic cones (24") 15 min      | Toxic vegetation barrier cream |
| Hard hat and liners             | Wool blanket                   |

\* Form S.F. 136 is available from Central Stores:  
Commodity Code 7540-005-205

**Surveying Equipment List**

*Figure 3-3b*



### 4-01 General

This chapter provides guidance on electronic data collection, conversion, and processing.

WSDOT uses total station equipment with electronic distance measuring capability and electronic data controllers to obtain field data. The data is imported and processed into WSDOT standard surveying and engineering software.

Full utilization of the power of electronic surveying relies on the concept of a three-dimensional digital terrain model. Significant terrain features are selected, surveyed, and coded so that the computer program can process the data and produce a representation of the existing ground.

Electronic surveying allows the survey team to record and process data, with hand written field notes, sketches and very little manual data entry. The instrument person must enter the WSDOT Standard Survey Code for each point with parameters and notes if needed into a data controller. The observation data is transferred directly by the total station to the data controller. The field crew downloads the survey data from the data controller to a folder on the hard drive of a personal computer and then processes the data in CAiCE software. Processing of the data includes editing, analysis, and visual inspection in 2-D and 3-D views in CAiCE, sometimes this is an iterative process. The field surveyor has the most knowledge of field conditions and with good field notes is the logical person to do the data processing. But cross training of processing duties is essential for all members of the survey team.

Members of the team review the project and select the most appropriate method or methods of data collection for the terrain and requirements of the job. The digital terrain modeling (DTM) method (also called selective point and breakline method) is the preferred method for collecting data that will be used to develop an accurate digital terrain model in CAiCE. The DTM method allows the most versatility for collecting data, keeping in mind that proper coding is critical.

The electronic surveying system is dependent on the use of appropriate surveying procedures in the field. It is a tool, which can enhance safety, efficiency, productivity, and accuracy.

The goal is to use an efficient process for obtaining raw data, transferring it to computers, and graphically displaying the resulting design.

### 4-02 Accuracy

The use of a data controller in the recording of field terrain information requires attention to standard survey practices to ensure accuracy.

Field Books shall be supplemental to the electronic data, regardless of the survey method.

The following guidelines apply.

1. Instrument setups must be stable and solid.
2. Check into backsights/benchmarks periodically and before changing instrument setup.
3. Close and adjust project control traverse before collecting DTM or cross section data.

## **Electronic Data Controllers**

4. Accurately measure height of prism and instrument.
5. Double check keyboard input of all angles, coordinates, and elevations.
6. Ensure that accuracy standards are appropriate for the type of work being done.
7. Use WSDOT standard survey codes.
8. Make supplemental notes to accurately describe nonstandard items.
9. Calibrate equipment regularly.

### **4-03 Data Controller Setup**

The current, standard WSDOT data controller software is Carlson's SurvCE. This software can be installed on most Windows CE devices. For the latest information on the set up of this software please refer to the HQ – CAE website at the following address; <http://www.wsdot.wa.gov/eesc/CAE/survey/equipment.htm>. For those still using the previous WSDOT standard data collector, the SDR 33, read the rest of this section below.

The setup of the present standard data controller, the SDR-33 is extremely important in providing a uniform output without double corrections being applied. **This is also true with any other brand of data controller.**

Check the following items in the data controller each time a job is created.

**Job** Create and make a supplemental note of the name you used. (Do not use spaces or periods in the name.)

**Scale Factor** See Chapter 6 for instructions about when and how to make a projection from Washington State Plane coordinates to project datum coordinates. Normally we do not use the Data Controller for projections. If you are using the Data Controller for projections, use the appropriate scale factor. If not using state plane coordinates, use 1.00000000.

**Point ID** (SDR-33 only) Set to **Alpha 14**.

**Autopoint Number** Default starts with 1000 or number(s) can be entered.

**Record Elevation** (SDR-33 only) Set to **YES**. (check manufactures instructions)

**Atmos Crn** (atmospheric correction) Set to **YES**. This will record the barometric pressure and temperature in your notes. Set the PPM on the instrument to **0** or a double correction will result.

**C and R Crn** (curvature and refraction correction) Set to **YES**. Turn on C and R in the instrument. This will not cause a double correction because the instrument only applies this correction on horizontal readings. This will assure that curvature and refraction corrections are applied whether a data controller is used or not.

For the coefficient of terrestrial refraction for Washington State use **0.14**.

**Sea level Crn** When using state plane coordinates and a scale factor, set to **YES**. You must also use real elevations. If a scale factor is not used or you are using assumed elevations then set to **NO**.

**Tolerances** Set tolerances in accordance with the manufacturer's specifications for the instrument being used.

**Units** The following units should be used:

|                        |  |
|------------------------|--|
| <b>Angle</b>           | <b>Degrees</b>   |
| <b>Distance</b>        | <b>US Survey foot</b> Also set the instrument to US Survey foot. |
| <b>Pressure Inches</b> | <b>Hg</b>  |
| <b>Temperature</b>     | <b>Fahrenheit</b>  |
| <b>Coordinates</b>     | <b>N-E-Elev.</b>   |

**Prism Constant**

**2-way instruments:** Set the data controller to the proper constant and it will control the instrument.

If a **Non 2-way instrument** is used, set the data controller to **0** and set the instrument to the proper constant. This will allow the instrument to measure distances properly without the controller attached..

#### 4-04 Gathering Digital Terrain Model Data

When collecting DTM data, the most important person on the survey crew is the rod person. This person sets the pace for the crew and makes many of the decisions about what type of information the survey will provide to the design team. When selecting locations for shots, the rod person must look in all directions for terrain breaks.

Prior to beginning the survey, the crew should carefully plan which standard codes they are going to use for the break lines.

Here is an example of a normal roadway section showing the typical standard codes.

To gather digital terrain model data:

1. Meet with design team to discuss project limits, break lines, and special features.
2. Using total station equipment, run a control traverse with approximately 1500 ft legs. (For Control Survey Guidelines see Chapter 13)
3. Using a bar code level or standard rod and level, run a level circuit through all control points to determine elevations.
4. Set up job in data controller and record in supplemental notes the date, the beginning and ending point numbers, job name, and the crew.
5. Set up and orient the total station.
6. Collimation properly according to the equipment manufacturers instructions.
7. Gather crew together and discuss strategy for collection to prevent over or under coverage.
8. Begin to gather DTM data.
  - (a) Check the configuration on the data controller to ensure that the auto point number is correct (do this daily). Let the data controller do the point numbering.
  - (b) Paint a spot for the beginning or end of breaklines.
  - (c) Collect break line data in the direction of increasing point numbers. (Do not jump back on the same break line.)
  - (d) Use WSDOT standard survey codes and include Left or Right for plotting.

## **Electronic Data Controllers**

- (e) Make supplemental notes to further describe topography items such as catch basins, guardrail anchors, etc.
  - (f) For accurate profiles, do not exceed 50 ft spacing on pavement.
  - (g) For accuracy and a dependable DTM, a maximum of 150 ft spacing is recommended.
  - (h) Do not take shots more than 750 ft away from the instrument.
  - (i) The computer will draw straight lines between points, so more shots must be taken on horizontal and vertical curves.
  - (j) Do not cross three dimensional break lines.
9. Daily download, edit, process, archive the data controller files. Print reports as needed
10. Hand-written field notes.

It is useful to show the location of points relative to permanent objects. Note what the point is (spike, hub & tack, etc.), and how it is referenced.

Make notes that are neat and accurate. Title and index the first page of each operation. On the first page of each day's work, show the date, crew, weather, and instrument by Serial number. Number and date every page. Notes written with the book turned are written with the right edge of the book toward the writer.

Do not use "scratch" notes intending to put them in the book later.

Field records are an important aspect in any survey. A well-executed surveying job is worthless unless it is well documented. Take the time necessary, in the field, to create good records on what you have done.



### 5-01 History and Background

The following information is in reference from the U.S. Department of the Interior, Bureau of Land Management (BLM) book titled: “Manual of Surveying Instructions”. Refer to the BLM Manual for additional information not used in this chapter.

The Public Lands Survey System (PLSS) was originally set up to sell the lands acquired by the U.S. Government in the Northwest Territory (Ohio, Indiana, Illinois, Michigan, and Wisconsin). It was so successful that it was used later to sell land in the Louisiana Purchase, Oregon Territory, Mexican Cession, and Alaska.

The system designates land location east or west of a principal meridian and north or south of a base line. In the state of Washington, the principal meridian is known as the Willamette Meridian (abbreviated as W.M. in legal descriptions). The principal meridian runs north and south from a stone monument established in 1851 located in Portland, Oregon. This stone monument is also on the east-west base line (the Willamette Base Line). See Figure 5-1.

Distances north or south of the base line are described by east-west township lines. The township lines are intended to be at six-mile intervals. A point eight miles north of the base line would then be in the second township north of the base line and would be described as Township 2 North, abbreviated as T.2N. Distances east or west of the principal meridian are described by north-south range lines at approximately six-mile intervals. A point eight miles east of the principal meridian would be in the second range east and would be described as Range 2 East, abbreviated as R.2E.

The combined description of the point would then be in Township 2 North, Range 2 East or T.2N., R.2E.

The Willamette Base Line runs east and west on a true parallel of latitude. To keep the township lines parallel to the base line, *standard parallels* were established at 24-mile intervals north and south of the base line. Similarly, guide meridians were established at 24-mile intervals east and west of the principal meridian. Since meridians converge towards the North Pole, the further the range lines are from the principal meridian, the more they diverge from true north. The guide meridians establish a new starting meridian for the next set of townships. The beginning point of the guide meridian is on the standard parallel or base line and the ending point is at its intersection with the next standard parallel.

## Public Lands Survey System

Thus, on the base line and on a standard parallel, there will be a convergence offset between the guide meridian to the south and the one to the north.

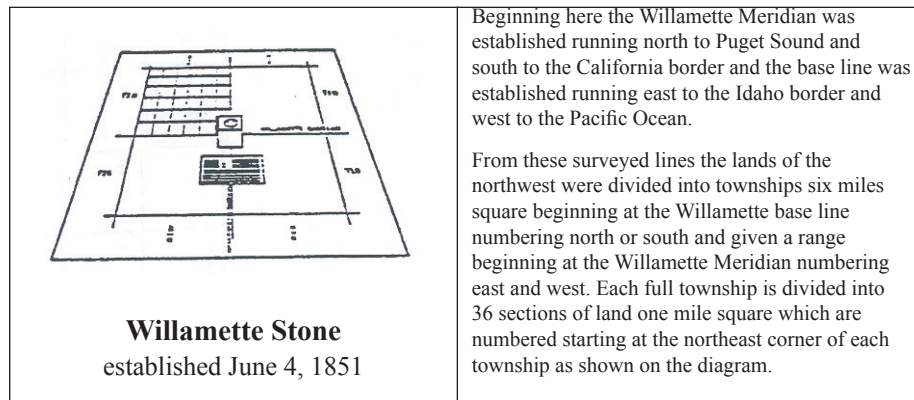

**Figure 5-1**

The final result is a series of quadrangles bounded by meridians and parallels each including 16 townships. See Figure 5-2.

### 5-02 Township Subdivision

Each township, approximately 6 miles on a side, was further divided into 36 sections and monuments were set at the section corners. Each section was intended to be 640 acres or one square mile in area. Variations of angular and distance measurements may vary slightly from today's measurements due to a myriad of factors. The physical location of original monuments set is the true corner even if the theoretical position places it in a very different position.

The numbering of the sections starts at the northeast corner of the township with Section 1 (Figure 5-3) and progresses westerly to Section 6 at the northwest corner of the township.

Section 7 is south of Section 6 and the numbering then increases to the east with Section 12 directly south of Section 1. The numbering continues, alternating between increasing to the east and increasing to the west, then to Section 36 in the southeast corner of the township.

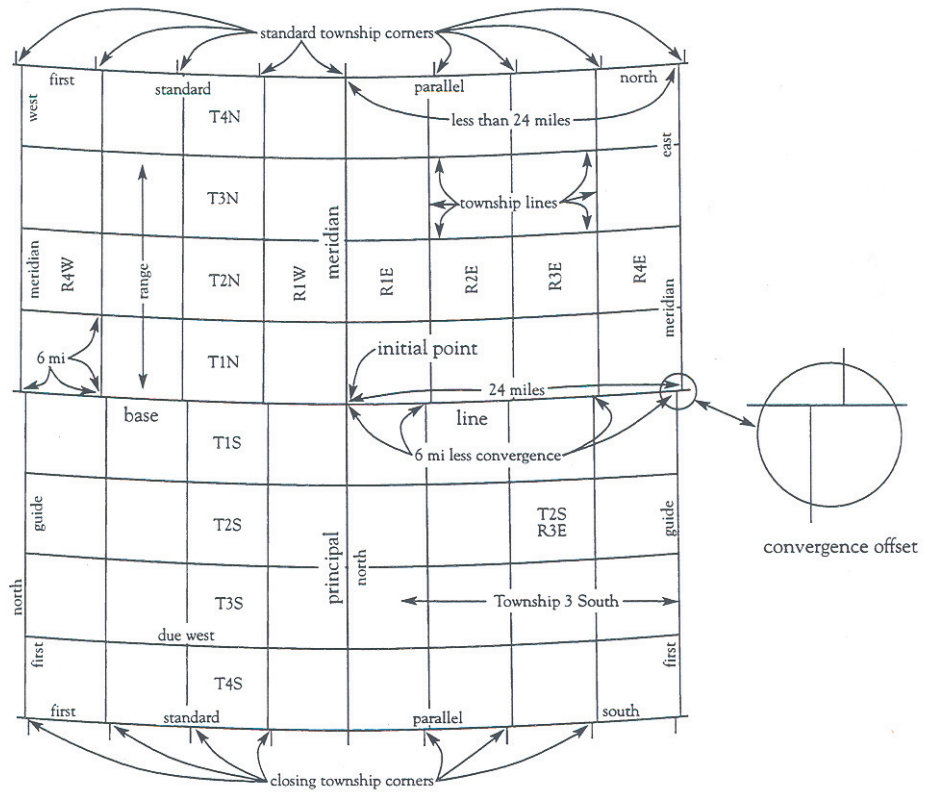

**Principal Meridian, Base Line,  
Standard Parallels and Guide Meridians**  
Figure 5-2.

|    |    |    |    |            |    |
|----|----|----|----|------------|----|
| 6  | 5  | 4  | 3  | 2          | 1  |
| 7  | 8  | 9  | 10 | 11         | 12 |
| 18 | 17 | 16 | 15 | Section 14 | 13 |
| 19 | 20 | 21 | 22 | 23         | 24 |
| 30 | 29 | 28 | 27 | 26         | 25 |
| 31 | 32 | 33 | 34 | 35         | 36 |

**Township Grid**  
Figure 5-3

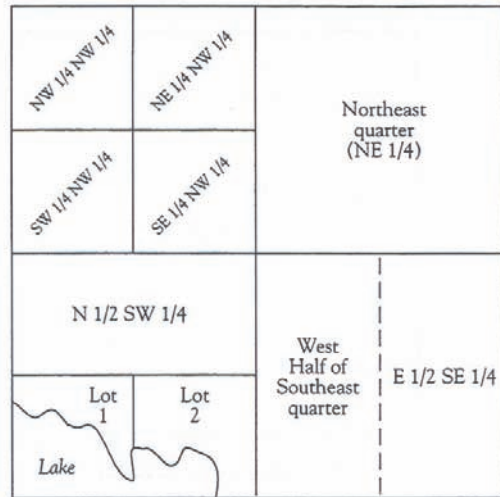

**Section Grid**  
Figure 5-4

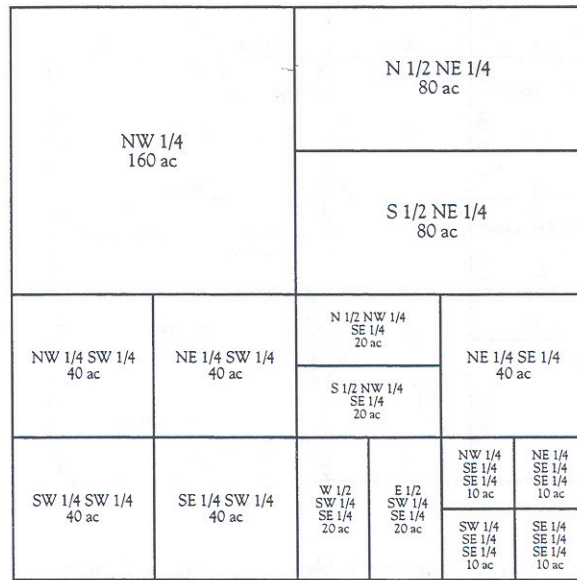

**Nomenclature for Portions of a Section**  
*Figure 5-5*

The dimensions of the sections were measured in chains and links. A chain of 100 links is equal to 66 feet and a link is 7.92 inches. A section was intended to be 80 chains (one mile) on each side.

**5-03 Section Subdivision**

Along with the section corner monuments, quarter corner monuments were set at the halfway point on each side of a section. Thus, the 80 chain sides were theoretically divided into 40 chain (1/2 mile) segments. The original surveyors were not instructed to set a monument at the theoretical center of section (where the lines connecting quarter corners would inter-sect).

Each quarter of a section (1/4 square mile) was theoretically 160 acres and could be divided as shown in Figures 5-4 through 5-7.

Certain areas of land were not available for sale and the boundaries of the Public Lands Survey System (PLSS) stopped at the edge of these areas. Some examples are:

- Indian reservations (IR)
- Donation land claims (DLC)
- Military reservations (MR).
- Some bodies of water
- Mining claims

To establish where the PLSS lines intersected the boundary line, auxiliary corners were set, known as witness corners (WC).

The Surveyor General instructed the surveyors to commence surveying the sections within the Townships by starting at the southeast corner of Section 36. They were to proceed in a northerly direction setting the quarter and section corners as they went. All of the north-south section lines were to be established from south to north moving east to west. These are called Meridional Section Lines. The east west section lines were established from West to East between the meridional section lines as the surveyors worked their way north. These are called Latitudinal Section Lines. In this manner of section line establishment, all of the measuring error was placed in the north and west tiers of the township. This meant that the sections along the north and west lines of any township are irregular sections and have more or less than the standard 640 acre area for a regular section.

The section was broken down into regular quarter sections as much as possible and the irregular pieces were called Government Lots (GL). This same system was also used where the section line intersected one of the reserved areas listed above (IR, MR, DLC, etc.). See Figure 5-8.

In summary, a section is approximately one square mile unless it lies on the north or west side of a township or abuts one of the areas not available for sale. In these irregular sections, there will be a mixture of regular quarter sections and Government Lots.

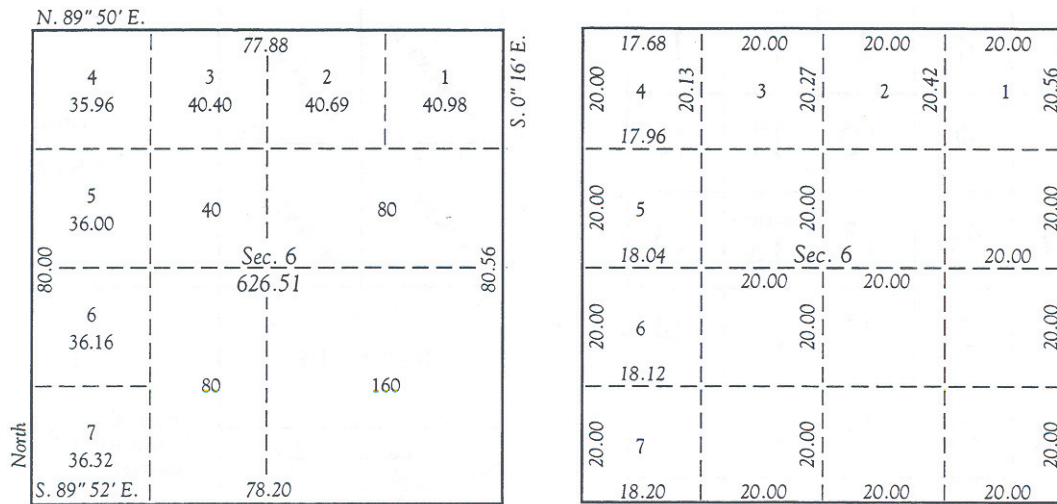

Showing areas in acres

Showing calculated distances in chains

**Example of Subdivision of Section 6**

*Figure 5-6*

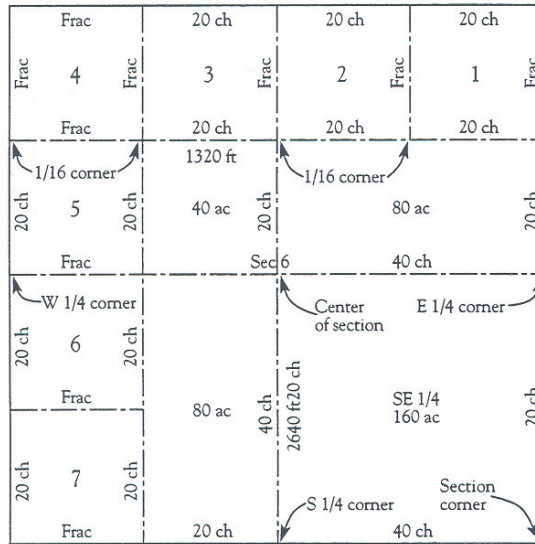

Section 6 has Fractional Measurements of more or less than 20 chains on lines marked "Frac"

**Fractional Measurements**  
*Figure 5-7*

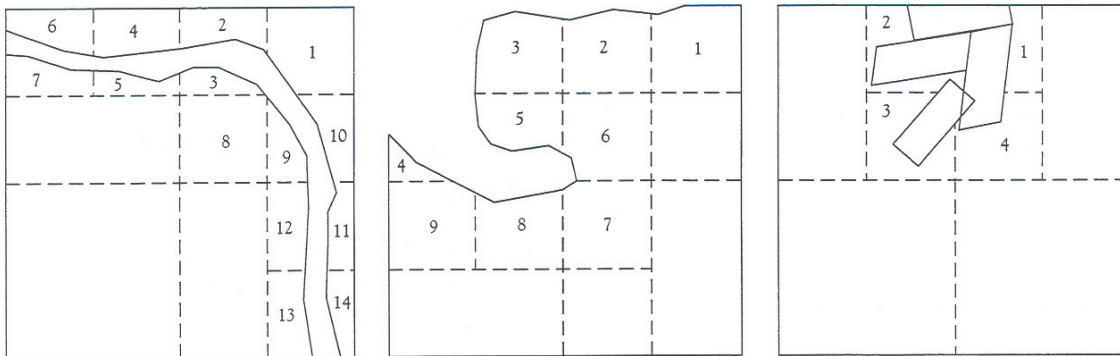

Meanderable River

Meanderable Lake

Mineral Claims

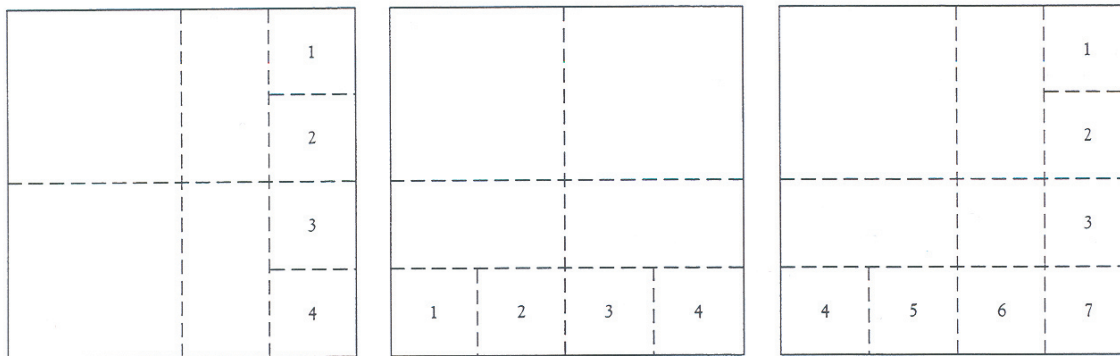

East boundary defective alignment

South boundary defective

East & South boundaries defective

**Example of Government Lots in Irregular Sections**  
*Figure 5-8*

The surveyors used whatever was available as a monument. Where wood was available, they used a post, usually 4" × 4", marked on the side with the section designation. Where wood was not available, they used stone monuments, dug pits, built mounds, or buried a quart of charcoal. See Figure 5-9.

Since the original surveys, government agencies and private surveyors have perpetuated many of the original monuments with more permanent markers.

In addition to monumenting the corners, the original surveyors also marked trees along the boundaries when available. These are known as line trees and were blazed or hacked with an axe. See Figure 5-10.

Similarly, if trees were near a corner, the surveyor recorded the distance and bearing of the tree, removed a piece of bark, and scribed on the living wood tissue.

Often, the bearing tree (BT) had been cut down but the stump may still be there. Since the section corner was also the meeting place of four property lines, it was frequently used as a fence corner. By using the recorded bearings and distances from bearing trees or other reference points, it is possible to verify if an old fence corner was placed at the location of the original section corner. See Figures 5-11 and 12.

In summary, almost anything might have been used to replace an old corner. The problem is then to confirm that what is found at the supposed site of the corner is at the exact location of the old corner and not just in the vicinity.

If there is a record in a survey book that some surveyor replaced the original corner (for example, "a rotten post scribed with proper markings") with an iron pipe, the problem is then to determine if the iron pipe that is found is the same one that was set. If it is possible to measure from other reference points and check the distances, then it is reasonable to accept the pipe as a replacement of the original corner. However, if there is no record of the replacement, the fact that there is an iron pipe does not automatically make it the corner. Any monument is subject to dispute and it is necessary to prove the position of anything other than the original corner. If the corner (or its replacement) is missing, the corner may be either "lost" or "obliterated." An obliterated corner is one that has been destroyed but whose position can be reestablished from other recorded reference points nearby.

A lost corner is one where all evidence of its location is gone. The location can be reestablished by rerunning the original survey. A corner is not considered lost if it has been assigned a coordinate using the Washington Coordinate System of 1983 (WCS83).

#### **5-04 Restoring Lost or Obliterated Corners**

Restoration of a lost or obliterated corner must be replaced by a Professional Land Surveyor See Chapter 16.

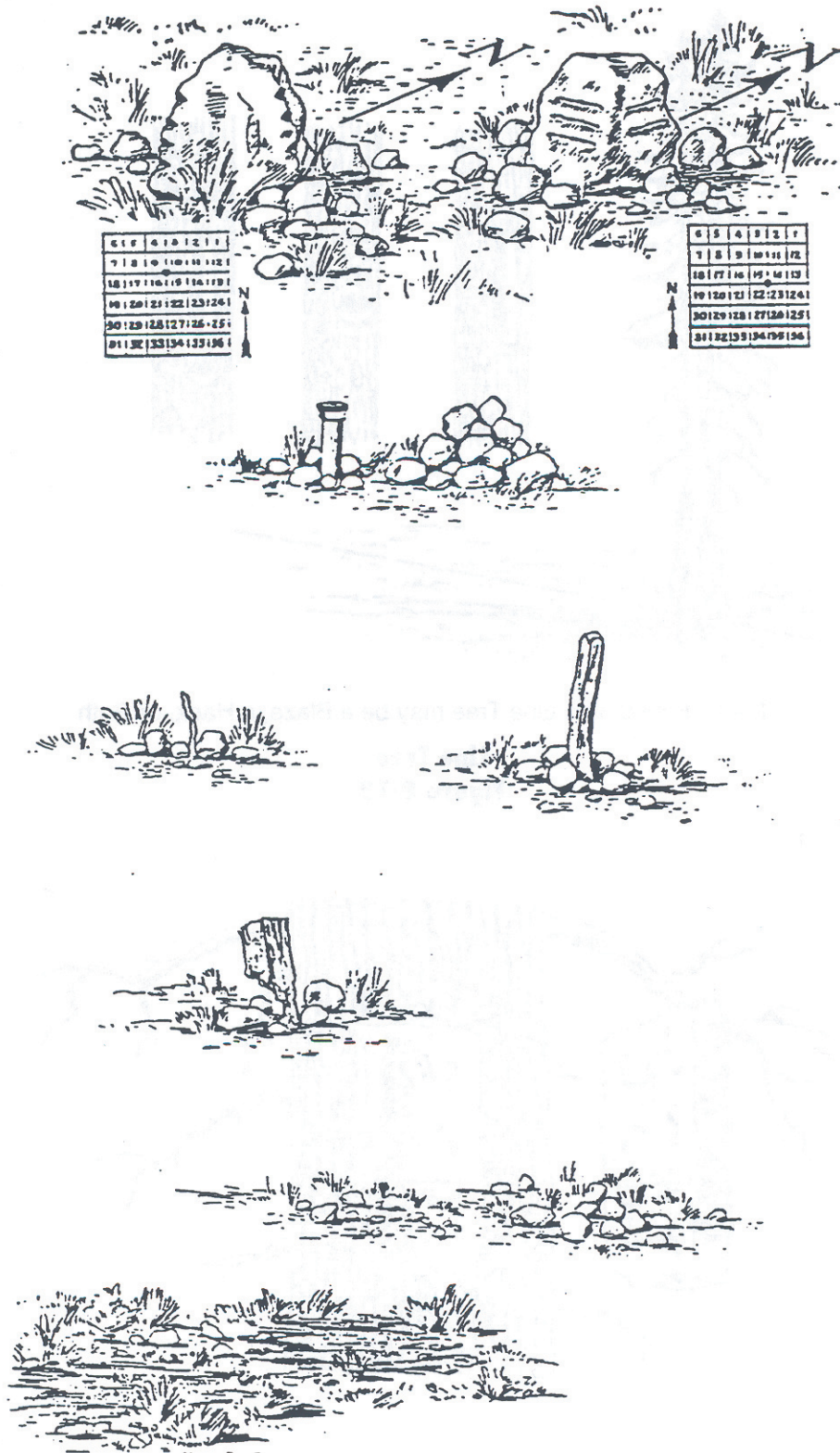

Corner Monuments of the Public Land Surveys

Figure 5-9.





Marks Found on a Line Tree may be a Blaze, a Hack, or Both

**Line Tree**  
*Figure 5-10*

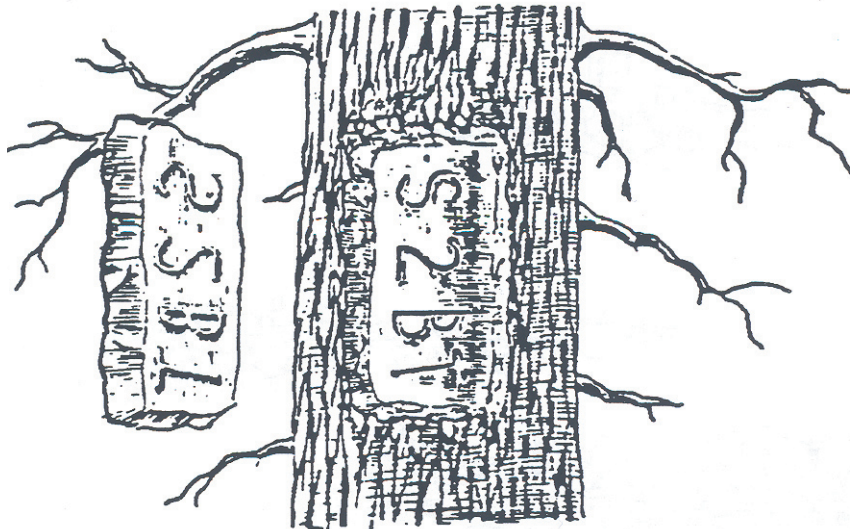

The original marks are preserved and appear in reverse and relief on the overgrowth

**Old Bearing Tree with Overgrowth Removed**  
*Figure 5-11*

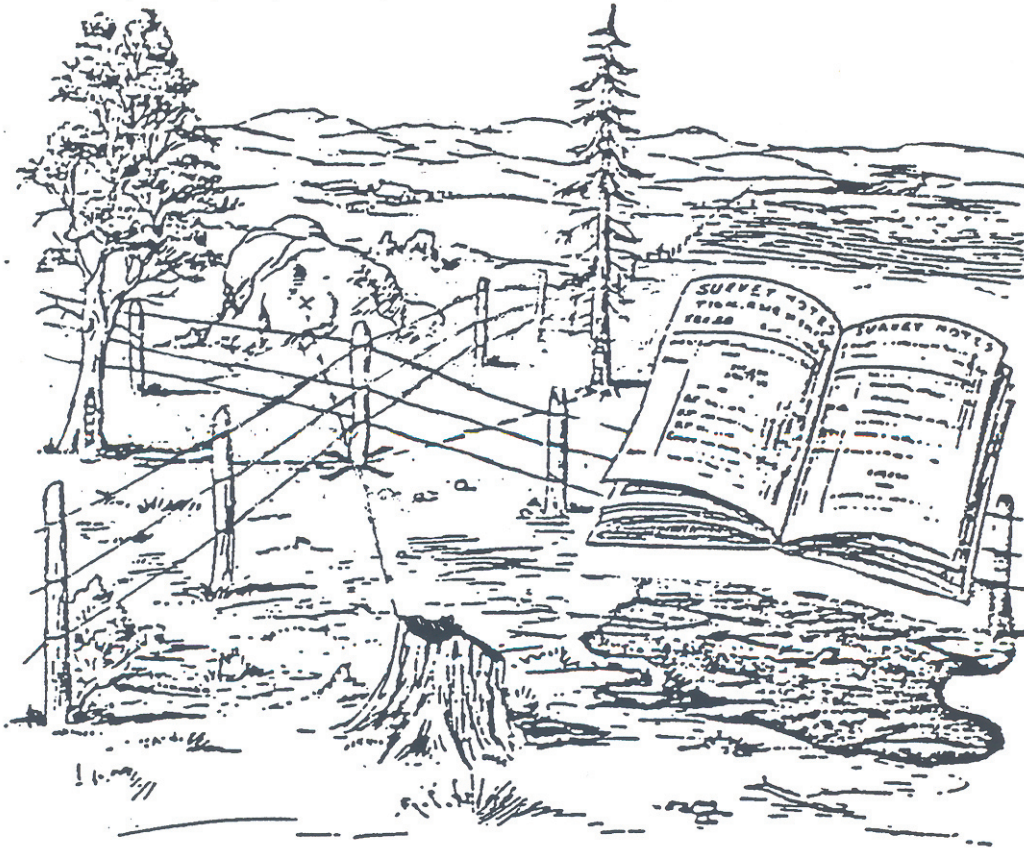

The position for a corner of the public land surveys may be recovered by reference to the recorded bearing trees or bearing objects

**Bearing Objects**

*Figure 5-12*

## 6-01 General

Today's multiorganizational Project Development efforts require the use of common, accurate horizontal and vertical survey datums and consistent, precise control-survey procedures to ensure the accurate location of fixed works and rights of way. The expanding use of Geographic Information Systems (GIS) by WSDOT and other agencies compounds these requirements. Universally accepted and used, common survey datums are essential for the efficient sharing of both engineering and GIS data with WSDOT partners in developing and operating a multimodal transportation system.

## 6-02 Horizontal Datum

### 6-02.1 Policy

All engineering work (mapping, planning, design, right of way engineering, and construction) for each specific WSDOT-involved transportation improvement project is based on a common horizontal datum.

By state law, (WAC 332-130 and RCW 58.20.180) the horizontal datum for all mapping, planning, design, right of way engineering, and construction on WSDOT-involved transportation improvement projects, including special funded State highway projects, is the North American Datum of 1983 (1991), [NAD83 (1991)], as defined by the National Geodetic Survey (NGS). The physical (on-the-ground survey station) reference network for the NAD83 (1991) datum for all WSDOT-involved transportation improvement projects is the Washington High Accuracy Reference Network (WA-HARN).

As resources are available, WSDOT will, in cooperation with NGS and others, monitor and maintain the integrity of the WA-HARN:

- The GeoServices Branch will coordinate WSDOT involvement in replacement of destroyed and disturbed HARN monuments, NGS Benchmarks (first and second order) and resurveys of the network in areas of significant seismic events.
- The regions are to report disturbed or destroyed HARN monuments to the GeoServices Branch. In addition, the regions attempt to visit each HARN station once a year and transmit to the GeoServices Branch a report that describes the station, its status, and any changes in the "to reach" description. Changes in the "to reach" description are to be submitted in a format acceptable to NGS (currently, Windows version of DDPROC). The GeoServices Branch will consolidate the data and forward it to NGS. Alternatively, NGS notification of changes to marks may be done interactively on the web at: <http://www.ngs.noaa.gov/datasheet.html>.

As resources permit, the WA-HARN and the WSDOT Primary Reference Network (PRN) are to be densified within the corridor areas of planned WSDOT involved transportation projects prior to, or during, the project studies (planning) phase to provide consistent, convenient geodetic reference monuments for all subsequent project-related surveys. The densification surveys are performed in accordance with the policies, standards, and procedures described in Chapter 13, "Control Survey Procedures."

### **6-02.2 Description of NAD83 (1991)**

The reference surface used for the North American Datum of 1983 (NAD83) is an ellipsoid named the Geodetic Reference System of 1980 (GRS80). GRS80, is a world-wide model that has replaced the previously-used Clarke's spheroid of 1866. Clarke's Spheroid, the reference figure for NAD27, was a best-fitting model for North America, but did not meet the needs of world-wide geodetic systems or the Global Positioning System (GPS).

NAD83 was established by first performing a least squares adjustment of Doppler observations used to establish the NAD27 network and then redefining the mathematical reference surface from Clarke's Spheroid to the GRS80. NAD83 has geodetic coordinates that measure 230 to 330 feet (70 to 100 meters) different from those of NAD27.

The geodetic coordinate system for NAD 83 is based on longitude defined as angular distance East or West of the prime meridian, which runs through the observatory at Greenwich, England, and latitude defined as the angular distance north of the Equator.

The initial NGS station coordinates based on NAD83 were the result of a simultaneous nationwide adjustment of the original observation that incrementally built up the NAD27 network. The adjustment results were published in 1986 as the NAD83/86 datum. Subsequently, in 1991, the WA-HARN was established using GPS technology. The GPS survey was more precise than the methods used to establish the NAD83 reference system in 1986. Consequently, coordinates for stations determined with reference to the WA-HARN are more accurate and might differ from those referenced to the original NAD83 positions as much as one meter. The adjusted network is NAD83 (1991).

### **6-02.3 Datum Conversions**

There is no direct mathematical method to accurately transform coordinates from one system to the other. Data conversion programs such as NADCON, developed by NGS, and Corpscon for Windows, developed by the Army Corps of Engineers, are only approximations that are not accurate enough for boundary or engineering surveys. With a general accuracy of 0.5 foot (0.15 m) these programs are satisfactory for some map conversions.

## **6-03 Vertical Datum**

### **6-03.1 Policy**

The vertical datum for all mapping, planning, design, right of way engineering, and construction on WSDOT-involved transportation improvement projects, including special-funded state highway projects, is the North American Vertical Datum of 1988 (NAVD88), as defined by the National Geodetic Survey (NGS). Exceptions to this policy, as determined by the Regional Cadastral Engineer or equivalent in consultation with the Project Manager, are permitted for:

- Projects that are small, remote, and isolated.
- Maintenance, traffic safety, and rehabilitation projects that are controlled by existing fixed works.
- Projects for which it is not cost effective to establish NAVD88 vertical control.
- Expedited projects for which it is not feasible to establish NAVD88 vertical control.
- Projects contiguous to the National Geodetic Vertical Datum of 1929 (NGVD29) projects and uniformity is desirable.

Generally, the only acceptable alternate datum is NGVD29. For project locations where published NAVD88 data is not locally available, GPS survey methods using GEOID99 or future geoid models of improved resolution may be considered. The standard deviation for results obtained from GEOID99 over a distance of 62 miles (100 km) of 0.33 feet (0.1 m) can be achieved with the right procedures, equipment, and guidelines.

Assumed datums are only considered as a last resort.

All engineering work (mapping, planning, design, right of way engineering, and construction) for each WSDOT-involved transportation improvement project must be based on common vertical datum.

### 6-03.2 Description of NAVD88

In 1978, NGS began a program to combine leveling surveys into a single least squares adjustment to provide improved heights for over 700,000 vertical control points throughout the United States. This adjustment was completed in June 1991 and has been designated the North American Vertical Datum of 1988 (NAVD88).

### 6-03.3 GPS Determined Heights

GPS survey methods, besides enabling the horizontal positioning of survey points to a high degree of accuracy, also provide accurate ellipsoidal height information. Whereas, all geodetic leveling is relative to a height or elevation (orthometric height) above the geoid, GPS heights are determined in relation to the GRS80 ellipsoid.

The sea-level surface of the Earth is called the geoid and is defined as the surface that is perpendicular to the direction of gravity at all points. The geoid is not a mathematically definable geometric shape. It is irregular because the direction of gravity varies from point to point as the result of the irregular distribution of mass within the Earth. Because of its irregular undulating nonmathematical shape, the geoid cannot be used for calculations of the relative horizontal positions of points on the Earth's surface.

The difference between the geoid (an undulating irregular surface defined by variations in the Earth's gravity field) and the ellipsoid (a mathematical surface) is referred to as geoid height. The geoid height is the separation between the ellipsoid and the geoid with the surface represented as mean sea level. This number is negative in Washington State ranging in values from -17 m to -23 m. Negative geoid heights indicate the geoid is below the ellipsoid as shown in Figure 6-1.

An exception to the visual diagram in figure 6-1, would be in an area where the ellipsoid is negative indicating that the ellipsoidal model is actually above the ground instead of below it. This occurs in a few locations within Washington State.

Geoid99, a model of geoid heights, is now available from NGS and is being used extensively in GPS data reduction to obtain elevations.

The relationship between the geoid, GRS80, and the Earth's surface is shown in Figure 6-1 and is given by Equation 6-1.

Equation 6-1:

$$h = N + H$$

where:

$$h = \text{ellipsoidal height}$$

$$N = \text{geoid height}$$

$$H = \text{orthometric height (elevation)}$$

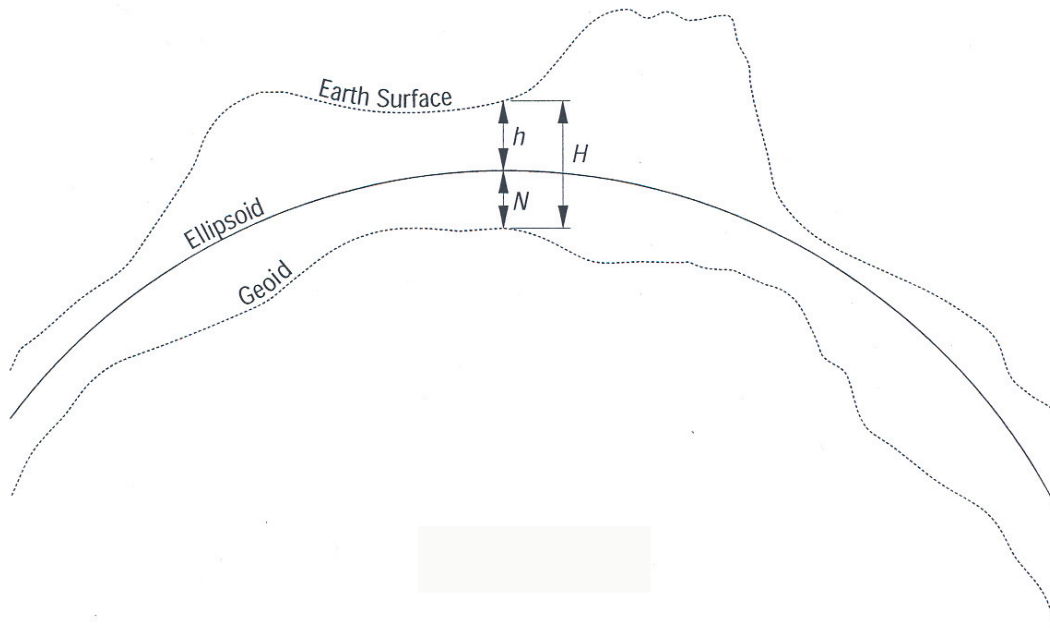

Figure 6-1

### 6-03.4 Datum Conversions

NGS, and other public agencies that maintain bench marks, periodically readjust level networks as new field data is obtained. Always use elevations from the most recent adjustment. When using the published elevations and benchmarks of other agencies, it is important to convert them to the datum selected for the WSDOT project. Example: Published monument data will show Geoid99 adjusted coordinates. It is incorrect to use one monument to set up a total station on, using Geoid99 data and another monument, such as in a back-sight point using Geoid96 data. The datum must be the same on both points.

Because NAVD88 is an independent readjustment and redefinition of NGVD29 there is not a precise mathematical method to convert exactly between the two datums. If using a conversion program like NGS's VERTCON or the US Army Corps of Engineers' Corpscon for Windows to convert NGVD29 elevations to NAVD88, be sure to verify that the results will meet the accuracy requirements of the work to be performed. Generally, accuracies when using VERTCON and Corpscon are within 0.25 m. Both programs require the input of the benchmark location expressed as Latitude and Longitude in NAD83 (1991).

## 6-04 The Washington Coordinate System of 1983 (WCS83)

### 6-04.1 Policy

WAC 332-130 and RCW 58.20.180 requires that all new surveys and new mapping projects, which record State Plane Coordinates, must use the Washington Coordinate System of 1983 (WCS83).

WCS83 is the coordinate system used for all mapping, planning, design, right of way engineering, and construction on WSDOT involved transportation improvement projects, including special-funded State highway projects. The physical (on-the-ground) reference network for WCS83 is the WA-HARN.

Coordinates shown on maps, plans, and other related documents are WCS83 coordinates. The reference network for WCS83 coordinates are the WA-HARN.

When a map, set of plans, or other document uses State Plane Coordinates, place a note on the document to show the basis of the coordinates used including the WCS zone and the physical reference network.

#### **6-04.2 Description of WCS83**

Because of the complexity of performing the calculations for geodetic surveying and the limited extent of most surveying projects, most surveyors generally use plane surveying methods. For local projects, plane surveying yields accurate results, but for large systems (like the WSDOT transportation system) local plane surveying systems are not adequate. Not only are local plane coordinate systems inaccurate over large areas, but they cannot be easily related to other local systems.

In response to the needs of local surveyors for an accurate plane surveying datum that is useful over relatively large areas, the U. S. Coast and Geodetic Survey (the predecessor of NGS) developed the State Plane Coordinate Systems. The first system for Washington State, WCS of 1927, was based on the NAD27 datum. Coordinates, in feet, were given as X (easting) followed by Y (northing) and bearings were reckoned from the south. WCS83 was established July 1, 1990, with coordinates, in meters, given as N (northing) followed by E (easting), and with bearings reckoned from north.

RCW 58.20.190 “Conversion of coordinates – Metric” *Any conversion of coordinates between the meter and the United States survey foot shall be based upon the length of one meter being equal to exactly 39.37 inches.*

The State Plane Coordinate System was established to provide a means for transferring the geodetic positions of monumented points to plane coordinates that would permit the use of these monuments in plane surveying over relatively large areas without introducing significant error.

A plane-rectangular coordinate system is by definition a flat surface. Geodetic positions on the curved surface of the Earth must be “projected” to their corresponding plane coordinate positions. Projecting the curved surface onto a plane requires some form of deformation. Imagine the stretching and tearing necessary to flatten a piece of orange peel. The orange peel cannot be flattened without deformation of the surface. Similarly, the surface of the earth cannot be represented on a flat plane surface without distortion. A long narrow strip of an orange peel can be flattened with a minimum of distortion. If coordinate systems are limited to long narrow strips a minimum of mapping error results. In Washington the Lambert Conformal map projection is used to transform the geodetic positions of latitude and longitude into the “N” (Northing) and “E” (Easting) coordinates of the WCS83.

The Lambert Conformal projection can be illustrated by a cone that intersects the GRS80 ellipsoid along two parallels of latitude as shown in Figure 6-2. These latitudes are known as the standard parallels for the projection. Distances lying along the standard parallels are the same on both the GRS80 ellipsoid and the cone. Between the standard parallels, distances projected from the ellipsoid to the conic surface become smaller. Outside the standard parallels, distances projected from the ellipsoid to the conic surface become larger. Scale factors are used to reduce and increase distances when converting between the WCS surface and the ellipsoid surface. The scale factor is exactly one on the standard parallels, greater than one outside them and less than one between them.

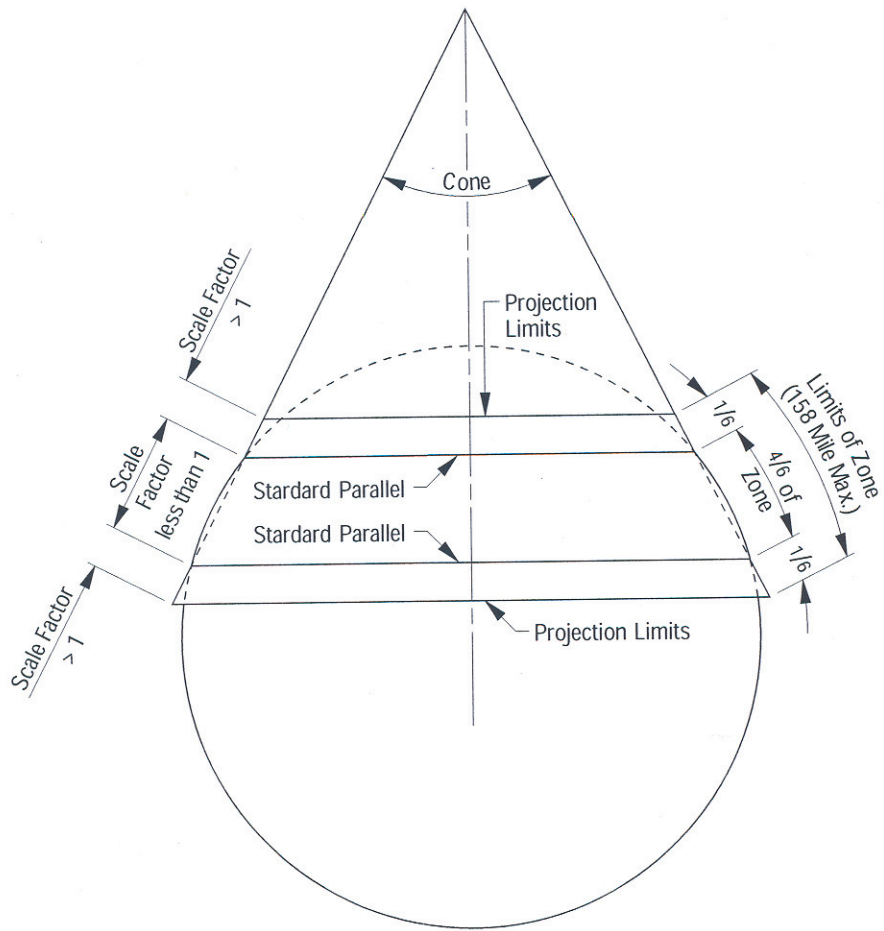

Figure 6-2



The limits of each Lambert projection are generally chosen so that scale factors will be less than 1.00010 and greater than 0.99990 so that, even if scale factors are disregarded, discrepancies between ground measurements at sea level and distances on the WCS grid will be within 1:10,000. Maintaining the 1:10,000 constraint requires two zones in Washington. The zones have been created so that zone boundaries run along County lines, with the exception of Grant County where the line between the “north zone” and the “south zone” lies along the parallel 47°30’ north latitude. See Figure 6-3.

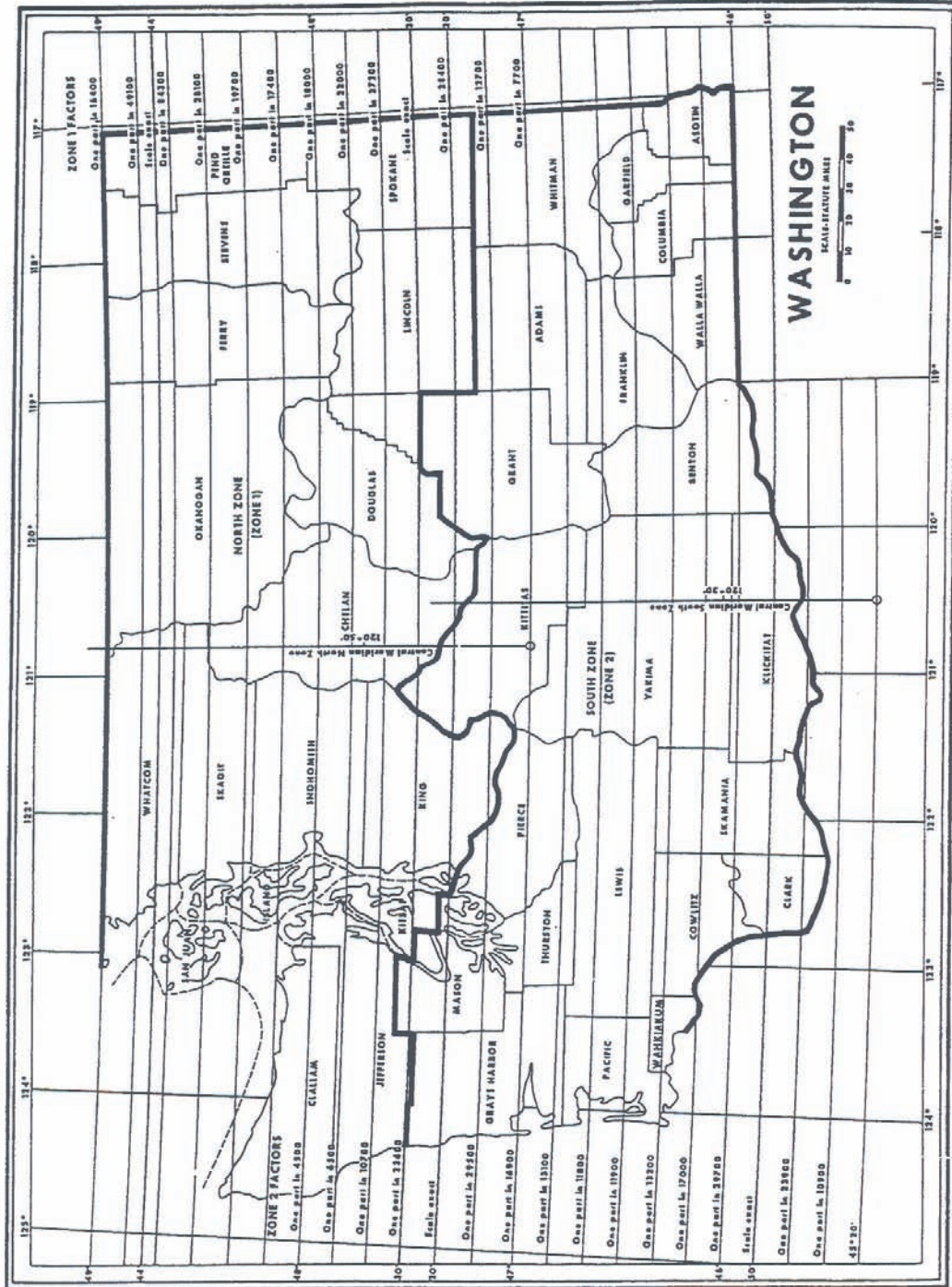
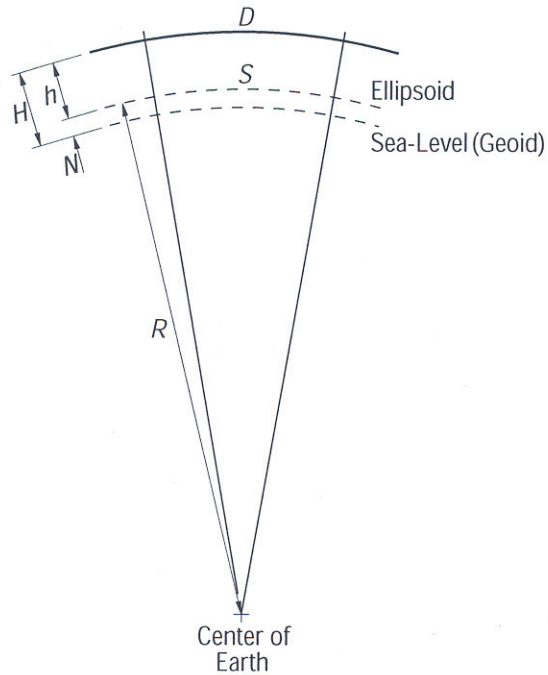

Figure 6-3

Distances measured on the surface of the Earth are to corresponding lengths on the ellipsoid. This ellipsoidal or elevation factor varies with the elevation of the surface where the distance is measured. As the elevation of the measured line increases, the distance (radius) from the surface of the Earth to its center increases, which correspondingly increases the length of the measured line. Thus, distances are reduced in proportion to the change in radius between the ellipsoid and the radius of the Earth's surface where the measurement is made. See Figure 6-4.



$$\frac{S}{D} = \frac{R}{R+h}$$

$$S = D \left( \frac{R}{R+h} \right)$$

or:

$$S = D \left( \frac{R}{R+N+H} \right)$$

Where:

- S = Distance on ellipsoid
- D = Distance on ground
- R = Radius of ellipsoid for zone
- N = Geoidal height
- H = Elevation
- h = Ellipsoid height

**Figure 6-4**

Normally the elevation factor (sometimes called the sea level factor) and the scale factor are combined by multiplication into a grid or combined factor. Distances measured on the Earth's surface are converted to WCS83 grid distances by multiplying by the grid factor. Grid distances are converted to ground distances by multiplying the grid distance by the reciprocal of the grid factor.

Lines running east and west on the WCS83 grid are parallels of latitude. A Central Meridian is designated for each WCS83 zone and all other meridional lines on the WCS83 grid are constructed parallel to it. Therefore the only true geodetic north-south line on a WCS83 grid is the Central Meridian. All other north-south lines vary from geodetic North by the plane convergence angle ( $\gamma$ ). The plane convergence angle varies with longitude, increasing as the distance from the Central Meridian increases. See Figure 6-5.

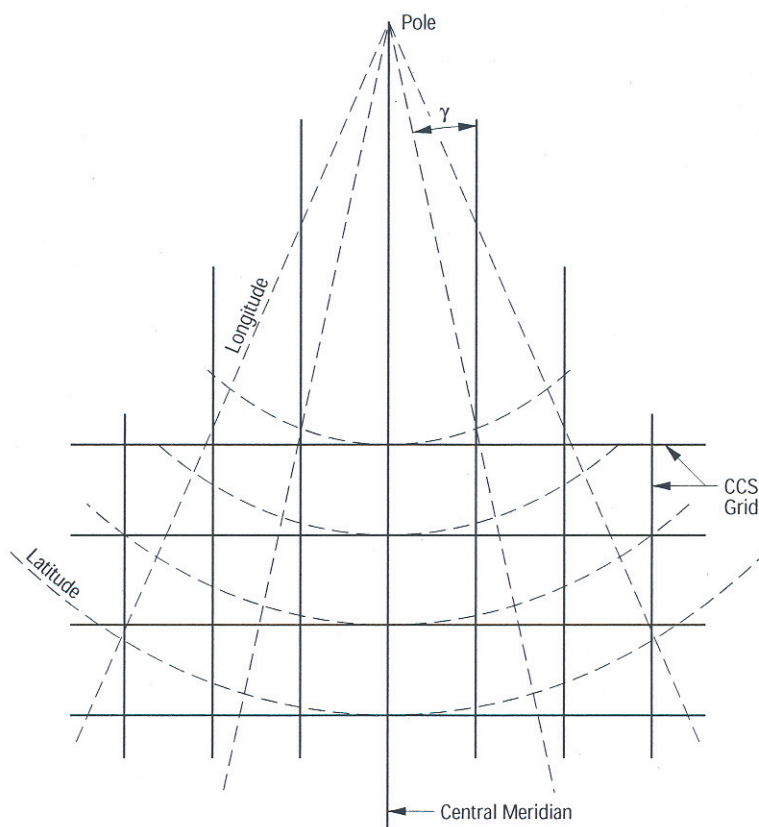

Figure 6-5

### 6-04.3 Coordinate Conversions

Conversions between geodetic coordinates and WCS83 coordinates are normally made using computer programs. The programs also calculate plane convergence angles and grid factors for each position. Though grid factors will differ from point to point because of change in elevation and latitude, as a general rule, a mean grid factor is selected for each project. This policy will usually cause no appreciable loss in accuracy and will eliminate confusion caused by multiple grid factors. However, for higher-order control surveys where the elevations of points vary significantly, or for projects extending to large north/south distances, assigning more than one grid factor might be appropriate.

WCS83 coordinates are specific for each zone because each WCS83 zone is a unique Lambert projection. WSDOT projects that extend from one zone into another use WCS83 coordinates based only on one zone. WCS coordinates for one zone can be easily converted to coordinates of a second zone by first converting to geodetic coordinates and then converting to WCS83 for the second zone.

In Washington, the effect of the changing datums from NAD27 to NAD83-91 was to shift and rotate geographic coordinates roughly three hundred feet to the southwest. There is no precise mathematical conversion for coordinates between WCS27 and WCS83. Conversion programs like the National Geodetic Survey's "NADCON" and the U.S. Army Corps of Engineers' "Corpscon for Windows" are only approximate conversions that are generally not accurate enough for engineering and boundary surveys. Do not use these programs to convert coordinates on survey control points between WCS27 and WCS83.

## Survey Datums

The two recommended methods for obtaining WCS83 coordinates for old WCS27 surveys are:

- Conducting a resurvey of the WCS27 survey using WA-HARN as the reference control.
- Use GPS to establish WCS83 coordinates on the original control points for the WCS27 survey and then recalculate coordinates for the entire network using the original observations.

### 6-04.4 Computing Project Datum Coordinates From State Plane

Since surveyors measure on the Earth's surface and not on the mathematical Ellipsoid, a coordinate conversion is necessary to convert from Washington State Plane coordinates to a "Project Datum". Ground distances and angles can be measured and projects can be laid out and constructed working with a project datum. During location and construction of highway projects, it is much easier to work with project datum coordinates than with Washington State Plane Coordinates. The procedure is to convert the State Plane Coordinates of the initial control points to project datum coordinates, gather all of the surveying data using project datum coordinates, design the project using project datum coordinates, construct the project using project datum coordinates, then convert the project datum coordinates back to Washington State Plane Coordinates for archiving and future use.

It is very important to understand the difference between Project Datum and Washington State Plane. Surveying can be performed in Project Datum or Washington State Plane coordinates. There is however, a difference between the two datum's (depending on project location) and should never be combined or confused.

The WSDOT policy is to always use a Project Datum. Experience has shown that far fewer surveying errors occur and the data provided from the Survey crews to the Designers is consistently superior when using a project datum. Documenting the method used to determine the combined factor and the combined factor itself is critical. The combined factor shall be transferred with all data so future data collection can use the same combined factor.

Any points on the project that vary significantly in elevation as well as projects that run North and South can have an adverse affect on the combination factor. The purpose of using project datum is so that a foot will equal a foot on the ground for location and construction surveying, and to obtain the precision ratio required for the survey work at WSDOT.

At the beginning of a project, a CF (combination factor) needs to be calculated, well documented, and used throughout the project.

When using a combination factor, it is always Project Specific.

It is mandatory to provide a clear, well-documented explanation of the combination factor and how it derived to establish the project datum coordinates. The following questions must be answered in documenting the creation of the combined factor:

- What published control points were used for the minimum and maximum latitudes to determine the mean latitude?
- What published control points were used to derive the minimum and maximum orthometric and geoid heights to determine the mean elevation and mean geoid height?
- Were ellipsoid heights used in lieu of orthometric elevations and geoid heights?

- If scale factors were used instead of latitudes, what are the scale factors that were used (scale factors are published on the monument data sheets)?
- Were the numbers and calculations checked independently?

It is also necessary to clearly state the combined factor (CF), and add a constant of sufficient size to make it impossible to mistakenly believe the Project Datum coordinates to be State Plane Coordinates. WSDOT adds 100 000.000 meters to both the northing and easting coordinates to avoid confusion.

The following are items to consider in determining the projection for the project:

**CONVENTIONAL SURVEY METHOD**

Take the size of the project into consideration. For example, if the project is 6 miles long, find the closest published quality Control Station monuments (Wa-Harn, PRN, GPS, NGS etc. monuments) at the beginning and ending of the project. A minimum of one control station is used at each end of the project to establish the scale factor which is determined from the mean latitudes of the control stations chosen. See Figure 6-7.

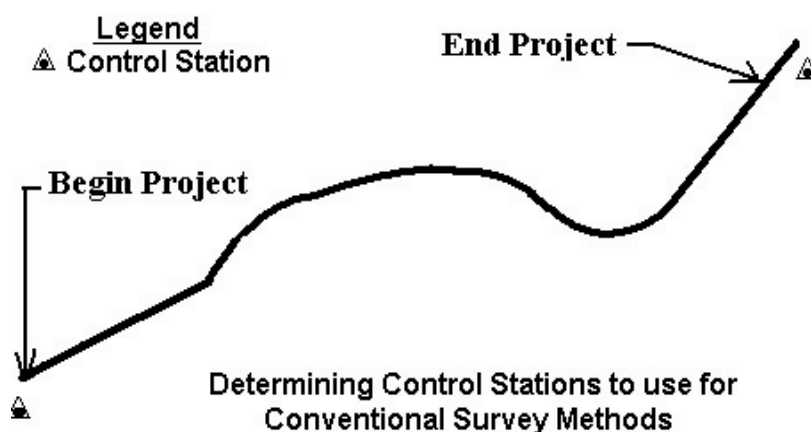

Figure 6-7

### **RTK SURVEY METHOD**

If GPS/RTK (Real Time Kinematics) is used to survey any portion of the project, use the same control points selected for the Calibration Box of the project (a minimum of four which encompasses the project) to calculate the project datum combination factor (See Chapter 8 for procedures on Project Geometric Framework. See Figure 6-8.

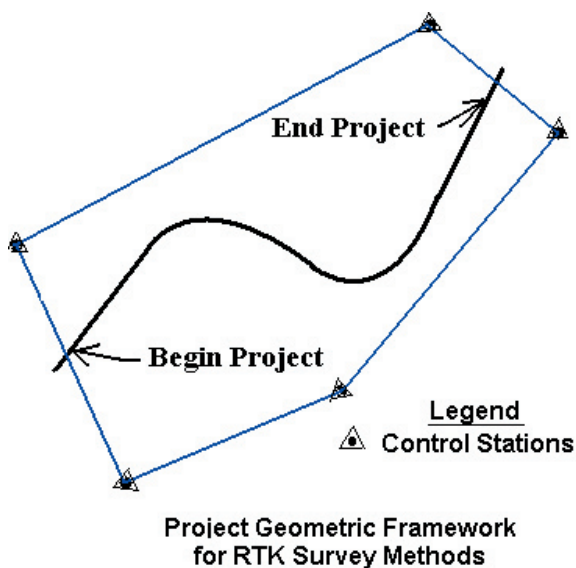

Figure 6-8

If possible, try not to exceed 6 miles of total project length when developing the “Project Datum Combination Factor”. If the project exceeds 6 miles and/or there is a large difference in elevation within the project, separate combination factors within the project area may need to be used. Generally, this is not recommended due to the potential confusion and errors it can create. It is always best to only have one combination factor per project whenever possible.

### **DETERMINING THE COMBINED FACTOR**

Determining a Combined Factor is a two-step process.

First you determine the project Scale Factor (SF) and the project Elevation Factor (EF).

The SF is determined based on the mean scale factors of the project control that has been established surrounding the project. See appendix A for a worksheet to help you calculate the SF.

The EF is determined based on the mean elevation of the project. See appendix A for a worksheet to help you calculate the EF.

Then you calculate a Combined Factor (CF). Multiplying the SF by the EF does this. See appendix A for a worksheet to help you calculate the CF.

### **APPLYING THE COMBINED FACTOR TO YOUR CONTROL POINTS**

First, state plane grid coordinates values (in metric) on ALL of your initial control points are divided by your combined factor (CF). See appendix A for a worksheet to help you apply the CF.

Now add 100,000 meters to the northing and easting values of all of your control points to make their appearance very different from WSPC. We do not want State Plane coordinates and Project Datum coordinates to be confused. See appendix A for a worksheet to help you apply the 100,000 meters.

For the conversion of coordinates from metric to english units, 1 meter is equal to 39.37 inches (RCW 58.20.190). Therefore, since WSDOT typically works in english units; a conversion from metric to english is necessary. See appendix A for a worksheet to help you convert from metric to english units.

Apply these steps to any project control. The process of projecting state plane coordinates to a project datum needs to only be done once at the start of a survey project and ALL data gathered on the project will use the original CF.

After applying the CF to the control points, the surveyor will gather all of the data for the project with a scale factor of 1.000000 in their data collectors, designers will design the project with no scale factors, construction will be accomplished with no scale factors.

When the project is completed and ready for archiving, the conversion from project datum coordinates to Washington State Plane Coordinates are calculated in the reverse order. So, English units are converted to metric, subtract 100,000 meters from each coordinate, then multiply the coordinate values by the combined factor. The result is the entire project is then based on the Washington State Plane Coordinates system and ready for archiving, GIS, transfer to others, etc.

Computer spreadsheets have been developed for ease of these calculations.

Check with the Regional Survey Coordinator or the State CAE Survey Coordinator for help with the computer conversion spreadsheets.

APPENDIX A

| WORK SHEET FOR CONVERTING STATE PLANE COORDINATES TO PROJECT DATUM        |  |   |  |   |   |   |   |   |                               |
|---|--|---|--|---|---|---|---|---|-------------------------------|
| Project Name  |  | Zone<br>(North or South)  | Minimum Latitude                           | Maximum Latitude  | Mean Latitude   | Mean Elevation  | Mean Geoid Height                             |   |                               |
| <b>(SF)</b><br>Obtained by using the mean latitude from the table k value |  | <b>(EF)</b><br>$E.F. = \frac{R}{R + N + H}$ R = assumed radius of earth of 6,372,000 (meters)<br>H = mean elevation from sea level for project (meters)<br>N = mean Geoid height for project (meters) |  | <b>(CF)</b><br>$SF \times EF = CF$                      |   | <b>(N) and (E) Project Datum</b><br>$N = \frac{Y}{CF} + 100,000$ $E = \frac{X}{CF} + 100,000$ |   | Conversion to US Survey Foot<br>$N \times \frac{39.37}{12}$ $E \times \frac{39.37}{12}$ |                               |
|   |  | <b>(Y)</b><br>State Plane Northing (meters)   | <b>(X)</b><br>State Plane Easting (meters) | <b>(SF)</b><br>Mean Scale factor (8 significant digits) | <b>(EF)</b><br>Mean Elevation factor (8 significant digits) | <b>(CF)</b><br>Combined Factor (8 significant digits)   | <b>(N)</b><br>Project Datum Northing (meters) | <b>(E)</b><br>Project Datum Easting (meters)  | Project Datum Northing (feet) |
| Point ID  |  |   |  |   |   |   |   |   |                               |
|   |  |   |  |   |   |   |   |   |                               |
|   |  |   |  |   |   |   |   |   |                               |
|   |  |   |  |   |   |   |   |   |                               |
|   |  |   |  |   |   |   |   |   |                               |
|   |  |   |  |   |   |   |   |   |                               |
|   |  |   |  |   |   |   |   |   |                               |
|   |  |   |  |   |   |   |   |   |                               |
|   |  |   |  |   |   |   |   |   |                               |
|   |  |   |  |   |   |   |   |   |                               |
|   |  |   |  |   |   |   |   |   |                               |
|   |  |   |  |   |   |   |   |   |                               |
| Calculated By:  |  |   |  |   |   |   |   | Checked By:   |                               |



## 7-01 Classifications of Accuracy

All surveys performed by WSDOT or others on all WSDOT-involved transportation improvement projects must be classified according to the standards shown in Figures 7-1 and 7-2. Standards shown are minimum standards for each order of survey.

In addition to conforming to the applicable standards, surveys must be performed using field procedures that meet the specifications for the specified order of survey. Specifications for field procedures are provided in Chapter 8, “Global Positioning System (GPS) - Survey Specifications,” Chapter 9, “Total Station System (TSS) - Survey Specifications” and Chapter 10, “Differential Leveling - Survey Specifications.” Surveying accuracy standards are meaningless without corresponding survey procedure specifications. Without the use of appropriate specifications, chance and compensating errors can produce results that indicate a level of accuracy that has not been met.

The order of accuracy to use for a specific type of survey is listed in Figures 7-1 and 7-2. Tolerance requirements for setting construction stakes are in Chapter 15, “Construction Surveys.” Tolerance requirements for collecting data are in Chapter 14, “Location Surveys.”

## 7-02 Precision and Accuracy

Accuracy is the degree of conformity with a standard or a measure of closeness to a true value.

Accuracy relates to the quality of the result obtained when compared to the standard.

The standard used to determine accuracy can be:

- An exact value, such as the sum of the three angles of a plane triangle is 180 degrees.
- A value of a conventional unit as defined by a physical representation thereof, such as the US survey foot.
- A survey or map deemed sufficiently near the ideal or true value to be held constant for the control of dependent operations.

Precision is the degree of refinement in the performance of an operation (procedures and instrumentation) or in the statement of a result. The term precise also is applied, by custom, to methods and equipment used in attaining results of a high order of accuracy, such as using 3-wire leveling methods or a one second theodolite. The more precise the survey method, the higher the probability that the survey results can be repeated.

Survey observations can have a high precision, but still be inaccurate. For example, observing with a poorly adjusted instrument.

| WSDOT Order          | Standard   | *Monument Spacing   | Survey Method  | Application  |
|----------------------|--|---|--|--|
| First<br>(1:100,000) | Network Accuracy<br>0.05 ft. - 0.12 ft.<br>(15 mm – 35 mm).<br><br>Local Accuracy<br>less than 0.05 ft.<br>(15 mm) | Rural Areas<br>6 miles<br>(10 km)<br><br>Urban Areas<br>3 miles<br>(5 km) | GPS:<br>Static<br>Fast Static  | Brass disks with<br>PRN designation.<br><br>First densification<br>layer of NGRS   |
| Second<br>(1:20,000) | Network Accuracy<br>0.12 ft. - 0.22 ft.<br><br>Local Accuracy<br>less than 0.08 ft.                                | Rural Areas<br>3 miles<br><br>Urban Areas<br>1000 feet                    | GPS:<br>Fast Static<br><br>Total Station:<br>Traverse  | Brass disks with<br>region designation<br>or equivalent<br><br>Densification of DOT<br>Primary Ref. Network                              |
| Third<br>(1:10,000)  | Network Accuracy<br>0.22 ft. - 0.34 ft.<br><br>Local Accuracy<br>less than 0.17 ft.                                | As Needed   | GPS:<br>Fast Static<br>Kinematic<br>RTK<br><br>Total Station:<br>Traverse<br>Resection<br>**Double Tie | Rebar and cap with<br>WSDOT designation<br>or equivalent<br><br>Photo targets, topo,<br>as-builts, const., pits<br>and quarry quantities |
| General              | As required  | As required   | GPS:<br>Kinematic<br>RTK<br><br>Total Station:<br>Radial   | Temporary monument<br><br>Resource mapping<br>Stockpile volumes<br>Environmental needs   |

**Notes:**

- \* Refer to other chapters for detailed procedural specifications for specific survey methods and types of surveys.
- \*\* Instead of including a point as a network point, certain survey points may be positioned by observations from two or more control points (i.e., double tied). If survey points are not included in a network, double ties must be performed to ensure that blunders are eliminated and the positions established are within the stated accuracy. Double tie procedures may be used only when appropriate.
- ‡ For definitions of Network and Local Accuracy see next page.

**WSDOT Horizontal Control Orders of Accuracy**  
*Figure 7-1*

| <b>**WSDOT Order</b>                    | <b>Minimum of BM Ties</b> | <b>*Monument Spacing</b> | <b>Survey Method</b>   | <b>Application</b>  |
|---|---------------------------|--------------------------|--|---|
| First<br>(1:100,000)<br>$e = 5\sqrt{E}$ | 6                         | Less than 2 miles        | Bar Code   | Brass disks with PRN designation<br><br>First densification layer of NGRS   |
| Second<br>(1:20,000)<br>$e = 8\sqrt{E}$ | 4                         | Less than 2 miles        | Bar Code<br>3 wire<br><br>Total Station:<br>Trig levels                          | Durable monuments with region designation<br><br>Control for Major Structures   |
| Third<br>(1:10,000)<br>$e = 12\sqrt{E}$ | 4                         | Less than 2 miles        | Bar Code<br>Single wire<br><br>Total Station:<br>Trig levels                     | Rebar and cap with WSDOT designation or equivalent<br><br>Photo control, topo<br>Project control<br>Construction staking<br>Durable monuments with region designation |
| General                                 | N/A                       | As required              | GPS:<br>Kinematic<br>RTK<br><br>Total Station:<br>Trig levels<br><br>Single wire | Topographic data<br>Resource mapping<br>Stockpile volumes<br>Environmental needs  |

**Notes:**

- \* Refer to other manual chapters for detailed procedural specifications for specific survey methods and types of surveys.
- \*\*  $e = N\sqrt{E}$  indicates closure between established control; e = maximum misclosure in millimeters, E = distance in kilometers, and  $\sqrt{\quad}$  indicates "square root", where N is a constant for the order of work.

**WSDOT Vertical Control Orders of Accuracy***Figure 7-2*

## Accuracy Classifications and Standards

The Federal Geographic Data Committee defines Network Accuracy and Local Accuracy as follows:

The *Network Accuracy* of a control point is a value expressed in centimeters that represent the uncertainty in the coordinates of the control point with respect to the geodetic datum at the 95-percent confidence level. For NSRS network accuracy classification, the datum is considered to be best expressed by the geodetic values at the Continuously Operating Reference Stations (CORS) supported by NGS. By this definition, the local and network accuracy values at CORS sites are considered to be infinitesimal, i.e., to approach zero.

The *Local Accuracy* of a control point is a value expressed in centimeters that represents the uncertainty in the coordinates of the control point relative to the coordinates of other directly connected, adjacent control points at the 95-percent confidence level. The reported local accuracy is an approximate average of the individual local accuracy values between this control point and other observed control points used to establish the coordinates of the control point.

Local Accuracy is best adapted to establishing new control points for a local project. Network Accuracy is better used for constructing a Geographic or Land Information System (GIS/LIS) positional tolerance with a set of coordinates. Network accuracy measures how well coordinates approach an ideal, error-free datum

The number of decimal places to which a computation is carried and a result stated indicates precision. However, the use of tables or factors of more decimal places do not necessarily make calculations more precise. The actual precision is governed by the accuracy of the source data and the number of significant figures rather than by the number of decimal places.

The accuracy of a field survey depends directly upon the precision of the survey. Although by chance (for example, compensating error) surveys with high order accuracies might be attained without high order precision, such accuracies are not valid. Therefore, show all measurements and results with the number of significant figures that are commensurate with the precision used to attain the results. For instance, distances measured with an EDM will be shown to the nearest hundredth of a foot, while distances scaled on a USGS 7½ minute quad map will be shown to the nearest 20 feet. Similarly, all surveys must be performed with a precision that ensures that the desired accuracy is attained.

Carefully show computed values with attention to the accuracies of the measurements. For example, in the case of a distance measured as 9.36 feet with a steel tape:

- $9.36 \text{ feet} \times \pi = 29.41 \text{ feet}$ , not 29.40531 feet

### 7-02.1 Significant Figures

The significant figures of a measurement are those digits that are known, plus one estimated digit following the known digits.

Recorded numerical values, measured and computed, must contain only those digits that are known, plus one estimated digit. Recorded field measurements must never indicate a precision greater than that used in the actual survey. For example, when measurements are made with a cloth tape, values can only be recorded to the nearest 0.1 ft rather than 0.01 ft.

## 7-03 Errors

Field measurements are never exact. Observations contain various types of errors. Often some of these known errors can be eliminated by applying appropriate corrections. Even after correcting all known errors, all measurements still have error associated to them by some unknown value. It is the responsibility of the Survey Team to perform surveys so that errors fall within certain acceptable standards.

### 7-03.1 Types of Errors

#### 7-03.1(a) Blunders

Blunders, which are unpredictable human mistakes, are not technically errors. Examples of blunders are: reading and recording mistakes, transposition of numbers, and neglecting to level an instrument. Blunders are generally caused by carelessness, misunderstanding, confusion, or poor judgment. Blunders can usually be detected by computing survey closures, carefully checking recorded and computed values and checking observations. Blunders must be found and eliminated from the work before errors are identified and minimized by adjustment procedure.

#### 7-03.1(b) Systematic Error

Systematic errors, given the same conditions, are of the same magnitude and algebraic sign. Because systematic errors have the same sign, they tend to be cumulative. Thermal contraction and expansion of a steel tape and refraction of angular observations are examples of systematic errors. Systematic errors can be eliminated by procedures such as balancing foresights and backsights in a level loop or by applying a correction, such as a temperature correction to a taped measurement. All detected systematic errors must be eliminated before adjusting a survey for random error.

#### 7-03.1(c) Random Error

Random errors do not follow any fixed relationship to conditions or circumstances of the observation. Their occurrence, magnitude, and algebraic sign cannot be predicted. An example of random error is instrument pointing. Because of the equal probability of algebraic sign, random errors tend to be compensating. Procedures and corrections cannot compensate for random error. Random errors must be distributed throughout the survey based on most probable values by adjustment procedures.

Some systematic errors, if undetected, act like random errors. For instance, centering error caused by an optical plummet maladjustment is a systematic error, but the error appears random because the orientation of the tribrach to the line of sight is random. In actuality, even a well-adjusted instrument has some amount of error that is treated as systematic random error.

## 7-04 Least Squares Adjustment

The least squares method of observation adjustment is used for the adjustment of most types of WSDOT Network survey data, whether collected by levels, total stations, or GPS receivers. Other methods of adjustments should be used on non network surveys. To be performed correctly, the adjustment is a two-part procedure. First, an unconstrained or free adjustment is done allowing the new observations to be analyzed, their quality determined, and errors detected. Second, a constrained adjustment is performed, which fits the observations to the reference system, thereby determining the coordinate values of the points observed.

**7-04.1 Data Preparation**

**7-04.1(a) Coordinates**

In order to perform a least squares adjustment, positional values must be assigned to each point in a two or three-dimensional network. In a one-dimensional network, such as in leveling, only one point is assigned an elevation. These values can be approximate if their true values are unknown. In some programs, the approximate value can be incorrect by several thousand feet or meters depending on our units of measurements. However, the closer the approximate values are to the true positions the quicker the adjustment can be solved. Also, the chances that a solution cannot be calculated increases as the amount of error in the approximate values increases. Some adjustment programs including Star\*Net and WSDOT Design / Survey Software (CAiCE) have the ability to use the network observations to calculate approximate values.

**7-04.1(b) Observations**

Each observation used in the network adjustment has an associated weight. The weight of an observation indicates how much influence it is to have on the final solution. Most programs allow the user to assign an accuracy or precision value, called the “observation standard error” ( $\sigma$ ), to each observation. The program then calculates the observation weight using the following equation:  $Weight = 1.0/\sigma^2$ . The point to make is, the smaller the standard error, the higher the weight.

There are two ways weights can be assigned to an observation. The first, and least desirable way, is to assign weights to observational groups. For example, weighting all angular observations to the accuracy of the total station used and all distances to the accuracy of the electronic distance measuring device. This method may be employed only if no other information is available.

The better method is to weight each observation individually. Normally, this is done by calculating the standard deviation (standard error) of the observation. Some design/software programs employ a procedure that combines both methods. First, it calculates the standard deviation of all observations. Next, it compares the calculated standard deviation with predefined minimum standard error values for each type of observation from the specifications of the instrument used for the observations. The larger of these two values is then used in the least squares adjustment.

**7-04.1(c) Errors**

Figure 7-3 illustrates the methods for handling the three types of errors found in surveying observations.

| Type       | Action   | Examples                    |
|------------|--|-----------------------------|
| Blunders   | This type of error must be removed before the least squares solution is obtained.              | Misnaming an observed point |
| Systematic | The effects of this type of error must be eliminated by procedures, adjustments, or weighting. | EDM Offset Corrections      |
| Random     | These errors will be distributed by the adjustment.  | Small Observation Errors    |

### Handling Errors

Figure 7-3

#### 7-04.2 Unconstrained Adjustment

The unconstrained or free adjustment is used to evaluate the observations which comprise the network and the weights and observation standard errors assigned to them. In order to effectively evaluate the network, the network must be a closed system. That is, all points in the network have been observed from at least two other points. This means that a closed traverse or level loop is acceptable, but an open ended traverse or level run is not.

#### Note:

This does not mean that least squares cannot be used to adjust these types of networks, it simply means that the least squares adjustment will produce a minimal amount of analysis information.

#### Procedure

1. As shown in Figure 7-4, adjust no more information than the minimum required to perform the unconstrained adjustment (also called a minimally constrained adjustment).

| Network Type                          | Adjust  |
|---------------------------------------|---|
| d=dimensional                         |   |
| 1d – Levels                           | The elevation of one point.   |
| 2d – Conventional Network or Traverse | The northing and easting of one point and any bearing or azimuth in the network.  |
| 3d – Conventional Network or Traverse | The northing and easting of one point and any bearing or azimuth in the network. The elevation of one point in the network. |
| 3d – GPS Network                      | Nothing required to be fixed; however, one point can be fixed if desired.   |

### Network Adjustments

Figure 7-4

2. Run the adjustment. Normally, a two dimensional adjustment is run first to analyze the horizontal component of the network and make any needed modifications. After a satisfactory resolution of the horizontal data is obtained, a three dimensional adjustment is performed. Problems with the three dimensional adjustment indicate errors in the vertical component (e.g. vertical angle pointing, H.I., and target height measurements). These “vertical” errors can be found more easily when using this two-step unconstrained adjustment process.
3. Analyze the statistical results of the adjustment. There are four main areas that to be analyzed to determine the quality of the network adjustment. These areas are:
  - **Standard Deviation of Unit Weight:** (Also called Standard Error of Unit Weight, Error Total, Network Reference Factor, etc.) The closer this value is to 1.0 the better your network is weighted. The acceptable range is 0.8 to 1.2. In general if all blunders have been removed, a value greater than 1.0 indicates that the observations are not as good as their weights, while a value less than 1.0 indicates that the observations are better than their weights.
  - **Observation Residuals:** Usually the adjustment output will include a listing that includes observations, residuals, standard errors, and a warning value or factor. The residual is the amount of adjustment applied to the observation to allow it to best fit the network. Many programs compare the residual to the observation standard error and then flag excessively large residuals. Both CaiCE, or WSDOT design/survey software, and STAR\*NET should flag observations when the residual is greater than three times the standard error. Large residuals might indicate blunders that were not previously identified and eliminated.
  - **Coordinate Standard Deviations and Error Ellipses:** A network with a good Standard Deviation of Unit Weight and well weighted observations with no flagged residuals can still produce points with high standard deviations and large error ellipses (due to the effect, for instance, of network geometry). Examine these values to determine if the point accuracies are high enough for their intended application.
  - **Relative Errors:** These values, often shown as parts per million (ppm), predict the amount of error that can be expected to be found between points in the network. However, values can also be shown as angular and distance errors (i.e. degrees, minutes and seconds and feet or meters) respectively.

Star\*Net uses a statistical test called the Chi-Square test to give a pass/fail grade to the adjustment. This test compares the actual statistical results to the expected theoretical results (that is a standard deviation of unit weight of 1.0) given the number of degrees of freedom in the network. (Degrees of freedom equal the number of observations minus the number of unknowns in the network.) Obviously, it is desirable to pass this test; however, it is not an absolute requirement. If a network has a standard error of unit weight close to 1.0, no high observation residuals, and still does not pass the Chi-square test, the network can be accepted and the Chi-square test ignored.
4. If necessary, make modifications as determined from the analysis of the adjustment statistical results. These modifications can include: (1) adding, deleting, or editing observations, (2) changing observation standard errors, and (3) modifying centering and standard H.I. errors.



- **Adding, Deleting, or Editing Observations:** At times, it is necessary to add observations to a network. If all other statistical indicators look good but some of the points have excessively large standard deviations, it is probably necessary to add additional observations to those points. Deleting observations might be required if they are proven to include blunders; that is, the observation simply does not fit the network. Sometimes a good observation is listed using the wrong point names; in which case, editing the point names will remove the blunder.
  - **Changing Observation Standard Errors:** Observation standard errors are not changed without a good reason. The only justification for changing a standard error is special field conditions noted in the field notes. Normally, if an observation fits poorly and its standard error was calculated individually, it is a blunder. Justifying changing standard errors is more reasonable when the standard errors were assigned on a group basis. However, if changes are made, make them for the whole group, not for an individual observation.
  - **Modifying Centering and H.I. Standard Errors:** Mistakes in assigning centering and H.I. errors is often misinterpreted as poor-observation errors, especially if the standard errors were developed for observation groups. This problem is easier to detect when standard errors are developed individually.
5. Readjust the network. The unconstrained adjustment is an iterative process. It may be necessary to adjust and modify the network several times until an acceptable solution is determined. Once this has occurred, a listing of the adjustment results can be printed out for filing and labeled as being the unconstrained adjustment.

### **7-04.3 Constrained Adjustment Procedure**

1. Fix the coordinates of the known control points.

**Note:**

Once the unconstrained adjustment has been accepted, make no modifications of any type to the network with the exception of fixing the coordinates of the control points.

2. Run the adjustment. Analyze the effects of the fixed control on the network adjustment. This is done to determine the validity of the coordinates of the control points. The validity of the network observations was proven in the unconstrained adjustment phase. Depending on the quality of the reference system used to constrain the network, the Standard Deviation of Unit Weight of the final adjustment might not be close to 1.0 and many of the observation residuals might be flagged as being excessively large. This situation is acceptable if it has been determined that there are no blunders in the control. The surveyor in charge of the adjustment must decide if this degradation in quality is significant. If the survey network meets required accuracies, the adjustment is complete. If accuracy standards are not met, then modifications of the fixed points and readjustments might be appropriate.
3. Modify the fixed points as appropriate. There are two modification options available. First, check the fixed coordinates for errors, transpositions, and misidentifications. If required, edit the coordinates and readjust. If this is not the problem, then one or more of the control points is not in its published position. An analysis of the relationship of the control points can help determine which point or points are unacceptable.

### ***Accuracy Classifications and Standards***

A procedure for analyzing the control is as follows:

- Calculate the inverse distance between the published positions of all the fixed control points.
  - Calculate the inverse distance between the unconstrained positions of all the fixed control points.
  - Calculate the difference between the published inverse distances and the unconstrained inverse distances.
  - Using these differences and the published inverse distances, calculate a ppm value for each inverse.
  - Examine the ppm values. High ppm values indicate problems with the associated control. A control point that shows up in several of the inverses with high ppm values is probably not in its published position. Try running the adjustment again with this point free.
  - Alternatively, control points can be held free or fixed on a trial and error basis until the problem has been detected. Once a determination about the control is made, the final adjustment is performed. After the final adjustment, a listing of the adjustment results can be printed out, labeled as the constrained adjustment, and filed along with a note about any control problems.
4. Readjust network, if necessary.

### 8-01 General

Survey specifications describe the methods and procedures needed to attain a desired survey accuracy standard. The specifications for Post Processed GPS Surveys described in 8-02 are based on Federal Geodetic Control Subcommittee (FGCS) standards and specifications. The FGCS standards and specifications have been modified to meet the specific needs and requirements for various types of primary, secondary, tertiary- and general-order GPS surveys typically performed by WSDOT. The specifications for Real Time Kinematic (RTK) GPS surveys described in 8-03 are based on accepted WSDOT Department of Transportation standards. For complete details regarding accuracy standards, refer to Chapter 7, “Accuracy Classifications and Standards.”

WSDOT GPS survey specifications are to be used for all WSDOT-involved transportation improvement projects, including special-funded projects.

GPS surveying is an evolving technology. As GPS hardware and processing software are improved, new specifications will be developed and existing specifications will be changed. The specifications described in this chapter are not intended to discourage the development of new GPS procedures and techniques.

**Note:**

Newly developed GPS procedures and techniques, which do not conform to the specifications in this chapter, may be employed for production surveys if approved by WSDOT HQ. Newly developed procedures are to be submitted to the WSDOT Geo-Services and Computer Aided Engineering (CAE) Survey Support Offices for distribution and review by other regions.

**Note:**

The specifications in 8-02, “Post Processed GPS Survey Specifications,” are separate and distinct from the specifications in 8-03, “Real-Time Kinematic (RTK) GPS Survey Specifications.”

### 8-02 Post Processed GPS Survey Specifications

#### 8-02.1 Methods

##### 8-02.1(a) Static GPS Surveys

Static GPS survey procedures allow various systematic errors to be resolved when high-accuracy positioning is required. Static procedures are used to produce base lines between stationary GPS units by recording data over an extended period of time during which the satellite geometry changes. All measurements exceeding 6 miles (10 km) must utilize static techniques with longer observation times.

##### 8-02.1(b) Fast-Static GPS Surveys

Fast-static GPS surveys are similar to static GPS surveys, but with shorter observation periods (approximately 5 to 15 minutes). Fast-static GPS survey procedures require more advanced equipment and data reduction techniques than static GPS methods.

### **8-02.1(c) Kinematic GPS Surveys**

Kinematic GPS surveys make use of two or more GPS units. At least one GPS unit is set up over a known (reference) station and remains stationary, while other (rover) GPS units are moved from station to station. All base lines are produced from the GPS unit occupying a reference station to the rover units. Kinematic GPS surveys can be either continuous or “stop and go.” Stop and go station observation periods are of short duration, typically under two minutes. Kinematic GPS surveys are employed where tertiary or lower accuracy standards are applicable.

### **8-02.1(d) Real Time Kinematic (RTK) GPS Surveys**

Real-time GPS surveys are kinematic GPS surveys that are performed with a radio or cellular telephone data link between a reference receiver and the roving receiver. The field survey is conducted like a kinematic survey, except measurement data from the reference receiver is transmitted to the roving receiver, enabling the rover to compute its position in real time. RTK surveys produce a radial network. The distance between the reference receiver and the rover should not exceed 6 miles (10 km).

## **8-02.2 Equipment**

Post processed GPS surveying equipment generally consists of two major components: the receiver and the antenna.

### **8-02.2(a) Receiver Requirements**

Primary, secondary and tertiary post processed GPS surveys require GPS receivers that are capable of recording data. When performing specific types of GPS surveys (i.e. static, fast-static, and kinematic), use receivers and software that are suitable for the specific survey, as specified by the manufacturer. Dual frequency receivers are used for observing base lines over 9 mi (15 km) long.

### **8-02.2(b) Antennas**

Whenever feasible, use all-identical antennas. For vertical control surveys, use identical antennas unless software is available to accommodate the use of different antennas, including Continuous Operating Reference Stations (CORS) antennas. Use identical antennas and receivers, regardless of software accommodations, for WSDOT Primary Reference Network (PRN) surveys.

For primary and secondary horizontal surveys, use antennas with a ground plane attached, and mount the antennas on a tripod or a stable supporting tower. When tripods or towers are used, optical plummets or collimators are required to ensure accurate centering over marks.

The use of range poles and/or stake-out poles to support GPS antennas may only be employed for tertiary horizontal and general-order surveys.

### **8-02.2(c) Miscellaneous Equipment Requirements**

Maintain all equipment to ensure valid survey results. Regularly check equipment for accuracy: calibrate level vials, optical plummets, and collimators at the beginning and end of each GPS survey. If the survey duration exceeds a week, repeat these calibrations weekly for the duration of the survey. For details regarding equipment repair, adjustment, and maintenance refer to Chapter 3, “Survey Equipment.”

8-02.3 General Post Processed GPS Survey Specifications

8-02.3(a) Network Design

Base Lines (Vectors)

Base lines are developed by processing data that is collected simultaneously by GPS units at each end of a line. For each observation session, there is one less independent (nontrivial) base line than the number of receivers collecting data simultaneously during the session. Notice in Figure 8-1 that three receivers placed on stations 1, 2, and 3 for Session “A” yield two independent base lines and one dependent (trivial) base line. Magnitude (distance) and direction for dependent base lines are obtained by separate processing, but use the same data used to compute the independent base lines. Therefore, the errors are correlated. Dependent base lines must not be used to compute or adjust the position of stations

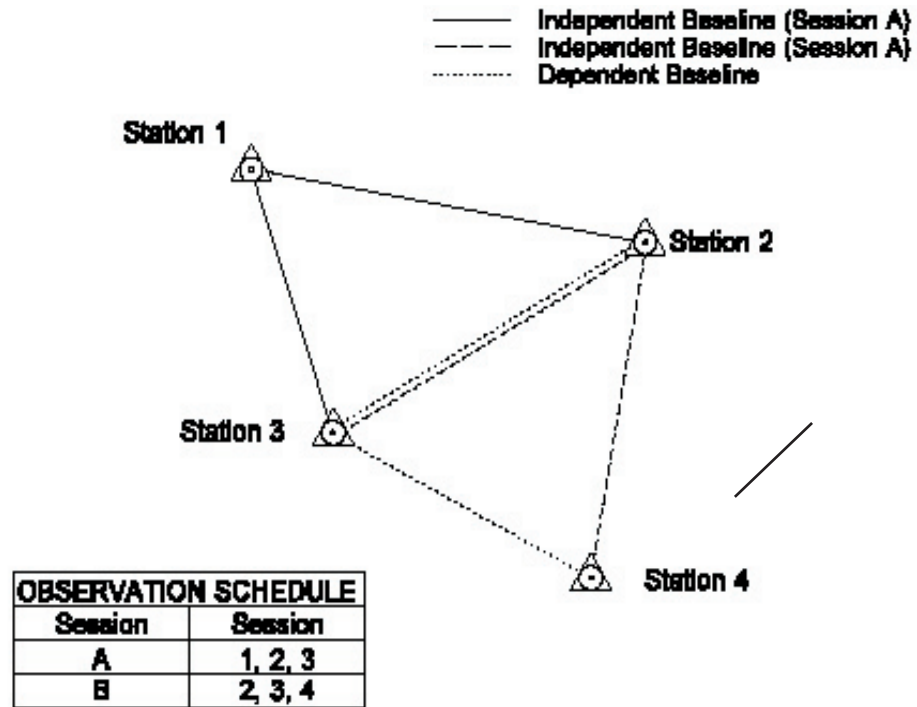

Observation Schedule  
Figure 8-1

Loops

A loop is a series of at least three independent, connecting base lines that start and end at the same station. Each loop has at least one base line in common with another loop. Each loop contains base lines collected from a minimum of two sessions.

Networks

Networks only contain closed loops. Each station in a network is connected with at least two different independent base lines. Avoid connecting stations to a network by multiple base lines to only one other network station. Primary and Secondary GPS control networks consist of a series of interconnecting closed-loop, geometric figures.

**Redundancy**

Design Primary, Secondary and Tertiary GPS control networks with sufficient redundancy to detect and isolate blunders and/or systematic errors. Redundancy of network design is achieved by:

- Connecting each network station with at least two independent base lines
- Observing a series of interconnecting, closed loops
- Repeating base line measurements

Refer to Figures 8-3 through 8-7 for the maximum number of base lines per loop, the number of required repeat independent base line measurements, and least squares network adjustment specifications. If a Post-Processed GPS survey lacks sufficient network or station redundancy to detect disclosures in an unconstrained (free) least squares network adjustment, it will be considered a general-order GPS survey.

**Reference Stations**

The following are the requirements for reference (controlling) stations for a GPS survey:

- All have the same, or higher, order of accuracy as that intended for the project.
- All are on the NAD83/91 datum. See Chapter 6, “Survey Datums.”
- All are included in, or adjusted to, the Washington High Accuracy Reference Network (HARN) with coordinate values that are current and meet reference network accuracy standards.
- All are evenly spaced throughout the survey project and in a manner that no project station is outside the area encompassed by the exterior reference stations.
- All of the same epoch, or adjusted to the same epoch using National Geodetic Survey (NGS) procedures (NAD 83/91 or subsequent adjustments as tied to the HARN or CORS).

Refer to Figures 8-3 through 8-7 for the number and type of reference stations, and distances between stations.

**Adjacent Station Rule (20 Percent Rule)**

For primary and secondary GPS surveys, an independent base line is produced between stations that are closer than 20 percent of the total distance between those stations traced along existing or new connections. For example, in Figure 8-2, if the distance between Station 5 and Station 1 is less than 20 percent of the distance between Station 1 and Station 3 plus the distance between Station 3 and Station 5, an independent base line is produced between Station 1 and Station 5. If the application of the adjacent station rule is not practical, include an explanation in the survey notes and/or project report.

Also make direct connections between adjacent intervisible stations.

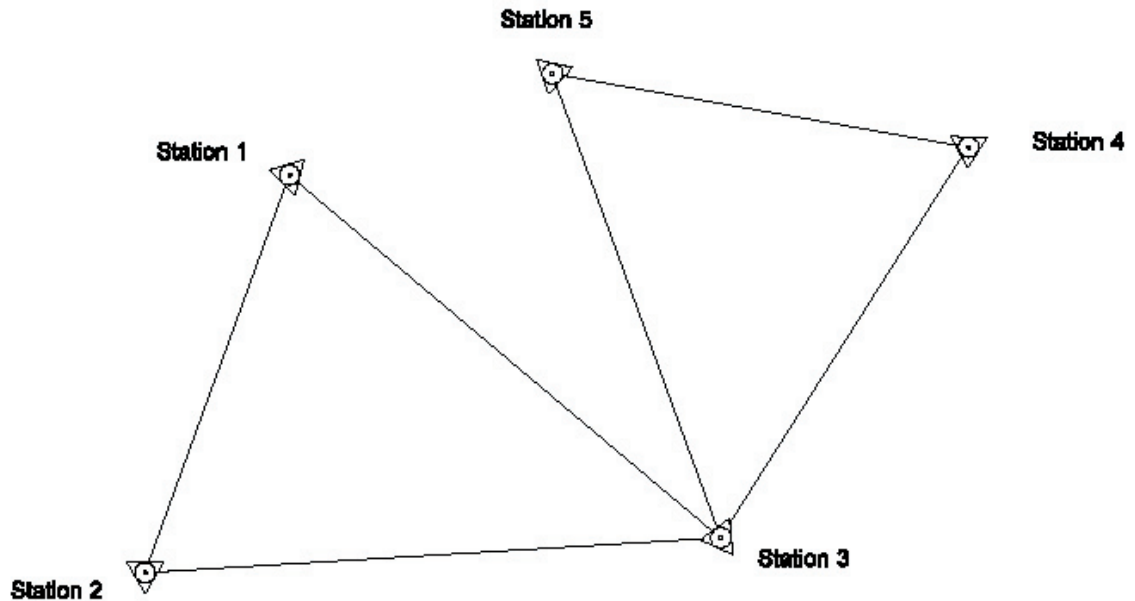
**Adjacent Station Rule (20 Percent Rule)***Figure 8-1***8-02.3(b) Satellite Geometry**

Satellite geometry factors to be considered when planning a GPS survey are:

- Number of satellites available
- Minimum elevation angle for satellites (elevation mask)
- Obstructions limiting satellite visibility
- Positional Dilution of Precision (PDOP)
- Vertical Dilution of Precision (VDOP) when performing vertical GPS surveys

Refer to Figures 8-3 through 8-7 for specific requirements.

**8-02.3(c) Field Procedures****Reconnaissance**

Thorough field reconnaissance is essential to the execution of efficient, effective GPS surveys. Reconnaissance includes:

- Station setting or recovery
- Checks for obstructions and multipath potential

## **Global Positioning System (GPS) Survey Specifications**

- Preparation of station descriptions (monument description, to-reach descriptions, etc.)
- Development of a realistic observation schedule

### **Station Site Selection**

The most important factor for determining GPS station location is the project's requirements (needs). After project requirements, consideration must be given to the following limitations of GPS:

- Situate stations in locations that are relatively free from horizon obstructions.  
In general, a clear view of the sky is required. Satellite signals do not penetrate metal, buildings, or trees and are susceptible to signal delay errors when passing through leaves, glass, plastic and other materials.
- Avoid locations near strong radio transmissions because radio frequency transmitters, including cellular phone equipment, can disturb satellite signal reception.
- Avoid locating stations near large flat surfaces, such as buildings, large signs, and fences, as satellite signals can be reflected off these surfaces causing multipath errors.

Some obstructions near a GPS station might be acceptable. For example, station occupation times can be extended to compensate for obstructions.

### **Multipath**

Multipath describes an error affecting positioning that occurs when the signal arrives at the receiver from more than one path. Multipath normally occurs near large reflective surfaces, such as a metal building or structure, but can be in effect by the presence of trees, grass, water, or roadway surfaces. Obviously, a vehicle parked nearby will represent a reflective surface. GPS signals received, because of multipath, give inaccurate GPS positions when processed. The effects of multipath as an error source can be reduced with the newer receiver and antenna designs and sound prior mission planning to eliminate possible causes of multipath. Averaging of GPS signals over a period of time can also help minimize the effects of multipath. With the short occupation times allowed by fast static and real-time techniques, multipath can become problematic.

### **Weather Conditions**

Generally, weather conditions do not affect GPS survey procedures with the following exceptions:

- Never conduct GPS observations during electrical storms.
- Note significant changes in weather or unusual weather conditions in the observation log (field notes).
- Generally, avoid horizontal GPS surveys during periods of significant weather changes.
- Do not attempt vertical GPS surveys during periods of significant weather changes.
- Include GPS observation planning information on current solar activity, as well as DoD-planned satellite outages.
- During periods of moderate solar activity, dual frequency receivers may be used for observing base lines over 6 mi (10 km) long. Do not attempt measurements during intense activity.



### **Antenna Height Measurements**

Blunders in antenna height measurements are a common source of error in GPS surveys because all GPS surveys are three dimensional whether the vertical component will be used or not. Antenna height measurements determine the height from the survey monument mark to the phase center of the GPS antenna. With the exception of permanently mounted GPS antennas, independent antenna heights must be measured in both feet and meters at the beginning and end of each observation session. Use a height hook or slant rod to make these measurements. Record all antenna height measurements on the observation log sheet and enter them in the receiver data file. Antenna height measurements in both feet and meters must check to within  $\pm 0.01$  ft (3 mm).

When a station is occupied during two or more observation sessions back to back, break down the antenna/tripod, reset it, and replumb the antenna/tripod between sessions.

When adjustable antenna staffs are used (e.g., kinematic surveys), adjust them so that the body of the person holding the staff does not act as an obstruction. Check the antenna height for staffs in extended positions continually throughout each day.

### **On-Site Observations**

Include the following procedures when making field observations.

- Verify stamping on monument, insuring proper station occupation
- Position antenna so that arrow is pointing north
- Move vehicle away from GPS equipment a minimum of 100 feet
- Check receiver for satellite tracking (minimum of 4), then start session
- Record monument stamping and enter station and file name
- Measure height of antenna in Metric units, check in English, record and enter into receiver

### **Documentation**

Include the following information in the final GPS survey project file:

- Project report
- Project sketch or map showing independent base lines used to create the network
- Station descriptions
- Station obstruction diagrams
- Observation logs
- Raw GPS observation (tracking) data files
- Base line processing results
- Loop closures
- Repeat base line analysis
- Least squares unconstrained adjustment results

### **Global Positioning System (GPS) Survey Specifications**

- Least squares constrained adjustment results
- Final coordinate list

For details regarding field notes and other survey records, see Chapter 16, “Monumentation and Survey Records.”

#### **8-02.3(d) Office Procedures**

##### **General**

For primary, secondary and tertiary Post-Processed GPS surveys, raw GPS observation (tracking) data is collected and post processed for results and analysis. Post processing and analysis are required for primary and secondary GPS surveys. The primary post-processed results that are analyzed are:

- Base line processing results
- Loop closures
- Repeat base line differences
- Results from least-squares network adjustments

Post-processing software must be capable of producing relative-position coordinates and corresponding statistics that can be used in a three-dimensional least squares network adjustment. This software must also allow analysis of loop closures and repeat base line observations.

##### **Data Analysis Specifications**

Before performing a minimally constrained and fully constrained adjustment, analyze the network for possible outliers using loop closures, analysis of repeat base lines, and comparison of known and observed base lines. To facilitate in detecting the source of blunder (height of instrument, centering errors, etc.), display vectors in northing, easting, or azimuth, height, and distance, or geodetic latitude, longitude, and height.

##### **Data Processing and Verification**

It is strongly recommended that base lines be processed daily as related to any given project, allowing the user to identify problems that might exist. Once the base lines are processed, review each base line output file. The procedures used in base line processing are manufacturer-dependent. Certain computational items within the base line output are common among manufacturerers and may be used to evaluate the adequacy of the base line observation in the field. A list of the triple difference, float double difference, and fixed double difference vectors ( $dx-dy-dz$ ) are normally listed.

The geodetic azimuth and the distance between the two stations are also listed. The Root Mean Square (RMS) is a quality factor that helps the user to determine which vector solution (triple float, or fixed) to use in the adjustment. The RMS is dependent on the base line length and the length of time the base line was observed. In some cases, the vector passes the RMS test, but does not fit into the network. If this occurs, ensure the stations were occupied correctly, then if necessary, check for multipath or other interference sources and reprocess data sets.

The first step in data processing is to transfer the observational data to a storage device for archiving and/or further processing.

Once the observational data has been downloaded, preprocessing of data can be

completed. Pre-processing consists of editing files info, station names, HI's, equipment types, etc. to ensure data quantity and quality.

### **Root Mean Square Error Measures**

Two-dimensional (2D/horizontal) GPS positional accuracies are normally estimated using a root mean square (RMS) radial error statistic. A 1-8 RMS, 1 sigma error, equates to the radius of a circle in which the position has a 63 percent probability of falling. A circle of twice this radius (i.e., 2-8 RMS or 2DRMS) represents approximately a 97 percent, 2 sigma, positional probability circle. This 97 percent probability circle or 2DRMS, is the most common positional accuracy statistic used in GPS surveying. In some instances, a 3DRMS or 99+ percent probability is used. This RMS error statistic relates to the positional variance-covariance matrix, used in adjustments of GPS networks. Note that an RMS error statistic represents the radius of a circle and therefore is not preceded by a ± sign.

### **Post Processing Criteria**

The success of an observation session based on data processing done by a differencing process can be determined in several ways.

RMS is a measurement (in units of cycles or meters) of the quality of the observational data collected during a given session. RMS is dependent on line length, observation strength, ionosphere, troposphere, and multipath. In general, the longer the line and the more interference by other electronic gear, ionosphere, troposphere, and multipath, the higher the RMS will be (commonly referred to as “noisy data”). A low RMS factor indicates good results, and is one indication to be taken into account. RMS can generally be used to judge the quality of the data used in the post processing and the quality of the post-processed vector.

Redundant lines should agree to the level of accuracy that GPS is capable of measuring to. For example, if GPS can measure a 6 mile (10 km) base line to 0.03 ft (1 cm) +/- 1 ppm, the expected ratio of misclosure is:

$$\frac{0.01 \text{ m} + 0.01 \text{ m}}{10,000 \text{ m}} = 1:500,000$$

Repeated base lines should be near the corresponding:

$$\frac{1 \text{ cm} + 1 \text{ ppm}}{\text{base line}} = \text{ratio}$$

### **Loop Closure and Repeat Base Line Analysis**

Compute loop closures and differences in repeat base lines to check for blunders and to obtain initial estimates of the internal consistency of the GPS network. Tabulate and include loop closures and differences in repeat base lines in the project documentation. Failure of a base line in a loop closure does not automatically mean that rejection is required, but it is an indication that a portion of the network requires additional analysis.

### **Least Squares Network Adjustment**

## **Global Positioning System (GPS) Survey Specifications**

Remove blunders from the network and perform a minimally constrained adjustment, to verify the base lines of the network. After a satisfactory standard deviation of unit weight (network reference factor) is achieved using realistic “a priori error estimates” (statistical quality indicator derived from the base line processor that is utilized in the adjustment of each base line), a constrained adjustment is performed.

The constrained network adjustment fixes the coordinates of the known reference stations, thereby adjusting the network to the datum and epoch of the reference stations. For details regarding least squares adjustments, refer to Chapter 7 for “Least Squares Adjustment.”

### **Accuracy Reporting**

When providing geodetic coordinate data, include a statement that the data meets a particular accuracy standard for both the *local accuracy* and *network accuracy*. For example: these geodetic data meet the 0.07 ft (2 centimeter) local accuracy standard for the horizontal coordinate values and the 0.16 ft (5 centimeter) local accuracy standard for the vertical coordinate values (heights) at the 95% confidence level. Provide a similar statement for these same data reporting the network accuracy.

### **Accuracy Determination**

The procedure leading to classification involves four steps:

1. Examine the survey measurements, field records, schematics, and other documentation to verify compliance with the specifications for the intended accuracy of the survey. This examination might lead to a modification of the intended accuracy.
2. Examine the results of a minimally constrained, least squares adjustment of the survey measurements to ensure correct weighting of the observations and freedom of blunders.
3. Local and network accuracy measures computed by random error propagation determine the provisional accuracy. In contrast to a constrained adjustment where coordinates are obtained by holding fixed the datum values of the existing network control, accuracy measures are computed by weighting datum values in accordance with the network accuracy’s of existing network control.
4. Check the survey accuracy by comparing minimally constrained adjustment results against established control. The result must meet a 95% confidence level. This comparison takes into account the network accuracy of the existing control, as well as systematic effects such as crustal motion or datum distortion. If the comparison fails, then scrutinize both the survey and the network measurement to determine the source of the problem.

## **8-02.4 Order A and B GPS Surveys**

### **8-02.4(a) Applications**

#### **High Accuracy Reference Network (HARN) Surveys**

HARN surveys establish high-accuracy geodetic control stations throughout the State of Washington. HARN and related stations are part of the NGS National Spatial Reference System (NSRS). The HARN consists of Federal Base Network (A order, 1:10,000,000) and Community Base Network (B order- 1:1,000,000) stations.

### **8-02.4(b) Specifications**

HARN surveys are performed using Order A and B specifications published by the FGCS. All HARN surveys are planned and coordinated through the HQ Geographic Services Office and submitted to NGS.

### **8-02.5 Primary (Horizontal) GPS Surveys**

#### **8-02.5(a) Applications**

##### **Primary Reference Network Surveys**

The Washington State Department of Transportation (WSDOT) Primary Reference Network (PRN) is designed to serve as a “first level of densification” from the Washington State High Accuracy Reference Network (HARN). The PRN provides a cost effective, systematic approach, which advocates conducting precise geodetic surveys along entire corridors, multiple corridors, or, in some cases, entire counties. In addition to increased efficiency, improvements in accuracy, because large high-order survey network adjustments are superior to that of forcing the adjustment of a succession of previously unconnected smaller projects, is a major benefit.

All WSDOT PRN monuments must meet NGS standards for geodetic control. All new PRN monuments, established by WSDOT, utilize a special brass disk designating it as a part of the PRN. All PRN positions meet National Spatial Data Infrastructure Standards of less than five centimeters (0.15 ft) (<5 cm) for Network Accuracy and less than two centimeters (0.07 ft) (<2 cm) for Local Accuracy.

All monuments in the PRN Monumentation History include a written “to reach” description following NGS format, a digital picture and are included in the WSDOT Monument Database ([www.wsdot.wa.gov/monument](http://www.wsdot.wa.gov/monument)). The Monument Database is an Internet application that allows the public at large to access geodetic information gathered by WSDOT.

The GPS measurements include static as well as fast static techniques. The geodetic networks are designed to take advantage of the vast number of HARN stations surrounding and within the project areas. The new stations are installed at an average of 6.8 mi (11 km) intervals to make use of efficient but accurate fast static techniques. Secondary surveys, to reference WSDOT projects, benefit greatly from the selected interval.

#### **8-02.5(b) Specifications**

##### **Methods**

- Static
- Fast- static

Generally, static GPS survey methods are employed when base line lengths are greater than 6 mi (10 km). Specifications for primary/PRN accuracy using static and fast-static GPS procedures are listed in Figures 8-3a and 8-3b.

**Global Positioning System (GPS) Survey Specifications**

| <b>Specification</b>  | <b>Static</b>  | <b>Fast-Static</b>   |
|---|--|--|
| <b>General Network Design</b>   |  |  |
| Size of project and number of HARN stations included  | Minimum size:<br>County-wide,<br>includes all HARN<br>stations | Minimum size:<br>County-wide,<br>includes all HARN<br>stations |
| Distance between the survey boundary and network reference control stations (1)   | >9 mile (>15km)  | <9 mile (<15km)  |
| Minimum percentage of all base lines contained in a closed network  | 100%   | 100%   |
| Direct connection between survey stations that are closer than 20 percent of the distance between those stations traced along existing or new connections (adjacent station rule) | Yes  | Yes  |
| Minimum number of independent occupations per station   | 100% (2 times) 10%<br>(3 or more times)                        | 100% (2 times) 10%<br>(3 or more times)                        |
| Vectors to be measured on the 2 <sup>nd</sup> day   | 33%  | 33%  |
| Vectors to be triple redundant  | 100%   | 100%   |
| Vectors to be septuple redundant  | 60%  | 60%  |
| Minimum # of vectors from encompassing directions on exterior stations  | 4  | 4  |
| Minimum # of vectors from encompassing directions on interior stations  | 5  | 5  |
| Direct connection between intervisible azimuth pairs  | Yes  | Yes  |
| <b>Field</b>  |  |  |
| Maximum PDOP during station occupation  | 3)   | 3  |
| Minimum observation time on station   | 150 minutes  | 15 minutes (PRN)   |
| Minimum number of satellites observed simultaneously at all stations  | 5 (75% of time)  | 5  |
| Maximum epoch interval for data sampling  | 15 seconds   | 15 seconds   |
| Antenna height measurements in feet and meters at beginning and end of each session (2)   | Yes  | Yes  |
| Minimum satellite mask angle above the horizon (3)  | 10 degrees   | 10 degrees   |

**Primary (Horizontal) GPS Survey Specifications**

*Figure 8-3a*

| Specification  | Static         | Fast-Static    |
|--|----------------|----------------|
| <b>Office</b>  |                |                |
| Fixed integer solution required for all base lines   | Yes            | Yes            |
| Ephemeris  | Precise        | Precise        |
| Initial position: maximum 3-d position error for the initial station in any base line solution                     | 33 ft (10 m)   | 33 ft (10 m)   |
| Maximum misclosure per loop, in terms of loop length   | 10 ppm         | 10 ppm         |
| Maximum misclosure per loop in any one component(x, y, z) not to exceed  | 0.10 ft (3 cm) | 0.10 ft (3 cm) |
| Repeat base line length not to exceed (dual frequency)   | 31 mi (50 km)  | 6 mi (10 km)   |
| Repeat base line difference in any one component (x, y, z)not to exceed  | 10 ppm         | 10 ppm         |
| Maximum length misclosure allowed for a base line in a properly-weighted, least squares network adjustment         | 10 ppm         | 10 ppm         |
| Maximum allowable residual in any one component (x, y, z) in a properly-weighted, least squares network adjustment | 0.07 ft (2 cm) | 0.07 ft (2 cm) |

Notes:

1. Network independent base lines are required to all “existing primary (or better) GPS established NSRS stations” located within 6 mi (10 km) of the project exterior boundary.
2. Antenna height measurements are not required when using fixed-height antenna poles.
3. During office processing, start with a 15-degree mask. If necessary, the angle may be lowered to 10 degrees.

**Primary (Horizontal) GPS Survey Specifications**

*Figure 8-3b*

**8-02.6 Secondary (Horizontal) GPS Surveys**

**8-02.6(a) Applications**

**Project Control Surveys**

Secondary accuracy standards are acceptable for horizontal Project Control Surveys. See Chapter 13.04.3, “Project Control Surveys.”

**8-02.6(b) Specifications**

**Methods**

- Static
- Fast-static

Dual-frequency receivers are required for observing base lines over 9 miles (15 km) in length. Figures 8-4a through 8-4c list the specifications for secondary accuracy using static and fast-static GPS procedures.

| Specification   | Static                                | Fast-Static                           |
|---|---------------------------------------|---------------------------------------|
| <b>General Network Design</b>   |                                       |                                       |
| Minimum number of reference stations to control the project (1)   | 3 PRN or 3 primary (horiz.) or better | 3 PRN or 3 primary (horiz.) or better |
| Maximum distance between the survey project boundary and network reference control stations   | 31 mi (50 km) if PRN does not exist   | 6 mi (10 km)                          |
| Minimum percentage of all base lines contained in a loop  | 100%                                  | 100%                                  |
| Direct connection between survey stations that are closer than 20 percent of the distance between those stations traced along existing or new connections (adjacent station rule) | Yes                                   | Yes                                   |
| Minimum number of independent occupations per station   | 100% (3 or more times)                | 100% (3 or more times)                |
| Direct connection between intervisible azimuth pairs:   | Yes                                   | Yes                                   |
| <b>Field</b>  |                                       |                                       |
| Maximum PDOP during station occupation  | 5                                     | 5                                     |
| Minimum observation time on station   | 70 minutes                            | 10 minutes                            |
| Minimum number of satellites observed simultaneously at all stations  | 4                                     | (5 sat/15min, 6 sat/10 min)<br>4      |
| Maximum epoch interval for data sampling  | 15 seconds                            | 10 seconds                            |
| Time between repeat station observations  | 45 minutes                            | 45 minutes                            |
| Antenna height measurements in feet and meters at beginning and end of each session (2)   | Yes                                   | Yes                                   |
| Minimum satellite mask angle above the horizon (3)  | 15 degrees                            | 15 degrees                            |
| Minimum number of vectors from encompassing directions to all stations  | 3                                     | 3                                     |

**Secondary (Horizontal) GPS Survey Specifications**  
**Figure 8-4a**



| Office   |                |                |
|--|----------------|----------------|
| Fixed integer solution required for all base lines   | Yes            | Yes            |
| Ephemeris (4)  | Broadcast      | Broadcast      |
| Initial position: maximum 3-d position error for the initial station in any base line solution                     | 66 ft (20 m)   | 66 ft (20 m)   |
| Maximum misclosure per loop in any one component (x,y,z) not to exceed   | 0.10 ft (3 cm) | 0.10 ft (3 cm) |
| Repeat base line length not to exceed (dual frequency)   | 31 mi (50 km)  | 31 mi (50 km)  |
| Repeat base line length not to exceed (single frequency)   | N/A            | 6 mi (10 km)   |
| Maximum length misclosure allowed for a base line in a properly-weighted, least squares network adjustment         | 10 ppm         | 10 ppm         |
| Maximum allowable residual in any one component (x, y, z) in a properly-weighted, least squares network adjustment | 0.10 ft (3 cm) | 0.10 ft (3 cm) |

**Secondary (Horizontal) GPS Survey Specifications**

*Figure 8-4b*

Notes:

1. Network independent base lines are required to all “existing primary (or better) GPS established NSRS stations” located within 6.2 mi (10 km) of the project exterior boundary.
2. During office processing, start with a 15-degree mask. If necessary, the angle may be lowered to 10 degrees.
3. Precise ephemeris may be used.

**Secondary (Horizontal) GPS Survey Specifications (Notes)**

*Figure 8-4c*

**8-02.7 Tertiary (Horizontal) GPS Surveys**

**8-02.7(a) Applications**

Tertiary horizontal accuracy is acceptable for the following typical WSDOT survey operations:

- Supplemental control for engineering and construction surveys
- Photogrammetry control
- Controlling land net points
- Construction survey setup points for radial stakeout
- Setup points for engineering and topographic survey data collection
- Controlling stakes for major structures
- Monumentation surveys

**8-02.7(b) Specifications**

**Methods**

- Static
- Fast-static
- Kinematic

Figures 8-5a and 8-5b lists the specifications for tertiary accuracy using static, fast-static and kinematic GPS procedures.

| Specification   | Static                         | Fast-Static                    | Kinematic                      | RTK                            |
|---|--------------------------------|--------------------------------|--------------------------------|--------------------------------|
| General Network Design  |                                |                                |                                |                                |
| Minimum number of reference stations to control the project (1)   | 3 secondary (horiz.) or better | 3 secondary (horiz.) or better | 3 secondary (horiz.) or better | 5 secondary (horiz.) or better |
| Maximum distance between the survey project boundary and network control stations   | 9 mi (15 km)                   | 6 mi (10 km)                   | 6 mi (10 km)                   | 6 mi (10 km)                   |
| Location of reference network control (relative to center of project); minimum number of "quadrants," not less than   | 3                              | 3                              | 2                              | 4<br>+ Center Pt.              |
| Minimum percentage of all base lines contained in a loop  | 100%                           | 100%                           | 100%                           | 0%                             |
| Direct connection between survey stations that are less than 20 percent of the distance between those stations traced along existing or new connections (adjacent station rule) | Yes                            | Yes                            | Yes                            | Yes                            |
| Minimum percentage of repeat independent base lines   | 100%                           | 100%                           | 100%                           | 100%<br>Antenna dump           |
| Percent of stations occupied 2 or more times  | 100%                           | 100%                           | 100%                           | 100%                           |
| Direct connection between intervisible azimuth pairs  | Yes                            | Yes                            | Yes                            | No                             |
| Field   |                                |                                |                                |                                |
| Maximum PDOP during station occupation  | 5                              | 5                              | 5                              | 5                              |
| Minimum observation time on station   | 70 minutes                     | 10 minutes                     | 5 Epochs                       | 30 Epochs                      |
| Minimum number of satellites observed simultaneously at all stations )  | 4                              | 4                              | 5<br>(100% of time)            | 5<br>(100% of time)            |
| Maximum epoch interval for data sampling  | 15 seconds                     | 15 seconds                     | 1 - 15 seconds                 | 1 seconds                      |
| Minimum time between repeat station observations  |                                |                                | 45 minutes                     | After antenna dump             |
| Antenna height measurements in feet and meters at beginning and end of each session (2)   | Yes                            | Yes                            | Yes                            | Yes                            |
| Minimum satellite mask angle above the horizon (3)  | 15 degrees                     | 15 degrees                     | 15 degrees                     | 15 degrees                     |

**Tertiary (Horizontal) GPS Survey Specifications**

*Figure 8-5a*

**Global Positioning System (GPS) Survey Specifications**

| Specification  | Static          | Fast-Static     | Kinematic       | RTK            |
|--|-----------------|-----------------|-----------------|----------------|
| <b>Office</b>  |                 |                 |                 |                |
| Fixed integer solution required for all base lines   | Yes             | Yes             | Yes             | Yes            |
| Ephemeris (4)  | Broadcast       | Broadcast       | Broadcast       | Broadcast      |
| Initial position: max. 3-d position error for the initial station in any base line solution                        | 330 ft (100 m)  | 330 ft (100 m)  | 330 ft (100 m)  | -              |
| Maximum misclosure per loop in any one component (x, y, z) not to exceed   | 0.16 ft (5 cm)  | 0.16 ft (5 cm)  | 0.16 ft (5 cm)  | 0.16 ft (5 cm) |
| Maximum allowable residual in any one component (x, y, z) in a properly-weighted, least squares network adjustment | 0.33 ft (10 cm) | 0.33 ft (10 cm) | 0.33 ft (10 cm) | -              |

Notes:

1. Network independent base lines are required to existing primary (or better) GPS established NSRS stations within 3.1 mi (5 km) of the project exterior boundary.
2. During office processing, start with a 15-degree mask. If necessary, the angle may be lowered to 10 degrees.
3. Precise ephemeris may be used.

**Tertiary (Horizontal) GPS Survey Specifications**

*Figure 8-5b*

**8-02.8 WSDOT General-Order (Horizontal and Vertical) Post Processed GPS Survey Specifications**

**8-02.8(a) Applications**

General-order horizontal accuracy is acceptable for the following typical WSDOT survey operations:

- Collection of topographic and planimetric data
- Supplemental design data surveys: borrow pits, utility, drainage, etc.
- Construction staking
- Environmental surveys
- Geographic Information System (GIS) surveys.

**8-02.8(b) Specifications**

**Method**

- Real Time Kinematic
- Kinematic

Figure 8-6 lists the specifications for general-order accuracy using kinematic GPS procedures.

| Specification   | Kinematic            | Real-time Kinematic  |
|---|----------------------|--|
| Minimum number of reference stations to control the project                                     | 3 Tertiary or better | 3 Tertiary or better                                       |
| Minimum number of check stations  | 2                    | 2  |
| Maximum distance between the survey project boundary and the network reference control stations | 6mi (10 km)          | Within project boundary/<br>radio range/6mi (10 km)<br>max |
| Maximum PDOP during station occupation  | 5                    | 5  |
| Minimum observation time on station   | 5 epochs             | As indicated by the<br>system                              |
| Minimum number of satellites observed simultaneously at all stations                            | 5 (100% of time)     | 5 (100% of time)   |
| Maximum epoch interval for data sampling  | 1 – 15 seconds       | 1 second   |
| Minimum satellite mask angle above the horizon  | 10 degrees (1)       | 13 degrees   |

Note:

1. During office processing, start with a 15-degree mask. If necessary, the angle may be lowered to 10 degrees.

### General-Order (Horizontal) GPS Survey Specifications

*Figure 8-6*

#### 8-02.9 Vertical GPS Surveys

##### 8-02.9(a) General

The following guidelines are intended for use on local transportation projects, and are not applicable to larger area networks.

##### Introduction

Because vertical positioning techniques using GPS are still under development, these guidelines are preliminary and will be updated as improved techniques and procedures are developed. GPS-derived orthometric heights (elevations) are compiled from ellipsoid heights (determined by GPS observations) and modeled geoid heights (using an acceptable geoid height model for the area). (For more detail see Chapter 6-03, “Vertical Datum.”)

Because of distortions in vertical control networks and systematic errors in geoid height models, results can be difficult to validate; however, results comparable to those obtained using differential leveling techniques are obtainable.

##### Geoid Height Modeling Methods

Two basic geoid modeling methods are used to develop the geoid heights:

## **Global Positioning System (GPS) Survey Specifications**

- **Published National and Regional Geoid Models:** For relatively large areas (areas exceeding 6 mi (10 km) by 6 mi (10 km), geoid heights use the applicable national or regional geoid model published by NGS. Generally, use the latest published model. If there are indications that the existing published geoid model does not provide adequate geoid heights, the procedures listed in the following paragraph may be substituted.
- **Local Geoid Models Based on Existing Vertical Control:** For smaller areas, (and where the published geoid model proves inadequate) if there are sufficient existing vertical control stations, a local geoid model applicable to the specific survey can be developed. With this method, geoid heights are determined at new stations by interpolating between the geoid heights at the known vertical control stations. The interpolation can be accomplished automatically during the least squares adjustment process by entering the known orthometric heights as ellipsoid heights for each vertical control station in the adjustment software. The horizontal positions might change slightly. Evaluate the amount of change to decide if separate adjustments need to be performed and documented. If an independent vertical adjustment is performed, include a minimum of constraints (one position) in the horizontal dimension.

### **Accuracy Standards**

When performing vertical control work using conventional methods, accuracy is expressed as a proportional accuracy standard based on the loop or section length (See Chapter 7, “Accuracy Classifications and Standards.”). GPS survey accuracies, both horizontal and vertical, are expressed in the form of allowable station positional variance. This variance is basically independent of the base line lengths, although base line lengths do affect procedures and the accuracies attainable. For horizontal GPS surveys, base line proportional accuracies are computed during the adjustment process, so a comparison of positional and proportional accuracy standards is provided; but, for GPS vertical surveys, only station positional accuracies are obtainable. A comparable relative measure of accuracy based on base line length is not readily available during the adjustment process. The GPS guidelines included in this chapter are designed to achieve an orthometric height accuracy standard of 0.07 ft (20 mm) or 0.15 ft (50 mm) at the 95 percent confidence level relative to the vertical control used for the survey. This means that 95 percent of the orthometric height determinations will be within plus or minus 0.07 ft (20 mm) or 0.15 ft (50 mm) (whichever is applicable) of the “true” relative value, provided the network is designed with sufficient redundancy and validation checks.

### **8-02.9(b) Applications**

Vertical GPS survey methods are an emerging technology. This is particularly true where orthometric heights (elevations) rather than ellipsoid heights are required, as is the case for most WSDOT surveys. Factors to consider when evaluating the use of vertical GPS survey methods are:

- Accuracy requirements for the survey
- Equipment availability
- Distance between survey stations
- Survey station locations (sky view obstructions, etc.)
- Specifications to be employed for the vertical GPS survey
- Whether elevations are required or only relative differences (over time) required
- Time and resources required in comparison to conventional surveys

- Availability and density of suitable reference control
- Future survey efforts in the vicinity

### **Vertical Project Control Surveys**

GPS surveys can be an effective means to establish vertical control (e.g., NAVD88) for a Vertical Project Control Survey, providing the required secondary and tertiary accuracy standard is achieved. The achievable accuracy standards will depend on the guidelines employed and the distance to the vertical reference control network. See 8-02.9(c), “Guidelines.” Differential leveling is used throughout the project corridor and strategic locations to aid in geoid modeling for Project Geometric Framework surveys.

### **Other Surveys**

See the list of possible applications Chapter 8-02.8(a).

### **8-02.9(c) Guidelines**

Guidelines for vertical control surveys using GPS are similar to those for primary GPS horizontal control surveys with additional requirements to limit the errors in GPS ellipsoid height determination. Guidelines for GPS vertical control surveys to achieve 0.07 ft (20 mm) or 0.15 ft (50 mm) accuracy standards, relative to existing vertical control are shown in Figures 8-7a and 8-7b.

In addition to the tabular specifications, in complex areas (mountainous, lack of control, need for greater precision, and longer distances to good control), contact the NGS State Geodetic Advisor to obtain the latest information and specifications for vertical GPS surveys.

**Global Positioning System (GPS) Survey Specifications**

| Specification   | 0.07 ft (20 mm)                        | 0.15 ft (50 mm)                          |
|---|--|--|
| <b>General</b>  |  |  |
| Minimum number of horizontal control stations for the project (latitude, longitude, ellipsoid height)                 | 3 primary (HPGN-D) or better           | 3 primary (HPGN-D) or better             |
| Location of horizontal control stations (relative to center of project); minimum number of "quadrants," not less than | 3                                      | 3  |
| Minimum number of vertical control stations (benchmarks) for the project  | 4<br>see 8-02.9(d)                     | 4<br>see 8-02.9(d)                       |
| Location of vertical control stations (relative to center of project); minimum number of "quadrants," not less than   | 4                                      | 4  |
| Maximum distance between project survey stations  | 6.2 mi (10 km)<br>[avg. 4.3 mi (7 km)] | 12.4 mi (20 km)<br>[avg. 7.5 mi (12 km)] |
| Minimum percentage of all base lines contained in a loop  | 100%                                   | 100%                                     |
| Minimum percentage of repeat independent base lines (adjacent station rule)   | 100% of total                          | 100% of total                            |
| <b>Field</b>  |  |  |
| Dual frequency GPS receivers required   | Yes                                    | Yes                                      |
| Maximum VDOP during station occupation  | 4                                      | 4  |
| Minimum observation time per adjacent station base line   | 30 minutes                             | see note 1                               |
| Minimum number of satellites observed simultaneously at all stations  | 5                                      | 5  |
| Maximum epoch interval for data sampling  | 15 seconds                             | 5 seconds                                |
| Time between repeat station observations  | see 8-02.9(d)                          | see 8-02.9(d)                            |
| Minimum satellite mask angle above the horizon  | 15 degrees                             | 15 degrees                               |
| Required number of receivers  | 3                                      | 3  |

*\* Relative to the existing vertical control*

**Vertical GPS Survey Guidelines (Local Projects)  
Positional Accuracy Standard –  
0.07 ft (20 mm) and 0.15 ft (50 mm)\***

*Figure 8-7a*



| Specification   | 0.07 ft (20 mm)                                 | 0.15 ft (50 mm)                              |
|---|---|--|
| <b>Office</b>   |   |  |
| Antenna height measurements in feet and meters at beginning and end of each session                               | N/A   | Yes<br>see note 2                            |
| Fixed integer solution required for all base lines  | Yes   | Yes  |
| Ephemeris   | Precise   | Broadcast                                    |
| Initial position: maximum 3-d position error for the initial station in any base line solution. See note 3 below. | 33 ft (10 m)                                    | 33 ft (10 m)                                 |
| Loop closure analysis, maximum number of base lines per loop  | 6   | 6  |
| Maximum ellipsoid height difference for repeat base lines   | 0.07 ft (20 mm)                                 | 0.16 ft (50 mm)                              |
| Maximum RMS values of processed base lines (2)  | 0.05 ft (15 mm)<br>(typically <0.03 ft (10 mm)) | 0.05 ft (15 mm) (typically <0.03 ft (10 mm)) |

Notes:

1. Minimum time on adjacent station base lines must ensure that all integers can be resolved and the root mean square error will not exceed 0.05 ft (15 mm).
2. Antenna height measurements are required at the beginning and end of each observation period and must be made in both feet and meters.
3. Start with HARN stations.

*\* Relative to the existing vertical control*

**Vertical GPS Survey Guidelines (Local Projects)  
Positional Accuracy Standard –  
0.07 ft (20 mm) and 0.15 ft (50 mm)\*  
Figure 8-7b**

**8-02.9(d) General Notes**

**Observations**

Collect data at the vertical control stations continuously and simultaneously with the new project survey station observations. Observe adjacent survey stations simultaneously. Observations at the new project survey stations are continuous for the times specified and must be repeated on a different day and at a different time. Complete the repeated observations on different days either four hours before the starting time of the first day's observations or four hours after the ending time of the first day's observations.

## **Global Positioning System (GPS) Survey Specifications**

### **Datums/Network/Epoch**

Reference stations must be the same datum, included in (or adjusted to) one consistent geodetic network, and of the same epoch (or adjusted to the latest epoch), especially in areas of known or suspected subsidence. For reference stations, use the most recent epoch NAD83 latitude, longitude, and ellipsoidal height. Vertical control surveys in subsidence areas might require special procedures.

### **Vertical Control Stations**

Three vertical control stations (bench marks) determine the plane of the geoid but provide no redundancy. Include at least one additional vertical control station in the project to provide this redundancy. If possible, include three additional vertical control stations, especially in areas where there are changes in the slope of the geoid as shown on gravity anomaly maps or where there are significant changes in the slope of the terrain. Note that reference stations with published orthometric heights (elevations) may be considered as meeting the requirement for vertical control stations.

Also, locate the vertical control stations so that the project survey stations are bracketed by the vertical control stations. Do not attempt to determine elevations through extrapolation outside the area encompassed by the reference stations.

### **Checks**

Check the elevation difference between adjacent survey stations by conventional leveling (differential or trigonometric) methods for 10 percent or two sections (whichever is greater) of the project survey base lines (i.e., pairs of adjacent survey stations). Use the procedures and quality of observations/measurements that will produce results that meet tertiary standards.

## **8-03 Real Time Kinematic (RTK) GPS Survey Specifications**

### **8-03.1 Method**

#### **8-03.1(a) RTK GPS Surveys**

RTK GPS surveys are kinematic GPS surveys ( 8-02.1-.3) that are performed with a data transfer link between a reference GPS unit (base station) and rover units. The field survey is conducted like a kinematic survey, except data from the base station is transmitted to the rover units, enabling the rover unit to compute its position in real time.

#### **8-03.2 Equipment**

An RTK system consists of a base station, one or more rover units, and a data transfer link between the base station and the rover unit(s).

##### **8-03.2(a) Base Station Requirements**

A base station is comprised of a GPS receiver, an antenna, and a tripod. The GPS receiver and the antenna must be suitable for the specific survey as determined from the manufacturer's specifications. Tripod requirements are specified in 8-03.3.

##### **8-03.2(b) Rover Unit Requirements**

The rover units are comprised of a GPS receiver, an antenna, and a rover pole. The GPS receiver and the antenna must be suitable for the specific survey as determined from the manufacturer's specifications.

A rover antenna must be identical (not including a ground plane, if used at the base station) to the base station antenna unless the firmware/software is able to accommodate antenna modeling of different antenna types.

Rover pole requirements are specified in 8-03.3.

### **8-03.2(c) Data Transfer Link**

The data transfer link can be either a UHF/VHF radio link or a cellular telephone link. The data transfer link must be capable of sending the base station's positional data, carrier phase information, and pseudo-range information from the base station to the rover unit. This information must be sufficient to correct the rover unit's position to an accuracy that is appropriate for the type of survey being conducted.

If the data transfer link uses a UHF/VHF radio link with an output of greater than 1 watt, a Federal Communications Commission (FCC) license is required.

All FCC rules and regulations must be adhered to when performing an RTK survey. These include but are not limited to the following:

- Title 47, Code of Federal Regulations (CFR) part 90, Chapter 173 (47 CFR 90.173): Obligates all licensees to cooperate in the shared use of channels.
- 47 CFR 90.403: Requires licensees to take precautions to avoid interference, which includes monitoring prior to transmission.
- 47 CFR 90.425: Requires that stations identify themselves prior to transmitting.

Voice users have primary authorization on the portion of the radio spectrum used for RTK surveying. Data transmission is authorized on a secondary and noninterfering basis to voice use.

Failure to comply with FCC regulations subjects the operator, and their employer, to fines, seizure of the surveying equipment, civil liability, and/or criminal prosecution. Failure to comply also jeopardizes the future use of RTK/GPS surveying by or for WSDOT.

### **8-03.2(d) Miscellaneous Equipment Requirements**

Use RTK equipment that is suitable for the work being done.

All RTK equipment must be properly maintained and checked for accuracy. Conduct the accuracy checks before each survey or at a minimum of once a week to ensure valid survey results.

For details regarding equipment repair, adjustment, and maintenance refer to Chapter 3, "Survey Equipment."

### **8-03.3 General RTK Survey Specifications**

In an RTK survey "radial" shots are observed from a fixed base station to a rover unit. A delta X, delta Y, and delta Z are produced from the base station to the rover unit on the WGS84 datum. From these values, coordinates of the points occupied by the rover unit are produced.

#### **8-03.3(a) RTK Survey Design**

RTK survey design differs from static and fast static GPS survey design. With static and fast static GPS surveys, a closed network design method is used. See 8-02.3(a), "Network Design," for more details on GPS network design. Use the following criteria for RTK survey design:

### **Global Positioning System (GPS) Survey Specifications**

- “Surround” and enclose the project area consisting of Project Geometric Framework control stations. (For the definition of a Project Geometric Framework control station, see the definitions in this section.)
- If the Project Geometric Framework control station is used for horizontal control, the Project Geometric Framework control station must have horizontal coordinates that are on the same datum as the datum required for the project.
- If the Project Geometric Framework control station is used for vertical control, the Project Geometric Framework control station must have a height that is on the same datum as the datum required for the project.
- Include all Project Geometric Framework control stations in a GPS site calibration. (For the definition of a GPS site calibration, see the definitions in this section.)
- If the RTK equipment does not support the use of a GPS site calibration, use the Project Geometric Framework control stations for check shots.
- For tertiary RTK surveys, occupy each new station twice. The 2nd occupation of a new station uses a different base station location. If the new station is being elevated by RTK methods, the 2nd occupation of the new station has a minimum of 3 different satellites in the satellite constellation. This is generally achieved by observing the 2nd occupation at a time of day that is either 4 hours before or 4 hours after the time of the 1st occupation.
- Establish the new stations in areas where obstructions, electromagnetic fields, radio transmissions, and a multipath environment are minimized.
- Use the current geoid model when appropriate.

### **8-03.3(a)1 THE PROJECT GEOMETRIC FRAMEWORK**

#### **Comprehensive and Coordinated Reference Framework**

To insure WSDOT projects do not contain mismatched data, a well planned geometric framework of control stations that specifically define the required datum and adjustment must be formed in advance of initiating project development. If coordinate-driven technologies are expected to function properly, a geodetic survey forming a geometric framework must be constructed in a manner that surrounds each individual project. “Calibration” of positioning systems used by WSDOT, consultants, and contractors must be based on the geometric framework survey and its gravity modeling for each project. Individual monuments representing the coordinates, datum, and adjustments must be defined early in the engineering process, utilize throughout the design, and detailed in all contracts as a required specification.

The Project Geometric Framework approach constitutes a “best business practice” for supplying survey control for WSDOT projects as it provides a comprehensive and coordinated reference “template” for new technologies utilized by planners, engineers, designers, consultants, and contractors.

Because the Global Positioning System provides location services for mapping, asbuilts, design, construction, and asset management the following elements need to be correctly addressed and implemented:

## How is a Project Geometric Framework Constructed?

GPS-derived WGS84 Cartesian coordinates must be transformed to a local datum.

This process is called Site Calibration.

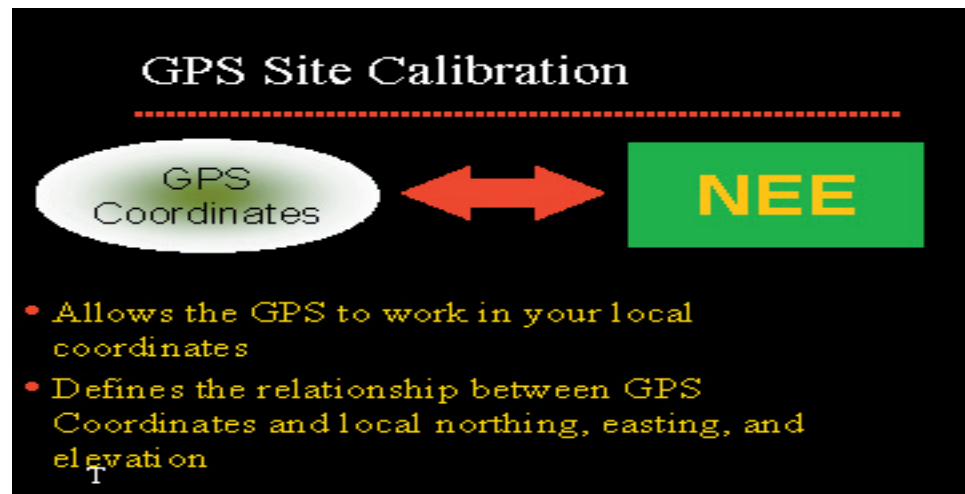

### GPS Site Calibration

Figure 8-8(a)

A geoid model must be utilized to transform earth-centered GPS-derived ellipsoid heights to a usable sea level referenced datum.

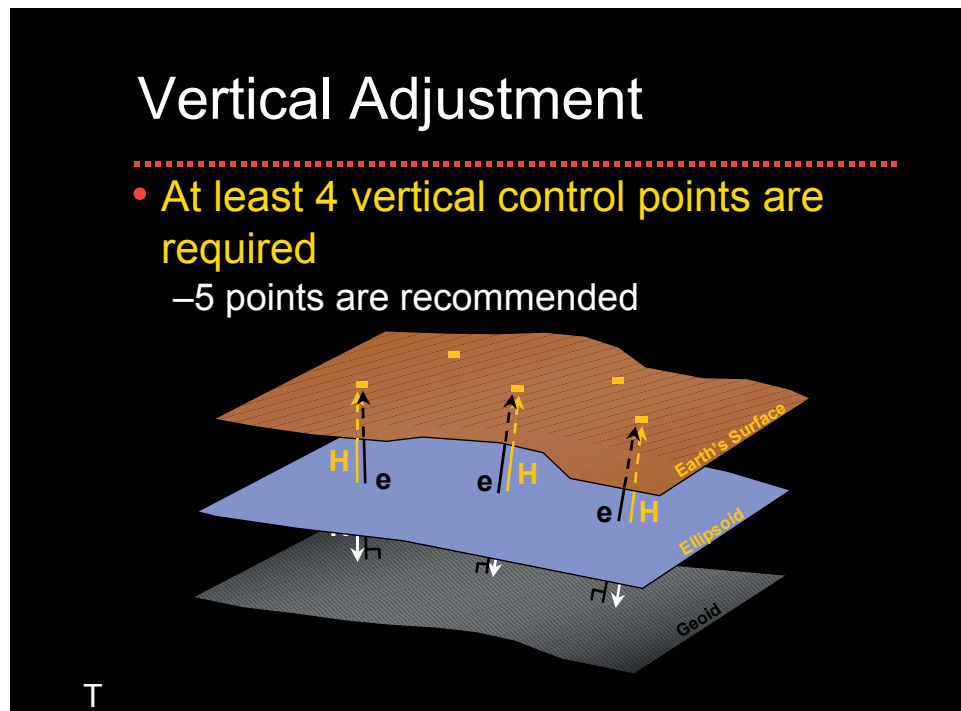

### Vertical Adjustment

Figure 8-9

The need for geodetic control on WSDOT projects is based on the concept of stabilizing a plane. The following illustration demonstrates this need:

# Stabilization of the Geodetic Model

Global Positioning

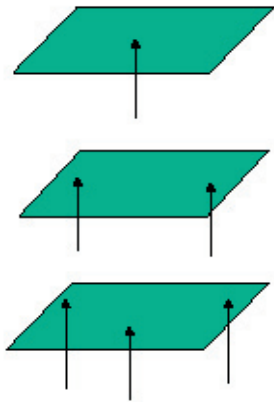

- One tie allows model to “pivot”
- Two ties allows model to tip in two directions
- Three ties stabilizes the model
- Additional ties allow checks

## Stabilization Model

Figure 8-10

Geodetic principles require a hierarchy layer approach to survey control similar to familiar historical classifications of 1<sup>st</sup>, 2<sup>nd</sup>, 3<sup>rd</sup> Orders of Accuracy. Accuracy begins at the highest level (HARN/CORS) and works through a well-adjusted, widespread network to a dense project-specific framework.

While the scope of a Primary Reference Network is based on the number and location of prioritized WSDOT project corridors, as well as the coordinated needs of WSDOT partners, the scope of the Project Geometric Framework is based on specific needs of the infrastructure improvement.

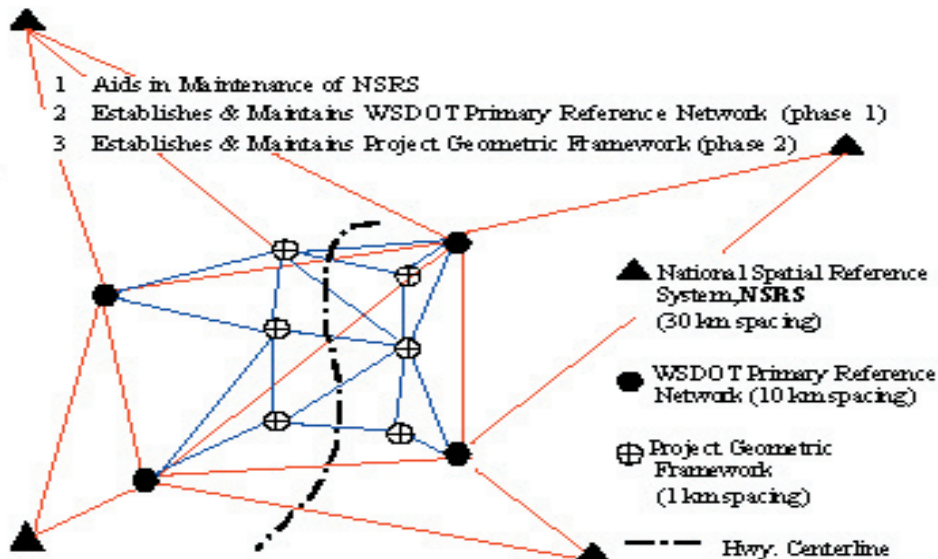

## Primary Reference Network

Figure 8-11

The Project Geometric Framework is delivered in the form of a “template” and used in the following manner:

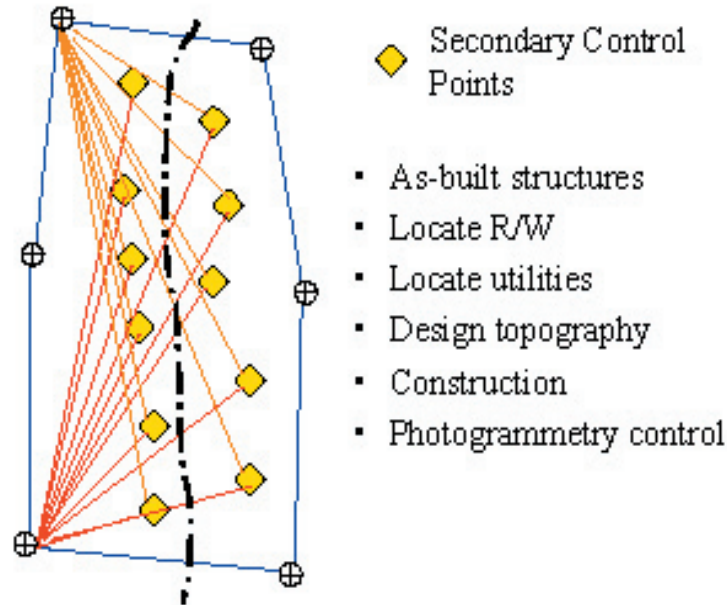

### Geometric Frame Work

Figure 8-12

**Definition:** A **Project Geometric Framework control station** is a station used to control a survey that uses RTK methods. The station has either horizontal coordinates, a height, or both. The order of accuracy of the horizontal coordinates and the height is at least tertiary.

**Definition:** A **GPS site calibration** establishes a relationship between the observed WGS84 coordinates and the known grid coordinates. This relationship is characterized by a translation, rotation, and scale factor for the horizontal coordinates and by an inclined plane for the heights. By applying a GPS site calibration to newly observed stations, local variations in a mapping projection are reduced and more accurate coordinates are produced from the RTK survey.

**Note:**

A GPS site calibration can be produced from RTK observations, an “office calibration,” or from a combination of both. If the RTK control stations were established by static or fast static GPS techniques, then an office calibration may be used.

The procedures for an office calibration are:

- Do a minimally constrained adjustment before normalization holding only one WGS84 latitude, longitude, and ellipsoid height fixed.
- Associate the results of this minimally constrained adjustment with the final grid coordinates in a site calibration.

**8-03.3(b) Satellite Geometry**

Satellite geometry affects both the horizontal coordinates and the heights in GPS/RTK surveys. The satellite geometry factors to be considered for RTK surveys are:

- Number of common satellites available at the base station and at the rover unit.
- Minimum elevation angle for the satellites (elevation mask).
- Positional Dilution of Precision (PDOP) or Geometric Dilution of Precision (GDOP).
- Vertical Dilution of Precision (VDOP).

Refer to Figures 8-8a, 8-8b, and 8-9 for specific requirements.

**8-03.3(c) Field Procedures**

Proper field procedures must be followed in order to produce an effective RTK survey.

For tertiary RTK Surveys:

- It is recommended that the base station occupy an RTK control station with known coordinates for horizontal RTK surveys and known heights for vertical RTK surveys.
- Use a fixed height survey rod or a survey rod with locking pins for the rover pole. A tripod and a tribrach may also be used. If a fixed height survey rod or a survey rod with locking pins is not used, independent antenna height measurements are required at the beginning and ending of each setup and must be made in both feet and meters. The antenna height measurements must check to within  $\pm 3$ mm and  $\pm 0.01$  feet.
- Use a bipod/tripod with the rover unit's survey rod.
- Establish the data transfer link.
- Observe a minimum of five common satellites at the base station and the rover unit(s).
- Initialize the rover unit(s) before collecting survey data.
- The initialization must be a valid checked initialization.
- PDOP must not exceed 5.
- Collect data only when the root mean square (RMS) is less than 70 millicycles.
- Observe a check shot by the rover unit(s) immediately after the base station is set up and before the base station is taken down.
- The GPS site calibration must have a maximum horizontal residual of 0.07 ft (20 mm) for each horizontal RTK control station.
- The GPS site calibration must have a maximum vertical residual of 0.10 ft (30 mm) for each vertical RTK control station.
- Occupy the new stations for a minimum of 30 epochs of collected data.
- The precision of the measurement data must have a value less than or equal to 0.03 ft (10 mm) horizontal and 0.05 ft (15 mm) vertical for each observed station.
- Locate the rover unit(s) not more than 6 miles (10 km) from the base station.
- The 2nd occupation of a new station must have a maximum difference in coordinates from the 1st occupation of 0.07 ft (20 mm).



- The 2nd occupation of a new station must reinitialize by forcing loss of lock to satellites and radio link by inverting antenna (antenna dump)
- The 2nd occupation of a new station must have a maximum difference in height from the 1st occupation of 0.13 ft (40 mm).
- When setting supplemental control by RTK methods for conventional surveys methods, it is recommended that the new control points be a minimum of 1000 ft (300 meters) from each other. See Chapter 7, “Accuracy Classifications and Standards,” for minimum accuracy standards that must be achieved for specific surveys.
- When establishing set-up points for conventional survey methods, set three intervisible points instead of just an “azimuth pair.” This allows the conventional surveyor a check shot.)

For general-order RTK surveys:

- It is recommended that the base station occupy an RTK control station with known coordinates for horizontal RTK surveys and known heights for vertical RTK surveys.
- Independent antenna height measurements are required at the beginning and ending of each setup and must be made in both feet and meters. The antenna height measurements must check to within  $\pm 0.01$  feet and  $\pm 3$  mm.
- Use a fixed height survey rod or a survey rod with locking pins for the rover poles. A tripod and tribrach may also be used. If a fixed height survey rod or a survey rod with locking pins is not used, independent antenna height measurements are required at the beginning and ending of each setup and must be made in both feet and meters. The antenna height measurements must check to within  $\pm 0.01$  feet and  $\pm 3$  mm.
- Use a bipod/tripod with the rover unit’s survey rod.
- Establish the data transfer link.
- Observe a minimum of five common satellites by the base station and the rover unit(s).
- Initialize the rover unit(s) before collecting survey data.
- The initialization must be a valid checked initialization.
- PDOP must not exceed six.
- Collect data only when the root mean square (RMS) is less than 70 millicycles.
- Observe a check shot by the rover unit(s) immediately after the base station is set up and before the base station is taken down.
- The GPS site calibration must have a maximum horizontal residual of 0.07 ft (20 mm) for each horizontal RTK control station.
- The GPS site calibration must have a maximum vertical residual of 0.10 ft (30 mm) for each vertical RTK control station.
- The precision of the measurement data must have a value less than or equal to 0.05 ft (15 mm) horizontal and 0.07 ft (20 mm) vertical for each observed station.
- Locate the rover unit(s) not more than 6 miles (10 km) from the base station.

### **8-03.3(d) Office Procedures**

### **Global Positioning System (GPS) Survey Specifications**

Effective office procedures must be followed in order to produce valid results. These procedures include:

- Review the downloaded field file for correctness and completeness.
- Check the antenna heights for correctness.
- Check the base station coordinates for correctness.
- Analyze all reports.
- Compare the different observations of the same stations to check for discrepancies.
- After all discrepancies are addressed, merge the observations.
- Analyze the final coordinates and the residuals for acceptance.

#### **8-03.3(e) General Notes**

- At present, do not use RTK surveys for pavement elevation surveys or for staking major structures.
- If the data transfer link is unable to be established, the RTK survey may be performed with the intent of post processing the survey data.
- The data transfer link must not “step on” any voice transmissions.
- If a UHF/VHF frequency is used for the data transfer link, check it for voice transmissions before use.
- The data transfer link is to employ a method for ensuring that the signal does not interfere with voice transmissions.

#### **8-03.4 Tertiary RTK Surveys**

##### **8-03.4(a) Applications**

Tertiary horizontal accuracy is acceptable for the following typical WSDOT RTK operations:

- Supplemental control for engineering surveys and construction surveys
- Photo control
- Controlling land net points
- Construction survey set-up points
- Topographic survey set-up points
- Monument surveys
- Monument surveys (set)

Tertiary vertical accuracy is acceptable for the following typical WSDOT RTK operations:

- Supplemental control
- Photo control
- Construction survey set-up points
- Topographic survey set-up points

Figures 8-8a and 8-8b list the specifications for tertiary accuracy using RTK procedures.

### **8-03.5 General-Order RTK Surveys**

#### **8-03.5(a) Applications**

General-order accuracy is acceptable for the following typical WSDOT RTK operations:

- Topographic surveys (data points)
- Supplemental design data surveys
- Construction surveys (staked points) excluding major structure points and finish grade stakes
- Environmental surveys
- Geographic Information System (GIS) surveys

Figure 8-9 lists the specifications for general-order accuracy using RTK procedures.

| <b>Specification</b>   | <b>RTK Survey</b>                     |
|--|---------------------------------------|
| <b>Field</b>   |                                       |
| Geometry of RTK control stations   | Surround and enclose the RTK project  |
| Minimum accuracy of RTK control stations                                     | Tertiary                              |
| Minimum number of horizontal RTK control stations for horizontal RTK surveys | 4                                     |
| Minimum number of vertical RTK control stations for vertical RTK surveys     | 5                                     |
| Base station occupies an RTK control station                                 | Recommended                           |
| Percent of data collected with a valid checked initialization                | 100 %                                 |
| Maximum PDOP during station observation                                      | 5                                     |
| Minimum number of satellites observed simultaneously                         | 5                                     |
| Maximum epoch interval for data sampling                                     | 5 seconds                             |
| Minimum satellite mask above the horizon                                     | 15 degrees                            |
| Maximum RMS during a station observation                                     | 70 millicycles                        |
| Minimum number of epochs of collected data for each observation              | 30                                    |
| Horizontal precision of the measurement data for each observation            | Less than or equal to 0.03 ft (10 mm) |
| Vertical precision of the measurement data for each observation              | Less than or equal to 0.05 ft (15 mm) |

**Tertiary-Order RTK Survey Specifications**

*Figure 8-8a*

| Specification   | RTK Survey      |
|---|-----------------|
| Maximum residual of the horizontal coordinates for the horizontal RTK control stations in the GPS calibration | 0.07 ft (20 mm) |
| Maximum residual of the height for the vertical RTK control stations included in the GPS calibration          | 0.10 ft (30 mm) |
| Maximum distance from the base station to the rover unit(s)   | 6 miles (10 km) |
| Percent of new stations occupied 2 or more times  | 100%            |
| Percent of second occupations having a different base station   | 100%            |
| Maximum difference in horizontal coordinates of the second occupation from the first occupation               | 0.07 ft (20 mm) |
| Maximum difference in height of the second occupation from the first occupation                               | 0.13 ft (40 mm) |
| Establish stations to be used as conventional survey control in groups of 3                                   | Yes             |
| <b>Office</b>   |                 |
| Check the data collector file for correctness and completeness  | Yes             |
| Check the base station WGS84 coordinates and ellipsoid height for correctness                                 | Yes             |
| Analyze the GPS site calibration for a high scale factor and high residuals                                   | Yes             |
| Compare check shots with the known values   | Yes             |
| Check all reports for high residuals  | Yes             |

### Tertiary-Order RTK Survey Specifications

*Figure 8-8b*

**Global Positioning System (GPS) Survey Specifications**

| <b>Specification</b>  | <b>RTK Survey</b>                     |
|---|---------------------------------------|
| <b>Field</b>  |                                       |
| Geometry of RTK control stations  | Surround & enclose the RTK project    |
| Minimum accuracy of RTK control stations                                      | Tertiary                              |
| Minimum number of horizontal RTK control stations for horizontal RTK surveys  | 3                                     |
| Minimum number of vertical RTK control stations for vertical RTK surveys      | 4                                     |
| Base station occupies an RTK control station                                  | Recommended                           |
| Percent of data collected with a valid checked initialization                 | 100 %                                 |
| Maximum PDOP during station observation                                       | 6                                     |
| Minimum number of satellites observed simultaneously                          | 5                                     |
| Maximum epoch interval for data sampling                                      | 5 seconds                             |
| Minimum satellite mask above the horizon                                      | 13 degrees                            |
| Maximum RMS during station observation  | 70 millicycles                        |
| Horizontal precision of the measurement data for each observation             | Less than or equal to 0.05 ft (15 mm) |
| Vertical precision of the measurement data for each observation               | Less than or equal to 0.07 ft (20 mm) |
| <b>Office</b>   |                                       |
| Check the data collector file for correctness and completeness                | Yes                                   |
| Check the base station WGS84 coordinates and ellipsoid height for correctness | Yes                                   |
| Analyze the RTK site calibration for a high scale factor and high residuals   | Yes                                   |
| Compare check shots with the known values                                     | Yes                                   |
| Check all reports for high residuals  | Yes                                   |

**General-Order RTK Survey Specifications**

*Figure 8-9*

### 9-01 General

Survey specifications describe the methods and procedures needed to attain the desired survey standard. Specifications in the section are based on Federal Geodetic Control Subcommittee (FGCS) standards and specifications. Except where noted, they have been modified to give results that will meet the standards for various TSS surveys typically performed by WSDOT. For complete standards, refer to Chapter 7, “Accuracy Classifications and Standards”.

WSDOT TSS survey specifications are to be used for all WSDOT involved transportation improvement projects, including special-funded projects.

### 9-02 The TSS Method

The TSS is a system that includes an electronic total station and electronic data collecting system. Conventional survey methods of traverse, network, resection, multiple ties and trigonometric leveling are used with the TSS method. Each WSDOT field survey crew is equipped with a TSS. The basic specifications for the WSDOT TSS are:

- Angle measurement: 6” accuracy, (Standard deviation = 1”)  
Distance measurement: +/- (0.01 ft (3 mm) + 3 ppm) in standard mode
- Data Controller: WSDOT standard data controller and with software compatible with WSDOT’s design and survey software.
- PC Software: WSDOT’s current supported software

The system also includes tripods, tribrachs, prisms, targets and prism poles.

For specific questions about the use of the software, see the programs Manual available on-line or the WSDOT software training manuals.

The specifications included in this Section are based on the basic WSDOT TSS. If other TSS are used, those specifications might not be applicable.

All TSS equipment must be properly maintained and regularly checked for accuracy. Equipment repair, adjustment, and maintenance are covered in Chapter 3, “Equipment.”

### 9-03 General TSS Survey Specifications

#### 9-03.1 Redundancy

When proper procedures are followed, the WSDOT TSS generally can easily meet the accuracy standards for WSDOT second order, third order and general order surveys. For example, the WSDOT TSS instrument specifications indicate that angles observed one time will meet the required accuracy standards, but without redundancy of observations, the possibility of blunders exist. For this reason, a complete set of angles is observed (two pointings to the backsight and two pointings to the foresight, minimum) whenever establishing or tying existing critical points such as control points and cadastral points. Redundant observations such as multiple ties are observed, whenever feasible, to improve the information available from least squares adjustments to strengthen survey networks.

### **9-03.2 Equipment Checks**

Check total station vertical index and horizontal collimation each day.

Systematic errors due to poorly maintained equipment must be eliminated to ensure valid survey adjustments. Regularly check and adjust optical plummets, tribrachs, tripods, and leveling bubbles. For barometers and thermometers, check regularly for accuracy.

### **9-03.3 Set Up**

**Height of instrument and target:** Measure and enter the H.I. and H.T. into the data controller at the beginning of each set up. It is advisable to check the target and instrument heights at the completion of each set up along with the optical plummet's position over the point.

**Temperature and barometric pressure:** Measure and enter the appropriate parts per million (ppm) correction into the data controller before work each day for general order and third order surveys. For second order surveys, make temperature and pressure readings and enter ppm correction into the data controller again at midday. Each 34°F (1°C) change in temperature will cause a one-ppm error, if the ppm setting in the data controller is not changed.

**Checking:** After setting the instrument up, measure the distance to the backsight to provide a check. Observations of other known points are encouraged whenever practical. For general order surveys, it is good practice to observe selected points from two setups as a check. At the conclusion of each setup, re-observe the direction to the backsight. For general order surveys (construction staking, topographic surveys, etc.), where areas are surveyed from two different setups, have common points from the two setups to provide additional checks.

**Mode:** All distance observations for second order and third order surveys are taken in standard measurement mode on the total station. Distances for general order surveys may be taken in track mode.

### **9-03.4 Field Notes**

Original survey notes, for all TSS observations, are maintained in the data controller and are stored electronically. Data controller headers must be completely filled in. Add comments about observations that might affect data reduction to the data controller file with a text entry. Data for all points that will be used as control and any cadastral monuments must be collected with 2 pointings in the data controller to be incorporated into a least squares adjustment.

Supplement the data controller notes with hand written notes. At a minimum, these notes include setup information (point numbers, codes, measure ups,), sketches, detailed descriptions and/or rubbings of monuments as appropriate and other general comments about the survey. Field notes are not complete unless they contain the date, project name and/or number, page number, and crew names.

### **9-03.5 Survey Adjustments**

All control points used for data gathering and stake out, including photo control, are adjusted by the method of least squares. Control points established by resection methods are adjusted for horizontal position by least squares before they are used in the field.



## 9-04 Second Order Surveys

### 9-04.1 Applications

**Corridor Control:** TSS can be used to perform second order trigonometric leveling surveys for Corridor Control Surveys.

**Project Control:** TSS can be used for horizontal and vertical Project Control Surveys to densify project control established by GPS.

### 9-04.2 Horizontal Specifications

**Method:** Traverse with cross ties. Figure 9-1 lists the specifications required to achieve second order horizontal accuracy.

### 9-04.3 Vertical Specifications

**Method:** Trigonometric Leveling, a method by which differences in elevation are determined by measuring vertical angles and slope distances.

Trig leveling is a separate and different procedure than carrying elevations with conventional total station traversing. The total station is setup anywhere convenient just like a level and there is no measure up at the instrument. There is no requirement for balanced sight lengths, and differences in elevation of 60 feet or more between backsight and foresight in one setup are not uncommon in steep terrain. The key to success is redundant elevation differences to fixed height targets.

Figure 9-2 lists the specifications required to achieve second order vertical accuracy.

**Total Station System (TSS) Survey Specification**

| Specifications   | Traverse/Network           |
|--|----------------------------|
| Check vertical index error   | Daily                      |
| Check horizontal collimation   | Daily                      |
| Measure instrument height and target height  | Begin and end each setup   |
| Use optical plummet to check position of target and instrument over points                                 | Begin and end each setup   |
| Measure temperature and pressure and enter ppm correction into total station                               | First set-up, midday setup |
| Measure distance to backsight and foresight at each setup  | Required                   |
| Observe traverse multiple ties to improve least squares adjustment   | Required, as feasible      |
| Close all traverses  | Required                   |
| Horizontal angle observations  | 3D, 3R (2 set) minimum     |
| Vertical angle observations  | 3D, 3R (2 set) minimum     |
| Angular rejection limit, i.e., reject angle if difference compared to mean of observations is greater than | 5"                         |
| Minimum distance measurement   | 330 ft                     |

**Second order (Horizontal) TSS Survey Specifications**

*Figure 9-1*

| Specifications   | Trigonometric Leveling      |
|--|-----------------------------|
| Check vertical index error   | 4 times per day             |
| Use fixed height staff for target  | Required                    |
| Measure temperature and pressure and enter ppm correction into total station                               | First setup, midday setup   |
| Vertical angle observations  | 2 sets of 2D, 2R (See Note) |
| Angular rejection limit, i.e., reject angle if difference compared to mean of observations is greater than | 10"                         |
| Measure uncorrected zenith distance  | Each pointing               |
| Measure uncorrected slope distance   | Each pointing               |
| Difference between two differences in elevation for each setup not to exceed                               | 0.005 ft                    |
| Maximum sight length   | 700 ft                      |
| Minimum ground clearance of line of sight  | 3 ft                        |

Note:

Two sets (eight pointings); each set of observations (2D, 2R) yields an independent difference in elevation between the backsight and foresight.

**Second order (Vertical) TSS Survey Specifications**

*Figure 9-2*

## **9-05 Third Order Surveys (Tertiary)**

TSS can be used for both third order horizontal and vertical positioning.

### **9-05.1 Applications**

- Supplemental control surveys for construction and engineering surveys
- Photogrammetric control
- Cadastral Location control
- Monumentation control
- Major structure and interchange staking

Supplemental control points are points that will be used as setup points to gather topographic data, locate monuments, perform Construction Staking and setout other control and right of way monuments.

### **9-05.2 Specifications**

#### **Methods:**

- Traverse
- Resection: This method locates the unknown position of a setup point by observing known positions from the unknown point. Generally, points are resectioned by observing three known points of equal or greater accuracy. Two point resections may be acceptable if the angle between the observed points is less than 135 degrees or greater than 225 degrees. All specifications for third order must be met. Figure 9-3 lists the specifications required to achieve third order accuracy.

## Total Station System (TSS) Survey Specification

| Specifications   | Traverse/Network<br>Resection Double Tie |
|--|--|
| Check vertical index error   | Daily                                    |
| Check horizontal collimation   | Daily                                    |
| Measure instrument height and target height  | Begin and end each setup                 |
| Use optical plummet to check position of target and instrument over points                                 | End of each setup                        |
| Measure temperature and pressure and enter ppm correction into total station                               | First set-up of day                      |
| Measure distance to backsight and foresight at each setup  | Required                                 |
| Observe traverse multiple ties to improve least squares adjustment   | As feasible                              |
| Close all traverses  | Required                                 |
| Number of known points to observe  | N/A                                      |
| Horizontal angle observations  | 2D, 2R (1 set) minimum                   |
| Vertical angle observations  | 2D, 2R (1 set) minimum                   |
| Angular rejection limit, i.e., reject angle if difference compared to mean of observations is greater than | 10"                                      |
| Minimum distance measurement to meet horizontal standard   | 165 ft                                   |
| Maximum distance measurement to meet vertical standard   | 330 ft                                   |

### Third-Order TSS Survey Specifications

Figure 9-3

## 9-06 General Order Surveys

### 9-06.1 Applications

- Engineering survey collected topographical data
- Construction survey, staked points
- GIS surveys
- Environmental surveys

### 9-06.2 Specifications

The radial survey method is used for all General Order surveys. Data for General Order points are gathered as radial observations in the data controller and are not available for least squares adjustment.

For construction staking, staked positions are rejected, when the difference between the "set" (observed) position and the theoretical design position exceeds the allowable tolerances.

Engineering survey data points are checked by various means including reviewing the digital terrain model, reviewing digital terrain lines in profile, and redundant measurements to some points from more than one setup.

Figure 9-4 lists the specifications required to achieve General Order accuracy.

| <b>Specifications</b>  | <b>Radial</b>            |
|--|--------------------------|
| Check vertical index error   | Daily                    |
| Check horizontal collimation   | Daily                    |
| Measure instrument height and target height                                  | Yes                      |
| Use optical plummet to check position of target and instrument over points   | Begin and end each setup |
| Measure temperature and pressure and enter ppm correction into total station | First set-up of day      |
| Horizontal angle observations  | 1D                       |
| Vertical angle observations  | 1D                       |
| Minimum distance measurement to meet horizontal standard                     | 65 ft                    |
| Maximum distance measurement to meet vertical standard                       | 500 ft                   |

**General-Order TSS Survey Specifications**  
*Figure 9-4*



## 10-01 General

Survey specifications describe the methods and procedures needed to attain a desired survey standard. Specifications in this chapter are based on Federal Geodetic Control Subcommittee (FGCS) standards and specifications. Except where noted, they have been modified to give results that will meet the requirements for various types of differential leveling surveys typically performed by WSDOT. For details regarding standards, refer to Chapter 7, “Accuracy Classifications and Standards.”

WSDOT differential leveling survey specifications are to be used for all WSDOT-involved transportation improvement projects, including special-funded projects.

## 10-02 Differential Leveling Method

These specifications apply to the use of compensator-type engineer’s levels and electronic digital/bar code leveling systems. Equipment to be used is specified under “Method” for each order of accuracy in this chapter.

- Specifications for trigonometric leveling are covered in Chapter 9, “Total Station System (TSS) Survey Specifications.”
- Specifications for GPS derived elevations are covered in Chapter 8, “Global Positioning System (GPS) Survey Specifications.”

All differential leveling equipment must be properly maintained and regularly checked for accuracy. Systematic errors due to poorly maintained equipment must be eliminated to ensure valid survey adjustments. Equipment acquisition, repair, adjustment, and maintenance are covered in Chapter 3, “Survey Equipment.”

## 10-03 General Differential Leveling Survey Specifications

### 10-03.1 Sight Distances

Sight distances and the balance between foresights and backsights are critical to maintaining accuracy in differential leveling. When poor environmental conditions are encountered reduce the sight distances. Under normal conditions the sight distances specified in this chapter will produce surveys that meet WSDOT accuracy standards for second-, third-, and general-order surveys. (See “Limits of Sight Distances,” page 10-4.)

### **10-03.2 Turning Points**

Set turning points (TP) in stable, protected locations. Spikes or large nails set in pavement; wooden stakes set in firm soil; and prominent points such as rock outcroppings or the top of concrete curbs may be used as turning points. If a turning point does not have a definite high point, provide a mark at the exact point of rod contact.

Do not remove turning points after use, but leave them in place to provide a check in the event of blunders or excessive misclosures. A solid, well defined turning point may be used as a temporary bench mark (TBM).

### **10-03.3 Benchmarks**

Benchmarks are a series of permanent points of known elevation located within the limits of the project. Benchmarks are very important, since the gradeline, earthwork, structure work and drainage are all referenced to benchmarks for elevation.

Establish benchmarks with physical characteristics and quality commensurate with the order of the leveling survey. Use benchmarks of a stable, permanent nature; e.g., galvanized steel pipe; steel rod driven into a firm soil base; or poured in place concrete. A brass WSDOT disk epoxied into a drill hole in rock or concrete is also acceptable. Stamp benchmarks with identifying information; date, point designation at a minimum.

Locate benchmarks where they will be conveniently and easily accessible. Whenever possible, locate benchmarks outside of construction areas, clear of traffic, and within a public right of way or easement. Allow for future changes in landscaping and overgrowth of trees and foliage.

Space benchmarks as required by project conditions and convenience of operation, generally not to exceed 3000 ft (1 km) apart. Minimum spacing for benchmarks is normally 1000 ft (300 m). In hilly terrain, place a benchmark where there is a 50 ft (15 m) difference in elevation. Place benchmarks within 200 ft (60 m) and on both sides of structure sites. Prepare a written benchmark/station description for inclusion in the survey notes and in the benchmark summary report.

Benchmarks should be shown on the Monumentation Map or the Record of Surveys as a method of recording.

### **10-03.4 Differential Leveling Survey Notes**

Record rod readings, for single- or three-wire leveling operations using a compensator-type engineer's level, in digital form on a hand-held programmable calculator, computer, or data collector. Such calculators must produce a hard copy of all readings, reductions, and adjustments. Hard copies of data collection, reduction, and adjustment calculations will be incorporated into, and become a permanent part of, the survey field notes. Field notes can be recorded by hand, but must be scanned to obtain electronic images of the notes.

Raw field data generated by an electronic digital/bar code leveling system will be translated into field book format by use of conversion software such as "DIGILEV Translation Program" or "STARPLUS Data Conversion Utility."

### **10-03.5 Adjustment of Differential Leveling Surveys**

A straight-line interpolation process adjusts second- and third-order differential leveling surveys, when run as a single loop or section. Corrections for the closing error will be prorated to each benchmark and TP between the two controlling benchmarks.



When multiple leveling survey loops interconnect to form a network, such as in corridor or project control, points common to two or more loops will be adjusted by application of least-squares adjustment. See “Least Squares Adjustment” in Chapter 7, “Accuracy Classifications and Standards.”

## **10-04 Second-Order Differential Leveling Surveys**

### **10-04.1 Application**

Second-order leveling surveys are generally confined to extending vertical control data over long distances, and establishing and maintaining corridor vertical control.

For second-order differential leveling specifications acceptable to the National Geodetic Survey, see *Standards and Specifications for Geodetic Control Networks* published by the Federal Geodetic Control Committee, September 1984.

### **10-04.2 Equipment**

Differential leveling survey methods/equipment to achieve second-order standards are:

- Compensator-type (automatic) engineer’s level (three-wire observations) with an invar-tape yard rod or a suitable metric graduated invar-tape rod.
- Electronic digital/bar-code leveling system with one-piece invar rod.
- If matched rods are used they must be alternated (leapfrogged) between setups.

### **10-04.3 Second-Order Three-Wire Differential Leveling Surveys**

#### **Instrument Check**

At the beginning and end of each day’s operation, check the instrument for collimation error (two-peg test), recording the tests into the survey notes. Description of the two-peg test can be found in any standard surveying text. If an error in excess of 0.007 ft (2 mm) within a 200 ft (60 m) sight distance is detected, readjust the level. Immediately check the instrument if it is severely jolted, bumped, or suspected as such. Check compensator-type instruments for proper mechanical operation at least every two weeks of use. See Section 3-03 Adjustment of Equipment for specific instructions on performing the two-peg test.

#### **Limits of Sight Distances**

Do not exceed sight distances of 230 ft (70 m). When more than two rod readings (see Rod Readings, below) are rejected in ten setups, reduce the sighting distance. Do not exceed 15 ft (5 m) for the difference in length between foresights and backsights of a single setup.

#### **Rod Readings**

Rod readings are estimated to the nearest 0.005 ft (1 mm). For each foresight and backsight reading of a set, the middle wire reading must be within 0.005 ft (1 mm) of the mean of all three wire readings. If this is not achieved, the misread or mis-recorded wire must be identified and corrected before moving to the next setup.

See Figure 10-1 for second-order, three-wire differential leveling standards and specifications.

### **10-04.5 Second Order, Electronic Digital/Bar Code Rod Leveling System**

Manufacturers specifications recommend that the electronic digital leveling instrument not be exposed to direct sunlight. Use umbrellas in bright sunlight. When using electronic digital leveling instruments, the absolute collimation error will be recorded along with the leveling data.

### Differential Leveling Survey Specifications

See Figure 10-1 for second order electronic digital/bar code differential leveling standards and specifications.

| Operation/Specification   | Compensator-Level<br>Three-Wire<br>Observation                         | Electronic/Digital<br>Bar Code Level                                   |
|---|--|--|
| Difference in length between fore and back sights, not to exceed per setup                      | 16 ft (5 m)  | 16 ft (5 m)  |
| Cumulative difference in length between fore and back sights, not to exceed per loop or section | 33 ft (10 m)   | 33 ft (10 m)   |
| Maximum sight lengths   | 230 ft (70 m)  | 230 ft (70 m)<br><i>see Note 1</i>                                     |
| Minimum ground clearance of sight line  | 1.5 ft (0.5 m)   | 1.5 ft (0.5 m)   |
| Maximum section misclosure  | $0.035 \text{ ft } \sqrt{Dm}$ (8 mm $\sqrt{Dk}$ )<br><i>see Note 2</i> | $0.035 \text{ ft } \sqrt{Dm}$ (8 mm $\sqrt{Dk}$ )<br><i>see Note 2</i> |
| Maximum loop misclosure   | $0.035 \text{ ft } \sqrt{Dm}$ (8 mm $\sqrt{Dk}$ )<br><i>see Note 3</i> | $0.035 \text{ ft } \sqrt{Dm}$ (8 mm $\sqrt{Dk}$ )<br><i>see Note 3</i> |
| Difference between top and bottom interval not to exceed:                                       | 0.20 of rod unit   | N/A  |
| Collimation (Two-Peg) Test  | Daily - not to exceed<br>0.007 ft (2 mm)<br><i>see Note 4</i>          | Daily  |
| Minimum number of readings.<br>(Use repeat measure option for each observation.)                | N/A  | 3<br><i>see Note 5</i>   |

Notes;

- Leveling staff in backlit condition may decrease maximum sight distance.
- $D$  = Shortest one-way length of section in miles ( $Dm$ ) or kilometers ( $Dk$ ) (section is defined as an unbroken series of setups between two permanent control points).
- $E$  = Length of loop in km (loop is defined as a series of setups closing on the starting point).
- Readjust level if 0.007 ft in 200 ft (2 mm in 60 m) is exceeded.
- If standard error exceeds 0.003 ft (0.1 mm), continue repeat measurements until standard error is less than 0.003 ft (0.1 mm),

### Second-Order Differential Leveling Specifications

*Figure 10-1*

Although the above Figure 10-1 provides maximum specifications it is recommended that the following guidelines be used during normal working conditions:

- Keep sights to 60 meters or less (200 feet).
- Keep imbalances to around 2 meters or less (6.5 feet).

- Always use the same rod used to come off the control mark to establish elevations on new marks.
- Try not to use the very bottom or top of the rod.
- Keep the rod plumb. If a truck wind hits either the instrument or the rod during a shot repeat the shot. Try to take shots between “large” truck traffic.
- Make sure that the claws for the instrument legs are kicked well into the ground.
- If using turtles (turning plates) to aid in leveling, make sure turtle is well into the ground.

## **10-05 Third-Order Differential Leveling Surveys**

### **10-05.1 Applications**

Third-order leveling surveys are used to establish vertical control and maintain benchmarks for:

- Project Control
- Supplemental Control
- Photo Control
- Construction Survey Control
- Topographic Survey Control
- Major Structure Points

### **10-05.2 Specifications**

#### **Methods:**

- Compensator-type engineer’s level (three-wire method) and yard rod or metric graduated Philadelphia-style rod
- Compensator-type engineer’s level (single-wire method) and metric graduated Philadelphia-style rod
- Philadelphia-style rod
- Electronic/digital level and bar-code rod (wood or noninvar metal)

See Figure 10-2 for third-order differential leveling methods and specifications.

## **10-06 Order G (General) Differential Leveling Surveys**

The survey party chief determines appropriate procedures for Order G (General) differential leveling, based on the particular needs of the survey task being performed. When developing procedures consider the following: objective of task, specific needs of the project and most efficient use of time.

See Chapter 14, “Location Survey Procedures,” and Chapter 15, “Construction Survey Procedures,” for tolerances and accuracy standards for specific types of surveys.

### **10-6.1 Applications**

Order G leveling surveys are generally used to provide elevations for:

- Supplemental Design Surveys
- Construction Layout
- Environmental Surveys

### ***Differential Leveling Survey Specifications***

- GIS Data Surveys
- Topographic Survey Data Capture

#### ***10-6.2 Specifications***

Compensator-type engineer's level (single-wire method) methods:

- Philadelphia-style rod
- Lenker-style rod
- 25 foot extendible fiberglass rod

| Operation/Specification  | Compensator-Level<br>Three-Wire Observation                        | Compensator-<br>Level Single-Wire<br>Observation                   | Electronic/Digital Bar<br>Code Level                                |
|--|--|--|---|
| Difference in length between fore and back sights, not to exceed per setup                     | 33 ft (10 m)   | 33 ft (10 m)   | 33 ft (10 m)  |
| Cumulative difference in length between fore and backsights, not to exceed per loop or section | 33 ft (10 m)   | 33 ft (10 m)   | 33 ft (10 m)  |
| Maximum sight lengths  | 300 ft (90 m)  | 300 ft (90 m)  | 300 ft (90 m)<br>see Note 1   |
| Minimum ground clearance of sight line   | 1.5 ft (0.5 m)   | 1.5 ft (0.5 m)   | 1.5 ft (0.5 m)  |
| Maximum section misclosure   | $0.05 \text{ ft } \sqrt{Dm}$<br>(12 mm $\sqrt{Dk}$ )<br>see Note 2 | $0.05 \text{ ft } \sqrt{Dm}$<br>(12 mm $\sqrt{Dk}$ )<br>see Note 2 | $0.035 \text{ ft } \sqrt{Dm}$<br>(12 mm $\sqrt{Dk}$ )<br>see Note 2 |
| Maximum loop misclosure  | $0.05 \text{ ft } \sqrt{Dm}$<br>(12 mm $\sqrt{Dk}$ )<br>see Note 3 | $0.05 \text{ ft } \sqrt{Dm}$<br>(12 mm $\sqrt{Dk}$ )<br>see Note 3 | $0.035 \text{ ft } \sqrt{Dm}$<br>(12 mm $\sqrt{Dk}$ )<br>see Note 3 |
| Difference between top and bottom interval not to exceed                                       | 0.30 of rod unit   | N/A  | N/A   |
| Collimation (Two-Peg) Test   | Daily - not to exceed<br>0.007 ft (2 mm)<br>see Note 4             | Daily  | Daily   |
| Minimum number of readings (Use repeat measure option for each observation)                    | N/A  | N/A  | 3<br>see Note 5   |

Notes:

- Leveling staff in backlit condition may decrease maximum sight distance.
- D = Shortest one-way length of section in miles (Dm) or kilometers (Dk) (section is defined as an unbroken series of setups between two permanent control points).
- E = Length of loop in km (loop is defined as a series of setups closing on the starting point). Em = miles, Ek = kilometers
- Readjust level if 0.007 ft in 200 ft (2 mm in 60 m) is exceeded.
- If standard error exceeds 0.003 ft (0.1 mm), continue repeat measurements until standard error is less than 0.003 ft (0.1 mm).

**Third-Order Differential Leveling Specifications**

Figure 10-2



**Circular Curves**

A circular curve is a segment of a circle — an arc. The sharpness of the curve is determined by the radius of the circle (R) and can be described in terms of “degree of curvature” (D). Prior to the 1960’s most highway curves in Washington were described by the degree of curvature. Since then, describing a curve in terms of its radius has become the general practice. Degree of curvature is not used when working in metric units.

**Nomenclature For Circular Curves**

|          |   |
|----------|---|
| P.O.T.   | Point on tangent outside the effect of any curve  |
| P.O.C.   | Point on a circular curve   |
| P.O.S.T. | Point on a semi-tangent (within the limits of a curve)  |
| P.I.     | Point of intersection of a back tangent and forward tangent   |
| P.C.     | Point of curvature - Point of change from back tangent to circular curve  |
| P.T.     | Point of tangency - Point of change from circular curve to forward tangent  |
| P.C.C.   | Point of compound curvature - Point common to two curves in the same direction with different radii   |
| P.R.C.   | Point of reverse curve - Point common to two curves in opposite directions and with the same or different radii                                       |
| L        | Total length of any circular curve measured along its arc   |
| $L_c$    | Length between any two points on a circular curve   |
| R        | Radius of a circular curve  |
| $\Delta$ | Total intersection (or central) angle between back and forward tangents   |
| DC       | Deflection angle for full circular curve measured from tangent at PC or PT  |
| dc       | Deflection angle required from tangent to a circular curve to any other point on a circular curve   |
| C        | Total chord length, or long chord, for a circular Curve   |
| $C'$     | Chord length between any two points on a circular Curve   |
| T        | Distance along semi-tangent from the point of intersection of the back and forward tangents to the origin of curvature (From the PI to the PC or PT). |
| E        | External distance (radial distance) from PI to midpoint on a simple circular curve  |

**Geometrics**

- M.O. The (radial) distance from the middle point of a chord of a circular curve to the middle point of the corresponding arc.
- tx Distance along semi-tangent from the PC (or PT) to the perpendicular offset to any point on a circular curve. (Abcissa of any point on a circular curve referred to the beginning of curvature as origin and semi-tangent as axis)
- ty The perpendicular offset, or ordinate, from the semi-tangent to a point on a circular curve

**Circular Curve Equations**

| Equations  | Units    |
|--|----------|
| $R = \frac{180^\circ}{\pi} \cdot \frac{L}{\Delta}$       | m or ft. |
| $\Delta = \frac{180^\circ}{\pi} \cdot \frac{L}{R}$       | degree   |
| $L = \frac{\pi}{180} \cdot R\Delta$                      | m or ft. |
| $T = R \tan \frac{\Delta}{2}$                            | m or ft. |
| $E = \frac{R}{\cos \frac{\Delta}{2}} - R$                | m or ft. |
| $C = 2R \sin \frac{\Delta}{2}, \text{ or } = 2R \sin DC$ | m or ft. |
| $MO = R \left( 1 - \cos \frac{\Delta}{2} \right)$        | m or ft. |
| $DC = \frac{\Delta}{2}$                                  | degree   |
| $dc = \frac{L_c}{L} \left( \frac{\Delta}{2} \right)$     | degree   |
| $C' = 2R \sin(dc)$                                       | m or ft. |
| $C = 2R \sin(DC)$  | m or ft. |
| $tx = R \sin(2dc)$                                       | m or ft. |
| $ty = R[1 - \cos(2dc)]$                                  | m or ft. |



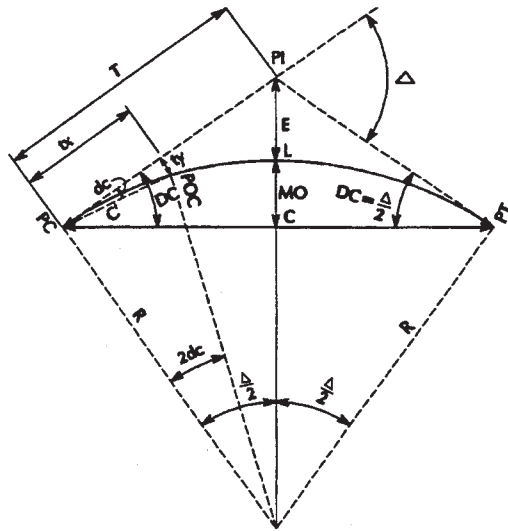

Constant for  $\pi = 3.14159265$

**Simple Circular Curve**  
*Figure 11-1*

After the length of the curve ( $L$ ) and the semi-tangent length ( $T$ ) have been computed, the curve can be stationed.

When the station of the PI is known, the PC station is computed by subtracting the semi-tangent distance from the PI station. (Do not add the semi-tangent length to the PI station to obtain the PT station. This would give you the wrong value) Once the PC station is determined, then the PT station may be obtained by adding  $L$  to the PC station.

All stationing for control is stated to one hundredth of a foot. Points should be set for full stations and at half station intervals. Full stations are at 100 ft intervals and half station intervals are at 50 ft. (10+00.00).

**Example Calculations for Curve Stationing**

Given: (See Figure 11-1)

$PI = 12 + 78.230$

$R = 500'$

$\Delta = 86^\circ 28'$

Find the PC and PT stations

Calculate  $T$

$T = R \tan (\Delta/2)$

$= 500 \tan 43^\circ 14'$

$= 470.08'$

## Geometrics

Calculate L ( $\Delta$  must be converted to decimal degrees)

$$\Delta = 86^\circ 28'$$

$$= 86^\circ + (28' / 60)$$

$$L = (\Delta/360^\circ) 2\pi R \text{ or } R\Delta (0.017453293)$$

$$= 754.56'$$

Calculate the PC station

$$PI - T = 1278.23' - 470.08'$$

$$T = 808.15'$$

$$PC \text{ station is } 8 + 08.15'$$

Calculate the PT station

$$PC + L = 808.15' + 754.56'$$

$$= 1562.71'$$

$$PT \text{ station is } 15 + 62.71$$

## Deflections

To lay out a curve it is necessary to compute deflection angles (dc) to each station required along the curve. The deflection angle is measured from the tangent at the PC or the PT to any other desired point on the curve. The total deflection (DC) between the tangent (T) and long chord (C) is  $\Delta/2$ .

The deflection per foot of curve (dc) is found from the equation:  $dc = (L_c / L)(\Delta/2)$ . dc and  $\Delta$  are in degrees.

Since  $L_c = 1'$ , the deflection per foot becomes:

$$dc / ft = (\Delta/2) / L$$

If only the radius is known, dc / ft can still be found:

$$dc / ft = (360^\circ/4\pi) \text{ or } 28.6479/R \text{ [Expressed in degrees]}$$

or  $1718.87338/R$  [Expressed in minutes]

The value obtained can then be multiplied by the distance between stations to obtain the deflection.

## Example Calculations for Curve Data

Given:

$$PI = 100 + 00.00$$

$$R = 1100'$$

$$\Delta = 16^\circ 30'$$

Find the deflection angles through the curve

Calculate T

$$\begin{aligned} T &= R \tan (\Delta/2) \\ &= 1100 \tan 8^{\circ} 15' \\ &= 159.49' \end{aligned}$$

Calculate L

$$\begin{aligned} \Delta &= 16^{\circ} 30' \\ &= 16.5^{\circ} \\ L &= (\Delta/360^{\circ}) 2\pi R \text{ or } R\Delta(0.017453293) \\ &= 1100' (16.5^{\circ}) (0.017452293) \\ &= 316.78' \end{aligned}$$

Calculate the PC station

$$\begin{aligned} PI - T &= 10,000 - 159.49' \\ &= 9840.51' \\ \text{PC station is } &98 + 40.51 \end{aligned}$$

Calculate the PT station

$$\begin{aligned} PC + L &= 9840.51 + 316.78' \\ &= 10157.29 \\ \text{PT station is } &101 + 57.29 \end{aligned}$$

Calculate the deflection per foot

$$\begin{aligned} dc / \text{ft} &= (\Delta/2) / L \\ &= 8^{\circ} 15' / 316.78' \\ &= 0.0260433^{\circ} / \text{ft} \end{aligned}$$

The first even station after the PC is 98 + 50.

Calculate the first deflection angle

$$\begin{aligned} L_c &= 9850' - 9840.51' \\ &= 9.49' \\ dc &= L_c(dc / \text{ft}) \\ &= 9.49(0.0260433^{\circ}/\text{ft}) \\ &= 0.2471509^{\circ} \\ &= 0^{\circ} 14' 50'' \end{aligned}$$

## Geometrics

The last even station before the PT is 101 + 50

Calculate the last deflection angle from the PC

$$\begin{aligned}L_c &= 10150 - 9840.51 \\ &= 309.49'\end{aligned}$$

$$\begin{aligned}dc &= L_c (dc / ft) \\ &= 309.49' (0.0260433^\circ / ft) \\ &= 8.0601409^\circ \\ &= 8^\circ 03' 37''\end{aligned}$$

Chord distances would now be calculated using  $c_1 = 2 R \sin (dc)$

## Curve Data

| Station     | Point | dc                      | Curve Data     |
|-------------|-------|-------------------------|----------------|
| 101 + 57.29 | PT    | 8°15'00''               | PI 100 + 00.00 |
|             |       | $\Delta = 16^\circ 30'$ |                |
|             |       | R = 1100'               |                |
|             |       | L = 316.78'             |                |
|             |       | T = 159.49'             |                |
| 101 + 50    |       | 8°03'37''               |                |
| 101 + 00    |       | 6°45'29''               |                |
| 100 + 50    |       | 5°27'21''               |                |
| 100 + 00    |       | 4°09'13''               |                |
| 99 + 50     |       | 2°51'05''               |                |
| 99 + 00     |       | 1°32'58''               |                |
| 98 + 50     |       | 0°14'50''               |                |
| 98 + 40.5   | PC    | 0°00'00''               |                |

**The deflection at the PT must equal  $\Delta/2$ .**

*Figure 11-2*

## Running the Curve

After completing the computations, it is necessary to establish the curve on the ground. When running the curve ahead on line (from PC to PT) the instrument is set on the PC, the plate set at zero and the telescope inverted for a sight on the back tangent. An alternative method would be to sight the PI without the telescope inverted if the PI has already been set and is visible.

Turn the deflection for the first even half station and accurately measure the proper distance to the desired station. Be sure to measure the chord distance and not the curve distance. The chord distance must be calculated. The backsight should be checked periodically to be certain that the instrument has not drifted.

The curve may be backed in from the PT by entering the total deflection and backing off to the PC. When the PC is sighted, zero should be read.

### **Radial Layout Method**

With the advent of electronic surveying, the need to occupy control points such as PCs, POCs, and PTs no longer exists. Control points that are set off the roadway in the vicinity of the curve are used for layout.

There are computer and data collector programs that calculate angles and distances from control points off the curve for setting points on the curve.

Coordinates of the curve alignment (such as 25 ft stationing) must be input into the Data Collector or computer with the off-the-curve control point coordinates.

The program then calculates the angles and distances from control points to layout the curve.

Specific information about this procedure may be found in the Data Collector reference manual under the “Roading” chapter.

Also, the design engineering software has commands and procedures to generate radial layout data.

### **Instrument Set At POC**

Assuming that the first part of a curve has been located by deflections from the PC, if the next part of the curve is not visible from the PC it must be located by deflections from some point on the curve, usually at a full station.

The instrument can be set on a point from which the PC can be backsighted (Methods A and B) or on any point from which some intermediate POC can be backsighted (Method C).

Method A uses deflection angles turned from the auxiliary tangent at the POC being occupied. Methods B (preferred) and C (for remote locations) use the original calculated (book) deflections turned from the extension of the chord from the PC to the occupied POC.

#### **Method A**

- Set the scale at the deflection angle for the point being occupied, but to the “wrong side”.
- Backsight on the PC with the scope inverted
- $0^\circ$  is now an auxiliary tangent.
- Turn deflection angles for the forward points based on their distance from the occupied POC and therefore turned from the auxiliary tangent.

### Method B

- Set the scale to  $0^\circ$
- Backsight on the PC with the scope inverted.
- $0^\circ$  is now the extension of the chord from the PC to the occupied POC.
- Turn deflection angles to the forward points using the original calculated (book) deflection angles.

### Method C

- Set the scale at the deflection angle for an intermediate point being sighted (POC<sub>1</sub>):  
 $d_{PI}$
- Backsight on the intermediate POC<sub>1</sub> with the scope inverted.
- $0^\circ$  is now the extension of the chord from the PC to the occupied POC.
- Turn deflection angles to the forward points using the original calculated (book) deflection angles.

## Offset Curves

Frequently it is necessary to locate outer and inner concentric curves, such as property lines, curb lines and offset curves for reference during construction. The full lengths of these offset curves are also desirable. Curve data can be calculated using the adjusted radius or by proportioning the center line data.

The subscripts “o” for outside and “i” for inside are commonly used to identify elements on offset curves.

For example, the length of an inside curve would be  $L_i = (\pi/180) R_i \Delta$ ;  $R_i$  being a shorter radius than the center line radius  $R$ . Or, by proportion,  $L_i = (R_i / R) L$ .

It is convenient to note that the difference in arc length  $L$  between the offset curve and the center line curve, for the same internal angle  $D$ , where  $w$  is the offset distance, is  $(2\pi\Delta / 360^\circ) w$ .

## Degree of Curvature

The two common definitions of degree of curvature ( $D$ ) are the arc definition used in highway work and the chord definition used by some counties and in railroad work.

By the arc definition, a  $D$  degree curve has an arc length of 100 feet resulting in an internal angle of  $D$  degrees. (So, the stationing and angles are known and the chords remain to be calculated.)

By the chord definition, a  $D$  degree curve has a chord of 100 feet resulting in an internal angle of  $D$  degrees. (So, the chords and angles are known and the arc stations would remain to be calculated.)

In terms of radius, a  $1^\circ$  curve by the arc definition would have a radius of 5729.578 feet. And by the chord definition, its radius is 5729.65 feet. In the days of slide rules, a radius of 5,730 feet might have been used as the formula  $R = 5730 / D$  in the Field Tables for Engineers, Spirals, 1957.

**Degree of Curvature for Various Lengths of Radii**

Exact for Arc Definition

$$D = \frac{100 \left( \frac{180}{\pi} \right)}{R} = \frac{18000}{\pi R}$$

Where D is Degree of Curvature

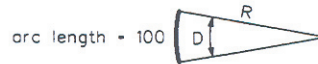
**Length of Radii for Various Degrees of Curvature**

$$R = \frac{100 \left( \frac{180}{\pi} \right)}{D} = \frac{18000}{\pi D}$$

Where R is Radius Length

**Degree of Curvature (Highway)***Figure 11-3***Field Record**

When not using a data collector it is necessary to handwrite field notes in the traditional manner

The field notes for curves are kept on transit note sheets. These are available on regular or “rite in rain” paper.

The left page is for station, curve data, deflections, and other such data. The right page is for ties to curve points, descriptions of points set and any pertinent drawings that may make clear to others just what was done in the field. This is very important, as the work may have to be reproduced years later.

It is useful to show the location of points relative to permanent objects. Note what the point is (spike, hub & tack, etc.), and how it is referenced.

Make notes that are neat and accurate. Title and index the first page of each operation. On the first page of each day’s work, show the date, crew, weather, and instrument by Serial number. Number and date every page. Notes written with the book turned are written with the right edge of the book toward the writer.

Do not use “scratch” notes intending to put them in the book later.

Field records are an important aspect in any survey. A well executed surveying job is worthless unless it is well documented. Take the time necessary, in the field, to create good records on what you have done.

**Spiral Curves**

WSDOT does not use spiral curves on new highway design but a knowledge of spiral curves is necessary when an existing highway alignment contains spiral curves.

A spiral curve is for the transition of a vehicle traveling at a sustained speed from a straight tangent to a circular curve. It is an attempt to approximate the path followed by a vehicle's wheels from when the operator begins to turn his steering wheel until he has reached the maximum degree of curvature at the circular portion of the curve.

Spiral curves are divided into an entering spiral transition, a circular curve, and an exiting spiral transition. In most cases the entering and exiting spiral will be equal. The major difference between a spiral and a circular curve is that the change of direction varies as the square of the length for a spiral rather than as the first power of the length for a circular curve. The degree of curvature on a spiral increases directly as the distance increases along the spiral curve from the tangent. The degree of curvature at any point in the spiral is the same as the degree of curvature of a circular curve having the same radius. A spiral curve will be tangent to a circular curve at the point where they share the same radius.

**Spiral Curve Elements**

For circular curve elements see circular curve segment in this chapter.

- a        Rate of change in the degree of curve of a spiral per 100 feet of length which equals the degree of curve on a spiral at a point 100' (one station) from the TS (or ST).  
 $a = D/L_s$  or  $a = D_s/L_s'$
- CΔ      Central angle of circular curve between connecting spiral curves.  
 $C \Delta = \Delta 2DE$  for equal spirals  
 $C \Delta = \Delta - (DE_1 + DE_2)$  for unequal spirals
- CS      Point of change from circular curve to spiral.  
 $CS = ST - (L_s \times 100)$
- C<sub>s</sub>      Total chord length for a spiral curve from its beginning (TS or ST) to its end (SC or CS).  
 $C_s = 100' L_s - 0.000338 a^2(L_s)^5$ ;  
also =  $\sqrt{X^2 + Y^2}$
- C<sub>s</sub>'      Chord length to any point on a spiral from TS or ST.  
 $C_s' = 100' L_s' - 0.000338 a^2(L_s')^5$ ;  
also =  $\sqrt{[(x')^2 + (y')^2]}$
- Δ        (delta) Total intersection or "central" angle between back and forward tangents.
- D        When used in reference to a spiral, D indicates the maximum degree of curvature of the spiral, which is at SC or CS.  
 $D = aL_s$
- DE      Deviation angle of spiral measured from back tangent (or forward tangent) to tangent through the spiral at its maximum degree.  
 $DE = [a(L_s)^2]/2$ ; also =  $DL_s/2$ ; also =  $DF + DH$
- de      Deviation angle of spiral measured from back tangent (or forward tangent) to tangent through any point on spiral.  
 $de = [a(L_s')^2]/2$ ; also =  $D_s L_s'/2$ ; also =  $df + dh$



- df Deflection angle to any point on spiral measured from tangent at TS (or ST).  
 $df = a(Ls')^2/6 - dfk$  in degrees
- DF Deflection angle for full spiral measured from tangent at TS (or ST) to SC (or CS) respectively.  
 $DF = a(Ls)^2/6 - DFk$ ; also  $DsLs/6 - DFk$ ;  
 also =  $DE/3 - DFk$
- dfk A correction, in minutes, to be applied to the equation for df when the angle de is 15° and over.  
 $dfk = 0.000053(DE)^3$
- DFk A correction, in minutes, to be applied to the equation for DF when the angle DE is 15° and over.  
 $DFk = 0.000053(DE)^3$
- dh Deflection angle required to establish tangent to any point on the spiral measured between tangent to the spiral at that point and the beginning of the spiral (TS or ST).  
 $dh = de - df$
- DH Deflection angle required to establish tangent to the spiral at its maximum degree when instrument is sighted on the beginning of the spiral (TS or ST).  
 $DH = DE - DF$
- dr Deflection angles required to be computed for each intermediate setup on a spiral to locate other points on the spiral. When sighting on TS or ST to establish tangent to the spiral,  $dr = dh$ .  
 $dr = df + Ds Ls'/6$
- Ds Degree of curve at any point on spiral.  
 $Ds = aLs'$
- Ls Total length of a spiral curve measured along its arc in stations of 100'.  
 $Ls = D/a$
- Ls' Length of spiral curve from T.S. (or S.T.) to any point on spiral measured along its arc in stations of 100'.  
 $Ls' = Ds / a$
- P.C.O. Point where circular curve, if extended around its center, has a tangent that is parallel to the spiral semi-tangent.
- POS Point on spiral.
- Q Offset distance perpendicular to the forward and back tangents that the circular curve is moved to accommodate the spiral transitions.  
 $Q = (0.0727a)(Ls)^3 - (0.0000002a^3)(Ls)^7$   
 (See Note 1)
- R Radius of circular curve in feet (minimum length of Rs for spiraled curve).

## Geometrics

- $R_s$  Radius in feet at any point on spiral curve.  
 $R_s = 5730/D_s$
- $SC$  Point of change from spiral to circular curve.  
 $SC = TS + (L_s \times 100)$
- $ST$  Point of change from spiral to forward tangent.
- $t$  Distance along semi-tangent of a spiral curve from  $TS$  (or  $ST$ ) to perpendicular offset through  $PCO$  in feet.  
 $t = 50L_s - (0.000127a^2)(L_s)^5$
- $T$  Distance along semi-tangent from the point of intersection of the back and forward tangents to the origin of curvature from that tangent.  
 $T = t + (R + Q) \tan \Delta/2$
- $TS$  Point of change from back tangent to spiral.  
 $TS = PI - T$
- $x$  Distance along semi-tangent of a spiral curve from  $TS$  (or  $ST$ ) to perpendicular offset to the end of spiral in feet.  
 $x = 100L_s - [(0.000762a^2)(L_s)^5 + (0.0000000027a^4)(L_s)^9]$  (See Note 1)
- $x'$  Distance along semi-tangent of a spiral curve from  $TS$  (or  $ST$ ) to perpendicular offset to any point on spiral in feet.  
 $x' = 100L_s' - [(0.000762a^2)(L_s')^5 + (0.0000000027a^4)(L_s')^9]$   
(See Note 1)
- $y$  Offset distance from the semi-tangent to the  $SC$  (or  $CS$ ) measured perpendicular to the semi-tangent in feet.  
 $y = (0.291a)(L_s)^3 - (0.00000158a^3)(L_s)^7$  (See Note 1)
- $y'$  Offset distance from the semi-tangent to any point on the spiral measured perpendicular to the semi-tangent.  
 $y' = (0.291a)(L_s')^3 - (0.00000158a^3)(L_s')^7$   
(See Note 1)

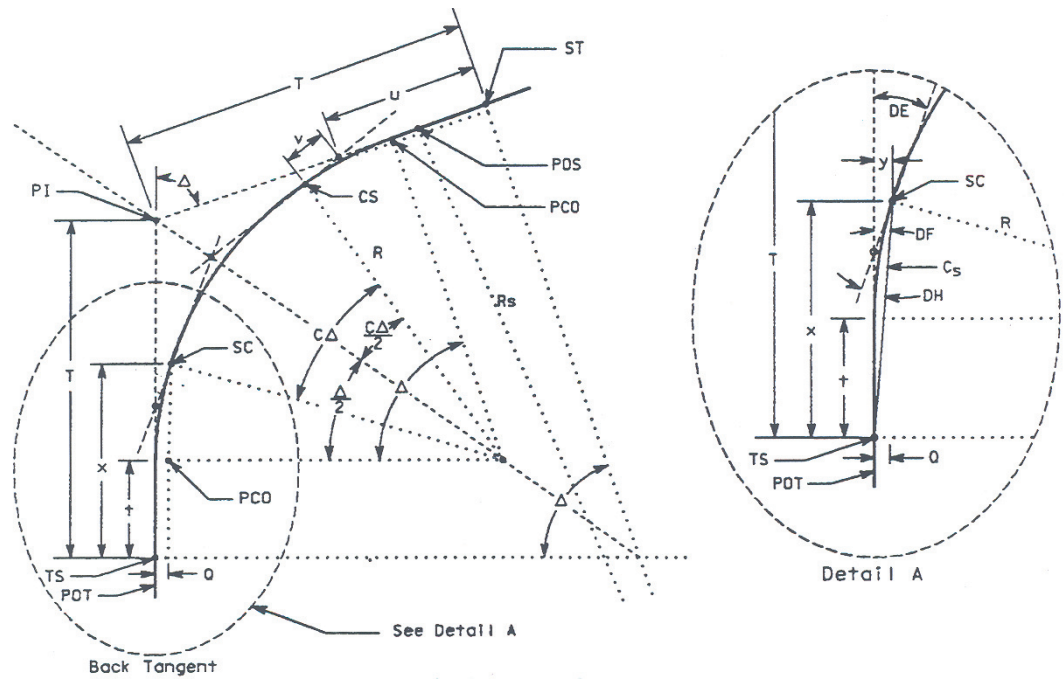

**Spiral Curve Elements**  
*Figure 11-4*

SPIRAL TABLES  $a = 1\frac{2}{3}$ —Continued

1" in 60 ft.

| Stations | Ds<br>Degrees and<br>Minutes | de<br>Deg. & Min. | df<br>Deg. & Min. | Q<br>Feet | R + Q<br>Feet | t<br>Feet | x<br>Feet | y<br>Feet | Cs'<br>Feet |
|----------|------------------------------|-------------------|-------------------|-----------|---------------|-----------|-----------|-----------|-------------|
| 3.1      | 5°-10'                       | 8°-00.50'         | 2°-40.1394'       | 3.607     | 1112.839      | 154.900   | 309.398   | 14.428    | 309.731     |
| 3.2      | 5°-20'                       | 8°-32.00'         | 2°-50.6337'       | 3.987     | 1078.342      | 159.882   | 319.289   | 15.867    | 319.685     |
| 3.3      | 5°-30'                       | 9°-04.50'         | 3°-01.4604'       | 4.350     | 1046.168      | 164.882   | 329.170   | 17.306    | 329.633     |
| 3.4      | 5°-40'                       | 9°-38.00'         | 3°-12.6193'       | 4.757     | 1015.933      | 169.840   | 339.037   | 19.024    | 339.579     |
| 3.5      | 5°-50'                       | 10°-12.50'        | 3°-24.1102'       | 5.189     | 987.474       | 174.815   | 348.886   | 20.747    | 349.507     |
| 3.6      | 6°-00'                       | 10°-48.00'        | 3°-35.8332'       | 5.645     | 960.645       | 179.781   | 358.718   | 22.570    | 359.432     |
| 3.7      | 6°-10'                       | 11°-24.50'        | 3°-48.0879'       | 6.128     | 935.317       | 184.756   | 368.529   | 24.497    | 369.349     |
| 3.8      | 6°-20'                       | 12°-02.00'        | 4°-00.5744'       | 6.638     | 911.374       | 189.721   | 378.319   | 26.529    | 379.256     |
| 3.9      | 6°-30'                       | 12°-40.50'        | 4°-13.3921'       | 7.174     | 888.712       | 194.682   | 388.085   | 28.689    | 389.153     |
| 4.0      | 6°-40'                       | 13°-20.00'        | 4°-26.5410'       | 7.739     | 867.239       | 199.630   | 397.827   | 30.920    | 399.039     |
| 4.1      | 6°-50'                       | 14°-00.50'        | 4°-40.0209'       | 8.332     | 846.868       | 204.592   | 407.540   | 33.284    | 408.912     |
| 4.2      | 7°-00'                       | 14°-42.00'        | 4°-53.8316'       | 8.955     | 827.526       | 209.539   | 417.225   | 35.764    | 418.773     |
| 4.3      | 7°-10'                       | 15°-24.50'        | 5°-07.9728'       | 9.608     | 809.142       | 214.482   | 426.877   | 38.362    | 428.620     |
| 4.4      | 7°-20'                       | 16°-08.00'        | 5°-22.4440'       | 10.291    | 791.654       | 219.419   | 436.496   | 41.080    | 438.452     |
| 4.5      | 7°-30'                       | 16°-52.50'        | 5°-37.2453'       | 11.006    | 775.006       | 224.350   | 446.078   | 43.922    | 448.287     |
| 4.6      | 7°-40'                       | 17°-38.00'        | 5°-52.3760'       | 11.753    | 759.144       | 229.274   | 455.621   | 46.889    | 458.066     |
| 4.7      | 7°-50'                       | 18°-24.50'        | 6°-07.8361'       | 12.532    | 744.021       | 234.191   | 465.122   | 49.983    | 467.847     |
| 4.8      | 8°-00'                       | 19°-12.00'        | 6°-23.6249'       | 13.345    | 729.595       | 239.102   | 474.578   | 53.207    | 477.608     |
| 4.9      | 8°-10'                       | 20°-00.50'        | 6°-39.7421'       | 14.192    | 715.824       | 244.004   | 483.987   | 56.563    | 487.348     |
| 5.0      | 8°-20'                       | 20°-50.00'        | 6°-56.1874'       | 15.073    | 702.673       | 248.898   | 493.344   | 60.053    | 497.066     |
| 5.1      | 8°-30'                       | 21°-40.50'        | 7°-12.9603'       | 15.989    | 690.106       | 253.783   | 502.648   | 63.679    | 506.761     |
| 5.2      | 8°-40'                       | 22°-32.00'        | 7°-30.0603'       | 16.941    | 678.094       | 258.659   | 511.894   | 67.442    | 516.430     |
| 5.3      | 8°-50'                       | 23°-24.50'        | 7°-47.4988'       | 17.930    | 666.609       | 263.525   | 521.079   | 71.346    | 526.074     |
| 5.4      | 9°-00'                       | 24°-18.00'        | 8°-05.8295'       | 18.955    | 655.621       | 268.381   | 530.199   | 75.391    | 535.689     |
| 5.5      | 9°-10'                       | 25°-12.50'        | 8°-23.3176'       | 20.018    | 645.108       | 273.225   | 539.251   | 79.578    | 545.275     |
| 5.6      | 9°-20'                       | 26°-08.00'        | 8°-41.7208'       | 21.118    | 635.046       | 278.058   | 548.220   | 83.911    | 554.829     |
| 5.7      | 9°-30'                       | 27°-04.50'        | 9°-00.4481'       | 22.258    | 625.415       | 282.878   | 557.131   | 88.389    | 564.351     |
| 5.8      | 9°-40'                       | 28°-02.00'        | 9°-19.4990'       | 23.429    | 616.194       | 287.685   | 565.952   | 93.015    | 573.828     |
| 5.9      | 9°-50'                       | 29°-00.50'        | 9°-38.8729'       | 24.654    | 607.285       | 292.478   | 574.686   | 97.789    | 583.288     |
| 6.0      | 10°-00'                      | 30°-00.00'        | 9°-58.5690'       | 25.912    | 598.812       | 297.257   | 583.330   | 102.713   | 592.699     |

Sample Spiral Table

Figure 11-5

Note 1

The last term in the equation may be omitted when the value of DE is 15° or less.

An example of a circular curve with equal spirals is calculated.

Given:

$$\Delta = 100^\circ 00'$$

$$PI = \text{Station } 120 + 10.54$$

$$D = 6^\circ 00'$$

$$L_s = 3.6 \text{ Stations}$$

Determine the information necessary to establish the control points for the curve.

First, determine a, the rate of change in the degree of curvature of the spiral per 100 ft of curve.

$$a = D/L_s$$

$$= 6^\circ / 3.6$$

$$= 1\frac{2}{3} \text{ degrees/station}$$

Now the spiral tables can be used to find information used to establish the control points for the curve.

From the *Field Tables for Engineers, Spirals 1984*, page 57, ( $a=1\frac{2}{3}$ ) the following information is found.

$$de = 10^{\circ} 48' \quad t = 179.787'$$

$$df = 3^{\circ} 36' \quad x = 358.718'$$

$$Q = 5.645' \quad y = 22.570'$$

$$R + Q = 960.645' \quad C_s = 359.432'$$

Or, if spiral tables are not available, the calculations go as follows.

First the angles DE, DF, DH and  $C\Delta$  are calculated.

$$DE = DL_s/2$$

$$= (6)(3.6)/2$$

$$= 10.8^{\circ}$$

$$= 10^{\circ} 48'$$

$$DF = DE/3 - DF_k$$

$$(DF_k = 0 \text{ because } D < 15^{\circ})$$

$$= (10^{\circ} 48')/3 - 0$$

$$= 3^{\circ} 36'$$

$$DH = DE - DF$$

$$= 10^{\circ} 48' - 3^{\circ} 36'$$

$$= 7^{\circ} 12'$$

$$C\Delta = \Delta - 2DE$$

$$= 100^{\circ} - (2)(10^{\circ} 48')$$

$$= 78^{\circ} 24'$$

Once  $C\Delta$  is known, the length of the circular curve can be found.

$$L = C\Delta / D$$

$$= (78^{\circ} 24')/6$$

$$= 13.0667 \text{ stations}$$

The radius for the circular curve is calculated using the formula in Field Tables for Engineers Spirals 1984, page 8.

$$R = 5730/D$$

$$= 5730/6$$

$$= 955.0'$$

## Geometrics

To find the stations, first calculate T. Since  $T = t + (R + Q) \tan D/2$ , it is necessary to first find Q and t.

$$\begin{aligned} Q &= (0.0727a)(L_s)^3 \\ &= (0.0727)(5/3)(3.6)^3 \\ &= 5.6532' \end{aligned}$$

$$\begin{aligned} t &= 50L_s - (0.000127a^2)(L_s)^5 \\ &= 50(3.6) - (0.000127)(1\ 2/3)^2(3.6)^5 \\ &= 180 - 0.2133 \\ &= 179.7867' \end{aligned}$$

Now find T.

$$\begin{aligned} T &= t + (R + Q)\tan \Delta/2 \\ &= 179.7867 + (955 + 5.6532)\tan 100/2 \\ &= 1324.65' \end{aligned}$$

Stationing can now be determined for the control points.

$$PI = \text{station } 120 + 10.54 \text{ is given}$$

$$\begin{aligned} TS &= PI - T \\ &= 12010.54 - 1324.65 \\ &= \text{station } 106 + 85.89 \end{aligned}$$

$$\begin{aligned} SC &= TS + (L_s \times 100) \\ &= 106 + 85.89 + 360 \\ &= \text{station } 110 + 45.89 \end{aligned}$$

$$\begin{aligned} CS &= SC + (L \times 100) \\ &= 110 + 45.89 + 1306.67 \\ &= \text{station } 123 + 52.56 \end{aligned}$$

$$\begin{aligned} ST &= S + (L_s \times 100) \\ &= 360 \\ &= \text{station } 127 + 12.56 \end{aligned}$$

## Spiral Deflections

For the deflections the spirals are divided into equal arcs. In the example above, where  $L_s = 360'$ , the spirals may be divided into nine equal arcs of 40 feet each. (A railroad would have used chords.) A curve with equal spirals uses the same arcs and deflections at either end.

Since the deflection varies as the square of the distance ( $L_s'$ ), the deflection angle  $df = a(L_s')^2/6$  in degrees or  $10a(L_s')^2$  in minutes at any point on the spiral. The rate of change of curvature was calculated first and is  $1\ 2/3$  or, to calculate more simply,  $a = 5/3$ .

The deflections for the previous example are, therefore:

| Station      | Deflection  |
|--------------|---|
| 106+85.89 TS | $0^\circ$   |
| 107+25.89    | $(5/3)(0.4)^2/6 = 0.044^\circ = 0^\circ\ 02'\ 40''$ |
| 107+65.89    | $(5/3)(0.8)^2/6 = 0.177^\circ = 0^\circ\ 10'\ 40''$ |
| 108+05.89    | $(5/3)(1.2)^2/6 = 0.399^\circ = 0^\circ\ 24'\ 00''$ |

This process is continued until the S.C. is reached at station 110+45.89 where  $L_s'$  is 3.6. The deflections are the same for the spiral at the other end of the curve. The circular curve is run in the same manner as a circular curve without spirals on either end.

For further information concerning spiral curves consult the *Field Tables for Engineers, Spirals 1984*.

### Field Procedures

One method for running a spiral is by occupying the TS (or ST). Set zero in the instrument and backsight a point on tangent or foresight a point on semi-tangent. Turn the calculated deflection and chain from station to station along the spiral.

Another method is to set out coordinate values for selected stations calculated with coordinate geometry software.

### Offset Curves

It may be necessary to locate outer or inner concentric curves such as lane edges and offset curves for reference during construction. Spiral curve data can be calculated using the offset width ( $w$ ) and the deflection angles for the segment: one measured from the forward tangent to the  $POS_1$  at the beginning of the segment ( $df_1$ ), and the other measured to the  $POS_2$  at the end of the segment ( $df_2$ ).

To sight along a line tangent to the spiral at any point ( $POS_2$ ) on a spiral:

1. Occupy the TS.
2. Sight an intermediate point ( $POS_1$ ) for the deflection angle  $df_1$ .
3. Sight  $POS_2$  for angle  $df_2$ .
4. Occupy  $POS_2$  and sight  $POS_1$ .
5. Turn an angle  $= 2(df_2 - df_1)$  away from the TS to sight the tangent.

To sight radially at  $POS_2$  follow steps 1 through 4 above and then turn  $90^\circ$  in either direction.

The length of a spiral curve segment of an offset curve is the center line segment plus (outside) or minus (inside curve) the amount  $3[\sin(df_2 - df_1)]w$ .

See Circular Curves.

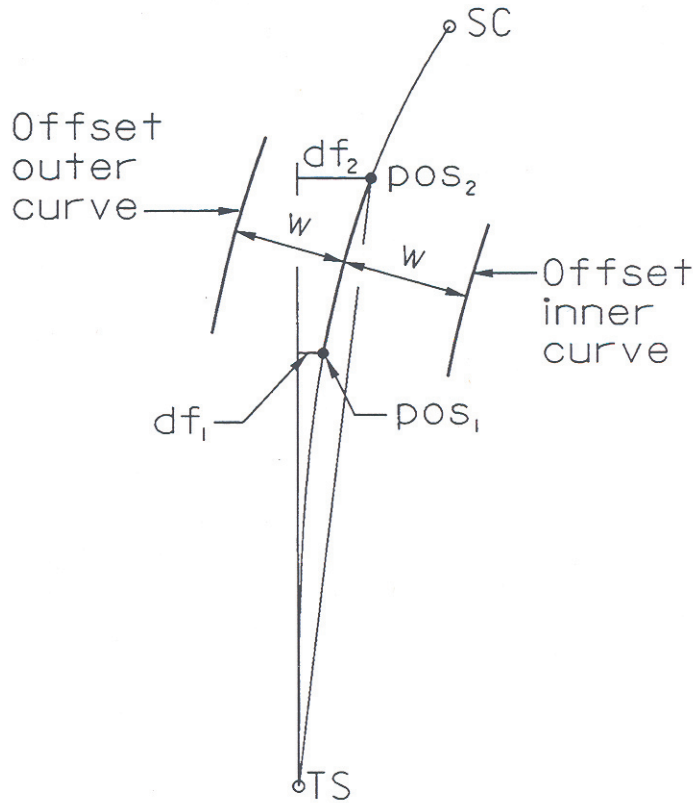

Figure 11-6

## Vertical Alignment and Superelevation

### Profile Grade

Grade is the rate of change in vertical elevation per unit of horizontal length. This rate is expressed in percent. For example, a 1 percent grade means a rise or fall of 1 foot in 100 feet of horizontal distance (rise over run).

To determine the grade between two points on a line, divide the difference in elevation in feet by the distance between the two points in stations (1 station = 100 feet) and multiply by 100 so the result will be in percent.

Example (metric)

| Station | Elevation |
|---------|-----------|
| 193+60  | 16.00     |
| 211+75  | 80.61     |

distance 18.15 m difference in elevation 64.61 m

The grade is then  $+64.61/18.15 = +3.56\%$

Since the elevation ahead on line is higher than the elevation of the beginning station it is a plus grade. If the ahead elevation were lower, it would be a minus grade.

This **profile grade** describes the vertical alignment of the roadway and is shown on the profile sheets of the contract plans.



A finished roadway is not a flat plane. Instead, the roadway is sloped slightly to the sides to allow water to run off.

This requires that a definite point on the cross section be chosen to “carry” the grade. The lateral location of profile grade is shown in the roadway sections portion of the contract plans.

On construction, it is important to study the profile sheets and roadway sections and know where every change in the profile grade occurs. Serious staking errors can be made in the field by overlooking a lateral shift in the location of the profile grade.

### Vertical Curves

When a change in grade of more than about 0.5 percent occurs at a VPI, a vertical curve is required. The vertical curve lengths are determined by criteria found in the *Design Manual*. Once the grades are established and the lengths of the curves are chosen, the vertical offsets of the curves can be computed. A vertical curve is a parabolic curve. When the grades form a peak or hill at the VPI, the curve is known as a **crest vertical** or **summit vertical** (Figure 11-7). When the grades form a valley or dip at the VPI the curve is known as a **sag vertical** (Figure 11-8).

When  $l_1$  does not equal  $l_2$  as shown in Figure 11-9 the curve is nonsymmetrical.

The vertical curve is computed by figuring offsets from the tangent grades. Subtract the offsets from the tangent grade elevations for crest verticals and add the offsets to the tangent grade elevations for sag verticals.

The following nomenclature and formulas are from the *Highway Engineering Field Formulas*, M 22-24.

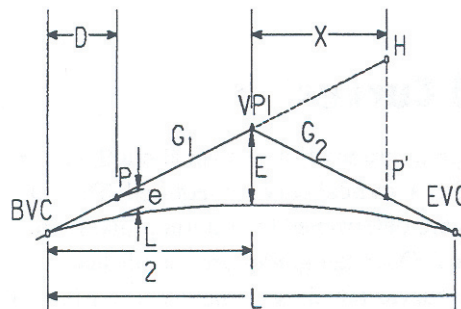

**Crest Vertical Curve**  
Figure 11-7

**Equations for Crest Vertical Curve**

$$e = \frac{AD^2}{200L}$$

$$L_1 = \frac{2(AX + 200e + 20\sqrt{AXe + 100e^2})}{A}$$

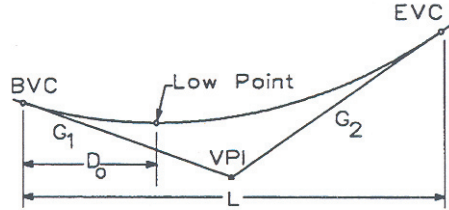

**Sag Vertical Curve**

Figure 11-8

**Equations for Sag Vertical Curve**

$$E = \frac{AL}{800}$$

$$E = \frac{1}{2} \left( \frac{\text{Elev. BVC} + \text{Elev. EVC}}{2} - \text{Elev. VPI} \right)$$

$$e = \frac{4ED^2}{L^2}$$

Notes: All equations use units of length (not stations or increments)

The variable A is expressed as an absolute in (%) percent

Example: If G<sub>1</sub> = +4% and G<sub>2</sub> = -2%  
Then A=6

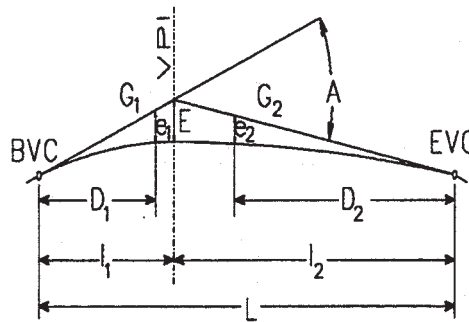

**Nonsymmetrical Vertical Curve**

Figure 11-9

**Equations for Nonsymmetrical Vertical Curve**

$$A = |(G_2) - (G_1)|$$

$$L = l_1 + l_2$$

$$E = \frac{l_1 l_2}{200(l_1 + l_2)} A$$

$$e_1 = m \left\{ \frac{D_1}{l_1} \right\}^2$$

$$e_2 = m \left\{ \frac{D_2}{l_2} \right\}^2$$

**Superelevation**

On horizontal curves, the roadway is tilted so that the edge of the pavement at the outside of the curve is higher than the edge of the pavement at the inside of the curve. This is called **superelevation** and is done to counteract the centrifugal force, which tends to push the vehicle off the roadway at the outside of the curve.

The rate of superelevation is a function of the radius of the curve and the design speed. As the radius shortens for a given design speed or as the design speed increases for a given radius, the **super rate** must increase to keep the vehicle on the road. The maximum super rate is 0.10 ft/ft. For further information see Chapter 642 of the *Design Manual*.

Going from a tangent section, which has a **normal crown** to a curve section, which has **full super**, there is a gradual change in the rate of superelevation called a **transition**.

Approximately three fourths of the transition is in the tangent section of the roadway and one fourth is in the curve. See the *Design Manual* for superelevation transition designs. The edge of the pavement that is on the outside of the curve begins to rise in relation to the center line (or reference point). The edge rises until the roadway is on one (sloping) plane from edge to edge. This is called **crown slope** and is usually 0.02 ft/ft. The entire roadway then rotates about the **pivot point** until it reaches its maximum or **full super**. Exiting a curve, the process is simply reversed, going from full super to crown slope to normal crown. See Figure 11-10.

The survey crew should not have to design supers but may have to compute grades for a station or offset on a section in transition. The contract plans will contain superelevation diagrams on the same sheet as the roadway profiles.

Figure 11-11 shows a super diagram for the roadway shown in Figure 11-10.

The contract plans and/or the roadway elevation listing (grade sheets) show the stations of the beginning of the transition, crown slope, and full super.

To find the super rate for any station in a transition:

1. Subtract the begin transition station from the end transition station.
2. Subtract the desired station from the end transition station.
3. Subtract, algebraically, the crown slope from the full super rate.

**Geometrics**

4. Divide the super difference (#3) by the station difference (#1).
5. Multiply the desired station difference (#2) by the rate of change (#4).
6. Subtract #5 from the full super rate which gives the super rate for the station in question.

**Example**

Find the super rate at station 17+50 on the right edge of the pavement using Figure 11-11.

1.  $18+20.68 - 16+04.68 = 216$  ft
2.  $18+20.68 - 17+50 = 70.68$  ft
3.  $0.06 - (-0.02) = 0.08$  ft/ft
4.  $0.08/216 = 0.000370370$  ft/ft/ft = rate of change
5.  $0.000370370 \times 70.68 = 0.02618$  ft/ft
6.  $0.06 - 0.02618 = 0.03382$  ft/ft

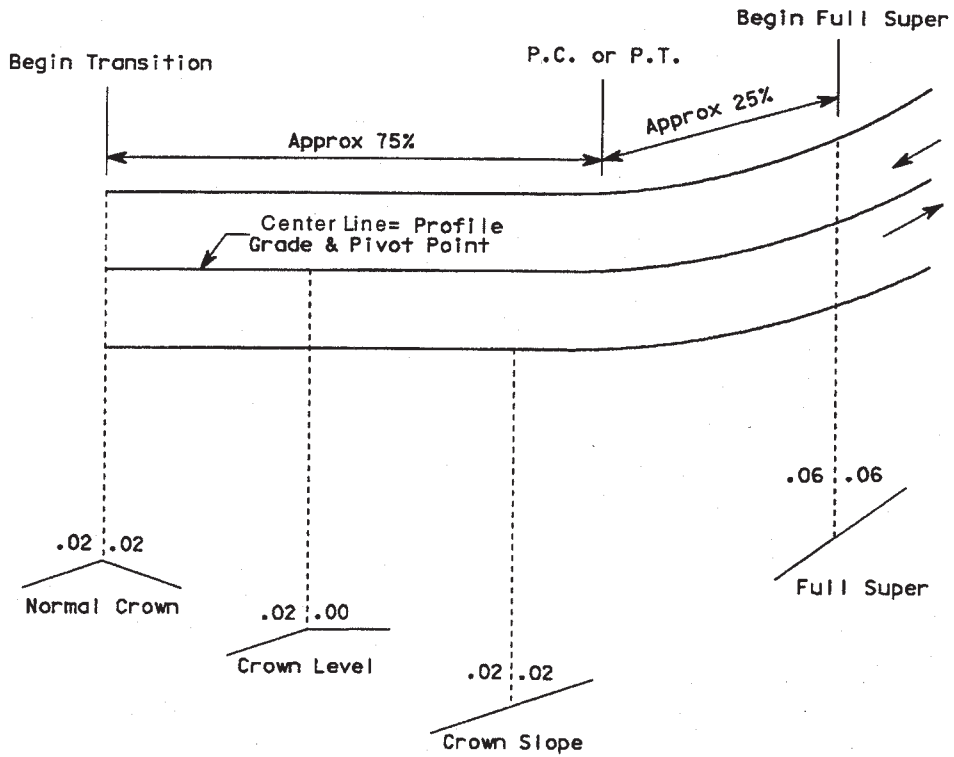

**Superelevation for Two-Lane Highway**  
*Figure 11-10*

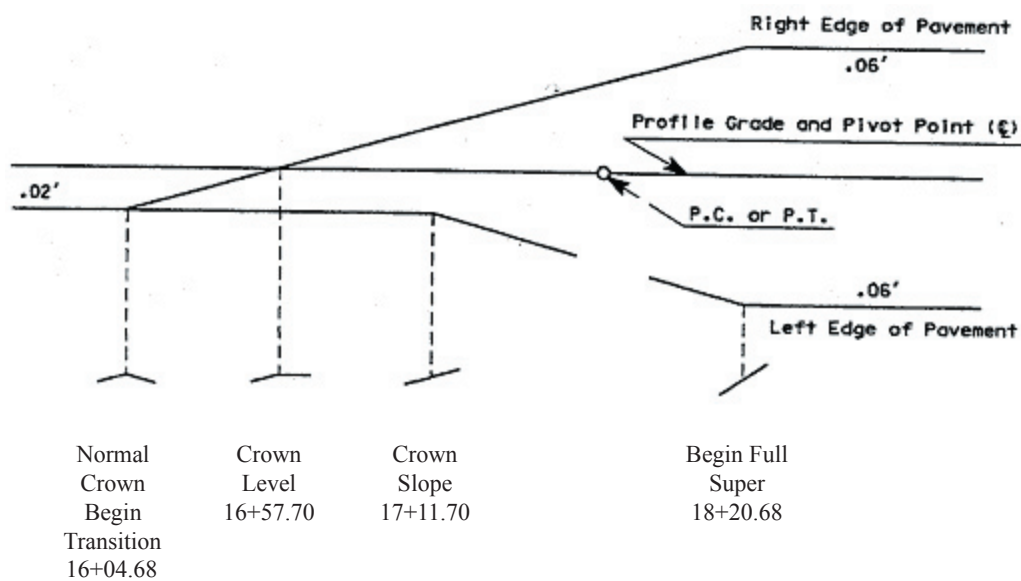

**Superelevation Diagram for Two-Lane Highway**  
*Figure 11-11*



### 12-01 General

Contact Headquarters Geographic Services for your mapping needs. They have a staff of mapping specialists, engineers and on-call consultants to make sure you get the right mapping products and geographic information for your project.

Photogrammetric surveys are used for reconnaissance, location design, PS&E, and construction projects. They are used for mapping, digital terrain modeling, cross sectioning, and alignment determination. If a project will take more than 4-5 field crew days or there is a safety concern, using photogrammetry will be to your advantage.

If you are contemplating a project, contact the Photogrammetry Branch early to get them on your project delivery team.

The telephone number is (360) 709-5541

Please take time to visit the Photogrammetry website at <http://wwwi.wsdot.wa.gov/PPSC/Photogrammetry/Default.htm>

### 12-02 Glossary

The mapping sciences are based on technology that is advancing and changing rapidly. Please see the Photogrammetry website for current terminology, information, education, and assistance on remote sensing and mapping.

<http://wwwi.wsdot.wa.gov/PPSC/Photogrammetry/Default.htm>

### 12-03 Mapping

When you need mapping, photogrammetric surveys are quick, safe, and economical. Photogrammetric mapping should be requested from the WSDOT Photogrammetry Branch whenever savings in time and/or manpower can be realized, when safety of field surveyors cannot be assured, or when lane closures for mapping would significantly impair traffic flows.

The Photogrammetry Section treats each project as a custom job so that you will get what you need to deliver your project. The nature of the topography, the amount and types of land cover / land use, and your specific needs for coverage and accuracy are some of the factors that the Photogrammetrist considers when designing your mapping job. When you contact the Photogrammetrist, you make a valuable addition to your Project Delivery Team. The Photogrammetrist will meet with you to determine the best way to approach your mapping requirements.

Since design is all computerized now, mapping is done that way too.

Features are recorded in three dimensions (x, y, and z coordinates) and topography is described by using breaklines (to describe a change of slope) and mass points. This data, together with selected 3D planimetric features, are used to make digital terrain models (DTMs), digital elevation models (DEMs), or other engineering products.

**12-03.1 Reconnaissance**

Reconnaissance mapping should be used where, in the opinion of the engineer, adequate information is unavailable and lack of current data may affect the proper development of a reconnaissance survey.

Photos of 1:24000 scale are commonly used in areas of sparse land use, where the character of the topography is mountainous, where heavily timbered areas restrict more accurate photogrammetric determination of topography, or where it is known in advance that developed areas will not be appreciably altered by proposed routes.

Photos of 1:12000 scale are commonly used in areas of moderate to intense land use, especially in urban areas. Consider this scale where the topography is slightly rolling or nearly level, and more accurate delineation of detail would be necessary.

The existing geodetic control is used, and additional ground control is usually necessary as well.

**12-03.2 Location Design**

Location design mapping is performed to furnish the engineer sufficient data to produce the best location for the highway and to aid in the preparation of detailed right of way plans. The aerial photography obtained at this stage will provide a record of conditions prior to construction.

Design mapping is a detailed and accurate survey of the important factors that affect the position, physical characteristics, and geometric design of the highway route.

A flight scale of 1:3000 is usually best for this need. When topographic design mapping is specified and the map sheets are also to be used as right of way or construction plans, the CADD system allows the user to eliminate details not needed on a particular plan sheet or exhibit.

For bridge site maps, refer to the *Design Manual* Chapter 11.10 for the appropriate map scale.

Horizontal and vertical mapping accuracy is directly proportional to the scale of the photograph. The number and placement of photo control points also affect photogrammetric mapping accuracy. Weather conditions at the time of flight and the season of the year have significant effects as well, since sun illumination angle and atmospheric factors affect the quality of the photo image. In areas where the ground is obscured by timber or other dense vegetation, photogrammetric design mapping cannot ordinarily be accomplished to the degree of accuracy required. Approximate ground form lines can be determined. Use field surveys to get the precise data needed to supplement the approximate contours. It is advised to contact the WSDOT Aerial Photogrammetry Department during the planning phase of your project to coincide Photogrammetry accuracy to project needs.

If you need preliminary cross section data and there is a safety problem, a centerline may be developed photogrammetrically from the existing painted stripes.

**12-03.3 PS&E**

Photo scale of 1:3000 or larger is needed in order to get data accurate enough to be used for construction quantities.



Photogrammetrically generated data are especially beneficial in areas of rough terrain or where heavy traffic could be a problem for field crews. However, some fieldwork may be necessary for data points not visible in the photos. In areas of heavy vegetation, photography should also be obtained after clearing and grubbing.

Controlled aerial photos can be used to update plans for existing conditions (as-builts). The photography taken at this stage will be particularly valuable if questions or disputes should arise after construction because it will show the conditions prior to any construction work.

The digital terrain model is used primarily for road design, but contours may also be generated by using CADD or GIS software.

## **12-04 Photography**

Aerial photography with proper ground control is the basis of a photogrammetric survey. Skilled photogrammetrists use very specialized analytical Digital Photogrammetric Workstations (DPWs) to interpret and make precise measurements of the aerial imagery. The data are recorded in 3D files using WSDOT level playing field (LPF) CAD software.

Aerial photos for mapping or orthophotos should be taken between mid-March and mid-September for best results. The Photogrammetrist on your managing project delivery (MPD) team can explain the many factors to consider in getting photos done at the right time.

Aerial photography and those products derived from it also have extensive use as a visual communication tool for planning, property acquisition, engineering, construction, litigation, and public relations.

### **12-04.1 Aerial Photograph Section**

The Aerial Photography Section uses a special aerial mapping camera to take very precise, high-resolution images on 9 x 9 inch film. The photo lab unit can provide uncontrolled digital image files or hard copy products from the film negatives. Uncontrolled imagery should not be used for measurements.

### **12-04.2 Aerial Photography**

The aerial camera has a variety of lenses and filters for capturing images for different purposes. Vertical aerial photography for mapping can be taken at scales from 1:1200 to 1:64000, and oblique photography from 1,000 feet to 30,000 feet above sea level. Photos can be grayscale, color, or color infrared.

Photo scale is like map scale. On a large-scale photo, objects appear large. On a small-scale photo, objects appear small, but more area is shown. Photo scale is a function of flying height and camera lens focal length.

### **12-04.3 Print Mosaicking, Mounting, and Framing**

Enlargements and special display mounting, framing, and laminating are available as well.

## **Photogrammetry**

### **12-04.4 Placing An Order**

Use the Aerial Photography and Lab Service Request form (DOT 350-148) or the Photogrammetry request form (DOT 274-015A). The forms are available electronically or in hard copy. Mail routine requests to the following address:

WSDOT Geographic Services  
PO Box 47384  
1655 South Second Avenue  
Tumwater, WA 98504-7384

Send urgent requests by email, or Fax 360 709 5599.

### **12-05 Field Surveys**

Survey telephone (360) 709-5530.

Ground control for photogrammetric surveys is different for every project. The Photogrammetry and Geodetic Survey sections will design the specifications and set the parameters for ground control on your project.

Assistance in placing control points, methods of placement, training of personnel, location of known points, accuracies required, and any other help needed to assure a quality product are available from the Geographic Services Office.

Coordinates and elevations for WSDOT mapping must fit in the departmental GIS database along with hundreds of other data layers. Therefore, mapping work is done in State Plane Coordinates, North or South zone, depending on location. The horizontal datum must be NAD83/91, the vertical datum NAVD88, and units of measure US Survey feet. A new datum adjustment is expected in 2003 or 2004 and will become the new standard when adopted by the agency Survey Committee. Most of the state is now covered by a high accuracy reference network (HARN) of monuments. The Geographic Services website has links to the monument database.

#### **12-05.1 Premarking**

Contact the Photogrammetry Section for a ground control layout designed for your specific project. The proper placement of photo targets prior to aerial photography improves map accuracy. The overall distribution of points and the specific location of each point must be determined by a Photogrammetrist in order to get the optimum accuracy/cost balance for your mapping project.

The size, shape, spacing, and material used for premarks are determined by the photography scale, film type, weather conditions, season, and type of terrain on which the targets will be placed.

#### **12-05.2 Establishing Control Photogrammetrically**

In many instances, it is impossible for field crews engaged in establishing control surveys to reach certain areas due to topography or accessibility. To overcome these situations, equipment is now available to assist the field engineer in obtaining additional control data.

By using a digital photogrammetric workstation (DPW), horizontal and vertical positions of desired points (preferably premarked) can be measured from controlled aerial photos. This method is particularly useful in determining the positions of section corners, property lines, property corners, or any other existing features, which are identifiable on the photograph.

Another useful feature of this method is the establishing of horizontal and vertical positions of premarked control points or other identifiable features, which may surround an area of heavy vegetation. These can then be used by the engineer to accomplish field completion in areas not covered by the photogrammetric mapping.

## **12-06 Programming**

This can be summarized in two words. “order early.” The best time to contact the Photogrammetry Branch is during scoping. Include mapping, photographic products, and control in the initial programming of a project to insure that you get a schedule and budget that works. Ask a Photogrammetrist to participate on your project delivery team to provide estimates and technical advice on mapping.

### **12-06.1 Mapping**

Some of the first things you need to know when you establish a mapping schedule are: map accuracy requirements, length of project, mapping widths, type and scale of mapping, priority areas, and the latest date delivery can be accepted.

### **12-06.2 Photographic Products**

Aerial photos are useful for many purposes, but the photo flight mission for “just plain pictures” is very different from the mission to obtain photos for mapping or orthophotos (true scale photos). Your photogrammetrist team member will keep you advised on these important matters.

### **12-06.3 Field Surveys**

Do your programming for geodetic or control surveys during your project scoping.

When you request a control survey, send a sketch (diagram) of the proposed work to the Photogrammetry Branch. This plan should indicate the known existing control stations, proposed primary and supplemental control stations to be established, and tentative mapping limits. Information about existing monuments and necessary new ones should also be included.

## **12-07 Procedures for Ordering**

Send all requests for photography, mapping, and related items to the Geographic Services Office. Be aware that the department has an approved group of private on-call firms that are selected by the legally required qualification based system (QBS). These firms are supervised and overseen by the Geographic Services Branch. Your project team need not take on the extra work and responsibility of managing private mapping consultants on your own.

See section 12-04.4 above for forms information.



### 13-01 General

Control surveys establish a common, consistent network of physical points that are the basis for controlling the horizontal and vertical positions of transportation improvement projects and facilities. Corridor control surveys ensure that adjacent projects have compatible control. Project control surveys provide consistent and accurate horizontal and vertical control for all subsequent project surveys — photogrammetric, mapping, planning, design, construction, and right of way.

The following policies, standards, and procedures are applicable to all control surveys for WSDOT involved transportation improvement projects. This includes surveys performed by WSDOT survey staff, WSDOT consultants, local agencies, private developers and others.

In 1991, WSDOT in cooperation with the National Geodetic Survey (NGS) and others, established a Washington high precision geodetic network to meet the following needs:

- Global Positioning System (GPS) survey methods.
- Today's multiorganizational transportation project development efforts.
- Surveys required to accurately locate transportation improvements and rights of way.
- Geographic Information Systems (GIS).

This network is called the Washington High-Precision Geodetic Network (HPGN). In other states, similar networks are often referred to as High-Accuracy Reference Networks (HARN).

The HPGN established 238 Order B (relative position accuracy of 0.8 centimeter plus one part in a million) horizontal control stations along transportation corridors throughout Washington using GPS survey methods. The stations are spaced about 64 kilometers apart on a grid-like network and form the basis for all WSDOT control surveys. Subsequently, corridor control surveys have been undertaken to establish a densified network (HPGN-D) of corridor control with stations spaced about 16 kilometers apart along State highways.

### 13-02 Policy

Horizontal corridor control surveys shall be performed along transportation corridors where multiple improvement projects are planned.

Horizontal project control surveys shall be performed for all WSDOT involved transportation improvement projects using Washington Coordinate System coordinates to define the geographic positions of project facilities.

Vertical project control surveys shall be performed for each WSDOT involved transportation improvement project that requires elevations to define the positions of fixed works.

## **Control Survey Procedures**

Horizontal project and corridor control surveys should be based on (tied and adjusted to) three or more HPGN or HPGN-D stations. If a Horizontal Project Control Survey network “tie” to the nearest HPGN station or HPGN-D station exceeds 20 kilometers, establishment of additional HPGN-D station(s) shall be considered. See Section 4.1, “Horizontal Datum” and 13-05.2, “Horizontal Corridor Control (HPGN-D) Surveys.”

When feasible, horizontal project control shall be established using GPS surveys complying with WSDOT first-order accuracy standard. When GPS survey methods cannot be used for all or part of a Horizontal Project Control Survey, a Total Station Survey System (TSSS) traverse network meeting the WSDOT second-order accuracy standard is acceptable. See Section 5, “Classifications and Accuracy Standards.”

Vertical project control surveys shall be based on a single, common vertical datum to ensure that various phases of a project and contiguous projects are consistent. The preferred vertical datum for WSDOT involved improvement projects is the North American Vertical Datum of 1988 (NAVD88). See Section 4.2, “Vertical Datum,” for a description of NAVD88 and exceptions to its use. All vertical project control survey work will be done to at least the WSDOT third-order survey accuracy standard. See Section 5, “Classification and Accuracy Standards.”

### **13-03 Planning and Research**

#### **13-03.1 Responsibility**

The planning and design phases of the project development process require appropriate mapping and field surveys. Project control surveys provide the basis and framework for base maps and digital terrain models used in the development of contract plans and acquisition of right of way. As soon as a project requiring Surveys involvement is known, e.g., appears on the “Status of Projects” report or an initial survey request is received, a Project Surveyor should be appointed by the Region Surveys Engineer. The Project Surveyor should be an active participant on the Project Development Team to provide advice and input on survey related matters and issues, be responsible for initiating control surveys, and respond to project survey needs.

#### **13-03.2 Planning**

The Project Surveyor is responsible for planning and establishing the project control network. Project control surveys should be planned to provide convenient horizontal and vertical survey control for right of way engineering, photogrammetric mapping, engineering, construction, and monumentation surveys for the duration of the project. A work plan for establishing the project control should be developed after consulting the following individuals:

- Project Manager
- Project Engineer
- Region Survey Engineer
- Region Right of Way Engineer
- Region Photogrammetry Coordinator

Planning the control network so that it will meet the needs of all subsequent project surveys is critical. Key steps in the control planning process are to:

- Ascertain the need for additional corridor control
- Develop a survey work schedule that meets the needs of the Project Development schedule.

- Research the existing horizontal and vertical control networks.
- Recover and evaluate existing control.
- Decide on the vertical datum for the project (NAVD88 preferred).
- Plan the project control network and select the methods for establishing control.
- Plan supplemental control.

If possible, project control should be planned so that project control monuments serve for both horizontal and vertical control. It is important that project control plans consider the need for supplemental control.

### **13-03.3 Research**

The Project Surveyor will conduct a thorough search of WSDOT records to determine the availability of existing control in the project area. Every attempt should be made to use existing WSDOT control in the area. A computer program for conversions should never be used to convert NAD27 horizontal control to the NAD83 datum. New coordinate values, based on the HPGN, should be determined for existing control using field observations and network adjustments. See Section 4.3-3, "Coordinate Conversion." All horizontal control, including conversions of existing control, should be based on the HPGN. Another source of control information is the NGS.

For vertical control, research may be expanded beyond WSDOT surveys files and NGS to include other State, Federal, County and local agencies.

### **13-04 Office Preparation**

The Project Surveyor, in consultation with the field supervisor and party chief, is responsible for the development of the necessary instructions and information (field package) for performing required control surveys. Surveys office staff, under the direction of the Project Surveyor, generally prepare a field package using information obtained from research, together with other compiled and computed data. Field packages should contain all the necessary information and data to efficiently complete the field work required for establishment of control networks. Typical information to include in the field package is:

- Expenditure authorization and time recording sheet information.
- Copy of the original survey request.
- Right of entry information, conditions, and permits.
- Criteria for selection of survey method.
- Predetermined positions of control monuments and anticipated project alignments.
- Copies of pertinent research materials (record of survey maps, parcel maps, tract maps, and subdivision maps).
- WSDOT right of way and monumentation maps.
- Existing aerial photographs.
- Station "to reach" information.
- Reference ties and related data for existing horizontal control monuments.
- Vertical control monument locations, descriptions, and elevations.

**13-05 Field Work**

**13-05.1 Reconnaissance**

Prior to initiating a Control Survey a thorough search and recovery of existing horizontal and vertical control monuments in the immediate area of the project is required. Also, a field reconnaissance will be required before final control net planning is accomplished and field work is begun. Recovered control monuments must be evaluated before being used as a basis for new control surveys. All recovered points should be fully described in the survey notes.

**13-05.2 Horizontal Corridor Control (HPGN-D) Surveys**

Corridor control surveys are undertaken to establish HPGN-D stations spaced along highway corridors approximately 16 kilometers apart. These control stations, together with the HPGN stations, are used as basic control for all of WSDOT surveying efforts. HPGN and HPGN-D stations, where established, have become the accepted horizontal control network for Washington surveyors, ensuring consistency between surveys performed by WSDOT and others.

Each Region/Region should develop a systematic plan for completing corridor control/ HPGN-D surveys. Region-wide or area-wide HPGN-D surveys are the preferred method for establishing corridor control. When large area densification surveys are planned, cooperative agreements for performing the work should be established with local agencies and private sector surveyors. This will ensure that the HPGN-D stations are accepted as the “best” control for the local surveying community.

When ties to HPGN stations, for purposes of establishing project control are longer than 20 kilometers, an HPGN-D station should be established in conjunction with project control. Exceptions to this policy shall be determined by the Region Surveys Engineer based on current and future project development needs and available resources.

**Method**

Corridor control surveys must be performed using GPS surveys. See Section 6, “Global Positioning System (GPS) Survey Specifications.”

Note: Survey procedures and documentation must conform to NGS specifications if survey results will be submitted to NGS for inclusion in the National Spatial Reference System (NSRS).

**Accuracy**

Surveys must be referenced and adjusted to HPGN stations and meet WSDOT first-order survey standards with a distance accuracy standard of 1:500,000. See Section 5, “Classification and Accuracy Standards” (See Figure 5-1, Note 10).

**Monumentation**

Monuments shall be located along transportation corridors in secure locations. The station site shall be selected with safety considerations for the surveyor and others given highest priority. Sites within or adjacent to the traveled way of limited access highways should be avoided. Monuments shall be accessible to the public, preferably in a public right of way or easement. Typical locations are:

- Along freeway ramps near the junction of the right of way for the ramp and the local street.
- Within county or city street right of way.



- Bridge abutments (if on piles).
- On public property or at public facilities (canals, parks, etc.).

Whenever possible select station locations that can be easily described. When several locations are equally satisfactory choose the one that is near features that will aid in future monument recovery.

Monuments shall be constructed to ensure permanency. Monument type shall be chosen to suit the local conditions. Acceptable monuments are as follows:

- NGS class B rod marks. See NOAA Manual NOS NGS 1, Geodetic Bench Marks.
- Existing NGS monuments in good condition and equal to or exceeding the permanency provided by class B rod marks.
- Other existing or new monuments, if they meet or exceed the permanency of class B rod marks and are approved by the Geometronics Branch.
- A disk epoxyed into a drilled hole in a large rock mass (large boulders are not acceptable).
- A disk epoxyed into a drilled hole in a concrete bridge abutment on piles (not on the bridge deck or an abutment fill) or other permanent and stable concrete structure.

If the survey results will be included in the NSRS, use monument disks specifically designed and manufactured for HPGN-D surveys stamped with the calendar year of the survey and the station identification. If another agency is the primary sponsor of the densification survey be sure that the disks used are stamped with the notation "HPGN-D."

### **13-05.3 Horizontal Project Control Surveys**

Horizontal project control surveys establish control for transportation improvement projects. All subsequent horizontal surveys for a project are based on the horizontal project control.

#### **Method**

Whenever feasible, horizontal project control shall be established using GPS survey methods. See Section 6, "Global Positioning System (GPS) Survey Specifications." When GPS survey methods cannot be used for all or part of a horizontal project control survey, the TSSS system can be used. See Section 9, "Total Station Survey System (TSSS) Survey Specifications."

Some horizontal project control surveys are hybrid projects with TSSS networks bracketed by GPS azimuth pairs at the beginning, end, and at intervals throughout the project.

#### **Accuracy**

Horizontal project control surveys must be referenced and adjusted to HPGN and/or HPGND stations. Preferred order of accuracy is WSDOT first-order survey standards with a distance accuracy standard of 1:100,000. WSDOT second-order accuracy standard (1:20,000) is acceptable when using the TSSS method.

#### **Monumentation**

- Establish sufficient monuments so that a minimum of three monuments exist for each project.

## **Control Survey Procedures**

- Set monuments as required by project conditions, generally no more than 800 meters apart. If longer spacing is used, establish monuments in pairs for intervisibility. Minimum, spacing for monuments is 150 meters (300 meters when using GPS).
- Locate monuments to minimize disturbance by construction and to be clear of traffic and accessible, preferably within a public right of way or easement.
- Preferably, locate monuments so they are intervisible with at least two other monuments.
- Establish durable, permanent monuments with WSDOT markings. The preferred monument is the Type “A” concrete monument with metal disk shown on Standard Plan A74. Other acceptable monuments are 50 mm galvanized steel pipe 750 mm long, with brass disk or plastic plug, 16 mm rebar, 750 mm long with cap, metal disk epoxyed in rock mass or bridge abutment, existing stable monuments, etc.

### **13-05.4 Vertical Project Control Surveys**

A vertical project control survey shall be performed for each specific WSDOT involved transportation improvement project that requires elevations to define topographic data points or positions of fixed works. The establishment of vertical project control monuments is important because all subsequent project surveys requiring elevations are to be based on the vertical project control.

When feasible, vertical control for projects should be established at all horizontal control stations. Additional benchmarks should be set to densify vertical control to provide convenient control for photogrammetry, topographic, and construction purposes.

#### **Method**

Vertical Project Control can be established using the following methods:

- Differential leveling, see Section 10, “Differential Leveling Survey Specifications.”
- Trigonometric leveling, see Section 9 “Total Station Survey System (TSSS) Survey Specifications.”
- GPS can be used to bring NAVD88 to a project. See Section 8-02.9, “Vertical GPS Surveys — Applications.”

#### **Accuracy**

Preferred accuracy standard is WSDOT second-order survey accuracy, although WSDOT third-order accuracy is acceptable. See Section 7, “Classifications and Accuracy Standards.”

#### **Monumentation**

- Monuments should be spaced as required by project conditions, generally no more than 500 meters apart.
- Whenever feasible, utilize horizontal project control monuments as vertical control monuments.
- Locate monuments to minimize disturbance by construction and to be clear of traffic and accessible, preferably within a public right of way or easement.
- When feasible, establish a monument at each major structure.

- Establish durable, permanent monuments with WSDOT markings. The preferred monument is the Type “A” concrete monument with metal disk shown on Standard Plan A74. Other acceptable monuments are 50 mm galvanized steel pipe 750 mm long, with brass disk or plastic plug, 16 mm rebar, 750 mm long with cap, metal disk epoxyed in rock mass or bridge abutment, existing stable monuments, etc.

### **13-05.5 Supplemental Control**

Supplemental control surveys are undertaken to densify project control surveys. Supplemental control is used for establishing photogrammetric control, locating terrain data for engineering surveys, establishing setup points for construction staking, locating land net monuments, and setting right of way monuments. Supplemental control points may be used for both horizontal and vertical control.

#### **Method**

- Differential leveling, see Section 10, “Differential Leveling Survey Specifications.”
- TSS surveys, see Section 9 “Total Station Survey System (TSSS) Survey Specifications.”
- Global Positioning System, see Section 8 “Global Positioning System (GPS) Survey Specifications.”

#### **Accuracy**

Supplemental control surveys shall meet WSDOT third-order survey accuracy for both horizontal and vertical control. See Section 7, “Classifications and Accuracy Standards.”

#### **Monumentation**

Generally monumentation for supplemental control is temporary. Monuments should be set where needed, but out of the way of construction and in stable ground. Examples of temporary monuments are: spikes, concrete nails, iron pipes, rebar, etc.

### **13-06 Office Data Processing and Documentation**

All control surveys will be evaluated, checked and adjusted by method of least squares before being used as a basis for any project survey.

The project surveyor is responsible for assembling all research materials along with the completed field data into a project control survey file. The file is then evaluated by:

- Reviewing field notes for completeness and accuracy.
- Reviewing all closures (residuals), adjustments, and conformance to standards.
- Calculating final horizontal and vertical positional values.

#### **13-06.1 Project Control Diagram**

The Project Surveyor shall prepare a project control diagram for each horizontal project control survey. The diagram shall be a schematic drawing of the horizontal network, including a north arrow, title block, survey date, date of diagram preparation, legend and vicinity map, if applicable. The diagram shall show the horizontal control monuments established, and the HPGN and HPGN-D stations that were used as the basis for the survey with appropriate symbols, monument names, and coordinate table reference numbers, if applicable. Vertical control monuments shall be shown in their location on the diagram.

## **Control Survey Procedures**

The project control diagram shall include a note that bearings, distances, and coordinates are based on the Washington Coordinate System and another note naming the datum used for vertical control. The Washington Coordinate System note shall state the zone of the system, project mapping angle(s), and project combination factor(s).

The project control diagram should contain a coordinate table which includes the following:

- Monument names.
- Horizontal coordinates of each monument (N,E).
- Least squares adjustment residuals for new control points.
- Coordinate dates (epochs).
- Descriptions of each monument.
- Bearing and distances of observed lines (if applicable).
- Reference to permanent file location of survey data, including “to reach” information.
- Overall network closure ratio.

The diagram shall also show the approximate location and include a table listing all vertical project control monuments, including the following:

- Vertical control monument.
- Elevation of each monument.
- Order of accuracy of vertical net.
- Least squares adjustment residuals, if applicable, for new vertical control points.
- Basis of the vertical control surveys (i.e., reference vertical control monuments).
- Descriptions of each monument.

The project control diagram shall be retained (archived) as part of the project control report.

### **13-06.2 Project Control Report**

The project surveyor shall prepare a project control report for each project control survey and file the report, with the project control diagram, as part of the permanent survey office records for the project. Cross file references shall be established in the Surveys office which will enable retrieval of project control reports by either (i) Expenditure Authorization, (ii) County, Route, and Milepost, and (iii) by the Washington Coordinate System coordinates.

Project control reports should generally not exceed three pages plus attachments. The following should be included in each report:

**Project Identification:** County, route, milepost, E.A., etc.

**Project Surveyors:** Project Surveyor, Field Supervisor, Party Chief, Office Supervisor, Data Processor; include Land Surveyor license numbers as applicable.

**Survey Specifications/Standards:** Statement regarding the specifications and standards used for the survey; i.e., WSDOT second-order class, dated nn/nn/nn.

**Dates of Survey:** Dates field work began and ended and date final adjustments were completed.

**Horizontal Survey Method:** General description of the survey method used: i.e., static, kinematic, station-observation time, etc.

**Vertical Survey Method:** General description of instrumentation used: i.e., bar code, TSSS, three-wire, etc.

**Horizontal Monument Types:** General description.

**Vertical Monument Types:** General description.

**Instruments:** Manufacturer, model, serial number of GPS receivers, type and serial numbers of antenna used, digital level, TSSS, etc.

**Base line Software:** Name and version of software used to produce base line vectors and method of data reduction

**Adjustments:** Least squares software used, general comments regarding the consistency of accuracy's achieved, explanation of any large residuals, etc.

**Field Comments:** Pertinent comments regarding the field surveys: i.e., right of entry problems, observation problems, explanation of delays, etc.

**Office Comments:** Pertinent, general comments regarding the data processing and adjustment.

**Project Control Diagram:** The Project Control Diagram shall be included as an attachment to the Project Control Report.

The project surveyor in charge of the project control survey shall be responsible for signing, sealing, and submitting all documents relevant to the project control survey for archiving.

### **13-06.3 Special Consideration for Corridor Control (HPGN-D) Surveys**

Corridor control surveys should be coordinated with the Geometronics Branch. Each corridor control survey shall be either submitted to NGS for inclusion in the National Spatial Reference System (NSRS) or be filed with the County Surveyor as a Record of Survey. The preferred method is to submit the survey for inclusion in the NSRS, so that all HPGN-D stations will be included in the NSRS and any future NGS adjustments. For requirements for submittal to NGS, see *Input Formats and Specifications of the National Geodetic Survey Data Base, I. Horizontal Control Data*, National Geodetic Survey.



Location surveys gather data for use by planners and engineers. The products resulting from location surveys are generally topographic maps and/or a digital terrain model (DTM). Both conventional (on the ground) and photogrammetric methods are used to gather data for location surveys. This chapter provides standards, procedures, and general information for performing conventional location surveys using the WSDOT Total Station System (TSS), GPS, and differential leveling. For a discussion of photogrammetric surveys, see Chapter 12, "Photogrammetry." For a discussion on preparing a Record of Survey or Monumentation Map, see Chapter 16, "MONUMENTATION AND SURVEY RECORDS".

### 14-01 Responsibilities

Successful location surveys require close cooperation between Planning/Design and Surveys.

#### **Project Manager**

The Project Manager is an engineer who leads the Project Development Team and is responsible for overall project planning and completion.

It is the responsibility of the Project Manager to:

- Meet with the Project Surveyor to review the scope and future needs of the project.
- Ensure that all survey requests are accurate and specific.
- Obtain right of entry, as needed, for surveys outside existing WSDOT right of way.

#### **Project Surveyor**

The Project Surveyor is appointed by the Project Engineer to:

- Participate as a member of the Project Development Team.
- Coordinate with other functional areas.
- Review and schedule each location survey request.
- Determine the appropriate method to accomplish the requested surveys in cooperation with the project manager.
- Create and maintain a survey project file.

### 14-02 Preliminary Survey Meeting

As soon as a project is known, e.g., appears on a Status of Projects Report or an initial survey request is received, the Project Surveyor will schedule a meeting with the Project Manager to discuss anticipated survey requests. The meeting with the Project Manager covers:

- Project Schedule
- Acquisition of any critical information not included in the initial survey request such as as-builts, alignments, etc.
- Overall project survey needs
- Alternative survey methods

### **Location Survey Procedures**

- Safety considerations
- Recommendations for survey methods
- Appointment of Project Surveyor to the Project Development Team
- Review of existing Records of Surveys for relevant information.
- Accuracy requirements for the survey
- Determine survey products (See Chapter 16 “MONUMENTATION AND SURVEY RECORDS” for the section on “When a Survey Document is Prepared”).
- Additional survey needs (right of way, construction, etc.)

### **14-03 Location Survey Request**

All location surveys are initiated by a written request from the Project Manager or designee. Requests are directed to the Project Engineer or the Project Surveyor if one has been appointed.

Survey requests should contain the following information:

- Requestor’s name, phone number, and functional area
- Date of request
- County, Route, and milepost of beginning and end of project
- Job Number; work order and group
- Specific date needed (ASAP is not acceptable)
- Description of work requested
- Expected work product
- Sketch of the area to be surveyed showing lateral limits for the survey and beginning and end of work area
- Signature of the Project Engineer or Project Manager (senior level or above)

See Figure 14-1, for sample Survey Services Request form.

Survey requests should be date stamped and then reviewed by the Region Project Survey Manager, Chief of Parties or Party Chief with the Project Engineer or his designee. The purpose of the form is to confirm survey needs: control network, topographic, photogrammetric, crew size, deadlines, construction, mapping, etc.





# Survey Request Form

**Design Office**

|  |                     |   |  |  |                           |
|--|---------------------|---|--|--|---------------------------|
| <b>PE/Manager</b>  |                     |   | <b>Org. Number</b>   | <b>Date Requested</b>  | <b>Date Needed</b>        |
| <b>Team Leader / Contact Name</b>  |                     |   | <b>Contact Phone</b>   |  | <b>Survey Request No.</b> |
| <b>Project ID</b>  | <b>Project Name</b> |   |  |  | <b>State Route</b>        |
| <b>Project Limits</b><br>MP to MP  |                     | <b>Project Scope</b>  |  |  |                           |
| <b>Purpose/Scope of Survey Request</b><br>Description: <input checked="" type="radio"/> General Topo <input type="radio"/> Control <input type="radio"/> Boundary <input type="radio"/> Construct. Layout/Staking <input type="radio"/> As-Built   |                     |   |  |  |                           |
| .....<br>.....<br>.....<br>.....   |                     |   |  |  |                           |
| (Continue on next sheet if necessary)  |                     |   |  |  |                           |
| <b>Additional Special Features Requested</b><br><input type="checkbox"/> 2D/3D survey points and survey chains <input type="checkbox"/> Traffic/Electrical features<br><input type="checkbox"/> Monuments found/Specified <input type="checkbox"/> Wetlands/other environmental features<br><input type="checkbox"/> Utility Features <input type="checkbox"/> Other |                     |   | <b>List other special features:</b><br>.....<br>.....<br>..... |  |                           |
| <b>Survey Request SR Limits</b><br>MP to MP<br>or<br><b>SR Alignment Limits</b><br>STA to STA  |                     | <b>Offset Limits (Left)</b><br>From to<br><br><b>Offset Limits (Right)</b><br>From to |  | <b>Project Combined Factor (CF)</b><br>(if provided by design)<br><br><b>Start survey at:</b><br>Point # / range Segment # |                           |
| <b>Supporting files location</b> (CD, floppy, or network/web location)   |                     |   |  |  |                           |
| In this location, find these supporting files:   |                     |   |  |  |                           |
| <b>Known project control point documentation</b>   |                     |   | _____  |  |                           |
| <b>State Plane to Project conversion report</b>  |                     |   | _____  |  |                           |
| <b>Other supporting documentation</b>  |                     |   | .....<br>.....<br>.....  |  |                           |
| <b>Work Map</b>  |                     |   | _____  |  |                           |

**Survey Crew** To be filled out by survey crew only

|  |  |  |   |                      |                                   |
|--|--|--|---|----------------------|-----------------------------------|
| <b>Survey Crew Party Chief</b>   |  |  | <b>Org. Number</b>                        | <b>Date Received</b> | <b>Date Completed</b>             |
| <b>CAI/CE Operator/Secondary Contact</b>   |  |  | <b>Contact Phone</b>                      |                      | <b>Combined Factor (CF)</b> _____ |
| <b>Survey data has been:</b> <input type="checkbox"/> Not Collected <input type="checkbox"/> Collected <input type="checkbox"/> Downloaded <input type="checkbox"/> Processed/Adjusted <input type="checkbox"/> Checked <input type="checkbox"/> DTM developed |  |  |   |                      |                                   |
| <b>Survey files location</b> (CD, floppy, or network/web location)   |  |  | <b>Survey Feature Code Tables</b>         |                      |                                   |
| In this location, find these survey files:   |  |  |   |                      |                                   |
| <b>Survey files</b> (KCM,XLM,SDR, etc.)  |  |  | WSDOT Std _____<br>Project Specific _____ |                      |                                   |
| <b>Monument documentation</b><br><b>State Plane to Project Datum report</b>  |  |  | _____                                     |                      |                                   |
| <b>Traverse document(s)</b>  |  |  | _____                                     |                      |                                   |
| <b>Non-Std Feature codes used</b>  |  |  | _____                                     |                      |                                   |
| <b>Survey Party Chief Comments:</b>  |  |  |   |                      |                                   |
| .....<br>.....<br>.....  |  |  |   |                      |                                   |

**SAMPLE SURVEY REQUEST FORM**  
*Figure 14-1*

## **14-04 Planning**

Planning begins with the meeting between the Project Surveyor and the Project Manager to discuss the proposed survey request. See 14-02, "Preliminary Meeting." From a planning perspective, an important part of this meeting is obtaining information about anticipated future related survey requests for the project. Consideration of future right of way surveys and construction surveys are considerations of the planning process so that the most efficient survey work plan for the overall project can be formulated.

A work plan for location surveys is prepared by the Project Surveyor. This work plan contains:

- A list of the required location survey products
- A schedule for the requested project surveys, including critical milestones
- Resource needs (personnel, equipment, overtime, travel expense)

### **14-04.1 Safety Planning**

Safety is a prime consideration in all survey planning and especially with location surveys, which often require work in and around traffic. A key planning consideration is to reduce (minimize) the overall exposure of surveyors to traffic. Carefully selecting the survey method, choosing the time to perform the survey, and employing special survey techniques can accomplish this in part.

## **14-05 Research**

Make research for the location surveys part of the research for the overall project. Research for location surveys and control surveys can be undertaken at the same time.

Identify existing survey control in the area. When necessary, plan a control survey that will meet the requirements of the initial survey request as well as anticipated future project surveying needs. See Chapter 13, "Control Survey Procedures."

Research information in WSDOT files so that all existing aerial photos, topographic mapping, monumentation maps, USGS maps, and as-built plans are identified. This will ensure that work accomplished on a previous project or survey request will not be duplicated.

Search the records and files of other government agencies, utility companies, and railroads for information on facilities located in the project area. Potential agencies include:

- Federal agencies: Bureau of Land Management, Bureau of Reclamation, Army Corps of Engineers, National Oceanic Atmospheric Administration, National Geodetic Survey and U.S. Forest Service.
- State agencies: Department of Parks and Recreation and Department of Natural Resources.
- Local public agencies: County and city public works departments, transit districts, reclamation districts, flood control districts, public utility districts, park districts, water districts, and community service districts.
- Private utility companies: Railroad, electrical power, telephone, cable TV, natural gas, pipeline companies, and water companies.

Obtain vesting documents for all recorded easements.

A data base of local contacts for survey research efforts should be maintained by each Surveys office. A simple, searchable, digital data base can be used for this purpose. Each record should contain the name of the agency or company, address, phone numbers, and the name of contacts. Special care should be taken to keep contacts friendly. Prompt payment for information that is purchased and letters thanking cooperative staff go a long way to improving research efforts.

#### **14-06 Office Preparation**

The Project Surveyor and party chief are responsible for the development of the necessary instructions and information (field package) for performing the requested location surveys. Surveys office staff, under the direction of the Project Surveyor, generally prepare the field package using information obtained from the research, together with other compiled and computed data. The field package contains all the necessary information and data to efficiently complete the field work required by the survey request. Typical information and data include:

- Copy of survey request (always included)
- Special instructions including safety and hazardous waste considerations (always included)
- Control diagram and station listing
- As-built plans
- Monumentation and right of way maps and monument listing
- Maps of record
- Utility maps
- Utility easement descriptions
- Data in digital format
  - Control data: descriptions, coordinates, elevations
  - Monumentation data: descriptions, coordinates
  - Topo data: descriptions, coordinates, elevations
  - Alignment data

#### **14-07 Field Work**

Field work should not be initiated without a completed field package, including survey request form and written instructions designating any special survey needs.

##### **14-07.1 General**

Download data collectors daily. Transfer files to a laptop computer hard drive or server and then back up on an approved storage medium disk. File naming conventions must be used to keep track of raw data files for each day of work for large survey requests. Locate data files, for each job, in a job directory. Store any comments, descriptions of special circumstances, and narratives of the work in a read.me subdirectory of the job directory.

Field crews must check their own work before sending it to the office. Field crews located in remote areas must check their work before returning to their area office. All work by field crews must be independently checked in the area office. Responsibility for final checking of all survey products, including DTMs, rests with the area office data processing staff.

### 14-07.2 Topographic Survey

Topographic surveys are undertaken to determine the configuration of the earth's surface and the locations of natural and manmade objects and features. The resulting products of topographic surveys, digital terrain models (DTMs) and topographic maps are the basis for planning studies and engineering designs.

A DTM is a representation of the surface of the earth using a triangulated irregular network (TIN). The TIN models the surface with a series of triangular planes. Each of the vertices of an individual triangle is a coordinated (x,y,z) topographic data point. The triangles are formed from the data points by a computer program that creates a seamless, triangulated surface without gaps or overlaps between triangles. Triangles are created so that their sides do not cross breaklines. Triangles on either side of breaklines have common sides along the break line. (See Figure 14-2.)

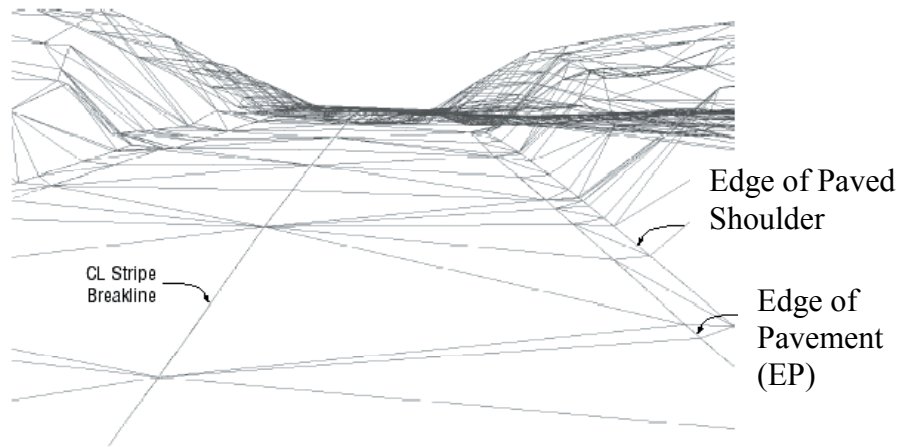

**A DTM MODEL USING THE TIN METHOD**

*Figure 14-2*

Breaklines define the points where slopes change in grade (the intersection of two planes). Examples of Breaklines are the crown of pavement, edge of pavement, edge of shoulder, flow line, top of curb, back of sidewalk, toe of slope, top of cut, and top of bank. Breaklines within existing highway rights of way are clearly defined, while breaklines on natural ground are more difficult to determine.

Locating topographic data points that define breaklines and random spot elevation points creates DTMs. The data points are collected at random intervals along longitudinal breaklines with observations spaced sufficiently close together to accurately define the profile of the break line. Like contours, breaklines do not cross themselves or other breaklines.

Add structure section.

Cross-sections can be generated from the finished DTM for any given alignments.

**Method:** When creating field-generated DTMs, data points are gathered along DTM breaklines, and randomly at spot elevation points, using the TSS radial survey method. This method is called a DTM break line survey.

The number of breaklines actually surveyed can be reduced for objects of a constant

shape such as curbs. To do this, a standard cross section for such objects is sketched and made part of the field notes. Field-collected breaklines are identified by line numbers and type on the sketch along with distances and changes in elevation between the breaklines. With this information in the field notes, only selected breaklines need to be located in the field, while others are generated in the office based on the standard cross section.

**Advantages of DTM break line surveys:**

- Safety of field crews is increased because the need to continually cross traffic is eliminated.
- Observations at specific intervals (stations) are not required.
- New sets of cross sections can be easily created for each alignment change.

**DTM survey guidelines:**

- Remember to visualize the DTM that will be created to model the ground surface and how breaklines control placement of triangles.
- Use proper and up to date, feature topographic codes, and point numbering.
- Collect extra ground shots for critical points between breaklines, around drop inlets and culverts, and on natural ground in relatively level areas.
- Make a sketch of the area to be surveyed identifying breaklines by name.
- Do not change break line codes without creating a new line.
- Take shots on breaklines at approximately 50 foot intervals and at changes in grade.
- Locate topography points/shots at high points and low points and on a grid of approximately 50 foot centers when the terrain cannot be defined by breaklines.
- Keep sight distances to a length that will ensure that data point elevations meet desired accuracies, especially in steep terrain.
- Gather one extra line of terrain points 20 to 30 feet outside the work limits.
- Locate major features outside of work area that will be impacted by project.

**Accuracy Standard:** Topography points/shots located on paved surfaces or any engineering works are located within  $\pm 0.06$  ft horizontally and  $\pm 0.05$  ft vertically. Topography points/shots on original ground are located within  $\pm 0.15$  ft horizontally and vertically.

**Checking:** Check topography points/shots by various means including reviewing the resultant DTM, reviewing breaklines in profile, and locating some data points from more than one setup.

**Products:** The Surveys group is responsible for developing and delivering final, checked location survey products, including DTMs, to the Project Manager. Products can be tailored to the needs of the requestor whenever feasible, but normally should be kept in digital form and include the following items:

- Converted and adjusted existing recorded alignments, if requested. (CAiCE or similar design software project subdirectory)
- CAiCE KCM file or similar design software files of survey chains and points. (CAiCE project subdirectory)
- CAiCE or similar design software segment name and description.
- CAiCE or similar design software DTM surface files. (CAiCE project subdirectory)

## **Location Survey Procedures**

- Hard copy topographic map with border, title block, labeled contours, and planimetry.
- File of all surveyed points with coordinates and descriptions.
- Project Datum information.

### **14-07.3 Pavement Elevation Surveys**

A significant portion of today's transportation program consists of rehabilitation and other improvements of existing facilities. For these projects, elevations of existing pavements are often required to develop accurate plans, specifications, and estimates. Because of safety considerations, surveyors need to carefully select methods and procedures for conducting pavement elevation surveys.

Until recently, the only practical method to acquire pavement elevation data was through conventional leveling or TSS methods. Both of these methods require surveys to be performed in, or adjacent to, moving vehicular traffic and can necessitate the use of temporary traffic controls including lane closures.

Alternate methods for determining pavement elevations, such as remote observations and photogrammetry, are now available and should always be considered. It is the responsibility of the Project Surveyor, in cooperation with the field supervisor, the requesting Project Manager, and with the assistance of Safety, Traffic Operations, Maintenance, and Permits functions, to determine the survey method or system that is most appropriate for a project.

When a request for a pavement elevation survey is received, the Project Surveyor will cooperate with staff from the following functional areas:

- Requesting Project Engineer: Determine (a) the overall objectives of the survey, (b) possible areas that can be eliminated to reduce the amount of data collection required, (c) realistic delivery times, and (d) the pavement elevation accuracy requirements. Key objective: determine, in cooperation with the Project Engineer, what is the minimal amount of data, if any, that is necessary to obtain a quality design.
- Permit Engineer: Determine if consultants, contractors, or others are, or will be, working near the project location.
- Traffic Operations: Obtain information on average daily traffic, peak hour traffic, and feasibility of traffic controls, including lane and shoulder closures.
- Maintenance: Coordinate survey activities with the maintenance engineer and area superintendent. Determine if maintenance activities that will require lane closures are planned for the survey area. Possibly, a maintenance lane closure can be jointly used for the survey effort.
- Safety: Solicit comments and advice from the Region Safety Office whenever safety issues arise that are not routine.

#### **Note:**

Remember, the need for a pavement elevation survey should always be questioned. The use of as-built information, existing survey data, or other record data must be considered before performing a pavement elevation survey. Request the Project Engineer to consider alternate design methods or procedures that do not require pavement elevations or require less accurate pavement elevations.

For instance, if concrete barriers are to be installed for construction, discuss with the Project Engineer the feasibility of collecting accurate pavement elevations after the

barriers are installed, but before establishing (staking) the final grade. With this method, the design is based on available data and then refined based on accurate pavement elevations collected during construction.

### **Safety**

Pavement elevation surveys are one of the most hazardous surveys performed by WSDOT surveyors. It is imperative that safe surveying practices be employed for such surveys.

For pavement elevation surveys, a key planning consideration is to reduce (minimize) the overall exposure of surveyors to traffic. Carefully selecting the survey method, choosing the time to perform the survey, and employing special survey techniques can accomplish this, in part. In addition, when planning pavement elevation surveys, safety of the traveling public must be a priority consideration.

Prior to commencing each pavement elevation survey, a tailgate safety meeting shall be conducted. All those involved in the pavement elevation survey must participate in the meeting and discuss all safety aspects of the survey. The meeting must be documented.

Close coordination between the Surveys Office and the Region Safety Office must be maintained.

**Method:** WSDOT and others have developed innovative methods for pavement elevation surveys. Whenever appropriate, employ new surveying technologies to reduce exposure of surveyors to traffic hazards. See Section 11.7-4, "Pavement Elevation Survey Methods."

**Accuracy Standard:** Data points should be located within  $\pm 0.05$  ft horizontally and  $\pm 0.03$  ft vertically.

**Checking:** Data points are checked by various means including reviewing breaklines in profile and locating some data points from more than one setup.

**Products:** The Survey Group is responsible for developing and delivering final, checked location survey products, including DTMs, to the survey requestors. Products can be tailored to the needs of the requestor whenever feasible, but normally should be in digital form and include the following items:

- CAiCE KCM file or similar design software files of survey chains and points.
- CAiCE or similar design software segment name and description.
- CAiCE DTM or similar design software surface files. (CAiCE project subdirectory)
- Files of all surveyed points with coordinates and descriptions.
- Project Datum information.

### **14-07.4 Pavement Elevation Survey Methods**

Various pavement survey methods are discussed in detail below to aid in the selection of the best method for a given survey.

#### **14-07.4(a) Conventional (TSS) Survey:**

**Description:** Locate data points on pavement breaklines using the TSS radial survey method. Accuracy of survey data points are within 0.02 ft.

Several methods have been used successfully to aid the surveyor to continually monitor traffic while making observations at the edge of a roadway. Two of these methods are:

## Location Survey Procedures

- Stand to the side of the pavement break line and hold the prism rod inverted, at an angle, with the prism directly on the observation point. The instrument operator sights the intersection of the prism and pavement (zero height of target).
- Utilize an expendable prism (sign reflector) mounted in a small (2.5" diameter) piece of material from a cone base. The expendable prism is placed directly on the point of observation, and the instrument operator sights as noted above.

The main disadvantage to the DTM break line method is that it normally cannot be used to obtain interior break line elevations (e.g., crown lines) without lane closures.

**Production:** Production varies depending on traffic, road profile, and number of breaklines. A four-person survey party is recommended. In light-to-moderate traffic, 200 to 250 observations per day can be expected. This equates to 4000 to 5000 feet per day of roadway, with four to five pavement breaklines. Production is reduced significantly by heavy traffic conditions and complexity of highway cross sections. Additional breaklines significantly reduce production. Survey costs increase significantly if lane closures are necessary.

### 14-07.4(b) Trigonometric Surveys:

**Description:** WSDOT has devised trigonometric methods to determine pavement elevations using the TSS without the use of a prism. These methods have been used successfully to supplement conventional pavement elevation surveys. Accuracy of survey data points are within 0.02 feet.

Following are such methods:

- **Prismless /TSS:** This method utilizes the technology of prismless EDM's in a Total Station. In the field a TSS is used to observe paint markings or pavement markers at ground level (typically at 40' intervals). Care must be exercised to take shot within the instruments range to maintain desired accuracy tolerances. Use standard feature codes for all shots. When changing instrument positions, turn to the last point collected to determine location to start collection of data.
- **Defined Line/TSS:** This method requires a known roadway (as-built) alignment that is consistent with (a) existing, well-defined, as-built roadway features (e.g., edge of pavement, edge of gutter) and (b) existing project control. Station/offset coordinates are pre-calculated for each required pavement elevation location. Direction and distance are then calculated from a specific, known control point to each pavement elevation location. In the field, a TSS is used to observe the known direction and to measure the unknown vertical angle to each pavement elevation location from a known control point. The predetermined distance, observed direction, and measured vertical angle are used to create a data file from which pavement elevations are calculated. Pre-determined distances and directions can be calculated.
- **Two TSS/Laser Dot:** Another similar method employs two TSS and a low-power laser. With this method, simultaneous horizontal and vertical TSS measurements are made from two known control points to a random pavement point defined by directing a laser beam onto the pavement surface at the location desired. The laser beam provides a sight point for the simultaneous TSS observations. (Prior to using this method, review the latest safety regulations concerning the operation of laser devices.)

**Note:**

The advantage of trigonometric methods over the conventional method is that surveyors



are not required to work adjacent to traffic. Additional costs are incurred because of the need for very accurate alignment data for the Defined Line/TSS method and the need for larger survey crews for the Two TSS/Laser Dot method. Both methods require an expanded control network and more time for computations.

**Production:** Varies depending on number of breaklines. Generally, less production than the normal DTM break line method.

### **14-07.5 Utility Surveys**

Utility surveys are undertaken to locate existing utilities for (a) consideration in engineering design, (b) purposes of utility relocation, and (c) right-of-way acquisition and negotiation.

Show survey limits and types of utilities to be located on the Survey Request and/or its attachments. Include all utility maps and drawings and descriptions of easements in the field survey file.

It is important to locate all significant utility facilities. The following are lists of facilities and critical points to be located for various utilities. Be sure to check the field package for any required special facilities not listed. Pothole underground utilities only if specifically requested on the Survey Request. Potholing is to be undertaken by the utility company.

#### **Oil and Gas Pipelines**

- Intersection point with center lines and/or right of way lines
- For lines parallel to right of way – location ties necessary to show relationship to the right of way lines
- Vents
- Angle points
- Meter vaults, valve pits, etc.

#### **Water and Sewer Lines**

- Intersection point with center lines and/or right of way lines
- For lines parallel to right of way – location ties necessary to show relationship to the right of way lines
- Manholes, valve boxes, meter pits, crosses, tees, bends, etc.
- Elevation on waterlines, sewer inverts, and manhole rings
- When appropriate, or when requested, draw a sketch of storm and sewer manholes identifying the type and size of pipes and the direction of flow. Also, indicate which structure the pipelines flow to or from.
- Fire hydrants
- Curb stops

#### **Overhead Lines**

- Supporting structures on each side of roadway with elevation of neutral or lowest conductor at each center line crossing point.
- On lines parallel to roadway, supporting structures that may require relocation, including overhead guys, stubs, and anchors.

#### **Underground Lines**

## **Location Survey Procedures**

- Cables/lines (denote direct burial or conduit, if known), etc.
- Manholes, pull boxes, and transformer pads
- Crossing at center line or right of way lines
- For lines parallel to right of way – location ties as necessary to show relationship to the right of way lines

### **Railroads**

- Profile and locate 500 ft each side of the proposed roadway right of way lines. (See Design Manual Chapter 930.03.)
- Switch points, signal, railroad facilities, communication line locations, etc.

**Method:** TSS radial survey, GPS fast static, kinematic or RTK.

**Accuracy Standard:** Data points located on paved surfaces or any engineering works are located within  $\pm 0.10$  ft horizontally and  $\pm 0.10$  ft vertically. Data points on original ground will be located within  $\pm 0.30$  ft horizontally and vertically. Be certain to review the purpose and type of the utility location with the Project Engineer. Some utility locations may require more stringent accuracies than above due to possible conflicts with other utilities, topographic features or design limitations. Adjust the method and accuracies expected to the purpose of the survey.

**Checking:** Utility data should be checked by the following means:

- Compare field collected data with existing utility maps
- Compare field collected data with the project topo map/DTM
- Review profiles of field collected data
- Include field collected data that have elevations in project DTM
- Locate some data points from more than one setup

**Product:** The Survey Group is responsible for developing and delivering final, checked location survey products, including DTMs, to the survey requestors. Products can be tailored to the needs of the requestor whenever feasible, but normally should be in digital form and include the following items:

- CAiCE KCM or similar design software files file of survey chains and points
- CAiCE or similar design software segment name and description
- CAiCE or similar design software DTM surface files (CAiCE project subdirectory)
- Hard copy topographic map with border, title block, labeled contours, and planimetry
- File of all surveyed points with coordinates and descriptions

### **14-07.6 Archaeological Site/Environmentally Sensitive Area Survey**

Archaeological and environmental site surveys are performed for planning and engineering studies. Surveys staff must work closely with the appropriate specialists and the survey requestor to correctly identify archeological and environmentally sensitive data points.

**Method:** TSS radial survey, GPS fast-static, kinematic or RTK

**Accuracy Standard:** Data points located on paved surfaces or engineering works are located within  $\pm 0.50$  ft horizontally and  $\pm 0.50$  ft vertically. Data points on original

grounds are located within  $\pm 0.50$  ft horizontally and vertically. Review field survey package for possible higher required accuracy.

**Checking:** Check data points by various means including, reviewing the resultant DTM, reviewing breaklines in profile, and locating some data points from more than one setup.

**Product:** The Survey Group is responsible for developing and delivering final, checked location survey products, including DTMs, to the survey requestors. Products can be tailored to the needs of the requestor whenever feasible, but normally should be in digital form and include the following items:

- 3-D digital graphic file of mapped area (Intergraph, .dgn, format)
- Hard copy topographic map with border, title block, and planimetry (contours and elevations only if specifically requested)
- File of all surveyed points with coordinates and descriptions

### **14-07.7 Spot Location or Monitoring Surveys**

Monitoring surveys are undertaken for monitoring wells, bore hole sites, and other needs.

**Method:** TSS radial survey, GPS fast static or kinematic

**Accuracy Standard:** Data points located on paved surfaces or any engineering works are located within  $\pm 0.08$  ft horizontally and  $\pm 0.05$  ft vertically. Data points on original ground are located within  $\pm 0.15$  ft horizontally and vertically. Be certain to review the purpose of the spot location and monitoring surveys with the Project Engineer. Some spot checking and monitoring may require more stringent accuracies than above. Adjust the method and accuracies expected to the purpose of the survey.

**Checking:** Observe data points with multiple ties. See Chapter 9-4.2 “TSS Specifications - Methods.”

**Product:** The Survey Group is responsible for developing and delivering final, checked location survey products, including DTMs, to the survey requestors. Products can be tailored to the needs of the requestor whenever feasible, but normally should be in digital form and include the following items:

- File of all surveyed points with coordinates and descriptions
- Sketch or map showing locations of data points

### **14-07.8 Vertical Clearance Surveys**

Vertical clearance surveys are undertaken to measure vertical clearances for signs, overhead wires and bridges.

**Method:** TSS radial method.

**Accuracy Standard:** Data points located on paved surfaces or any engineering works are located within  $\pm 0.10$  ft horizontally and  $\pm 0.10$  ft vertically. Data points on original ground should be located within  $\pm 0.10$  ft horizontally and vertically.

**Checking:** Observe data points with multiple ties. See Chapter 9-4.2 “TSS Specifications Methods.”

**Product:** The Survey Group is responsible for developing and delivering final, checked location survey products, including DTMs, to the survey requestors. Products can be

## **Location Survey Procedures**

tailored to the needs of the requestor whenever feasible, but normally should be in digital form and include the following items:

- File of all surveyed points with coordinates and descriptions
- Sketch or map showing vertical clearances
- Project Datum information.

### **14-08 Office Data Processing**

Data processing includes preparing and checking survey products for delivery to the survey requestor. Processing, editing, and transferring data is all done using CAiCE software. Supplemental control established during the location survey must be adjusted by appropriate method, least squares, compass or transit rule, constrained to existing project control before calculating coordinates for topographic data points.

#### **14-08.1 DTM Processing**

The primary steps in processing a DTM are:

1. Use CAiCE or similar design software to create a survey database file, adjust control network, compute adjusted coordinates (x,y,z) for all DTM data points, edit known coding problems.
2. Review file to verify checks shots and validate field procedures such as proper entry of instrument and prism height.
3. Check the survey chains (DTM breaklines) in plan and profile for errors: incorrect positions, points skipped, crossing breaklines, and mislabeled data.
4. Create DTM surface database, calculate DTM triangles, and compute DTM contours.
5. Check the DTM by creating “freehand” cross sections from the DTM contours.
6. Return to step 1 and make corrections to database noted from steps 3-7. Repeat steps 3-5 as necessary.

## 15-01 General

In performing construction surveying, preparation is a major part of the operation. Study the contract plans, special provisions, *Standard Plans*, *Standard Specifications*, the plan quantities, *Construction Manual*, and the contractor's proposal. Take appropriate measures to protect existing monuments. (See Chapter 16 "Monumentation and Survey Records").

Features may be staked directly from the highway center line by station and offset, or they may be staked from some other control point that is more convenient. Depending on the type of work to be performed by the contractor, stakes may be set to mark the actual work, such as clearing limits, or they may be offset in staking pipe.

After completing a staking operation, look at the stakes to be sure that they are in a uniform line if they should be. "Double Checking" is *the most important part* of construction surveying. Check everything that is staked and always have another member of the crew double check any calculations that someone has made. Always visually check field staking making sure it looks correct. If your not sure, check it out. Many errors can be caught beforehand or eliminated if the survey crew stays aware and questions anything that looks out of the ordinary. Review cuts or fills recorded on the stakes to ensure that they agree with the notes.

In addition to "Field Note Records" (which are kept as documentation for payments to the contractor), computer printouts, and cross section notes, keep a field book to record alignment, references, control points, slope stake data, drainage computations, and other information. A Surveyors Daily Report should be made denoting all work completed for the day. (DOT Form 237-010 EF).

Included in this chapter are five phases of construction for many WSDOT projects. They are:

- Earthwork and Surfacing
- Drainage
- Structure layout
- Miscellaneous Construction
- Post Construction Surveying
  - WSDOT Standard Color Codes
  - Equipment Table

## 15-02 Earthwork and Surfacing

As the construction work progresses, the survey crew is usually involved in the following stages:

- Clearing and Grubbing
- Slope Staking
- Grade Control

15-02.1 Clearing and Grubbing

After Aesthetic and Environmental concerns are addressed, Clearing and Grubbing stakes are set to mark the limits of disposal of all unwanted material from the surface (clearing) and underground (grubbing). This prepares the project for other staking and construction activities. See Chapter 2-1 of the *Construction Manual*.

Use the construction center line as the reference line for setting clearing stakes. Set stakes (lath) at least 4 feet long, marked "Clearing," at the offset, marking the limits of the area to be cleared. Where slope treatment is to be provided, clearing normally is staked 10 feet beyond the limits of the slope treatment with 5 feet minimum. Do not set grading stakes until clearing and grubbing work is completed. Refer to the *Standard Specifications*, Section 2-01.

While staking for clearing and grubbing, the party chief prepares a "Field Note Record," WSDOT Form 422-636EF (Figure 15-1). Complete the heading. In the sketch grid area, show center line, stations, and limits of clearing and grubbing. Include a north arrow. Do not try to draw to scale, as an exaggerated scale makes the note easier to read. Use a straightedge for straight lines. Gaps that require no work and isolated areas that require work should be staked in accordance to the Standard Specifications in Section 2.01.4.

**FIELD NOTE RECORD (SKETCH GRID)**

|                            |  |                                  |  |                           |  |                       |  |
|----------------------------|--|----------------------------------|--|---------------------------|--|-----------------------|--|
| CONTRACT NO. <b>1-4444</b> |  | SECTION <b>170+00 to 170+800</b> |  | MILELINE                  |  | BOOK NO. <b>0883</b>  |  |
| DRAWN BY <b>JVP</b>        |  | DATE                             |  | WORK DATED <b>10-1-96</b> |  | WORK COMPLETED        |  |
| CALCULATED BY              |  | CHECKED BY                       |  | DATE                      |  | INSPECTOR'S SIGNATURE |  |

|                           |                 |     |                 |      |
|---------------------------|-----------------|-----|-----------------|------|
|                           | grubbing limits | ¢   | grubbing limits |      |
| Distance from center line | 27.1            | 8.5 | 18.6            | 35.4 |
| +100                      | 26.8            | 8.6 | 19.2            | 36.6 |
| +200                      | 24.4            | 7.9 | 17.7            | 34.1 |
| +300                      | 23.2            | 8.2 | 18.9            | 32.9 |
| +400                      | 23.2            | 8.5 | 19.8            | 32.9 |
| +500                      | 25.0            | 8.5 | 18.5            | 32.9 |
| +600                      | 29.0            | 8.5 | 18.3            | 32.9 |
| +700                      | 29.0            | 8.8 | 17.9            | 32.3 |
| 170+800                   | 21.3            | 8.2 | 16.2            | 30.5 |

| ITEM NO. | ITEM     | GROUP NO. | DATE | UNIT | QUANTITY       | RANGE NO. | DATE OF MATERIAL ACCEPTANCE | CAPX (ENR) NO. | PETALS | EST. NO. |
|----------|----------|-----------|------|------|----------------|-----------|-----------------------------|----------------|--------|----------|
| 2        | clearing |           |      |      | m <sup>2</sup> |           |                             |                |        |          |
| 3        | grubbing |           |      |      | m <sup>2</sup> |           |                             |                |        |          |

DOT FORM 422-636EF  
REVISED 1/96

Figure 15-1 Field Notes for Clearing and Grubbing

15-02.2 Slope Staking

Slope staking is a trial and error process of finding the point where the slope intercepts the natural ground. This point is referred to as the “catch point” or “slope catch.”

The information needed to set slope stakes is obtained from the contract plans and the computer generated slope stake notes which includes:

- Profile grade elevation.
- Traveled way cross slopes and lane widths.
- Shoulder slopes and widths.
- Side slopes, cut or fill.
- Ditch inslopes, back slopes, and depths.
- Total depth of surfacing materials.

| Alignment Chain A90           |             |            |             |            |            |         |            |            |             |            |             |           |
|-------------------------------|-------------|------------|-------------|------------|------------|---------|------------|------------|-------------|------------|-------------|-----------|
| Station 294+50.00 Surface FIN |             |            |             |            |            |         |            |            |             |            |             |           |
| C 13.27                       | EPP         |            | EPP         | EPP        | WBINSHL D  | CL      | EBINSHL D  | EBINSHL D  |             |            | EPP         | C 19.39   |
| @ 113.18                      | -47.00      | -35.00     | -23.00      | -11.00     | -87        | .00     | 87         | 11.00      | 23.00       | 35.00      | 47.00       | @ 131.56  |
| \$ 3.00:1                     | 1971.86     | 1972.10    | 1971.86     | 1971.62    | 1971.42    | 1974.27 | 1971.42    | 1971.62    | 1971.86     | 1972.10    | 1971.86     | \$ 3.00:1 |
|                               | -2.00%      | 2.00%      | 2.00%       | 2.00%      | -0.31:1    | .       | -0.31:1    | 2.00%      | 2.00%       | 2.00%      | -2.00%      |           |
|                               | <b>EPSP</b> | <b>SGS</b> | <b>DTCH</b> | <b>BKD</b> | <b>LCP</b> |         | <b>RCP</b> | <b>BKD</b> | <b>DTCH</b> | <b>SGS</b> | <b>EPSP</b> |           |
|                               | -59.00      | -68.89     | -71.89      | -73.39     | -113.18    |         | 131.56     | 73.39      | 71.89       | 68.89      | 59.00       |           |
|                               | 1971.62     | 1969.97    | 1969.47     | 1969.97    | 1983.24    |         | 1989.36    | 1969.97    | 1969.47     | 1969.97    | 1971.62     |           |
|                               | -2.00%      | -6.00:1    | -6.00:1     | 3.00:1     | 3.00:1     |         | 3.00:1     | 3.00:1     | -6.00:1     | -6.00:1    | -2.00%      |           |

| Alignment Chain A90           |             |            |             |            |            |         |            |            |             |            |             |           |
|-------------------------------|-------------|------------|-------------|------------|------------|---------|------------|------------|-------------|------------|-------------|-----------|
| Station 295+00.00 Surface FIN |             |            |             |            |            |         |            |            |             |            |             |           |
| C 14.27                       | EPP         |            | EPP         | EPP        | WBINSHL D  | CL      | EBINSHL D  | EBINSHL D  |             |            | EPP         | C 20.93   |
| @ 116.21                      | -47.00      | -35.00     | -23.00      | -11.00     | -87        | .00     | 87         | 11.00      | 23.00       | 35.00      | 47.00       | @ 136.18  |
| \$ 3.00:1                     | 1971.36     | 1971.60    | 1971.36     | 1971.12    | 1970.91    | 1973.76 | 1970.91    | 1971.12    | 1971.36     | 1971.60    | 1971.36     | \$ 3.00:1 |
|                               | -2.00%      | 2.00%      | 2.00%       | 2.00%      | -0.31:1    | .       | -0.31:1    | 2.00%      | 2.00%       | 2.00%      | -2.00%      |           |
|                               | <b>EPSP</b> | <b>SGS</b> | <b>DTCH</b> | <b>BKD</b> | <b>LCP</b> |         | <b>RCP</b> | <b>BKD</b> | <b>DTCH</b> | <b>SGS</b> | <b>EPSP</b> |           |
|                               | -59.00      | -68.89     | -71.89      | -73.39     | -116.21    |         | 136.18     | 73.39      | 71.89       | 68.89      | 59.00       |           |
|                               | 1971.12     | 1969.47    | 1968.97     | 1969.47    | 1983.74    |         | 1990.40    | 1969.47    | 1968.97     | 1969.47    | 1971.12     |           |
|                               | -2.00%      | -6.00:1    | -6.00:1     | 3.00:1     | 3.00:1     |         | 3.00:1     | 3.00:1     | -6.00:1     | -6.00:1    | -2.00%      |           |

Figure 15-2A Computer Generated Slope Stake Notes

Also see Figure 15-2B for an example of hand written slope stake notes.

EXAMPLE OF SLOPE STAKING NOTES

| STA.  | SECTION   |  |  |  |  |       | ELEV. | GRADE | AREAS                  |         | CU. YDS. |         | REMARKS  |
|-------|---|--|--|--|--|-------|-------|-------|------------------------|---------|----------|---------|--|
|       | CUT OR FILL   |  |  |  |  |       |       |       | EXCAV.                 | EMBANK. | EXCAV.   | EMBANK. |  |
|       | LEFT  | %  |  |  |  | RIGHT |       |       | EXCAV.                 | EMBANK. |          |         |  |
|       | 4:1   |  |  |  |  |       |       |       |                        |         |          | 225.6   |  |
| 158   | (0.0) -2.8 -2.8 -1.8 -1.1 0.0<br>253 362 30 253 50  |  |  |  |  |       | 331.6 | 333.7 |                        | 129.6   |          |         |  |
| +15   |   | 4:1  |  |  |  | SLT   |       |       | 0.0                    |         |          |         |  |
| +50   |   | 0.0 +1.6 +2.3 +2.8 +4.6 +3.5 (0.0) 13.7<br>250 230 286 390 428 289 416 |  |  |  |       | 337.8 | 336.2 |                        | 0.0     | 499      |         |  |
|       | SLT 4:1   | 3:1  |  |  |  |       |       |       | 107.7<br>0.29<br>110.8 |         | 275.0    |         | BM Sta.<br>158+10<br>5' Fir<br>56' Lt.<br>Elev.<br>334.35      |
| 159   | (0.0) 0.0 +0.7 +2.3 +3.0 +2.2 +2.4 +4.5 +4.5 (0.0) 14.8<br>536 486 422 222 222 217 380 412 211 482                      |  |  |  |  |       | 341.7 | 338.7 | 181.0<br>0.4<br>181.4  |         |          |         |  |
|       | 3:1   | 2:1  |  |  |  |       |       |       |                        |         | 419.1    |         |  |
| +50   | (3.4) (0.0) +3.8 +4.7 +4.1 -5.6 +5.0 +4.8 -5.7 +4.9 (0.0) 14.7<br>461 217 391 271 222 222 268 340 366 268 436           |  |  |  |  |       | 346.8 | 341.2 | 326.4<br>0.46<br>326.8 |         |          |         |  |
|       | 1 1/2:1   | 1 1/2:1  |  |  |  |       |       |       |                        |         | 365.2    |         |  |
| +15   | (5.6) (0.0) +6.1 +6.3 +5.3 -7.4 -7.9 +7.6 -7.9 +7.1 (0.0) 18.0<br>426 264 356 264 222 222 264 340 371 364 441           |  |  |  |  |       | 351.1 | 343.7 | 454.1<br>0.38<br>454.5 |         |          |         |  |
|       | 1:1   | 1:1  |  |  |  |       |       |       |                        |         | 414.4    |         |  |
| 160   | (6.5) (0.0) +6.1 +6.6 +7.0 +7.1 +7.8 +8.0 +9.2 +9.0 (0.0) 18.8<br>390 259 32.0 25.9 22.2 22.2 25.9 39.9 34.5 25.9 41.9  |  |  |  |  |       | 353.3 | 346.2 | 433.8<br>0.34<br>434.2 |         |          |         |  |
|       | 1:1   | 1:1  |  |  |  |       |       |       |                        |         | 812.1    |         |  |
| +44.5 | (6.8) (0.0) +6.4 +6.1 +6.4 +7.8 +8.9 +8.3 +8.4 +8.7 (0.0) 18.9<br>393 259 32.3 25.9 22.2 22.2 25.9 32.5 36.6 25.9 42.6  |  |  |  |  |       | 356.5 | 348.7 | 463.6<br>0.34<br>464.0 |         |          |         | BM Sta.<br>160+76.4<br>10' Cedar<br>61' Rt.<br>Elev.<br>355.21 |
|       | 1:1   | 1:1  |  |  |  |       |       |       |                        |         | 923.1    |         |  |
| +38.5 | (7.8) (0.0) +7.3 +7.5 +7.9 +8.8 +9.3 +9.3 +10.7 +9.4 (0.0) 19.0<br>462 259 33.2 25.9 22.2 22.2 25.9 31.5 35.3 25.9 35.1 |  |  |  |  |       | 360.7 | 351.9 | 526.6<br>0.34<br>527.0 |         |          |         |  |

245

Figure 15-2B Hand Written Generated Slope Stake Notes

There are various ways to slope stake a project, depending on which method you choose. They are listed as follows:

- **Manual Method** - Manual slope staking using a rag tape, fiberglass rod and level.
- **Conventional Method** - Slope staking using a total station and data collector, setting out the offset and distance from the design catches and then manually slope staking from this point.
- **Modified Conventional Method** - Slope staking using a total station and data collector, using the slope staking program in the data collector by inputting design templates, horizontal and vertical alignments and super elevation rates. Or by User Defined process entering pivot offset, pivot elevation and slope ratios for desired station.
- **GPS/RTK Method** - Slope staking using a base station and rovers with data collectors by loading a design Digital Terrain Model (DTM). This method slope stakes off the DTM surface and immediately calculates the catch allowing you to walk right to the actual catch point. Or by User Defined process entering pivot offset, pivot elevation and slope ratios for desired station.



### Distance From Finished Shld. to Subgrade Shld. and Slope Equivalents

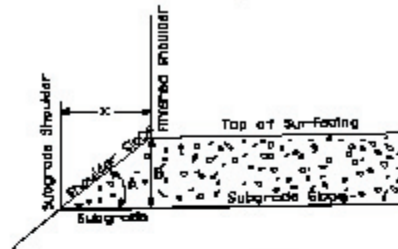

$$\text{Equation: } x = \frac{100B}{A}$$

A = Algebraic difference in % between shld. slope and subgrade slope

B = Depth of surfacing at finished shoulder

x = Distance from finished shld. to subgrade shld.

| Shoulder Slope | Equivalent Rate of Grade | Equivalent Vertical Angle |
|----------------|--------------------------|---------------------------|
| 1:1.5          | 66.67%                   | 33°41'24"                 |
| 1:1.75         | 57.14%                   | 29°44'42"                 |
| 1:2            | 50.00%                   | 26°33'54"                 |
| 1:2.5          | 40.00%                   | 21°48'05"                 |
| 1:3            | 33.33%                   | 18°26'06"                 |
| 1:4            | 25.00%                   | 14°02'10"                 |
| 1:5            | 20.00%                   | 11°18'36"                 |
| 1:6            | 16.67%                   | 9°27'44"                  |
| 1:8            | 12.50%                   | 7°07'30"                  |
| 1:10           | 10.00%                   | 5°42'38"                  |

| Subgrade Slope | Equivalent Rate of Grade | Equivalent Vertical Angle |
|----------------|--------------------------|---------------------------|
| .020 / 1       | 2.00%                    | 1°08'45"                  |
| .025 / 1       | 2.50%                    | 1°25'56"                  |
| .030 / 1       | 3.00%                    | 1°43'06"                  |
| .035 / 1       | 3.50%                    | 2°00'16"                  |
| .040 / 1       | 4.00%                    | 2°17'26"                  |
| .050 / 1       | 5.00%                    | 2°51'45"                  |

**Figure 15-2C Distance From Finished Shoulder to Subgrade Shoulder and Slope Equivalents**

See 1996 Field tables M22-24, page 13 for determining the add distance from finished shoulder to subgrade shoulder as a check for the slope stake notes.

#### 15-02.3 Manual Method

To find the catch point, first obtain the distance and elevation of the subgrade shoulder for a fill section, or back of ditch (BOD) for a cut section. This information is found on the generated slope stake notes. Next, determine the difference in elevation between the existing ground and the subgrade shoulder at that offset. Multiply the prescribed slope ratio by this difference in elevation to find the catch. If the ground is level, go to that distance and take another rod shot.

In most cases, the ground will not be level. In a fill, if the ground slopes downward away from center line, the catch will be farther out. In a cut, if the ground slopes downward away from center line, the catch will be closer in. The catch point is found by trial and error until the amount of cut or fill multiplied by the slope ratio plus the “add” distance agrees with the distance and elevation for the current rod shot.

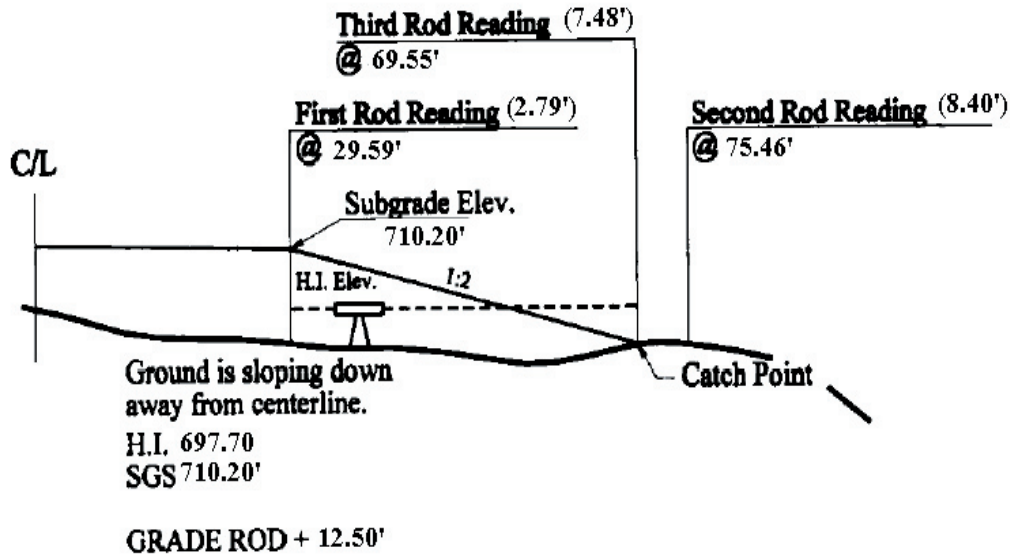

Figure 15-3 Slope stake Example

The tolerance for slope staking is 0.10 feet horizontally and vertically.

Set a slope stake at the catch. Set an offset hub and stake to the catch. For fill sections the offset is 10 feet beyond the catch and for cut sections the offset is 7 feet beyond the catch. When using a rod, level, and tape, the conversion from elevations to rod readings will expedite the staking.

From your H.I., determine the “grade rod” for subgrade shoulder (or back of ditch for a cut section). This will be the rod reading if there is zero fill (or zero cut). After taking a ground shot at the subgrade shoulder distance (SGS), subtract the rod readings. The difference will be the height of fill or cut.

The catch can usually be found after two or three trial and error shots. After finding the catches for two to three stations, it is possible to align the rod sighting through the previous stakes to eliminate much of the trial and error.

#### 15-02.4 Conventional Method

Hubs will be set at the distance from centerline at the design catches using the total station system (TSS). Hubs should be set flush with the ground. Record the elevations shot with the total station on top of the hubs. Write the elevations recorded next to the elevation shown at the design catch on the slope stake design notes. Spot check the elevations with a level and a rod throughout the area slope staked to ensure the elevations recorded from the total station system are correct. Proceed station-to-station fine-tuning the catches using a fiberglass rod and hand level to determine the cut and/or fills on the hubs and the offset. (Refer to Chapter 9, “Total Station System”).

#### 15-02.5 Modified Conventional Method

There are times when it is advantageous to use the Data Controller with a Roading-type slope staking module to set out slope stakes. Input roadway design templates, horizontal and vertical alignments, and superelevation rate data in the Data Controller before slope stake work can proceed. Applicable situations include new roadway designs with definite template ranges as opposed to roadway projects that match existing slopes. An advantage to slope staking this way is that the positions of the slope stakes are at right angles to the center line and this ensures accurate quantities for payment.

Data Controllers running Carlson SurvCE software can slope stake with the user entering pivot offsets, pivot elevations and slope ratios from our computer generated Slope Staking reports at any desired station. A customizable slope staking report in TXT or CSV format can be stored in the controller for later downloading.

In the latter case, it is impractical to input unique templates for every station and therefore manual rod and level techniques are appropriate. (Refer to Chapter 9, “Total Station System”).

**15-02.6 Global positioning System (GPS) /Real Time Kinematics (RTK) Method**

Input roadway design templates, horizontal and vertical alignments, and superelevation rate data or a DTM surface in the Data Controller before slope stake work can proceed. The GPS units read continuously and models the ground surface. The program calculates immediately where the catch point is located. The trial and error method is eliminated using GPS. (Refer to Chapter 8 “Global Positioning System”).

**15-02.7 Stake Markings**

Standard plans have been developed to establish a uniform method of marking survey stakes. This uniformity permits a consistent way of communicating the desired action and checking the Contractor progress in achieving that goal.

Using a different symbology will require documentation to assure that all parties involved understand the meaning conveyed on the survey stakes.

Data Controllers running Carlson SurvCE software can slope stake with the user entering pivot offsets, pivot elevations and slope ratios from our computer generated Slope Staking reports at any desired station. A customizable slope staking report in TXT or CSV format can be stored in the controller for later downloading.

**15-02.8 Additional Notes**

Set a second back-up offset hub and lath for line and distance to centerline only, well beyond the original offset in fill sections. Set the back-up offset hub as far back as possible staying inside of right of way. Many times the offset hubs are destroyed accidentally during the construction of the slopes and all references to centerline are lost through these areas. This additional step will prevent the crew from having to re-survey the area to re-establish centerline for grade control.

Daylighting is when the catch intersects the existing ground and “daylights”. (See Figure 15-4).

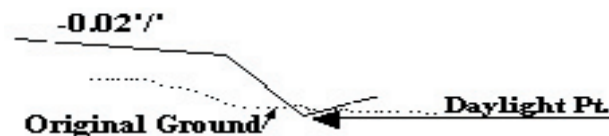

**Figure 15-4 Daylighting Example**

A ditch cut (DC) is when the natural ground elevation is lower than the ditch depth(the catch is a ditch cut).(See Figure 15-5)

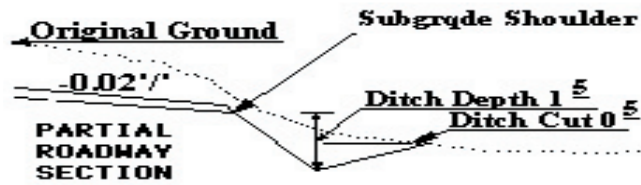

Figure 15-5 Ditch Cut (DC) Example

When “daylighting” isn’t workable because ditch water is draining toward your station, but the natural ground is still too low to obtain a full depth ditch, you might need to stake a ditch cut. The subgrade will be in a shallow fill, and the ditch depth will remain the same related to subgrade shoulder, but the catch point will be lower than subgrade shoulder. In this case, slope stake using the bottom of ditch elevation as the reference. Label the stake as ditch cut (DC) with a fill to subgrade shoulder. When the design slope rates change abruptly (ie; 6:1 to a 2:1) a gradual transition slope rate should be implemented. Make sure to blend the slopes, gradually transitioning between stations.

Where the catch is at the actual ground elevation, there is no cut, no fill at the slope stake catch. This is referred to as a “naught/naught” section, written at the top of the stake as shown in figure 15-6.



Figure 15-6

15-02.9 Grade Control

See Chapter 1-5 of the *Construction Manual*. Before any hubbing is started on the project it is “very important” to check all areas where any new roadbed construction matches into the existing pavement. An elevation check should be done using the design elevations comparing these with shots across the existing pavement to make sure no adjustments to the alignment need to be done. If this is not done and there are errors in the original design topo the crew will have to make last minute field adjustments to the vertical alignment and superelevations of the roadway. This can be avoided by simply checking these areas ahead of time.

After the roadbed is constructed as near as possible from the cut and fill stakes, the survey crew sets grade hubs and feathers for final finishing of the roadbed. There might be several sets of grade stakes required before the roadway is paved.

The first set of grade hubs usually required is for the subgrade. Stake subgrade before placement of base materials. The base might be crushed aggregates, cement treated or asphalt treated base of subgrade, or selected rock material, for example.

The subgrade hubs are referred to as “bluetops.” The most common lengths used are 8 inch and 12 inch. In most situations set bluetops every 50 feet. In order for the contractor to grade the roadbed to its true cross section, place bluetops on each break in the slope.

Set bluetops on center line and subgrade shoulder. If a broken back is required, set a hub on this line. Also, if the width between hub rows is excessive, the contractor might want an intermediate row. Do not set hubs too close together. A blade cannot work grades 10 feet apart without destroying most of them. Do not set a “forest” of hubs in an intersection that the contractor cannot possibly work between. It is best to set a few key hubs and return later if more hubs are required. Do not set loose hubs, the grade operator will remove them and the crew will be re-hubbing.

After the subgrade is completed, the base surfacing is placed at the prescribed depth. Then set hubs for base rock (“redtops”). Use the same procedure as for bluetops.

Finally, set “yellow tops” for the top course grade control. Each row of shoulder hubs will be closer to the center line by the factor: slope times

depth of surfacing course. The finish required on roadway surfacing and subgrades ensures a final grade in as close conformity to the planned grade and cross section as is practicable, consistent with the type of material being placed.

Set hubs for subgrade 0.05 feet below “grade.” Set hubs for surfacing at “grade.”

Hubs should be set in accordance with tolerances as identified in the *Construction Manual* Chapter 1-6 or as modified in the *Special Provisions* of the contract.

### **15-02.10 Procedure**

The procedure for efficient setting of grade stakes is as follows:

1. Temporary Bench Marks (TBM’s) set every 500 feet are recommended on construction projects. Run the center line.
2. Go through and set a stake at each point you intend to bluetop.
3. Drive through with the survey truck and throw out hubs at each point. 12 inch hubs are used the most.
4. Select the lengths appropriate for the soil conditions.
5. Set up the level, set the Lenker rod on the bench mark, and read the elevation. Set the rod to the elevation and check it. This involves moving the lenker rod up and down and rechecking the elevation on the benchmark. It is a good idea to mark the side of the lenker rod with a pencil mark. This lets you know immediately if it has slipped.
6. Each rod person sets the rod next to the stake and calls out the station.
7. The level person reads the rod and indicates how much up or down to grade, usually calling out the amount of cut or fill.
8. Typically, when the grade requires a Cut of 0.30’ or more a thin flat or stake is set with a line at the subgrade. A crows foot and line with the indicating arrow pointing down to the top of subgrade or surfacing, instead of driving a hub. This area will have to be re-hubbed after the contractor gets the grade closer.

## **Construction Survey Procedures**

9. The hammer person drives the hub, stopping above the indicated grade. The rod person checks and then the hammer person drives the hub to grade with light blows. Don't overdo it. It is easier to tap a hub down a few hundredths than it is to pull one up. A good set of hand signals known to all is useful.

Turn when you reach the limits of your level. Check all rods into a TBM as often as possible. After obtaining a new H.I., check the last hub set, and at the end of the day's hubbing make sure and check into a known benchmark.

GPS/RTK equipment can be used for setting out and checking grade control for creating a DTM (digital terrain model) or TTM (triangulated terrain model). The equipment will model elevations at any point on the surface DTM/TTM's.

### **15-03 Drainage**

See Chapter 7 of the *Construction Manual*.

#### **15-03.1 Culverts**

A culvert is an opening (usually a pipe) in the embankment that allows water to pass from one side to the other. Culverts are placed in valleys that would otherwise be dammed by the highway embankment.

Culverts may be concrete or metal pipe, pipe arches, or concrete box culverts. The amount of water passing through and the height of the fill determine the size and type of culvert to be installed.

If the culvert is to be constructed for a flowing stream, a channel change is usually required. The culvert is constructed on the new channel alignment and the stream is then diverted through it.

If the channel is dry at the time of construction, the contractor might be required to partially build the embankment before placing pipe.

To lay out culvert installations, perform the following steps:

1. Consult the contract plans for station and offset for ends of the installation.

You might be required to field fit culverts. If so, find the slope catch in the channel bottom for each end of the culvert.

Check the templates to be sure widening for guardrail has been included if necessary.

2. Set a hub and tack at the indicated positions for each end of the culvert. Typically we set an offset reference point 10 feet past the end of the pipe with a grade to the pipe.
3. Measure distance between hubs.
4. Set a parallel offset line at a distance convenient for the contractor. Usually 10 feet is adequate.
5. Beginning at the downstream end, set and station hubs along the offset line at 25 foot intervals. Place the beginning hub at station 0+01 or greater.
6. At the downstream end, set a second hub to ensure proper positioning of the first section of pipe.
7. Obtain elevations on all offset hubs and corresponding ground elevations at the center line of the pipe. Record on "Field Note Record for Drainage," WSDOT Form 422-637.
8. When the trench will be excavated to a depth of 4 feet or more, obtain elevations at the horizontal limits of the trench.

9. Compute the flow line grade of the culvert for each offset hub. Subtract from hub elevation. Record on the form.
10. Mark and place stakes at the hubs, recording the station, offset, code number, and cut.
11. Check all computations and check all stakes for accuracy in recording.
12. Complete the sketch on Form 422-637 along with other required data and submit to your supervisor.

### 15-03.2 Sewers

Sewers are a closed system of watertight pipes that generally begin and end in some sort of drainage structure.

Storm sewers, manholes, or catch basins are located to allow water in or out of the system and provide access for cleanout. Manholes are usually spaced at a maximum of 300 feet. Catch basins are spaced often enough to drain the roadway.

Sanitary sewers have manholes for maintenance but no other openings. In sewer design, the crowns of all pipes coincide at the center of the manhole. Therefore, water running through a small pipe into a larger pipe at a manhole will fall by the difference in pipe size.

On the drainage plan sheets of the contract plans you will find a circled number and a line drawn to each drainage structure. The plan sheet number with the circled number are the “structure note” or “code.”

The drainage profile sheets show the station, offset, flow line grade, and top of grate elevations for each installation. The top of grate elevation is for the center and is usually at the pavement elevation for manholes, and 1 inch below the pavement elevation for catch basins and grate inlets. The grates are to be set on the same slope as the pavement. Communication between the crew and the contractor is “very important” when setting elevations for top of grate inlets. Make sure the contractor and inspector know that the elevations are already set 1 inch below the pavement elevation.

Grades are critical, especially for sanitary sewers. Therefore, pay close attention to elevations.

The “structure notes” section of the contract plans tabulates the lengths, size, type of pipe, appurtenances, and any special note for each installation.

In laying out sewers, the following steps are taken:

1. Study the plans, special provisions, structure note sheets, *Standard Specifications*, and appropriate standard drawings before starting. This is most important. In studying the system you are staking, be sure to consider the whole system, not just the area you are working in. You might pick up an error on the plans before it gets constructed.

Make sure that the back edges of catch basins will be in the curb line and that manhole lids are not in the curb line.

2. Establish the locations at the center of manholes, catch basins, or any other connections by setting a guinea.

A hub and tack serves no purpose since it will get dug out. Set an offset hub at the same offset distance as for the pipe. Then set a second offset hub in line with the first. This will allow the contractor and inspector to be sure of accurate placement of the structure.

## Construction Survey Procedures

3. Compare the plan layout against the ground layout. Always pay attention to the drainage layout in the field. Does it look correct compared to the plan layout? If you suspect an error in the plans or if something looks out of place, advise your supervisor or project inspector. Do not make changes without approval. For catch basins or irregular shaped structures “*VERIFY*” design offset is to center of structure or center of grate.
4. Set RP hubs for an offset line parallel to the pipe at 25 foot intervals. It’s handy for the drainage inspectors if an offset RP hub is set at the end of second length of pipe (20’ pipe length, so put a hub at 40’). Station the hubs using 0+00 at the center of the manhole or catch basin at the lower end of the pipe.

Offset the RP’s enough to allow pipe laying and digging equipment room to work along the trench but not so far away that they are difficult to transfer to the trench. Usually 10 to 20 feet is a good offset distance, depending on the depth and size of pipe. Consult with the pipe-laying contractor and agree on the offset distance.

5. Obtain elevations on the offset hubs and ground at the center line of the pipe. Record the elevations on WSDOT Form 422-637, Field Note Record - Drainage.
6. Compute the flow line grade of the sewer at each Reference Point (RP) hub. Subtract from hub elevation and record on the form.
7. Mark and place stakes at the hubs and record the drainage code number, station, offset, and cut.
8. Check all computations and check all stakes for accuracy in recording.
9. Complete the “Field Note Record for Drainage.” One sheet is required for each drainage structure note or code. On the form, show a simple plan view and profile along with a north arrow and center line ties. On the back of the sheet, show the pipe stations at 25 feet intervals, flow line grades, ground elevations at the center line of the pipe, the elevations of the offset hubs, and the cuts from the offset hub to pipe flow line grade. The inspector completes the quantity calculations.

When completed, submit the form to your supervisor.

As in all survey work, it is easy to transpose numbers or make other blunders. Therefore, have some other qualified person check all computations and spot check instrument readings before leaving the site.

### 15-04 Structure Layout

This addresses the procedures to be followed for surveying and staking structures.

Review Section 1-5 and chapter 6 of the *Construction Manual* before proceeding.

Review the plans, specifications, and special provisions.

#### 15-04.1 Horizontal Control

For structure layout, establish a horizontal control network using second order procedures. (See Chapter 7 “Accuracy Classification and Standards”.) Place control points in strategic locations so that any point within the bridge site can be set from at least two control points. Provide control points that are substantial enough to remain in place and undisturbed for the duration of the bridge construction. A rebar and cap set in concrete can be used for these control points. “*Always*” use the same set of control points to build the bridge from one side to the other.



The next step is to establish the structure center line. Sometimes this center line differs from the line used to construct the roadway. Study the plans carefully to determine the correct line. This is not always plainly marked and it is easy to overlook some variation in the alignment. Resolve any problems before setting stakes.

Run the center line (make sure it closes within the site location) and all other controls that are pertinent to the structure.

Check distances across streams, highways, or other obstructions by use of an approved electronic distance measuring device (EDM).

Never rely on any existing station to establish pier or bridge footing locations without checking it first. Always double check all distances to all existing or proposed structure features to ensure constructibility. Errors in locating the footing might necessitate extensive revision in the design of the structure or removal of the incorrectly located foundation.

### **15-04.2 Staking**

Stake pier locations in accordance with the footing layout included in the plans. After the piers have been staked, stand back and “eyeball” the entire layout, if possible, to determine if it looks correct. Check the depth of footing compared to the ground line, cut or fill slopes, or stream bed. Take profiles along the center line of each pier or bent and at all corners for use in excavation calculations.

### **15-04.3 Vertical Control**

Set the vertical control after the horizontal control. Set temporary bench marks (TBM) in readily accessible locations where they will also be safe during construction. Extra TBMs are advisable to ensure survival.

The vertical control requirement for major structures is second order and for minor structures is third order. (See Chapter 7 “Accuracy Classification and Standards”.)

When setting TBMs for structures, remember that structures are very susceptible to settlement. Not only do the piers settle but the ground in the area of the piers can also settle. Therefore, it is essential to set a control TBM outside the area of influence so that it can be used to monitor TBMs near the structure. Settlement can occur on the day of the pour or more than a year later, so it is something that requires close attention. Settlement is common in some concrete structures. Notify the inspector and project engineer when it is detected.

Locate TBMs at each end of the structure. If the structure is very long, it might be necessary to set TBMs in intermediate locations along the structure. Consider locating TBMs in the vicinity of each pier.

### **15-04.4 Layout and References**

Stake the piers/footings at the locations shown in the plans. These may be staked directly by station and offset from the center line or from the control points established previously. Stake reference points (RP) in line with the center of the pier or footing to ensure recovery of the pier after excavation.

Consider the following concepts when setting RP’s.

## **Construction Survey Procedures**

Consider the length of time that the point must remain in a precise, fixed position and be resistant to outside forces such as traffic and frost heave. Hubs are susceptible to heave if not planted deeply enough and will weather rapidly if shattered. If not driven straight, small diameter rebar has a tendency to straighten during weather cycles. If a rock is driven along the side of a rebar to get it on line, it will only remain in that position until the next heavy rain or frost.

A 5:1 ratio from RP to deck elevation is sufficient width on structures other than lids.

Place the reference points so they are clear of other construction features and so they will not be affected by ground movements caused by large excavations or embankments. Set adequate references so that if some are lost the pier can still be easily reestablished. References are a very critical item in the layout of the structure. A little extra time spent placing good references can save time throughout the life of the project.

### **15-04.5 Checking Layout**

Have the layout of the structure and the references independently checked by a different survey crew using a different control point. Whenever possible, avoid having the same crew perform the independent check. Also have all survey notes checked by another person.

Whenever possible, determine distances by direct measurement.

The contractor will excavate for the footings. (The party chief as well as all crew members may only enter properly shored excavations. It is a safety violation to do otherwise.) Bluetop the bottom of the excavation for grade, and set the form corner hubs.

After the piers or footings have been cast, the reference hubs can be used to center and plumb the column forms and then the pier cap forms.

### **15-04.6 Superstructure**

As the contractor's work progresses to the superstructure, the survey work also continues.

For box girder bridges, the bottom deck, diaphragms, webs, and exterior walls are aligned on the plywood decking. For precast girder bridges, points are set for precise placement of the girders.

When working on structures, safety procedures for work above ground or water must be known and observed. Due to the heights involved as well as heavy materials being lifted overhead and proximity of water or traffic, the potential for injury is high. It is the responsibility of the party chief to ensure that items such as handrails are in place before the crew begins work.

The contractor will construct the forms for the roadway deck. The roadway will extend outward of the exterior walls or girders. This portion of the bridge is called a soffit or overhang. The decking forms are supported by either steel brackets or bracing against the falsework below. On the overhang decking, the line marking the edge of the roadway deck must be laid out. The elevation at each bracket/brace is observed and the soffit is adjusted until the decking is set at its predetermined elevation. This procedure is known as grading the overhang. The brackets/ bracing are usually spaced at 4 feet along the entire length of the bridge.

Only approved equipment in proper adjustment, calibration, collimation and approved rods may be used for determining elevations and grades for structures. Remember to check the TBMs from the control benches after major concrete pours and after placement of large quantities of rebar.

The interior decking forms are usually adjusted to grade after placement of the rebar so that some of the “crush” is taken up. The girders or web walls will have rebars protruding vertically from the concrete. Grade marks can be filed into the bars for each bay and adjustments are made by string lining. The screed rails are set up and the crew will grade them at each support bracket.

“Critical” areas to watch for in deck construction are errors built into structures due to expansion caused by temperature changes. In steel structures, camber built into truss spans can increase more than 1 inch on a hot day. When doing this type of work, a point can be set at mid span and then monitored throughout the day to determine what if any adjustment to apply to the layout grades. This is less obvious on concrete spans so it is easier to miss. This is probably the greatest cause of dispute when state crews are required to check grades after they are set and adjusted by the contractor. A typical scenario has the grades set in the morning when it is cool and checked in the afternoon by a different survey crew.

Perform the final survey operation after the falsework has been released. This is the grading of the top of the traffic barrier. First, the face of barrier line is established and deck elevations observed at each joint in the forms. The deck profile is plotted and top of barrier grades are determined. “Low spots” can be filled but any “high spots” in the deck will essentially be a controlling factor. The chamfered grade strip is nailed to the back form and concrete is poured to match the grade.

#### **15-04.7 Documentation**

“Field Note Records” will be required for payment of the contractor. Keep a field book record of observations, sketches, horizontal and vertical control monuments, and Height of Instrument (HI’s) for each grading operation. Also keep computer calculations and other papers. A separate field book for each structure is recommended. Turn these records over to the office engineer for safekeeping upon completion of the project.

### **15-05 Miscellaneous Construction Surveying**

#### **15-05.1 Pit Site/Quarry Site, Stockpiles, Sundry Site, and Reclamation**

##### **Pit Areas**

One of the many tasks required of survey crews is to gather field data of pit site areas for the purpose of generating quantities for the state to pay contractors.

With current surveying practices, Digital Terrain Model (DTM) data (Topographic) is gathered of the pit site area before any work is done (original ground) and then new DTM data is gathered after work has been performed (remeasure). A conventional total station system (TSS) or the GPS/RTK equipment can be used.

The contractor may request a remeasure of the pit site at a time when the work is getting close to plan quantities.

The procedure is as follows:

1. Gather crew together and discuss strategy for collecting data.
2. Set a minimum of two control points to establish a set up station and a back sight. Assumed coordinates and elevations may be used for this type of work since the object is a volume. Check with the Regions’ Pit’s and Quarries division, there may already be control in the area. It is always better to work from known control points (such as Washington Coordinate System) when available, than assumed coordinates.

### **Construction Survey Procedures**

3. Set additional control points, as necessary, to be able to Topo the entire pit site area. Locate all control points where they will not be disturbed by the work.
4. Set up a new Topo job in the data collector with a note that includes the pit site number, date, job name, and the names of crew members.
5. Gather data for DTM. It is very helpful to mark each point where a shot is taken with a paint spot so you can visually see areas where shots are needed.
6. Download, edit, backup, and create DTM. For remeasures, create a new job in the data collector and follow the aforementioned procedures taking care to pick up any terrain changes from the original ground (first DTM).

Manual cross section methods may be used instead of DTM methods. The procedures are as follows:

1. Establish a base line and reference it in a safe location so that it can be replaced after the material has been removed. Fifty foot intervals are usual but closer spacing might be necessary if the ground is very irregular.
2. Cross section the ground prior to removal of any material.
3. Establish temporary bench marks (TBM) for vertical control. Set 2 or 3 TBMs around the pit for backup.
4. On completion of the removal, or at any time an estimate is required, reestablish the base line and cross section the area. This will be the remeasure line on your notes.

### **Stockpiling**

The volume for pay quantity will be determined by computing the volume between the original ground surface and the stockpile surface using Digital Terrain Model (DTM) techniques or cross sectioning.

First study the contract plans to determine the following:

- Number of stockpiles required for various aggregates.
- Which aggregates are to be surveyed for pay quantity.
- Quantity of aggregates required in each stockpile.

An on-site review of the stockpile area with the project inspector and contractor will determine where the best stockpile locations are in relationship to the various plant operations.

1. Locate stockpile areas to ensure easy access by trucks and loading equipment.
2. Do not establish stockpiles under power lines.
3. Maintain sufficient distance between the various stockpiles to prevent mixing the various classes of materials.

The procedure for staking stockpile areas is as follows:

4. Find out how much area is available for the stockpiles. Often a scale drawing of the area will be needed.
5. From the proposed planned quantities, determine suitable dimensions for piles that will best fit into the available areas. (If stockpiles are for maintenance, check with the maintenance foreman for the best locations for their use.)
6. Lay out control points, base lines, and all corners of each pile and indicate materials to be piled at each located area.

7. Follow the procedures given for DTM technique for pit areas or, follow steps 8 through 12 below for cross sectioning.
8. Place stations along the base line at 20 foot intervals and at any points where irregular breaks in the ground require extra stations for accurate measurements.
9. Cross section the ground from the stations established along each base line. Take rod shots at 25 foot intervals and where ground line irregularities require extra rod shots for accurate measurement.
10. Set base line references in protected areas.
11. Set a TBM in a safe place. Assumed elevations can be established if an actual bench mark is not handy. Use the same bench mark for all stockpiles being constructed in the immediate area.
12. After the stockpile is complete, remeasure the pile and compute the quantity.

### **Sundry Site and Reclamation Plans**

Refer to the *Plans Preparation Manual* and the *Standard Plans for Road, Bridge, and Municipal Construction* for survey requirements.

### **15-05.2 Erosion control**

Erosion control is to preserve the erodible surfaces of our highway projects. Steep slopes are the most susceptible to erosion. Covering with topsoil then planting grass, sodding, bark mulch, plants, and trees are used for erosion control.

Measurement and payment are by area, by volume, or by actual count of such things as plants and trees. For items paid by area such as seeding, mulching, and fertilizing, measure the area to be covered.

For example: in a quadrant of an interchange, start by laying out a base line. The base line may be parallel or skewed to the highway, ramp, or crossroad. If the base line is on a skew, tie the ends to one of the control center lines.

After the base line is laid out and stationed, measure to the edges of the planting area perpendicular to the base line at 50 foot intervals or at the breaks. These measurements are made directly on the ground instead of level chaining.

Prepare a "Field Note Record", WSDOT Form 422-636EF showing the base line and center line ties and measurements to the edge of the planting area. The inspector then computes the areas for payment. An alternative is to gather a Topo of the site with a closed chain defining the perimeter of the area. Then the design software will build a DTM and build a report using the Surface Volume/Area command to provide the surface area.

### **15-05.3 Guide Post**

The locations for guide posts are shown in the contract plans. Check the *Standard Plans* and *Standard Specifications* for the distance from the edge of the pavement as it might vary in different areas. Check with the project engineer because maintenance might have some special requests as to the location of the guide posts.

In staking guide posts, usually all that is required is a stake at the location of each guide post. Sometimes a paint mark on the edge of the pavement will be sufficient. Consult with the contractor who will be doing the work.

More information can be found in the *Design Manual* Chapter 830 or the *Manual on Uniform Traffic Control Devices for Streets and Highway* (MUTCD).

### **15-05.4 Guardrail**

Study the plans, specifications, and *Standard Plans* specific to the project before beginning. This is especially important with guardrail as the design details change frequently.

Use the face of rail and top of rail as the horizontal and vertical references for guardrail.

Consult the contractor for the type of reference line needed. The contractor might want the face of rail staked, the center of post, back of the post, and so on, and usually will want the center of the bolt or the top of the post referenced for grade.

Resist the tendency to overstate guardrail. Normally, only the guardrail ends (flares and parabolas) and the tapers are staked. The following applies in most cases.

- Don't stake every post. Just stake the beginning and ending post of the straight run.
- In most situations, a reference hub every 50 feet is adequate.
- On sharp horizontal or vertical curves, you might need a hub every 30 feet.
- On tight radius curves, you might need hubs at 10 feet.
- A hub and tack is usually used to mark line and grade.
- Only stake every post in special areas where the situation requires exact placement.
- If the contractor wants the center or back of the post staked, locate the hubs between posts.
- If the contractor wants the face of the rail staked, it is not necessary to keep the hubs between the posts.

Do not level chain as the rail has a finite length that follows the slope of the road.

### **15-05.5 Fencing**

The locations for fencing are given in the contract plans or the special provisions.

Consult the project inspector and the contractor for the type of reference line.

The following will apply in most cases:

- Stake the pull points, gate post, corner post, and end posts.
- For all types of fence, a change in alignment of 2 feet tangent offset, or more, for the next post is considered a corner.
- Stake all fence 1 foot inside Right of Way, unless directed otherwise.

More information can be found in *Design Manual* Chapter 1460.

### **15-05.6 Illumination and Traffic Signals**

First study the plans, specifications, and standard drawings. The locations are given in the contract plans. A visual check of the site is needed to ensure that the location is suitable.

See the plans for the location and the height of the luminaire. A cross section is necessary at that section of roadway to determine the base elevation. "*Double check*" the cross section elevations, subgrade shoulder and existing ground elevations to the top of the luminaire base to make sure the placement is correct. There is a limit to the amount of adjustment the contractor can make if it is set too low and if it is set too high it may have to be re-set.

Stake the center of the base for line and grade. The stake for the center will be destroyed during excavation and must, therefore, be referenced. Locate the reference points outside the excavation area, but near enough to be useful to the contractor. Show the offset distance, cut or fill to the top of the luminaire base, and stationing on the stakes.

Stake the conduit runs according to the plan or as directed by the project inspector. A paint line will generally be adequate for the conduit, but consult the project inspector and the contractor for their needs.

Stake and reference the junction boxes. See the plans for the location.

Locate service cabinets and reference them to line and grade.

When staking illumination, good communication with the project inspectors is needed. The survey crew must be aware of their needs and aware of any changes that are necessary.

Good communication between the crew and inspector will aid the crew in determining what is needed.

More information can be found in *Design Manual* Chapters 840 and 850.

### **15-05.7 Signing**

#### **Steel Sign Supports**

Study the plans, specifications, and standard drawings. The following procedure usually can be followed:

1. Locate the site of the sign. It will be given on the plans but you will have to check it for visibility.
2. Take a cross section at the sign location. Include the edge of the traveled way in the section.
3. Set hubs at the footing locations with references to the top of the footings.

With this information the exact post length can be computed, and the sign can be installed later. Unless your reference hubs are lost, no other staking is usually required.

On sign bridges and large cantilevered signs that have electric power to them, you will have to also locate and stake the conduits. Follow the plans and try to locate the conduits outside the pavement area if possible.

#### **Miscellaneous Signing**

The locations for these facilities are given in the contract.

All that is required for wood sign posts is the location by station and the offset. The required heights and other details are given on the plans and are the responsibility of the contractor.

More information can be found in *Design Manual* Chapter 830 or the *Manual on Uniform Traffic Control Devices for Streets and Highway* (MUTCD).

### **15-05.8 Pavement Marking**

Review the contract plans and special provisions, *Standard Specifications*, and *Standard Plans* prior to laying out pavement marking.

Prior to layout, meet with the contractor to determine the intervals required for layout marks. Once layout is complete, the contractor completes preliminary spotting prior to pavement marking.

## **Construction Survey Procedures**

Center line is generally used as the control points for pavement marking although use of an offset is acceptable. Lay out all the pavement marking from the same control to maintain correct spacing and lane widths. Paint marks are typically used when establishing control and for layout.

### **Center Line**

Mark center lines with paint.

### **Curves**

Use a total station and set the curve points or use a 300 ft or longer cord, eyeball in a curve, and paint over it. By doing the tangents first, it will make the transitions to curve look better when you eyeball in a curve.

When laying out the initial paint marking use very small preliminary dabs until you verify the plans are correct. At times there can be errors in the plans and recalculation may be needed on lane tapers, stationing etc. Visually check dabs looking back and ahead on line making sure it looks correct. If the crew finds an error and corrects it, use black paint to cover the preliminary dabs. Always inform the project inspector or the project engineer when finding an error.

### **15-05.9 Concrete Curb**

When staking concrete curb, check the plans carefully to determine the correct location and grade.

Since the face of the curb is battered and the back of the curb is plumb, the best control point for line and grade is the top and back of curb.

Set hubs and tacks at 30-foot intervals on a 3 foot offset line to the back of curb. On radius curves of 50 feet or less, space hubs and tacks at 10 feet or less as needed.

Run levels on the hubs and determine the difference in grade from the hubs to the top of the curb. Prepare stakes showing the difference as a cut or fill and the offset. Flagging on the stakes is not necessary.

“Always” check any new curbs elevations that are being tied into existing/new pavement (such as a grind and inlay with different surfacing depths up to finished, etc.). Just because the plan profiles show elevations at top of curb does not mean that they are error free. Check by calculating the measure up at centerline from the subgrade or existing surfacing, across what will be the finished roadway at the proper super to the new curb elevation making sure it is correct.

Prepare a “Field Note Record”, WSDOT Form 422-636EF, showing the plan view of the curb line along with the length staked.

### **15-06 WSDOT Standard Color Codes**

Some standards apply to all construction phases. Follow the standard color codes for survey ribbon and spray paint to ensure uniformity and minimize confusion.

#### **Color Code for Spray Paint**

It is desirable to conform to the WUCC/APWA/ULCC standard color codes for utilities. “White” is acceptable for stationing along the paved shoulder. “Pink” is the accepted color for all other survey markings per the national standard utility color code list.



### Flagging Color Code for Construction Stakes

It is desirable to have a uniform color code system throughout the state so the contractor's personnel will be able to readily recognize the work item referenced.

Whenever flagging is necessary on the project, use the following flagging colors:

| Activity                 | Flagging Color            |
|--------------------------|---------------------------|
| Clearing and Grubbing    | White                     |
| Right of Way             | Red                       |
| Slope Stakes             | Blue                      |
| Center line              | Yellow                    |
| Drainage                 | Blue                      |
| Signing and Illumination | White                     |
| References and Control   | Multicolor                |
| Selective Thinning       | Orange (for tree removal) |
| Trees Remaining          | Blue                      |

### 15-7 Post Construction Survey

See Chapter 16 "*Monumentation and Survey Records*" for guidelines on location, placement and types of monuments and documentation needed for your project. It is vital that a post construction survey be performed on projects to ensure that associated documentation and monumentation are accurate and up to date.

### 15-8 Equipment Table

#### 15-08.1 Equipment

The ideal rod to use is the Lenker or self-reducing type. Grade rods do not have to be computed as with the Philadelphia rod. The Lenker enables you to read the elevation directly on the rod with no computations required. For example, the TBM elevation is 127.68. The rod is set on the TBM and the rod person adjusts the tape until the level person reads 7.68 and then locks the tape in place. If the elevation of the bluetop is to be 125.15, then the hub is driven until the level person reads 5.15 on the rod and no computations are required.

If you use a Philadelphia rod however, the following computations are required: The TBM elevation is 127.68. The level person reads 5.06. The HI is then 132.74. The grade elevation (125.15) is subtracted from the HI (132.74) to yield a grade rod of 7.59. Thus, when the hub is driven so the level person reads 7.59, the hub is at grade. Grade rods have to be computed for each hub set.

A 12 lb hammer is a good all around size for driving the hubs. A lighter hammer requires too many blows to drive a hub into a well compacted grade, which is tiring and increases chances the hub will be shattered. The heavier the hammer the better. Skill with a hammer is the controlling factor in the speed at which the crew can work. A pick and shovel are necessary tools when the grade is a little high. Digging below grade before driving the hub makes the hub easier to drive. Placing centerline Cuts and Fills is a very good interim step between slope stakes and bluetopping. If the grade is consistently high or low, halt operations and inform the inspector. If the grade is suspected of not being close, spot check it before setting up operation. Painting, on the ground, the amount high or low might save time in the long run.

**Construction Survey Procedures**

A small pruning saw can save much time and work in some situations. In a very hard grade, often the hub will go so far and then bind up. The hub will shatter before getting to grade. If the hub is solid, saw it off at grade. The alternatives are: keep pounding and if the hub shatters set another; remove the hub and drive a frost pin to provide a hole for the hub; or insert another hub into the shattered hub, driving it down to the elevation needed (this method prevents loose hubs). Periodically have the hammered end of the frost pin cut off. Do not use a mushroomed tool.

| Equipment Table                        | CLEARING AND GRUBBING | SLOPE STAKING - TRADITIONAL | SLOPE STAKING CONVENTIONAL | SLOPE STAKING MODIFIED CONVENTIONAL | SLOPE STAKING - GPS/RTK | GRADE CONTROL | DRAINAGE AND CULVERTS | SEWERS | STRUCTURE LAYOUT | PITS, QUARRIES STOCKPILES- TRADITIONAL | PITS, QUARRIES STOCKPILES- CONVENTIONAL | PITS, QUARRIES STOCKPILES- GPS/RTK | GUIDEPOSTS | GUARDRAIL | FENCING | ILLUMINATION | SIGNING | PAVEMENT MARKINGS | CONCRETE CURB |
|--|-----------------------|-----------------------------|----------------------------|-------------------------------------|-------------------------|---------------|-----------------------|--------|------------------|--|---|------------------------------------|------------|-----------|---------|--------------|---------|-------------------|---------------|
| <b>Crew Size</b>                       | 2                     | 4                           | 3                          | 3                                   | 2                       | 3             | 2                     | 2      | 3                | 3                                      | 2                                       | 2                                  | 1          | 2         | 2       | 2            | 2       | 3                 | 3             |
| Field Book - WSDOT Field Forms         | •                     | •                           | •                          | •                                   | •                       |               |                       |        | •                | •                                      | •                                       | •                                  |            |           |         |              |         |                   | •             |
| Computer Data Sheets                   |                       |                             |                            |                                     |                         | •             |                       |        |                  |  |   |                                    |            |           |         |              |         |                   |               |
| Calculator                             | •                     | •                           | •                          | •                                   |                         | •             | •                     | •      | •                |  |   |                                    |            |           |         |              | •       | •                 | •             |
| Spray Paint                            |                       |                             |                            |                                     |                         |               |                       |        | •                |  |   |                                    | •          |           |         | •            | •       | •                 | •             |
| Colored Flagging                       | •                     | •                           | •                          | •                                   | •                       |               | •                     |        |                  |  |   |                                    |            |           |         | •            | •       | •                 | •             |
| Marking Pen                            | •                     | •                           | •                          | •                                   | •                       |               |                       | •      | •                | •                                      |   |                                    | •          | •         | •       | •            | •       | •                 | •             |
| Fiberglass (Rag) Tape                  | •                     | •                           |                            |                                     |                         | •             | •                     | •      | •                | •                                      |   |                                    |            | •         | •       | •            | •       | •                 | •             |
| Hammers (Several Sizes)                | •                     | •                           | •                          | •                                   | •                       | •             | •                     | •      | •                | •                                      |   |                                    | •          | •         | •       | •            | •       | •                 | •             |
| * Total Station System (TSS)           |                       |                             | •                          | •                                   |                         |               |                       |        | •                |  | •                                       |                                    |            |           |         |              |         | •                 | •             |
| Level with Tripod                      |                       | •                           |                            |                                     |                         | •             | •                     | •      | •                | •                                      |   |                                    |            |           |         | •            | •       | •                 | •             |
| Level Rod (Philadelphia, Lenker, etc.) |                       | •                           |                            |                                     |                         | •             | •                     | •      | •                | •                                      |   |                                    |            |           |         | •            | •       | •                 | •             |
| Hand Level                             |                       | •                           | •                          | •                                   |                         |               |                       |        |                  |  |   |                                    |            |           |         |              |         |                   | •             |
| ** GPS/RTK Equipment                   |                       |                             |                            |                                     | •                       |               |                       |        |                  |  |   | •                                  |            |           |         |              |         |                   |               |
| Pick                                   |                       |                             |                            |                                     |                         | •             |                       |        |                  |  |   |                                    |            |           |         |              |         |                   |               |
| Shovel                                 |                       |                             |                            |                                     |                         | •             |                       |        |                  |  |   |                                    |            |           |         |              |         |                   |               |
| Frost Pin                              | •                     | •                           | •                          | •                                   | •                       | •             | •                     | •      | •                | •                                      |   |                                    | •          | •         | •       | •            | •       | •                 | •             |
| Hubs, Guineas, Stakes, Lath, Thins     | •                     | •                           | •                          | •                                   | •                       | •             | •                     | •      | •                | •                                      |   |                                    | •          | •         | •       | •            | •       | •                 | •             |
| Feathers (variety of colors)           |                       |                             |                            |                                     |                         | •             |                       |        |                  |  |   |                                    |            |           |         |              |         |                   | •             |
| Pruning Saw                            |                       |                             |                            |                                     |                         | •             |                       |        |                  |  |   |                                    |            |           |         |              |         |                   | •             |
| Walkie-Talkie Radios                   |                       |                             | •                          | •                                   | •                       |               |                       |        | •                |  | •                                       |                                    |            |           |         |              |         | •                 | •             |
| Cup Tacks                              |                       |                             |                            |                                     |                         |               | •                     |        | •                |  |   |                                    |            | •         |         |              |         |                   | •             |
| Pocket Tape                            |                       |                             |                            |                                     |                         |               |                       |        | •                |  |   |                                    |            |           |         |              |         |                   | •             |
| Umbrella                               |                       |                             |                            |                                     |                         |               |                       |        | •                |  |   |                                    |            |           |         |              |         |                   | •             |
| *** Survey Vest and Hard Hat           |                       |                             |                            |                                     |                         | •             |                       |        | •                |  |   |                                    |            |           |         |              |         |                   | •             |
| *** First Aid Kit                      |                       |                             |                            |                                     |                         | •             |                       |        |                  | •                                      | •                                       | •                                  |            |           |         |              |         |                   | •             |
| *** Eye and Ear Protection             |                       |                             |                            |                                     |                         | •             |                       |        |                  | •                                      | •                                       | •                                  |            |           |         |              |         |                   | •             |

NOTES:

- \* See Chapter 9
- \*\* See Chapter 8
- \*\*\* See Chapter 2

**Figure 15-7 Suggested Equipment Table**

**16-01 Monumentation and Survey Records**

The placement of markers or monuments in the ground is used for a variety of purposes. One of the more common purposes is to mark the corner locations of property ownership. In transferring a particular parcel of real property, written conveyances are used to describe the outer bounds or limits of that parcel. An ancient ritual known as the *livery of seisin* (delivery of possession), had the seller, purchaser and witnesses meet on the property, walk the perimeter or bounds of the parcel and then memorialize the contract by handing over a handful of dirt, twig, driving stakes into the ground or other act while uttering the words “I give,” to bind the conveyance.

Today, the transfer of real property does not have the same fan fare of the *livery of seisin* ritual but the acts of the ritual are still incorporated into our real property transfer laws. Deed documents, written descriptions, physical markers or monuments left by the owner or their land surveyor are evidence of the transfer of ownership (*I give*). Much of today’s real property has been segregated into smaller parcels by written description only. To aid in defining the location of the larger and smaller segregated parcels, land owners and land surveyors have placed markers as a witness corner of the parcel(s) being transferred. Often times these markers or monuments define a different geometry than the written description the monuments are supposed to be defining.

The written conveyances often have errors or described lines within the body of the description that could impact the intent of the geometry or area of a particular parcel. Thus the purpose of the survey monument and Record of Survey/Monumentation Map document is to aid WSDOT and others using this information in defining the location of WSDOT’S right of way and other land holdings.

**16-02 Monumentation and Survey Records**

Examples of monuments are brass caps, brass plugs, marked stones, iron pipes, lead plugs with tacks, wooden hubs with tacks, railroad spikes with punch marks, finishing nails or brass screws in fence posts, PK nails, concrete posts, reinforcing bars with plastic or aluminum caps and holes drilled in rocks. Monuments set by government agencies are identified by an official designation on the monument.

Monuments can be divided into five groups.

1. Geodetic control - usually set by government agencies.
2. Public Lands Survey System (section and quarter section corners, witness corners, meander corners) – originally set by government surveyors from the General Land Office (GLO).
3. Highway, road, and street alignment – usually set by government agencies.
4. Monuments used to define the location of highway or utility company rights-of-way – set by government or private surveyors.
5. Property corners – usually set by private surveyors.

### **16-03 Geodetic Control Monuments**

Generally, control monuments are classified as either primary or secondary. A control monument can be used for horizontal position, vertical position, or both.

Monuments set by other agencies can be used if they are in a desired location. For example, an existing U. S. Geological Survey benchmark could be used for a horizontal control monument. Specifications for horizontal and vertical control monuments shall meet the standards of the Federal Geodetic Control Subcommittee (FGCS) of the Federal Geographic Data Committee (FGDC).

For safety reasons, control monuments should be placed as far away from traffic danger as possible. They should be set firmly in the ground with considerations as to the possibility of frost heave or ground settling. See Standard Plan H-6 for monument installation. WSDOT maintenance requests that the monument be set flush with the ground surface so it will not interfere with their on-going weed control program. When field conditions permit, monuments can be cemented into drilled holes of solid rock or concrete structures. The terrain of each project will dictate the spacing of the control monuments (see Monument Spacing “ in Chapter 7). Placing a witness post (flexible guide post) near the monument helps find it again at a later date and tends to protect it from accidental destruction. Attach a standard label that states: “Please Do Not Disturb Nearby Survey Marker”.

When writing the station description, include information on how to reach the general location of the monument from some prominent feature such as a junction of two highways. Include the location by section-township-range and by State Route and milepost. Relate the monument to at least three nearby permanent objects by distance and direction and describe the specific details of the monument including any stamping or lettering. This data will be incorporated into the “Report Of Survey Mark” document. When completed, this report is then added to the WSDOT Survey monument Database.

### **16-04 Horizontal Control Monuments**

Horizontal control monuments, whether primary or secondary, must be referenced to the NAD83/91 metric coordinate system of the Washington State Coordinate System.

Primary horizontal control monuments must be tied to the High Precision Network (HPN). Primary horizontal control monuments are normally measured by using the Global Positioning System (GPS). If GPS is not used or is not practicable, then conventional means must be used to establish primary control that is tied to the HPN using procedures and equipment meeting second order class II FGCS specifications.

Secondary control, designed to supplement the primary control, is used for photogrammetry and right of way surveys, to provide the basis for topography, or the layout of alignments and structures. Secondary horizontal control monuments must be tied to the primary horizontal control monuments by a traverse or GPS methods using procedures and equipment meeting third order FGCS specifications.

Wherever possible, when setting horizontal control points, place another horizontal control point to act as an azimuth point. Place it so that development in the area will not block the line of sight and in an area that is unlikely to be disturbed by impending construction.

When setting brass caps for horizontal control, position the cap facing approximately “North” using a compass.

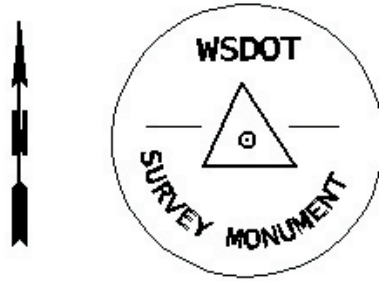

Figure 16-1 Horizontal / Vertical Control Cap

### 16-05 Vertical Control Monuments

Vertical control monuments must be measured in the metric NAVD88 system. Primary vertical control monuments must be tied to National Geodetic Survey (NGS) bench marks by using equipment and procedures meeting second order FGCS specifications (Chapter 5).

Secondary vertical control, designed to supplement the primary control, is established throughout the project to provide the basis for topography, the layout of grades and structures, or photogrammetry. Secondary vertical control monuments must be tied to the primary vertical control monuments by using equipment and procedures meeting third order FGCS specifications.

### 16-06 Public Land Survey System Monuments

During the latter portion of the 1800's, the public lands of Washington were surveyed and monumented so that settlers could obtain a "patent" and establish property for private ownership. The monuments which represented a variety of sectional corners (refer to the Bureau of Land Management "Manual of Instructions") were originally set by surveyors from the General Land Office (GLO). Over the last 100 years, either government or private surveyors have perpetuated many of the monuments.

During the course of typical WSDOT projects, sectional corner monuments are often subject to disturbance by construction activities. Several Washington State laws address the procedures and requirements for monument restoration. . See *WAC 332-120-040* for more information.

It is the agency's responsibility to make a prudent search, locate and reference all existing General Land Office corners within the highway margins for perpetuation. All General Land Office corners existing at the time of construction will be replaced by state forces, their assign or the contractor on site if disturbed by construction activity.

Also, *RCW 58.09.130* outlines the procedures and requirements regarding monuments disturbed by construction activities. The law states that whenever practical, a suitable monument shall be reset in the surface of new construction. In all other cases, permanent witness monuments shall be set to perpetuate the location of preexisting monuments.

A minimum of two durable witness monuments along with corresponding Washington State Plane Coordinates for each are established when it is deemed unsafe to replace a monument in the traveled portion of any highway.

**16-07 Alignment, R/W, and Property Corner Monuments**

Monuments in this group control the location of constructed highway alignments, utility easements, and private property ownership. Several State laws address the procedures for monument removal and restoration.

Washington Administrative Code (*WAC 332-120*) pre-scribes the procedure for obtaining a permit from the Department of Natural Resources (DNR) to remove a monument.

The purposes of the regulations are:

- To set standards for the work,
- To establish a chain of evidence on the replacement of an original monument, and:
- To ensure that the work is done by qualified personnel who know the correct procedure.

Before removing a monument, the owning agency should be contacted to coordinate the work. Some agencies may prefer to do the removal and replacement themselves. This particularly applies to horizontal and vertical control monuments belonging to U.S. Government agencies.

The documentation consists of:

- Application for a permit, explaining the necessity for removal.
- Permit approval.
- Report on the removal and what was used for replacement.
- Land Corner Record; used when a section corner, quarter corner, street monument, or other point, which is used for locating property lines, is established or replaced and is not reported on some other recorded map or survey. This establishes a chain of evidence which can be used later to prove the genuineness of the monument at that point.

See the *Design Manual, Chapter 1450* for examples of paperwork for permits to temporarily remove or destroy monuments. When monuments are set for a new project or to replace

old monuments, they should:

1. Be of a permanent nature,
2. Be clearly identified as to who set them,
3. Be referenced to other points so they can be easily reset if disturbed or destroyed,
4. Be filed with the Department of Natural Resources, and with the county auditor or county engineer, depending on legal requirements, so there is a public record of the location and references, and
5. Be located on the Washington coordinate system so they will extend the survey network in this state.

If a monument is offset from the point that it is intended to represent, the record must show the offset and direction between the point and the monument. For example, the base line for a highway may lie along the center of the paving, while the monumentation for the base line may be located in the shoulder.

Public knowledge of the location of the monuments and their relation to the point that they represent will eliminate many problems that have occurred in the past where monuments were destroyed and there was no public record that showed references to remaining points.

## **16-08 Documentation**

The best evidence of a monument's original position is a continuous chain of history by acceptable records, usually written, back to the time of the original monumentation. As part of this, WSDOT surveyors must contribute to the body of public records by documenting monument work appropriately and by striving to preserve and perpetuate existing monuments.

Monuments set by a public officer shall be marked by an official designation. Prior to the "Survey Recording Act" ( *RCW 58.09* ) in 1973, many surveyors did not mark their monuments, so it is sometimes difficult to determine whether an object is a monument or not.

*RCW 58.09.120* requires that any monument set by a land surveyor be permanently marked or tagged with the certificate number of the land surveyor setting it.

Deeds have a chain of title back to their inception, and the validity and correctness of a deed is based upon these records. Similarly, monuments should have a continuous chain of history. The original surveyor sets a stone mound for the section corner. Surveyor number two finds the stone mound and sets a 2-inch iron pipe. Surveyor number three finds the 2-inch pipe and sets reference points 30 feet on each side of a new proposed road. Surveyor number four finds the reference monuments and resets the true section corner in the center line of the new road. Surveyor number five finds the new monument in the center line and wants to prove its identity and the correctness of its position. How can he without a continuous record of what each surveyor did? This is the reason that Washington has a law making it mandatory to file a record of survey under certain circumstances.

*RCW 58.09.120* requires that any monument set by a land surveyor be permanently marked or tagged with the certificate number of the land surveyor setting it.

Monuments set by a public officer shall be marked by an official designation. Prior to the "Survey Recording Act" ( *RCW 58.09* ) in 1973, many surveyors did not leave identifying caps or tags on their monuments, so it was sometimes difficult to determine whether an object is a monument or not.

History or chain of record for monument position is valuable evidence, but all too often there is an interruption in the history, and a continuous chain of records cannot be proven.

Many disputes have been caused because a monument was not properly identified when it was set or because its replacement was not properly identified and marked. Accidental or deliberate destruction of a monument can lead to long and expensive disputes about where it was originally located.

It is therefore essential that, if an existing monument must be disturbed for any reason, its present location must be accurately referenced with modern equipment and methods so that it can be replaced in its old position, or its location accurately determined if it cannot be replaced for some reason.

Presently, WSDOT is documenting the right-of-way alignment of a State Route by the use of a Record of Survey or Monumentation Map. This map shows all of the survey data and ties to the PLSS monuments, county road or city street intersection points, private survey corners, and other pertinent geodetic control markers. The purpose of

## **Monumentation and Survey Records**

this map is to document how the right-of-way alignment was established using all of the available information. The Monumentation Map shows direct ties or station and offset to all survey markers. Any global positioning points established in the area are directly tied to the right-of-way alignment. Ownership information is not shown on this map. The main purpose is to establish the right-of-way centerline and determine its relationship to the other survey control points. A narrative discussing the procedure used and problem solving methods is a part of this document. This map is filed with the County Engineer's office, at the WSDOT Regional office, WSDOT Headquarters office in Olympia, and at the Department of Natural Resources in Olympia. It is a document used by both WSDOT and the general public. This map is prepared on all new projects that have right-of-way or alignment issues. As new projects are being developed, this monumentation map will be a vital tool in establishing and reestablishing the right-of-way centerline alignment.

### **16-09 Post Construction Monumentation**

The post construction survey serves several purposes:

1. It establishes coordinates and elevations for the monumentation set by the contract.
2. It provides the necessary data for making a Monumentation Map, or updating the map made prior to construction.
3. It establishes a permanent base line from which the right of way line and right of way base line can be reestablished.
4. It establishes a base line for future projects in the area.
5. It enables WSDOT to comply with *RCW 58.09 (Survey Recording)* and *58.20 (Washington Coordinate System)*.
6. It provides a permanent record of how the survey measurements to determine monument location were performed.
7. It documents which monuments were removed, destroyed, replaced, or set within the project limits during construction.

When placing monuments after construction, the following criteria should be considered:

- Monument location should be accessible after construction.
- Monuments should be intervisible and not liable to have the line of sight blocked by brush, trees, or future construction.
- Monuments should be set back from the traveled roadway as far as possible and still meet above requirements.

The procedure is:

1. Designate location of each monument by station and offset on the contract plans. Construction personnel shall not change the location without approval by the location personnel.
2. Include as contract items the installation of monument case and cover (in paved areas), poured-in-place concrete (in unpaved areas) or drilled hole (in rocky areas).
3. If the actual setting of the monument is done by a WSDOT crew, cement the disk inside the pipe, set in the freshly poured concrete or cement into the drilled hole, as applicable. If the monument is to be set by the contractor, furnish WSDOT disks to the contractor. Stamp each disk with the predetermined monument marking before it is set.



4. Mark the location on the ground where the contractor is to install the monument case and pipe, pour the concrete, or drill a hole. The location of the control point shall be within 0.01 feet of the specified location as shown on the contract plans. If the contractor installed the monument, verify that it was set to this specification.
5. After completion of construction, perform a survey meeting secondary control specifications on all new monuments.
6. Prepare a Monumentation Map showing the location of each monument set by its station and offset referred to the right of way base line, together with its state plane coordinates. The Monumentation Map shall be signed and sealed by the person responsible for the survey.
7. If the surveying of the contract is being done as a contract item, the contractor is responsible for engaging a licensed land surveyor to perform this work.

Survey Documentation of survey activity is very important. It allows field crews and offices to share information without having to survey the same areas more than once. The final documentation of survey data allows the design team and other groups within the agency to use the same data for their own particular purposes. These guidelines should be used during the scoping phase of the project to determine preliminary survey cost estimates.

## **16-10 Guidelines For When A Survey Document is Prepared**

### **16-10.1 What is a survey document?**

A survey document could be a number of items but the common documents for which this guideline is prepared for are:

1. Record of Survey
2. Monumentation Map Type 1 or Type 2
3. Application for Permit to Remove or Destroy a Survey Monument
4. Land Corner Record

What determines a need for preliminary land survey work or monumentation inventory?

Preliminary land survey work is required if the proposed construction activity is not clearly within the limits of our existing right of way.

A monumentation inventory is required if the proposed construction activity will physically impact the existing survey monuments. (See “What are WSDOT’s Responsibilities of Maintaining a Monument”)

### **16-10.2 What is a preliminary land survey?**

A preliminary land survey is intended to be part of the Scoping Package. The purpose of the survey is to provide cost estimates for survey labor, documentation (mapping) and monumentation for a specific project. This survey will help determine, at the scoping phase rather than midway through the project, the need for: preparing new or revising existing right of way plans, Record of Survey or type of Monumentation Map, and / or other survey documents.

A preliminary land survey reviews existing survey documents and right of way plans located at WSDOT or the county auditor’s office, etc., locating existing survey monuments in the field, and making field checks to determine if the information is reliable and consistent, and creating a preliminary right of way centerline. (See “What does a Preliminary Land Survey consist of?” on page 8.)

## **Monumentation and Survey Records**

Who is qualified to do preliminary land surveys?

Preliminary land surveys will be performed under the direct supervision of a licensed professional land surveyor, or licensed professional engineer experienced in the practice of land surveying, in accordance with the survey standards promulgated under Chapter 332-130 WAC.

### **16-10.3 What does a monumentation inventory consist of?**

A monumentation inventory consists of document research and fieldwork to find the monuments, determining ownership of them, and identifying what they represent.

A monumentation inventory should be performed during project scoping.

### **16-10.4 What determines a need for a Record of Survey or Type 1 Monumentation Map?**

A Record of Survey or a Type 1 Monumentation Map is not necessarily required just because WSDOT is acquiring property.

If a new right of way plan is being prepared, one of these survey documents will always be required. The document will show the existing right of way alignment.

If revisions to the existing right of way alignment are being planned, a Record of Survey or a Monumentation Map Type 1 will be prepared of the existing right of way alignment. The Type 1 Monumentation Map is actually an analysis of the centerline alignment. This will define or prove the existing alignment while providing a foundation for the new alignment. In most instances, it is recommended that the existing right of way alignment be retained as the right of way centerline though the construction centerline may change to meet the needs of the project. Those projects that necessitate having a new right of way alignment will include both the existing and the new right of way centerline with station equations at both diversion and conversion points to the existing alignment. This document will be a part of the package presented for Right of Way Plan approval and adoption.

Then a new document will be prepared as a Post Construction Survey Document to show any revisions and ties back to the existing alignment.

If the determination is made (from the preliminary land survey) that the alignment ties are reliable and verified in the field, then a Record of Survey or Type 1 Monumentation Map is not required and the existing right of way plans can be utilized subject to Section 180.01 of the Plans Preparation Manual.

If, during the preliminary survey, it is discovered that the cadastral ties shown on the existing right of way plans are not reliable, then additional research and an economic risk analysis should be done. The design team, with the help of the designated land surveyor and real estate services personnel, will do this analysis. This analysis will determine if the Record of Survey or Type 1 Monumentation Map will identify and/or eliminate present or future ownership rights problems. If the risk is low, with little ownership rights issues or great monetary issues, then a Monumentation Map or Record of Survey is not required. The cadastral tie(s) should be changed on the existing right of way plan.

If, during the preliminary survey, it is discovered that the alignment centerline monuments are not on the right of way centerline, or if unclear what they are intended to represent, then a Record of Survey or Type 1 Monumentation Map is required.

If the cost of preparing the necessary survey document far outweighs the cost of the right of way to be acquired or the cost to remedy present or future problems, a survey document is not required. Before the decision is made to not prepare a survey document, always consult with the region's Cadastral Engineer or designated Land Surveyor.

A Record of Survey will be certified by a Professional Land Surveyor and filed with the county auditor's office in the county where the project resides.

A Type 1 Monumentation Map will be certified by a Professional Land Surveyor or a Professional Engineer, with surveying background, i.e. competent in the technology and knowledgeable of the codes and regulations applicable to land surveying (See *WAC 196-27A-020* and *RCW 58.09.09*), and filed with the county engineer's office, or as instructed by the county engineer, in the county where the project resides.

#### **16-10.5 What determines the need for a Type 2 Monumentation Map?**

A Type 2 Monumentation Map is required whenever alignment monuments are being removed, destroyed and not replaced, or new monuments are being established by WSDOT and a Type 1 Monumentation Map or Record of Survey is not being prepared. Examples why new monuments might be established are:

- Monuments are difficult to use due to location within traffic;
- Monuments will be destroyed by the construction activity;
- Monuments are becoming inaccessible due to construction;
- Monument spacing is too great or additional control is required.

A Type 2 Monumentation Map may also be prepared as a method for identifying and preserving monuments during a highway construction project. Washington State Plane Coordinates are used to designate the location of monuments and control in lieu of stations and offsets as with the Type 1 Monumentation Map.

A Type 2 Monumentation Map will be certified by a Professional Land Surveyor or Professional Engineer, with surveying background, i.e. competent in the technology and knowledgeable of the codes and regulations applicable to land surveying (*WAC 196-27A-020*) and filed with the county engineer's office, or as instructed by the county engineer, in the county where the project resides.

#### **16-10.6 What determines a need for a Record of Survey on Sundry Site Plans?**

Partial Takes: A Record of Survey will be required. This will help in the parcel split for the county assessor and ensure proper property line location and approval from the Grantor.

Generally, total takes will not require a Record of Survey. However, other issues will need to be taken into account in making this determination (i.e., abandoned railroad and county road rights of way; obvious and potential encroachments; an ambiguity in the deed). If any of these conditions exists, then a Record of Survey should be prepared in an effort to prevent future ownership problems.

#### **16-10.7 Who is qualified to prepare the Application For Permit to Remove or Destroy a Survey Monument?**

Both licensed engineers, i.e. competent in the technology and knowledgeable of the codes and regulations applicable to land surveying (*WAC 196-27A-020*) and land surveyors are qualified for preparing this document. A recent letter from the Board of Registration gave us this reminder:

## **Monumentation and Survey Records**

“Anyone performing construction or maintenance activities should consider the following:

1. No survey monument shall be removed or destroyed (*the physical disturbance or covering of a monument such that the survey point is no longer visible or readily accessible*) before a permit is obtained from the Department of Natural Resources (DNR). *WAC 332-120-030(2)* states, “It shall be the responsibility of the governmental agency or others performing construction work or other activity (including road or street resurfacing projects) to adequately search the records and the physical area of the proposed construction work or other activity for the purpose of locating and referencing any known or existing survey monuments.” (*RCW 58.09.130*).

Any person, corporation, association, department, or subdivision of the state, county or municipality responsible for an activity that may cause a survey monument to be removed or destroyed shall be responsible for ensuring that the original survey point is perpetuated. (*WAC 332-120-030(2)*)

2. Survey monuments are those monuments marking local control points, geodetic control points, and land boundary survey comers. (*WAC 332-120-030(3)*)”

A copy of the survey document prepared may be attached to the Application to Remove or Destroy a Survey Monument. This will aid in the documentation of the point(s) being removed and prevent having separate documents for each monument removed or destroyed. When, or if, the monuments are replaced at the same point, or if new monuments are set in a different location, then a survey document similar to the first is prepared to give that positional relationship between the old removed and the new set monuments.

### **16-10.8 What are WSDOT’s Responsibilities of Maintaining a Monument?**

“Any monument set by a land surveyor to mark or reference a point on a property or land line shall be permanently marked or tagged with the certificate number of the land surveyor setting it. If the monument is set by a public officer it shall be marked by an appropriate official designation.” (*RCW 58.09.120*)

A monument usually has identifiable markings to identify ownership of the monument or one that is shown on a survey document that has been recorded with the county auditor.

Construction activity that will impact any monument will need to be identified and certain documents shall be prepared during the design phase or construction office.

A Record of Survey or a Monumentation Map Type 1 or 2 is a typical document prepared on most WSDOT projects. For those monuments that are being impacted, covered, destroyed, potentially bumped, etc., an Application For Permit to Remove or Destroy a Survey Monument shall be prepared. (See Design Manual Chapter 1450)

This permit will be prepared by the Construction Office or designated Land Surveyor prior to construction commencing. This permit shall be kept in the construction office throughout the duration of the contract. The construction office will follow through with the permit and prepare an “As-Built” survey (Design Manual 1440.03(2), Construction Manual 1-5.1C, Highway Surveying Manual Ch. 16 (Post Construction Surveying)) to acknowledge monuments remaining on site. Unless directed by the Project Engineer, all monuments within the construction site will be maintained per Standard Specifications 1-07.16.

Monuments shall be noted on the permit if they will be destroyed and replaced (field referenced and State Plane Coordinate assigned), destroyed and not replaced, raised in place, or replaced with reference monuments. One permit may be submitted for the entire project limits, (i.e. attach Record of Survey or Monumentation Map).

General Land Office (GLO) corners affected by construction activity shall be referenced as noted above, and replaced in the same position. If this position falls in a hazardous location (middle of traffic lane, top of retaining wall, middle of wetland area), then a minimum of three additional witness monuments shall be set to perpetuate the location of the preexisting monument. A Land Corner Record (See Design Manual Chapter 1450) shall be prepared when the new monuments are in place. This information shall also be included in the As-built Monumentation Map when one is required.

Failure to prepare a permit or total disregard for the monuments on and within the project limits, may subject the project engineer to penalties described in *RCW 58.04.015*. The penalties include being guilty of a gross misdemeanor and liable for the cost of reestablishment. The reestablishment cost could be in excess of \$30,000 per monument.

**16-10.9 What does a Preliminary Land Survey consist of?**

- I) Research
  - A) WSDOT Records
    - a) R/W plans, contract and as-built plans, field books, monument information files, hard shells, GPS database, etc.
  - B) Underlying county and city records of same type as described above.
  - C) DNR records
    - a) Records of Survey's, plats, Land Corner Records, unrecorded surveys and plats.
  - D) Deeds (relating to placement of the R/W centerline)
  - E) Ownership rights (project vicinity)
    - a) DEEDS (R/W and adjacent), waivers, orders of establishment, etc.
- II) Preliminary analysis
  - A) Evaluate documents collected in Research.
  - B) Is there enough good data to build a preliminary centerline?
    - i) Does information collected agree with itself?
    - ii) Does information agree with R/W Plans?
  - C) If there is enough good information, generate a preliminary centerline based on records evaluated.
    - i) What happens when this centerline is extended? Does it continue to fit?
    - ii) Do records indicate centerline monuments were set?
- III) Preliminary fieldwork
  - A) Verify enough corners to insure preliminary data is good and locate corners for which no information is available.
  - B) Tie centerline monuments and r/w markers if they exist.

## **Monumentation and Survey Records**

- C) Tie into state plane control if available.
  - D) Tie topography. Does centerline as-built and occupation lines agree with preliminary centerline?
- IV) Preliminary final analysis
- A) Evaluate all data collected.
  - B) Create a preliminary right of way centerline based on this data.

### **16-11 Survey Monumentation**

Survey monuments represent limits of ownership, alignment or a geographic point. It is important to know which of these representations the monument, or marker, found is trying to portray. The intent of the monument helps identify the legal locations of structures, objects, property ownerships, roadway alignments, easement rights, horizontal and vertical control points, etc.

Care needs to be taken when establishing monuments that the accuracy and precision used is clearly noted so that the monument is not used for something beyond its intended purpose. Small errors inherent in establishing a particular point can become a nightmare if this point is used for something it was not intended for.

### **16-12 Record of Survey/Monumentation Map Policy**

Proper documentation and monumentation is important in referencing a highway's alignment that is used to define its right of way and contribute to the body of public records. The department is required by law to perpetuate existing recorded monuments thus it is essential that a documentation and monumentation policy be established. (See Design Manual Ch. 1450.01)

### **16-13 Record of Survey or a Type 1 Monumentation Map**

The purpose of this document is to identify the physical location of the WSDOT Right of Way center line alignment. Measurements taken to: all existing monuments or markers within the project area; existing cadastral corners on each side of the highway corridor; city and county street intersection markers; any other extrinsic feature that was used to determine the right of way centerline alignment. This document will follow the mapping guidelines of a record of survey found *WAC 332-130-050*. A narrative will be added to monumentation map or record of survey to describe the nuances of the survey.

Monuments set or found by WSDOT employees will be mathematically tied to the right of way center line alignment. In those instances when the construction alignment and the right of way alignment differ, all monuments set on the right of way center line or randomly set with station and offsets, with a state plane coordinate, to the right of way center line. The last method is the preferred method when placing new monuments.

If the existing monuments are on a construction alignment, all found alignment monuments shall note a station and offset to the Right of Way center line alignment. A note shall be placed on the Monumentation Map or Record of Survey noting the finding of found monuments on a construction alignment. A DNR "Application for Permit to Remove or Destroy a Survey Monument." Shall be filled out on all monuments removed, destroyed and reset on the project.

## **16-14 Type 2 Monumentation Map**

The purpose of this document is to perpetuate existing monuments that may be covered, raised, destroyed, or replaced within a project area that does not require an alignment determination. New monuments may be set to replace existing monuments in a different location but the mathematical geometry needs to be perpetuated to keep the integrity of the old monument locations.

All monuments found and/or set are shown graphically on a proper type of Monumentation Map. Monuments that were originally set on a construction alignment shall have a note stating construction station and have a right of way alignment station and offset computed and shown on the map.

Monuments set or found by WSDOT employees on projects not requiring the determination of the centerline alignment, but are set or found for perpetuation purposes.

Monuments found or set will have a State Plane Coordinate assigned to them with a brief description or diagram of how the coordinates were determined. Stations assigned to the monuments found will be noted as the station found on the construction as-built plans. No determination of right of way centerline or construction centerline is made during this survey.

## **16-15 Monument Markers**

It is the intent of this policy to change (from the past custom of placing monuments at the construction alignment PC's and PT's) monument placement to a random location. Random points placed in "safe" locations, are assigned a station and offset and a state plane coordinate. Existing monuments that are or will be buried or covered by structures shall be located and removed having new monuments set in a more usable location. New monuments need not be direct offsets from existing points. A random location may replace existing monuments as determined by terrain, visibility, and safety issues.

Existing monumentation documentation can be found with a little research at the county auditor's or surveyors office, county or city engineer's office, DNR, National Oceanic Atmospheric Administration (NOAA), WSDOT construction plans, etc. All Monuments found on the site shall be referenced and outside agencies contacted prior to construction of possible disturbance of said monument. A DNR "Application for Permit to Remove or Destroy a Survey Monument." Shall be filled out on all monuments removed, destroyed and reset on the project. After the project is completed, inspection of the area to ensure all monuments labeled to be removed have been removed, that existing monuments to remain are still in place, existing monuments that were to be replaced have been replaced, and that new monuments set during the project are shown on the record of survey or Type 1 monumentation map and the DNR Application to remove or Destroy a Survey Monument is completed and filed.

Monuments that are reset by the Project Engineer are limited to existing monuments that will be replaced in the original location. A consultant will establish property corners that are to be replaced in their new location. Geodetic monuments are to be reset by Headquarters Geographic Services or the agency to whom they belong. There will be a charge for this work. General Land Office corners that fall within travel way will be replaced in its original location. In addition, for safety reasons, a minimum of three witness corners will be set so that the corner in question may be mathematically computed. A Land Corner Record will be completed by the Project Engineer or Professional Land Surveyor and filed with DNR and the County in which the corner lies.

## **16-16 Definitions of WSDOT Horizontal Control Hierarchy**

**Monumentation** – the process of establishing a physical survey control network, consisting of survey markers representing specific points or corners and generally assigned with geographical coordinates and/or elevations, which pertain to a defined datum of reference.

As monumentation relates to most State Highway projects, the physical network of survey markers are further defined as being Primary Control, Secondary Control, or Tertiary Control points. All survey markers (monuments) are subject to specifications and procedures, which define the classification.

**Primary control** – This is the first layer of densification of the National Geodetic Reference System (RGRS). The monuments are WSDOT brass disks and designated as “PRN” (Primary Reference Network). WSDOT Geographic Services Survey Section establish the monuments, using ties to High Accuracy Reference Network (HARN) stations in the network, and provide “Report Of Survey Mark” data sheets available on the World Wide Web (Internet) and the internal WSDOT Intranet. The precision ratio is considered 1:100,000, with a Network Accuracy not to exceed 0.12 feet and a Local Accuracy not to exceed 0.05 feet.

**Secondary control** – This layer is the densification of the Primary Reference Network. The monuments are WSDOT brass disks and designated with Regional notation (i.e.: “SW” for Southwest Region). The WSDOT Regional Office Survey Section generally establish the monuments, using ties to the PRN stations or previous “GP” monuments supplied for the Regions by WSDOT Geographic Services Survey Section. Regional forces collect the survey data, unless otherwise provided, and “Report Of Survey Mark” data sheets are available on the Regional survey monument database. The precision ratio is considered 1:20,000 with a Network Accuracy not to exceed 0.22 feet, and a Local Accuracy not to exceed 0.08 feet.

Often times rebar and cap monuments are used in this layer when durability due to anticipated highway construction may be in question.

**Tertiary control** – The monument in this classification is considered temporary and not generally entered into the Regional database. The precision ratio is 1:10,000 or less, with a Local Accuracy not to exceed 0.17 feet. Typical uses of this monument are for stockpile volumes, overcoming a local obstacle in topographic data collection, etc.

**Spacing requirements** for Primary Control Points see chapter 8 “Global Positioning System (GPS) Survey Specifications”. When establishing the spacing of secondary control Points, the determining factors are terrain, length of project, traffic volumes, and elevation. Line of sight between points is preferred but not necessary. When extenuating circumstances do not allow line of sight, then each secondary control point shall have an Azimuth Reference point established paired with it.

A minimum of two (2) Secondary Control points set, if there are no existing control points in the area, at each end of the project shall be established. Secondary Control points shall have state plane coordinates established and recorded in the region or statewide data base.

Tertiary control points established as durable monuments shall be no further than 1500 feet apart.



***What is an acceptable monument?*** - Any object of durable nature that will not be affected by the normal activity surrounding the monument. All iron rods (#4 or bigger), iron pipes (1/2 in. inside diameter or bigger), or aluminum rods shall have a cap (Brass, plastic, or aluminum) bearing the acronym “WSDOT CONTROL”, “WSDOT PLS #####” or “WSDOT PE #####”. Other durable markers, railroad spikes, PK Nails, axles, etc., shall have a brass washer (bearing the acronym “WSDOT CONTROL”, “WSDOT PLS #####” or WSDOT PE #####”) attached to it by a wire or other permanent method. See Exhibit A. Monuments set to define property corners (right of way break points, pit site property corners) shall use the “WSDOT PLS #####” cap style. All other control monuments set for design, topographic, construction, and other purposes shall have “WSDOT CONTROL”. Monuments set specifically for alignment purposes only shall have the choice of “WSDOT CONTROL”, “WSDOT PLS #####”, or WSDOT PE #####” depending on the office (person supervising the survey activity will be either a Professional Engineer or a Professional Land Surveyor) setting the monument.

For permanent monument placement see Exhibit B for an example.

**Exhibit A**

Plastic or aluminum caps or metal washers to be placed on or attached to iron rods, pipes, PK nails, brass screws, etc.



USES:

Nonboundary delineation point, Network Control Points,  
Alignment Control Points

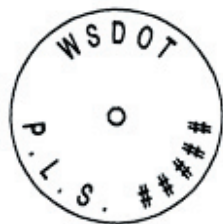

USES:

Boundary Corners, right of way break points,  
Alignment Control Points

EXHIBIT B

NOTE: THIS PLAN IS NOT A LEGAL ENGINEERING DOCUMENT BUT AN ELECTRONIC OUTPUT OF A CAD PROGRAM. THE ORIGINAL, SIGNED BY THE ENGINEER AND APPROVED FOR PUBLICATION, IS KEPT ON FILE AT THE WASHINGTON STATE DEPARTMENT OF TRANSPORTATION. A COPY MAY BE OBTAINED UPON REQUEST.

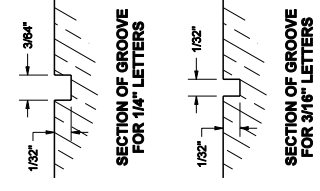
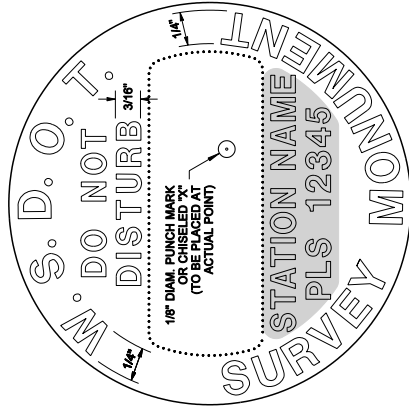
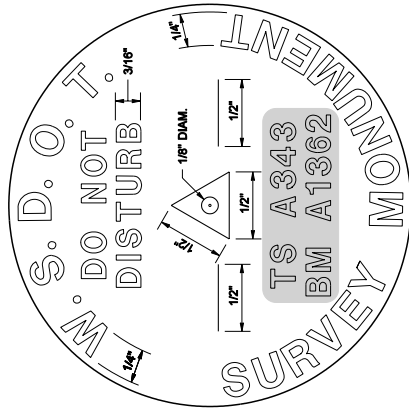

NOTES

1. THE BRASS DISC WILL BE FURNISHED BY THE STATE.
2. THE TEXT IN THE SHADED AREA (SEE TOP VIEW) SHALL BE 3/16" HIGH AND WILL BE STAMPED BY WSDOT PERSONNEL PRIOR TO SETTING THE CAP. ONLY THE ASSIGNED IDENTIFICATION LETTERS AND NUMBERS ARE TO BE PLACED ON THE BRASS DISC.
3. THE HOLE SHALL BE 3/16" MINIMUM IN DEPTH OR 6" BELOW THE DEEPEST RECORDED SURFACE OF THE GROUND. THE BRASS DISC SHALL BE SET IN THE CENTER OF THE HOLE SO THAT THE CONCRETE IS PLACED ON FIRM UNDISTURBED EARTH.
4. THE TOP OF THE CONCRETE SHALL BE TROWELED SMOOTH AND THE BRASS DISC SET IN THE CENTER WITH TOP FLUSH AND LEVEL. WHEN THE CONCRETE IS SET, COVER THE ENTIRE MONUMENT WITH MOIST EARTH AND LEAVE FOR THREE DAYS.
5. THE TOP OF THE MONUMENT MAY BE RECESSED OR PROTRUDING, DEPENDING ON CONDITIONS.
6. TO REPLACE A GENERAL LAND OFFICE (G.L.O.) CORNER, CONSULT A LICENSED PROFESSIONAL LAND SURVEYOR (P.L.S.).

TOP VIEW  
BRASS DISC

TYPE 2

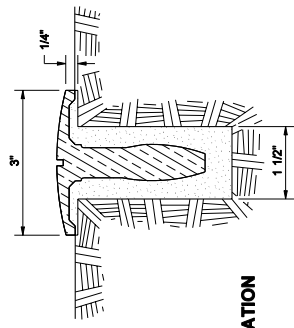
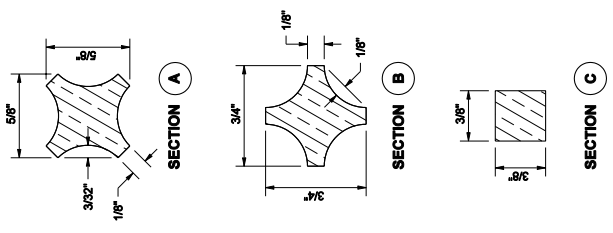
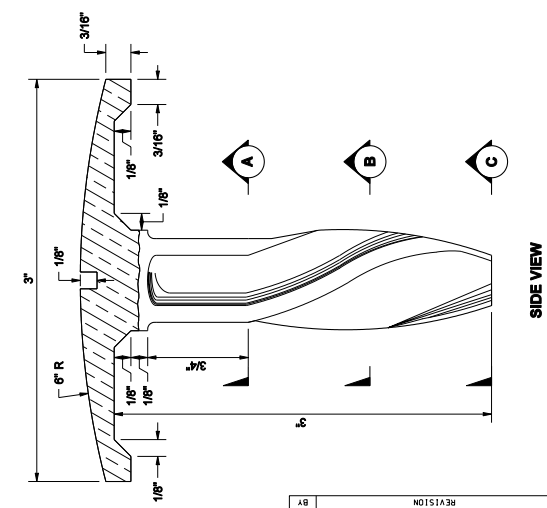

SECTION VIEW OF  
LEDGE ROCK, CONCRETE  
OR ASPHALT INSTALLATION

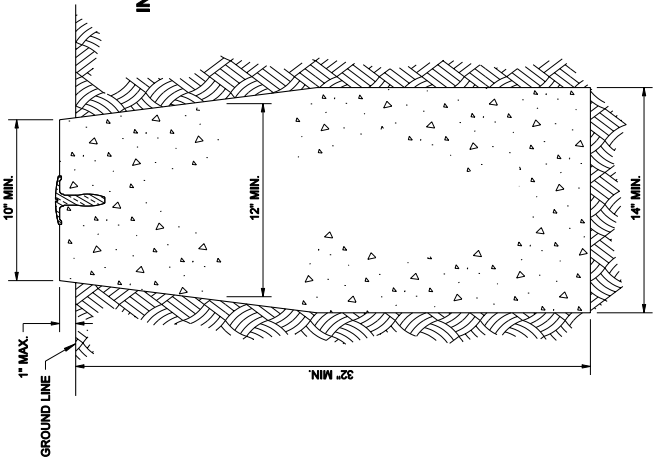

SECTION VIEW OF  
GENERAL INSTALLATION



EXPIRES MAY 16, 2005

**SURVEY MONUMENTS  
TYPE 1 AND TYPE 2  
STANDARD PLAN H-6**

SHEET 1 OF 1 SHEET

APPROVED FOR PUBLICATION  
**Harold J. Peterfeso** 10-29-03  
 STATE DESIGN ENGINEER DATE  
 Washington State Department of Transportation

|         |                       |
|---------|-----------------------|
| DATE    | REVISION              |
| 10/2000 | ADDED TYPE 2 MONUMENT |
| BY      | MKS                   |

**EXHIBIT C  
RECORD OF SURVEY / MONUMENTATION MAP  
CONTENTS CHECKLIST**

WAC 332-130-050.....SURVEY MAP REQUIREMENTS

1. County recording official's information block, which contains:
  - (a) Title block, shown on all sheets, including:
    - (1) Business name
    - (2) Date prepared
    - (3) Sheet identification number, such as "sheet 1 of 2"
  - (b) County Engineer's Certificate, located on the first sheet only
  - (c) Land Surveyor's Certificate, located on the first sheet only
    - (1) Show name, license number, seal, signature, license expiration date, and date the surveyor approved the map
    - (2) Every other sheet shall show only data per (1)
2. Indexing information on the first sheet of multiple sheets:
  - (a) The section-township-range and quarter-quarter of section(s)
  - (b) Additionally, if appropriate, the lot, block, and plat title
3. North arrow
4. Basis of Bearings
5. Bearings: use degrees, minutes, and seconds
6. Distances: use feet and decimals of feet (ground-level distances)
7. Curve data: show the controlling elements
8. Graphic scale bar
9. For the intelligent interpretation of various items shown:
  - (a) Use reference documents that identify different corner positions
  - (b) Identify all corners used to control the survey
  - (c) Describe physical monuments found or re-established
  - (d) Show legal description of surveyed property or recorded reference
  - (e) Identify ambiguities, gaps, and/or overlaps
  - (f) Show any encroachments or evidence of possible conflicts
10. All signatures and writing using permanent black ink
11. Size to be 22" by 34" per WSDOT Plans Preparation Manual.

WAC 332-130-100.....EQUIPMENT AND PROCEDURES USED

1. Equipment used
2. Procedures used

RCW 58.090.050.....RECORD-OF SURVEYS PROCESSING

1. Legible map of permanent quality, using black on mylar
2. Sheet size to be 22"x34"
3. 2" margin on left edge and ½ " margin at all other edges
4. Supply original mylar to the County Engineer.

RCW 58.09.070.....COORDINATES- CONTROL SCHEME REQUIRED

1. Use a control scheme (network diagram) to show how the WSP coordinates were determined from the known points
2. Datum defined : *RCW 58.20.120* states the Washington Coordinate System of 1983 is the designated coordinate system in Washington

RCW 58.09.080.....CERTIFICATES - REQUIRED

See this law for both Surveyor's Certificate and Engineer's Certificate

RCW 58.20.190.....METRIC EQUIVALENT

Conversion to US Foot shall use 1 meter to equal 39.37 inches.

RCW 58.20.140.....DESIGNATION OF SYSTEM - ZONES

Label whether project is in the North zone or the South zone

RCW 58.20.180.....RECORDING COORDINATES

When reference has been made to such coordinates, the scale and sea level factors shall be stated for the survey lines used in computing ground distances and areas.

MISCELLANEOUS ITEMS

State Route (SR) shown on alignment

Legend showing monument symbols and their equivalents

Surveyor's Notes (purpose of the survey), etc.

Document title "RECORD OF SURVEY" or "MONUMENTATION MAP", generally located at top - center of sheet

Surveyor's Statement.....to add a special note for clarification of deeds, etc.

EXHIBIT D  
REFERENCE TO STATE STATUTES

**16-02 Monumentation and Survey Records**

Monuments are defined in Washington Administration Code (WAC).

***WAC 332-120-020 Definitions.***

Survey monument: The physical structure, along with any references or accessories thereto, used to mark the location of a land boundary survey corner, geodetic control point, or local control point.

**16-06 Public Land Survey System Monuments**

***WAC 332-120-040 Monument removal or destruction.***

- (1) All land boundary survey monuments that are removed or destroyed shall be replaced or witness monuments shall be set to perpetuate the survey point.
- (2) A land boundary survey corner shall be referenced to the Washington Coordinate System of 1983, adjusted in 1991, prior to removal or destruction. See WAC 332-130-060, Geodetic control, survey standards.

An applicant may request a variance from this referencing requirement by so noting in the applicant information section on the permit and providing the justification on the back of the form. The department shall note whether the variance is approved or not approved and shall provide the reason for not approving the request.

[Statutory Authority: RCW 58.24.040(8). 94-06-034 (Order 617), § 332-120-040, filed 2/25/94, effective 3/28/94; Order 131, § 332-120-040, filed 3/1/72, effective 4/7/72.]

**16-17 State Responsibility of Survey Markers – *RCW 47.36.010***

**“Restoration of United States survey markers.** The department shall fix permanent monuments at the original positions of all United States government monuments at township corners, section corners, quarter section corners, meander corners and witness markers, as originally established by the United States government survey whenever any such original monuments or markers fall within the right of way of any state highway, and aid in the reestablishment of any such corners, monuments, or markers destroyed or obliterated by the construction of any state highway by permitting inspection of the records in the department’s office.”

The DNR permit uses the terminology “remove or destroy” as required by law and legally defined as follows:

***WAC 332-120-020 Definitions.***

Removal or destruction: The physical disturbance or covering of a monument such that the survey point is no longer visible or readily accessible.