

# ZEN ORIGAMI



20 MODULAR FORMS  
FOR MEDITATION AND CALM

MARIA SINAYSKAYA



# ZEN ORIGAMI

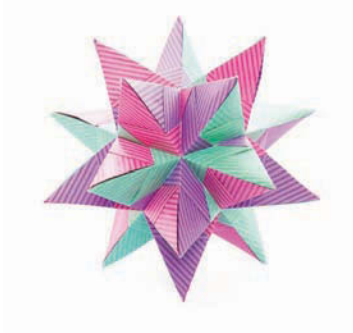



Quarto is the authority on a wide range of topics.  
Quarto educates, entertains and enriches the lives of  
our readers—enthusiasts and lovers of hands-on living.  
[www.quartoknows.com](http://www.quartoknows.com)

© 2016 by Maria Sinayskaya

First published in the United States of America in 2016 by  
Race Point Publishing, a member of  
Quarto Publishing Group USA Inc.  
142 West 36th Street, 4th Floor  
New York, New York 10018  
[quartoknows.com](http://quartoknows.com)

All rights reserved. No part of this book may be reproduced in any form without written permission of the copyright owners. All images in this book have been reproduced with the knowledge and prior consent of the artists concerned, and no responsibility is accepted by producer, publisher, or printer for any infringement of copyright or otherwise, arising from the contents of this publication. Every effort has been made to ensure that credits accurately comply with information supplied. We apologize for any inaccuracies that may have occurred and will resolve inaccurate or missing information in a subsequent reprinting of the book.

10 9 8 7 6 5 4 3 2 1

ISBN 978-1-63106-197-4  
Digital edition: 978-1-62788-945-2  
Softcover edition: 978-1-63106-197-4

Author, illustrator, and photographer: Maria Sinayskaya  
Editorial Director: Jeannine Dillon  
Managing Editor: Erin Canning  
Project Editor: Jason Chappell  
Editor: Katherine Furman, Tandem Books  
Interior Design: Ashley Prine, Tandem Books

Printed in China

Not for individual sale

Graphic pattern on pages 24, 28, 31, 38, 52, 58, 62, 66, 70, 74, 78, 84, 90, 95, 100, 108, 112, 116, 119, and 123  
© NattyPTG/Shutterstock.

Origami-paper patterns and images on pages 12–13 (left to right, excluding third from right) ©:  
Elena Zolotukhina/Shutterstock, mystel/Creative Market, Lana839/Shutterstock, mystel/Creative Market,  
Lana839/Shutterstock (far right p. 12 and far left p. 13), mokokomo/Shutterstock, and akiyoko/Shutterstock,  
kao/Shutterstock

# ZEN ORIGAMI



20 MODULAR FORMS  
FOR MEDITATION AND CALM

MARIA SINAYSKAYA



# CONTENTS

INTRODUCTION . . . . 7

BASIC INSTRUCTIONS  
AND SYMBOLS . . . . 10

PAPER TIPS AND  
FOLDING TRICKS. . . . 12



SQUARE  
COASTER  
• 24 •



GIANT  
STAR  
• 28 •



TWO-FACED  
FLOWER  
• 31 •



FASETT  
SONOBE  
• 38 •



LORENCE  
SONOBE  
• 52 •



FLORENCE  
SONOBE  
• 58 •



GEMSTONE  
SONOBE  
• 62 •



ESTE  
SONOBE  
• 66 •



ESTERRE  
SONOBE  
• 70 •



ISOLDE  
SONOBE  
• 74 •



SELENE  
SONOBE  
• 78 •



CURLY  
SONOBE  
• 84 •



IMPERIAL ROSE  
SONOBE  
• 90 •



LOTUS CROWN  
SONOBE  
• 95 •

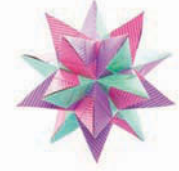

SKY STAR  
KUSUDAMA  
• 100 •



SKELLA ALPHA  
KUSUDAMA  
• 108 •



SKELLA BETA  
KUSUDAMA  
• 112 •



SKELLA GAMMA  
KUSUDAMA  
• 116 •



ROCCA  
KUSUDAMA  
• 119 •



IORELLA  
KUSUDAMA  
• 123 •

ABOUT THE  
AUTHOR..... 128







---

## INTRODUCTION

---

# A MEDITATION ON FOLDING

THE WORD “ZEN” COMES FROM THE SANSKRIT *DHYANA* WHICH MEANS “MEDITATION.” Zen is itself a school of Buddhism—formed in 650 CE and most popular in Japan—that believes enlightenment can be attained by reflection and meditation. Through the centuries and the spread of Buddhist thought to all corners of the globe, Zen has evolved to become somewhat synonymous with the calm and balanced state of being that comes about from meditative practices. This calmness is something we could all use a little more of in our hectic modern world.

Another traditional and well-known Japanese practice is, of course, origami. This art of paper folding may be as much as a thousand years old, and it has been used in everything from education to gift giving to meditation. One of the most familiar origami forms is that of a crane. The story goes that if you fold 1,000 cranes, collectively known as a *senbazuru*, a crane spirit will grant you a wish or bestow you with eternal good luck. No matter what you believe, the one thing that is guaranteed is that there is a great deal of peace to be found in repeating the same simple motions to produce an elaborate thing of beauty.

*Zen Origami* combines the two traditions that give this book its name to create a wonderfully meditative experience. It is a way to step back from whatever stresses and distractions occupy your thoughts and bring you to a place of serenity. The forms that you ultimately create will serve as beautiful reminders of the importance of taking a little mental time away from your day-to-day worries and finding some peace of mind.

This book utilizes modular origami, which involves folding many simple units. These single-sheet units are then linked together to create stunning, often 3-dimensional, pieces of art. This form of origami captures the essence of Zen practice in that it involves a mindful observation of what one is doing and repeating that same thing many times—a physical expression of a chant.

When creating the forms in this book, you will have the opportunity to perfect each unit you create by folding it multiple times. After folding a unit the first couple of times, you'll likely be able to create it from memory and find a flow to your movements in which your busy mind quiets, you become immersed in the art of folding, and a sense of peace is found.

Each unit is fairly simple, but the result of their union is stunning and, in a way, more than the sum of its parts. They assemble to create intricate patterns that are both gratifying to make and enchanting to look at—many of them even resemble the Buddhist symbol of the universe, the mandala.

*Zen Origami* provides you with the instructions for a variety of modular projects. The Square Coaster and Giant Star are simple, flat forms that will warm up your fingers and get you used to folding.

The *sonobe* projects are 3-dimensional figures that are built on underlying geometrical shapes. Many find a sacred beauty in the math intrinsic to them. They capture an intricacy that is at once pleasing and awe-inspiring to behold.

The *kusudama* projects are also 3-dimensional. They often take the form of a ball and have a hollow center. Originally, a kusudama was a ball of dried, medicinal herbs sown together, which is evident in the word itself: in Japanese *kusuri* means “medicine” and *tama* means “ball.” Combined you get kusudama, or a medicine ball. The origami kusudamas made today are similar in shape alone. They are fashioned for the sake of the pleasure found in creating them and for their beauty.

Please enjoy this book with a light heart and a sense of joy and playfulness. Treat each project as a meditative retreat, and remember you're doing this for you—to find calm and patience in a simple act, to experience the joy of creation, and to have a little bit of fun in your pursuit of Zen!

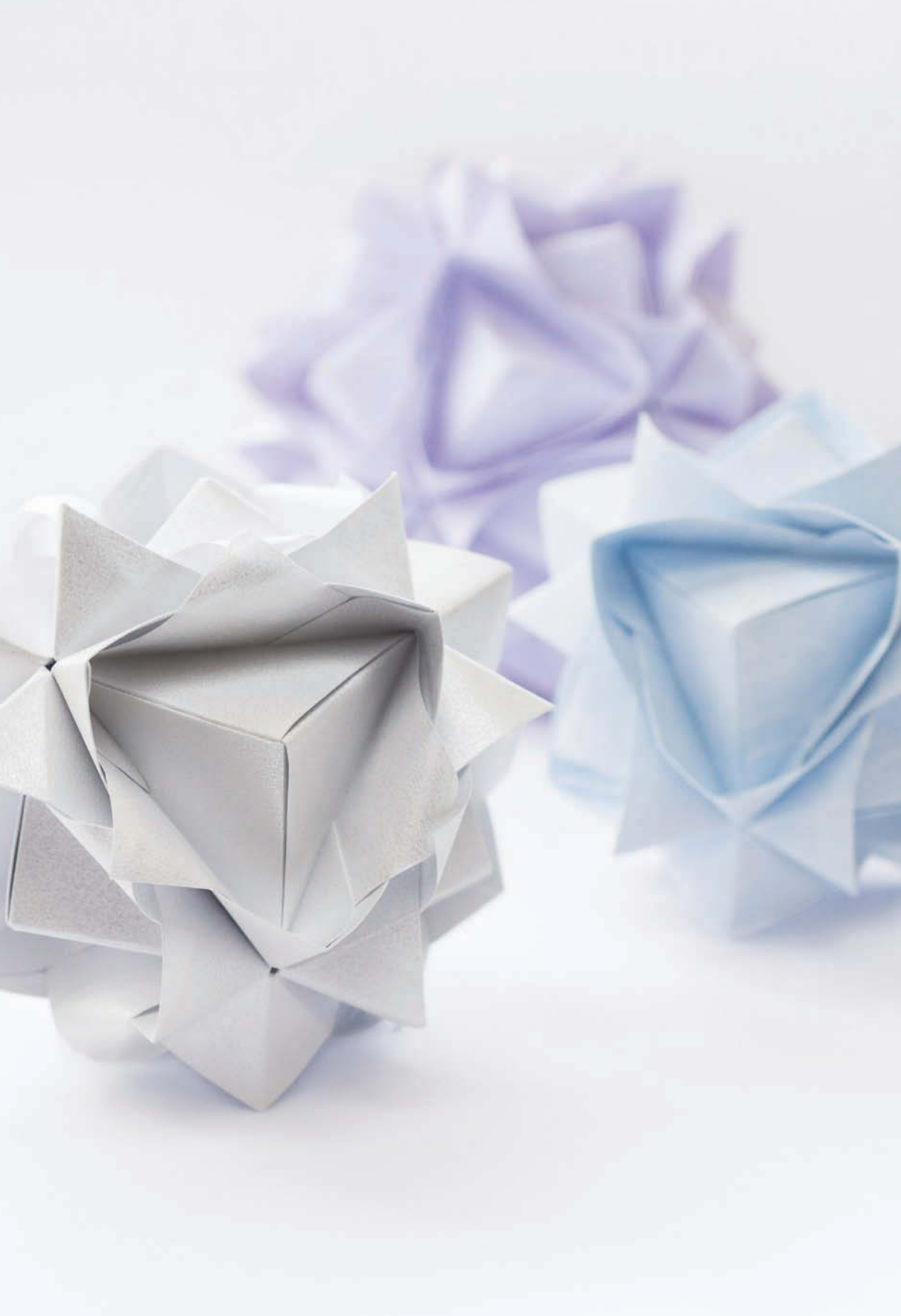

# BASIC INSTRUCTIONS AND SYMBOLS

Here are the basic instructions, fold names, and symbols you will find throughout the book.

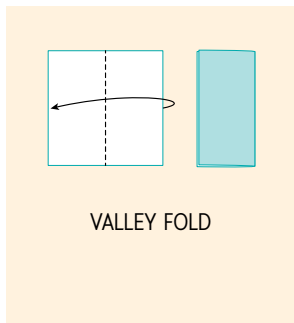
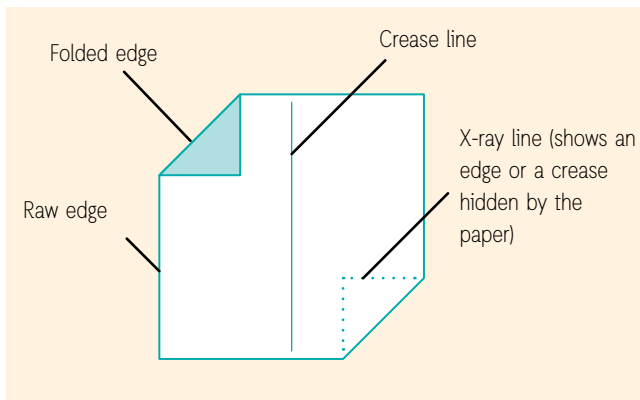

VALLEY FOLD

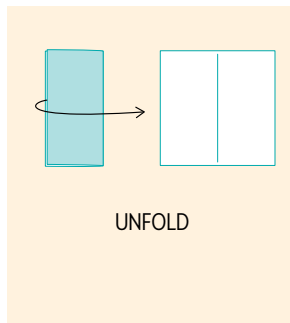

UNFOLD

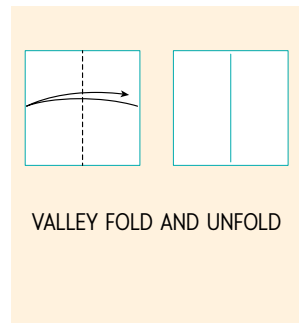

VALLEY FOLD AND UNFOLD

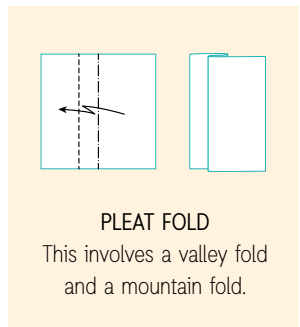
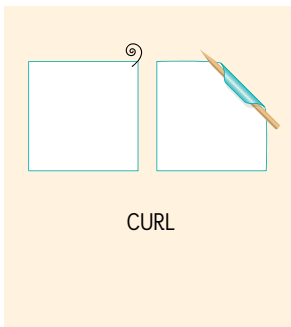
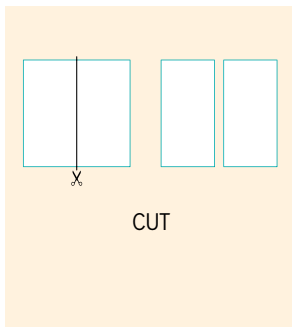
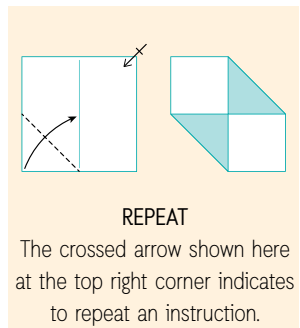
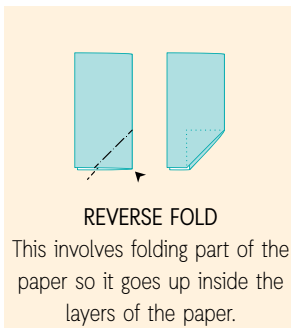
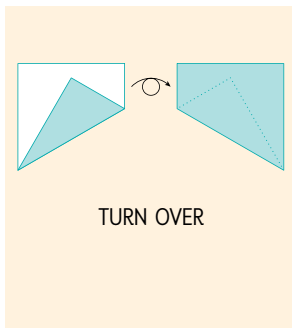
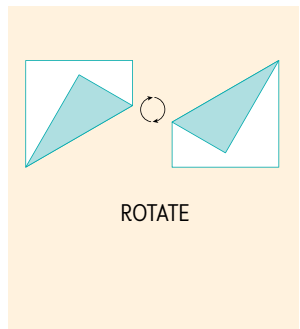
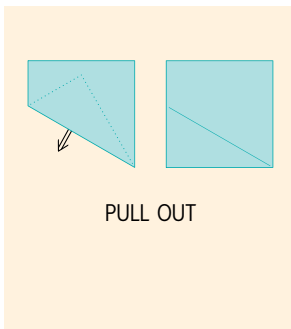
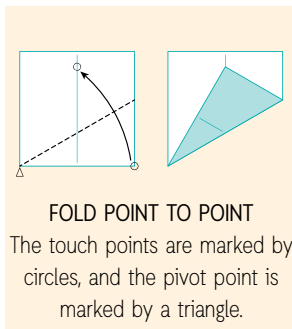
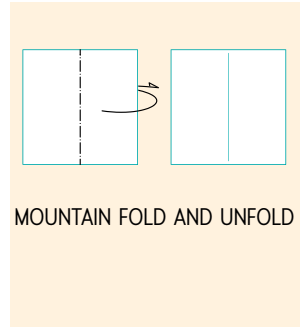
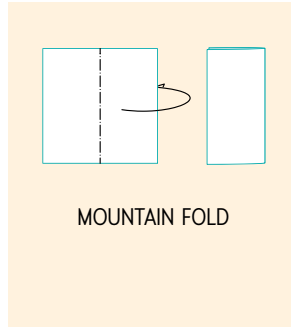
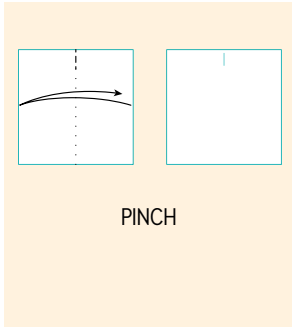



# PAPER TIPS AND FOLDING TRICKS

## CHOOSE THE PAPER

The general rule of thumb for choosing the right type of paper for modular origami is that it must be relatively thin, crisp, and hold a crease well. There are quite a few types of paper out there that you can use—standard origami paper that can be found at craft stores and some wrapping papers, such as brown and white kraft paper, which are sold in rolls and sheets. Browse your local art-supply store for paper that has a weight of 50 to 70 GSM (grams per square meter), but avoid papers that are too thick, “soft,” or tear easily.

## TEST-FOLD THE UNITS

Before making a decision on what paper to use for a certain project, always try folding a unit from a sheet of inexpensive paper first to get an idea of what size the finished unit will be and how difficult it is to fold.

Make at least two identical units so you can also see how the assembly method works and if the units’ flaps and pockets are a manageable size.

## ASSEMBLE ONE UNIT AT A TIME

A common mistake a novice can make while assembling the units is to connect them first into smaller assemblies (groups of three, for example) and then try to connect those groups together into a single structure. That rarely works! Instead, start by forming a group of units according to the assembly instructions and then keep adding more units to it, one at a time, “growing” the first group slowly until the model is finished. If you are confused about an assembly, just be patient and gentle, and the “a-ha!” moment will come to you.



## ACCURACY

Unlike some simple traditional origami designs, modular origami is highly geometric in nature and requires a lot of accuracy and precision in folding. All the units must be identical, otherwise they might not fit each other when it's time to assemble them. Make sure you follow the instructions exactly, and don't rush it—take your time and enjoy the process!

## FOLDING SURFACE

For the best results, fold on a flat, firm surface (rather than holding the paper in the air). I recommend using a gridded cutting mat. It makes a perfect non-slip folding surface and can even be used to quickly divide a sheet of paper into equal thirds (see page 17).

## FOLDING TOOLS

Remember that folding multiple units for modular projects takes time, and prolonged folding might damage your nails. Using special folding tools, like bone or wooden

folders (available at most craft stores), not only makes your creases sharp but preserves your nails.

## READ AHEAD

If you're having trouble reading a certain step, look at the next step to see what the result is supposed to look like. Having an idea of what you're trying to achieve helps a great deal.

## HELPFUL ASSEMBLY TOOLS

Sometimes during the assembly you might find that a few small paper clips or mini clothespins placed temporarily in the right places can help the units stay in place (and keep you in the Zen mode). For some models a pair of tweezers might come in handy, too!



# EVEN THREE-COLOR DISTRIBUTION

To make a modular origami model more appealing while assembling it with 3 different colors, follow the color distribution patterns illustrated below. Each edge of a polyhedron represents an origami unit.

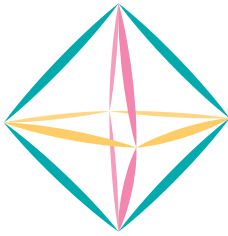

OCTAHEDRON

EDGES: 12      Every face has 3  
 VERTICES: 6      different colors.  
 FACES:  $8 \times \triangle$

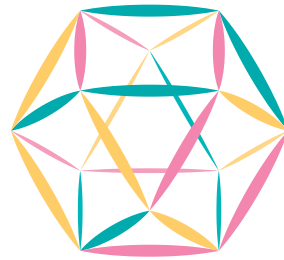

CUBOCTAHEDRON

EDGES: 24      Every triangular face  
 VERTICES: 12      has 3 different colors,  
 FACES:  $8 \times \triangle$       every square face has  
                   $6 \times \square$       2 different colors.

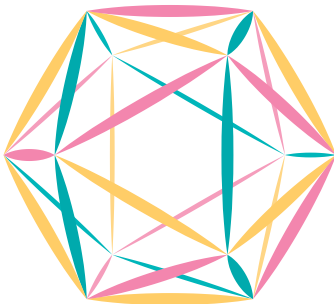

ICOSAHEDRON

EDGES: 30      Every face has 3  
 VERTICES: 12      different colors.  
 FACES:  $20 \times \triangle$

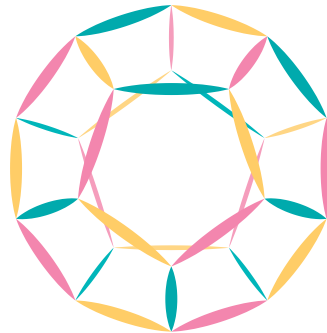

DODECAHEDRON

EDGES: 30      Every vertex has 3  
 VERTICES: 20      different colors.  
 FACES:  $12 \times \hexagon$

# FOLDING PAPER INTO THIRDS

Many projects require that the paper be folded into thirds. This section shows a few ways you can accomplish that with single and even multiple sheets of paper.

## METHOD 1

---

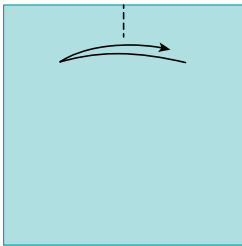

**1** Fold the paper in half from side to side, making a small crease at the top to mark the halfway point.

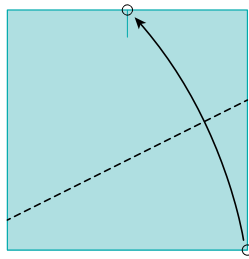

**2** Fold the lower right corner to the halfway pinch.

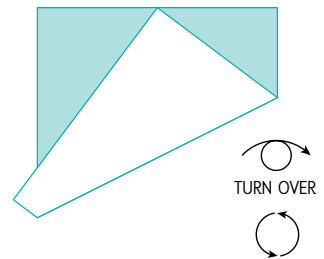

**3** This is what your paper should look like. Turn it over, and position it as shown in the next picture.

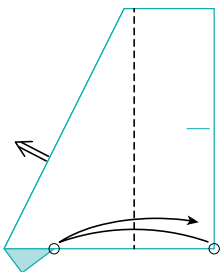

**4** Fold the lower right corner to meet the point marked here with a circle. Unfold the paper until you are back to a square sheet.

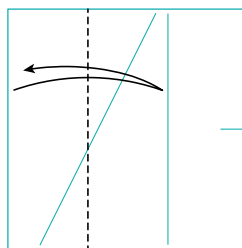

**5** Fold and unfold the left edge to the most recent crease.

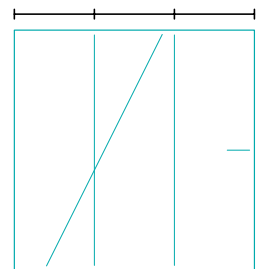

**6** The square is now divided into equal thirds.

## METHOD 2

---

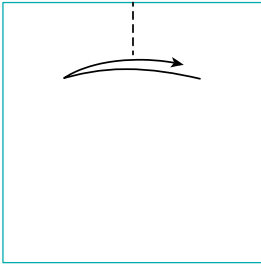

**1** Fold the paper in half from side to side, making a small crease at the top.

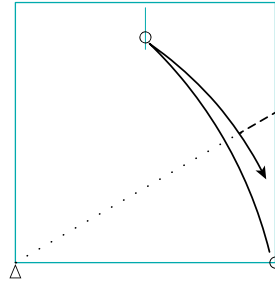

**2** Pivoting around the lower left corner, marked here with a triangle, bring the lower right corner to the recent crease. Make a short pinch on the right edge, then unfold.

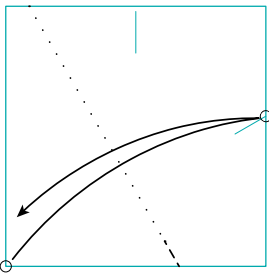

**3** Bring the lower left corner to the most recent crease and pinch at the lower edge.

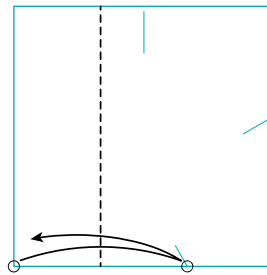

**4** Fold the lower left corner to meet the pinch on the lower edge, crease, and unfold.

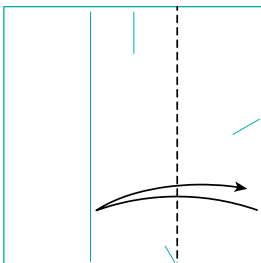

**5** Fold and unfold the right edge to the vertical crease on the left side.

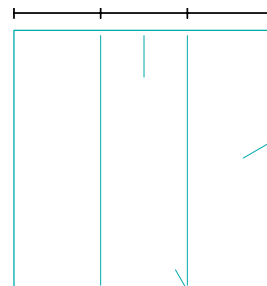

**6** The square is now divided into equal thirds.

## METHOD 3

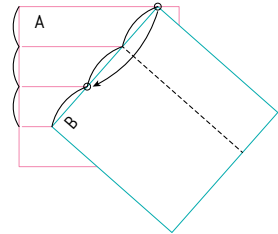
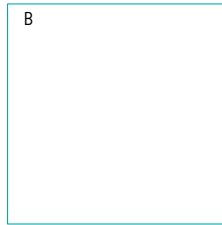
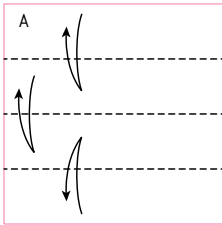

**1** You will need two sheets of paper for this method. Divide the first sheet, labeled here as “A,” into 4 equal parts horizontally. You can do this by folding the paper in half, unfolding it, and then folding and unfolding both horizontal edges to the central crease.

**2** Place the second sheet, “B,” on top of the first so that its top right corner meets the top edge of sheet A and its top left corner meets the lowest horizontal crease. Fold the top right corner of B over to the point where the upper edge intersects A’s central crease (the crease will intersect A’s top crease).

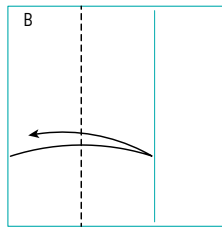
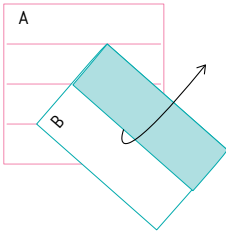

**3** This is what your papers should look like. Unfold B back to a square.

**4** Fold the left edge to the crease, then unfold.

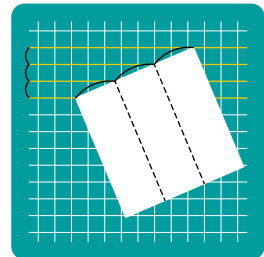
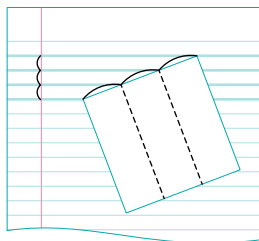
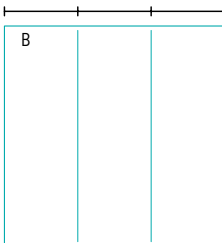

**5** The square is now divided into equal thirds.

**TIP!** You can use this method using a lined sheet of paper or a gridded cutting mat.

## FOLDING MULTIPLE SHEETS INTO THIRDS: METHOD 1

When you need to divide not just one but many sheets, using a prefolded template will speed up the process while eliminating unnecessary creases on the paper.

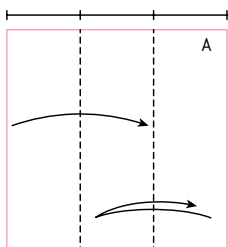

**1** Begin by dividing a sheet of paper, "A," into vertical thirds using any of the methods shown on pages 15–17. Then fold the left edge over to the right crease.

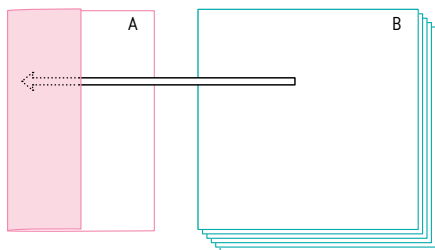

**2** Place a new sheet of paper, "B," that is the same size, inside A as far as it can go, so its edge is flush with A's fold.

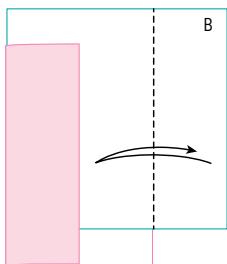

**3** Fold the right edge of B to meet the colored edge of A, then unfold.

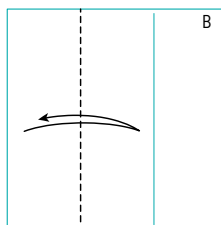

**4** Take B out of A, and fold the left edge to the vertical crease, then unfold.

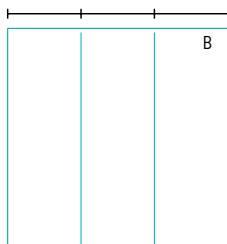

**5** The square is now divided into equal thirds. Repeat this process for as many sheets as you need.

## FOLDING MULTIPLE SHEETS INTO THIRDS: METHOD 2

When using large squares of paper, 6 inches (15 centimeters) or bigger, divide them into thirds first, before cutting into smaller squares. This is a great time-saver!

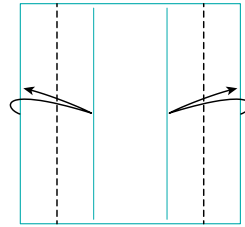
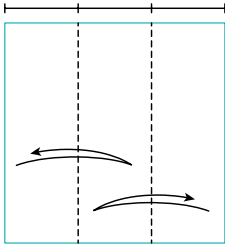

**1** Start by dividing the paper into thirds vertically using any of the methods shown on pages 15–17.

**2** Fold both vertical edges to the nearest creases, then unfold.

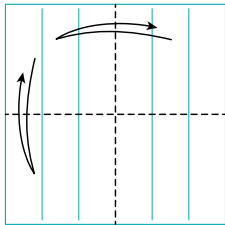

**3** Fold and unfold in half vertically and horizontally.

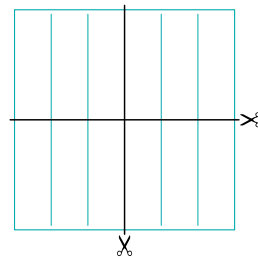

**4** Cut the paper into 4 squares along the central creases.

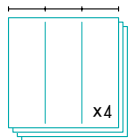

**5** Now you have 4 squares pre-folded into equal thirds.

# CREATING 2:3 RECTANGLES FROM A SQUARE

Some projects, such as the Esterre Sonobe on page 70, require rectangular papers with 2:3 proportions. This section has instructions on how to create those rectangles from square sheets of paper.

## SMALL, SQUARE PAPER

---

If your paper is 3 inches (7.5 centimeters) square, like the papers included in this kit, you can use this method. Each square will make one 2:3 rectangle.

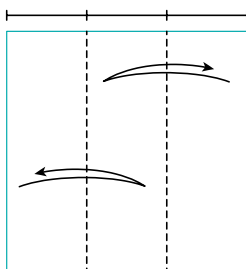

**1** Fold and unfold the paper in thirds vertically (see pages 15–19).

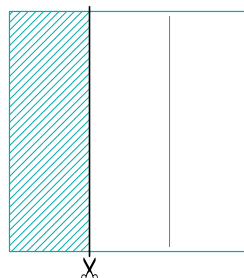

**2** Cut the paper along a crease. The small rectangle has sides in the proportion of 1:3, meaning the long side is 3 times longer than the short side. (You can save the 1:3 rectangles for other projects or crafts.)

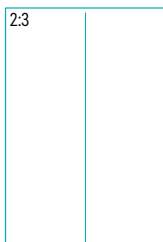

**3** The bigger rectangle has sides in the proportion of 2:3 and can be used for several projects in this book.



## MEDIUM, SQUARE PAPER

---

If your paper is 4–5 inches (10–12 centimeters) square, use this method. Each square will make two 2:3 rectangles.

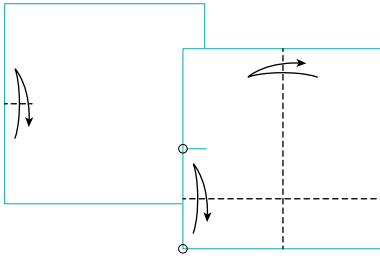

**1** Fold the paper in half horizontally and crease the left edge to mark the halfway point. Then fold the bottom edge up to the pinch and unfold. Now, fold and unfold the paper in half vertically.

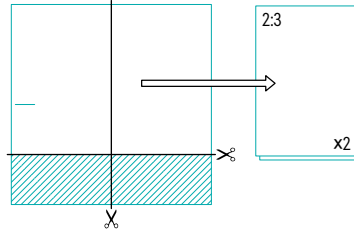

**2** Cut the paper along the creases. The two resulting rectangles will have sides in the proportion of 2:3.

## LARGE, SQUARE PAPER

---

This method is great if you're cutting from larger paper that is 6–8 inches (15–20 centimeters) square. Each square will make six 2:3 rectangles.

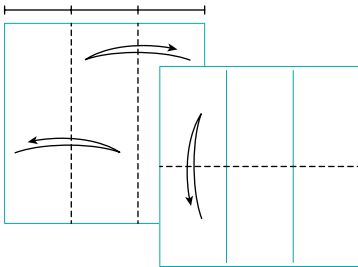

**1** Fold and unfold the paper in thirds vertically (see pages 15–19). Then, fold and unfold in half horizontally.

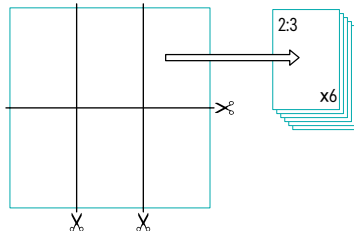

**2** Cut the paper along the creases. The six resulting rectangles will have sides in the proportion of 2:3.

# CREATING 3:4 RECTANGLES FROM A SQUARE

Some projects, such as the Skella Gamma Kusudama, can be created using rectangular papers with 3:4 proportions (see page 118). This section has instructions on how to create those rectangles from square sheets of paper.

## SMALL, SQUARE PAPER

---

If your paper is 3 inches (7.5 centimeters) square, like the papers included in this kit, you can use this method. Each square will make one 3:4 rectangle.

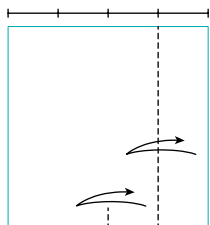

**1** Crease the bottom edge to mark the halfway point. Then fold and unfold the right edge to the mark.

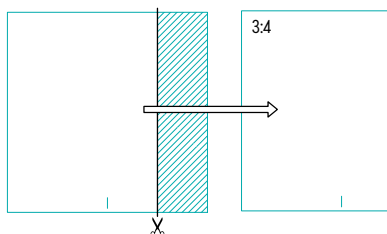

**2** Cut the paper along the crease. The bigger rectangle will have sides in the proportion of 3:4.

## MEDIUM, SQUARE PAPER

---

This method is good for 6 inch (15 centimeter) squares. Each square will make six 3:4 rectangles.

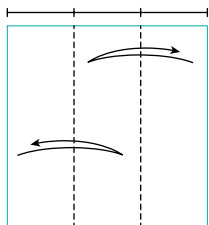

**1** Fold and unfold the paper in thirds vertically (see pages 15–19).

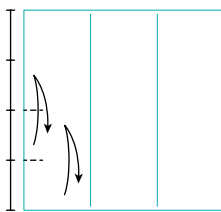

**2** Mark a halfway point on the left edge of the square. Make another mark by bringing the bottom edge to the halfway point.

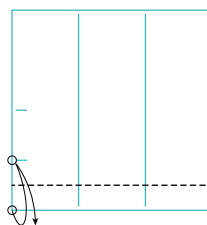

**3** Fold the bottom edge up to the most recent crease, then unfold.

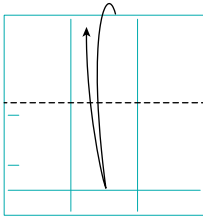

**4** Fold and unfold the upper edge to the lowest horizontal crease.

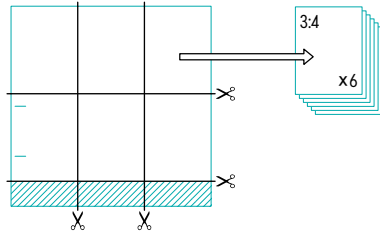

**5** Cut the paper along the creases. The six resulting rectangles have sides in the proportion of 3:4.

## LARGE, SQUARE PAPER

This method works great if your paper is 8 inches (20 centimeters) square or larger. Each square will make twelve 2:3 rectangles.

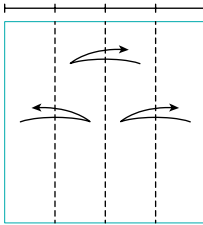

**1** Fold and unfold the paper in fourths vertically.

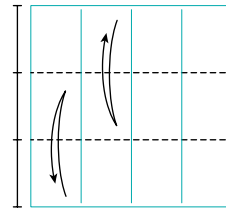

**2** Fold and unfold the paper in thirds horizontally (see pages 15–19).

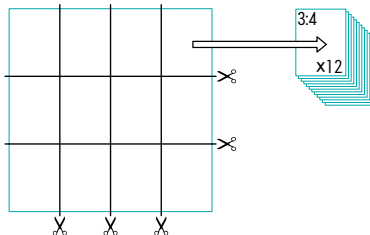

**3** Cut the paper along the creases. The twelve resulting rectangles will have sides in the proportion of 3:4.

# SQUARE COASTER



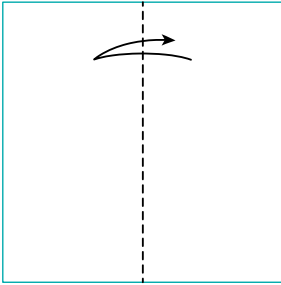

**1** Fold and unfold the paper from side to side to form a vertical crease.

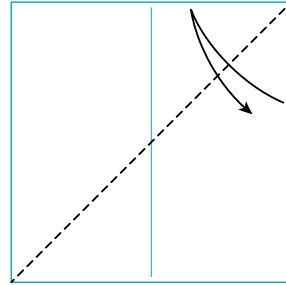

**2** Fold and unfold from corner to corner to form a diagonal crease.

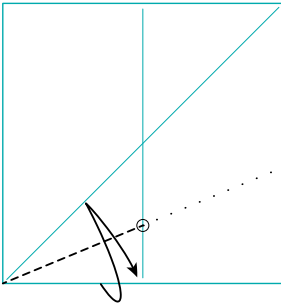

**3** Fold and unfold the bottom edge to the diagonal crease, making a crease only from the bottom left corner to the vertical crease.

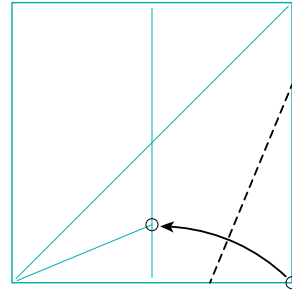

**4** Fold the lower right corner to the intersection of the vertical crease and the crease made in step 3.

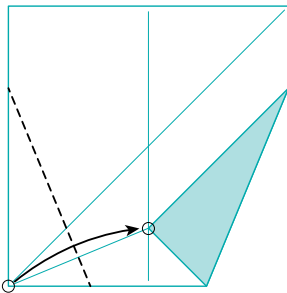

**5** Fold the lower left corner to the same point.

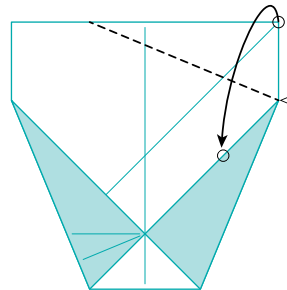

**6** Starting at the point marked with the triangle, fold the top right corner down to align with the colored edge.

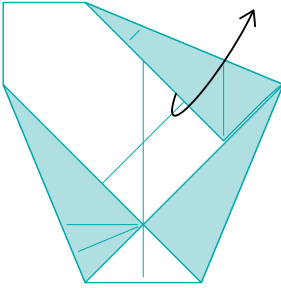

**7** Unfold the last step.

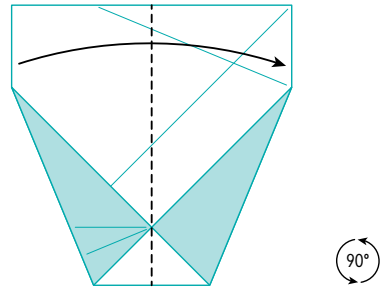

**8** Fold the paper in half from left to right along the vertical crease. Rotate 90° counterclockwise.

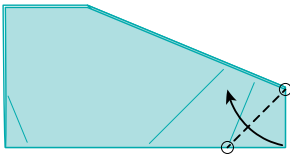

**9** Using the 2 points marked with circles as guides, fold the lower right corner over.

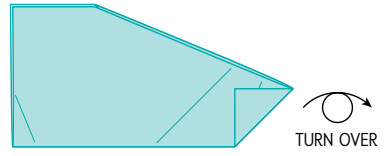

**10** Your paper should look like this. Now, turn the paper over.

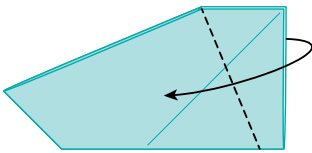

**11** Fold both layers of the right edge of the paper to the left using the existing crease.

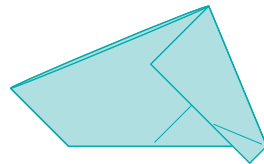

**12** This is what a complete unit should look like. Make a total of 4 units.

## ASSEMBLY

---

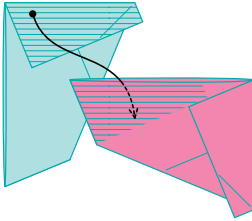

**1** Arrange 2 units as shown. Slide the flap of the green unit into the pocket of the pink unit, making sure that both layers of paper go inside the pocket.

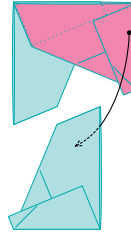

**2** Add a third unit in the same way.

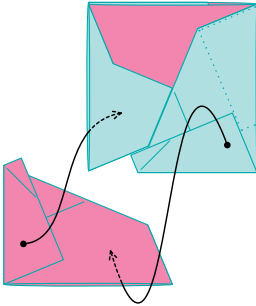

**3** Add the last unit, connecting it with the first and third units as shown.

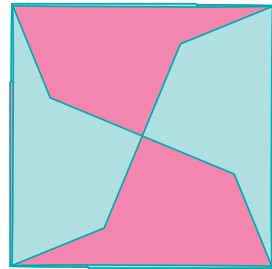

**4** This is the back of the coaster. Turn over.

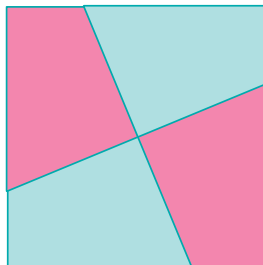

This is your completed Square Coaster.  
Flatten all creases firmly, and enjoy!



# GIANT STAR



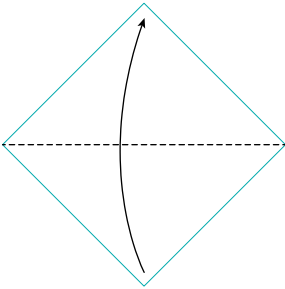

**1** Fold the paper in half from corner to corner.

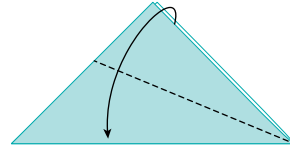

**2** Fold the right edge of only the top layer down to the folded edge.

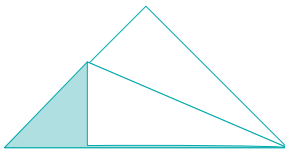

**3** This is the result. Turn the paper over.

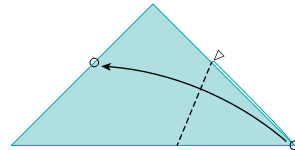

**4** Using the point marked with a triangle as a guide (the top of the fold from step 3), fold the lower right corner over to touch the left edge. The upper edge of the top layer will be parallel to the lower edge of the paper.

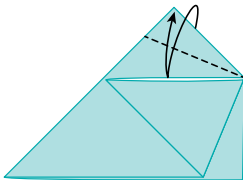

**5** Fold the top right edge to meet the upper horizontal edge, then unfold to create a crease.

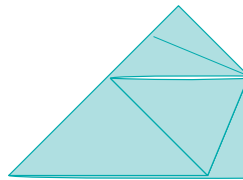

**6** This is what a complete unit should look like. Make a total of 8 units.

## ASSEMBLY

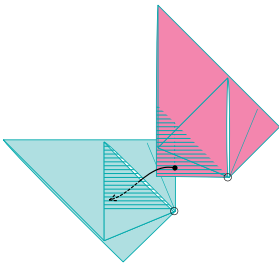

**1** Arrange 2 units as shown. Slide the pink unit into the green unit, making sure that both layers of paper go inside the pocket.

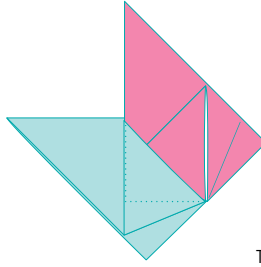

**2** Align the units as shown, then turn them over.

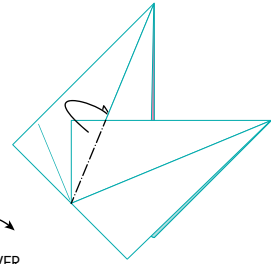

**3** Using the existing crease, fold the flap of the right unit so it is inside the pocket of the left unit.

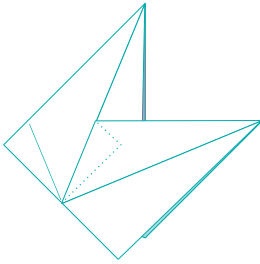

**4** These units are now joined together. Turn over.

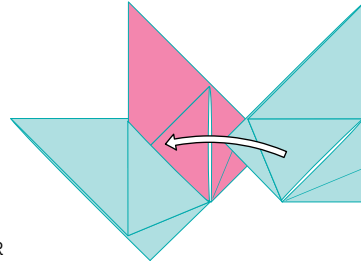

**5** Add the remaining units, repeating steps 1-4.

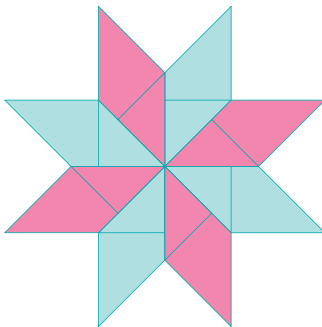

Your Giant Star is now complete! Turn it over ...

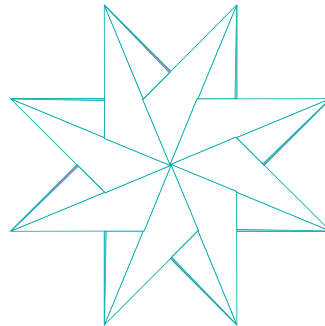

... to see the back of the star.



# TWO-FACED FLOWER



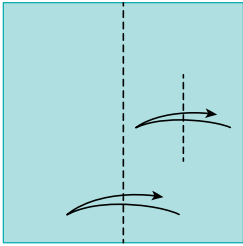

TURN OVER

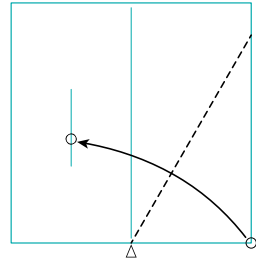

**1** Fold and unfold the paper in half to form a crease. Then fold the right edge to the vertical crease, creasing only in the middle of the square. Unfold, and turn the paper over.

**2** Using the point marked with a triangle as a pivot point, fold the lower right corner over so it reaches the most recent crease.

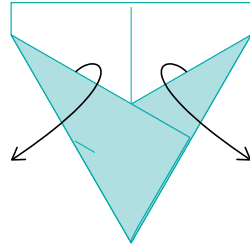
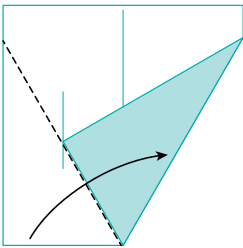

**3** Fold the lower left edge up over the right flap created in step 2.

**4** Unfold both flaps.

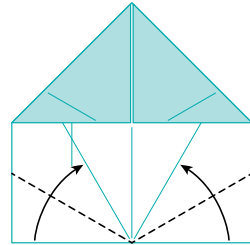
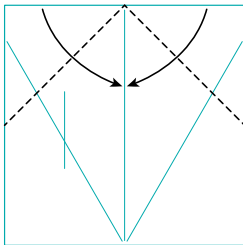

**5** Fold both top corners down to the vertical crease.

**6** Fold both lower edges up so they lay along the diagonal creases from step 4.

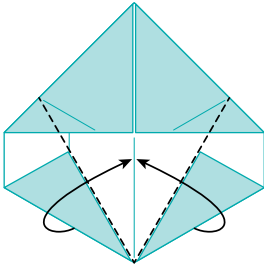

**7** Using the existing diagonal creases from step 4, fold both lower edges over to the vertical crease.

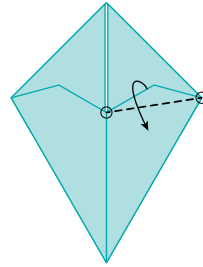

**8** On the right-hand flap, fold the small triangle down using the points marked with circles as guides.

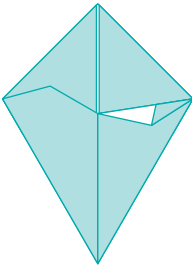

**9** Your paper should look like this. Now, turn it over.

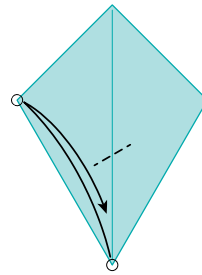

**10** Fold the bottom corner to the left corner of the unit, only making a small crease at the intersection with the vertical crease. Unfold.

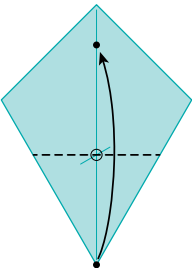

**11** Fold the lower corner at the crease made in step 10.

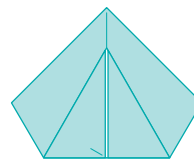

**12** This is what a complete unit should look like. Make a total of 6 units.

## ASSEMBLY

---

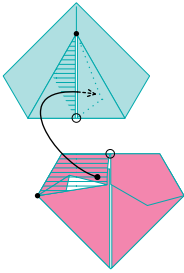

**1** Slide the flap on the pink unit inside the right pocket of the green unit, aligning the marked points. (The pink unit is shown upside down here, so you can see the flap, but you will have to flip it over to insert the flap.)

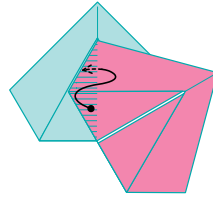

**2** Slide the shaded area on the pink unit inside the left pocket of the green unit.

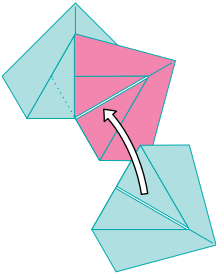

**3** Now that you have 2 units locked together, add the remaining units in the same way.

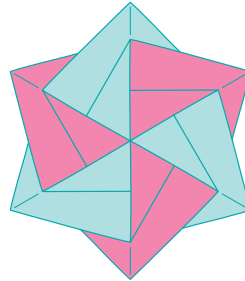

TURN OVER

Here is a completed Two-Faced Flower.  
Turn it over . . .

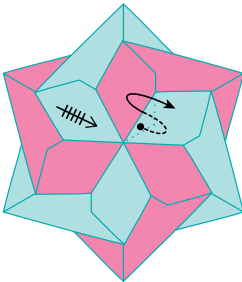

. . . and, if you like, you can rearrange the layers on this side . . .

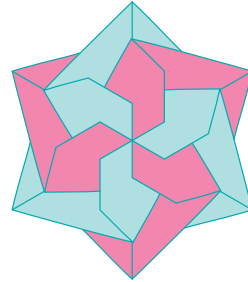

. . . to create a different pattern.

## TWO-FACED FLOWER VARIATION

---

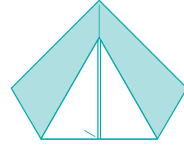
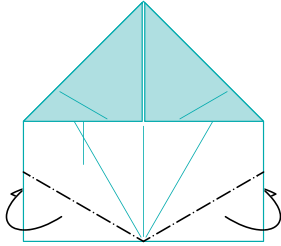

**6** Change the valley folds on step 6 of the main sequence to mountain folds, then follow the basic folding sequence. You can do this either on one or on both sides of the unit.

**7** This is what your complete unit will now look like. Follow the assembly instructions on the previous page.

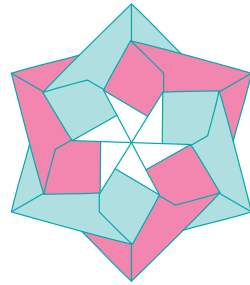
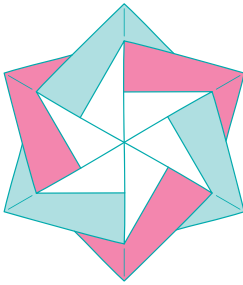

Here is one side of a completed model . . .

. . . and here is the other.

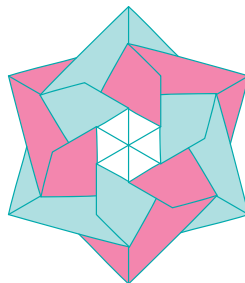

If you rearrange the layers as shown in the main sequence of the assembly instructions, this is what your model will look like.



## TWO-FACED FLOWER 3-D VARIATION

---

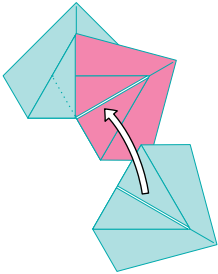

To make a 3-D flower, join 5 units using the assembly instructions on page 34.

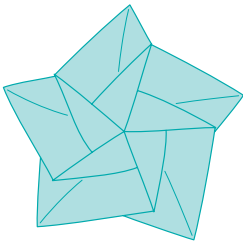

This is what your flower will look like. Turn it over . . .

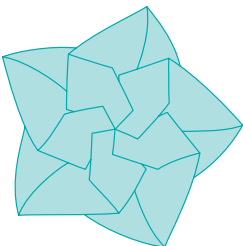

. . . to see the other side of the flower. You can shape the petals to your liking.







# FASETT SONOBE

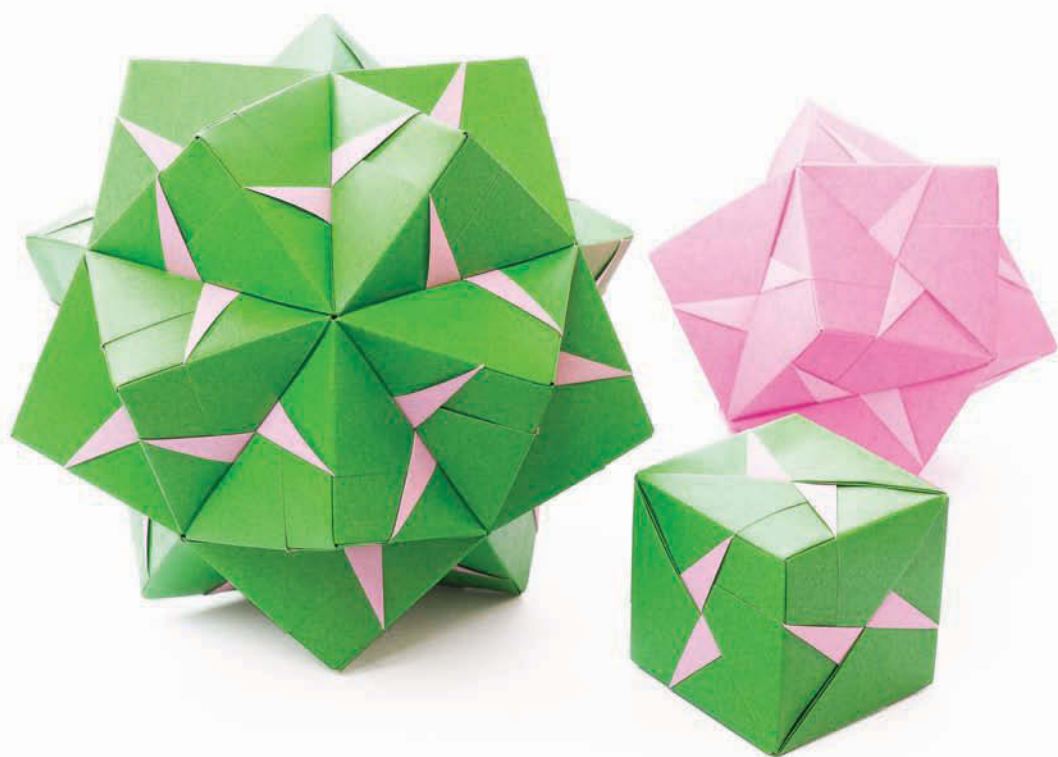

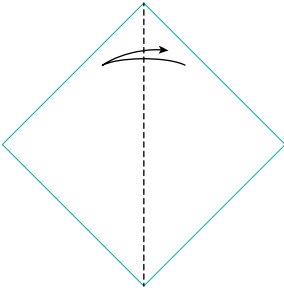

**1** Fold and unfold the paper from corner to corner to form a vertical crease.

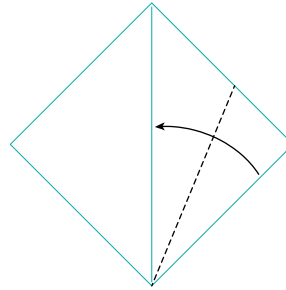

**2** Fold the lower right edge to lay along the vertical crease.

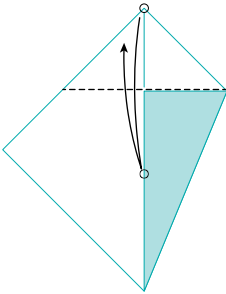

**3** Fold the top corner down against the colored edge, then unfold to form a crease. Rotate the paper 180°.

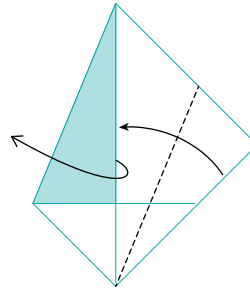

**4** Fold the lower right edge to the vertical line, then open up the left-hand flap.

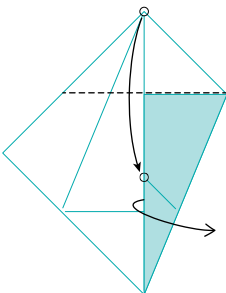

**5** Fold the top corner down against the colored edge. Open up the right-hand flap.

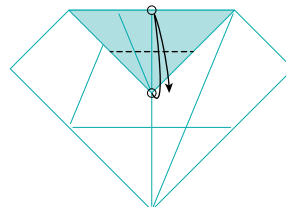

**6** Fold the lower corner of the top flap up to meet the upper edge, then unfold to form a crease.

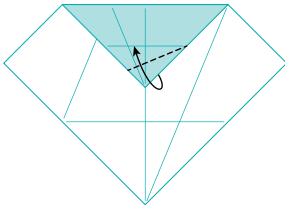

**7** Fold the lower right edge of the flap up to the most recent crease.

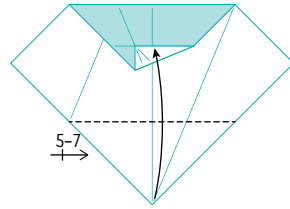

**8** Repeat steps 5-7 on the bottom side of the paper.

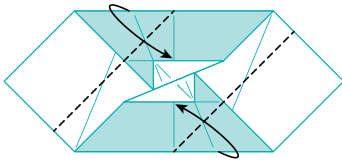

**9** Fold the bottom right edge to the center vertical crease. Repeat on the upper left side.

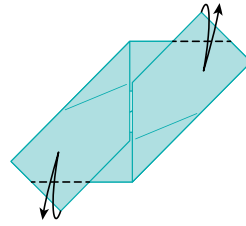

**10** Fold the small triangles, aligning them with the edges of the unit, then unfold to form creases.

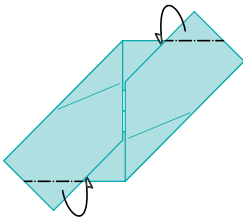

**11** Fold both corners back behind the top most layer, using the creases from step 10.

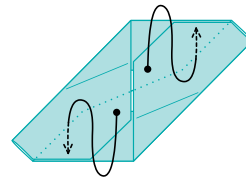

**12** Tuck both flaps of the top layer under the layers beneath them . . .

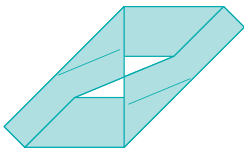

**13** . . . to look like this. Turn the paper over.

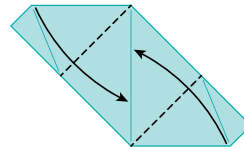

**14** Fold the bottom right edge to the vertical crease, and repeat on the top left side.

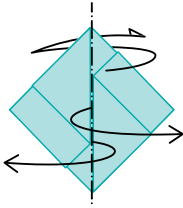

TURN OVER

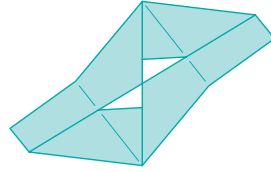

**15** Fold back along the existing vertical crease, then slightly unfold the left and right flaps. Turn over.

**16** This is what a complete unit should look like.

## 6-UNIT CUBE ASSEMBLY

---

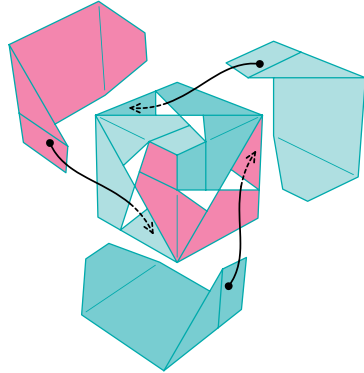
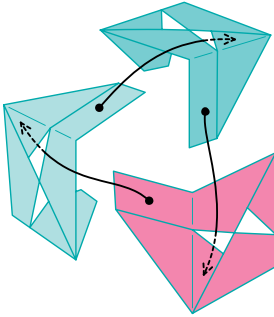

**1** To create a Fasett Sonobe Cube, make a total of 6 units. For this assembly you may skip step 15 of the main sequence.

Arrange 3 units as shown, then slide the flaps of each unit into their neighbors' pockets.

**2** The 3 joined units form 3 faces of the cube. Add 3 more units on the opposite side, inserting each flap into its appropriate pocket.

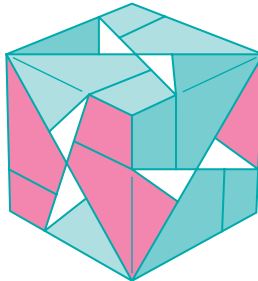

Here is a completed Fasett Sonobe Cube.

## 12-UNIT ASSEMBLY

---

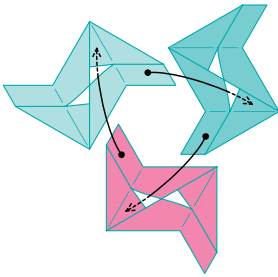

**1** To create a 12-unit Fasett Sonobe, arrange 3 units as shown, then slide the flaps into the appropriate pockets.

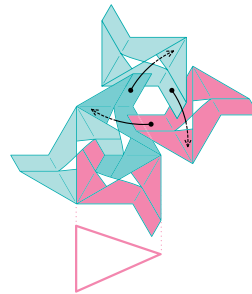

**2** Here, 3 units join to form a pyramid. Add fourth and fifth units to form a second pyramid adjacent to the first.

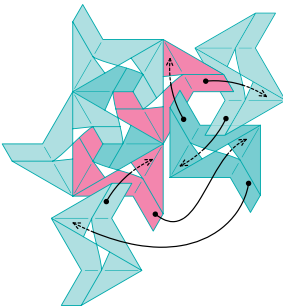

**3** Add 2 more units to form a third pyramid, then add 1 more as shown to create a ring of 4 pyramids.

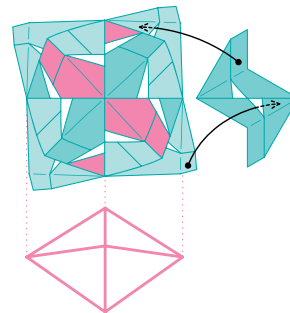

**4** Here, 8 units join to form a group of 4 pyramids. Continue adding more units in the same way, one at a time, forming pyramids in clusters of 4.

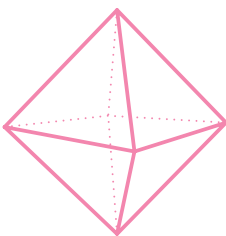

Note that the 12 units in this assembly type will correspond to the 12 edges of an octahedron.

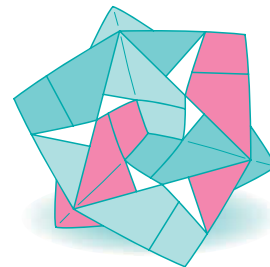

Your 12-unit Fasett Sonobe is now complete!

## 30-UNIT ASSEMBLY

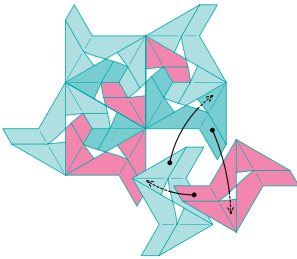

**1** To create a 30-unit Fasett Sonobe, form 3 pyramids next to each other as shown in steps 1–3 on the previous page. Now, add 2 more units to make a fourth pyramid.

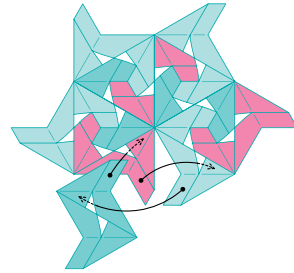

**2** Add 1 more unit as shown to create a ring of 5 pyramids.

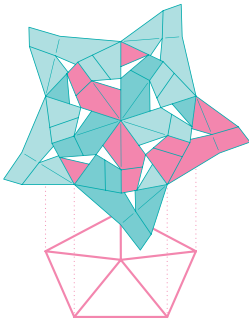

**3** Here, 10 units join to form a group of 5 pyramids.

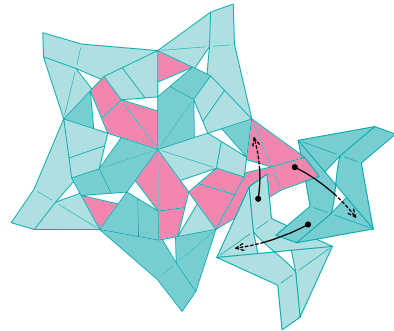

**4** Continue adding more units in the same way, one at a time, forming pyramids in clusters of 5.

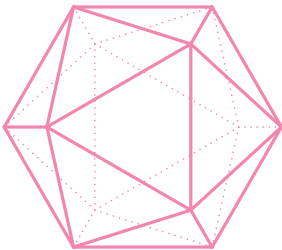

Note that the 30 units in this assembly correspond to the 30 edges of an icosahedron.

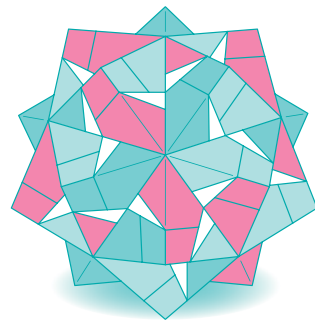

This is what a 30-unit Fasett Sonobe will look like.



## 90-UNIT ASSEMBLY: VIEW 1

---



In this type of assembly, clusters of 5 and 6 pyramids are combined into a single shape.

A total of 90 units (60 pink and 30 green units) were used to make the model. Each unit of the structure corresponds to a colored line on the polyhedron shown here.

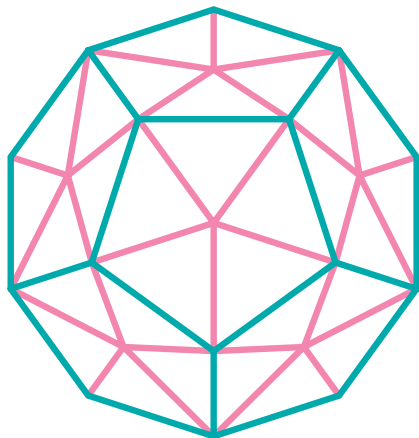

## 90-UNIT ASSEMBLY: VIEW 2

---



This is another view of what a 90-unit sonobe looks like. The underlying polyhedron on the right is rotated accordingly. Note how some clusters consist of 6 pyramids, while others consist of 5.

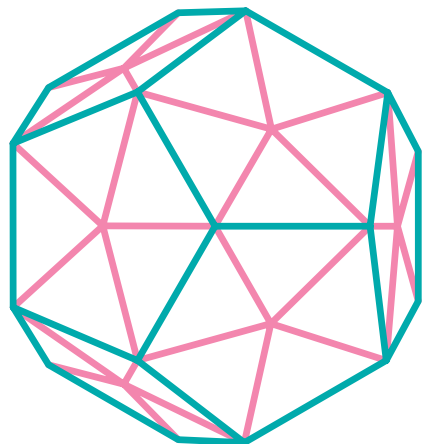

## 120-UNIT ASSEMBLY: VIEW 1

---



In this type of assembly, clusters of 5 and 6 pyramids are combined into a single shape.

A total of 120 units (60 pink and 60 green units) were used to make the model. Each unit of the structure corresponds to a colored line on the polyhedron shown here.

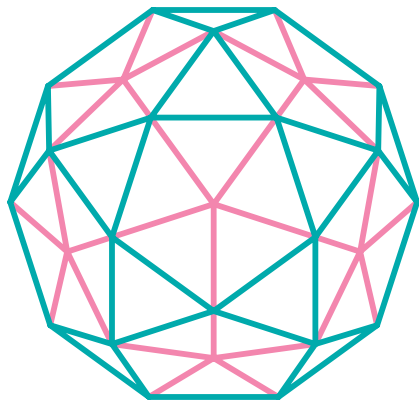

## 120-UNIT ASSEMBLY: VIEW 2

---



This is another view of what a 120-unit sonobe looks like. The underlying polyhedron on the right is rotated accordingly. Note how some clusters consist of 6 pyramids, while others consist of 5.

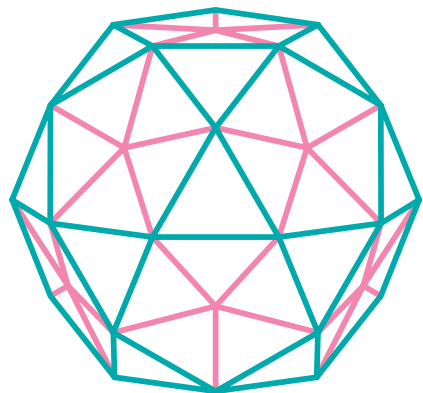

## FASETT SONOBE VARIATION

---

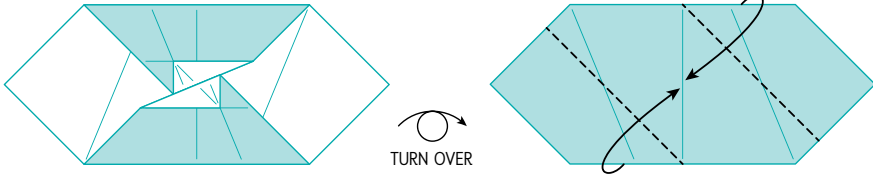

**9** Complete up to step 9 of the main sequence on pages 39–40. Turn the paper over.

**10** Fold the upper right edge to the central vertical crease. Repeat on the lower left side.

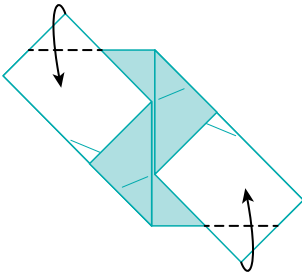

**11** Fold both small triangles, aligning their bases with the edges of the unit.

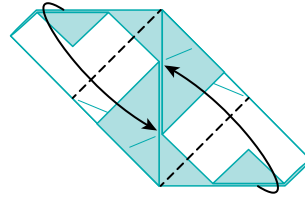

**12** Fold the lower right edge to the vertical crease. Repeat on the upper left side.

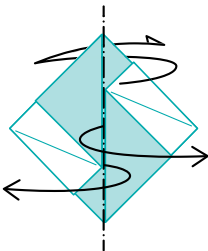

**13** Fold the unit back along the central crease, then open the flaps on both sides, but do not flatten the unit. Turn over.

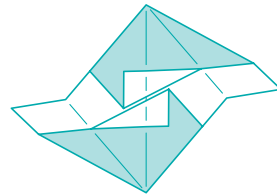

**14** This is what a complete unit should look like. You can create this Fasett Sonobe variation with the same amount of units as the basic model.

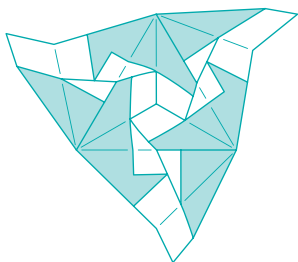

**15** Assemble in the same way as the basic model.

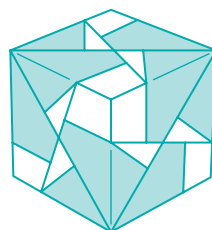

Here are a 6-unit . . .

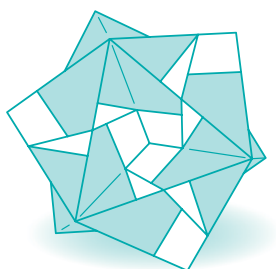

. . . a 12-unit . . .

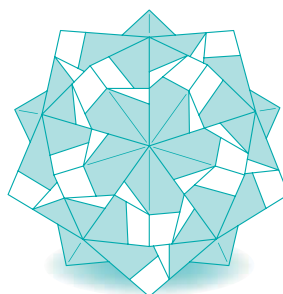

. . . and a 30-unit Fasett Sonobe variation.

## FASETT SONOBE PINWHEEL VARIATION

---

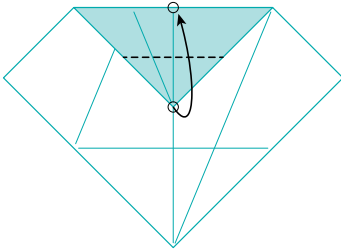

**6** Complete up to step 6 of the main sequence (see page 39). Fold the bottom corner of the flap up to the top edge of the unit.

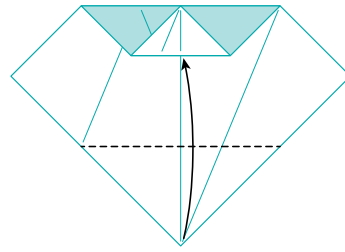

**7** Using the existing crease, fold the lower corner up.

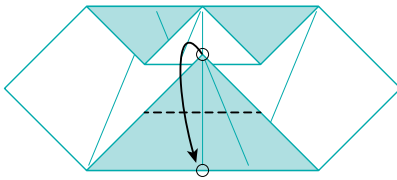

**8** Fold the upper corner of the flap down to the bottom edge of the unit.

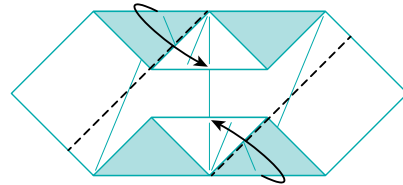

**9** Now follow the main folding sequence starting from step 9 (see pages 40–41).

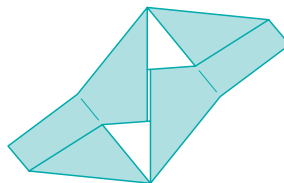

**10** This is what a complete unit for the Pinwheel Fasett Sonobe should look like. Assemble in the same way as the basic model.



Here are a 6-unit . . .



. . . a 12-unit . . .

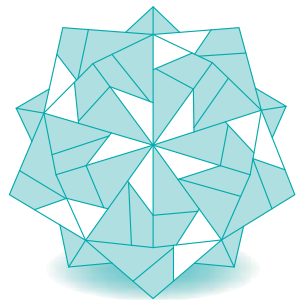

. . . and a 30-unit Pinwheel  
Fasett Sonobe.





LORENCE  
SONOBE

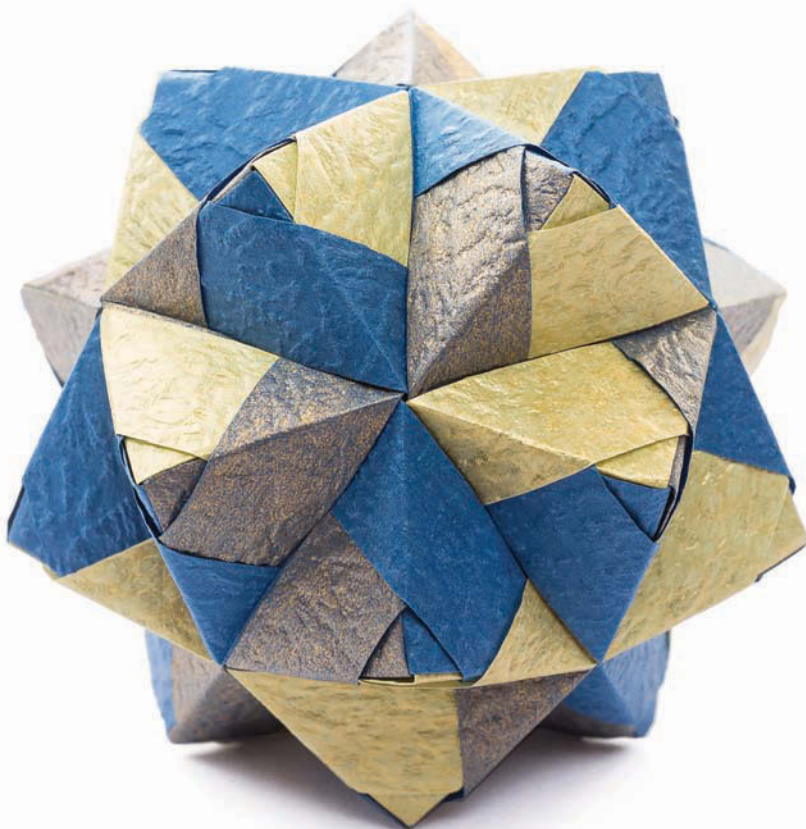

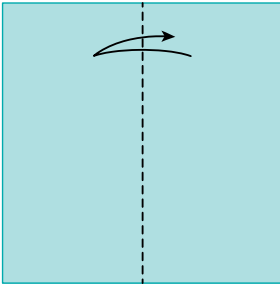

**1** Fold and unfold the paper in half from side to side to form a crease.

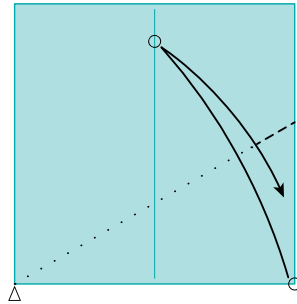

**2** Using the lower left corner as a pivot point, bring the lower right corner to the vertical crease, make a small pinch on the right edge, and unfold.

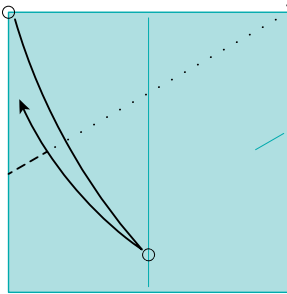

**3** Repeat the previous step on the top left side as shown. Turn the paper over.

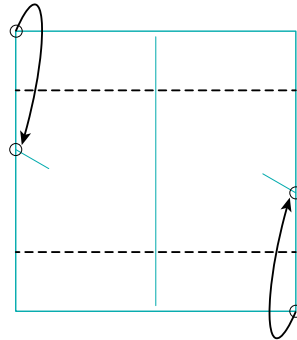

**4** Fold the lower edge up to the pinch mark, then repeat on the top edge.

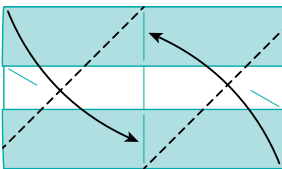

**5** Fold the lower right corner to the vertical crease. Repeat with the top left corner.

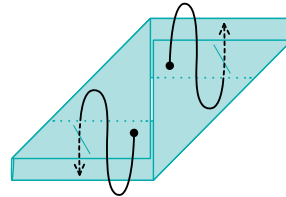

**6** Rearrange the layers on both sides of the unit, so the flap underneath the top layer comes up and becomes the top layer.

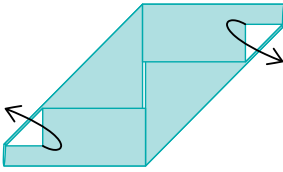

TURN OVER

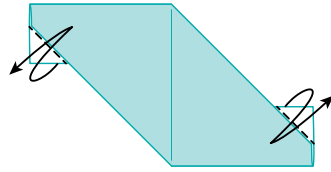

**7** Unfold both little corners, then turn the paper over.

**8** Fold the right little corner over the edge of the unit, then unfold to form a crease. Repeat with the left little corner.

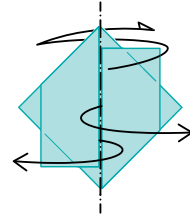
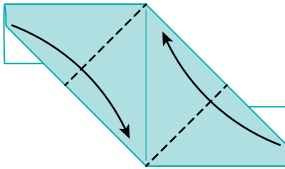

TURN OVER

**9** Fold the lower right corner to the central crease. Repeat with the top left corner.

**10** Fold the unit back along the central crease, then open the flaps on both sides, but do not flatten the unit. Turn over.

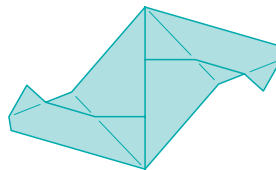

**11** This is what a complete unit should look like. Make a total of 12 or 30 units.

## ASSEMBLY

---

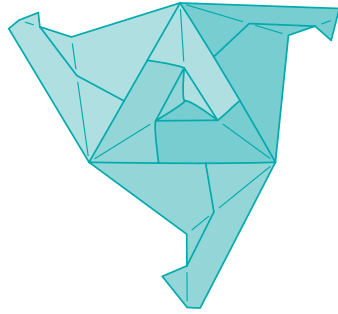
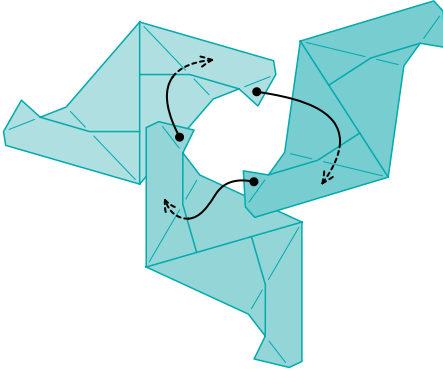

**1** Arrange the units as shown here, then slide the flap of a unit inside the pocket of another unit, making sure the small corner of the flap wraps around the contour of the adjacent unit. Add a third unit in the same way to form a pyramid.

**2** Here are 3 units joined to create a pyramid. Keep adding more units, one at a time, forming new pyramids adjacent to the first.

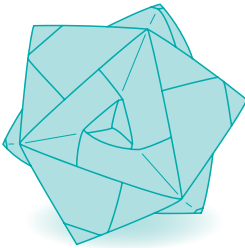

Here are a 12-unit ...

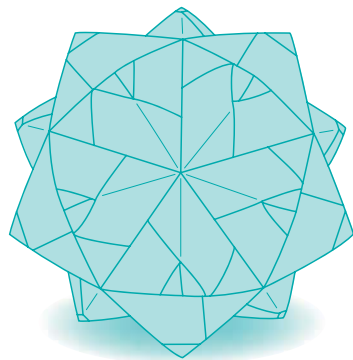

... and a 30-unit Lorence Sonobe.

## LORENCE SONOBE VARIATION

---

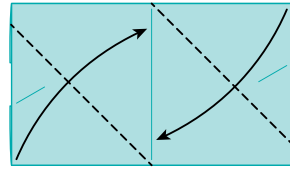
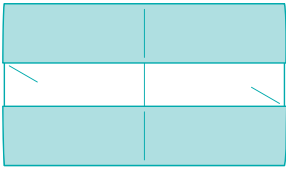

**5** Complete up to step 5 of the main sequence (see page 53), then turn the paper over.

**6** Fold the top right corner down to the vertical crease. Repeat with the lower left corner.

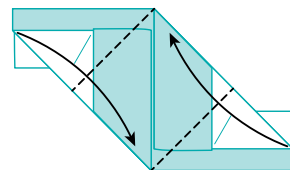
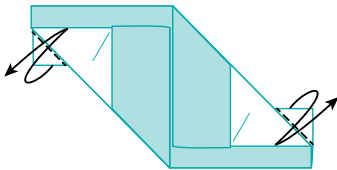

**7** Fold the small right corner over the edge of the unit, then unfold to form a crease. Repeat on the left side.

**8** Fold the lower right corner to the central crease. Repeat on the upper left side.

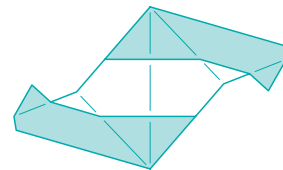
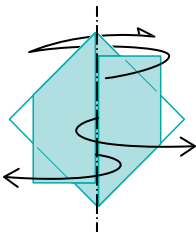

**9** Fold the unit back along the central crease, then open the flaps on both sides, but do not flatten the unit. Turn over.

**10** This is what a complete unit should look like for the Lorence Sonobe variation. Make a total of 12 or 30 units.

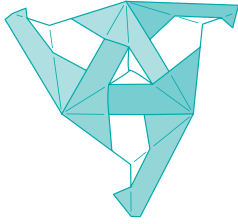

**11** Assemble in the same way as the basic model.

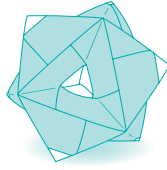

Here are a 12-unit ...

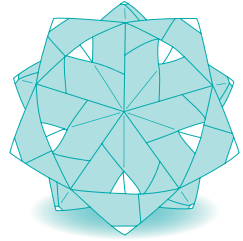

... and a 30-unit model.

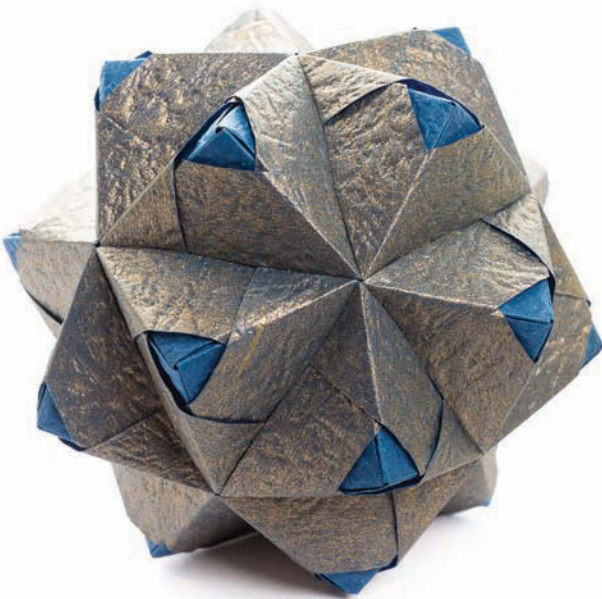

FLORENCE  
SONOBE

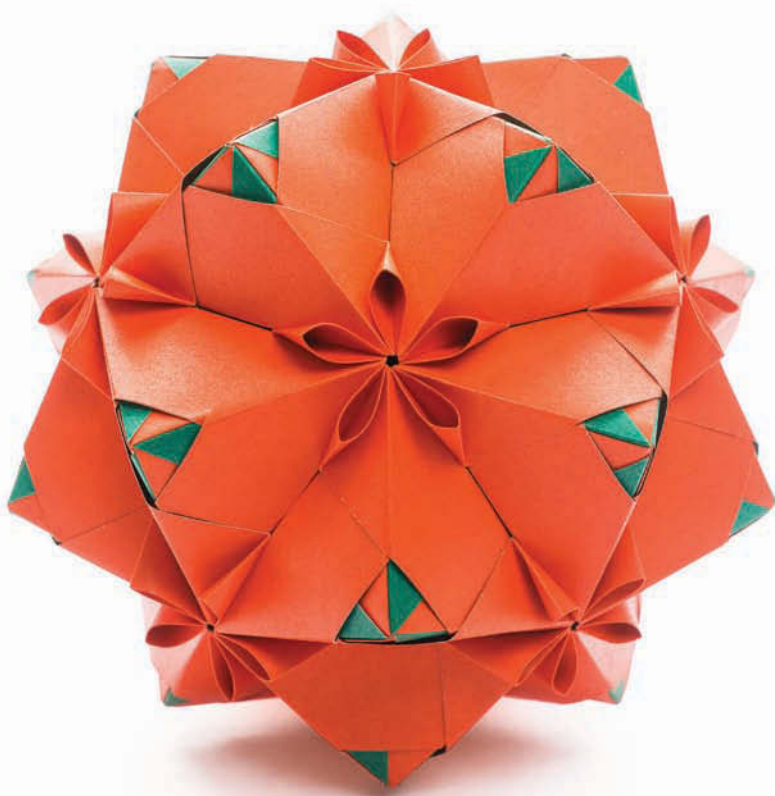

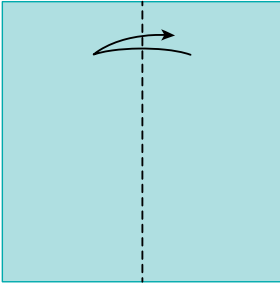

**1** Fold and unfold in half from side to side to form a crease.

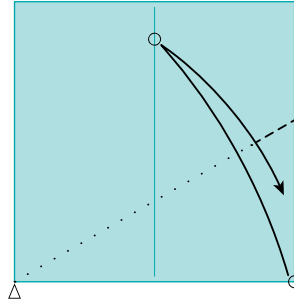

**2** Using the lower left corner as a pivot point, bring the lower right corner to the vertical crease, make a small pinch on the right edge, and unfold.

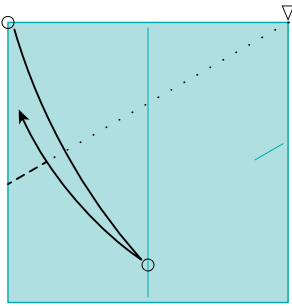

**3** Repeat the previous step on the top left side of the paper as shown. Turn the paper over.

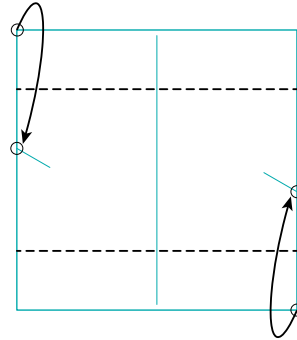

**4** Fold the lower edge up to the pinch mark, then repeat on the top edge.

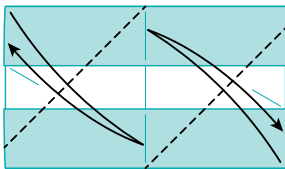

**5** Fold the lower right corner to the vertical crease, then unfold. Repeat with the top left corner.

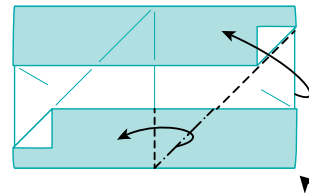

**6** Using the existing creases, bring the lower right corner to the central crease, opening up and squashing the top layer as shown.



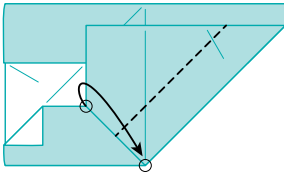

**7** Fold the top layer down, so that the points marked by circles meet.

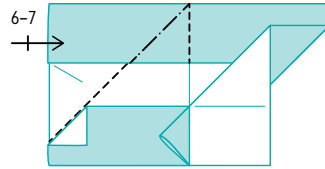

**8** Repeat steps 6-7 on the top left corner of the unit.

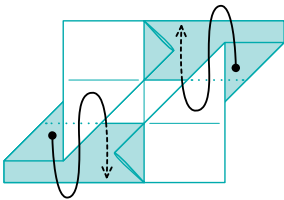

**9** Rearrange the layers on both sides of the unit, so the flap underneath the top layer comes up and becomes the top layer.

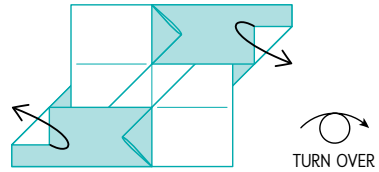

**10** Unfold both little corners, then turn the paper over.

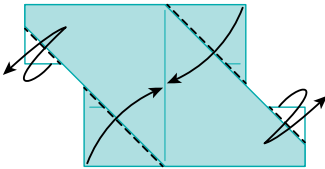

**11** Fold the bigger corners over the edges of the unit. Then fold and unfold the smaller corners to reinforce the creases.

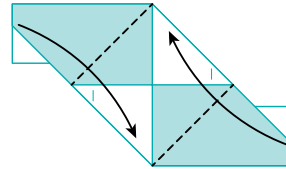

**12** Fold the lower right corner up to the vertical crease, then repeat with the top left corner.

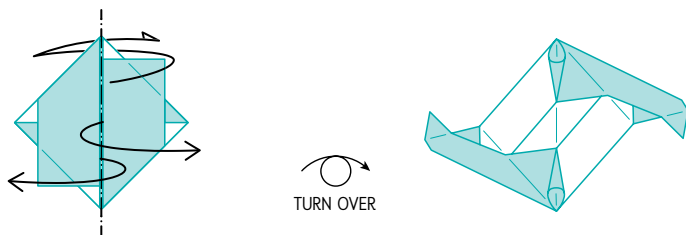

**13** Fold the unit back along the central crease, then open the flaps on both sides, but do not flatten the unit. Turn over.

**14** This is what a complete unit should look like. Make a total of 30 units.

## ASSEMBLY

---

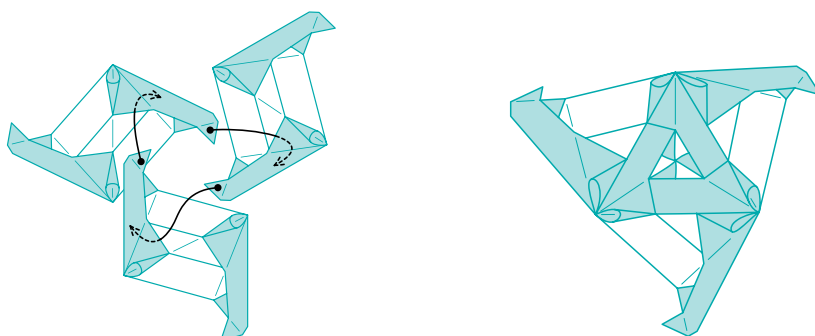

**1** Assemble in the same way as the Lorence Sonobe (see page 55), making sure that the corner of each flap is wrapping around the contour of the adjacent unit.

**2** Here are 3 units joined. Continue adding more units, one at a time, to finish the model.

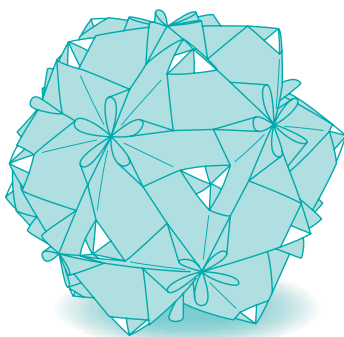

Here is a completed 30-unit Florence Sonobe.

GEMSTONE  
SONOBE



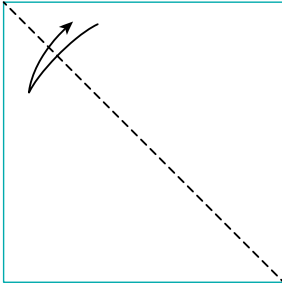

**1** Fold and unfold the paper to form a diagonal crease.

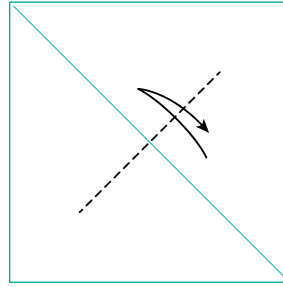

**2** Fold the lower right corner to the top left corner, creasing only in the middle of the square, and unfold.

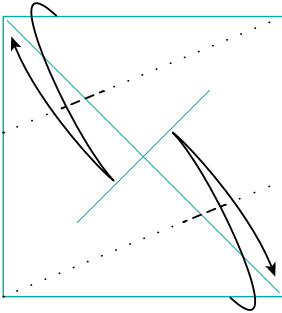

**3** Fold the lower edge along the most recent crease, only making a short crease on the diagonal. Repeat with the upper edge.

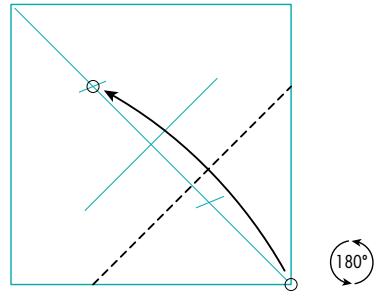

**4** Fold the lower right corner to the farthest crease. Rotate the paper 180°.

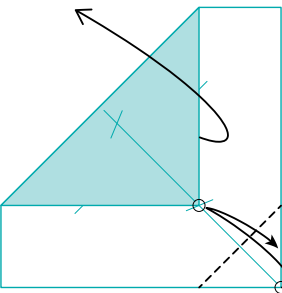

**5** Fold the lower right corner to meet the corner of the upper left flap, then unfold both corners to form creases.

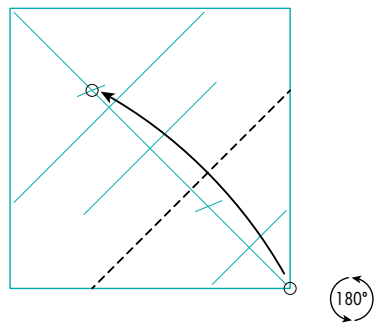

**6** Repeat step 4.

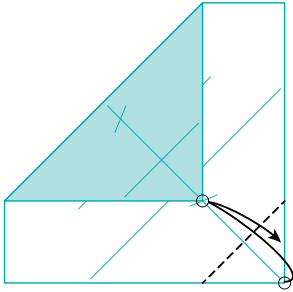

**7** Fold the lower right corner to meet the corner of the upper left flap, then unfold to form a crease.

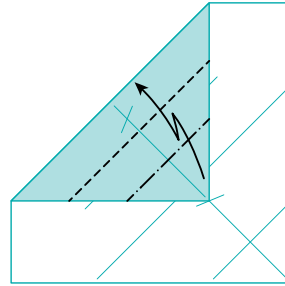

**8** Pleat fold the top layer as shown.

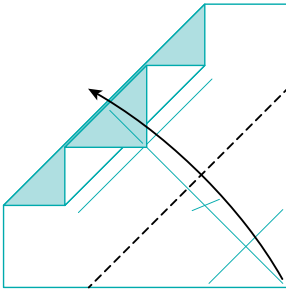

**9** Fold the lower right corner over, using the existing crease.

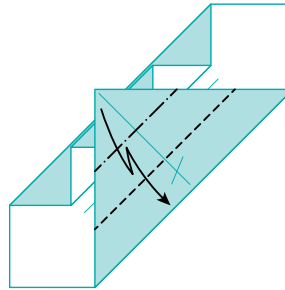

**10** Repeat the pleat fold from step 8 on this side.

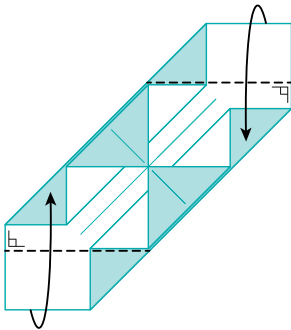

**11** Fold the top edge down so that the crease runs along the white edge of the paper. Repeat on the other side.

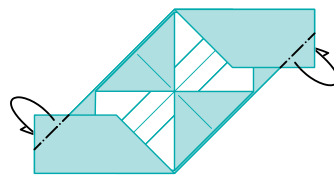

**12** Fold in the small triangles along the edges of the unit.

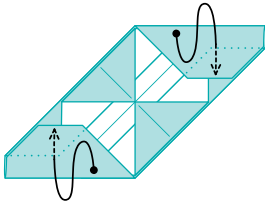

**13** Rearrange the layers on both sides of the unit, so the flap underneath the top layer comes up and becomes the top layer.

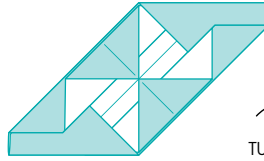

**14** Your unit should now look like this. Turn it over.

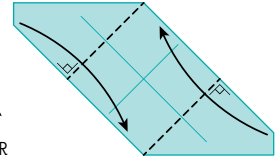

**15** Fold the lower right corner up as shown, aligning it with the edge of the unit.

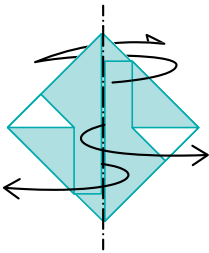

**16** Fold the unit back along the central crease, then open the flaps on both sides, but do not flatten the unit. Turn over.

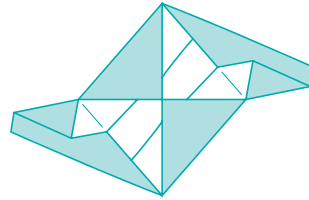

**17** This is what a complete unit should look like. Make a total of 30 units.

## ASSEMBLY

---

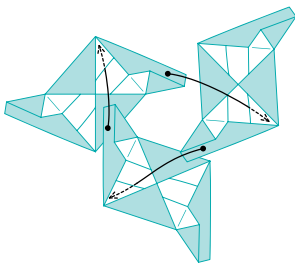

**1** Arrange the units as shown here. Slide the flap of a unit inside the pocket of another unit. Add a third unit in the same way to form a pyramid.

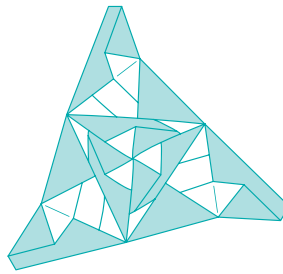

**2** Here are 3 units joined to create a pyramid. Continue adding more units, one at a time, in the same manner.

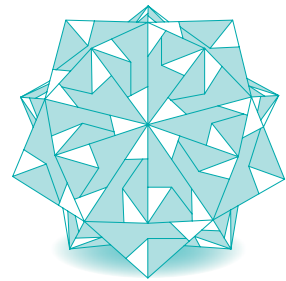

Here is a completed 30-unit Gemstone Sonobe.

ESTE  
SONOBE

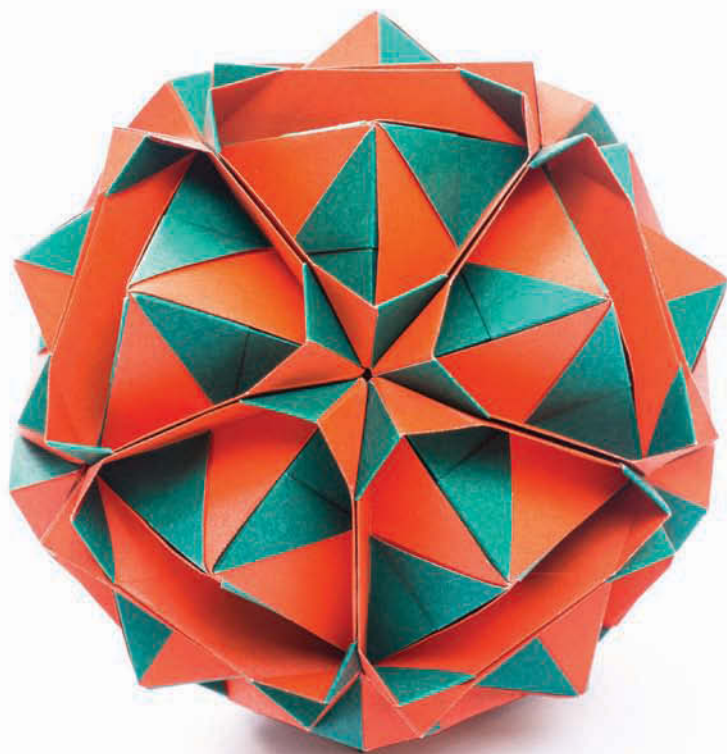

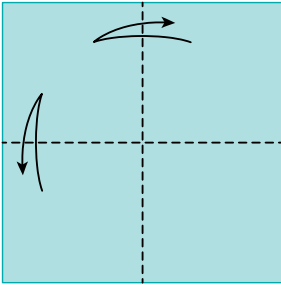

**1** Fold and unfold the paper in half vertically and horizontally.

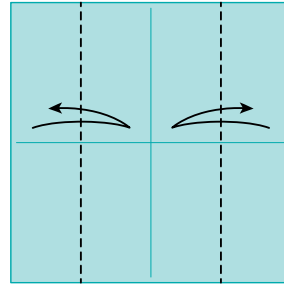

**2** Fold both vertical edges to the vertical crease, and then unfold.

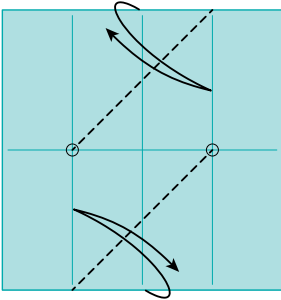

**3** Fold the right part of the lower edge up to the left vertical crease, only creasing in the lower half of the square. Unfold and repeat with the left part of the top edge.

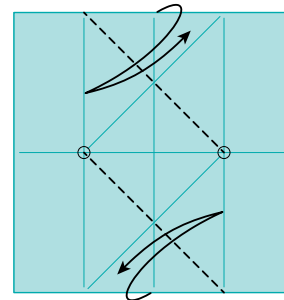

**4** Repeat step 3 with the left part of the lower edge and the right part of the upper edge.

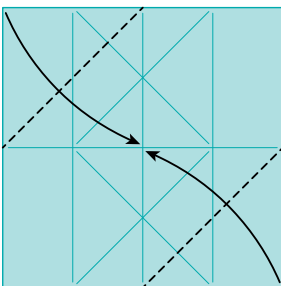

**5** Fold the lower right and the upper left corners to the center.

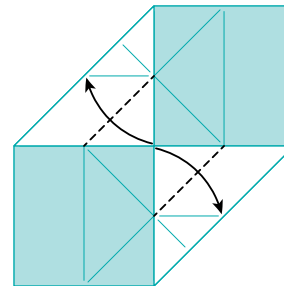

**6** Fold both corners of the white flaps as shown.



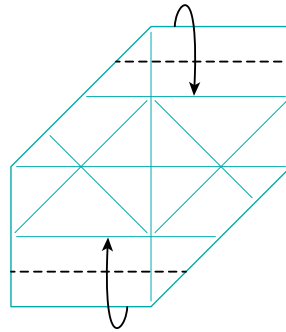
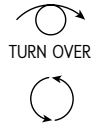
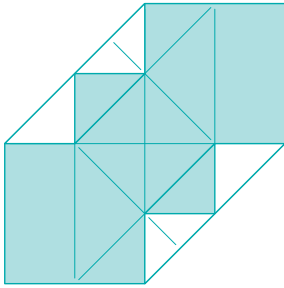

**7** This is what your paper should look like. Turn it over and rotate to match the next picture.

**8** Fold the lower edge to the nearest horizontal crease. Repeat with the upper edge.

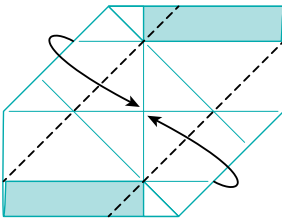

**9** Using the existing crease, fold the lower right edge over to the center. Repeat with the top left edge.

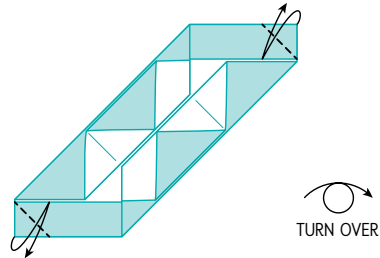

**10** Fold the top right corner to the nearest horizontal edge. Unfold. Repeat on the bottom left corner. Turn the paper over.

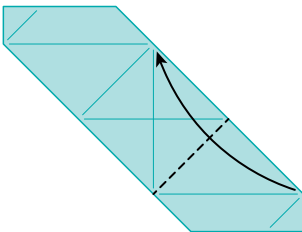

**11** Using the existing crease, fold the lower right flap upward.

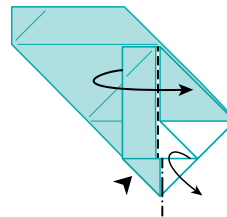

**12** Fold the vertical colored edge to the right on the existing crease while simultaneously opening up and flattening the lower part of the flap.

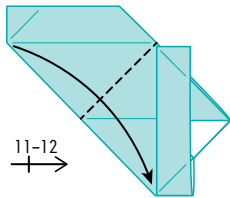

**13** This is what your paper should look like. Repeat steps 11-12 with the top flap.

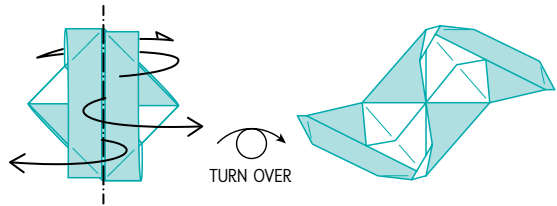

**14** Fold the paper back along the central crease, then slightly unfold the flaps. Turn over.

**15** This is what a complete unit should look like. Make a total of 30 units.

## ASSEMBLY

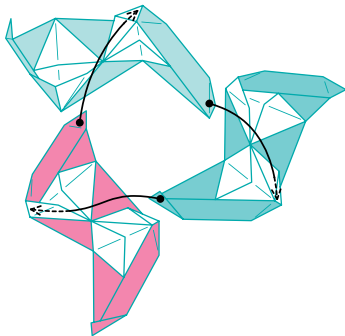

**1** Slide the small corner at the end of the flap inside the pocket on the rim of another unit.

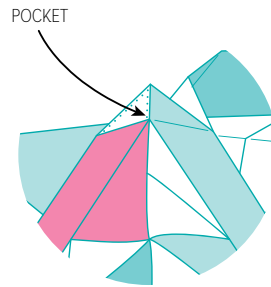

Here is a close-up look at a flap inside a pocket.

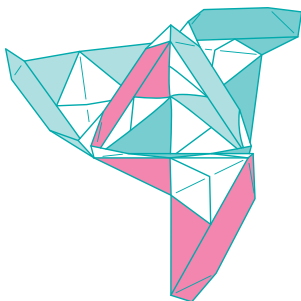

**2** Here are 3 units joined together, forming a pyramid. Continue adding more units in the same way, one at a time, to finish the model.

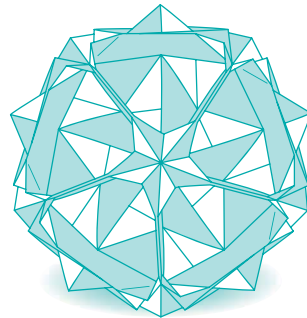

Here is a completed 30-unit Este Sonobe.

ESTERRE  
SONOBE

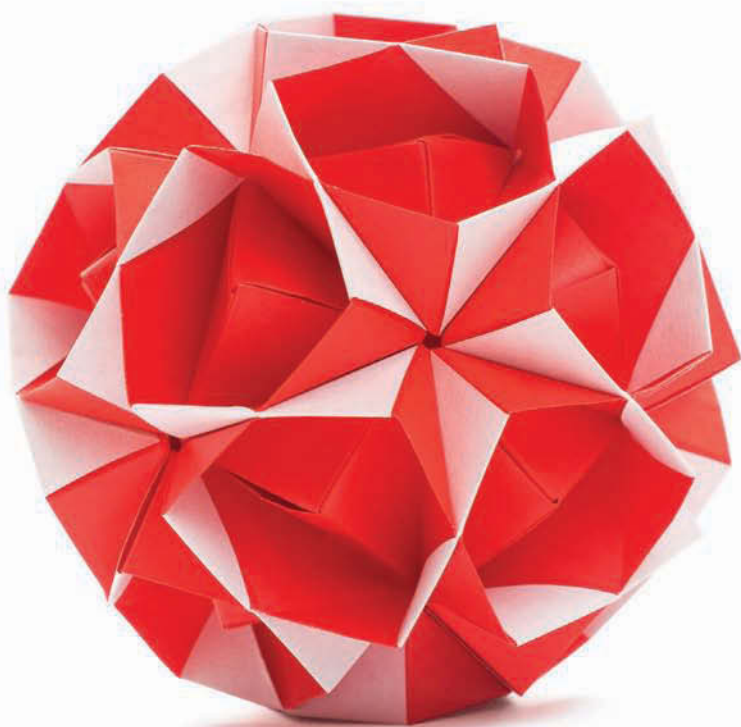

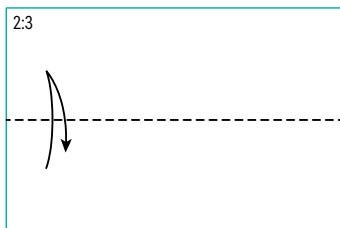

**1** Start with a 2:3 rectangle (see pages 20–21), then fold and unfold from top to bottom.

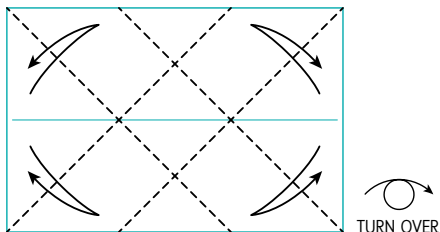

**2** Fold the right-hand edge to the top edge and unfold. Continue in this manner to complete the pattern of diagonal creases shown here. Turn the paper over.

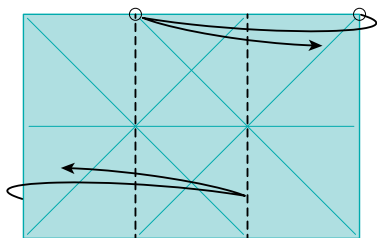

**3** Fold the top right corner to the end of the diagonal crease as shown, then unfold. Repeat on the left side.

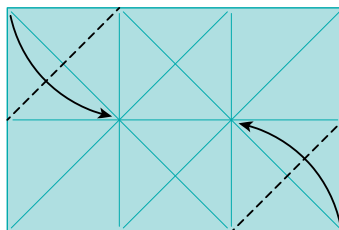

**4** Fold the lower right corner up to the nearest crease intersection. Repeat on the top left corner.

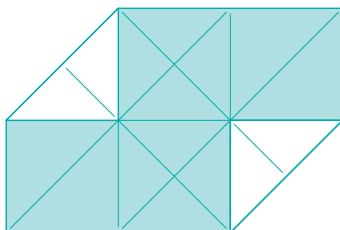

**5** This is what your paper should look like. Turn it over.

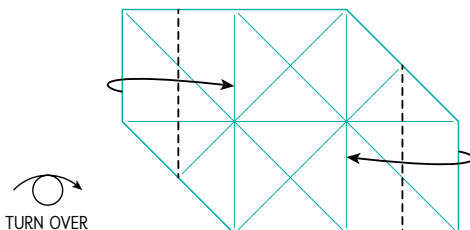

**6** Fold the right edge to the nearest vertical crease. Repeat on the left edge.

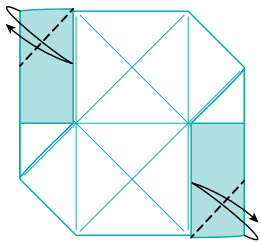

**7** Fold and unfold the colored edges inward as shown. Rotate the paper 90° clockwise.

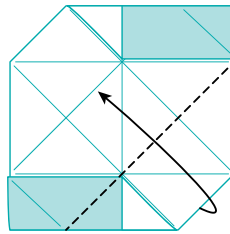

**8** Using the existing crease, fold the lower right edge over to the far diagonal crease.

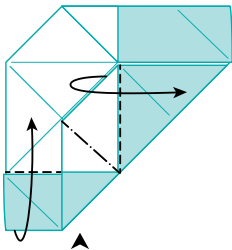

**9** Fold the white section of the top layer to the right while simultaneously folding the left part of the lower edge up.

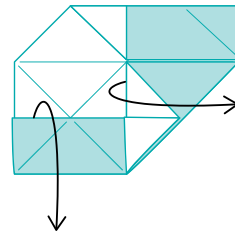

**10** This is what your paper should look like. Unfold back to step 8.

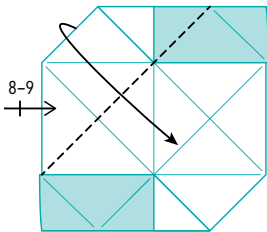

**11** Repeat steps 8-9 on the top left side of the unit.

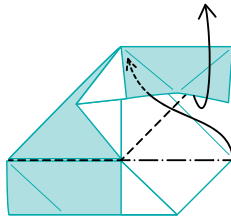

**12** Fold the lower right corner inward, slightly opening the topmost layer. At this point, the unit becomes 3-D.

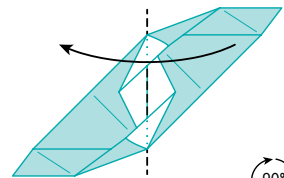

**13** Keeping the rims of the unit upright, fold the right-hand half of the unit to the left along the central crease and flatten. Rotate 90° clockwise.

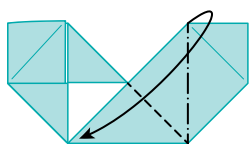

**14** Using the existing crease, fold the right-hand flap down to the bottom edge while forming a mountain fold as shown. The lower right corner will naturally fold out.

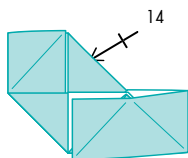

**15** This is what your paper should look like. Turn the paper over and repeat the previous step on the other flap. Slightly unfold the unit.

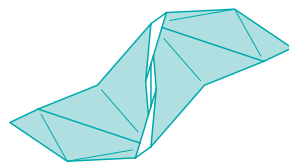

**16** This is what a complete unit should look like. Make a total of 30 units.

## ASSEMBLY

---

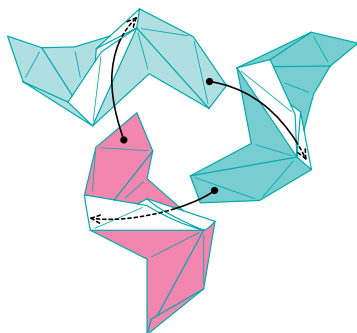

**1** Slide the corner at the end of a flap inside the pocket on the rim of another unit.

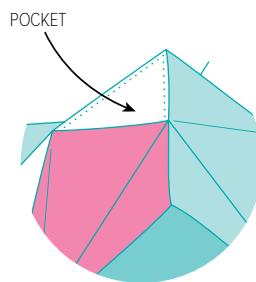

Here is a close-up look at a flap inside a pocket.

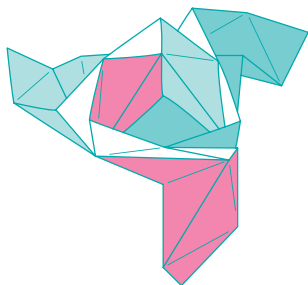

**2** Here are 3 units joined together, forming a pyramid. Continue adding more units in the same way, one at a time, to finish the model.

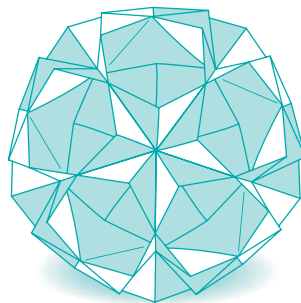

Here is a completed 30-unit Esterre Sonobe. Well done!

ISOLDE  
SONOBE

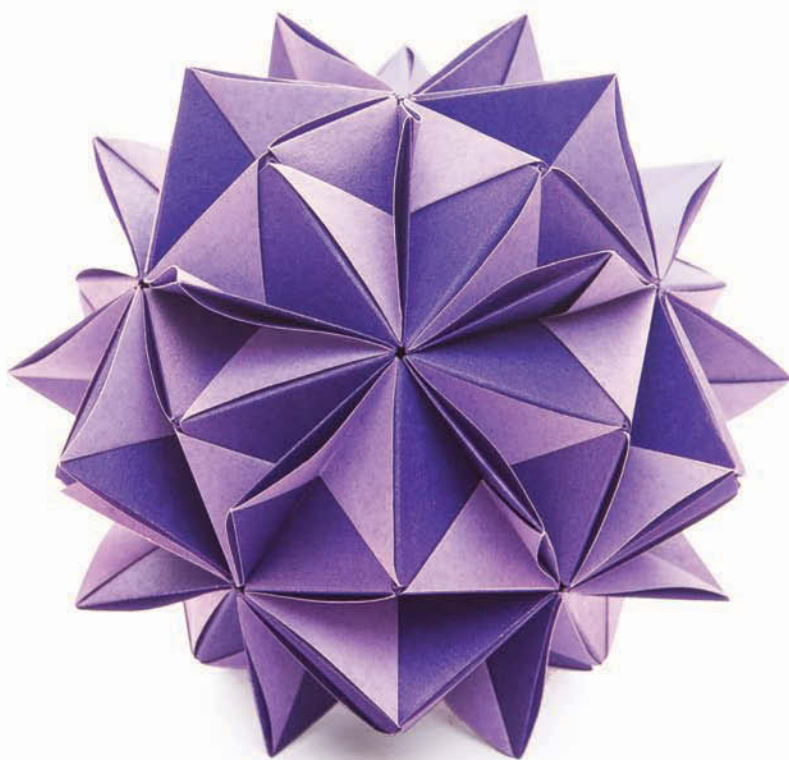

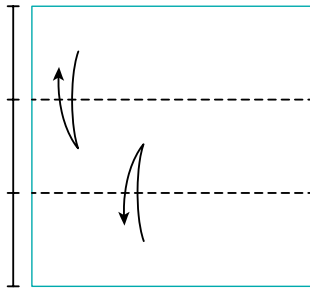

**1** Fold and unfold the paper in horizontal thirds (see pages 15–19). Turn over.

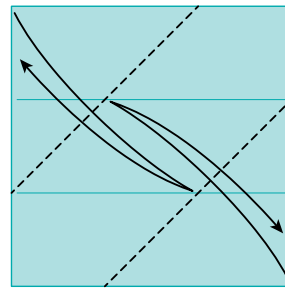

**2** Fold the bottom right corner up to the far horizontal crease. Unfold. Repeat on the top left corner, and then turn the paper over.

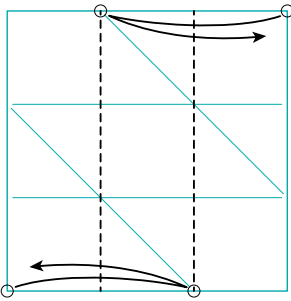

**3** Using the most recent creases for reference, fold and unfold the paper into vertical thirds.

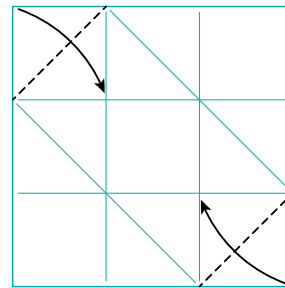

**4** Fold the lower right and the upper left corners to meet the nearest intersections.

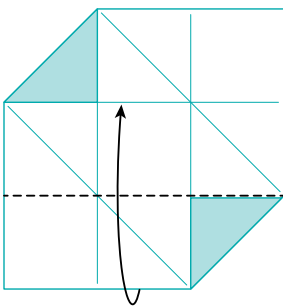

**5** Fold the lower edge up using the existing crease.

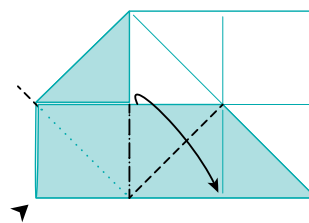

**6** Fold the paper over along the valley fold line, while squashing the lower left corner as shown.



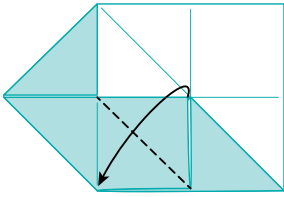

**7** Fold the inner corner down to the lower left corner of the unit.

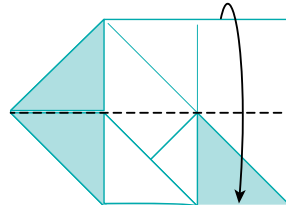

**8** Fold the top edge down using the existing crease.

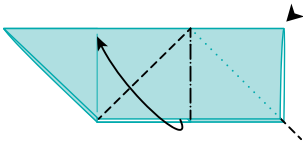

**9** Repeat step 6 on the other side of the unit.

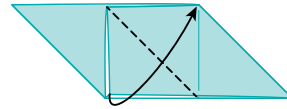

**10** Repeat step 7 on this side.



**11** Rearrange the layers as shown, so the underlying left flap comes up to lay on top.

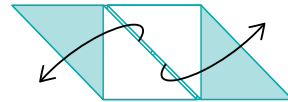

**12** Slightly open up the top layers.

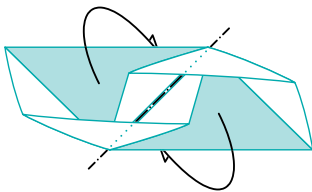

**13** Fold both flaps back along the central crease, bringing both flaps down and flattening the unit. Rotate to match the next picture.

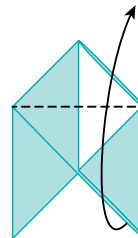

**14** Fold the right-hand flap up.

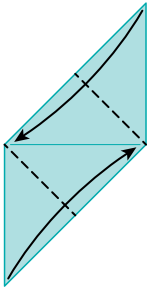

**15** Fold both flaps to the central crease as shown.

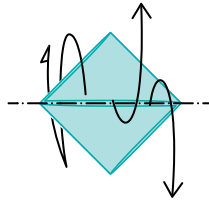

**16** Fold the unit back along the central crease, then slightly unfold the flaps. Turn over.

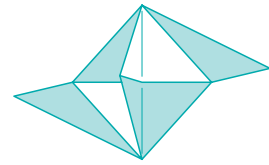

**17** This is what a complete unit should look like. Make a total of 30 units.

## ASSEMBLY

---

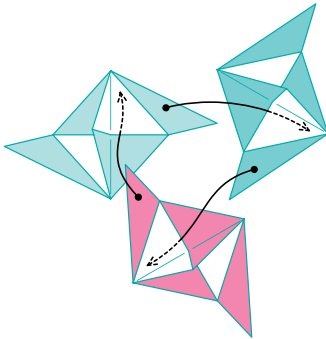

**1** Slide the flap of a unit inside the pocket of another unit. Add a third unit in the same way to form a pyramid.

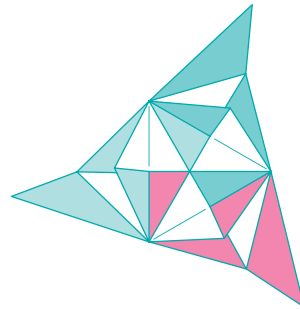

**2** Here are 3 units joined together, forming a pyramid. Continue adding more units in the same way, one at a time, to finish the model.

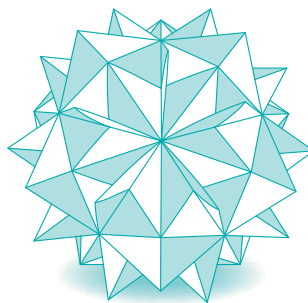

Congratulations! You have completed a 30-unit Isolde Sonobe.

SELENE  
SONOBE



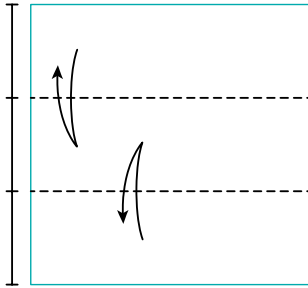

**1** Fold and unfold the paper in horizontal thirds (see pages 15–19).

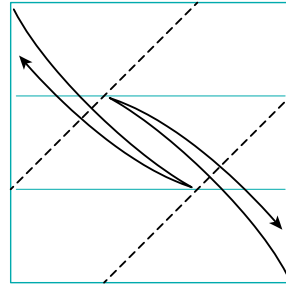

**2** Fold the bottom right corner up to the far horizontal crease. Unfold. Repeat on the top left corner.

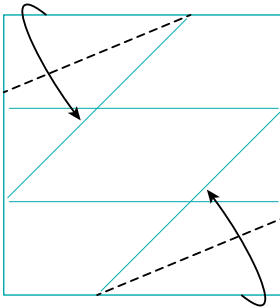

**3** Fold right part of the the lower edge to lay along the nearest diagonal crease. Repeat on the other side.

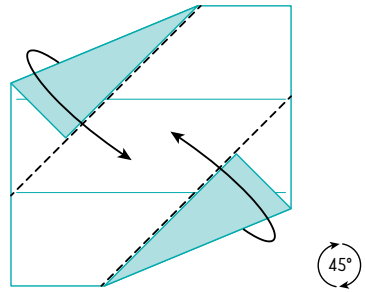

**4** Fold the colored edges inward. Rotate the paper 45° clockwise.

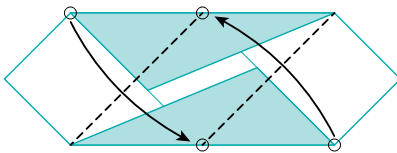

**5** Using the top right corner as a guide, fold the lower right corner up to meet the top horizontal edge. Repeat on the left side.

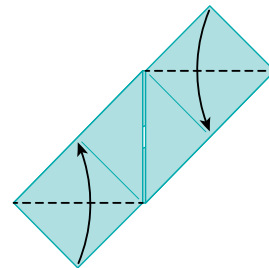

**6** Fold the corners inward, aligning them with the edges of the unit.

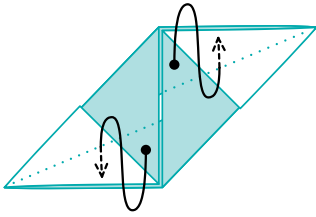

**7** Rearrange the layers as shown.

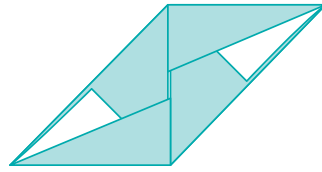

**8** This is what your paper should look like. Turn the paper over.

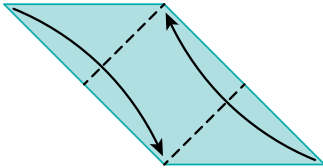

**9** Fold both the right and left corners over on the existing creases.

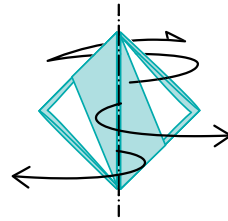

**10** Fold the unit back along the central crease, then slightly unfold the flaps. Turn over.

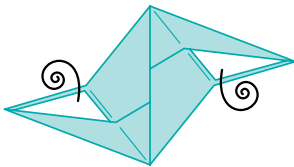

**11** Curl the white flaps.

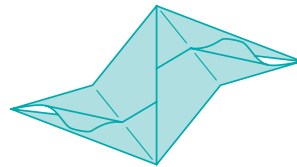

**12** This is what a complete unit should look like. Make a total of 12 or 30 units.

## ASSEMBLY

---

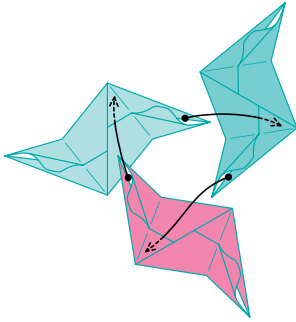

**1** Slide the flap of a unit inside the pocket of another unit. Add a third unit in the same way to form a pyramid.

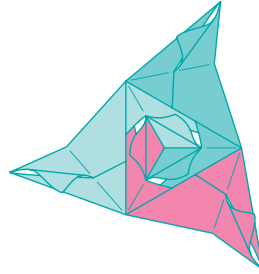

**2** Here are 3 units joined together, forming a pyramid.

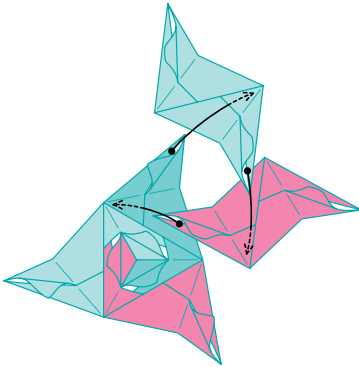

**3** Continue adding more units in the same way to finish the model.

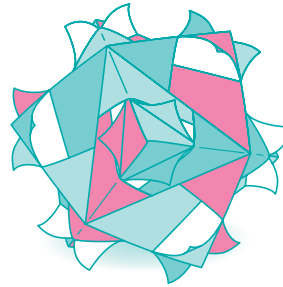

Here are a 12-unit . . .

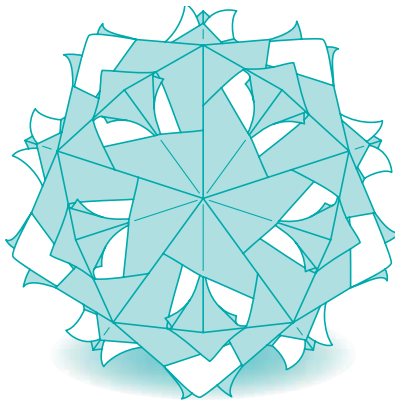

. . . and a 30-unit Selene Sonobe!

## SELENE SONOBE VARIATION

---

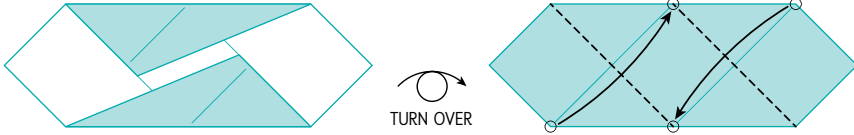

**5** Complete up to step 5 of the main sequence (see page 79). Turn the paper over.

**6** Fold the top right corner to the lower edge so that it meets the end of the crease. Repeat on the left side.

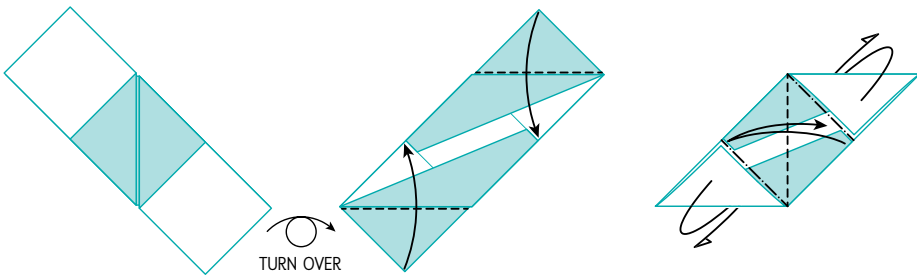

**7** This is what your paper should look like. Turn the paper over.

**8** Fold the corners inward, aligning them with the edges of the unit.

**9** Make all the mountain and valley folds shown here.

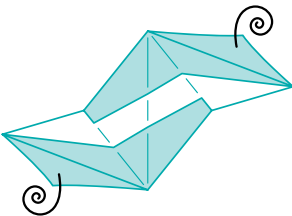

**10** Curl the corners on both sides of the unit.

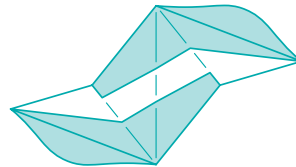

**11** This is what a complete unit should look like. Make a total of 30 units.

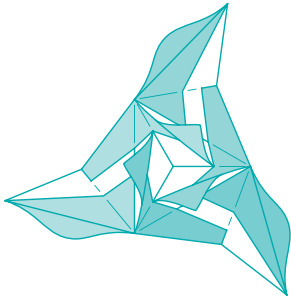

**12** Assemble in the same way as the basic model.

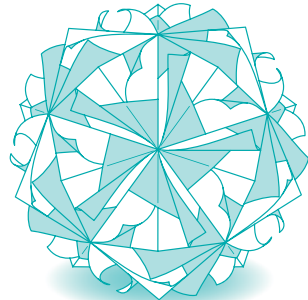

Here is a completed 30-unit model.

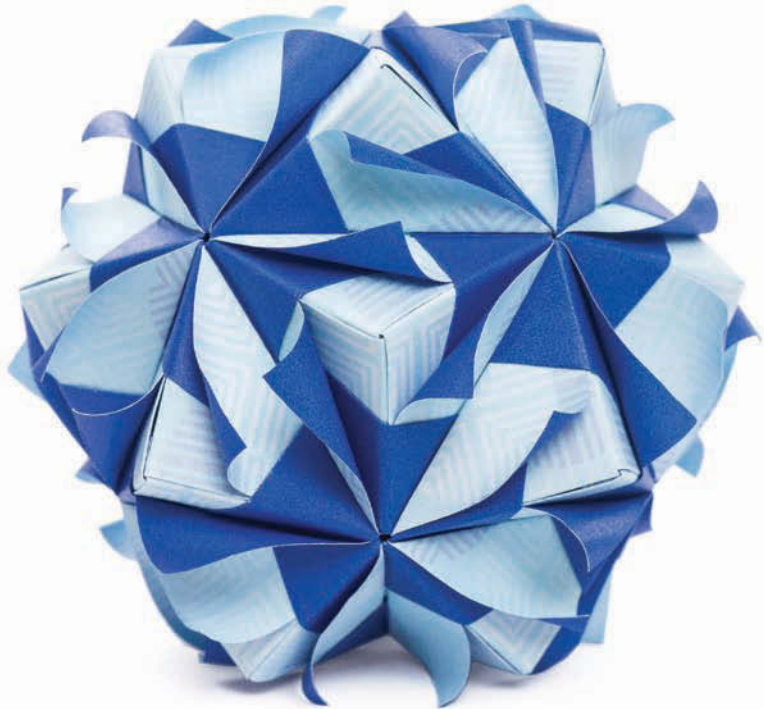



# CURLY SONOBE



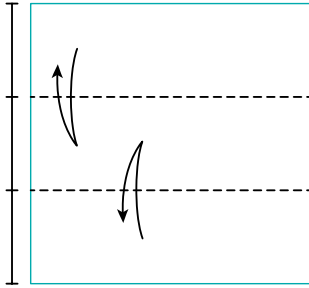

**1** Fold and unfold the paper in horizontal thirds (see pages 15–19).

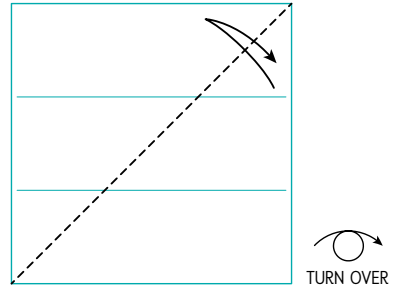

**2** Fold and unfold to form a diagonal crease. Turn the paper over.

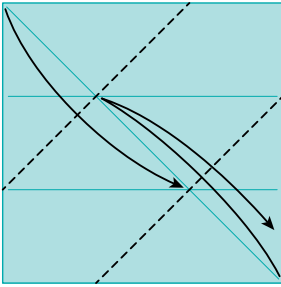

**3** Fold the lower right corner up to the top horizontal crease. Unfold. Fold the opposite corner to the bottom horizontal crease, then rotate the paper 45° clockwise.

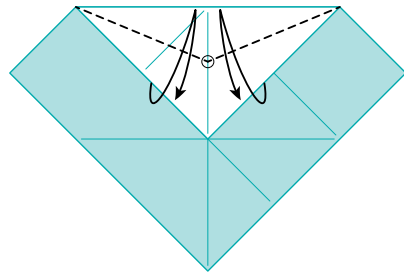

**4** Fold the lower right edge of the white flap up to the top horizontal edge, creasing the right half of the flap. Unfold, and repeat on the left side.

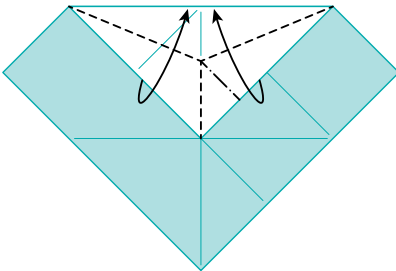

**5** Fold both sides upward, forming a flap in the center. Flatten the flap to the right.

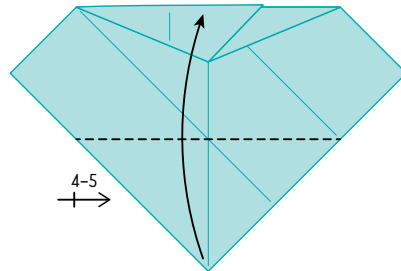

**6** Fold the lower corner up along the existing crease, then repeat steps 4–5 on this side of the unit.

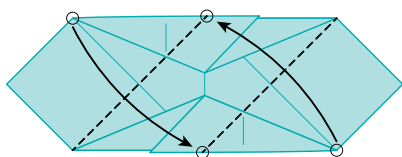

**7** Using the top right corner as a guide, fold the lower right corner up to meet the top horizontal edge. Repeat on the left side.

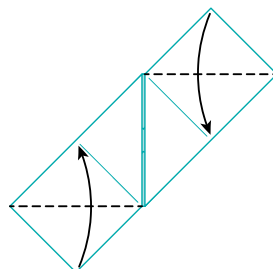

**8** Fold the corners inward, aligning them with the edges of the unit.

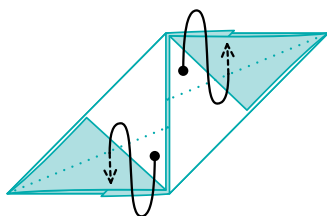

**9** Rearrange the layers as shown.

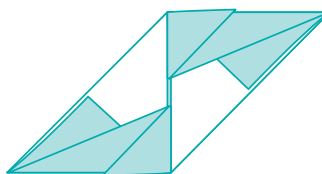

TURN OVER

**10** This is what your paper should look like. Now, turn it over.

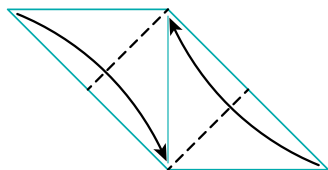

**11** Fold both flaps over on the existing creases.

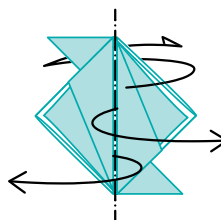

TURN OVER

**12** Fold the unit back along the central crease, then slightly unfold the flaps. Turn over.

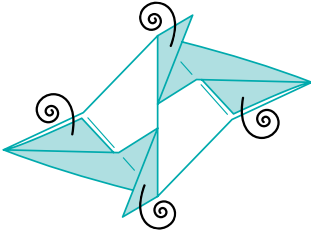

**13** Curl the colored corners.

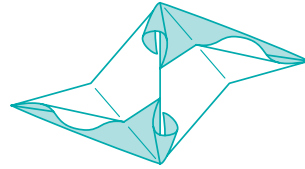

**14** This is what a complete unit should look like. Make a total of 30 units.

## ASSEMBLY

---

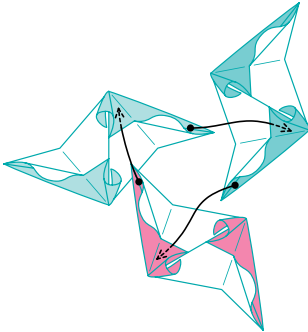

**1** Slide the flap of a unit inside the pocket of another unit. Add a third unit in the same way to form a pyramid.

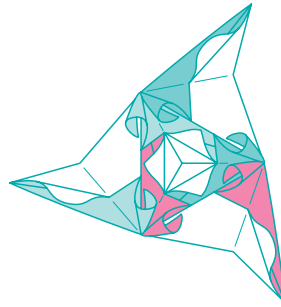

**2** Here are 3 units joined together, forming a pyramid. Continue adding more units in the same way, one at a time, to finish the model.

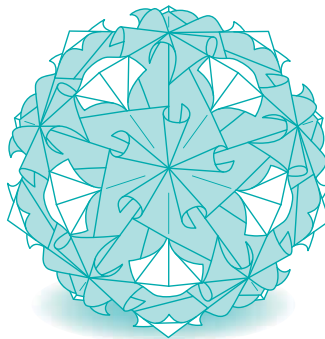

Here is a completed 30-unit Curly Sonobe.  
Great work!



## CURLY SONOBE VARIATION

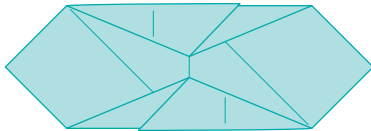

TURN OVER

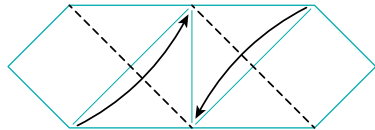

**7** Complete up to step 7 of the main sequence (see pages 85–86). Turn the paper over.

**8** Fold the right part of the top edge down to the central vertical crease. Repeat on the left side.

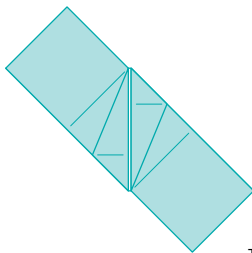

TURN OVER

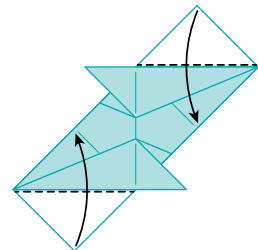
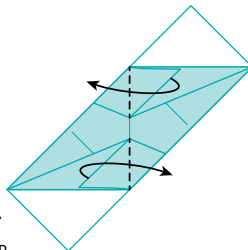

**9** This is what your paper should look like. Now, turn it over.

**10** Fold the small flap at the top edge to the left and the flap at the bottom edge to the right.

**11** Fold the white corners inward, aligning them with the edges of the unit.

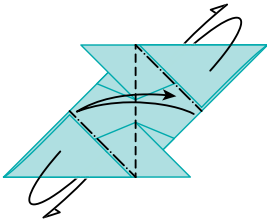

**12** Form flaps by mountain folding the right and left corners. Then make a central crease.

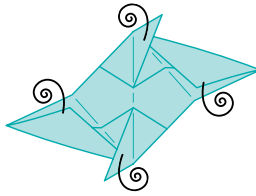

**13** Curl all the corners.

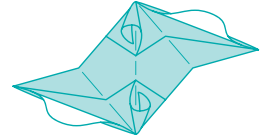

**14** This is what a complete unit should look like. Make a total of 30 units.

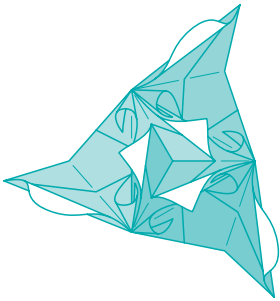

**15** Assemble in the same way as the basic model.

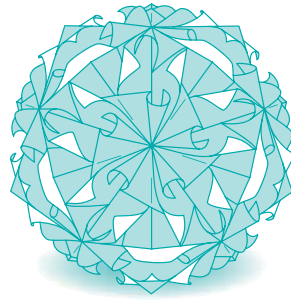

Here is a completed 30-unit model.

## TIP! ADDING BEADS

Beads can make a beautiful addition to many of the projects in this book. To attach beads to a finished 30-unit sonobe model, you will need twelve beads (one for each small "hole"), a thread, and a very long beading needle that is at least as long as the distance between two of the closest holes. Attach beads one by one with the single thread, moving the needle from one hole to the next hole closest to it.

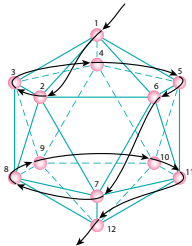

Here is an example of a sequence for adding beads.

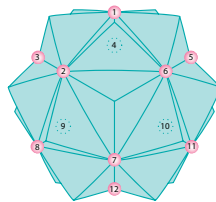

Here are beads attached to our example 30-unit sonobe model.

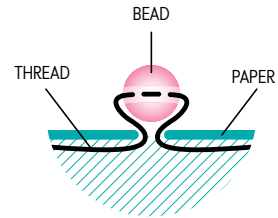

A close-up view of a bead. Note that the thread stays inside the model and the size of the bead keeps the bead from falling into the model.

IMPERIAL ROSE  
SONOBE



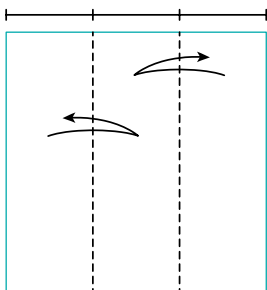

**1** Fold and unfold the paper in vertical thirds (see pages 15-19).

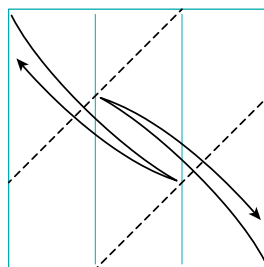

**2** Fold the bottom right corner up to align with the far vertical crease. Unfold. Repeat with the top left corner.

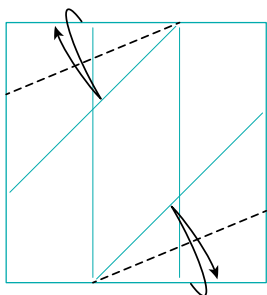

**3** Fold the right part of the lower edge to lay along the nearest diagonal crease, then unfold. Repeat on the left part of the top edge. Rotate the paper 45° clockwise.

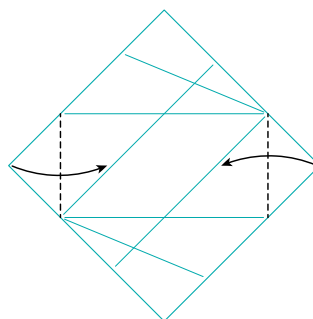

**4** Fold the right corner over to the nearest diagonal crease. Repeat on the left side.

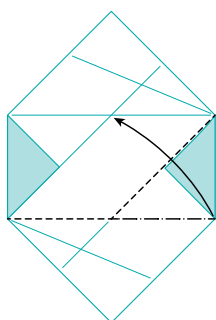

**5** Reinforce the mountain and valley folds as indicated. Fold the right vertical edge to the top horizontal crease while lifting the lower corner up. At this point the unit becomes 3-D.

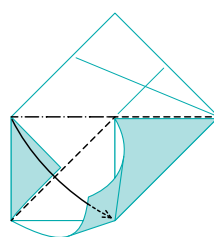

**6** This is what your paper should look like. Repeat step 5 on the left side of the unit.



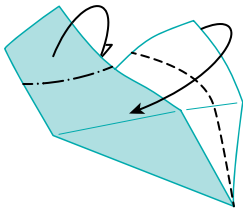

**7** Keeping the unit 3-D, fold the single-layered corners in along the existing creases. Both corners should lay on top of the other layers.

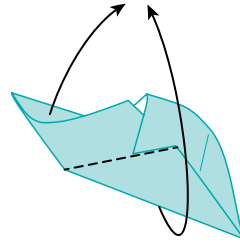

**8** Lift both flaps up along the central line.

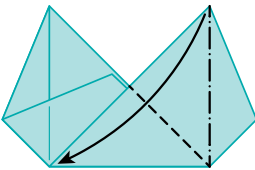

**9** Fold the upper right corner down to the lower left corner while forming a mountain as shown.

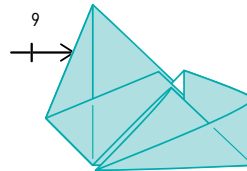

**10** This is what your paper should look like. To get the finished model to look organic, try not to flatten the upstanding rim. Instead, round it a bit using your finger as a guide. Turn the unit over, and repeat step 9 on the other side.

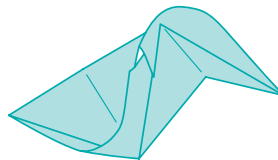

**11** This is what a complete unit should look like. Make a total of 12 or 30 units.

## ASSEMBLY

---

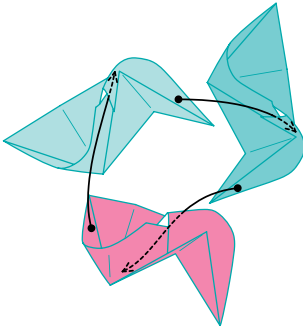

**1** Slide the rim at the end of the flap of a unit under the top layer of the rim of another unit. Add a third unit in the same way to form a pyramid.

POCKET

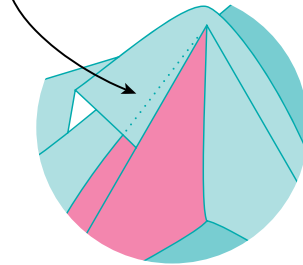

Here is a close-up look at a rim inside a pocket.

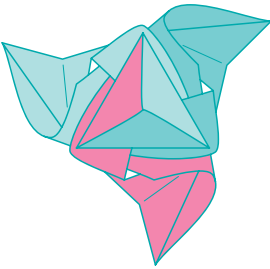

**2** Here are 3 units joined together, forming a pyramid. Continue adding more units in the same way, one at a time, to finish the model.

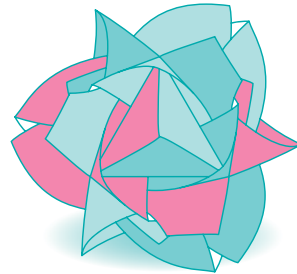

Here are a 12-unit . . .

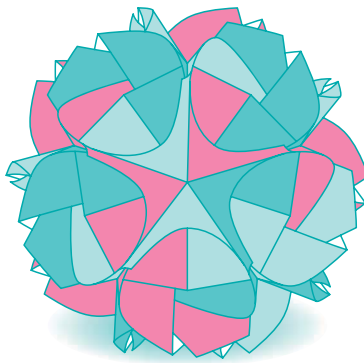

. . . and a 30-unit Imperial Rose Sonobe.

## IMPERIAL ROSE SONOBE VARIATION

---

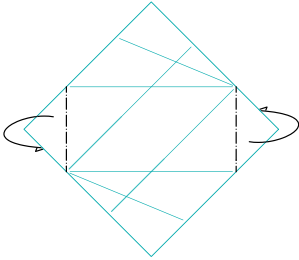

**4** Complete up to step 4 of the main sequence (see page 91), but instead of valley folding the corners, mountain fold them. Then follow the rest of the main folding sequence.

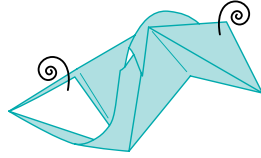

**5** This is what a complete unit should look like. Curl the white corners for a more organic look.

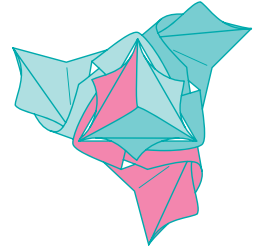

**6** Make a total of 12 or 30 units. Assemble in the same way as the basic model.



Here is a completed 30-unit model.

LOTUS CROWN  
SONOBE



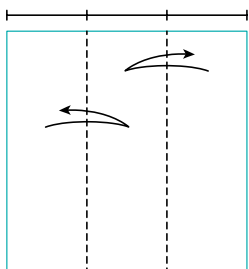

**1** Fold and unfold the paper in vertical thirds (see pages 15-19).

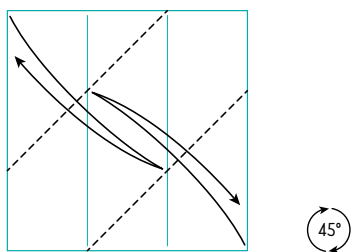

**2** Fold the bottom right corner up to align with the far vertical crease. Unfold. Repeat on the top left corner. Rotate the paper 45° clockwise.

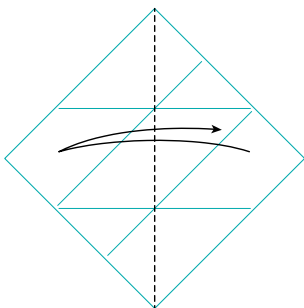

**3** Fold and unfold from the right to left corner.

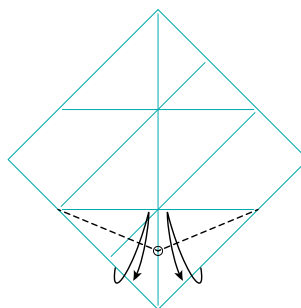

**4** Fold the lower right edge up to the nearest horizontal crease, but only crease the right side. Unfold and repeat on the left side.

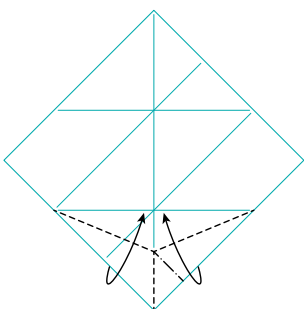

**5** Fold both sides up, forming a flap in the center. Flatten the flap to the right.

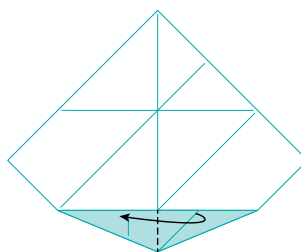

**6** Now fold the flap to the left.

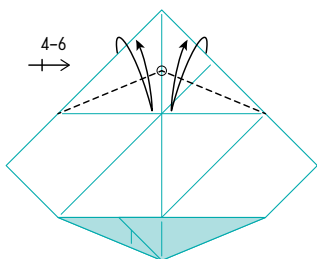

**7** Repeat steps 4-6 on the top corner of the unit.

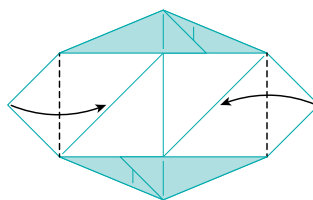

**8** This is what your paper should look like. Fold both corners in.

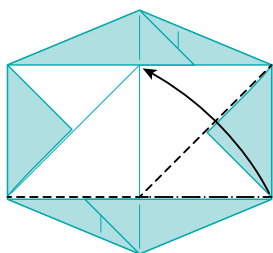

**9** Reinforce the mountain and valley folds as indicated. Fold the right vertical edge to the colored horizontal edge while lifting the lower part of the unit up. At this point the unit becomes 3-D.

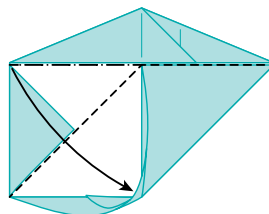

**10** This is what your paper should look like. Repeat step 9 on the left side of the unit.

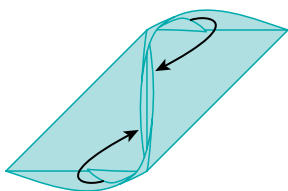

**11** Keeping the unit 3-D, swing the small colored flaps to the center of the unit.

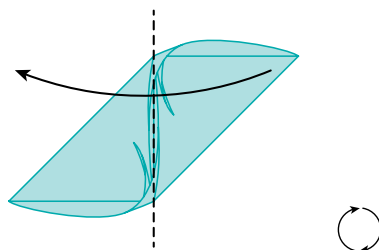

**12** Fold the unit along the central crease, then rotate to match the next step.

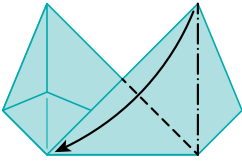

**13** Fold the top right corner down to the bottom left corner while forming a mountain fold as shown.

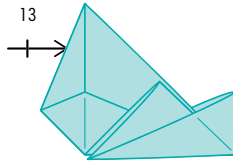

**14** This is what your paper should look like. Turn the paper over, and repeat step 13 on the other side. Slightly unfold.

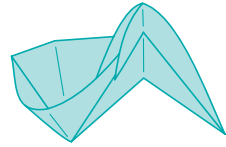

**15** This is what a complete unit should look like. Round the rims using your finger as a guide. Make a total of 12 or 30 units.

## ASSEMBLY

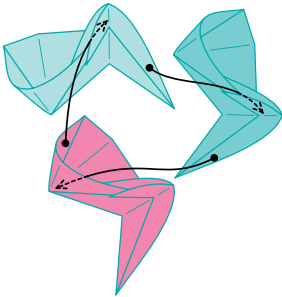

**1** Slide the rim at the end of the flap of a unit under the top layer of the rim of another unit. Add a third unit in the same way to form a pyramid.

POCKET

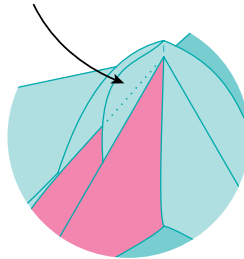

Here is a close-up look at a rim inside a pocket.

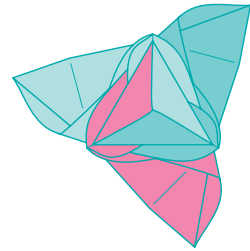

**2** Here are 3 units joined together, forming a pyramid. Continue adding more units in the same way, one at a time, to finish the model.

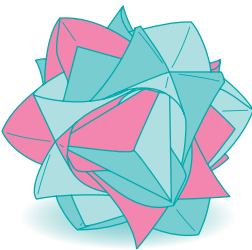

Here are a completed 12-unit . . .

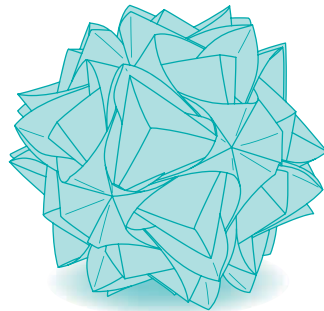

. . . and a 30-unit Lotus Crown Sonobe (pictured on page 95).

## LOTUS CROWN SONOBE VARIATION

---

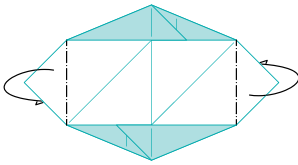

**8** Complete up to step 8 of the main sequence (see pages 96–97), but instead of valley folding the corners, mountain fold them. Then follow the rest of the main folding sequence.

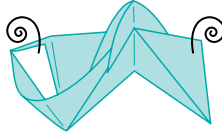

**9** This is what a complete unit should look like. Curl the white corners for a more organic look.

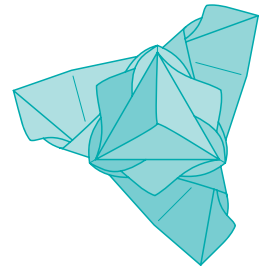

**10** Assemble in the same way as the basic model.



Here is a completed 30-unit model.



SKY STAR  
KUSUDAMA

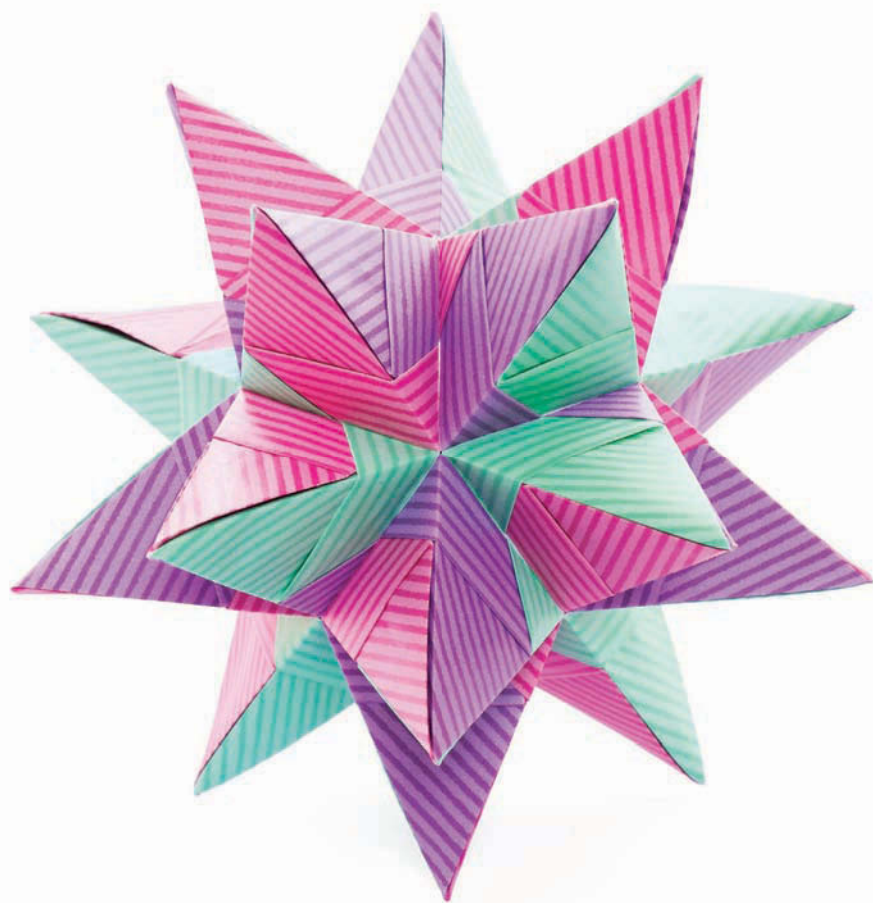

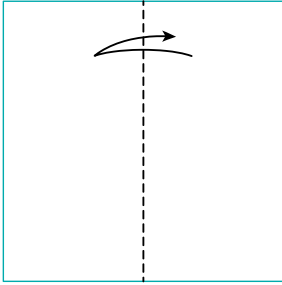

**1** Fold and unfold the paper in half from side to side.

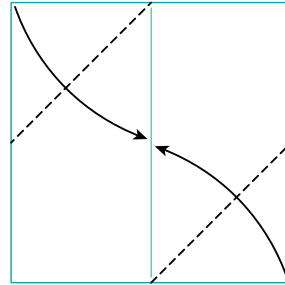

**2** Fold the bottom right corner to the central crease. Repeat with the top left corner.

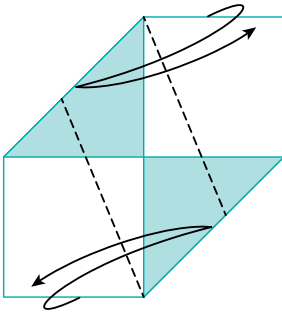

**3** Fold the top raw edge over so it lays along the top folded edge, then unfold it to form a crease. Repeat with the bottom raw edge.

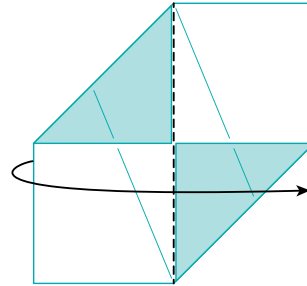

**4** Fold the paper in half along the vertical crease left to right.

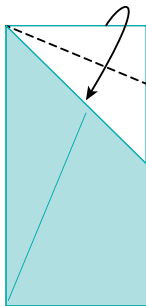

**5** Fold the top edge of the paper to the diagonal folded edge.

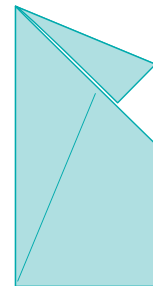

TURN OVER

**6** This is what your paper should look like. Flip it over vertically.

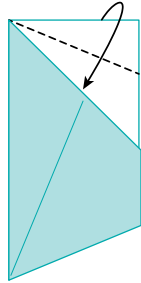

**7** Repeat step 5 on this side of the paper.

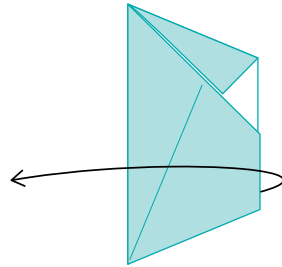

**8** Unfold the top layer.

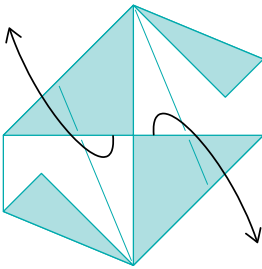

**9** Unfold the 2 biggest flaps, then turn the paper over.

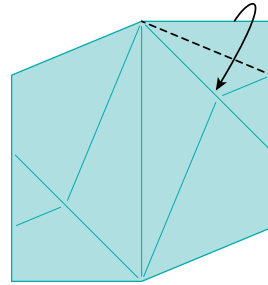

**10** Fold the top raw edge to the nearest diagonal crease.

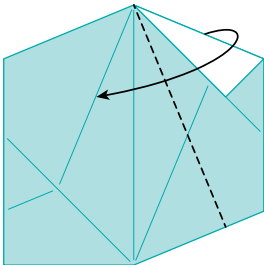

**11** Fold the top right edge of the paper over to align with the crease made in step 3.

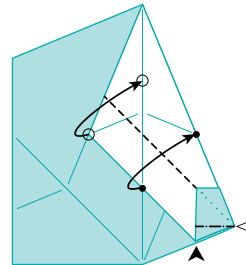

**12** Fold the white flap so that the dots marked above meet. Simultaneously squash and flatten the lower part of the flap . . .

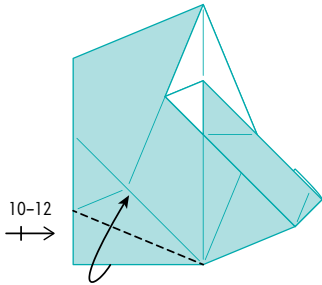

**13** . . . as shown here. Now, repeat steps 10-12 on the lower left side of the paper.

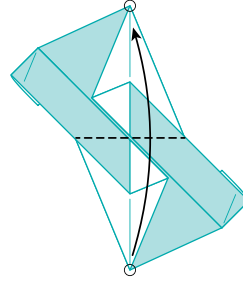

**14** Fold the unit in half horizontally, aligning its top and bottom corners.

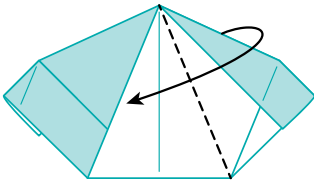

**15** Fold the right-hand flap over along the existing crease.

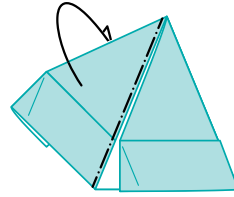

**16** Turn the unit over and repeat the previous step on the other side.

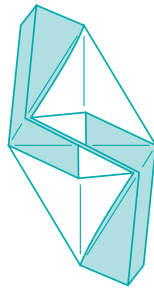

**17** This is what a complete unit should look like. Make a total of 12, 24, or 30 units.

## ASSEMBLY

---

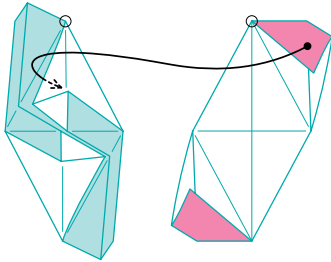

**1** To connect 2 units takes 2 steps. First, slide the inner flap of the pink unit under the top layer of the green unit, aligning the points and edges.

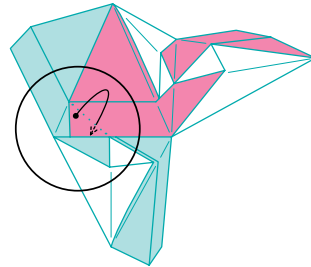

**2** Now, slide the small corner at the end of the pink unit's flap inside the pocket of the green unit.

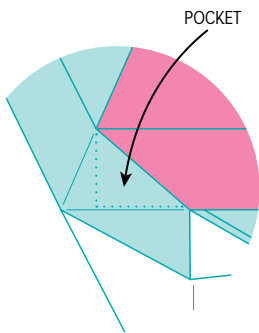

Here is a close-up look at a flap inside the pocket.

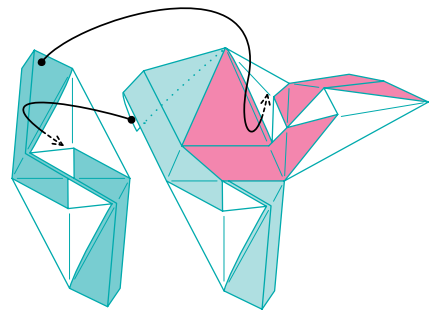

**3** Add 1 more unit in the same way to form a triangular pyramid.

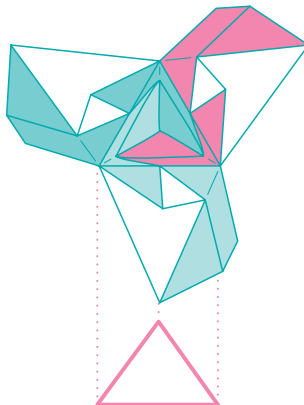

Here are 3 units joined together, forming a pyramid with a triangular base. Continue adding more units, one at a time, following one of the assembly patterns on the next page. Each unit should correspond to an edge of the underlying polyhedron.



## 12-UNIT OCTAHEDRAL ASSEMBLY

---

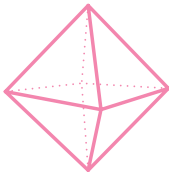

For a 12-unit assembly, follow the structure of an octahedron, forming new triangular pyramids in clusters of 4.

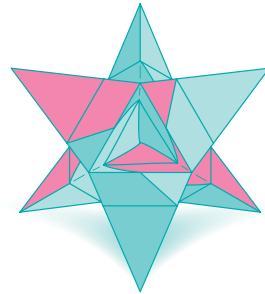

Here is a completed 12-unit Sky Star Kusudama.

## 30-UNIT ICOSAHERAL ASSEMBLY

---

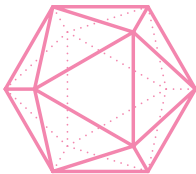

For this 30-unit assembly, follow the structure of an icosahedron, forming new triangular pyramids in clusters of 5.

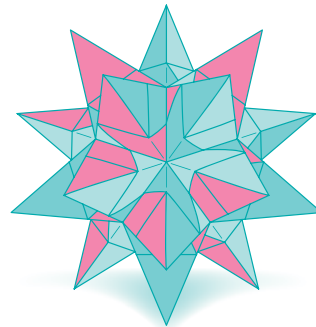

Here is a completed icosahedral 30-unit Sky Star Kusudama (pictured on page 100).

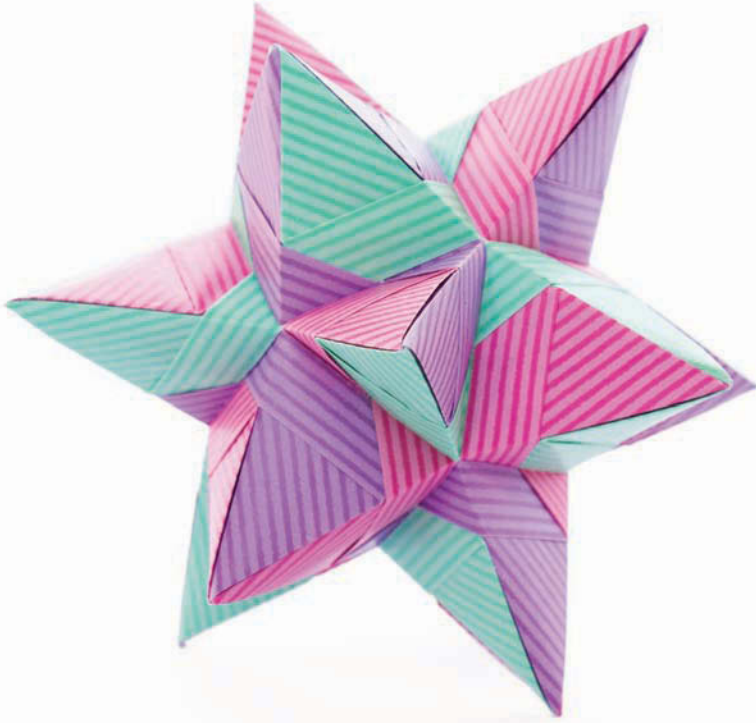

## 24-UNIT CUBOCTAHEDRAL ASSEMBLY

---

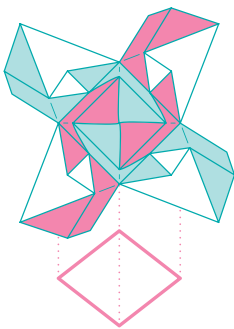

For a 24-unit assembly, join 4 units together to form a pyramid with a square base.

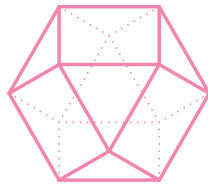

Continue adding more units, one at a time, forming new triangular and square pyramids and following the structure of a cuboctahedron.

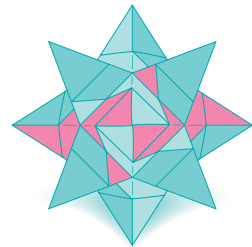

Here is a completed 24-unit Sky Star Kusudama.

## 30-UNIT DODECAHEDRAL ASSEMBLY

---

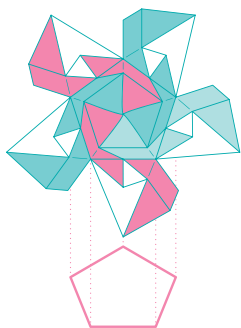

For this 30-unit assembly, join 5 units together to form a pentagonal pyramid.

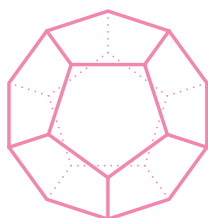

Continue adding more units, one at a time, forming new pentagonal pyramids and following the structure of a dodecahedron. The pyramids will form clusters of 3.

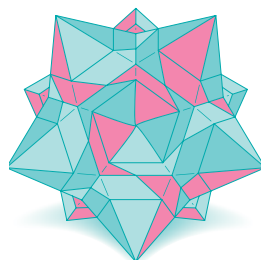

Here is a completed dodecahedral 30-unit Sky Star Kusudama.





# SKELLA ALPHA KUSUDAMA



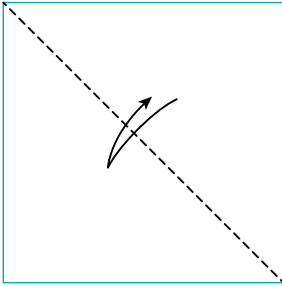

**1** Fold and unfold the paper from the top right corner to the bottom left corner to form a diagonal crease.

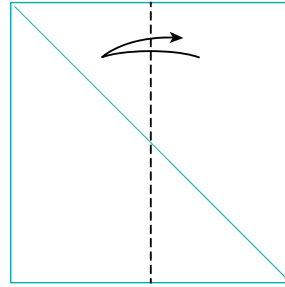

**2** Fold and unfold in half from side to side.

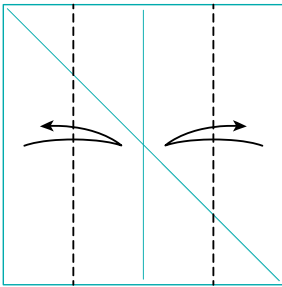

**3** Fold both vertical edges to the central crease, then unfold.

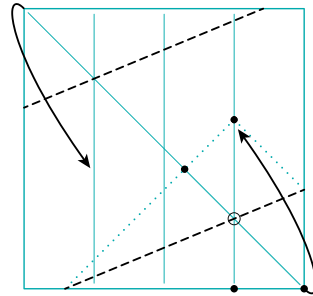

**4** Fold the lower edge up, so that the new crease runs through the marked intersection of creases and the lower right corner lands on the vertical crease as shown. Repeat on the top edge.

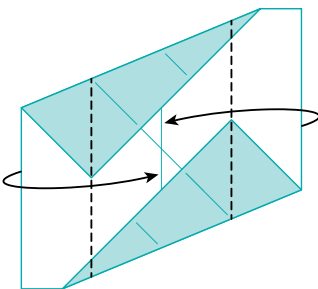

**5** Fold both vertical edges to the center using the existing creases.

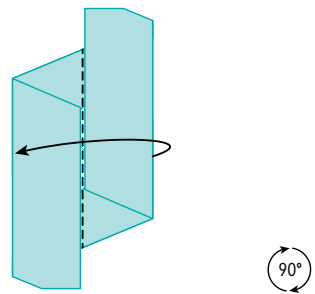

**6** Fold the unit in half along the vertical crease, then rotate 90° clockwise.

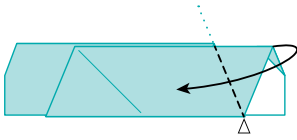

**7** Fold the right-hand flap over so that the crease aligns with the edge of the bottom layer of the unit.

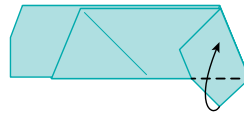

**8** Fold the lower corner of the flap up, aligning it with the lower edge of the unit.

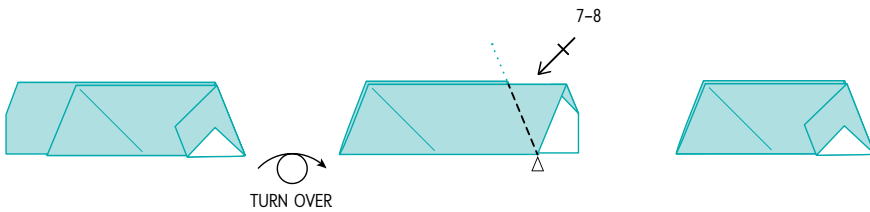

**9** This is what your paper should look like. Now, turn it over.

**10** Repeat steps 7-8 on this side of the unit.

**11** This is what a complete unit should look like. Make a total of 12, 24, or 30 units.

## ASSEMBLY

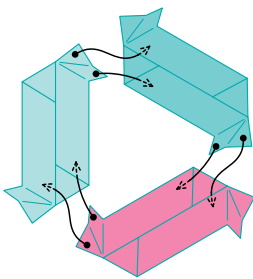

**1** Slide the corners at the end of a flap on a unit inside the pockets of another unit as shown.

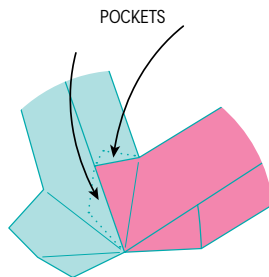

Here is a close-up look. Note that each flap should be inside its respective pocket.

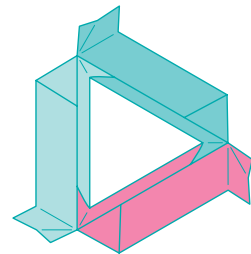

**2** Here are 3 units joined together, forming a triangle. Continue adding more units in the same way, one unit at a time, following one of the assembly patterns on the next page. Each unit should correspond to an edge of the underlying polyhedron.

## 12-UNIT ASSEMBLY

---

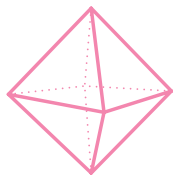

For a 12-unit assembly, follow the structure of an octahedron, forming new triangles in clusters of 4.

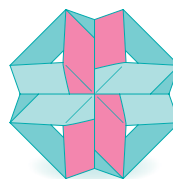

Here is a completed 12-unit Skella Alpha Kusudama.

## 30-UNIT ASSEMBLY

---



For a 30-unit assembly, follow the structure of an icosahedron, forming new triangles in clusters of 5.

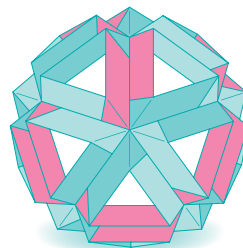

Here is a completed 30-unit Skella Alpha Kusudama (pictured on page 108).

## 24-UNIT ASSEMBLY

---

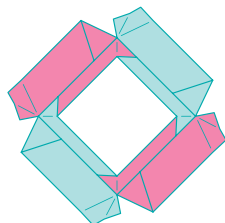

For a 24-unit assembly, join 4 units together to form a square.

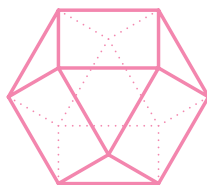

Continue adding more units, one at a time, forming new triangles and squares and following the structure of a cuboctahedron.

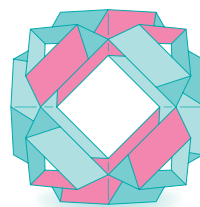

Here is a completed 24-unit Skella Alpha Kusudama.

# SKELLA BETA KUSUDAMA



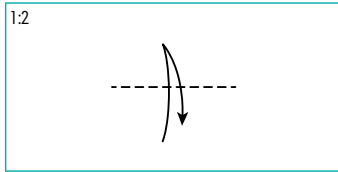

**1** Start with a 1:2 rectangle (you can create this by folding a square piece of paper in half, unfolding it, and cutting along the crease). Bring the bottom edge to the top, crease only in the middle, then unfold.

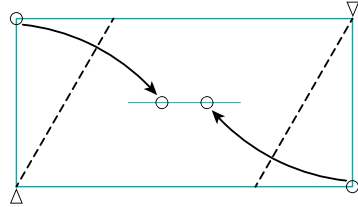

**2** Using the top right corner as a pivot point, fold the bottom right corner upward to lay on the horizontal crease. Repeat with the left side.

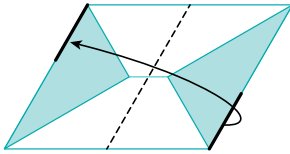

**3** Fold the right diagonal edge to the left edge, aligning them nicely . . .

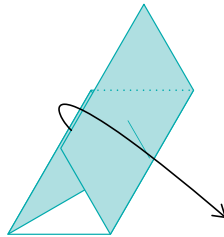

**4** . . . to look like this. Then unfold.

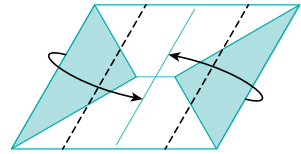

**5** Fold both diagonal edges to the crease made in step 3.

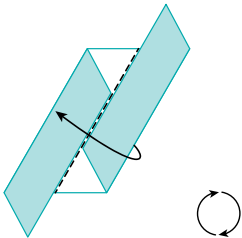

**6** Fold the unit in half along the central crease. Rotate it clockwise so that it matches the next picture.

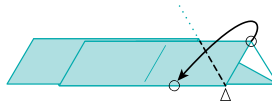

**7** Fold the right-hand flap over so that the crease aligns with the edge of the bottom layer of the unit.



**8** Fold the lower corner of the flap up, creasing it along the lower edge of the unit.

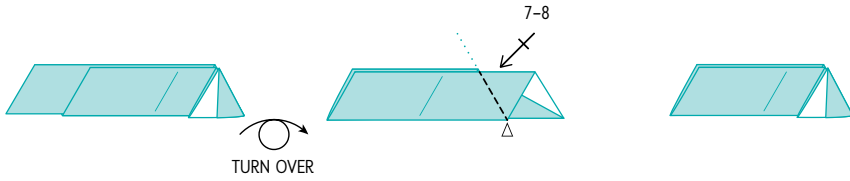

**9** This is what your paper should look like. Turn it over.

**10** Repeat steps 7-8 on this side of the unit.

**11** This is what a complete unit should look like. Make a total of 30 units.

## ASSEMBLY

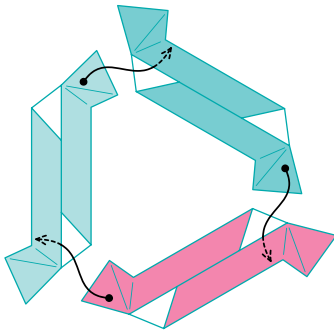

**1** Slide the corner at the end of a flap on a unit inside the pocket of another unit as shown.

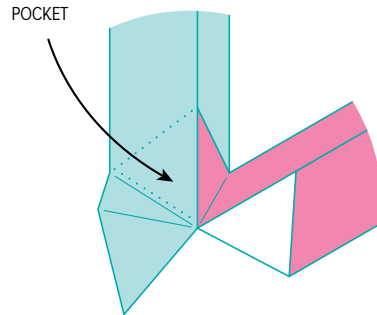

Here is a close-up look at a flap inside a pocket.

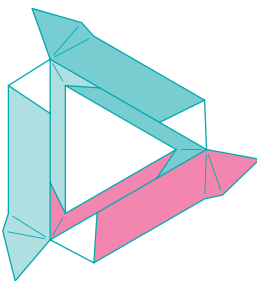

**2** Here are 3 units joined together, forming a triangle. This model can be assembled in the same ways as Skella Alpha Kusudama (see page 111).

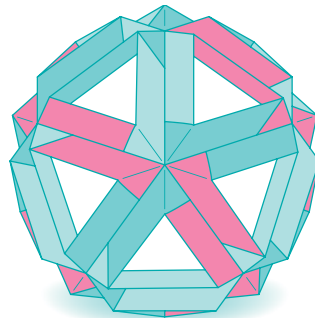

Congratulations! Here is a completed 30-unit Skella Beta Kusudama.

## SKELLA BETA KUSUDAMA VARIATION

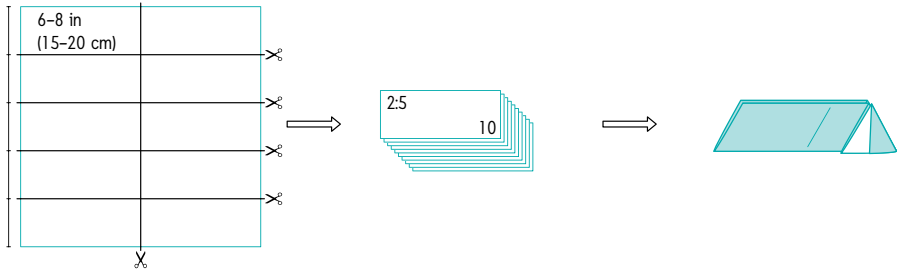

You can also fold this model using rectangles with proportions other than 1:2. For example, cut a large square sheet of paper in half vertically and in fifths horizontally. This will give you 10 equal rectangles with 2:5 proportions. Then follow the basic folding sequence to make the units.

You will only need 3 large square sheets of paper to make a 30-unit model, with no paper wasted!

This is what a complete unit made with a 2:5 rectangle should look like. Make a total of 30 units. Assemble in the same way as the basic model.

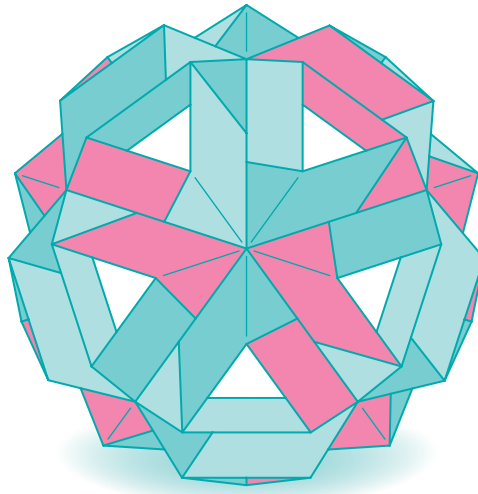

Here is a completed 30-unit Skella Beta Kusudama folded with 2:5 rectangles.



# SKELLA GAMMA KUSUDAMA



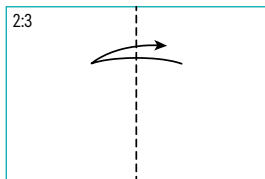

**1** Start with a 2:3 rectangle (see pages 20–21). Fold and unfold from side to side to create a vertical crease.

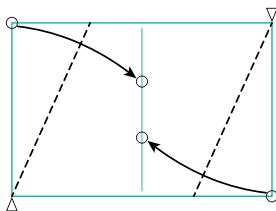

**2** Using the top right corner as a pivot point, fold the bottom right corner upward to lay on the crease.

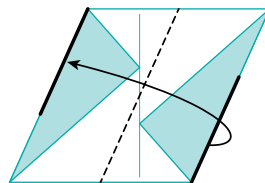

**3** Fold the right diagonal edge to the left edge aligning them nicely . . .

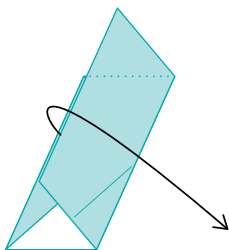

**4** . . . to look like this. Then unfold.

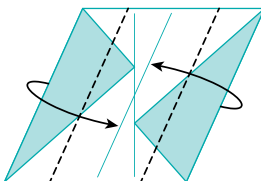

**5** Fold both diagonal edges to the crease made in step 3.

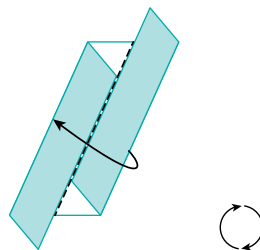

**6** Fold the unit in half along the central crease. Rotate it clockwise so that it matches the next picture.



**7** Fold the right-hand flap over so that the crease aligns with the edge of the bottom layer of the unit.



**8** Fold the lower corner of the flap up, creasing it along the lower edge of the unit.



**9** This is what your paper should look like. Turn it over.



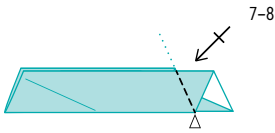

**10** Repeat steps 7–8 on this side of the unit.

**11** This is what a complete unit should look like. Make a total of 30 units.

## ASSEMBLY

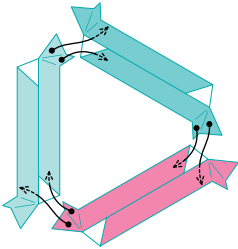

**1** Slide the corners at the end of a flap on a unit inside the pockets of another unit as shown.

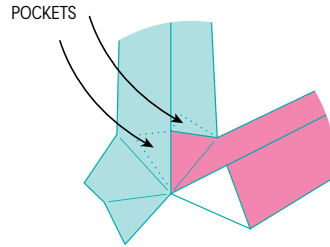

Here is a close-up look. Note that each flap should be inside its respective pocket.

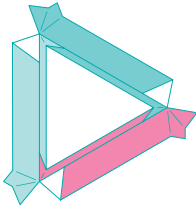

**2** Here are 3 units joined together, forming a triangle. This model can be assembled in the same ways as Skella Alpha Kusudama (see page 111).

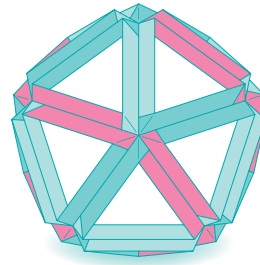

Here is a completed 30-unit Skella Gamma Kusudama.

## SKELLA GAMMA KUSUDAMA VARIATION

You can also fold this model using rectangles with proportions other than 2:3. For example, use 3:4 rectangles (see pages 22–23) and follow the main folding sequence.

Another good option is to fold an A4 or a US letter-size sheet of paper in fourths along both sides, then cut along the creases. This will give you 16 equal rectangles, which will also work for this project. You will only need 2 sheets to make a 30-unit model!

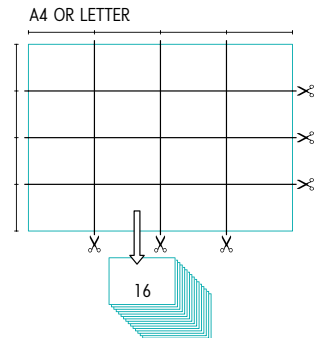

ROCCA  
KUSUDAMA



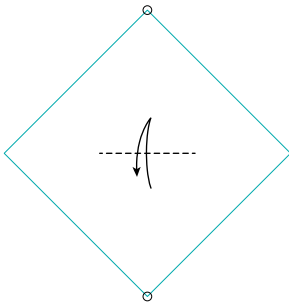

**1** Fold the paper in half from corner to corner, creasing only in the middle, then unfold.

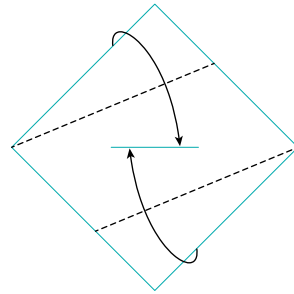

**2** Fold the lower right edge to the horizontal crease. Repeat with the top edge.

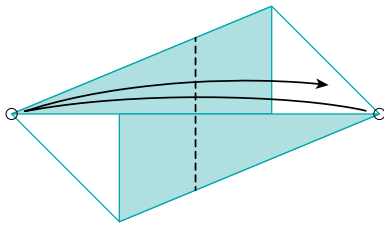

**3** Fold and unfold in half vertically to make a crease.

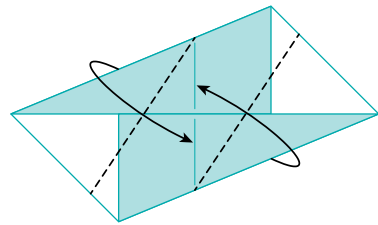

**4** Fold the lower right edge to the vertical crease. Repeat with the upper left edge.

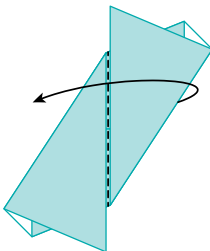

**5** Fold the unit in half along the central vertical crease. Rotate the paper 90° clockwise.

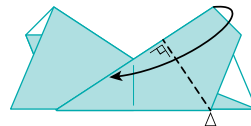

**6** Starting at the point marked with a triangle, fold the right-hand flap to the left, aligning it with the edge of the unit.

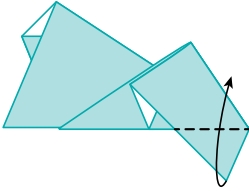

**7** Fold the lower corner of the flap up, creasing it along the bottom edge of the unit.

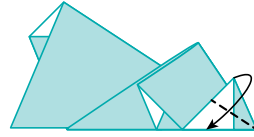

**8** Fold the little flap down, aligning it with the bottom edge of the unit.

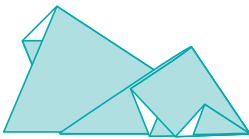

**9** This is what your paper should look like. Turn it over.

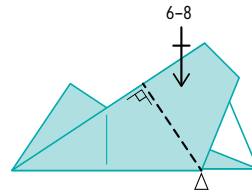

**10** Repeat steps 6-8 on this side of the unit.

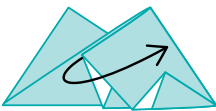

**11** Your unit should now look like this. Slightly unfold the flaps and rotate it.

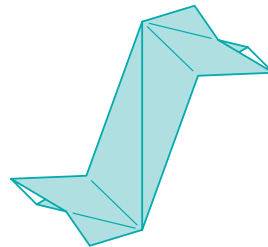

**12** This is what a complete unit should look like. Make a total of 12 or 30 units.

## ASSEMBLY

---

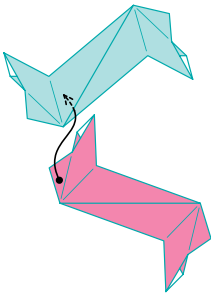

**1** Slide the flap of a unit inside the pocket of another as shown.

POCKET

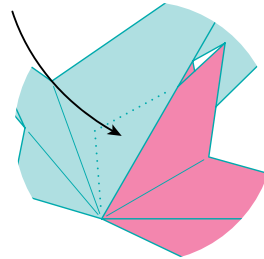

Here is a close-up look at a flap inside a pocket.

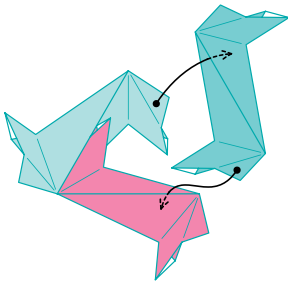

**2** Add a third unit to create a pyramid.

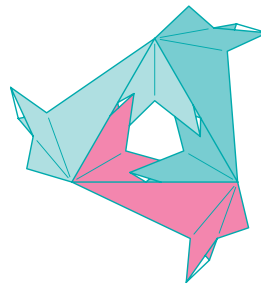

**3** Here are 3 units joined together, forming a pyramid. Continue adding more units in the same way, one at a time. This model can be assembled in the same ways as Skella Alpha Kusudama (see page 111).

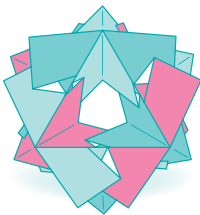

Here are a completed 12-unit . . .

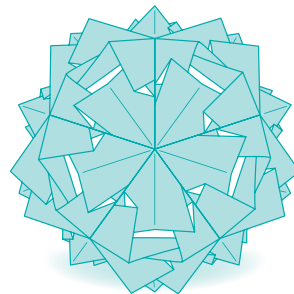

. . . and a 30-unit Rocca Kusudama.

# FIGRELLA KUSUDAMA





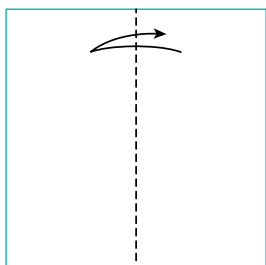

**1** Fold and unfold the paper in half from side to side to create a vertical center crease.

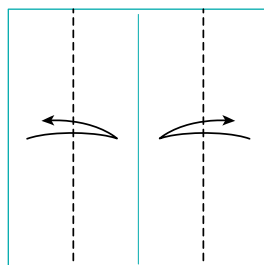

**2** Fold and unfold both vertical edges to the center to form creases.

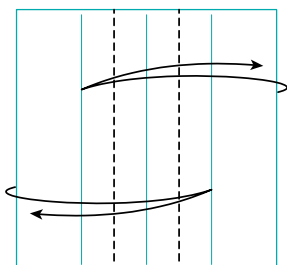

**3** Fold the right edge to the farthest vertical crease, then unfold. Repeat with the left side of the paper.

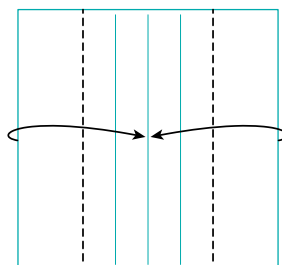

**4** Using the creases made in step 2, fold both vertical sides to the central line.

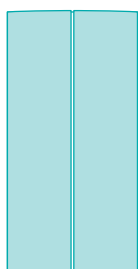

**5** This is what your paper should look like. Now, turn it over.

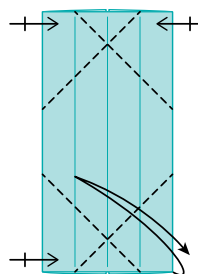

**6** Fold the lower right corner up, aligning the bottom edge with the left vertical crease, then unfold. Repeat with the remaining 3 corners.

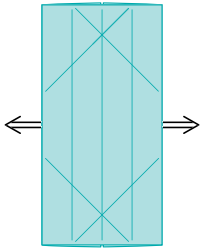

**7** Unfold the paper all the way back to a square, and turn it over.

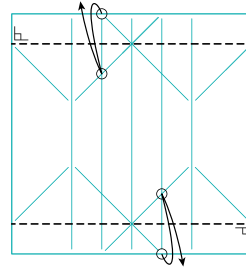

**8** Fold the lower edge up so that the circles shown here meet. Unfold and repeat with the top edge.

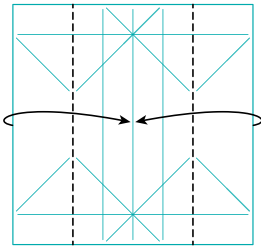

**9** Fold both vertical edges to the center.

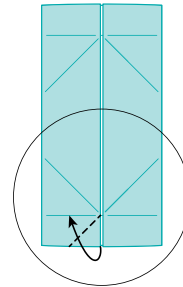

**10** Fold the lower corner of the left-hand flap up to align with the nearest horizontal crease.

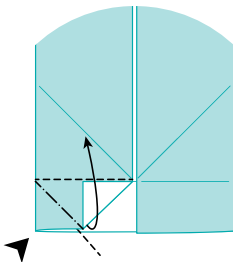

**11** Fold the lower part of the flap up along the existing crease while simultaneously squashing and flattening the lower left corner.

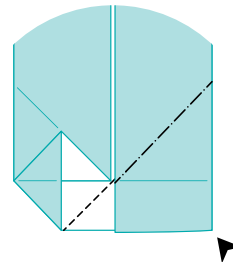

**12** Reverse fold the lower right corner of the unit using the existing creases.

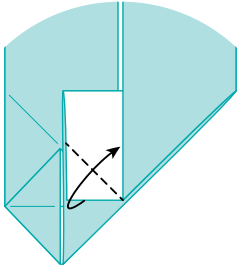

**13** Fold the little white corner to the right so it lays along the raw edge of the paper.

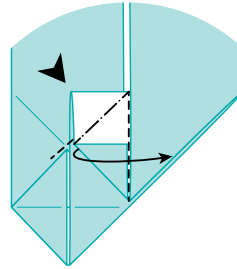

**14** Opening up the top layer, fold it to the right while simultaneously squashing and flattening the upper white corner.

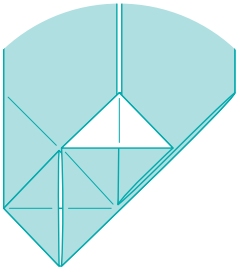

**15** This is what the lower part of your unit should look like.

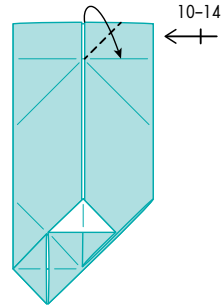

**16** Repeat steps 10-14 on the upper side of the unit.

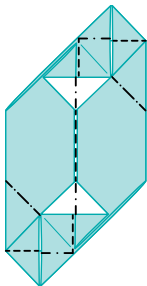

**17** Refold all the valley and mountain folds shown here. This will form flaps and petals.

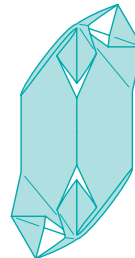

**18** Here is what a complete unit should look like. Make a total of 30 units.

## ASSEMBLY

---

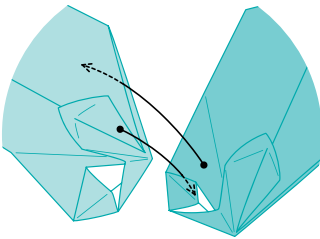

**1** Arrange 2 units as shown and slide the right-hand unit into the left-hand unit.

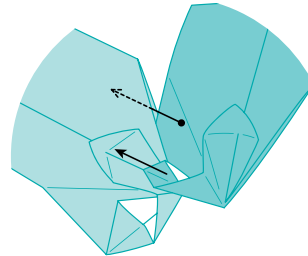

**2** While you are doing this, pay attention to the position all of the layers.

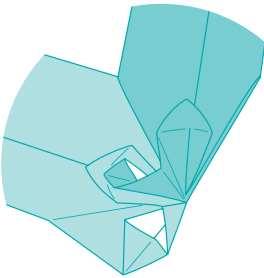

**3** Here are 2 units joined together. Note that the small petal of the right unit is now inside the petal of the left unit.

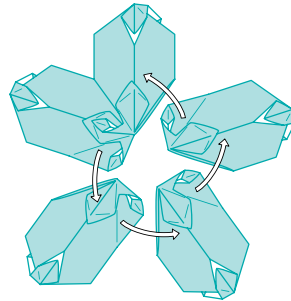

**4** Continue adding units in the same way, one at a time. For this model, instead of joining units in groups of 3 to form triangles, it's easier to join them in groups of 5, forming 5-pointed "stars" first.

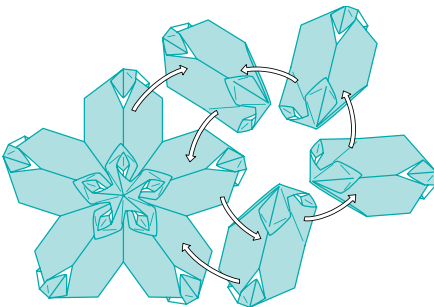

**5** Add the remaining units, following the 30-unit assembly method for Skella Alpha Kusudama (see page 111).

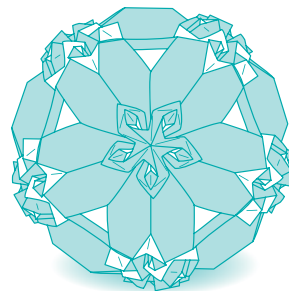

Here is a completed 30-unit Fiorella Kusudama.

# ABOUT THE AUTHOR

MARIA SINAYSKAYA is an origami artist who is mostly known for her modular origami designs—polyhedra, kusudamas, and stars. Born and raised in Russia, she received a master's degree in mathematics from Samara State University and worked in the field of data analysis and statistical research.

Her mathematical background, combined with a special love for geometry, led her to become deeply interested in modular origami and an avid paper folder. Over the years, Maria has created a number of original origami designs and has been a regular contributor to origami-related exhibitions and publications around the world.

Maria resides in Durban, South Africa, and when she is not busy folding paper she spends time with her husband, traveling the country and enjoying the beauty and diversity of nature and wildlife that South Africa has to offer.



# ZEN AND THE ART OF ORIGAMI

FOR CENTURIES, people have delighted in the joy of folding humble pieces of paper into grand figures. *Zen Origami* builds on that tradition using a method known as “modular origami.” Each project is created by folding a number of easy 1-paper units, and then assembling them to create an exquisite keepsake. The repetitive and delicate folds will bring you to a meditative state of calm, in which noisy thoughts are quieted as you are absorbed into the flow of your motions.

Through easy-to-follow, step-by-step instructions and diagrams in this book, you'll learn how to create 20 unique projects, many of which have variations that reveal elegant, new color patterns through small adjustments. Though the models may appear complex, remember that they are made from simple pieces assembled to create something intricate. And you too, through simple actions, can achieve something seemingly difficult: a meditative mind.



Not for individual sale