

DAI VERNON
SLYDINI
DAVID ROTH
EDWARD MARLO
DEREK DINGLE
SOL STONE

COINMAGIC

GEOFFREY LATTA
JOHN CORNELIUS
KEN KRENZEL
HERB ZARROW
TOM GAGNON
SCOTT WEISER
DAVID ARTHUR

RICHARD KAUFMAN

COINMAGIC

**Written
and
Illustrated
by**

RICHARD KAUFMAN

**Preillustrative
Photos
by
Michael Lew**

**Published
By**

Richard
Kaufman

and

Alan
Greenberg

Introduction

It's easy to see the influence of the contributors to a book because their names are right there. There are, however, other people whose contributions may not be so obvious. The one man without whom this book (and, for that matter, all my others) would not have been possible is Harry Lorayne. I had presumptuously written a book while only sixteen and he agreed to edit it, in the process teaching me not only how to write, but how to publish a book as well. He spent a lot of time rewriting it while I watched over his shoulder until he felt I understood the technique of properly describing an effect. It's rare to find a busy celebrity who is generous to a fault with his time and knowledge. Though young, I sensed the unique opportunity being offered and took advantage of it: that kind of practical experience isn't easy to come by.

Over the years Harry introduced me to many people, made a lot of connections, and provided the opportunity necessary to increase my skill at drawing. Without all of that expert teaching my work would not be as you now see it. In short, this book would probably not exist if it were not for Harry's help and advice over the past six years. I could not have asked for a finer teacher.

One name that you will see, but whose influence you may still underestimate, is David Roth. Not only has he generously contributed material which constitutes almost a quarter of the book, but he also has influenced many of the other contributors. Geoffrey Latta, Scott Weiser, David Arthur, and Les Shore have all grown up in New York City watching Roth perform. He caught the imagination of those coin men and provided new pathways for them to follow. Roth is to coin magic what Hofzinsler was to card magic, and the eventual publication of his wealth of ingenious material will confirm that beyond all doubt.

Sol Stone is another major contributor, and a name you've seen before in both *Apocalypse* and *Tarbell No. 7*. Sol developed many of his routines during the forties and fifties and a choice selection of his most cherished material comprises his section. Anyone who has seen Sol work is amazed at the smoothness of his beautifully choreographed sleights. I've tried to give a sense of his flowing rhythm in the descriptions, but it's really just style.

Every book should have a surprise, and the sudden arrival of a seemingly fully formed major talent seems appropriate. Geoffrey Latta has been a close friend of David Roth's for years, and nobody is quicker to acknowledge his debt to David than Geoff. They don't really think alike, though, and in many of the routines in Geoff's section you'll see wonderful applications of ideas that certainly signal a unique creative mind at work.

To Jon Racherbaumer, and the many other prestigious contributors like Vernon, Slydini, Marlo, Krenzel, Zarrow, and Dingle, I would like to offer my heartfelt thanks. Without their almost unlimited generosity the art of magic would stop stone still. By creating and giving their ideas to all of us our art continues to expand and grow, becoming more wondrous with each passing moment.

Richard Kaufman
August, 1981

Retention Clip Vanish

Richard Kaufman

Many routines in this book require a vanish which takes place while your hands are in Retention Pass position. The widespread use of the move, which has appeared in both *Greater Magic* and *Bobo's Modern Coin Magic* (and is Vernon's), is due to David Roth's extensive use of it in his lectures, and his influence upon coin magic in general. To keep this book complete, here's a version of the move that I developed several years ago.

Hold a half dollar between your right thumb, on the inner side, and first and second fingers, on the outer side (fig. 1). Your third and pinky fingers are naturally curled and out of the way. I'll teach the right-hand action first, and then how to coordinate that with closing your left fingers.

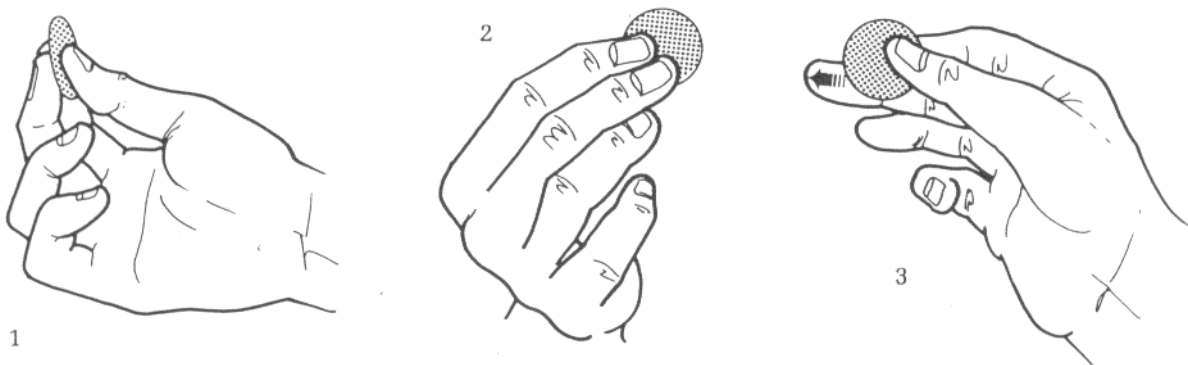
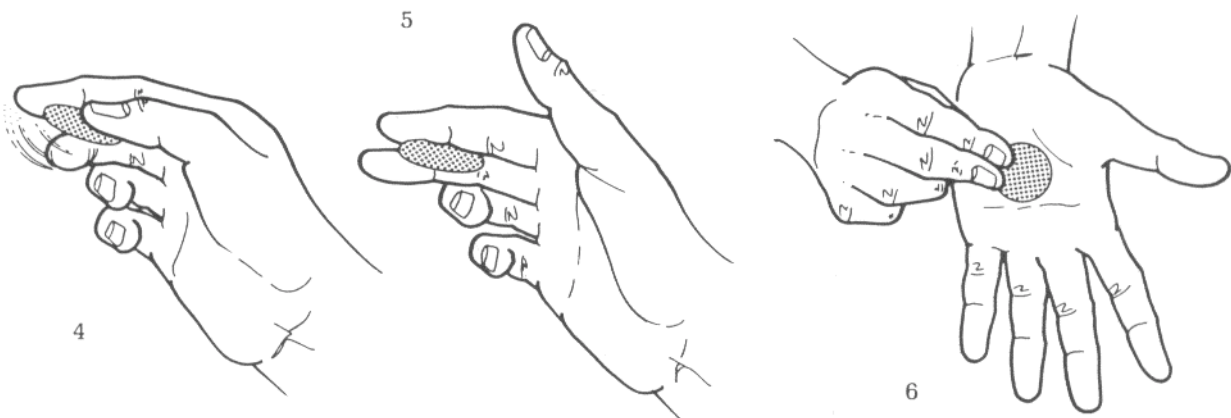

Figure 2 is an audience view. Extend your second finger across the face of the coin (fig. 3). Relax your first finger a bit so that it's not pressing the coin as firmly against your thumb. When you do that start to curl your second finger. The coin will slowly tilt sideways onto your second finger (fig. 4).



Your first finger should automatically be in position so that if it presses lightly downward the coin's forward edge will be clipped between it and your second finger. Lift your thumb (fig. 5). Your palm is toward the left throughout this. If you rotate your hand to a palm-down position, slightly curling your fingers, the coin will drop to fingertip rest on your second and third fingers (the exact position is described in detail later in this section).

Add the left-hand action. Hold your left hand palm toward audience, fingers pointing downward, behind the coin displayed by your right hand (fig. 6 is an audience view). As you rapidly close your left fingers into a loose fist your right fingers perform the clipping action and move away. There's a timing knack here that gives you the retention, and it has to do with coordinating your curling left fingers with your right fingers clipping the coin. As your left fingers curl your right second finger moves across the face of the coin and pulls it back to clip position. Your right hand is already moving away when your left fingers finish curling.

The tip that Roth often gives when he teaches the Retention Pass is to wait to begin the right-hand action until the tip of your left pinky touches the back of your right fingers. That way you can be sure you're stealing the coin (it the last possible moment).

Palm Change

Moves like this have been around for years, but rarely in print. Like the Retention-Pass, this will be used in a number of routines that will be taught later on.

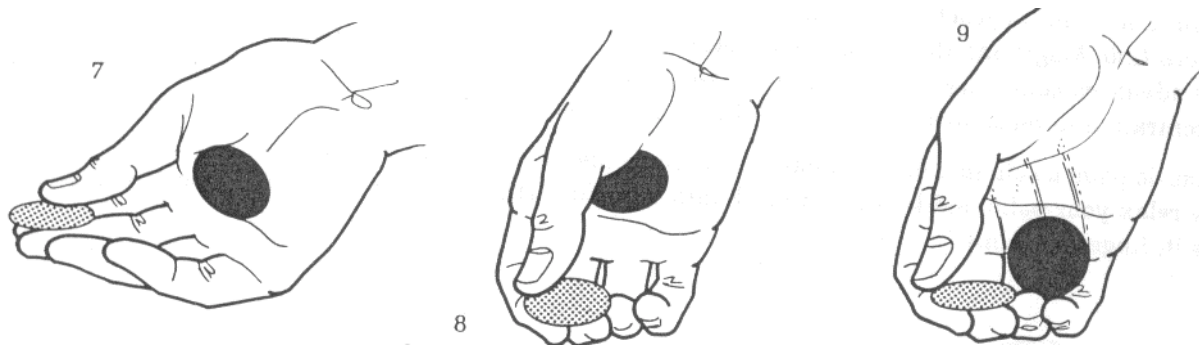

Classic palm a copper coin in your right hand. Hold your hand partially palm up, fingers pointing to the left. A silver coin lies on your first and second fingers, held in place by your right thumb (fig. 7). Turn your hand so that your fingers point toward you and the back of your hand is toward the audience (fig. 8). Relax

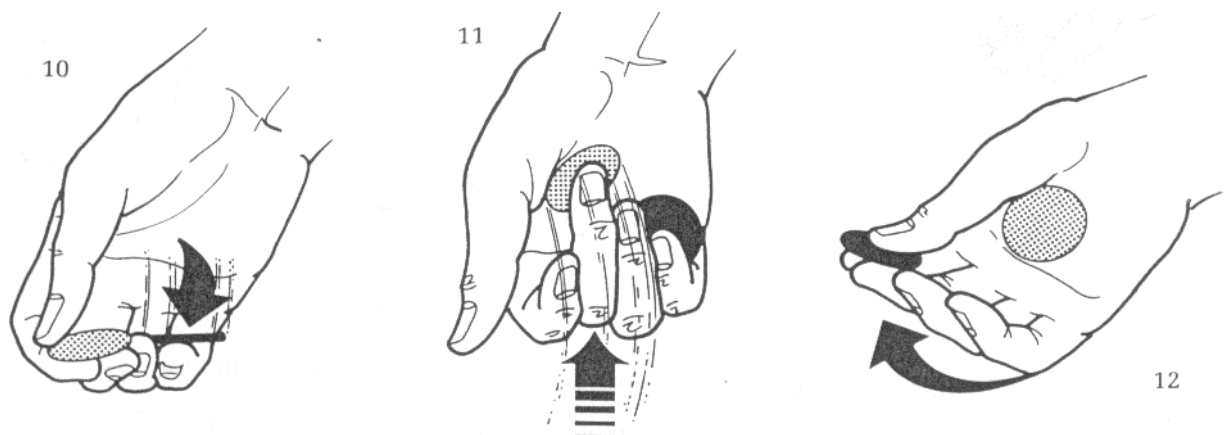

your palm and allow the copper coin to drop. It should land as in figure 9, its lower edge cradled by the joints of your third and pinky fingers nearest the finger base.

Squeeze your fingers closed - two things happen. First, as your third and pinky fingers curl, the copper coin will flip over (inward) onto them (fig. 10). Second, your first and second fingers push the silver coin into classic palm (fig. 11).

Lower your fingers and slightly contract your palm to hold the silver coin in place. Move your thumb inside your fingers onto the copper coin and slide it to your first and second fingertips as your hand turns partially palm up (fig. 12).

It should appear as if you simply make a fist and open it again. With practice you'll be able to do this very quickly. It's similar to the late Fred Kaps' method.

Fingertip Rest Position

I am not going to teach all the basic palms and grips because you should already have read Bobo's Modern Coin Magic and they're all well described there. What follows is a bit of finesse - something that most advanced coin workers use a lot. It's a simple thing to understand and do - it'll just take a bit of your concentration to remember to use (and I'll remind you constantly).

Classic palm a coin in your right hand. Curl your fingers into a loose fist and rest your hand on the table. Now relax your palm and let the coin fall onto your fingertips (fig. 13). That's fingertip rest for, as Roth calls it, fingertip palm).

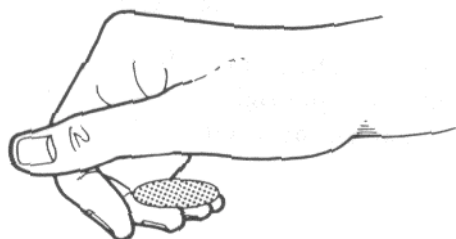

13



The coin just sits there on your second and third fingertips - it's not gripped in any way.

You can go directly into fingertip rest after a Retention Pass - in which case your hand doesn't rest on the table (assuming you're standing, of course), but simply hangs casually off your wrist (fig. 14).

Palm and Grip Transfers

David Roth has given this piece of advice to a number of his students: know how to secretly transfer a coin from any palm position to any other position. The reason is simple. In many advanced multi-step routines you must do a number of sleights in a row, without pausing. You must be able to get into position to perform those sleights by shuttling concealed coins around inside your hand. The basic positions of concealment are: 1) Classic Palm, 2) Finger Palm, 3) High Finger Palm, 4) Thumb Palm, 5) Downs Palm, 6) Fingertip Rest, 7) Interior Clips, 8) Back Clip, 9) Deep Back Clip, and 10) Edge Grip. That list is not complete - there are many more, but those are the ones used in this book. Details on some of them will be given as the need arises.

Here are a few suggested ways to move a coin from one basic position to another.

From Classic Palm to Fingertip Rest: see Fingertip Rest Position. To reverse the action and transfer a coin from Fingertip Rest to Classic Palm simply push it upward with your second and third (or just third) fingertips.

From Fingertip Rest to Thumb Palm: Curl your fingers as far as you can into your fist, making a conscious effort to aim the coin's left edge for your thumb crotch (fig. 15). Simultaneously press your thumb against the coin's edge and straighten your fingers. A word about Thumb Palm - don't press your thumb firmly against the side of your hand. A light relaxed touch will hold the coin there and also allow your hand to look fairly natural.

15

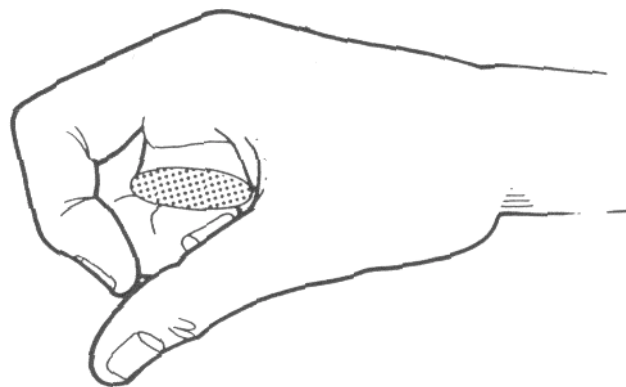

From Classic Palm to Thumb Palm: Combine the two movements just taught, first dropping the coin to Fingertip Rest, and then curling your fingers and thumb palming it.

From Finger Palm to Thumb Palm: This is very difficult, though Roth uses it on occasion. There's also not much to tell -do it exactly as you think it should be done. In other words curl your fingers and lift your first finger out of the way. Catch the coin's edge in your thumb crotch and straighten your fingers.

Edge Grip Transfers: see the Roth section on Edge Grip,, and Framed Again (Getting Into Edge Grip: Method Three).

From Downs Palm to Back Clip: see The Sol Stone Section.

Other transfers will be discussed in context.

**The
DAVID ROTH
Section**

The Shuttle Pass

David Roth

This is a versatile utility move - many of the later routines in this book use it in one way or another (or another!). I'll assume, for the moment, that you're sitting when you learn this, though the move can be done standing as well.

Classic palm a coin in your right hand - that's the coin that'll be switched in. Another identical coin lies in finger palm on your palm-up left hand - that's the coin that'll be switched out. Your hands rest on the table about six to eight inches apart; your left hand palm up, just above the table, your right hand curled in a relaxed fist (fig. 16).

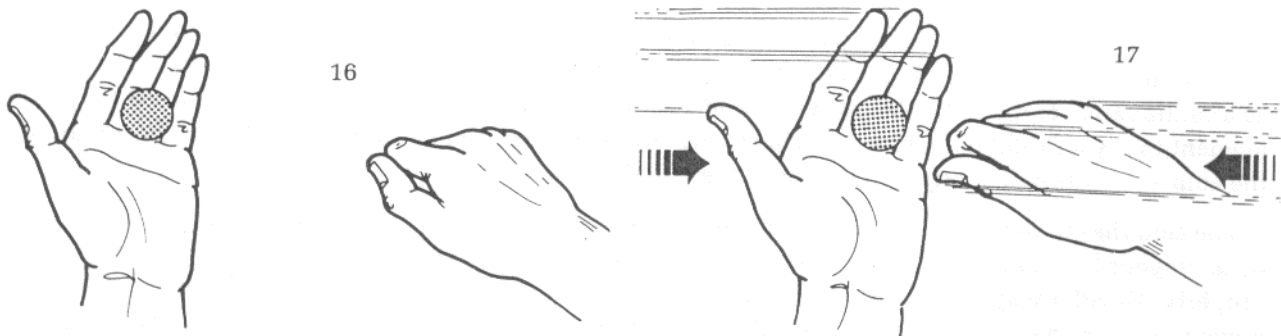

This is a balanced move, i.e., both hands begin moving at the same time and stop (when it's finished) at the same time. There are no loose ends, unnecessary movements, etc. The technique isn't difficult, but the timing is. It'll take some intense concentration to resist your natural urge to do things before the proper time. I'm telling you all this in advance because forewarned is forearmed: don't do anything until I tell you.

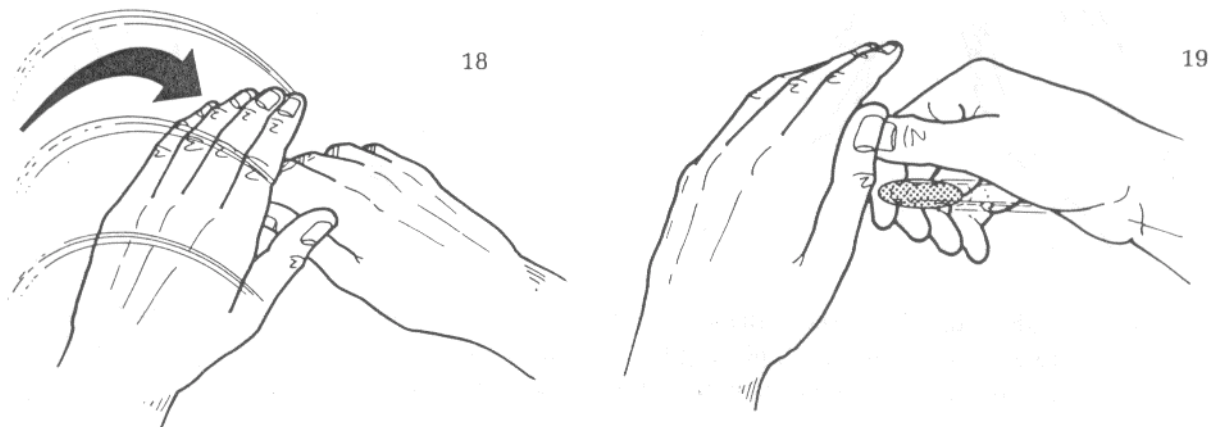

Okay; raise your right hand slightly and begin moving your hands toward each other. The right-hand coin stays in classic palm for now. Continue to move your hands together until your right thumbtip almost touches your left pinky base - it should be directly beside it (fig. 17).

Now, two things happen simultaneously. Your left hand's action is the simpler of the two - just turn it palm down, retaining the coin in finger palm (fig. 18). (David always raises and curls his left pinky a bit it gives the hand a flatter appearance.) At the same time your right hand turns palm up, your fingers moving beneath your left hand and pointing directly to the left. The timing on when your right palm relaxes and lets the coin fall onto your right fingertips (which happens as the hand turns up) is tough to explain. It happens at the last possible moment. In other words, you don't let the coin drop onto your fingertips and then simply turn your right hand palm up when it reaches your left hand - it doesn't look good. Let's go over the last few movements again.

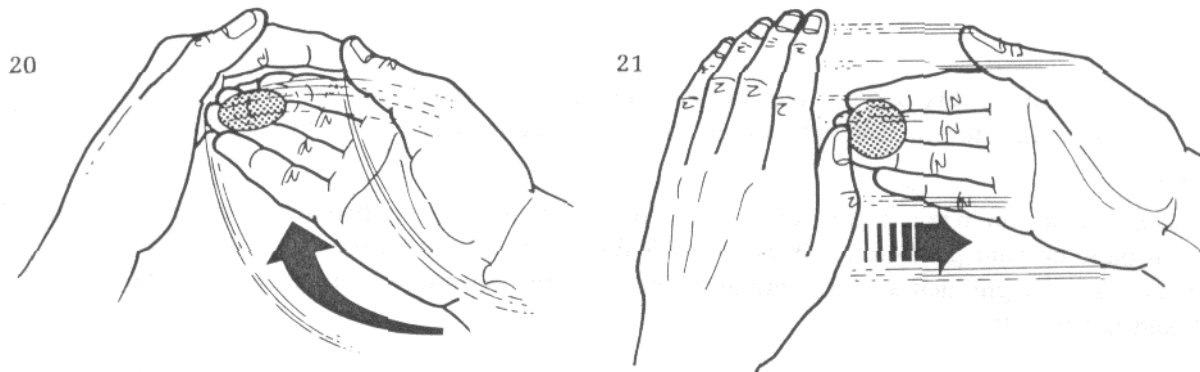

When your hands are moving together, and your right thumbtip almost meets the left pinky base, your hands immediately start turning over - your right hand palm up and your left hand palm down. It happens as a continuation of the to-the-left movement of your right hand. If you relax your right palm at the precise moment that your right hand stops moving to the left the momentum of the entire hand will be imparted to the coin - and it will continue to move to the left (fig. 19).

The coin flies to the left at the same time that your right fingers are straightening, and it lands on them beneath your left hand (fig. 20). It's really much simpler than I'm making it sound, but I want you to do it properly. David always thinks of it as if his palm is throwing the coin onto his fingertips. Immediately move your right hand directly to the right, bringing the coin out from beneath your left hand (fig. 21).

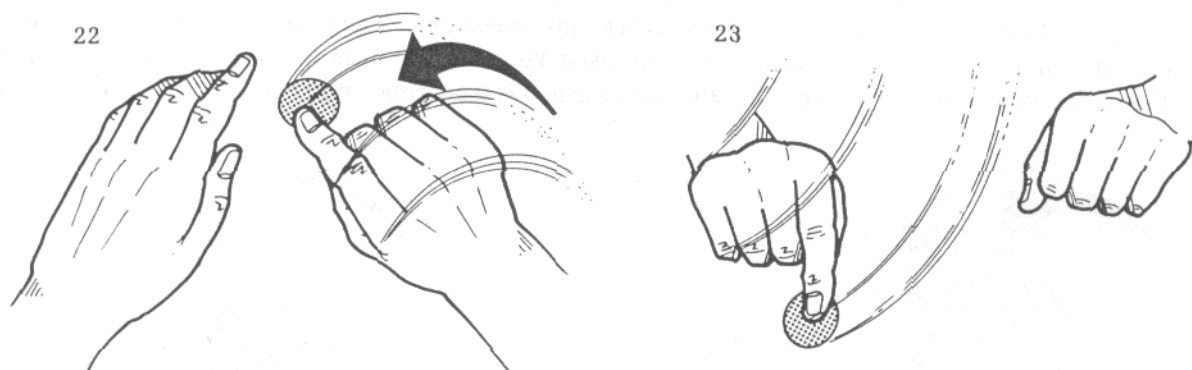

Move your right thumb onto the coin's edge and turn your hand over (fig. 22). Your right hand moves diagonally outward and to the right, placing the coin on the table (fig. 23). As your right hand descends your left hand also moves downward, settling into a relaxed fist on the table.

In Addition: Wait until the last possible moment to:

- 1) start turning your left hand palm down and your right hand palm up. They should be almost touching. 2) drop the classic palmed coin onto your fingertips. Remember, your right hand stops moving and the

momentum is imparted to the coin, which flies to the left and falls onto your fingertips. 3) move your right thumb onto the coin that's resting on your fingertips. Your right hand moves to the right, drawing the coin out from beneath your left hand, then your thumb moves onto its edge.

The value of David's handling of this move will become more apparent as you read how it's used later on.

Edge Grip Technique

David Roth

David did not invent the Edge Grip. It's an ancient technique, and probably hundreds of years old. Originally, before David tinkered with the move, you had to turn your back in order to put coins into Edge Grip: it was strictly a one-shot concealment. David is releasing two of his methods for getting into the grip in full view of the audience (they occur, of course, in the context of routines). Other techniques which are made possible through the use of Edge Grip, and which will later be used in various routines, will also be explained.

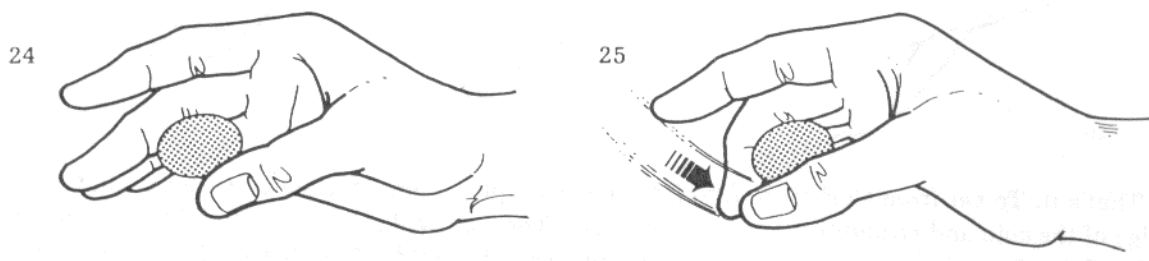

Take a half dollar and grip it as shown in figure 24. It's held horizontally (parallel with the floor or table) between your thumb and second finger. On the second-finger side the coin rests between the joints, leaving the second fingertip free. On the thumb side the coin should be inward just enough so that your thumb and second fingertip can touch when curled around the coin (fig. 25). That's your best guide - if you can touch your thumb to your second fingertip then the coin is in exactly the proper position.

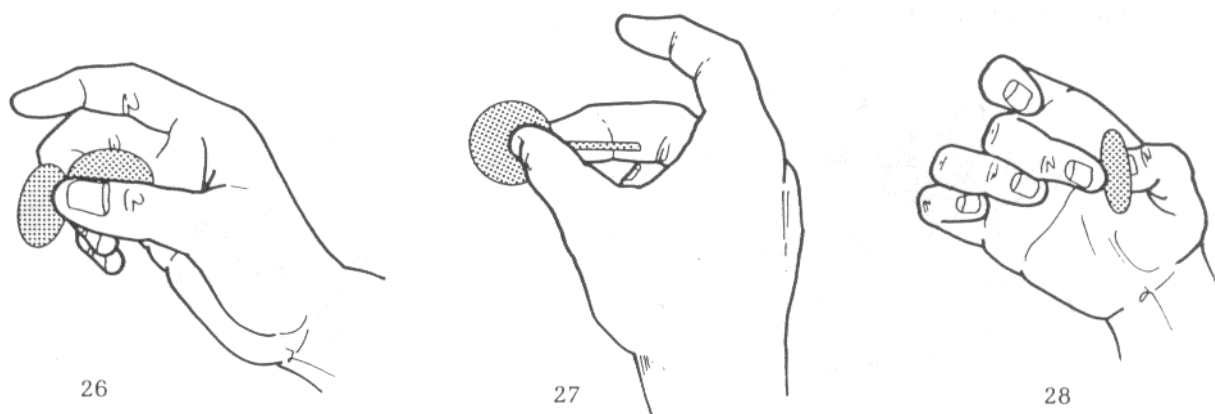

Take another coin and place it, held vertically, between your thumb and second fingertip (fig. 26). The coin, or coins, held this way - in Edge Grip Display - are your logic (or justification) for holding your fingers in such a peculiar position. It's not strange when something is held there - it is if nothing is held.

When you hold your right hand at eye level you should be able to see only the edge of the Edge Grippped coin, and second finger both above and below (fig. 27). If you hold your hand in that position, so your view is exactly the same as in figure 27, then the concealed coin will be parallel with the floor and concealed from the spectator (fig. 28 is the audience view). You must practice raising and lowering your hand, tilting it slightly so that the coin in Edge Grip remains hidden.

Curl Palm

One of the problems David had in developing routines with Edge Grip was the frozen position of your thumb and second finger when coins were being concealed. He solved it by developing a palm that can be instantly gotten into and out of from Edge Grip without any additional movement.

Place one coin in Edge Grip, held horizontally between your right thumb and second finger. Curl your second finger around the coin's edge as far as you can (fig. 29). Your thumb and second finger press the coin inward against the length of your second finger (so it's completely wrapped, or curled, around the coin) (fig 30). By keeping your second finger curled tightly around the coin's edge you can move your thumb away and retain it there [fig. 31).

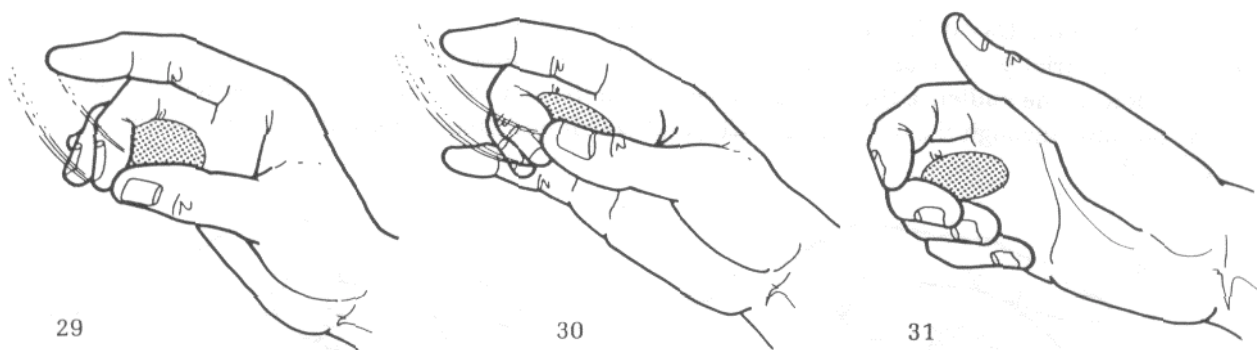

That's it. To get from Curl Palm into Edge Grip simply reverse the actions: move your thumb onto the edge of the coin and straighten your second finger. The coin will roll out a bit and fall naturally back into Edge Grip. Once the coin or coins have been transferred from Edge Grip to Curl Palm your thumb and first finger can pick up and hold other coins, etc. You can also rest your hand on the table in a relaxed fist while coins are in Curl Palm.

Edge Grip Load

Most standard handlings make this kind of thing awkward - secretly loading an extra coin into your hand as you openly drop other coins into it. The very nature of the Edge Grip cleans this up completely.

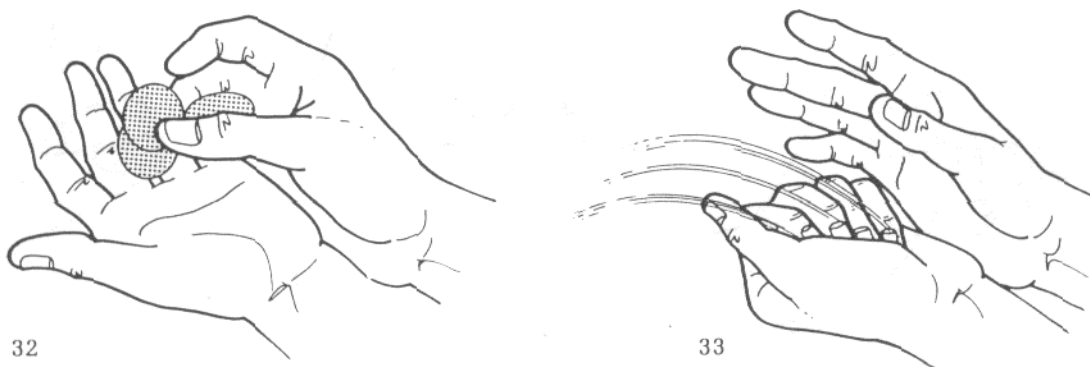

Place a coin into Edge Grip and hold two other coins in Edge Grip Display - vertically between thumb and second finger, visible to the audience. Move your right hand over your palm-up left hand (fig. 32).

Separate your thumb and second finger, dropping all the coins (both those visible and concealed) into your left hand. Naturally, your left fingers close immediately around them (fig. 33). The illusion is perfect. Your hands appear to be unquestionably empty as you drop two coins into your left hand - and you've secretly loaded an extra coin.

Shuttle Pass From Edge Grip

If you want to do the Shuttle Pass as already taught, but have a coin concealed in Edge Grip instead of classic palm, this is how.

A coin rests in finger palm on your palm-up left hand. There's an identical coin hidden in Edge Grip in your right hand. Your hands are about six inches apart, etc., as already described. Your right hand is relaxed, fingers pointing downward (fig. 34).

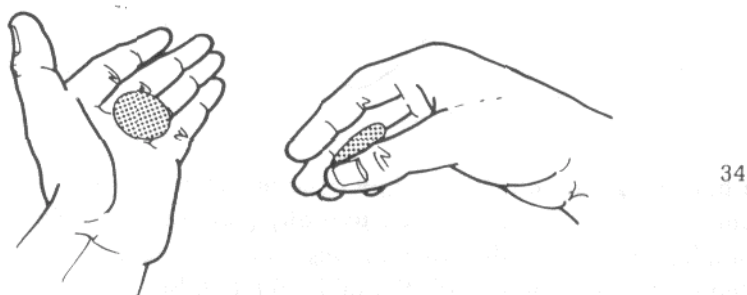

Move your hands together until your right hand is directly beside your left hand. Start simultaneously turning your left hand palm down and your right hand palm up (fig. 35). You don't have to worry about transferring the coin from classic palm to your fingertips because it's already there - so the move is easier to do this way.

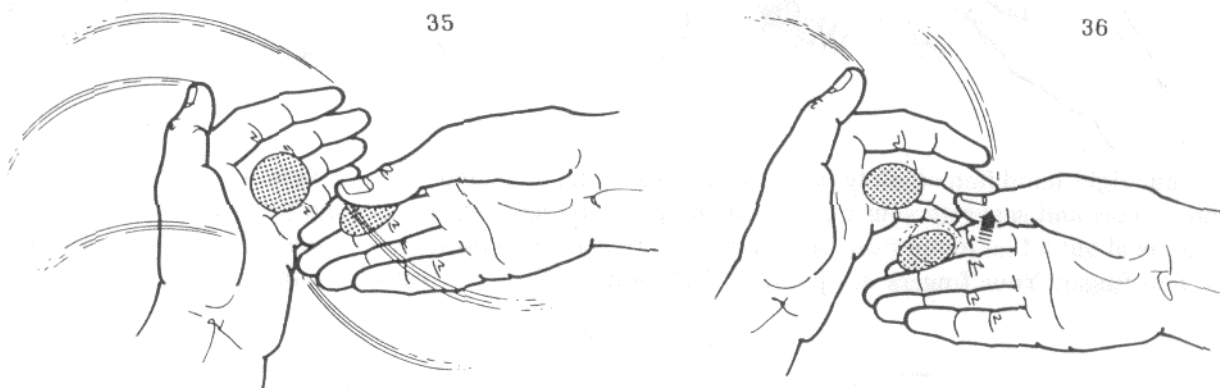

As your right hand turns palm up your right thumb simply tips the coin forward so that it falls across your first and second fingers (fig. 36). Continue as in the regular handling of Shuttle Pass, moving your right hand to the right, out from beneath your left fingers, and then moving your right thumb onto the coin and placing it aside (or whatever the routine calls for).

Shuttle Pass Drop

This allows you to show one coin in your left hand, transfer it to your right hand, and drop it onto the table while simultaneously concealing up to three other coins in Edge Grip.

Let's assume that three coins are Curl Palmed in your right hand, and one coin lies in finger palm on your palm-up left hand. Your hands are about six inches apart in Shuttle Pass position. Your right hand is relaxed and resting on the table in a loose fist. Raise your hands a bit and transfer the three concealed coins

from Curl Palm to Edge Grip. Afterward your right hand hangs loosely at the wrist, fingers pointing downward.

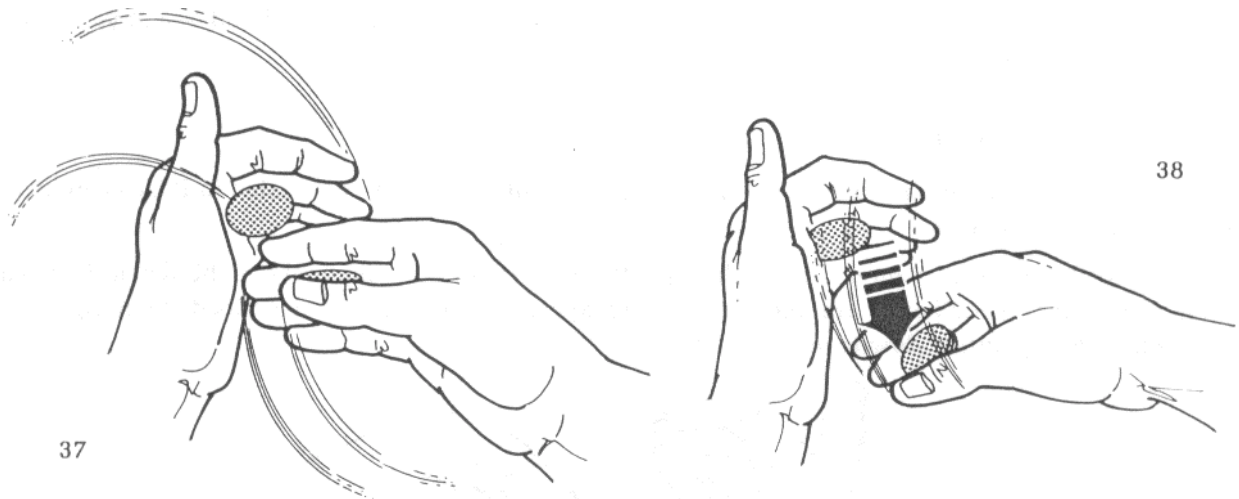

Move your hands together until your right hand is just beside your left hand. Simultaneously turn your left hand palm down and your right hand partially palm up - the Shuttle Pass action. Don't turn your right hand completely palm up, though, stopping when the insides of your fingers are toward you and the three concealed coins are parallel with the table (fig. 37). Rock your right hand downward a bit as if it's caught the coin (fig. 38).

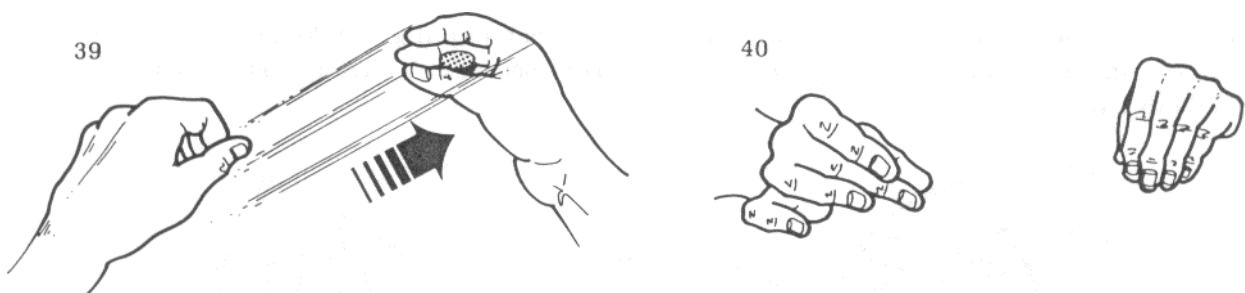

Your right hand immediately moves away from you, diagonally outward and to the right (fig. 39). As it moves curl and separate your right third and pinky fingers (fig. 40 is an audience view). When your right hand is about a foot away from you, and about two or three inches above the table, relax your thumb and second finger. Your fingers are pointed slightly downward, the coins at a forty-five degree angle to the

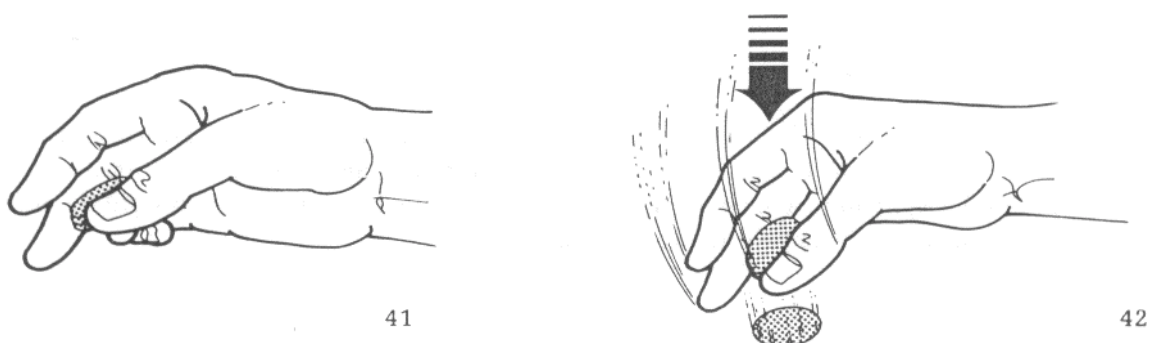
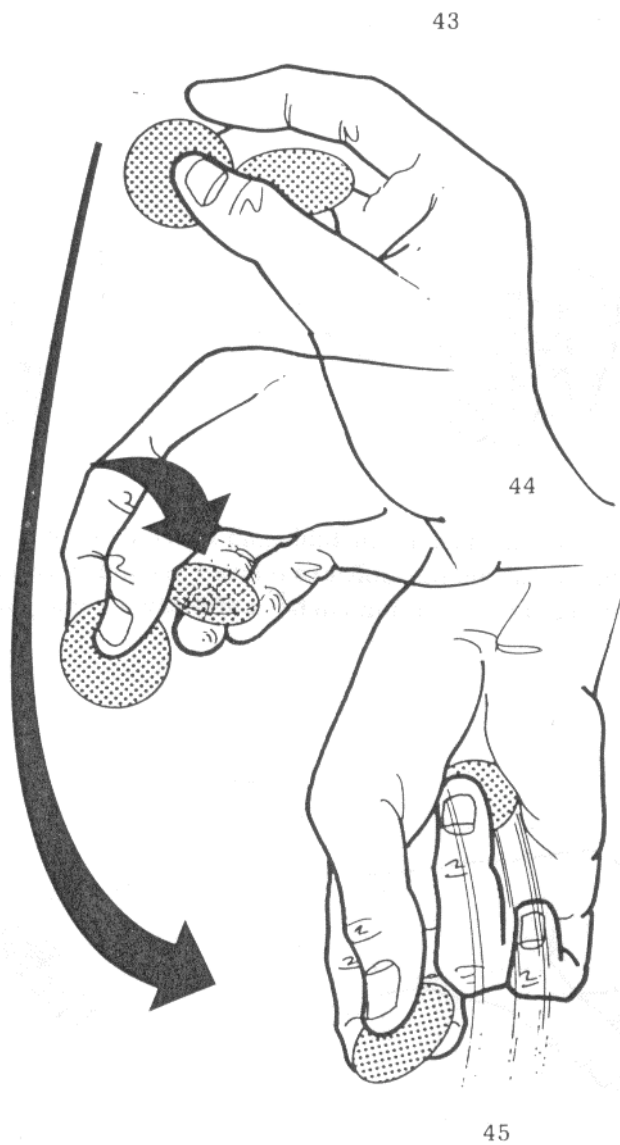

table (fig. 41). Move your right hand sharply downward (only an inch or so) allowing the bottom coin to drop off the stack and onto the table (fig. 42). It should look as if you've deliberately put the coin down. It's a precise, crisp, movement. Your hand does not move over the table and remain motionless in the air while the coin drops from it - it moves downward as if putting the coin down. There should be no pauses, either.

Once the coin has dropped retract your right hand, Curl Palming the two coins it still contains. At the same time allow your left hand, still holding a finger palmed coin, to settle into a relaxed fist.

Edge Grip Recovery

There are two coins in your right hand, one in Edge Grip and the other in Edge Grip Display. You want to quickly and secretly transfer the coin from Edge Grip to classic palm. Figure 43 shows the starting



position. Lower your right hand turning it palm down, at the same time relaxing your thumb and second finger so the Edge Grippped coin falls to fingertip rest (fig. 44). Your third finger immediately pushes the coin upward into classic palm (fig. 45). At the same time your thumb, first, and second fingers twirl the visible coin.

The Scoop Addunder

David Roth

This is a clean technique for adding a classic palmed coin to another group which is picked up from the table. This will work only on a soft surface.

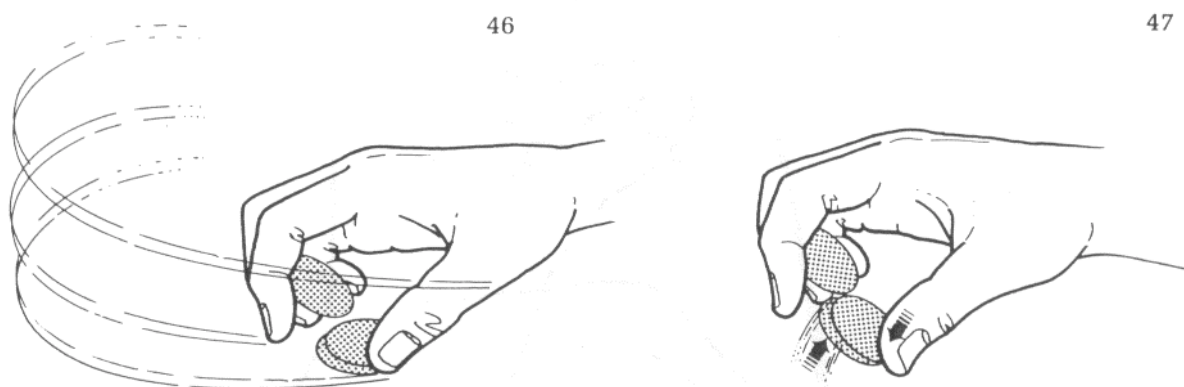

Let's say that two coins are stacked on the table and the coin you wish to add is in classic palm in your right hand. Your right hand rests on the table in a relaxed fist and allows the classic palmed coin to drop to fingertip rest. Your right hand circles around in front of the two coins, your thumb moving onto their inner edges (fig. 46).

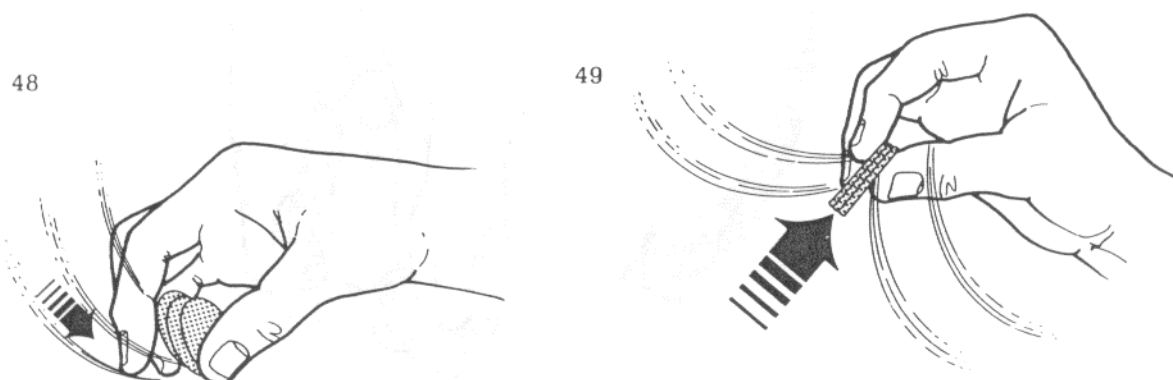

Your thumb presses downward causing the outer edges of both coins to rise (fig. 47). Your fingertips, on which rest the third coin, slide beneath the two raised coins, adding the concealed coin to the bottom of the stack (fig. 48). Your thumb flattens against the inner side of the stack so that all the coins are firmly gripped between your thumb, first, and second fingers as your right hand is lifted (fig. 49).

Now you can do whatever the particular routine calls for - put them into your left hand, or into a purse, etc.

The Frontal Imp Pass

David Roth

This variation of Slydini's Imp Pass will be applied in two routines later on - Wild Coin No. 1 and The Portable Hole. David's handling of the move is different than Slydini's in several important ways, but Slydini's principles of timing and misdirection are the same.

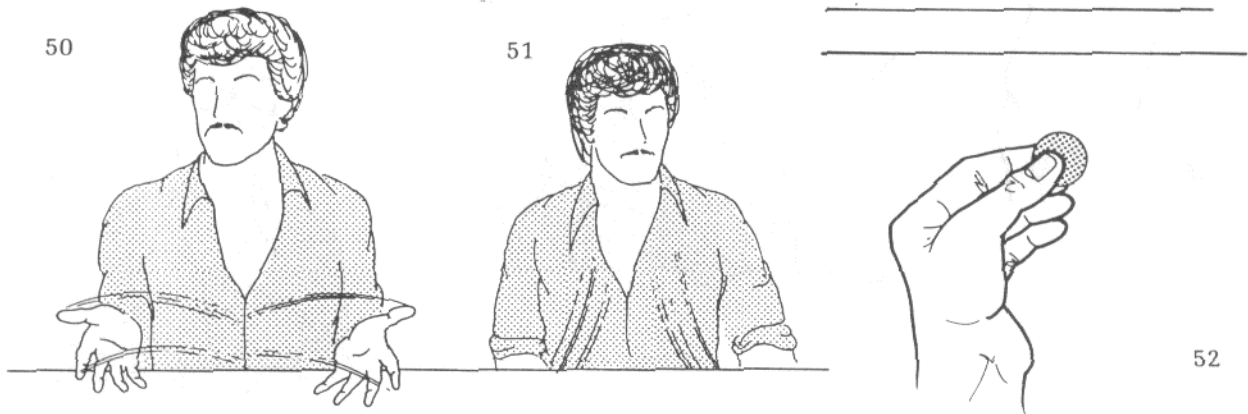

Let's say that you've got a coin in your lap that you must transfer to classic palm in your right hand. Lean forward and extend both hands in a palm-up gesture with some accompanying remark (fig. 50). (The exact

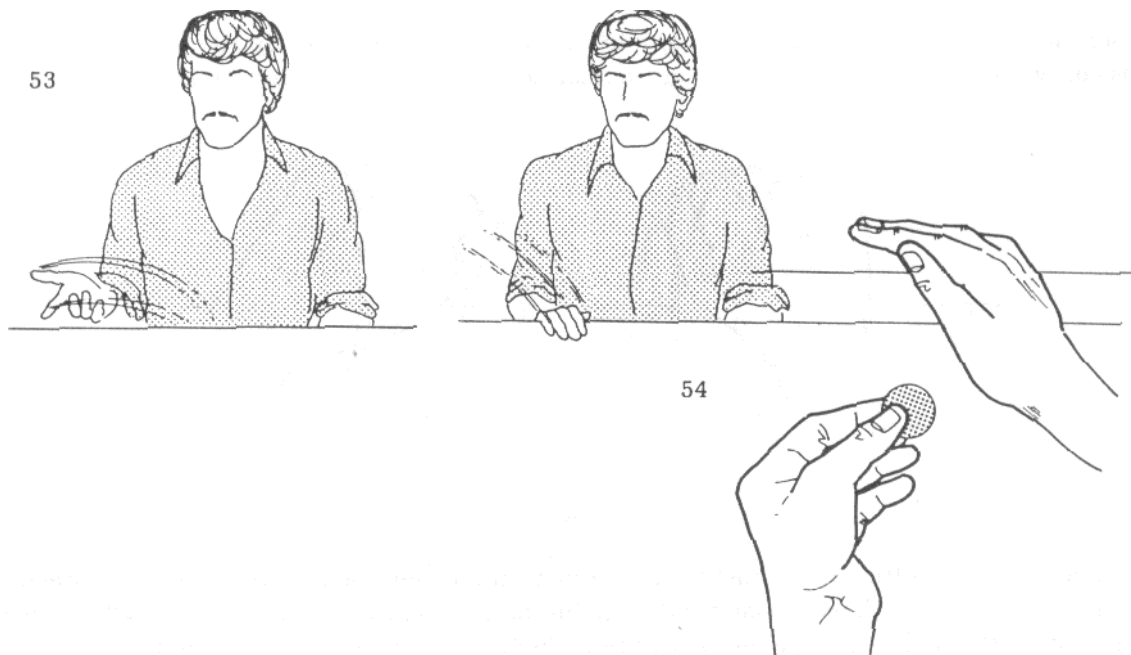

patter, of course, should be related to the effect in which the move is used.) After the remark lean back and relax, allowing both hands to drop into your lap (fig. 51). Your left hand immediately picks up the coin and holds it between thumb, first, and second fingers (fig. 52).

Make another remark and raise your right hand, palm up (fig. 53). After the remark turn your hand palm down and let it drop so that your fingers rest on the table and the rest of the hand hangs over the edge, concealed from the audience (fig. 54).

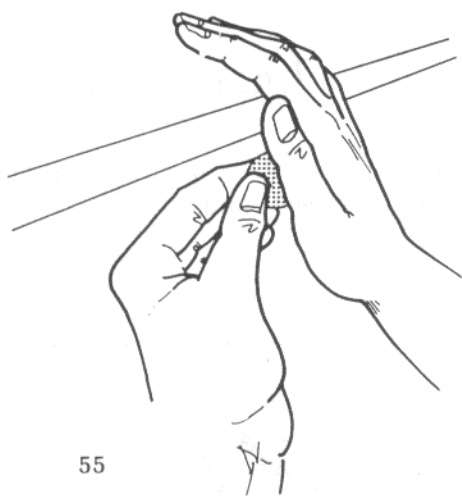

55



56



57

Your left hand, which has risen slightly in preparation, sticks the coin into right-hand thumb palm (fig. 55). Without pausing raise your left hand in a palm-up gesture with another remark (fig. 56). Afterward turn your left hand palm down and drop it to the table in the same position as your right hand (fig. 57).

Curl your fingers, pulling your hands upward into fists on the table (fig. 58). You'll find that as your right fingertips curl you can easily transfer the thumb palmed coin to fingertip rest and, later on, to classic palm.

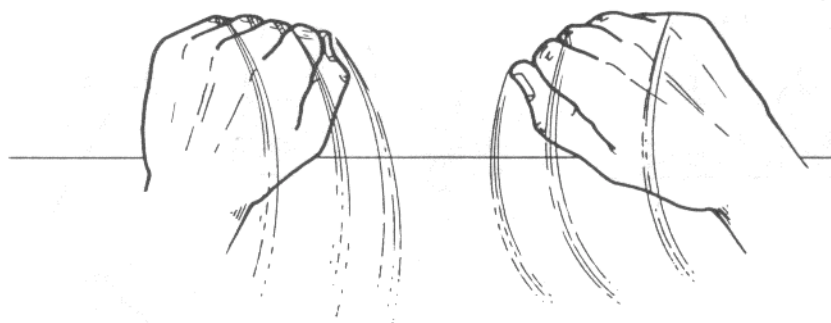

58

In Addition: This isn't difficult, you just have to justify all the movements with patter and practice the timing. You need three short lines - one for each palm-up gesture. Here's an example: "What else can I say?" (said during the both hands palm-up gesture); "You've seen these coins. . ." (said during the right hand's palm-up gesture); "...and you've seen these coins" (said during the left hand's palm-up gesture).

You can load the coin directly into classic palm, but that takes a bit longer and is more difficult.

Pop Outs

David Roth

David didn't want to include this because he doesn't use it anymore, and consequently doesn't practice it. It's the type of thing you have to do all the time or not at all. I insisted upon including it because it's one of the few introductory productions I know - it's a way to magically produce a coin or two before going into a routine. It's also an integral part of my Open Travelers routine, which appears in the next to last section.

Classic palm a coin in your right hand and hold your hand palm down about four inches above the table. I'll tell you in advance that this move will seem difficult because you're going to have the urge to do all sorts of little things to try and help this - when you don't have to! You'll be tempted to jerk your wrist, move your fingers, etc., and none of that makes it any easier.

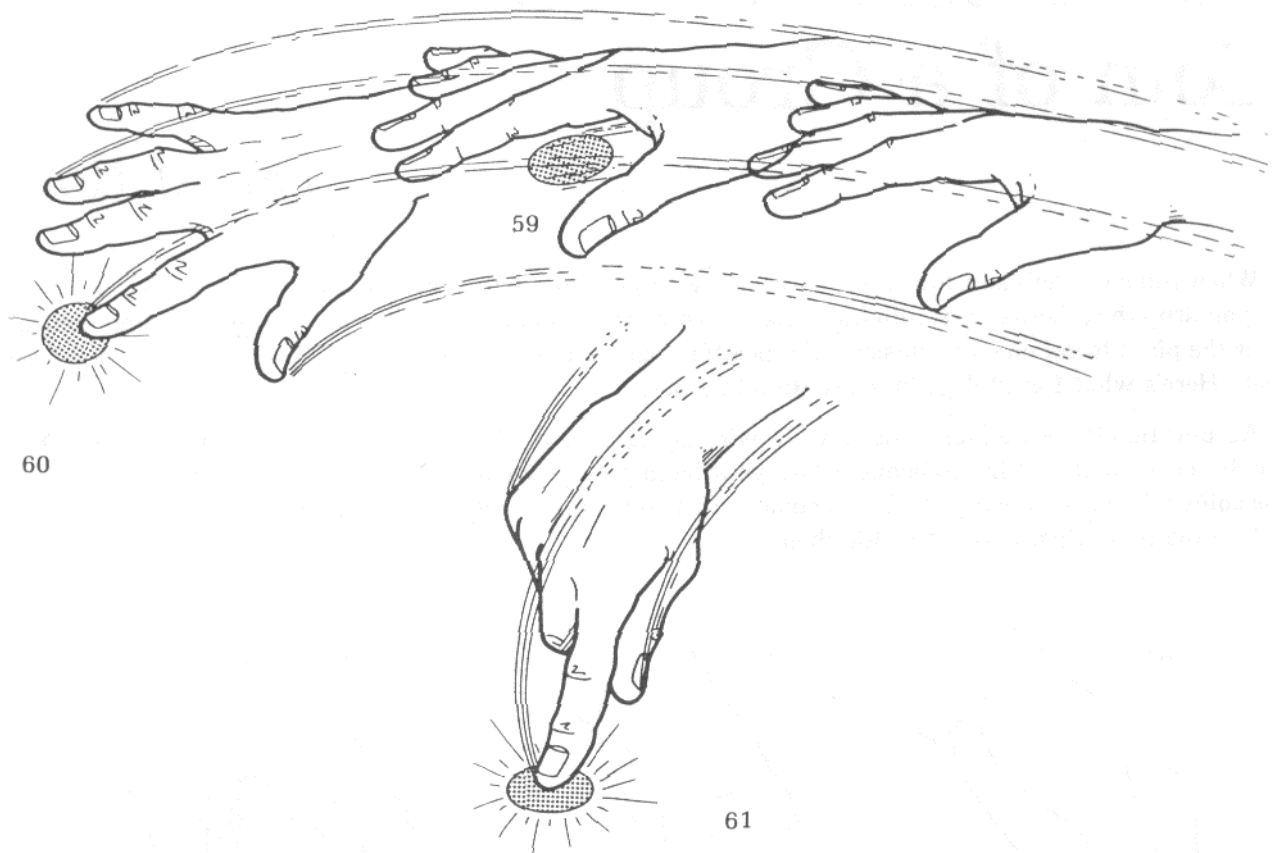

All that happens is this. Briskly move your right hand forward about six inches, relaxing your palm when you reach that point. Your right hand must freeze so that its forward momentum is imparted to the coin - which will fly forward (fig. 59). As the coin flies it'll pass directly beneath your first finger. When it does your first finger must push it downward, jabbing it to the table (fig. 60).

It's going to take some practice before this works consistently - and it has to work every time because there's no out. If you miss it looks lousy. It can work all the time if you give it the practice it deserves. The timing is all that matters: you must learn to stab your first finger downward exactly when the coin passes beneath it.

You can do the move the way it's already been taught, or with your second, third, and pinky fingers curled so it appears as if you point to a spot on the table and a coin magically appears beneath your fingertip (fig. 61). The mechanics are the same.

You don't have to help the coin in any way. Don't jerk your hand forward and back, don't snap your wrist upward, trying to toss the coin outward. just shoot your hand forward, relax your palm, and freeze, jabbing your first finger downward.

It's possible, with a great deal of practice and control, to classic palm a stack of several coins (as many as four) and do the move four times in a row, producing four coins one at a time. Think of the illusion - it just might be worth the work.

To Classic Palm One Coin of a Group

David Roth

When you have, let's say, four coins spread on your palm-up right hand and you want to classic palm one as you drop the others either onto the table or into your left hand, you'll often see people bouncing them all over the place to get one into classic palm position. That's a visually distracting thing, and unnecessary as well. Here's what David does in a situation like that.

Assume that there are four coins on your palm-up right hand - they can be anywhere, spread or stacked, etc. It doesn't matter. Simultaneously turn your hand palm down and curl your fingers into a loose fist the coins will automatically stack and come to rest on the insides of your fingers (fig. 62). Note that they're not on the fingertips, but just inside them.

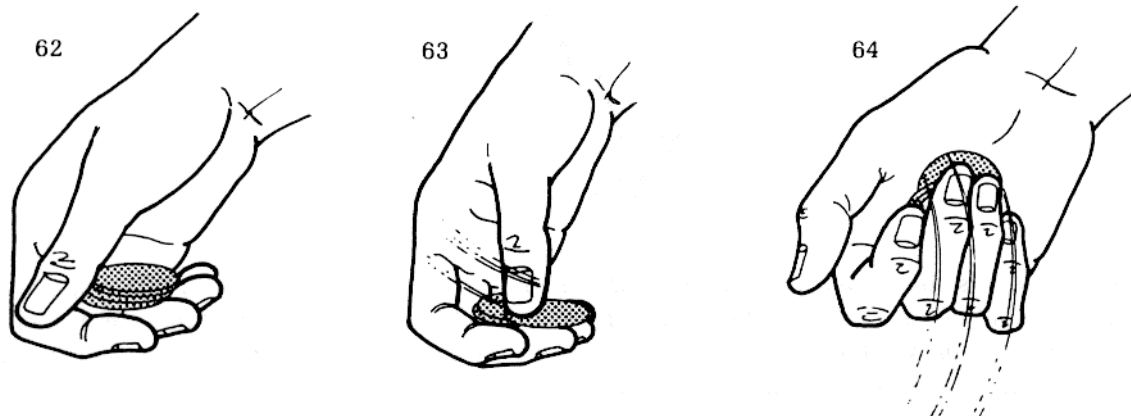

Move your thumbtip onto the top coin and slide it toward your fingertips about a quarter of an inch (fig. 63). Move your thumb away and curl your fingers inward, your fingertips pressing the in-jogged top coin into classic palm (fig. 64). Lower your fingers and jingle the coins a bit. One coin is now in classic palm and the other three are loose.

If you like, after you've pushed the coin into palm, turn your hand palm up to display the coins again one will be neatly in palm position with the others spread and overlapping in front of it (fig. 65). Now, when you turn your

hand palm down, three coins will fall onto the insides of your fingers while one remains in classic palm. You can use this technique with any number of coins.

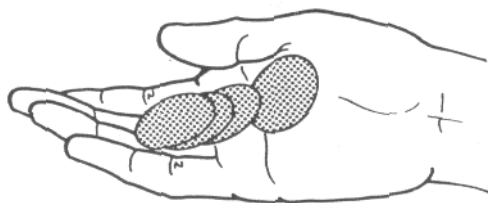

65

The Deep Back Clip Steal

David Roth

Though Deep Back Clip is not a new grip it's been kept underground, pretty much within the inner circle, for so long that it remains virtually unknown. It's a difficult super-clean technique that is useable only under specific performing circumstances. You must be standing, working for spectators who are also standing. If you learn this I think you'll find that you can use it more often than you'd suppose.

Deep Back Clip

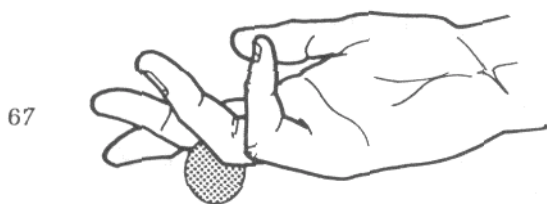

67

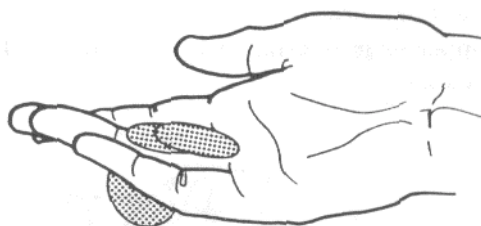

68

A coin in this grip is concealed beneath your palm-up hand, held by its upper edge between your second and third fingers near the hand (fig. 67 is an underview). There are always coins in finger palm to cover the possibility of the concealed coin's edge peeking out from between the fingers (fig. 68). It's difficult to hold a coin or coins securely in this grip without a lot of practice. It is, however, worth the work.

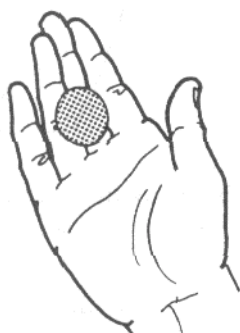

69

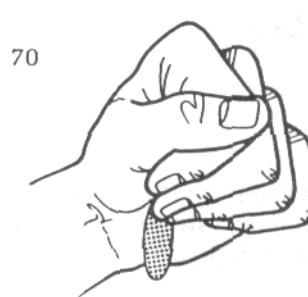

70

The actual Deep Back Clip is not David's, but the following steal (which is based on an idea of Roger Klause's from his *New Theory Coins Across in Kabbala Vol. 1 No. 4*) is. Let's assume you're going to do a standard transposition where you have a coin in each hand and both jump to one hand.

Place a coin in each palm-up hand in finger palm and display them (fig. 69). Curl your fingers and turn your hands palm down. You want the coin that's in your right hand to stay in finger palm and curling your fingers before you turn your hand over insures that. Relax your left hand and allow its coin to drop to fingertip rest. Stretch your fingers as far as they'll go toward your wrist and press the coin upward. Slide Your fingers off the coin, letting it dan-

gle downward, your fingertips holding only the inner edge (fig. 70). You can now, if you like, push it even farther toward your wrist.

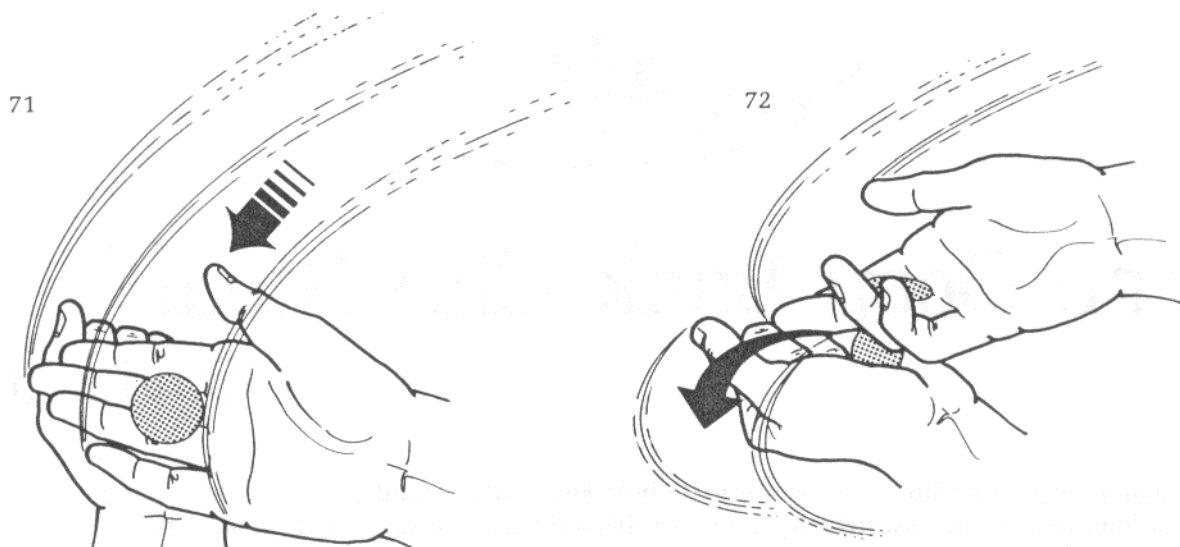

Turn your right hand palm up and open your fingers, revealing the coin still in finger palm, and say, "The coin in my left hand will jump from here to here." As you patter do the steal. Like this. As you say, ". . . from here. . .," two things happen simultaneously. Your right hand swings to the left, moving over your left fist, and your left fist turns over (fig. 71). The coin hanging outside your left hand is covered by your right hand, and its upper edge is gripped in Deep Back Clip while your right hand is directly over it (fig. 72 is an exposed view).

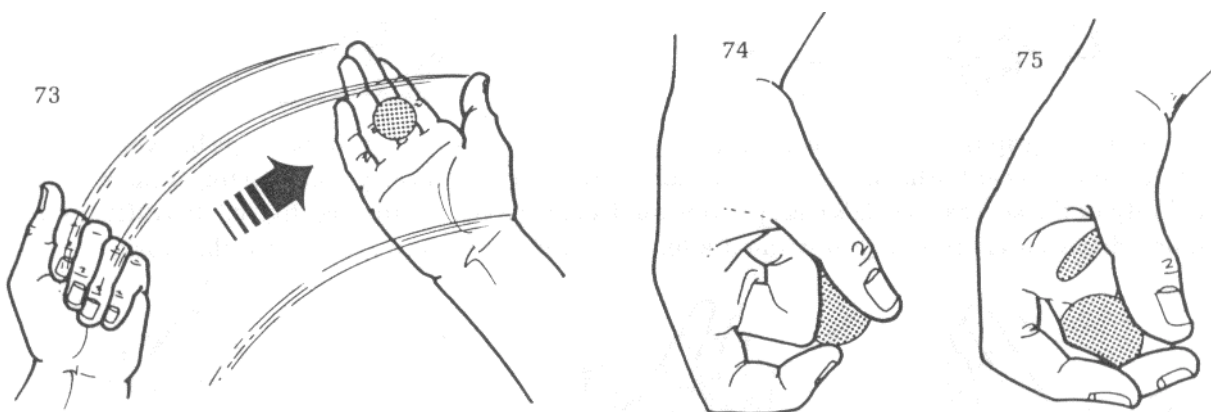

As you complete the sentence and say, ". . . to here," swing your right hand outward again (fig. 73). Close your right hand into a fist, at the same time turning it palm down. The Back Clipped coin will hang beneath it. Turn your left fist over.

You'll find that by curling your right fingers you can squeeze them beneath the coin in finger palm, transferring it momentarily to fingertip rest. Immediately push it up into classic palm. Your thumb reaches beneath your fingers to the Back Clipped coin (fig. 74). Pull it inside your fist (fig. 75). Once inside let it fall flatly onto your second and third fingertips in rest position. Then, allow the classic palmed coin to fall onto it with a clink and open both hands as you turn them palm up to reveal both coins in your right hand.

In Addition: The steal from your left fist has to be done quickly and smoothly - your right hand swings over it and almost immediately moves away again without pausing. It appears as if your hands never touch. Also, make sure that your left fist turns up at exactly the proper moment - too soon and you'll expose the coin that's hanging outside it.

The Karate Coin

David Roth

David has used this effect in his lecture for many years, and several new methods will be taught here as well as a portion of his original handling. It's based on The Finger Gimlet, an item which appeared in the lean Hugarad booklet on coin magic. You need a half dollar with a hole drilled through the center just large enough for the tip of your right first finger to fit through. It must be a tight fit - the spectators never see the hole, only your finger's apparent penetration through the coin.

Stab No. I

This is how David stabbed the coin in his lecture. To prepare, classic palm the Karate Coin in your right hand. To perform, have a regular coin examined and then take it with your left hand. Maneuver the coin into finger palm on your palm-up hand, ready for the Shuttle Pass. Move your hands together, your left hand turning palm down and your right hand turning palm up in the rocking Shuttle Pass action. Here, however, before you can move your right hand out from beneath your left hand to display the coin your right thumb must move onto it and cover the hole (fig. 76).

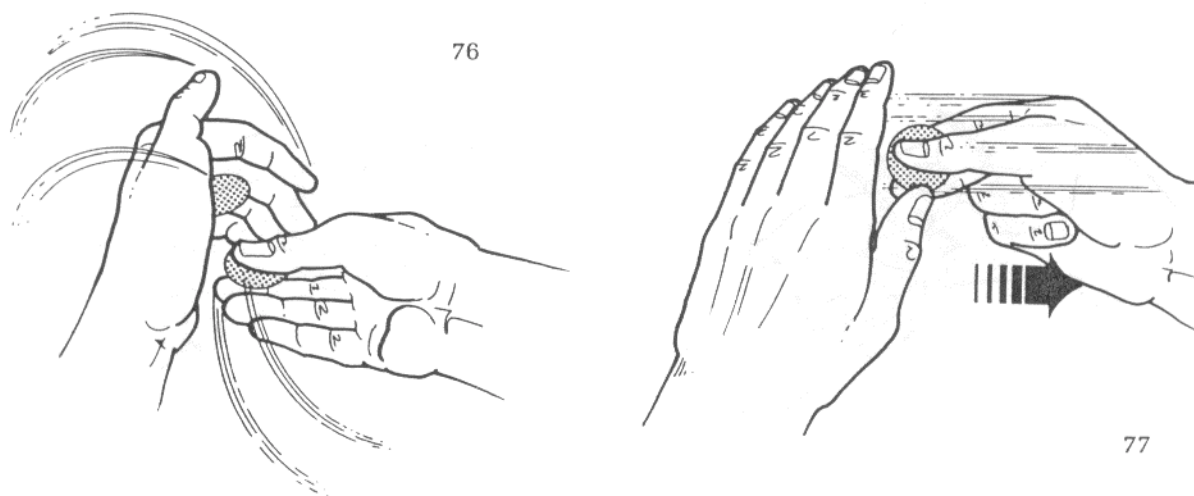

Now move your right hand to the right curling your third and pinky fingers so that the coin is held solely by your thumb, first, and second fingers (fig. 77). Turn your left hand palm up, keeping your fingers slightly curled to hide the regular half dollar in finger palm. Your right hand places its coin between your left thumb, first, and second fingers in Spellbound position (fig. 78). Note that your right first and second fingers cover the hole.

With a sharp motion jab your right first fingertip through the hole (fig. 79). Really push it in so that the flesh expands over the immediate area around the hole so no opening can be seen. Move your right hand away and extend the stabbed coin upward for display.

78

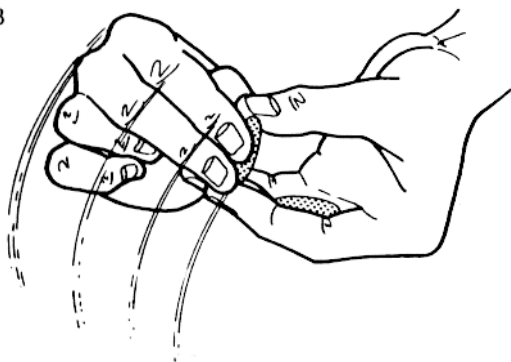

79

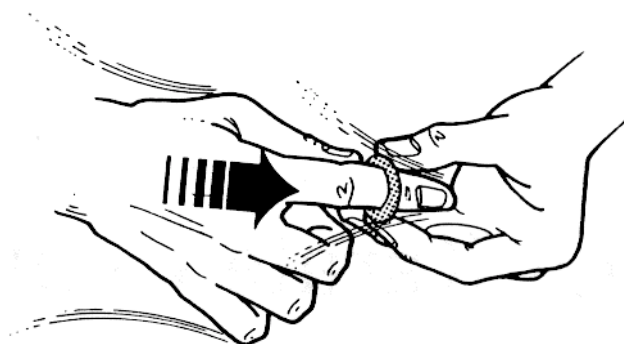

Restoration No. I

A new visible restoration. After you've displayed the Karate Coin on your finger your left thumb and first finger pull it toward your fingertip a tiny bit, so it's loose, and tilt it, so the hole doesn't show (fig. 80).

80

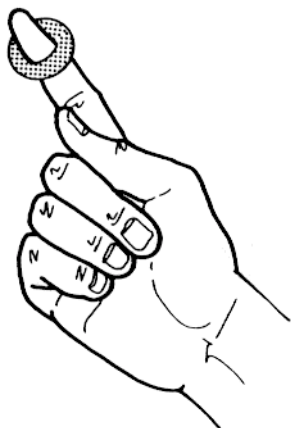

81

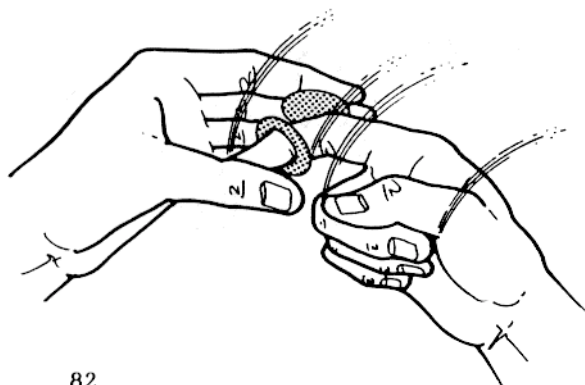
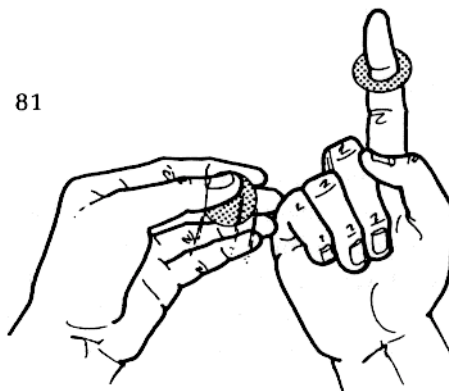

82

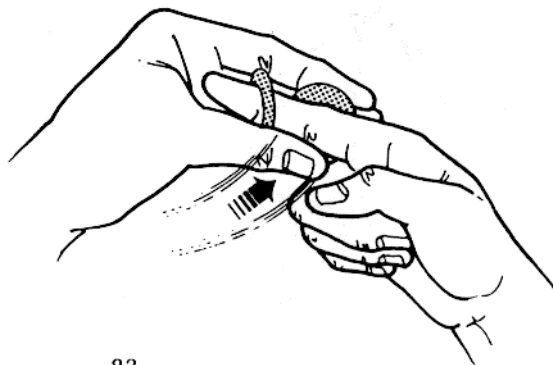

83

Hold your left hand palm toward you and, with your left thumb, push the finger palmed coin to behind your first and second fingertips (fig. 81). Move your extended right first finger inside your left fingers, your left thumb moving out of the way and the back of your right first finger pressing the regular coin in place (fig. 82). Move your left thumb onto the inner edge of the Karate Coin, its outer edge pressing against the second joint in your left fingers (fig. 83).

Slowly pull your first finger out of the Karate Coin, your left thumb snapping it flat into finger palm (fig. 84). Push the coin downward to lower finger palm, your slightly curled third and pinky fingers holding it in place (fig. 85).

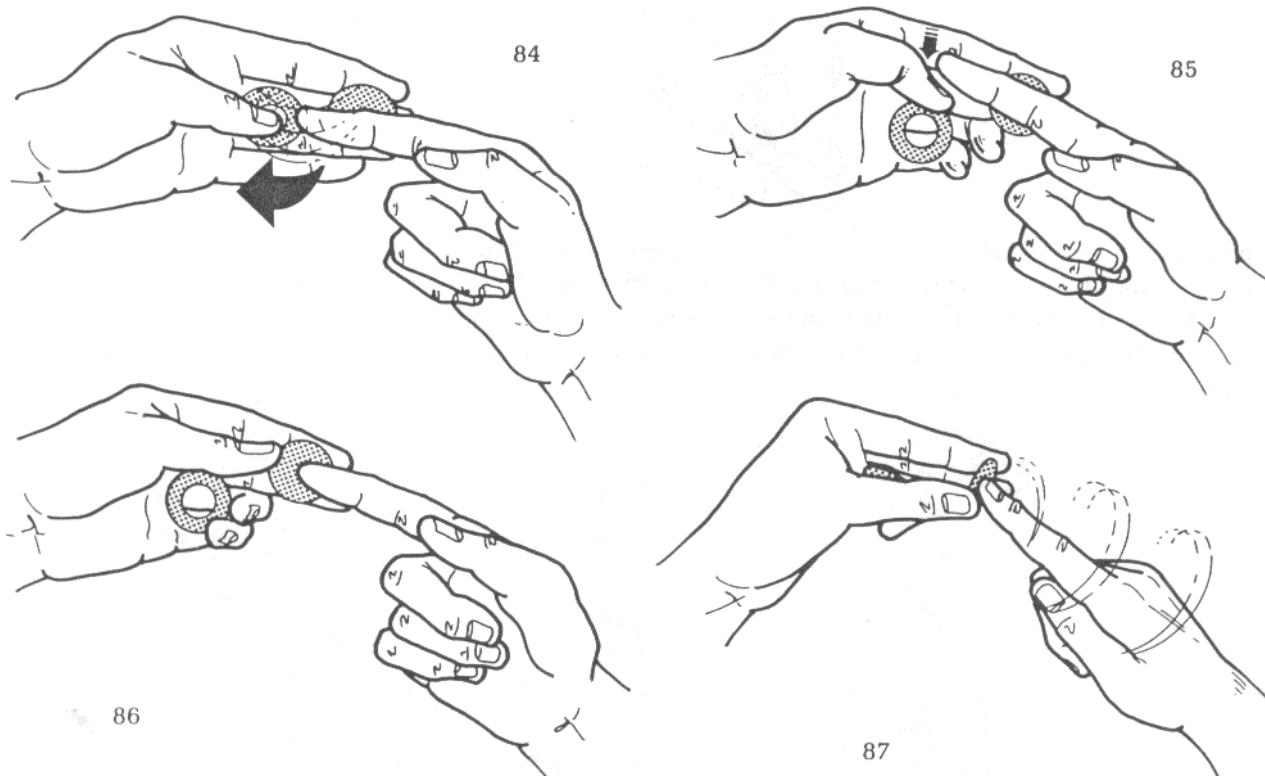

Begin sliding your right first finger out from behind your left fingers, its back continuing to press the real coin against your left first and second fingers. As soon as it's able, while your first fingernail still holds the coin in place, your left thumb moves onto the left edge of the regular coin (fig. 86). Two things happen at the same time. Your left thumb levers the coin to Spellbound position and Your right hand turns palm down (fig. 87). The coin should now be visible to the audience. Sharply lift your first finger to reveal the whole coin (fig. 88).

I know that seems like a lot of little steps, but it's very deceptive if you combine them smoothly.

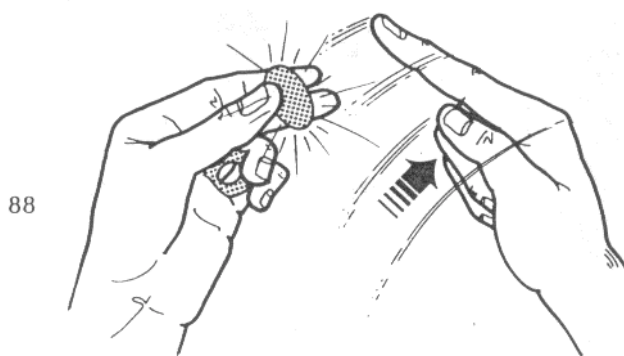

Stab No. 2

Roth and Latta

Both this handling and the restoration which follow have not been released before. Start with the Karate Coin in righthand thumb palm. The regular coin can be examined. You should be standing with your left

side to the audience, your right hand hanging naturally at your side. Take the regular coin with your left hand and display it on your palm for a moment (fig. 89).



At the same time you must insert your right first finger into the Karate Coin, and there are two ways to do it. You can simply curl your first finger and try to work it into the coin while it's in thumb palm, or you can allow the coin to drop from thumb palm to fingertip rest and then, while holding it between thumb and second finger, stick your finger through (fig. 90). Either way, keep your fingers loosely curled once the coin is in position.

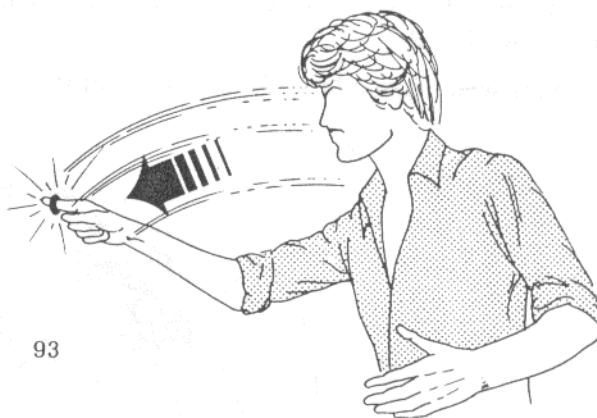
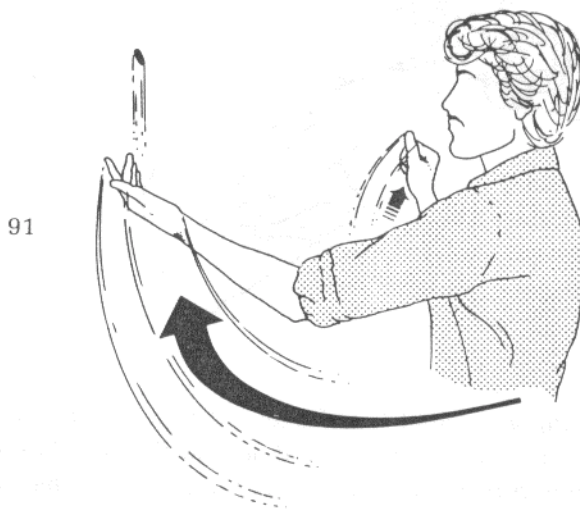

Toss the coin that's left in your left hand straight up in the air. As you throw it raise your right arm (fig. 91). Wait for the coin to reach its peak and then begin to fall. Shoot your right hand forward as the coin falls, opening your fingers (fig. 92). Catch the falling coin with your second, third, and pinky fingers and close them into a fist leaving your first finger extended with the Karate Coin on it (fig. 93). Display the coin on your finger. It appears as if your finger visibly penetrates the coin in midair!

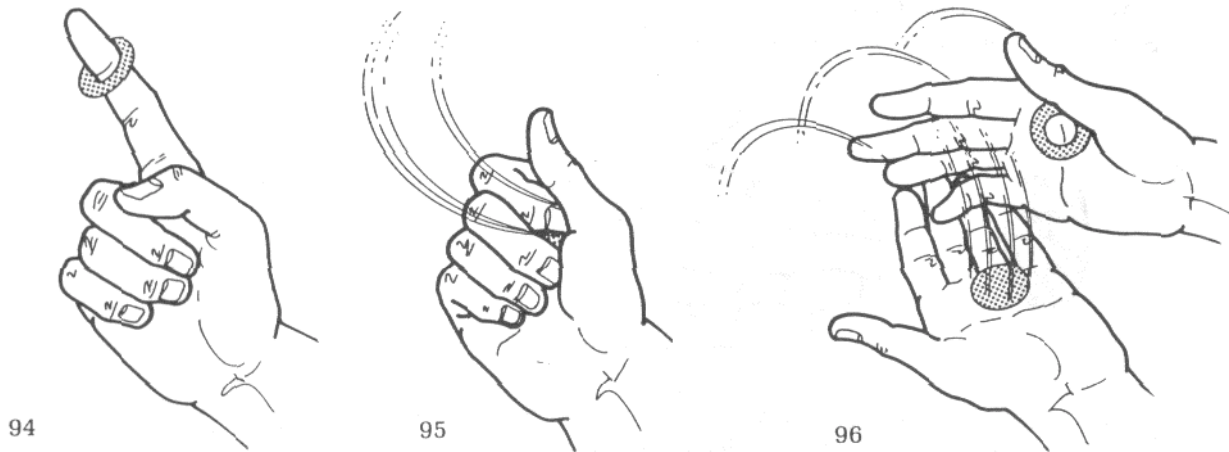

Hold your right hand so your first finger is pointing straight up (fig. 94). Curl your first finger and take the Karate Coin into thumb palm (fig. 95). Snap your first finger straight again as if it popped out of the coin.

Move your palm-up left hand beneath your right hand, which turns palm down, fingers straightening and dropping the regular coin onto your left hand (fig. 96).

In Addition: I've kept all the moves separated for a reason - you can mix and match either restoration with either stab. The best combination, I think, is Stab No. 2 and Restoration No. 1 - you simply have to transfer the real coin from your right hand to your left after the stab. It's easy, just bring them together for a moment (your left hand beneath your right) and let the coin slide from hand to hand.

The Complete Torn and Restored Coin

David Roth

This is another quick effect that uses the Shuttle Pass, and it bears a passing similarity in method to The Karate Coin because of that. The effect to laymen, of course, is radically different. This was one of the items I talked David into giving me while I was with Apocalypse and it was briefly described in Volume One, Issue Eight, though using a different switch because David didn't want to put the Shuttle Pass into print at that time. The restoration was also not described in detail.

You need to prepare a "torn" coin by taking a regular half dollar and making a jagged cut from edge to center, and then bending one of the sides of the cut inward (fig. 97). File the jagged edges smooth so you don't cut yourself (and so, as David put it, the coin doesn't "eat" your thigh if you carry it in your pants pocket between performances). Any jeweler can do this for you.

Classic palm the torn coin in your right hand with the cut directly in line with your fingers (fig. 98). That's important because it must land in the proper position after the Shuttle Pass so your thumb can cover the tear. Display a regular coin on your palm-up left hand in finger palm (it's been previously examined). Do the Shuttle Pass as described in The Karate Coin, your right thumb covering the tear just

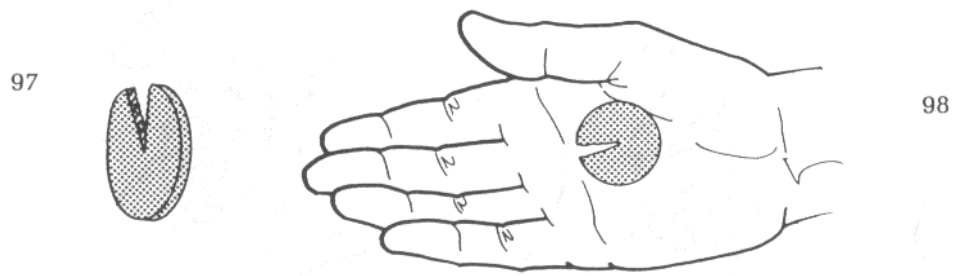

before you separate your hands. Immediately turn your right hand over, your first and second fingers covering the tear. Slide your first finger directly over the tear so you can move your second finger out of the way, curling it beside your third and pinky fingers (fig. 99).

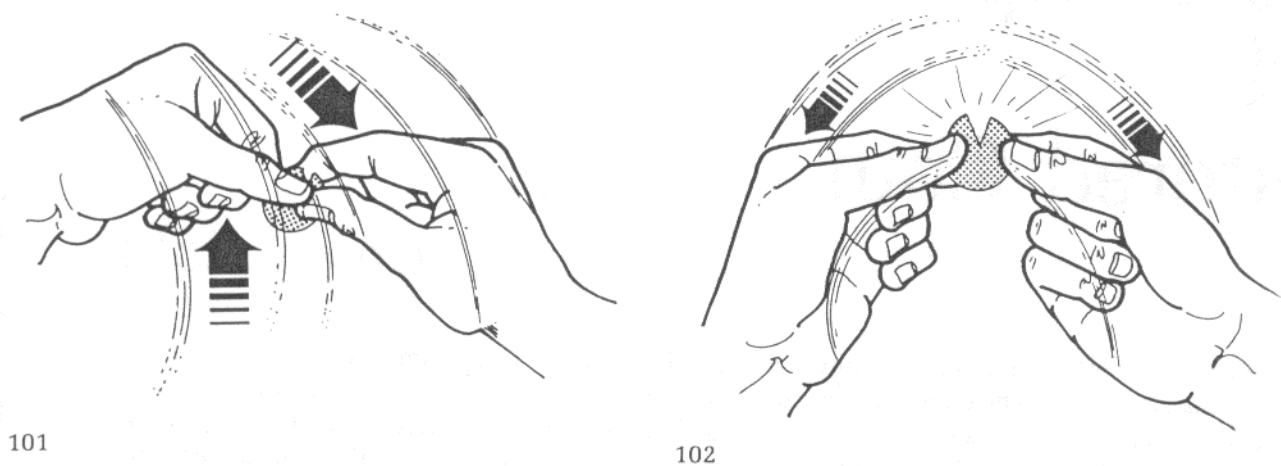
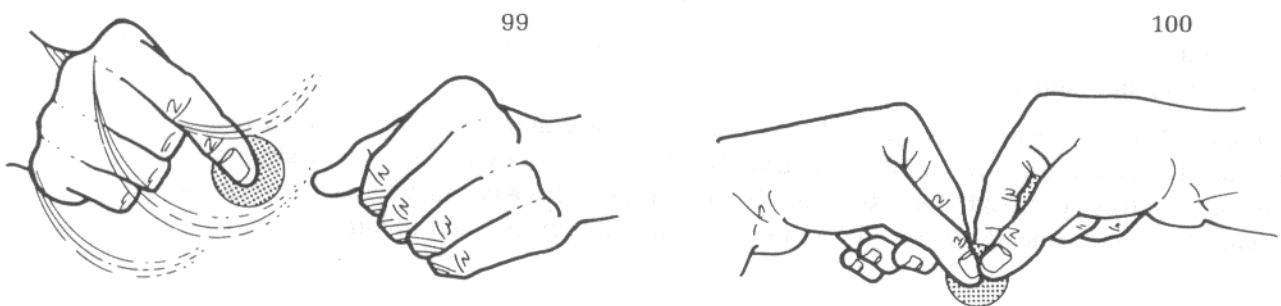

Your left thumb and first finger grasp the coin in the same way so that your first fingers are beside one another (fig. 100). Note which side of the tear is bent inward and mime bending that hand inward and the other outward (fig. 101). Use a lot of arm and shoulder strength to make it convincing, and then slide your fingers to the sides revealing the tear (fig. 102).

Take the coin with your right hand and display both sides - it can be examined. Take it back afterward and hold it in French Drop position in your right hand, the tear pointing to the left (fig. 103). Move your left fingers in front of the torn coin, allowing it to fall into right-hand finger palm. Your right fingers grasp the regular coin that's been in left-hand finger palm (fig. 104). Move your left hand slowly to the left, extending your first finger over the tear the audience believes to be in the coin (fig. 105). Rub your finger back and forth a few times and then slowly remove it, revealing the restored coin. Your right thumb and fingers squeeze the coin, snapping it to a vertical position. Your hand turns over to hand out the coin for examination.

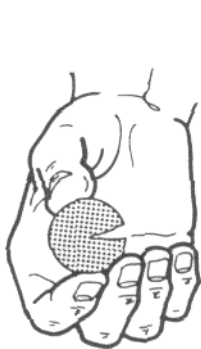

103

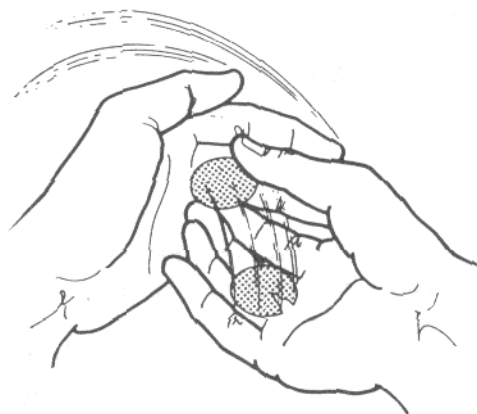

104

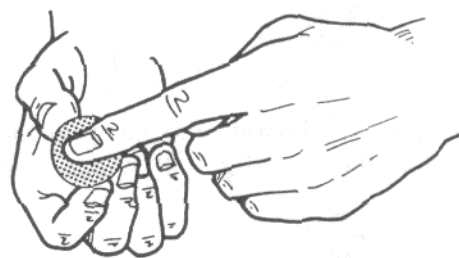

105

Oval Purse Holdout

David Roth

David has found a terrific use for those little plastic oval squeeze purses that are sold in all five and dime stores (fig. 106). Get one, it doesn't matter what the color is, and place as many coins into it as you'd like to

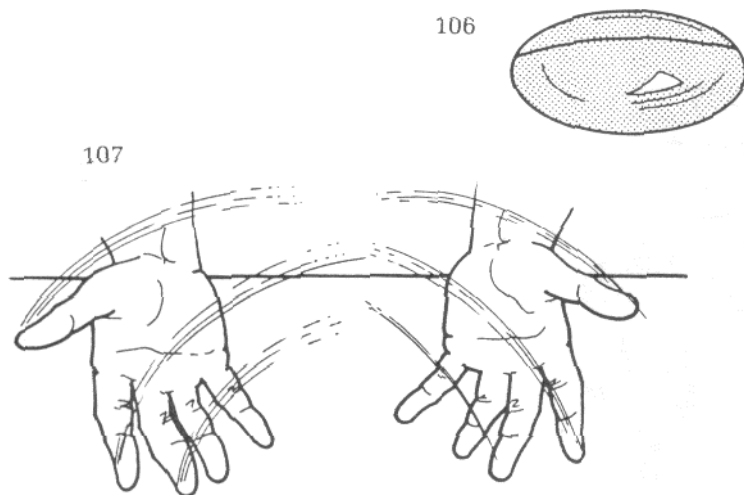

107

106

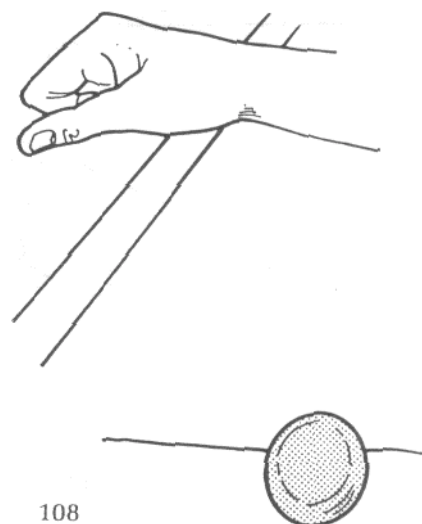

108

produce (you're limited only by the size of the purse - it must close after it's loaded). You must be seated at a table opposite the audience. Place the loaded purse on your right thigh, slit side down, ends to the right and left (fig. 107).

Start talking to the spectators at the same time doing a both hands palm-up gesture (fig. 108). Immediately sit back and relax, allowing your hands to drop into your lap. Your right hand grasps the

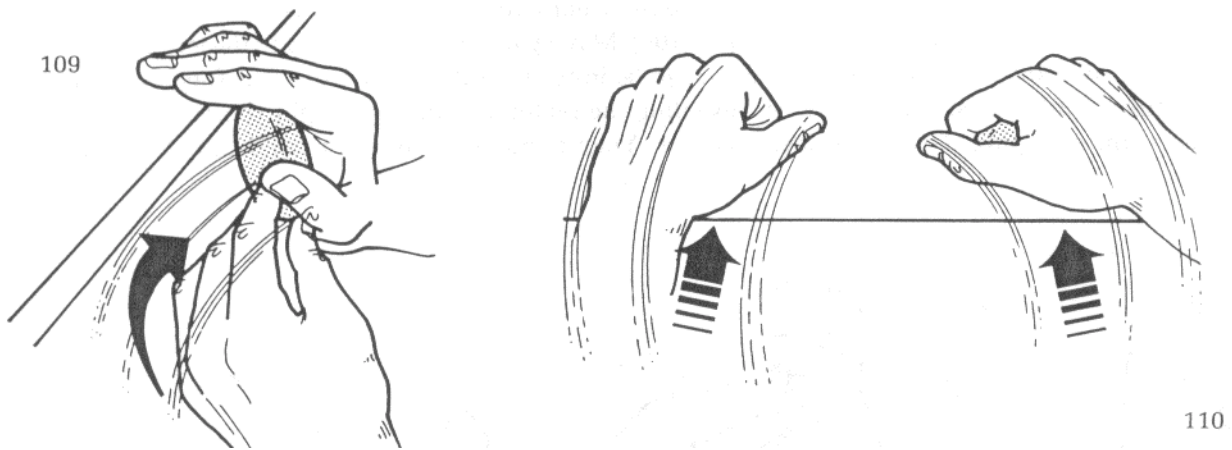

loaded purse in Tenkai palm, i.e., your thumb pressing against the left end, the right end pressed against the heel of the hand (fig. 109). Without pausing raise your hands onto the table in relaxed fists (fig. 110).

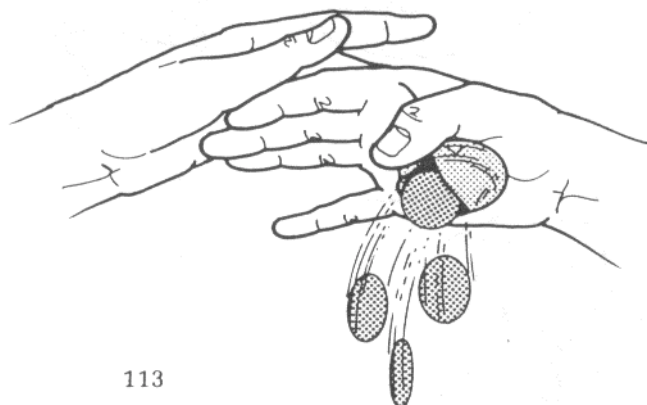
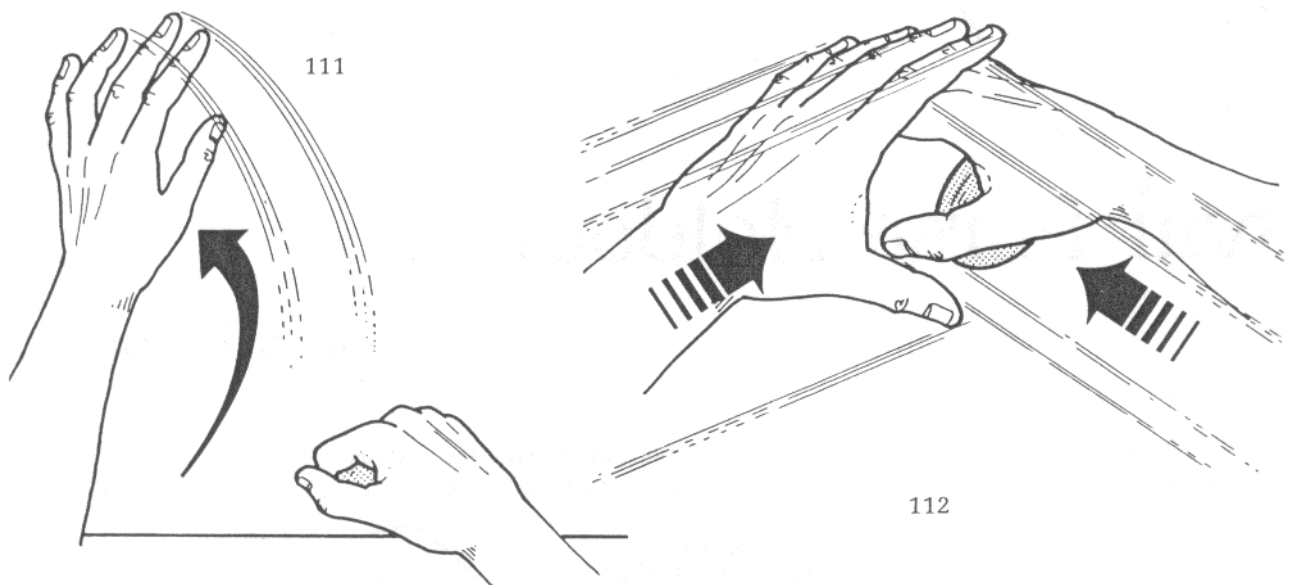

Make a few plucking motions in the air with your left hand, grabbing apparently invisible coins (fig. 111). Retract your left hand slightly and raise your right hand to meet it about a foot over the table,

fingers spread, your left fingers over your right fingers (fig. 112). Squeeze the purse open with your right thumb, allowing all the coins to fall onto the table (fig. 113). As soon as the coins hit, lower your hands to the table edge and lap the purse (fig. 114). Immediately raise your hands, turning them palm up.

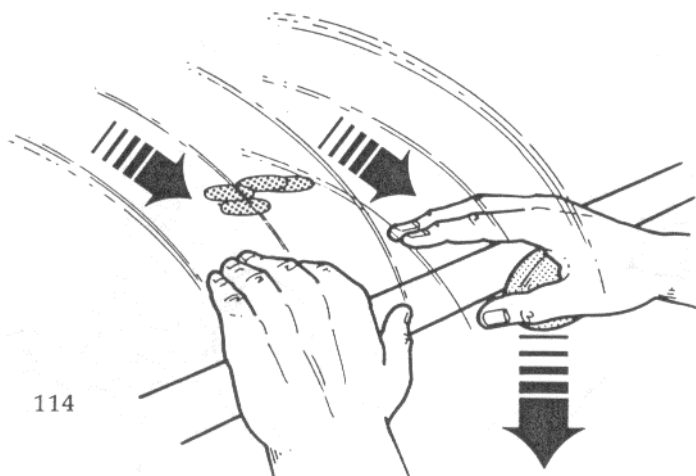

The Acentric Purse

David Roth

A seemingly impossible production of four coins from a purse frame (i.e., a purse without the bag). Your hands are shown empty throughout the routine using many of the Edge Grip techniques just taught, and the coins are produced a number of different ways, one of which is a new sleight called the Edge to Fingertip Drop Production. There are two handlings - choose the one you prefer.

115

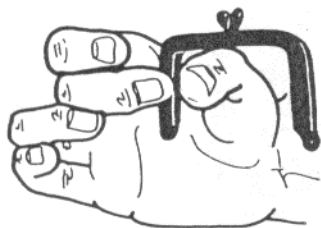

116

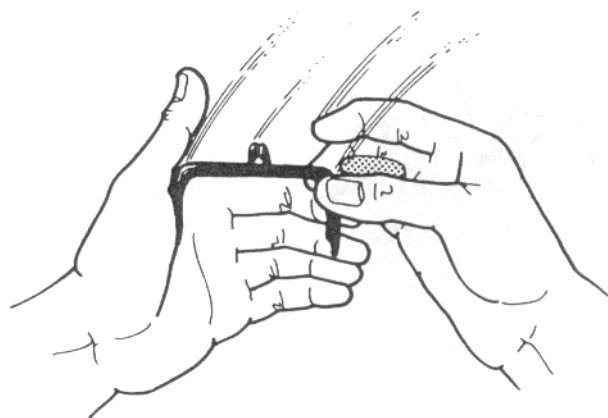

Sequence No. I

Four half dollars are in right-hand Curl Palm, and the hand rests on the table in a relaxed fist. Your left hand is in the same position (though it holds no coins) and a purse frame lies on the table. Your left hand picks up the purse frame while your right hand moves upward. Place the frame into Edge Grip Display, its right end held between your right thumb and second finger (fig. 115). Turn both hands palm toward you and place the purse frame in your left hand in production position, i.e., wedged between your thumb base and first and second fingertips (fig. 116).

Edge to Fingertip Drop Production

While the coins are in Edge Grip your right thumb and second finger snap open the purse (fig. 117). Tilt your left palm upward a tiny bit and lower your right thumb, first, and second fingers into the purse (fig. 118). Your third finger moves outside the purse and hugs your left first finger to cover the space between the purse frame and your first finger (fig. 119) is the audience view).

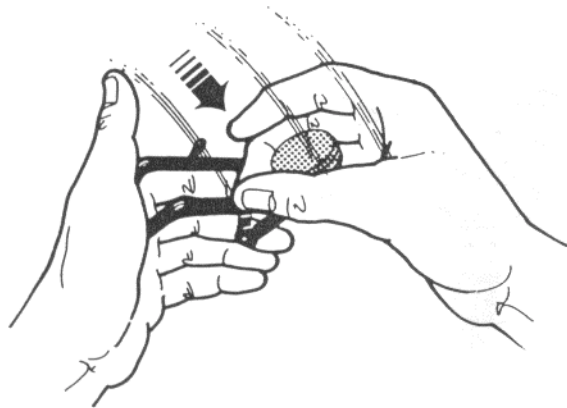

117

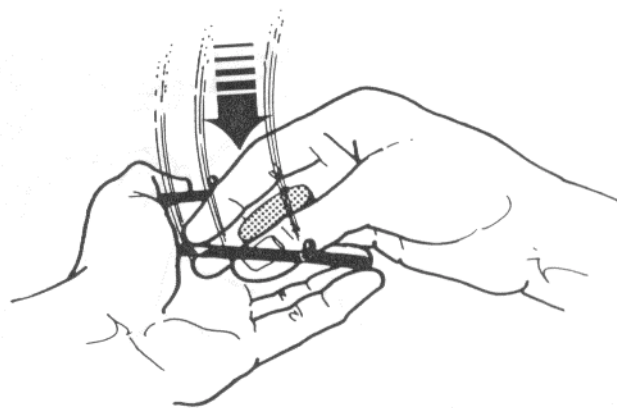

118

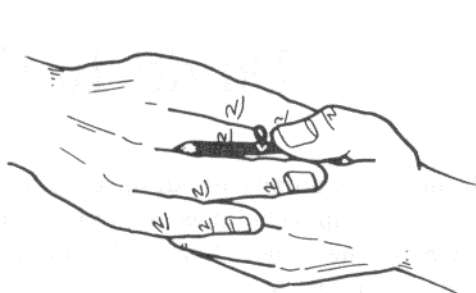

119

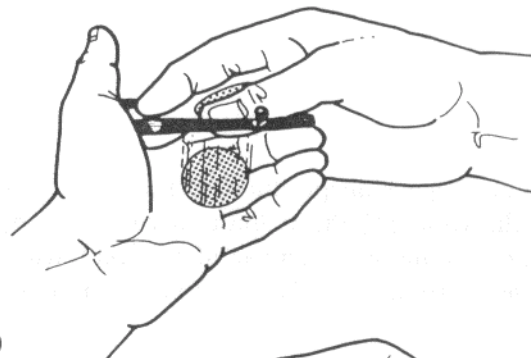

120

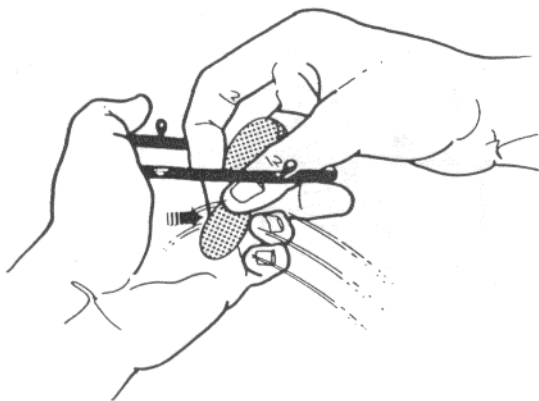

121

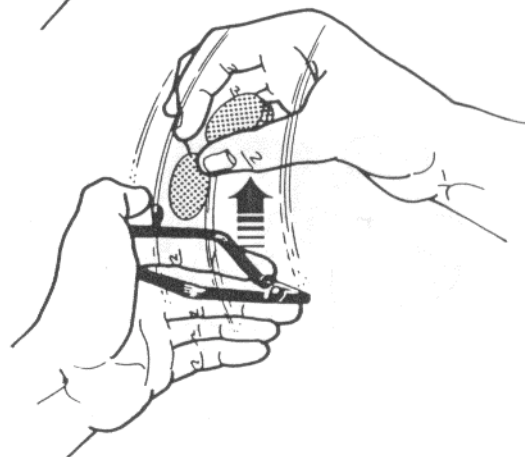

122

Relax your right thumb and second finger and allow the bottom coin to drop off the Edge Grippped stack and fall into left-hand finger palm (fig. 120). Your left third finger immediately curls, turning the coin and delivering its upper edge to between your right thumb and second finger (fig, 121). Raise your right hand, apparently pulling the coin out of the purse (fig. 122). Raise your right hand to Edge Grip Display while you extend your left hand toward the audience, tilting it forward so they can see inside the purse (fig. 122a).

Tilt your left palm back toward you and simultaneously table the visible coin with your right hand. Repeat the Edge to Fingertip Drop Production to produce the second coin. After you've pulled it out of the purse your left hand tables the frame and picks up the first coin. Both hands hold their coins in Edge Grip Display. Your right hand tables its coin while your left hand maneuvers its coin into finger palm. Do the Shuttle Pass Drop, apparently taking the coin with your right hand and dropping it onto the table on the coin already there. Afterward there'll be a coin concealed in left-hand finger palm and another in righthand Edge Grip.

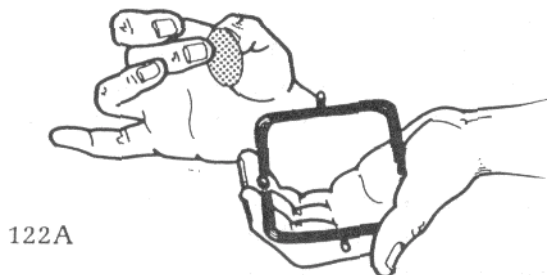

After your right hand does the Shuttle Pass Drop it moves back a bit and settles on the table in a fist, the Edge Grippled coin falling to fingertip rest. Move your right toward the purse frame and, on the way, classic palm the coin. Pick up the frame and place it in production position in your left hand, wedged between thumb base and fingertips. Your right thumb and first finger snap open the purse and very cleanly reach inside. Grasp the upper edge of the coin that's finger palmed and pull it out of the purse.

Extend your right hand and place the coin on the table with the two already there. As you retract your right hand extend your left hand to show the interior of the frame empty. Your right hand settles to the table in a relaxed fist and transfers the coin to fingertip rest. Retract your left hand, tilting it palm toward you. Raise your right hand and insert your thumb and fingers into the purse (fig. 123). Your thumb pushes the hidden coin to your fingertips while your other fingers curl out of the way (fig. 124). That takes a second, and your right hand immediately moves upward pulling the coin out of the purse. Place it on the table with the others.

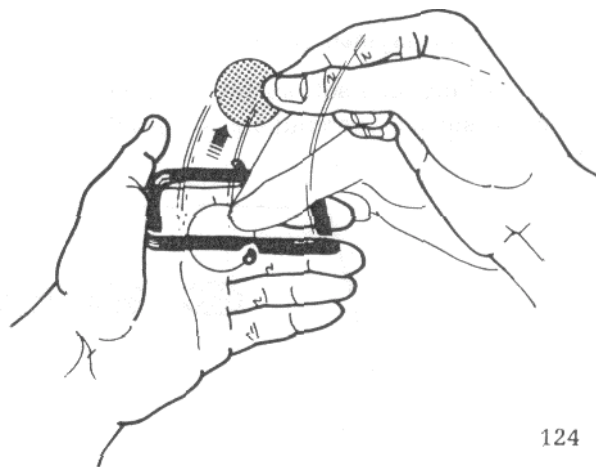
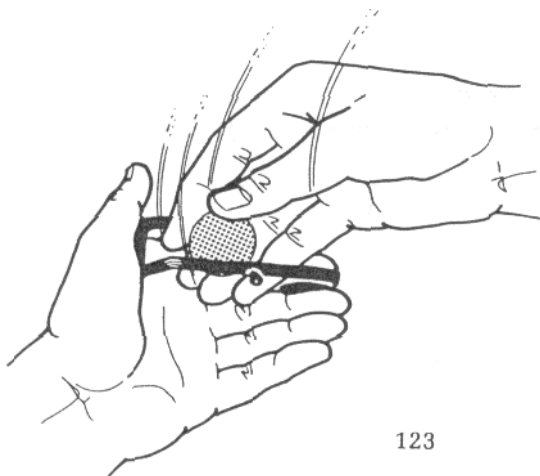

Sequence No. 2

This starts exactly the same way as the first sequence, with a production of a coin from the purse using Edge to Fingertip Drop Production. After your right hand has pulled the coin from the purse your left hand tables the purse and presses it closed. Your left hand turns palm up and your right hand drops the coin onto it in finger palm. Do the Shuttle Pass Drop, apparently taking the coin with your right hand and dropping it on the table. Afterward both hands settle to relaxed fists. One coin is finger palmed in your left

hand, two Curl Palmed in your right, and one on the table.

Your right thumb and first finger lift the purse frame and place it into production position in your left hand. Snap open the purse, reach inside with your thumb and first finger, and take out the finger palmed coin. Place it on the table. Your left hand tables the purse frame and your right hand transfers its coins to Edge Grip. Each hand lifts one of the visible coins and holds it in Edge Grip Display as you patter. Drop both back on the table afterward.

Your right hand picks up the frame and places it in production position in your left hand. Produce the third coin using Edge to Fingertip Drop Production. After you've pulled it out your left hand tables the purse, closing it. Drop the justproduced coin onto your palm-up left hand in finger palm and do a Shuttle Pass from Edge Grip, apparently taking the coin with your right hand, tapping the purse frame with it as you patter ("Three coins from a bagless purse"), and dropping it onto the table beside the two already there.

Your right hand lifts the purse frame and places it into production position in your left hand. Snap it open and do the Johnny Paul subtlety (described later in Scott Weiser's routine, Framed) to apparently show your hands empty. Then, insert your right thumb and first finger into the purse and cleanly produce the last coin.

In Addition: If you wanted to routine this with, say, Wild Coin No. 2, you could magically produce a bag on the purse Using some sort of switch, and then go into that routine.

High Flying Winged Silver

David Roth

This is David's all new handling of Coins Across using Edge Grip. You'll be amazed at how impossibly clean it appears to both laymen and other magicians.

You must be working on a soft surface - though you can be either standing or sitting since there's no lapping. (If the soft surface prerequisite is a problem you can substitute another technique for The Scoop Addunder.)

125

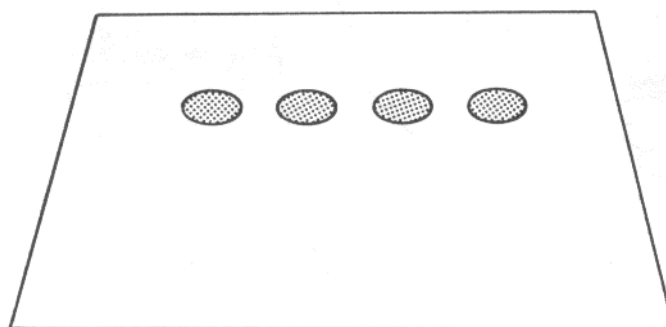

To begin, have a coin classic palmed in your right hand and four matching coins on the table in a horizontal row about an inch apart (fig. 125). Your left hand picks up the coin on the left end of the row and holds it, palm up, in finger palm. Do a Shuttle Pass, your right hand ostensibly taking the coin. It turns palm down with the switched-in coin held at the fingertips and moves toward the right end of the row.

Both hands now work simultaneously gathering the coins. Your right hand places its coin onto the one at the right end of the row and lifts both of those. Your left hand lifts the coin at the left end of the row. Your right hand places its two coins on the coin (originally third from the right) remaining on the table and lifts all three. Your left hand drops its coin onto your palm-up right hand so it coalesces with the three already there.

Close your right hand turning it palm down and classic palming one of the coins as already described (see Classic Palming One Coin of a Group) as you make a fist. Your left hand also curls into a fist and turns palm down. Make your magic gesture and open both hands over the table - three coins drop from your right hand and one from your left (fig. 126). Your hands are almost touching the table when you open them. Immediately raise them straight up, move them back a bit (toward you), and let them settle onto the table in relaxed fists (fig. 127).

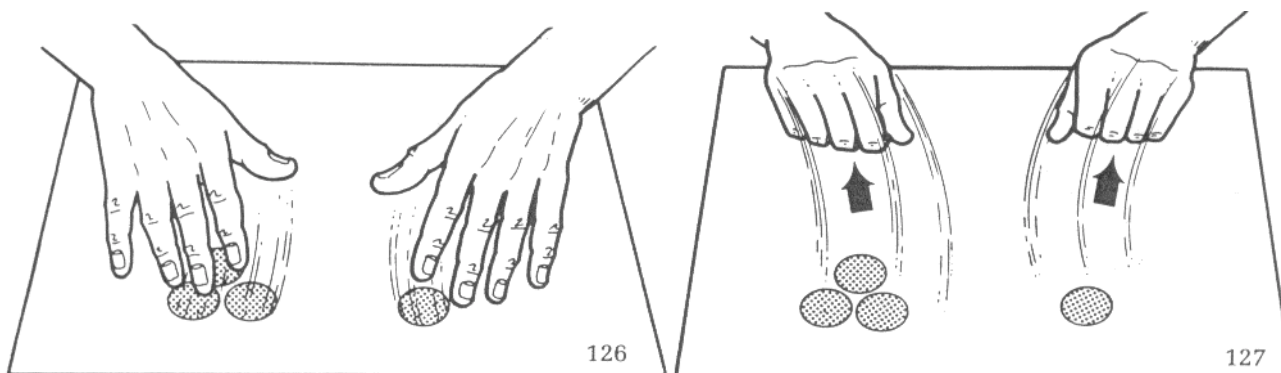

Your left hand picks up the coin on the left and holds it in palm-up finger palm. Do a Shuttle Pass, your right hand apparently taking the coin and immediately moving to tap the three coins on the table with it. As your right hand moves downward to tap your left hand settles back to relaxed fist position on the table. Say, "It used to be over here but it jumped into my left hand."

Turn your left hand palm up keeping your fingers partially curled so the coin concealed in finger palm isn't exposed. Your right hand tosses the coin it holds onto your left palm - it won't hit the finger palmed coin if you're careful (fig. 128). Close your left hand and turn it palm down.

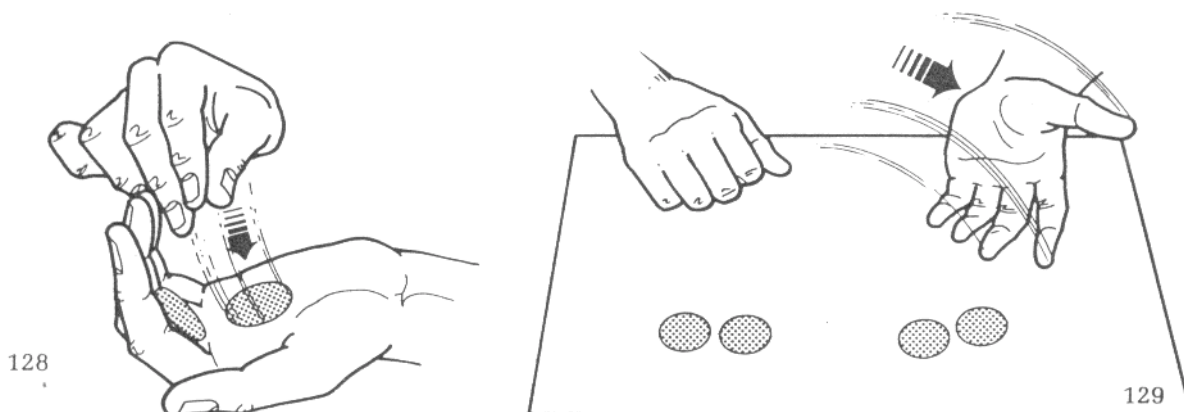

Your right hand picks up the three tabled coins and classic palms one of them as it makes a palm-down fist. Make your magic gesture (wiggle your thumbs, or whatever) and open your fists low over the table. Let the coins, two beneath each hand, spread before you lift your hands to reveal that the second coin has jumped. Remember to lift your hands straight up, move them toward you, and then let them settle in relaxed fists on the table behind the coins. Gesture with your palm-up left hand as you say, "The second coin has jumped across" (fig. 129).

Both hands simultaneously pick up the innermost coin of each pair and place it on the other coin - so there's a stack of two in front of each hand. Start moving your right hand across the table toward the coins in front of your left hand. As it moves allow the classic palmed coin to drop to fingertip rest. Do The Scoop Addunder as your right hand lifts the two coins in front of your left hand, secretly adding its coin to the bottom of the stack.

Getting Into Edge Grip: Method One

A stack of three coins now rests on your curled right fingers. Curl them enough so that you can lift your thumb without dropping the coins, and move your thumb onto the inner edge of the stack. Straighten your fingers (fig. 130). The stack is now gripped solely by your thumb and second finger, with the outer edge of the stack (directly opposite your thumb) exactly between the second and third joints of your second finger. (All of this is shown in the preceding illustration.)

130

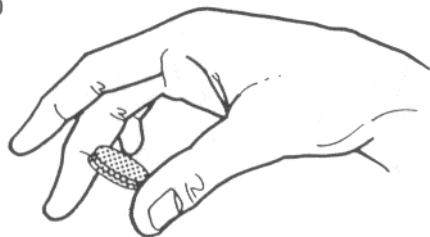

131

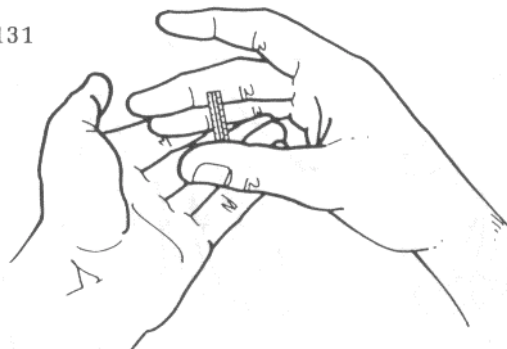

132

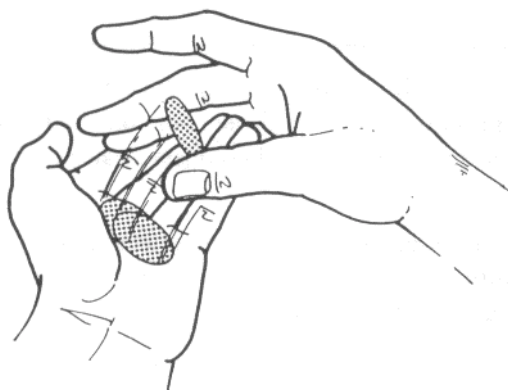

133

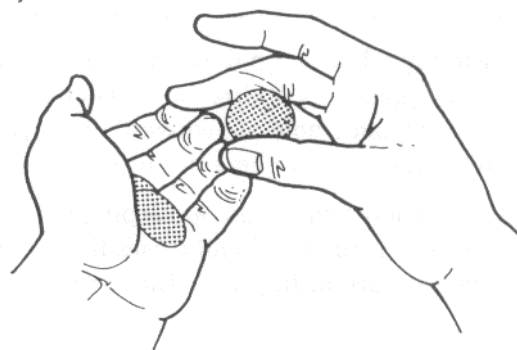

Turn your left hand palm up and hold it beneath your right hand. Your left fingers are slightly curled and almost touch the outer side of your right third finger (fig. 131). Relax your thumb and second finger and allow the bottom two coins of the stack to drop into your left hand - one coin remains between your right thumb and second finger (fig. 132). Curl your left fingers until they touch the edge of the coin still in your right hand. Continue to close them - they pivot the coin to a horizontal position (a.k.a. Edge Grip) (fig. 133). Don't close your left fingers completely - just enough to do the move (which isn't really very much) and separate your hands. The spectators should still be able to see two coins in your left hand.

Obviously I've broken this new method of getting into Edge Grip down into small steps to teach. In David's hands it takes a second. You just drop the coins into your left hand and close your fingers a bit. It's quick and precise.

Your left fingers open and your left thumb pushes the coins to your fingertips. Your left hand places one vertically between your right thumb and second finger in Edge Grip Display position, and holds the other in a similar fashion as you cleanly display two coins. Your left hand places its coin between your right thumb and second finger, with the one already there, but spread slightly. Your right hand holds both over your palm-up left hand and does the Edge Grip Load already described, dropping those two and secretly adding the third coin as they fall into your left hand.

Your right hand picks up the two coins on the table and holds them in Edge Grip Display for a moment (even though there are no coins in Edge Grip to conceal). Let the coins drop into your right hand and make a fist, classic palming one of them. Turn both fists palm down over the table, make your magic gesture, and open both hands. One coin will drop from your right hand, three from your left hand. Your hands move straight up, then toward you, finally settling back onto the table in relaxed fists behind the coins (fig. 134).

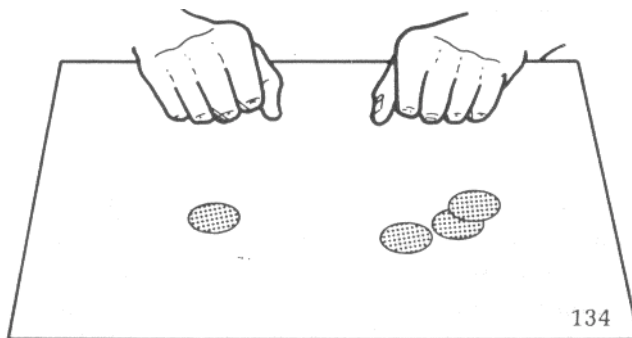

Your left hand picks up one of the three coins in front of it and holds it in palm-up finger palm. Do a Shuttle Pass, your right hand apparently taking the coin. Your right hand crosses over in front of your left hand and picks up one of the two coins in front of it - it now holds two. Your left hand picks up the coin remaining in front of it and places it with the two coins already in your right hand. All three coins are held slightly spread in a fan between your thumb, first, and second fingers.

Turn your right hand palm down, allowing the coins to coalesce in a stack and catching them on the insides of your fingers. Curl your fingers, move your thumb onto the stack's inner edge, and straighten your fingers so the stack is held solely by your thumb and second finger in position for the method just taught of getting into Edge Grip.

Turn your left hand palm up and hold it directly beneath your right hand (obviously the finger palmed coin is shielded from the audience by your curled left fingers) (fig. 135). Now, do Method One as taught, your right thumb and second finger relaxing just enough to release the two bottom coins of the stack they fall onto the finger palmed coin with a clink. Your left fingers curl slightly, your fingertips hitting the coin remaining in your right hand and pivoting it to Edge Grip.

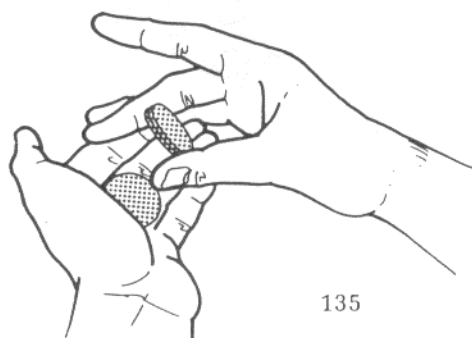

Transfer the three coins from your left hand to Edge Grip Display in your right hand, held between thumb and second finger. Cleanly display the three coins and then drop them into your left hand, doing Edge Grip Load and secretly adding the fourth coin that was in Edge Grip. Your left hand immediately closes into a fist and turns palm down. Your right hand picks up the coin remaining on the table and classic palms it as it closes into a fist.

Both hands are held palm down over the table. Open them - four coins fall from your left hand and none from your right. Wiggle your fingers as you raise your hands, subtly giving the impression that your hands are empty. Move them toward you and let them settle onto the table in relaxed fists. End of routine - you can go south with the extra coin whenever you like.

Hanging Coins Plus

David Roth

I originally described a version of this routine in *Apocalypse Vol. 1 No. 6*. David has also used it in his lecture for several years. This version has many details never released before on timing, patter, and an entirely new center sequence after the first two coins have vanished. Also, this leads directly into the Flash Production which uses many of the new Edge Grip techniques already taught to reproduce the coins one at a time. The alternate original ending, which David used because he didn't want to release the Flash Production, will also be briefly described.

You may be either standing or seated - it depends upon the performing situation. Your left hand grasps four half dollars between thumb and first finger (fig. 136). Note that the coins are spread downward (the hand is palm up), the innermost coin being the lowermost. The pad of your thumb rests across a small portion of all the coins, making the grip as secure as possible. Your left second, third, and pinky fingers are loosely curled beneath the coins and out of the way.

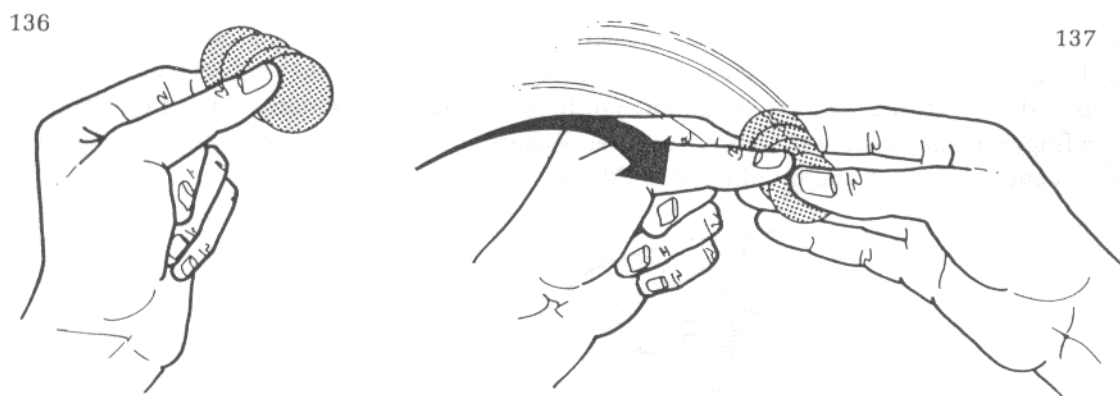

The Feint

You'll have the option (which David usually takes) of doing this bit of business three times during the routine. Learn it now so you don't have to keep flipping back. Hold your hands comfortably in front of you at about waist level. (If you're performing while seated at a table simply let your hands hover just above the table.) Say that you're going to make the coins invisible one at a time and hang them in the air. Turn your right hand palm toward you and move your hands together. Your right fingers move outside the coins, your right thumb moves onto the inner side of the innermost coin (fig. 137). Note that your left thumb is pointing toward the right. Say, "Watch," as you simultaneously raise both hands; your right hand curves upward and to the right, your left hand upward and to the left. Your right thumb retains the innermost coin flatly against the insides of your right fingers (fig. 138).

Your hands have moved upward only about six or eight inches, and are just below your chest. Your right thumb pushes the coin inside your hand up to your fingertips as you say, "It hasn't gone yet" (fig. 139). Put the coin back where it was, with the others in your left hand.

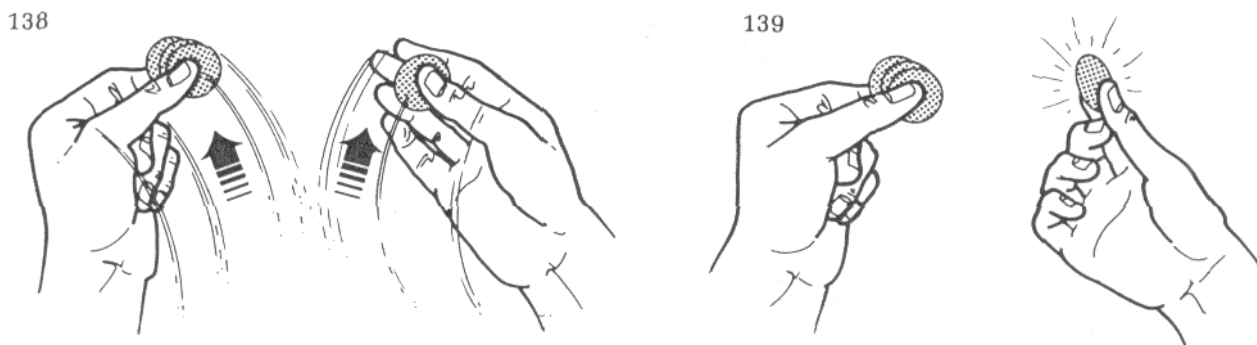

Getting Into Edge Grip: Method Two

Pause, gesture toward the audience with your palm-up right hand, at the same time casually letting your left hand drop to waist level, the coins tilted to a horizontal position (parallel with the table or floor) (fig. 140). Patter briefly. Move your right hand down to your left hand, guiding the same coin that you've just used for the Feint into Edge Grip between your right thumb and second finger (fig. 141). Continue to look at the audience and patter during this.

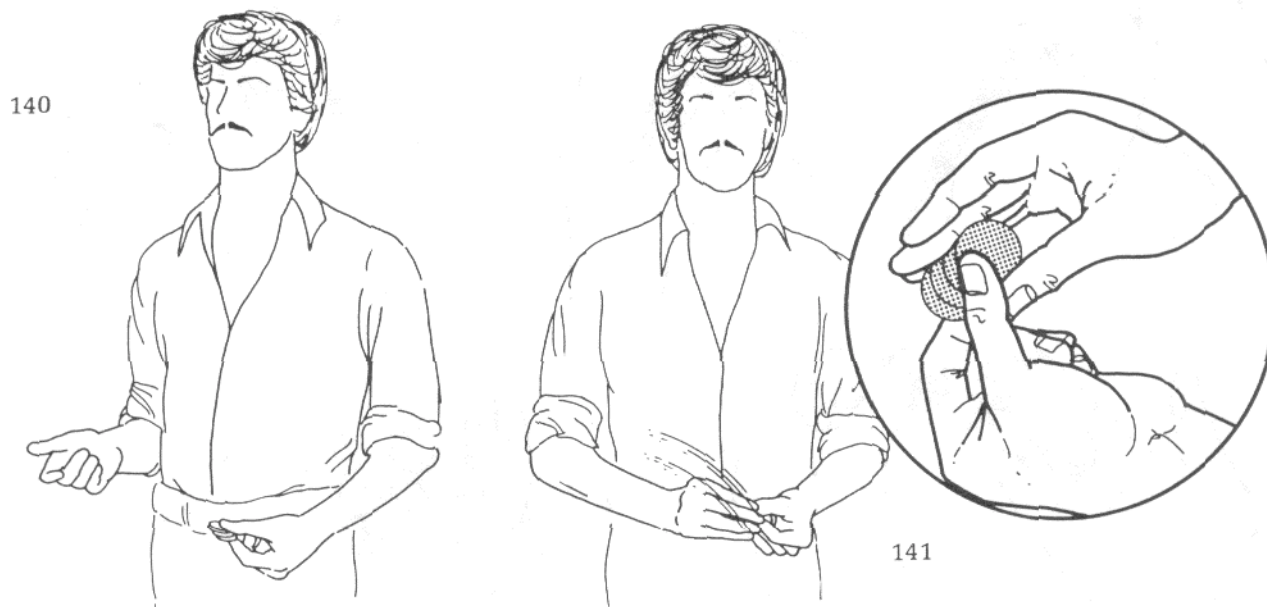

Raise both hands as in the Feint - your right hand curves upward to the right, your left hand upward to the left. Your right hand moves with fingers held together and straight, as if a coin was held flatly behind them as you did in the Feint. Now, of course, the coin is in Edge Grip (fig. 142).

Move your hands together, opening your left second, third, and pinky fingers. Move your right fingers over your left palm (your right pinky actually resting on it for a moment) and curl your left fingers around them (fig. 143). Pretend to drop the coin onto your left hand, immediately curling and spreading your right fingers as you move your right hand a bit to the right. Your left second, third, and pinky fingers close over the coin supposedly placed there (fig. 144).

Immediately rotate your left hand at the wrist, placing the three-coin fan into Edge Grip Display between your right thumb and second finger (fig. 145). Your right hand takes the coins and turns palm toward audience. Crumple your left fingers, opening them, and pretend to "hang" the now invisible coin in the air in front of you.



Show your left hand to be empty both front and back. Lower both hands slightly. Your left hand, held palm toward you, takes the uppermost (outermost) coin of the three and holds it in palm-up finger palm as you count, "One" (fig. 146). As you say, "Two," your right hand drops the other two visible coins just inward of, but overlapping, the coin already in your left hand (fig. 147). On "Three" do a Utility Switch. Briefly: Your left hand turns palm down over your right hand, which turns palm up. Two coins drop from your left hand into your right hand, coalescing with the coin which has been released from Edge Grip, while your left hand retains one coin in finger palm (fig. 148).

Your right hand maneuvers the coins into a stack and places them back between your left thumb and first finger in spread (fanned) position. Repeat the Feint, really taking a coin flatly inside your right fingers. Push it upward revealing that it's still there and then replace it in the left-hand fan.

Now, really do the sequence, taking a coin into Edge Grip in your right hand. Simultaneously raise both hands, pretend to place the coin into your left hand, and place the other two coins remaining between your left thumb and first finger into Edge Grip Display in your right hand. Your right hand turns palm toward audience displaying two coins.

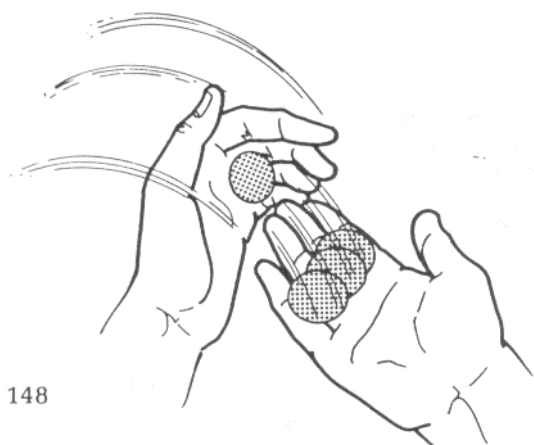

148

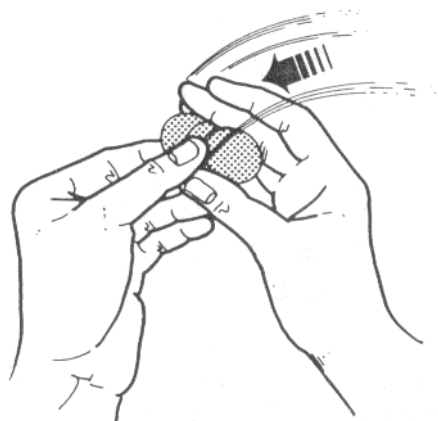

149

Hold your left fist palm up and open it, revealing that the coin is still there. Place that coin with the two in your right hand, and then transfer the whole fan back to your left hand between thumb and first finger.

Lower your left hand to waist level, tilting the coins parallel to the floor, and say, "This time it'll really go." Move your right hand over the fan, taking the uppermost coin into Edge Grip beneath the coin already there (fig. 149). Continue with the sequence as you did to vanish the first coin, raising and separating your hands (keeping your right fingers together and straight), pretending to place the coin into your left hand, your left hand placing the two visible coins into Edge Grip Display in your right hand, etc. Turn your right palm toward the audience to display the two coins while your left hand pretends to hang the second coin in the air.

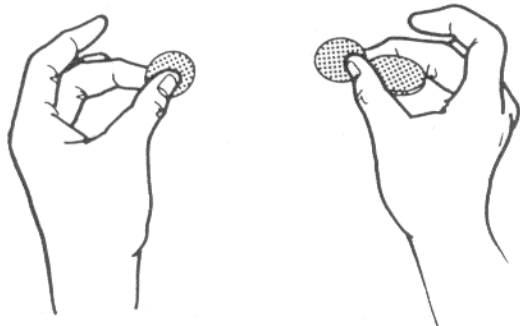

150

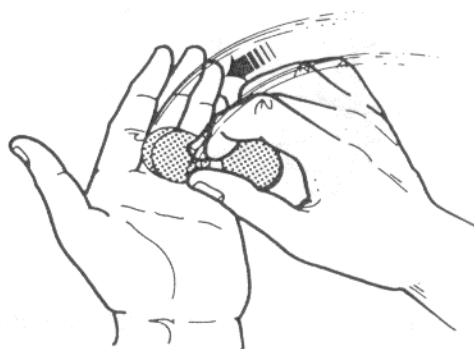

151

Once you've shown that your left hand is empty, take one of the visible coins from your right hand and display it between your left thumb and second finger (fig. 150). Maneuver the left-hand coin onto your palm-up hand in finger palm and drop the right-hand coin onto it (fig. 151).

Do the Shuttle Pass From Edge Grip exactly as taught in the Sleights and Finesse section - here exchanging two coins for two. Your left hand turns palm down retaining both coins in finger palm, and your right hand turns palm up displaying its coins between thumb, first, and second fingers.

Place the two coins between your left thumb and first finger in spread position. Do the Feint, taking one with your right hand, then showing that it's still there, and finally replacing it. Both coins are again held between your left thumb and first finger.

152



153

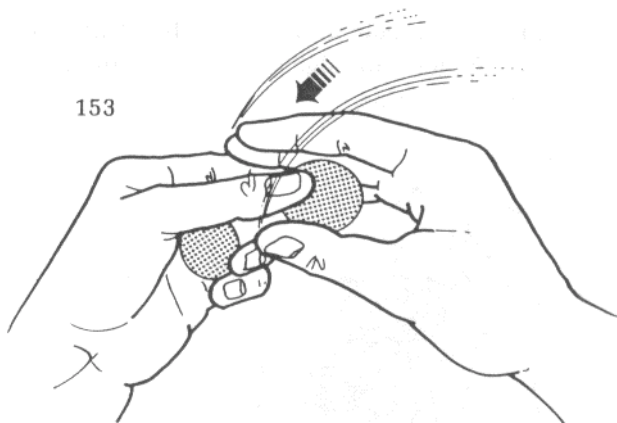

Take one coin between the thumb and first finger of each hand and say, "I could make the last two go one at a time. . ." Put the right-hand coin between your left thumb and first finger (exactly onto the other coin) and continue, " .. or I could make them go together." As you say that lower your left hand slightly, tilting the coins so that they're parallel with the floor (they're about to go into Edge Grip) (fig. 152). Move your right hand over them, taking both into Edge Grip (fig. 153). Your right thumb, first, and second fingers immediately grasp the upper edge of the two finger palmed coins (fig. 154). Pull them upward, out of your left hand, and spread them as you say, "But I'll do it one at a time" (fig. 155). Note that your left hand is displayed empty during a gesture as you talk.

154

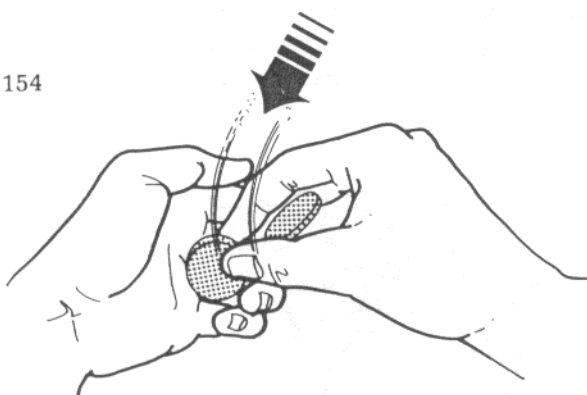

155

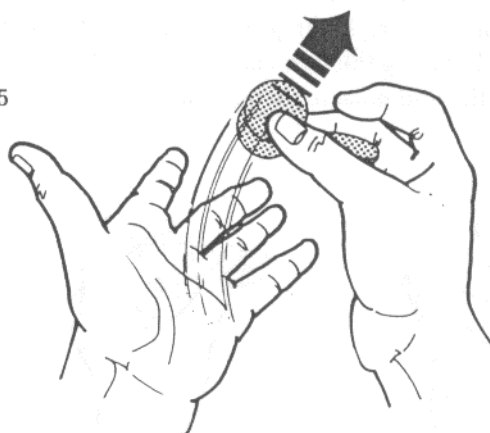

Place both coins back between your left thumb and first finger. Lower your left hand to waist level, tilting the coins, and immediately lower your right hand, taking the uppermost coin into Edge Grip beneath the two already concealed there. Raise your hands, your right fingers together and straight, and pretend to place the coin in your left hand, which places the last visible coin between your right thumb and second finger. Your right hand turns palm toward audience to display one coin. Your left hand hangs the third invisible coin in the air.

At this point you've got three coins in Edge Grip and one coin in Edge Grip Display. This is where you'll start the Flash Production to reproduce the coins. If you're already familiar with the original ending then turn directly to Flash Production. If you don't know how David used to end the routine, read on.

Say, "You may not believe that these three coins are hanging here in the air. Watch." Swing your right hand in a large sweeping motion from right to left, letting the visible coin drop inside it with a clink as it hits the coins already there - your right hand makes a fist (fig. 156). Lower your hand and open it revealing all four coins.

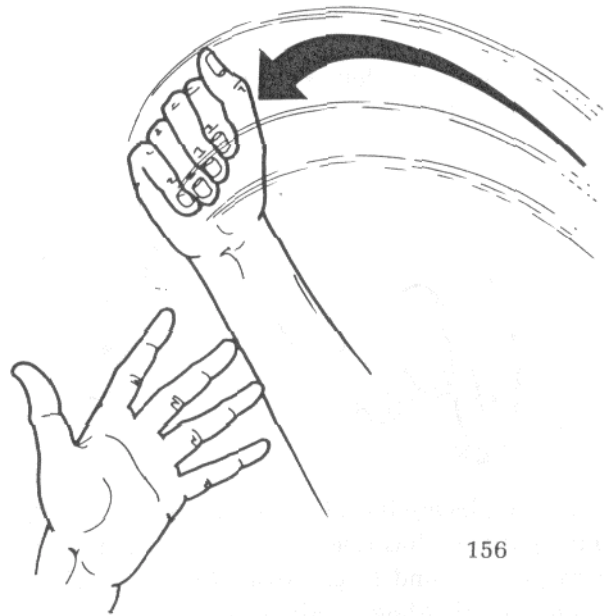

Flash Production

David Roth

This is a method for producing coins, one at a time, from the fingertips of your apparently empty hands, David's held this back for years - it's how he ends the Hanging Coins for the inner circle crowd.

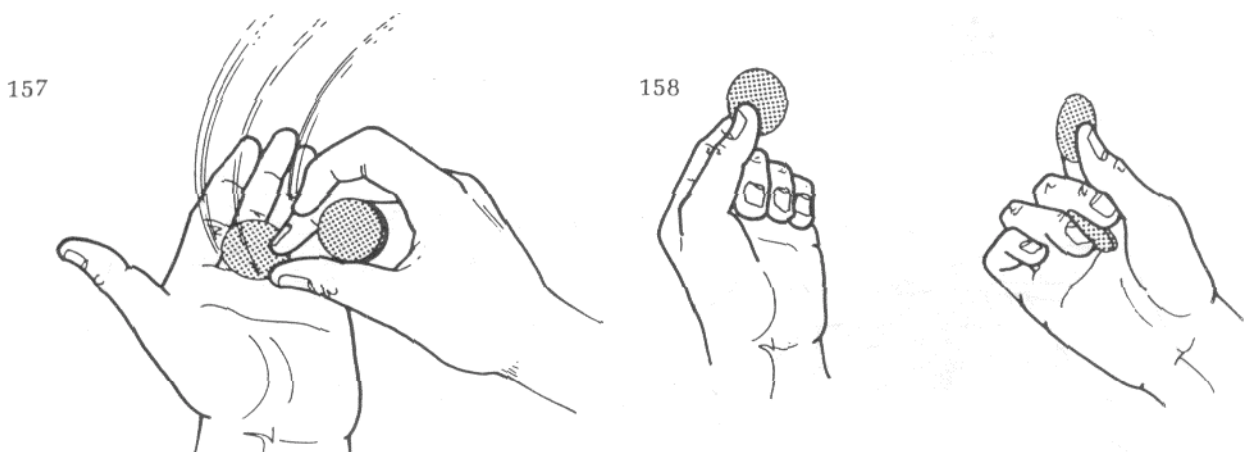

Let's assume that you've just done the Hanging Coins and have three coins Edge Gripped in your right hand with one coin (still visible) in Edge Grip Display. Show your right hand to be completely empty except for that coin and then move your hands together, your right hand dropping the visible coin onto your palm-up left hand in finger palm (fig. 157).

Do the Shuttle Pass Drop as already taught, apparently dumping the coin into your right hand - your left hand actually retaining it in finger palm. Your right hand immediately moves forward over the table and drops one of the Edge Grippeds coins onto it. Raise your right hand and transfer the two coins from Edge Grip to Curl Palm as it settles back to the table in a relaxed fist. Pause for only a second and extend your right thumb and first finger to lift the coin just Shuttle-Pass dropped. After you've picked it up turn your right hand palm up.

Your left hand, also palm up, reaches to the left. Your left thumb pushes the finger palmed coin to your fingertips, magically producing it (fig. 158).

159

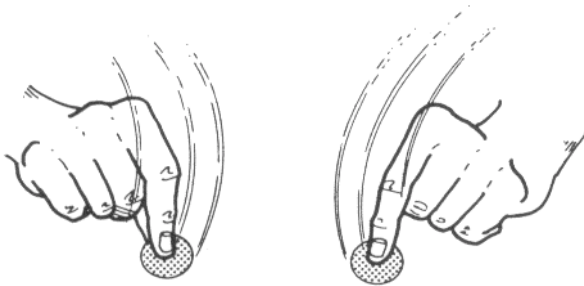

160

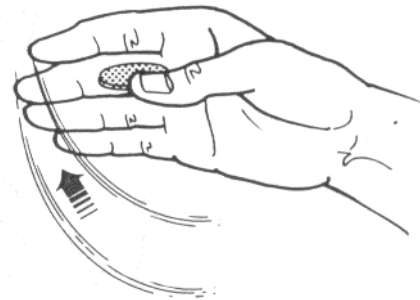

Turn both hands palm down, each placing its coin onto the table (fig. 159). Now, a few things happen at the same time. As soon as your right hand has released its coin your thumb moves onto the inner edge of the two coins in Curl Palm as your second finger straightens, transferring them back to Edge Grip. Without pausing, raise your right hand holding it palm toward you (fig. 160). I've broken it down here to teach, but at the same time your left hand also moves upward and slightly toward you, turning palm up and moving its fingertips directly beneath the Edge Grippeds coins (fig. 161).

161

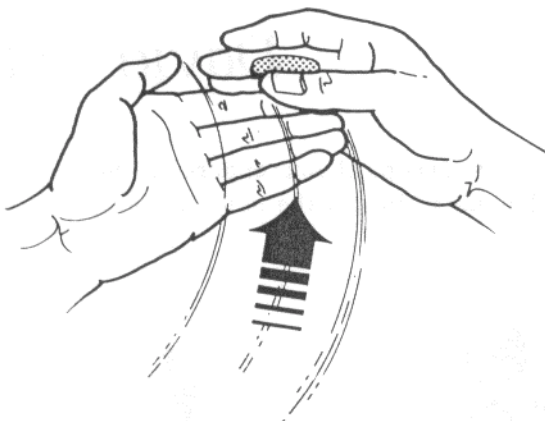

162

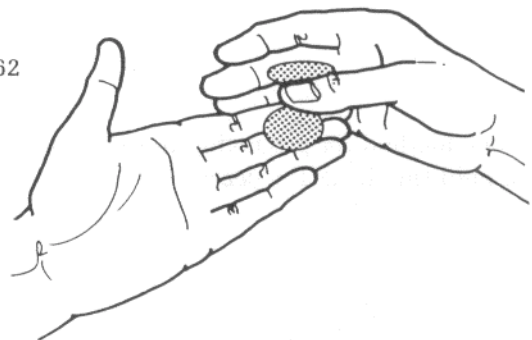

163

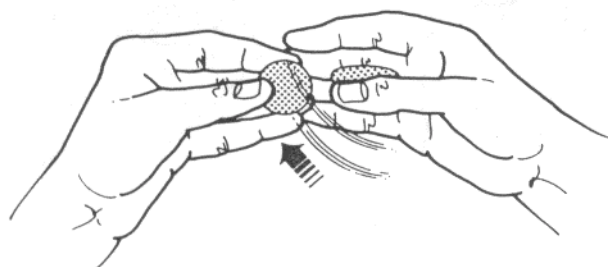

164

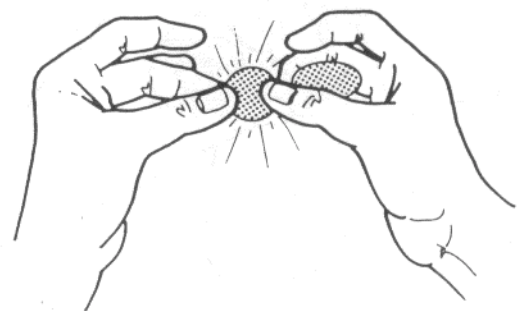

Continue rapidly, your right thumb and second finger relaxing and dropping the lowermost of the two coins from Edge Grip onto your extended left fingers (fig. 162). Immediately move your left thumb onto the left edge of the just-dropped coin and start turning your left palm toward you (fig. 163).

Your left thumb pushes the coin to the right, past your left fingertips. Your right thumb and second finger grasp it as your left fingers curl to reveal it to the audience (fig. 164). Your left fingers release the coin and your left hand turns palm up. Your right thumb and second finger display the coin, still concealing another in Edge Grip.

Drop the visible coin onto your palm-up left hand in finger palm and immediately do a Shuttle Pass From Edge Grip as described, your hands moving together, your right hand turning palm up and your left hand turning palm down, apparently dumping the coin into your right hand. Your right thumb pushes the coin to your fingertips afterward as your hand turns palm up.

Turn your left hand palm up and produce the fourth coin by thumb-pushing it to your fingertips as before. Both hands turn palm down and drop their coins onto the table to end.

Standup Copper/Silver Classic

David Roth

If there's one commercial routine that you get out of this book, a routine to perform for both magicians and laymen anytime, anywhere, it should be this one. You start clean, end clean, and the visual illusion is perfect. It uses anywhere from three to six Palm Changes in quick succession - so it'll take some practice. But it's worth it.

To begin, you have a copper/silver coin classic palmed in your right hand, silver side against palm. (I'm describing this position as if you're going to use the Palm Change which is described elsewhere in the book. If you want to use the Kaps Palm Change, or any other for that matter, where the coin does riot turn over - but drops directly to the fingertips - start with the copper/silver coin palmed copper side against palm.)

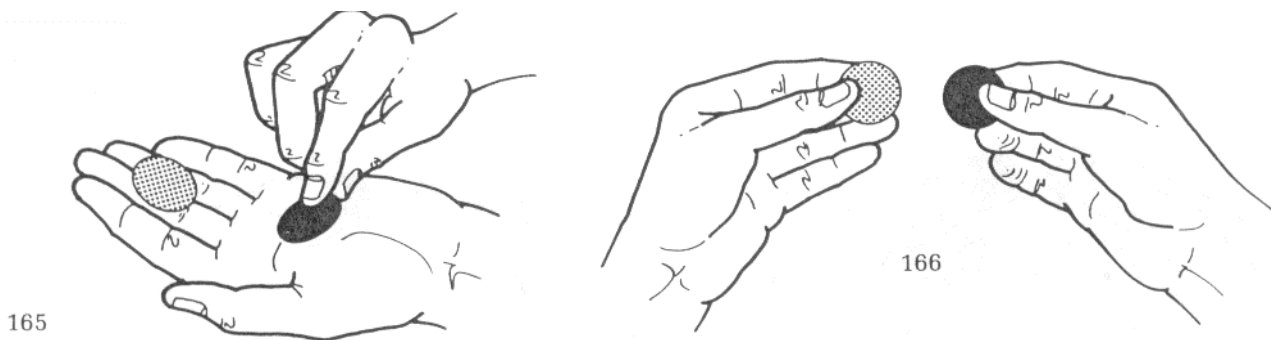

Your palm-up left hand holds two coins: a copper on your palm and a silver on your fingertips. Your right thumb and first finger turn these over a few times to display both sides (fig. 165). Take the copper coin with your right hand, leaving the silver on your left fingertips. Turn both hands over making fists. Your right hand does the Palm Change, switching the regular copper for the copper/silver coin. As you close your fingers ask the spectator which coin is in which hand. No matter what his reply is, turn both hands partially palm up (actually your left palm faces the right and your right palm faces left) displaying the coins on your fingers, your thumbs resting on them (fig. 166). Everything appears exactly as it should. The right hand concealment is a Fred Kaps subtlety.

Say, "The easiest way to make these coins change places is to do it myself - like this." Openly switch the coins, sliding one beneath the other (fig. 167). Your left hand takes the copper coin and your right hand takes the silver. Continue, "But that wasn't real magic. I can do it without moving." Now, a couple of things happen at the same time. Both hands close into fists and turn palm down. Your left thumb drags the copper coin toward the palm so that it just rests on the finger base (fig. 168). That happens as it has already started turning over, your fingers curling into a fist immediately afterward. That automatically flips the copper/silver coin over so that the silver side will show when you open your fingers in a moment.

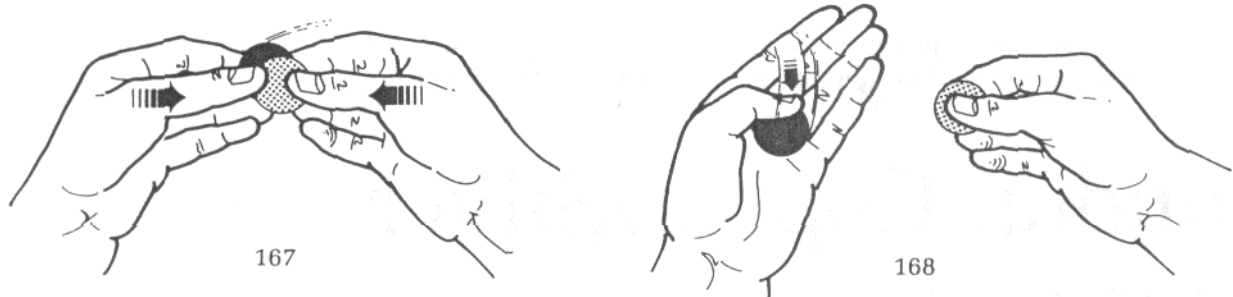

Your right hand does a Palm Change as it turns palm down, switching the silver coin for the copper. Open both hands, turning them partially palm up, the coins apparently having switched places; the silver coin rests on your left fingers and the copper on your right fingers.

Repeat the above sequence twice. In other words, both hands close into fists; your left hand secretly flips over the copper/silver coin and your right hand does the Palm Change. The second time You do the sequence the copper coin will jump back to your left hand and the silver to your right. The third time you do the sequence the copper will jump to your right and the silver to your left. You can repeat this ad nauseum, but David usually does it three times before going into the ending sequence which switches out the gimmicked coin.

Ending No. I

Let's assume you've just done the third transposition. The copper/silver coin rests on your left fingers silver side up, the silver coin is classic palmed in your right hand, and the copper coin rests on your right fingers.

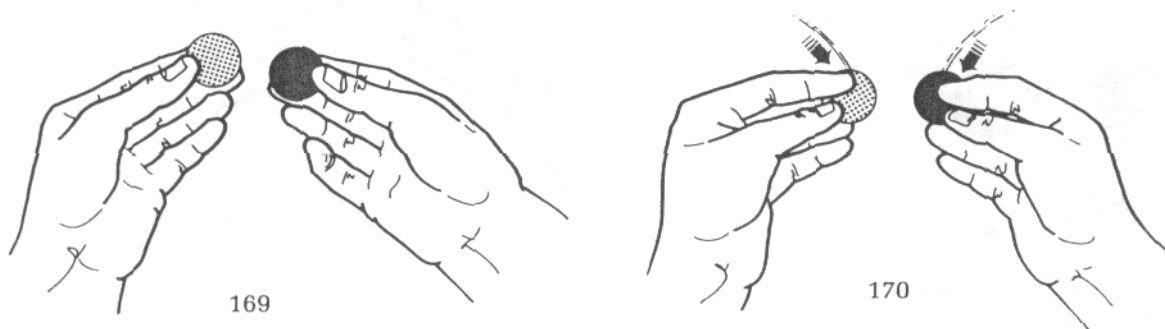

Your thumbs slide the visible coins in each hand onto the first and second fingertips (fig. 169). Move your first fingertips to above each coin so that they're clipped between first and second fingertips (fig. 170). Move your thumbs beneath the coins and turn your hands palm down, keeping the faces of the coins toward the audience - they end grasped between thumb and first finger (fig. 171).

Raise your right hand, turning it palm up, and say, "Copper in this hand" (fig. 172). Simultaneously lower your right hand and raise your left hand (turning it palm up so the silver side of the gimmick remains toward the audience) and say, "Silver in my left hand." As you lower your right hand do the Palm Change as it closes into a fist, switching the copper for the silver. Relax your right fingers a bit so they hang down slightly with the silver coin resting inside them.

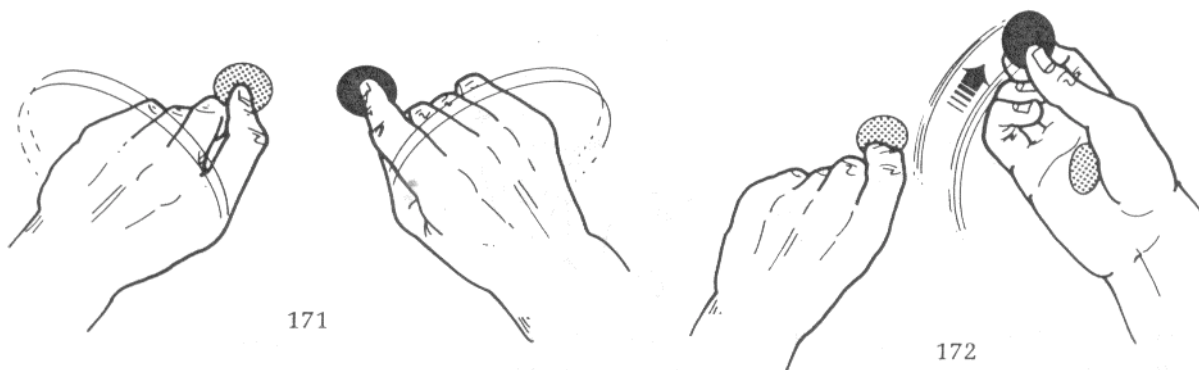

Open your left second, third, and pinky fingers and do a Hanging Coins type of "put" into your left hand. That is, your right hand turns partially palm up and moves to your left hand, your right fingers moving inside your left fingers with the silver coin (fig. 173). Leave the silver coin there, immediately closing your left second, third, and pinky fingers over it.

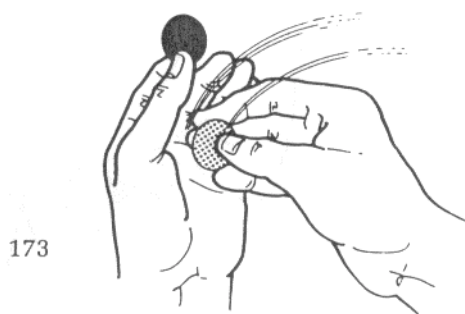

Your right hand takes the copper/silver coin from between your left thumb and first finger and your left hand turns palm down (your thumb and first finger closing into a complete fist). Lay the coin silver side up on the back of your left fist (fig. 174). Say, "The silver's on the back of my hand - that leaves the copper

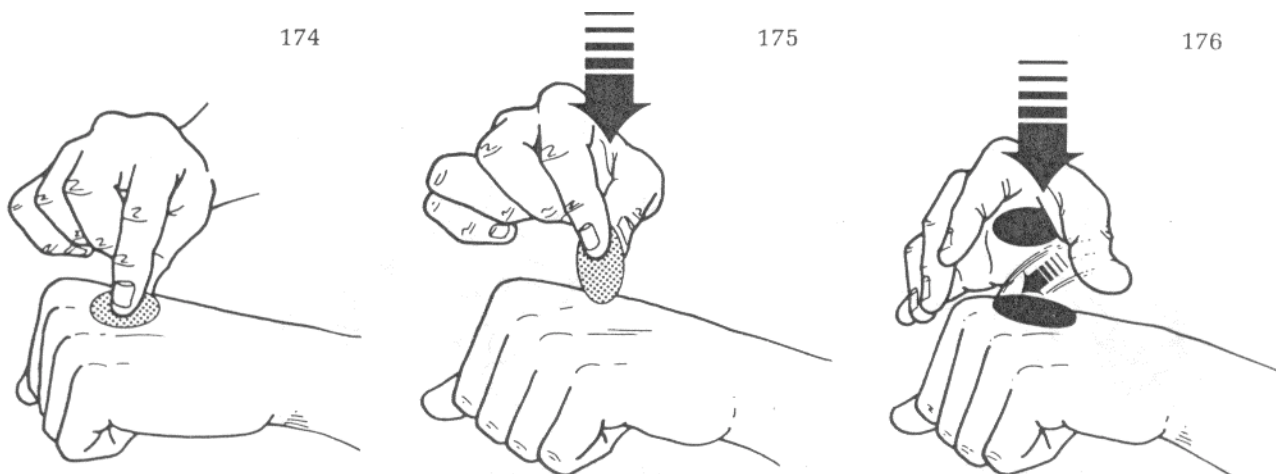

inside." Your right thumb and first finger grasp the silver's edge and lever it upward to a vertical position, its bottom still resting on your fist (fig. 175).

Tap the coin lightly against your fist twice, and on the third tap straighten your right fingers in front of it. Of course when you do that the coin will fall forward, copper side up (fig. 176). Immediately spread your right fingers wide so that the spectators can see the copper coin through them (fig. 177 is the audience view). It should be an instant change, your fingers straightening and opening immediately afterward.

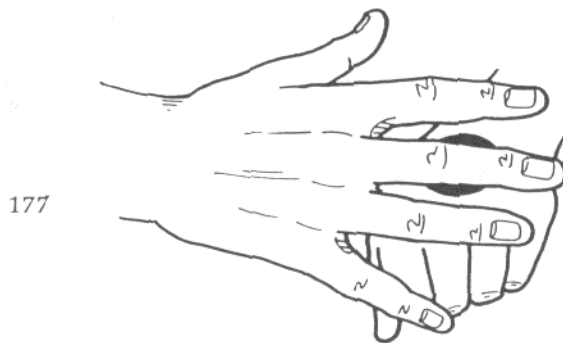

Lower your right hand, moving your right thumb onto the copper coin (fig. 178). Draw the copper off your fist and onto your right fingers (fig. 179). Raise your left hand slightly, turning it over and opening your fingers to reveal the silver coin inside. At the same time your right hand closes into a fist and does a Palm Change, switching the gimmicked coin for the regular copper, which your right hand drops onto your left palm beside the silver. Both coins can now be examined.

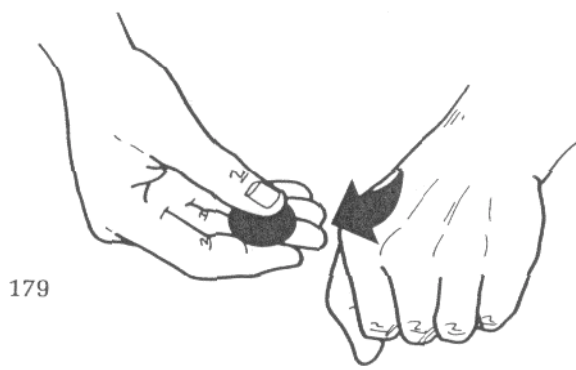

Ending No. 2 (Fred Kaps)

This is an alternate ending that David often uses for laymen. Again, let's start at the end of the third transposition. The copper/silver coin rests silver side up on your left fingers and the copper coin rests on your right fingers. The silver coin is classic palmed in your right hand.

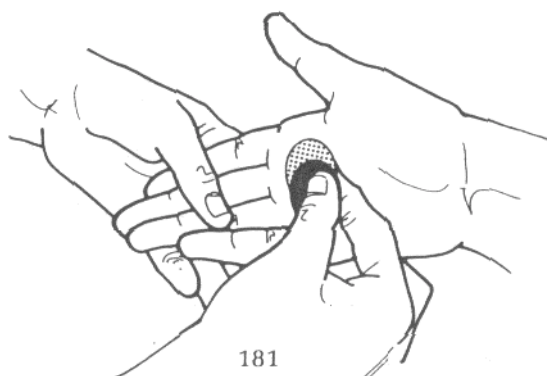

Lay the copper coin partially over the silver coin and hold both between your right thumb and fingers (fig. 180). Ask the spectator to extend his right hand, palm up, in front of him. Place the two coins, still overlapping, onto the base of his fingers (fig. 181). Ask him to close his fingers and then turn his hand over.

Ask him to reach inside the thumb hole with his left fingers and pull out one coin halfway and leave it there. They will always pull out the coin closest to the hole, which is the copper/silver coin, and it'll always be copper side up (fig. 182). Reach over to his fist with your right hand and take the coin that's sticking out. Display it on your fingers and close your hand into a fist doing a Palm Change. Open your hand revealing a silver coin, and ask the spectator to open his, revealing a copper.

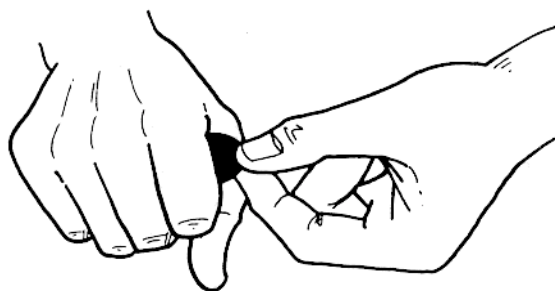

182

Edge Grip Copper/Silver

David Roth

This is David's way of applying Edge Grip to the opening of a copper/silver sequence. Let's assume two coins are on the table - a copper and a silver, and an extra copper coin is classic palmed in your right hand.

Turn both tabled coins over a few times to show both sides, leaving the copper coin on top of the silver coin, overlapping inward (fig. 183). Let your right hand settle to the table in a relaxed fist as your left hand makes a palm-up gesture. Relax your right palm and allow the extra copper coin to drop to fingertip rest.

183

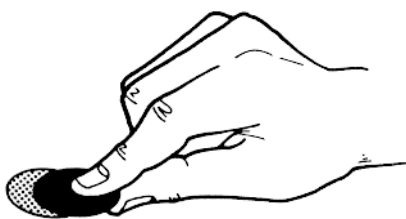

184

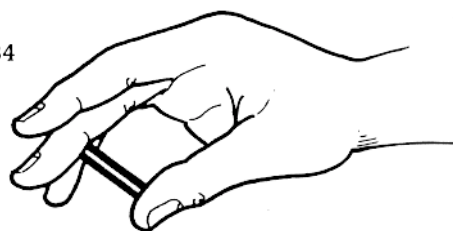

Your right hand does The Scoop Addunder, adding the extra copper coin beneath the stack as it's picked up. Curl your right fingers slightly so that the coins form a neat stack inside them and move your thumb onto their inner edges (fig. 184). Move your right hand over your palm-up left hand and do David's first method for getting into Edge Grip (taught in High Flying Winged Silver). In other words your right thumb and fingers relax just enough to allow the two lower coins, a copper and a silver, to drop onto your left hand. (You'll find that particularly easy - the last copper practically holds itself back because of the larger size of an English penny.) As soon as the coins drop your left fingers close, pivoting the extra copper into Edge Grip. Immediately turn your left fist palm down and lift it to jingle the coins. At the same time your right hand descends to the table for a moment.

Open your left hand, bringing the copper and silver coins to your fingertips for display. Take the silver coin with your right hand in Edge Grip Display and hold the copper that remains in your left hand in a similar way. Your hands appear to be completely empty except for the two coins.

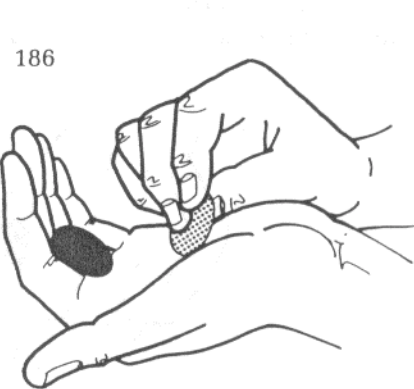
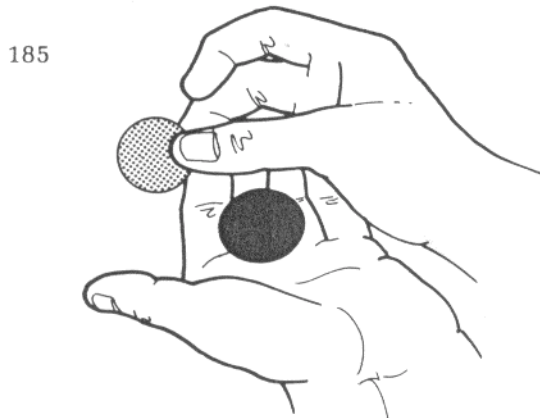

Here's one way that I might go into a copper/silver sequence after doing David's opening handling just described. Your left hand turns palm down and places the copper coin onto the table. As it turns palm up your right hand moves over it and releases the Edge Grippped copper into left-hand finger palm (fig. 185). Your left fingers must be curled to conceal the action from the audience. Your right hand immediately moves the silver coin back near your left palm in position for a Retention Pass (fig. 186). Do the move and close your left fist.

Your right hand transfers the silver coin from fingertip rest to classic palm as it reaches to pick up the copper coin on the table. Do a Palm Change as your right hand makes a fist. Say your magic mumbo jumbo, turn both fists palm down and open them over the table - a copper falls from your left hand and a silver from your right.

Ultra Coin Assembly

David Roth

This is a for-magicians-only version of David's famous Chink a Chink routine. In the original routine (which I wrote for Apocalypse Vol. 1 No. 1) an extra coin was used and the hands crossed during the routine. In this version two extra coins are used and the hands never cross (a la Frank Thompson). As usual with all of David's routines the illusion is impeccable, especially for the two final coins, as you'll see in a moment.

You must be seated at a table opposite the audience and working on a soft surface. Four half dollars lie on the table in a square, each about a foot from the others - the two inner coins about three inches from the table edge (fig. 187). Two extra coins are classic palmed in your right hand.

Hold your palm-down hands over the inner coins (your right hand over the inner right coin and your left hand over the inner left coin) and say, "I'm just going to cover the coins. . . ." Retract your hands as you finish that line, moving them slightly apart and letting them settle on the table behind the coins.

Without pausing, continue, "...but I won't touch them." As you say that relax your right palm and allow one of the two coins in classic palm to drop to the table. Reposition your right hand over the just-dropped coin so that it's beneath your thumb base (fig. 188 is a side view). The only sleight used in most of this routine is the action of sliding a coin beneath the thumb base. (And you'll have to be able to do it with both hands equally well.) Right now you've got a coin beneath your right thumb base. Lift your hand as far off the table as possible - your thumb base will hang lower and continue to rest on the coin (fig. 189). Your hands hover over the table during the entire routine, and it appears as if you're not really touching the coins, merely covering them. You've got to have a good classic palm to do this or else your right hand will look cramped.

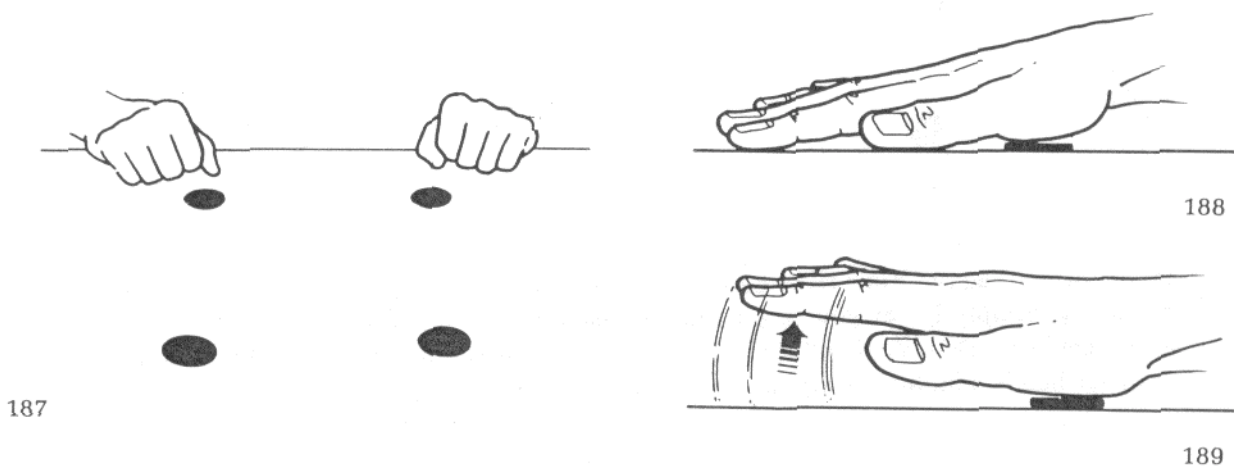

Move your hands forward and cover the outer two coins (a coin sliding beneath your right thumb base), and say, "I could cover these two" (fig. 190). Retract your hands, covering the two inner coins, and say, "Or I could cover these two" (fig. 191). Now, your hands move independently, your right hand covering the inner left coin. Say, "Or I could cover these two" (fig. 192). Reverse the positions of your hands, i.e., your right hand covers the inner right coin while your left hand covers the outer left coin, and say, "Or I could cover these two - but nothing happens until I wiggle my thumbs." During all of the above movements the hidden coin slides beneath your right thumb base. It will appear completely natural.

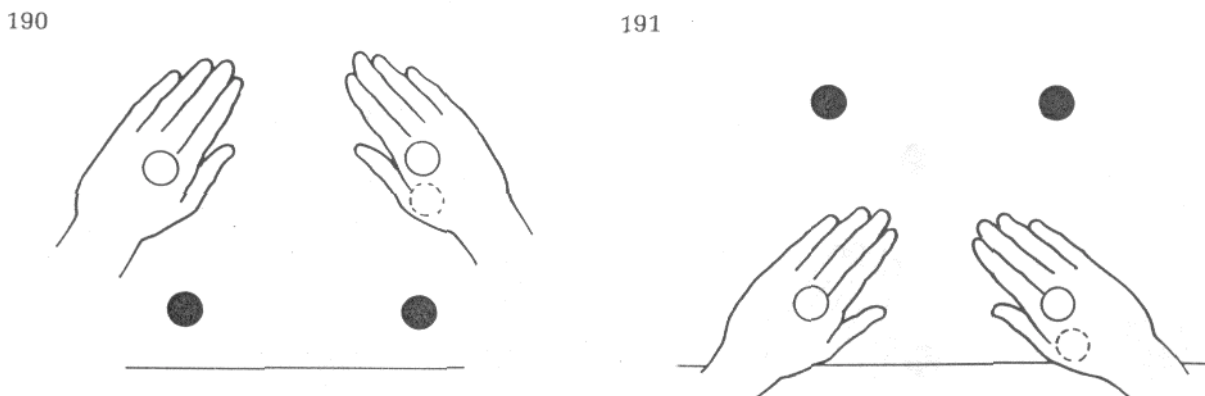

Let's go over the final covering movement again because your left hand does a little extra something as it covers the coin at the outer left. Move your left hand over the coin so that it's directly beneath your thumb base. Now move your hand toward you just a bit, sliding the coin beneath your left thumb base, your hand moving as if to cover the coin (if it was still there) with your palm (fig. 193). This is called The Hook Action. All your left hand is really doing is, as it covers the coin, sliding back a bit farther so the coin appears to be beneath the palm when it's already been stolen beneath the thumb base.

Wiggle your thumbs. Both hands move simultaneously to the sides, your left hand taking a coin, your right hand leaving a coin, so that two appear at the inner right and none at the outer left (fig. 194). Move your hands inward and let them relax, to rest position behind the coins. Your left thumb base has a coin concealed beneath it.

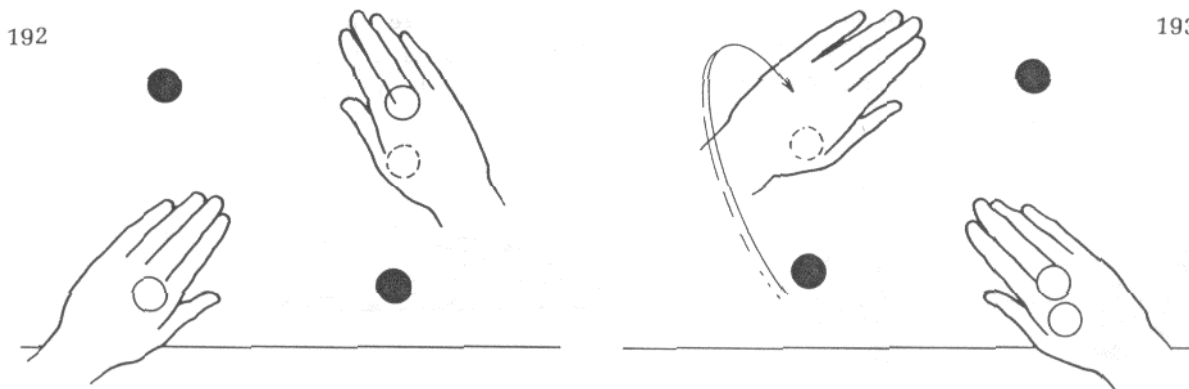

Move your hands forward again. Your right hand covers the two coins at inner right - but The Hook Action is not necessary. Simply lower your right thumb base over the innermost coin. Your left hand covers the inner left coin (fig. 195). Your right hand steals a coin beneath thumb base and your left hand leaves its coin as your hands simultaneously move back to rest position (fig. 196).

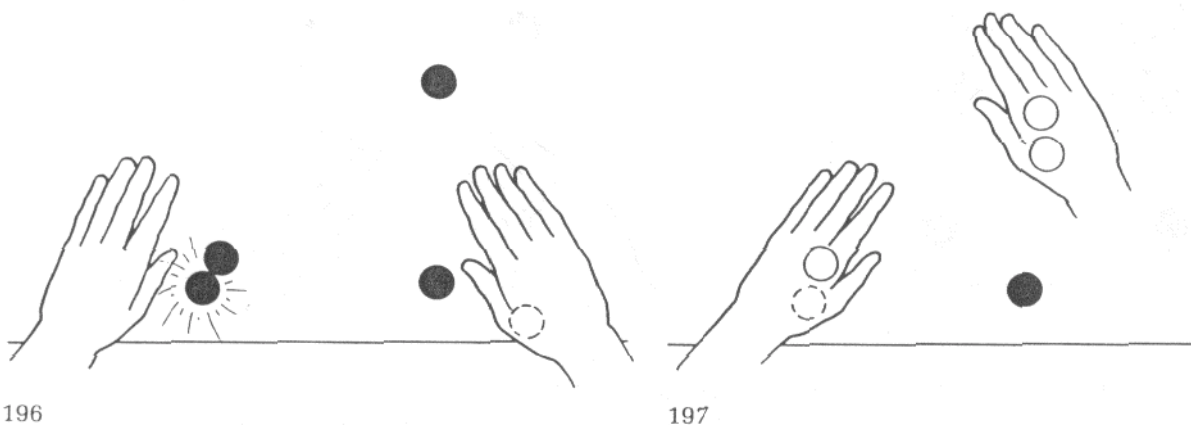
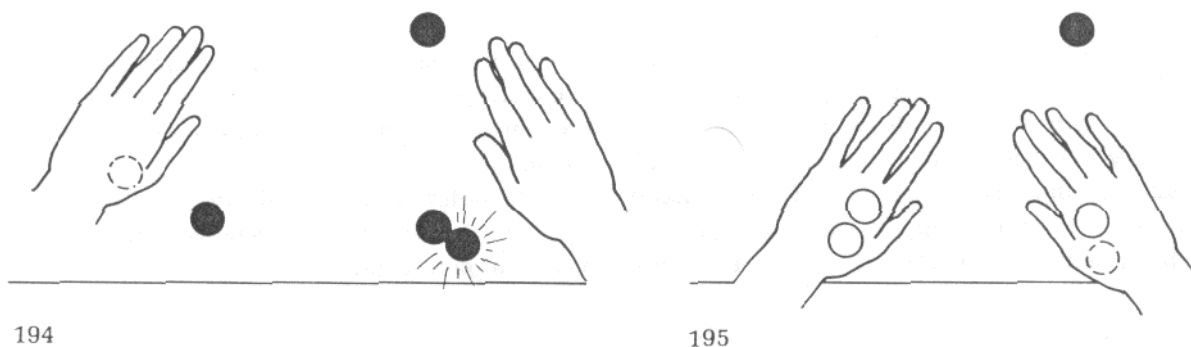

Move your hands forward again. Your right hand covers the coin at the outer right, adding its coin. Your left hand covers the coins at the inner left positioning the innermost coin beneath thumb base (fig. 197). Wiggle your thumbs and simultaneously move both hands to rest position, your left hand sliding a coin beneath it (fig. 198).

Move your hands forward again. Your right hand performs The Hook Action as it covers the coin at the inner right. Your left hand covers the coin at inner left (fig. 199). Your hands move to rest position, your right hand stealing a coin, your left hand leaving a coin, so that two coins are at the inner left and two at the outer right (fig. 199 a).

198

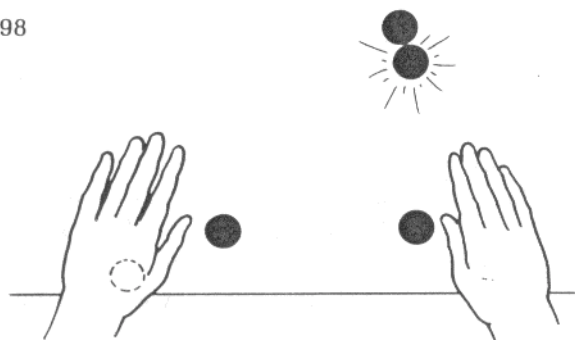

199

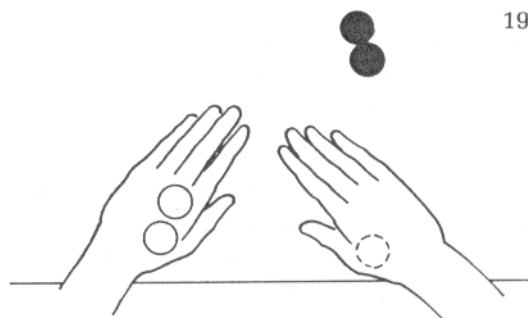

199A

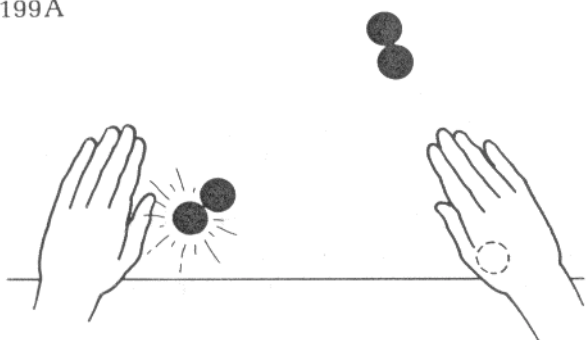

200

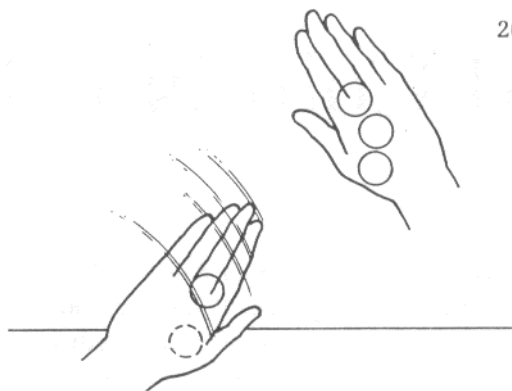

201

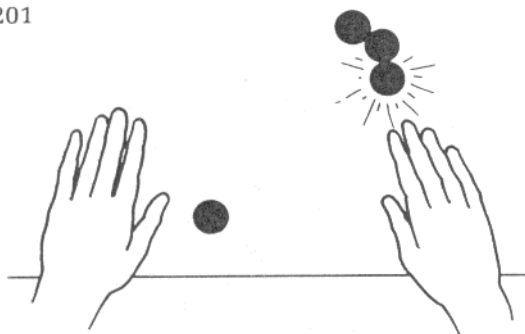

202

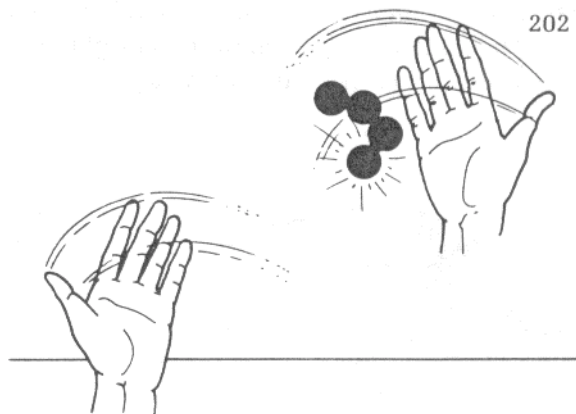

You're about to enter the final sequences of the routine where the two coins at the inner left will almost visibly jump to the outer right - no hands cross, no extra moves. In order to do this you're going to have to lap two coins, one at a time, without making any noise. David has a sure-fire method that's easy. Your legs should be crossed beneath the table throughout the routine - but not tightly. Of course they must be crossed just snugly enough so that a lapped coin will not fall through (between your thighs). After the first coin falls into your lap you'll have to squeeze your legs together, covering the coin already there (it should be almost folded under the cloth of your pant leg) so that when the second coin lands it won't hit the first.

Okay; two coins are visible at the outer right and two more at the inner left. Move your hands forward, your right hand covering the two coins at outer right and adding the one beneath thumb base. Your left hand covers the coins at inner left, the innermost coin positioned beneath thumb base. As your left hand covers the coins it hooks inward, sliding the coin beneath thumb base off the table and into your lap (fig. 200).

Move your hands to rest position, your right hand leaving a coin, and your left hand simply moving aside. That leaves three coins at the outer right and one coin at the inner left (fig. 201). Squeeze your legs together as already described, creating a place for the next coin to fall.

Move your hands forward again. Your right hand covers the coins at outer right and simply relaxes, allowing the coin which has been in classic palm throughout the routine to fall onto the table beside the three already there (it should not clink against them as it lands). Your left hand performs The Hook Action, getting the coin at inner left beneath thumb base and, without pausing, moving back a bit to the table edge and lapping it. To end, simply turn your hands palm up (where they are) book style revealing four coins at the outer right (fig. 202).

Wild Coin No. 1

David Roth

It was inevitable that Peter Kane's Wild Card plot should eventually be adapted to coins, and both Father Cyprian and Al Schneider have published methods. David has many versions - this, I think, is the best. It is un gimmicked, and uses a cup a la Father Cyprian's version. You must be seated at a table opposite the audience, working on a closeup mat. A small opaque cup with four half dollars in it is also on the table. An English Penny is classic palmed in your right hand.

To perform, pick up the cup with your right hand and spill it to the left, dumping the silvers onto the table (fig. 203). Take the empty cup with your left hand and extend it toward the audience. Your right hand takes the cup and tables it, mouth up, at the outer right. Arrange the four silvers in a horizontal row about an inch apart, about half a foot from the table edge.

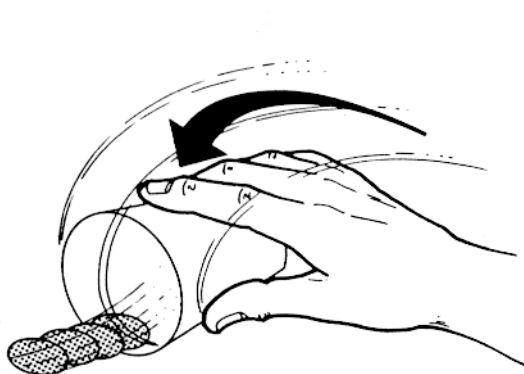

203

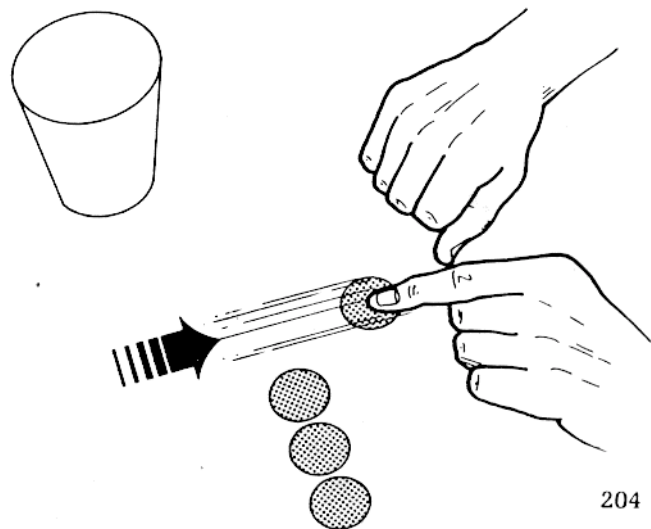

204

The First Coin

Move your left first finger onto the coin at the right end of the row and pull it toward you (fig. 204). When it's halfway between you and the other coins, stop, turn the coin over. Turn your left hand palm up and say,

"Half dollar, a silver coin." Pick the coin up with your right thumb, first and second fingers (fig. 205). Note that the coin really rests on your thumb, your fingers pulled back so it's visible.

Raise your right hand a bit, at the same time extending your first and second fingers over the silver coin and pulling it along your thumb until it hits your thumb crotch (fig. 206). Reverse your hand's direction, lowering it, thumb palming the silver coin and allowing the classic palmed copper to fly into your left hand (fig. 207). Your left fingers immediately close around it and your left fist turns over. Your right fingers rub the back of the fist.

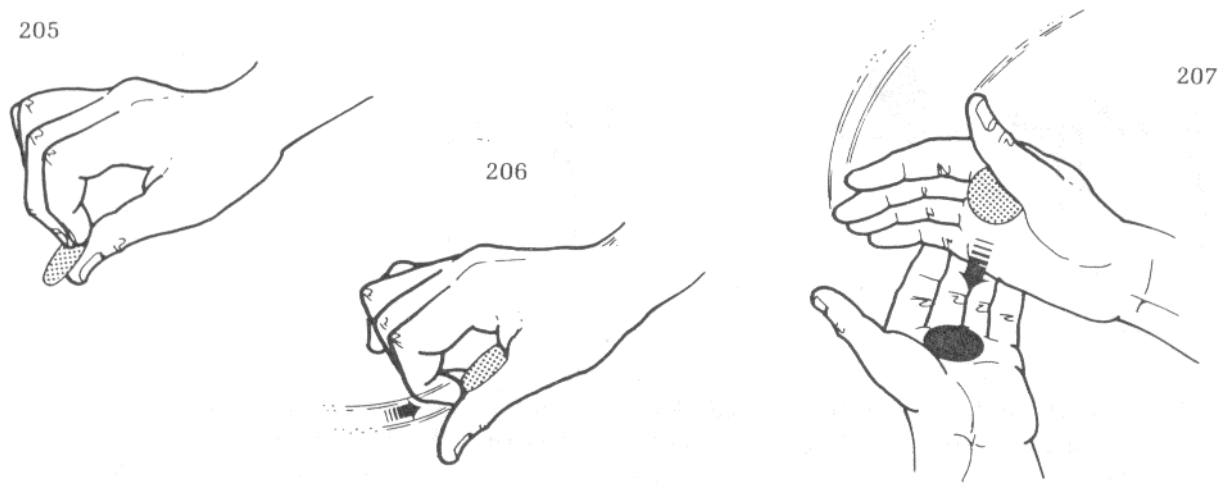

Your right hand settles to the table in a fist for a second, transfers the coin from thumb palm to fingertip rest, and then moves toward your left hand again. As it travels classic palm the silver coin. Rub the back of your left fist again, turn it palm up, wave your right hand over it, and then open it revealing the copper coin.

Dump the copper onto the table so its other side is seen. Turn it over again with your right hand, pick it up, and place into finger palm on your palm-up left hand. You're going to do a fake Shuttle Pass (call it Shuttle Pass Variant). The action appears the same to the audience, though the silver coin in your right hand is retained in classic palm throughout - that's the only difference.

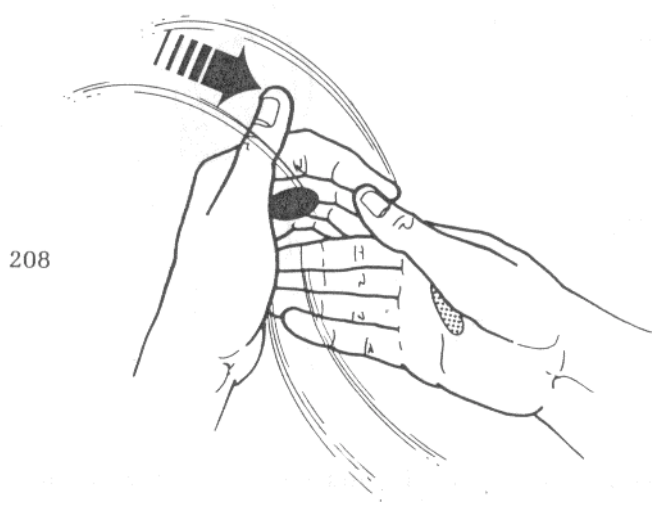

Like this. Your hands are a few inches apart; right hand palm down, left hand palm up. Move your right hand beside your left hand and do the rocking action of the Shuttle Pass, your left hand turning palm down and your right hand turning partially palm up beneath it (fig. 208). Your right hand immediately turns over as if it has the coin and moves over the cup (fig. 209). Lower your hand over the cup and open your fingers,

releasing the classic palmed silver coin (fig. 210). There should be a clunk as the coin falls in. Your hand must be directly on top of the cup as you release the coin so it doesn't flash; the spectators will think you've dropped the copper coin into the cup.

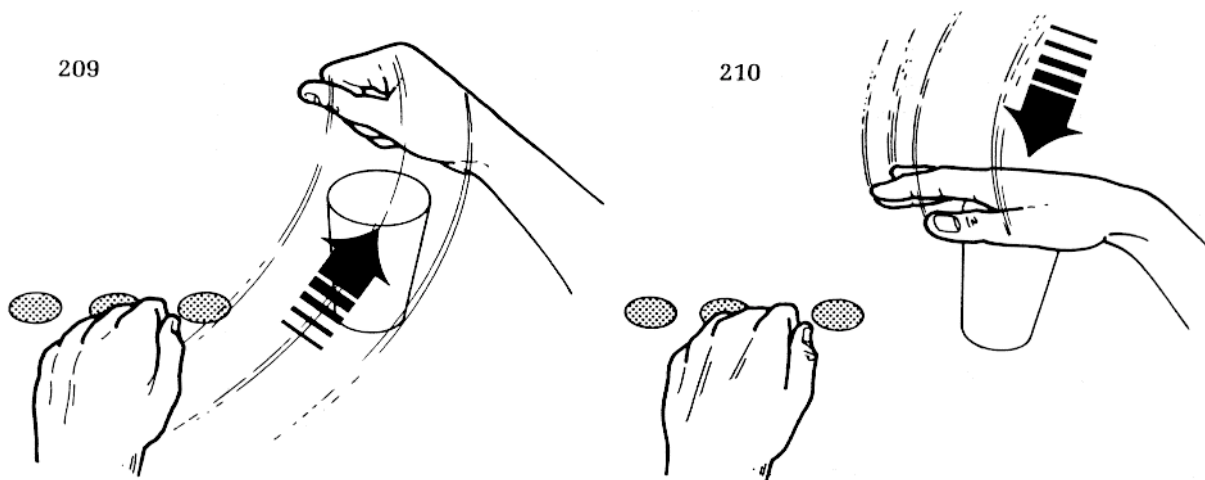

The Second Coin

Move your right first finger onto the next coin at the right end of the row and drag it toward you. Turn it over with your left hand. Lift it with your right hand and, at the same time, turn your left hand palm up keeping your fingers curled (so the finger palmed copper isn't exposed). Place the silver coin onto your left palm (fig. 211). It won't hit the copper coin because that's farther away in finger palm. Close your left fingers loosely as your right hand moves away.

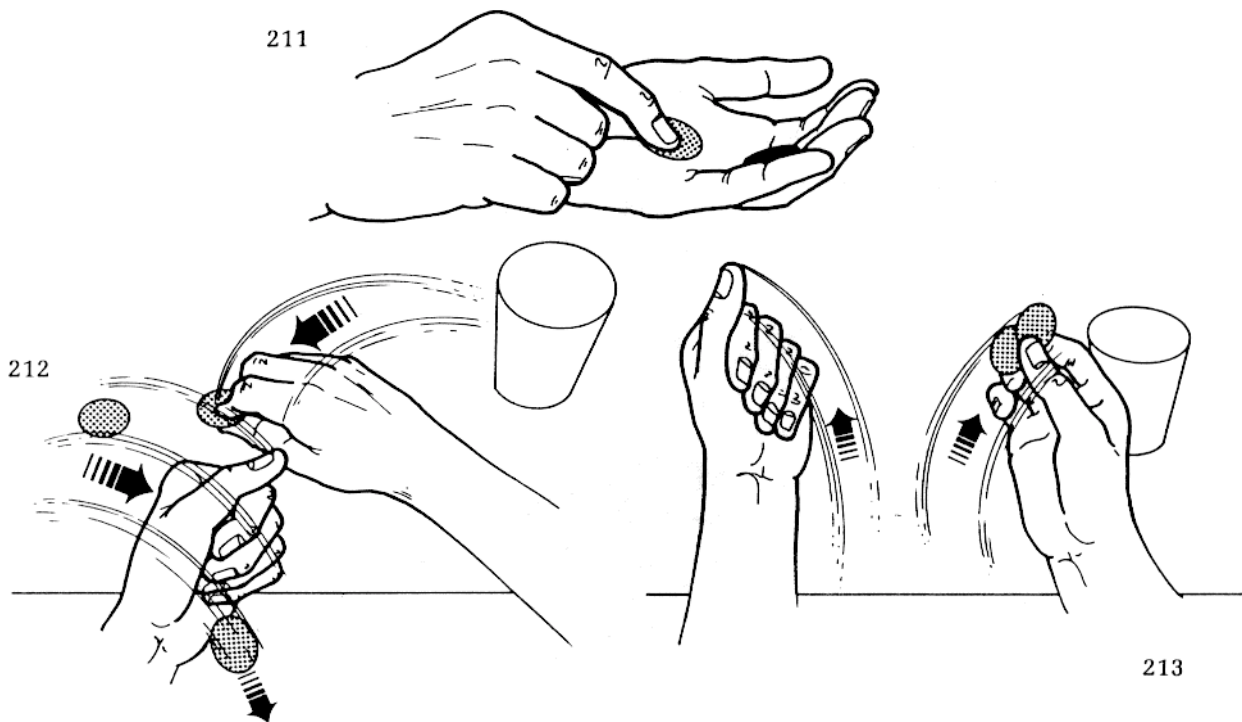

Your right hand crosses over in front of your left hand, reaching for the two silvers still on the table. As it does your left fist turns thumb up (vertical) and moves to the table edge, lapping the silver coin (fig. 212). It takes only a second - the coin simply rolls out near your pinky. Raise both hands without pausing and say, "Don't watch these two, they'll change later. . ." (fig. 213). Drop them on the table. Turn your left fist palm up and open it revealing the copper coin as you finish the sentence, "... watch this one."

Dump the copper onto the table and push it toward the audience with the request, "Look at it." Do the Frontal Imp Pass as taught - your three patter lines are: "It's changed to copper. . ." (said as you gesture with both palm-up hands). Your hands drop into your lap. ". . . Just like the first one- . ." (said as your right hand comes up and gestures palm up to the cup). It turns palm down and drops, its fingers resting on the table. Your left hand loads the silver coin into it in thumb palm and immediately moves upward, palm up, and gestures toward the two silvers still on the table as you conclude, ". . . those two will change in a moment."

Your left hand turns palm down and drops, its fingers resting on the table like your right hand. Both hands move onto the table, fingers curling into loose fists, the silver coin transferred from thumb palm to fingertip rest. As your right hand reaches for the copper coin near the audience it classic palms the silver coin].

Pick up the copper and place it on your palm-up left hand in Shuttle Pass position. Do the Shuttle Pass Variant as described, your right hand apparently taking the copper coin and dropping it into the cup. (The copper remains in lefthand finger palm and the classic palmed silver goes in the cup.)

The Third Coin

Move your left first finger onto one of the two remaining silver coins and slide it toward you, turning it over. Pick it up with your right hand and hold it in Spellbound position between thumb, first, and second fingers. Straighten your left fingers, moving your thumb onto the copper coin to hold it in place. Move your left fingers in front of the silver coin (fig. 214). The back of your left thumb knocks the silver coin into righthand finger palm (fig. 215). Leave the copper coin in Spellbound position and move your left hand away revealing the change.

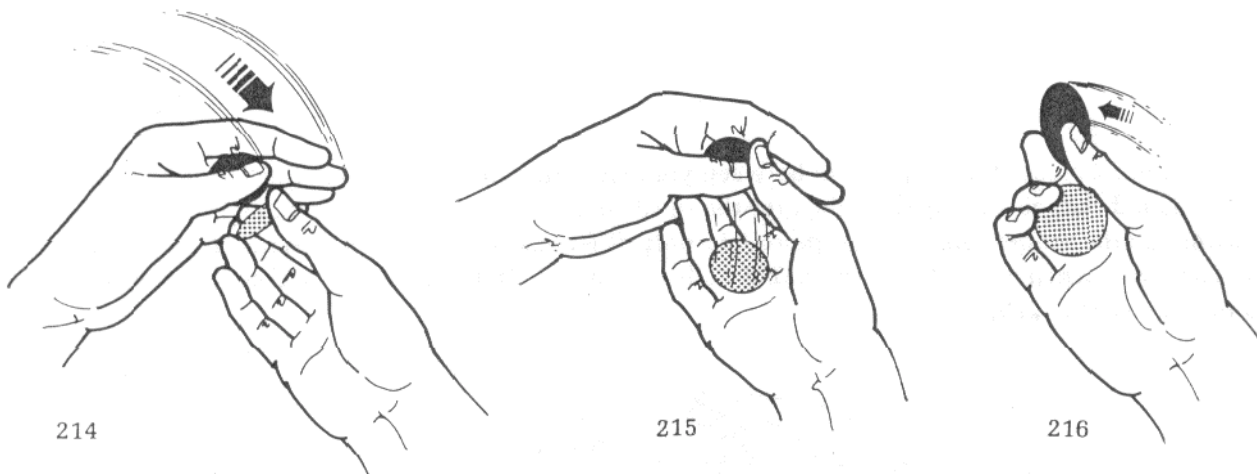

Squeeze your right thumb and fingers together snapping the copper to a vertical position (fig. 216). You're going to do the same Thumb Palm Switch that you did at the beginning of the routine - though this time your right hand simply turns over and moves over the cup. As it turns your first and second fingers push the copper coin into thumb palm. The silver coin is released from finger palm over the cup and falls inside with a clink. Your right hand immediately drops over the table edge in Frontal Imp Pass position, fingertips on the table.

The Fourth Coin

Your left hand turns over the last silver coin and picks it up, holding it in Spellbound position. At the same time your right fingers curl, pulling your right hand onto the table in a loose fist. The copper coin remains in thumb palm.

Raise your right hand, straightening your fingers, and move it in front of the silver coin. Relax your left thumb and allow the silver coin to fall backward into your left hand - your left thumb and fingers grasp the lower portion of the thumb palmed copper (fig. 217). Turn your left hand over, moving the copper coin beneath your right fingers (fig. 218). Move your right thumb behind your fingers and slowly draw your right hand away from you, revealing the change (fig. 219). This is a sucker vanish of Derek Dingle's which originally appeared in Epilogue - your right hand looks pretty suspicious at this point, so slowly turn it palm up.

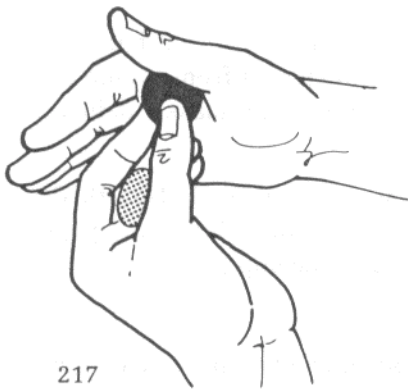

217



218



219

Your left hand places the copper coin between your right thumb and fingers in Spellbound position. Do the Spellbound change already described for the third coin. Afterward the silver coin will be at your right fingertips and the copper coin in finger palm. The only difference here is that you do the change at the table edge. That way, when your left fingers take the silver coin and lift it, your right hand simply tips back and laps the copper (fig. 220).

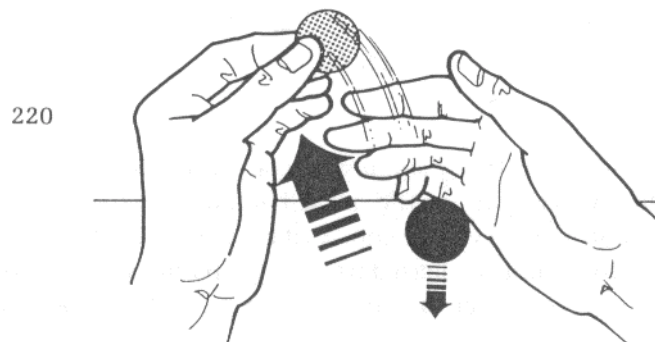

220

Your right hand immediately moves upward and turns palm toward audience, taking the silver coin. Wave it over the cup and then drop it in, saying, "It's a funny thing. The silver acts as a catalyst." Pick up the cup and swirl the contents. "It changes all the copper back into silver." As you say that dump out the coins revealing that they've all turned silver again.

Wild Coin No. 2

David Roth

This one is a standup impromptu version that uses a purse instead of a cup. This routine was developed before the preceding one, and is a much simpler application of the Wild Coin plot. I'm describing it using a purse so you can routine it with other items in the book which also use a purse in some way. David originally showed this to me using three coins, though I will describe how to add a fourth in In Addition at the end.

The only thing you need beside three half dollars and a copper coin is a purse. Any sort of small change purse that will stay open by itself, and has a snap type top, will do (fig. 221). To set up, drop the silvers into the purse, close it, and classic palm the copper coin in your right hand. You should be standing at a table, or any soft surface you can work on.

Open the purse and dump the silver coins onto the table. Lay the open purse to the right, open and angled slightly to the right. Arrange the coins in a horizontal row (fig. 222).

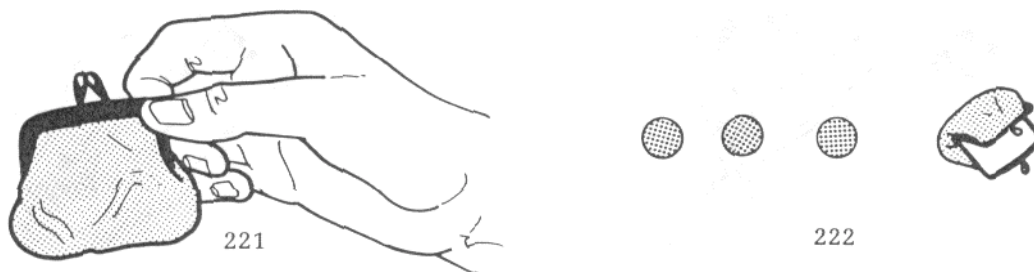

The First Change

Pick up one of the silver coins with your right hand, holding it between thumb, first, and second fingers (fig. 223). Your left hand is held palm up about a foot away. Do the Bobo Switch, except from classic instead of finger palm. In other words, your right hand apparently tosses the silver coin into your left hand.

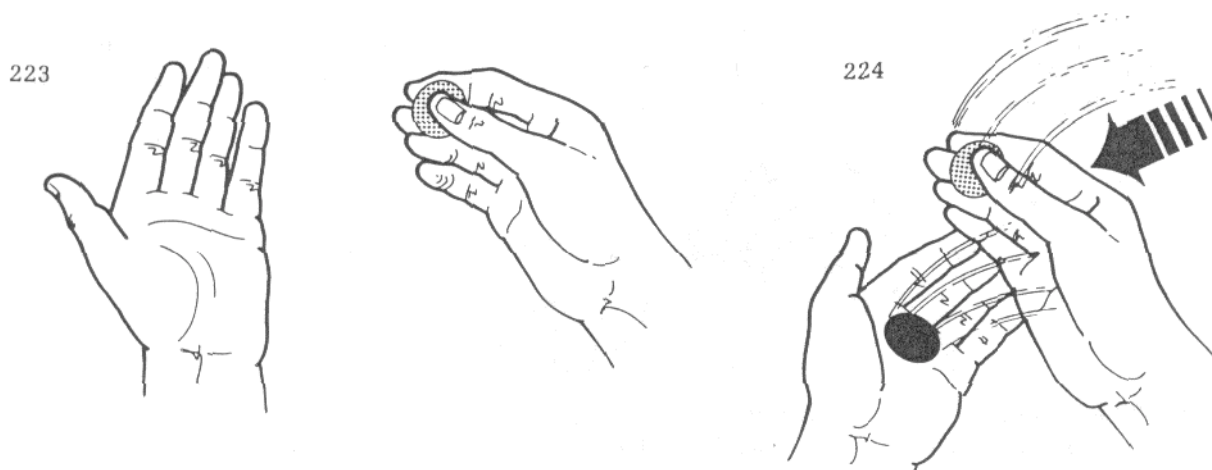

Actually, your right thumb holds the silver coin against the insides of your first and second fingers and you relax your palm allowing the copper coin to fly into your left hand (fig. 224). Your left fingers quickly close around it. Your right thumb immediately pulls the silver coin into finger palm.

Relax your right hand, allowing it to curl into a loose fist, and letting it drop slightly. Raise your left hand, crumpling your fingers and opening them to reveal a copper coin. Push it to finger palm with your left thumb. You're going to do a variation of the Shuttle Pass (there are several in the routine). Move your hands together as if to do the move. Your left hand turns over and your right hand turns partially up - but not much (just enough to give the impression that it has caught a coin). Immediately turn your right hand down again and move it toward the purse. On the way your right thumb pushes the silver coin from finger palm to fingertip rest (fig. 225). Your hand swings around to the purse's right and then hooks back (fig. 226). Toss the coin into the purse, the tips of your fingers actually entering the purse so that the silver coin isn't prematurely exposed (fig. 227). During all of that your left hand settles into a relaxed fist.

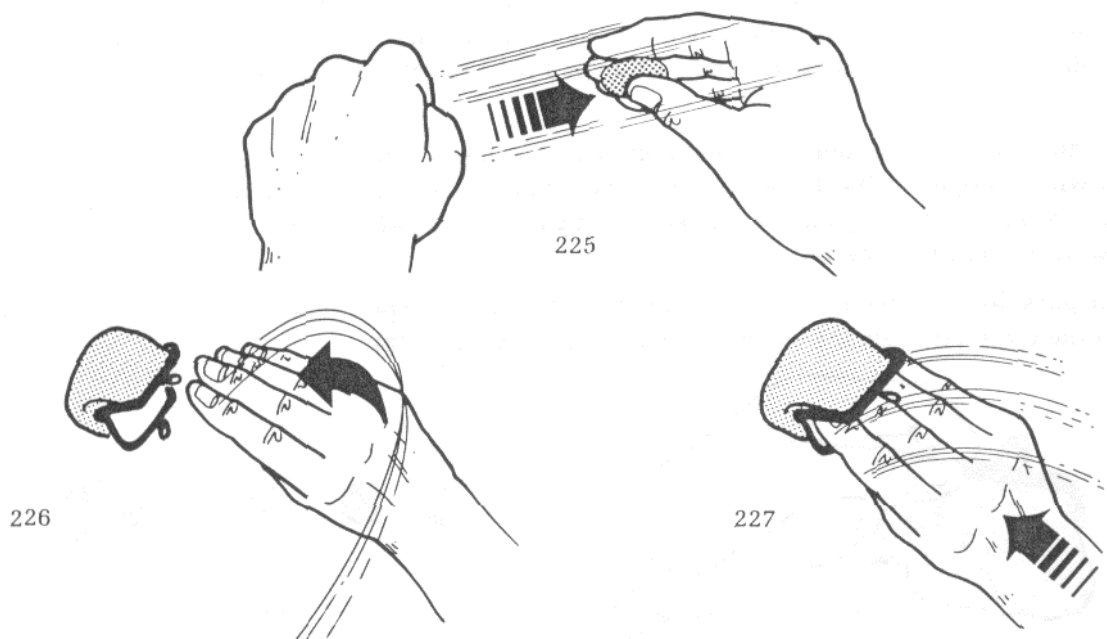

The Second Change

Your right hand picks up another silver coin. Turn your left hand palm up, keeping your fingers curled slightly to conceal the finger palmed copper coin (fig. 228). Do a Retention Pass, apparently placing the silver coin into your left hand while actually retaining it in right-hand fingertip rest. Your left fingers close as the coin is seemingly placed into the hand. Your right fingers push the silver into classic palm. (You can use any type of Retention Vanish or, as David suggests, any vanish where the coin ends classic palmed in your right hand. The basic Classic Palm Vanish where your right third finger pushes the coin up into palm as you apparently place it into your left hand will do.)

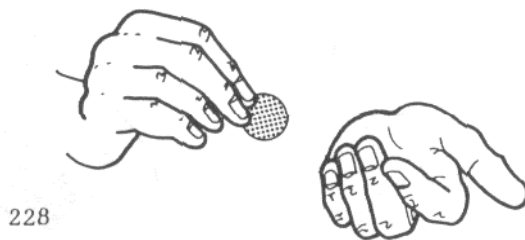

Crumple your left fingers and open them revealing a copper coin. Do the Shuttle Pass Variant that you did after the first change, your hands moving together. The coin in your right hand remains in classic palm throughout the move. Fake the Shuttle Pass, your left hand turning palm down afterward, your right hand pretending to take the coin and move toward the purse. As it goes relax your right palm and allow the coin to drop to fingertip rest. Swing your right hand around, hook-tossing the silver into the purse. Remember to stick your fingers into the purse so the silver coin doesn't flash.

The Third Change

Your right hand picks up the last silver coin and holds it at your fingertips in Spellbound or French Drop position. Turn your left palm toward you, straightening your fingers - your thumb holds the copper coin in place. Do a standard Spellbound change by moving your left fingers in front of the silver coin. Your thumb knocks it backward into righthand finger palm, and your left fingers leave the copper coin in its place.

Move your left hand away, revealing the change. Squeeze your right thumb and fingers together, snapping the copper to a vertical position. Drop the copper coin onto your palm-up left hand in finger palm. Do the Shuttle Pass Variant again, apparently taking the copper with your right hand and tossing it into the purse. Actually, of course, the finger palmed silver goes into the purse and the copper remains finger palmed in your left hand.

Pick up the purse with your right hand and shake it, then turn it over and dump all the silver coins back onto the table revealing a change en masse. Dispose of the copper coin at your earliest convenience.

In Addition: You may want to do this routine with four coins so it fits into a larger sequence of routines. You can, for example, either precede or follow this with David Arthur's Panda's Purse routine (which is taught in the next to last section). Here, then, is an additional change sequence I sometimes use which can be inserted into the routine. Use it for the third coin, and use the Spellbound change already described for the third coin for the fourth coin.

This move is based on a vanish of David's (related to a move of Arthur Buckley's which appeared in Principles and Deceptions) that was in Tarbell No. 7. Your right hand picks up the third silver coin from the row (one remains on the table afterward). Turn your left hand palm up and toss the silver coin onto it, catching it on your left palm. This is the same subtlety that was used in High Flying Winged Silver to keep coins from clinking: the copper coin is locked in finger palm. As soon as you've caught the coin close your fingers over it and turn your fist over. Maneuver the coin so that it hangs out of your fist at the fingertips as described in The Deep Back Clip Steal.

Two things happen at the same time. Your right hand, held palm down, moves over your left hand. Your left hand turns over beneath it - the silver coin sticking out of your fist going into right-hand thumb palm (fig. 229). Immediately move your right hand an inch or two to the right and rub your left fist with your fingers (fig. 230).

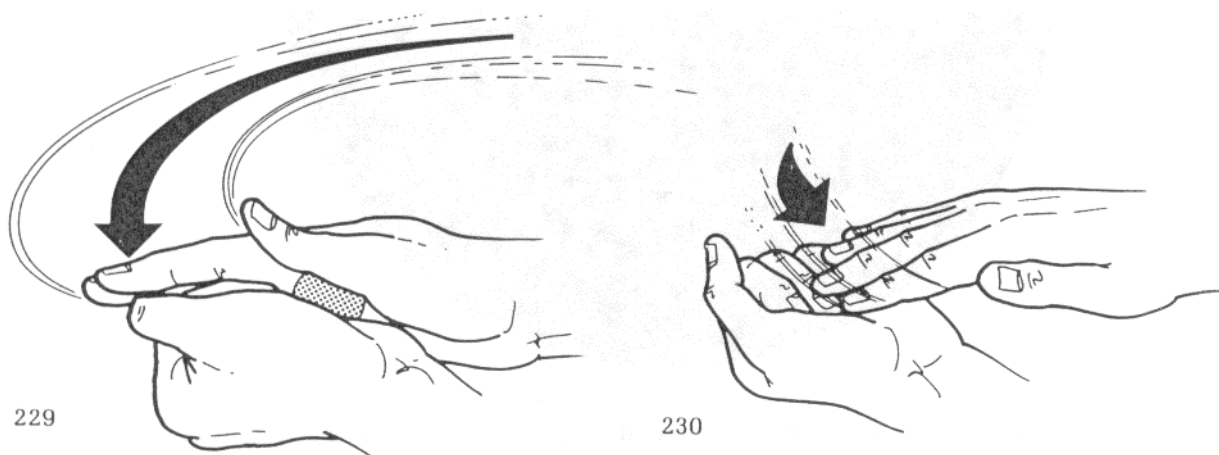

Lower your right hand and, as you open your left fingers to reveal the copper coin, your right fingers curl into a loose fist and transfer the silver coin from thumb to finger palm. Do the Shuttle Pass Variant exactly as in the first change, apparently taking the copper with your right hand and tossing it into the purse.

Now, pick up the fourth and final silver coin and do the Spellbound change described as The Third Change to continue.

The Portable Hole

David Roth

You could count the classic coin plots on the fingers of one hand - until now: add The Portable Hole to that list. This routine is the epitome of David Roth's genius as both a creator and synthesizer, and he's used it both in his professional act and lecture and it is world famous. What you're about to read is the height of coin magic - the state of the art. The routine itself is fairly long and complex, and will be difficult to master. Only a few can and will do it.

The props and conditions are simple. You must be seated at a table opposite the audience (though an alternate standup method will be given afterward). There must be a close-up mat on the table directly in front of you. You also need four half dollars, a purse frame, and a felt hole that's 3-7/8" in diameter - actual size reproduced directly below from Roth's own hole.

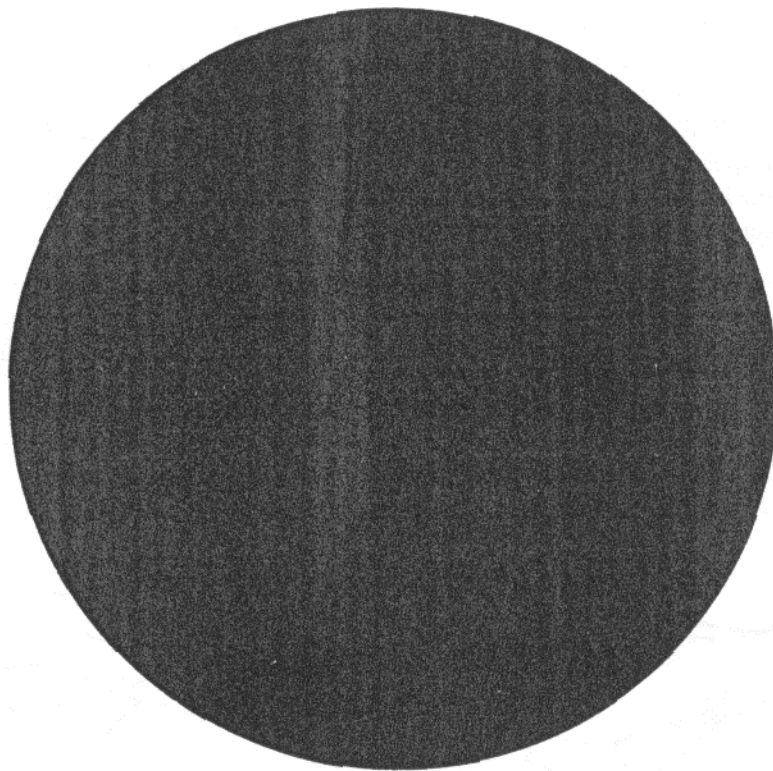

In order to save time when you're actually learning the routine I want to teach you two moves in advance. You should have already mastered The Shuttle Pass, Frontal Imp Pass, and some form of the Retention Pass (the ones taught in this book are fine). The first move you'll learn now is Marla's Spider Grip Vanish. Hold a coin in Spellbound position at your left fingertips. Hold your right hand palm toward you and move it in front of the coin (fig. 231). Move your right thumb onto the inner side of the coin and actually take it with your right hand (fig. 232). In other words, this is what you would do if you were doing what appeared to be a French Drop, but really took the coin instead.

As soon as your right hand begins moving upward with the coin concealed behind its fingers your left hand turns palm down, curling its second, third, and pinky fingers. Your left thumb and first finger stick out awkwardly so the hand looks suspicious (fig. 233). Make your left hand look cramped - as if it concealed the coin (this is a feint). At the same time your right hand turns palm down, its fingers loosely curled, the coin in fingertip rest. Raise your right hand and move it slightly forward (there will be a logical action for this during the routine) simultaneously pushing the coin into classic palm. Make a small tossing motion downward and spread your right fingers wide so that even though the hand is palm down it will appear empty (you need a good classic palm for this) (fig. 234). Turn your left hand palm up and open it to show that, contrary to what the spectators may have suspected, the coin is not there, either.



231



232

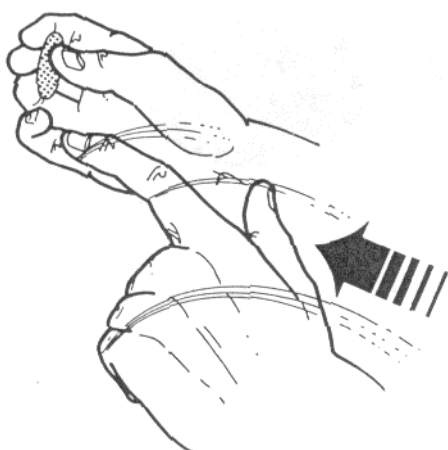

233

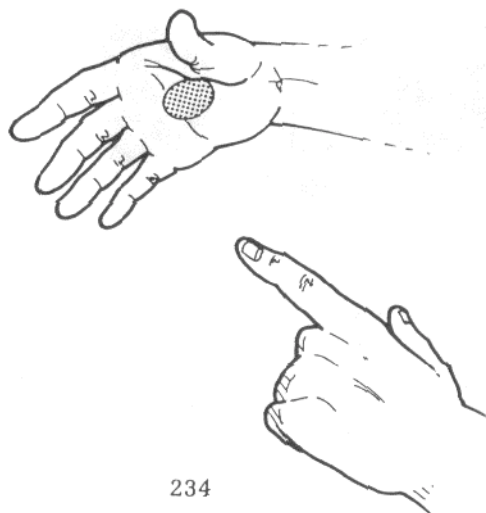

234

The second move you should learn now is The Kick Move. The idea of kicking one object beneath another is not new, but the technique and its applications are strictly David's. Place the felt hole on the mat and flatten it completely with your left hand. Place one of the coins directly beside it, about a quarter inch to the right (fig. 235). Your palm-down left hand, fingers together and straight, descends over the coin so that it's directly to the left of your thumb (fig. 236) in which the coin can be seen through the hand). Note that your hand is cupped very slightly so that it doesn't actually press on the coin. Also make sure that your thumb is relaxed and, while it is not sticking out to the side, it is a little away from the side of your hand.

I'm going to break this down into numerical steps because everything is so precise:

1) Your left thumb snaps to the left, kicking (not pushing!) the coin to the left. It will slide beneath the hole (fig. 237). It'll take a bit of practice so you can gauge exactly how hard to kick it - if it doesn't quite slide under all the way then kick it harder, if it flies out from beneath the left side of the hole then kick it lighter.

Other than your left thumb's action your hand does not move yet.

2) Start to lift your hand straight up, keeping it palm down, moving your thumb behind your fingertips as if holding the coin there (fig. 238).

3) Begin to turn your hand palm up and stop when your fingers are pointing directly to the right (fig. 239).

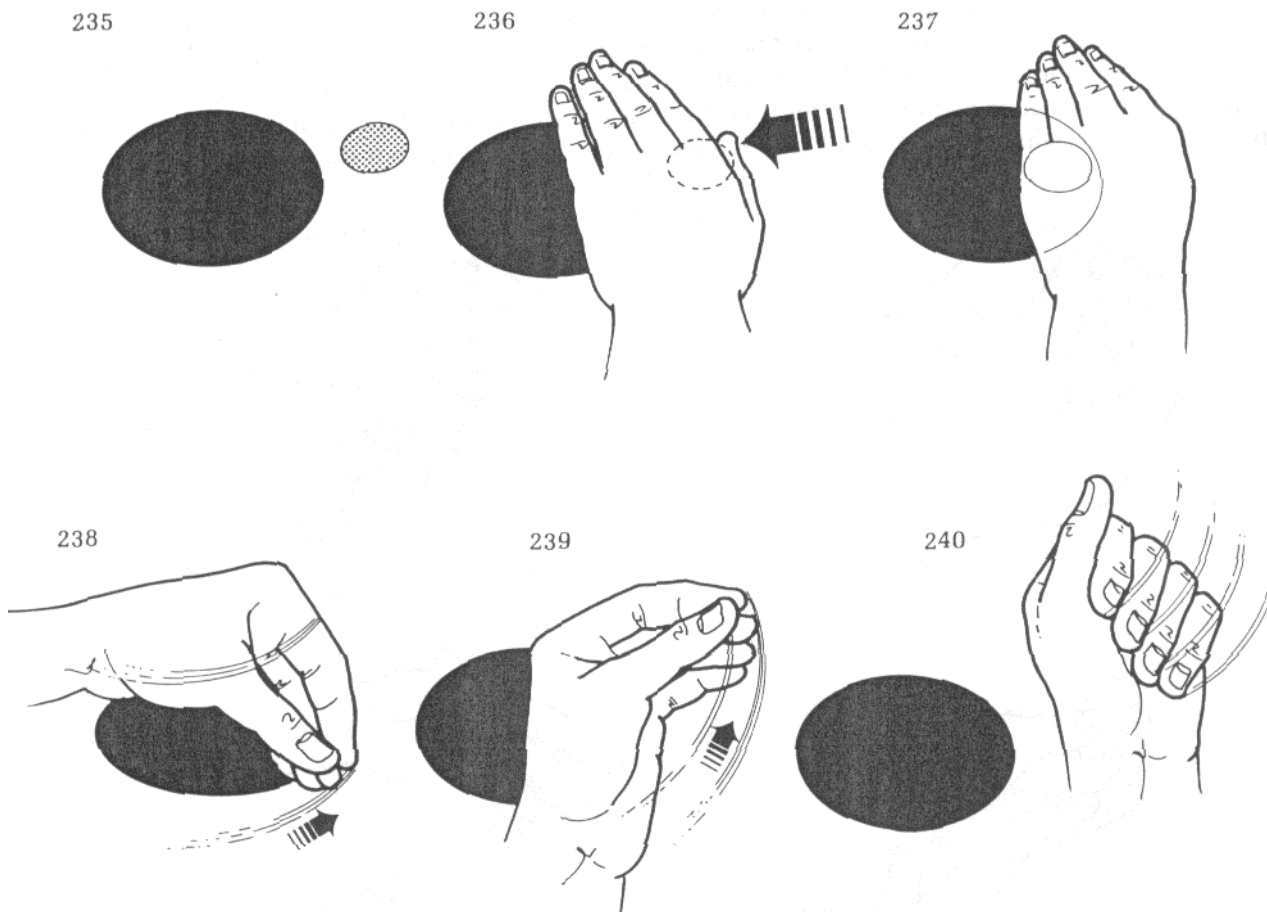

4) Continue turning your hand palm up, at the same time curling your fingers into a fist as if you've let the coin drop inside it (fig. 240).

The Kick Move must be done as if you were really picking up the coin - smoothly and rapidly, all the steps combining effortlessly into one fluid motion.

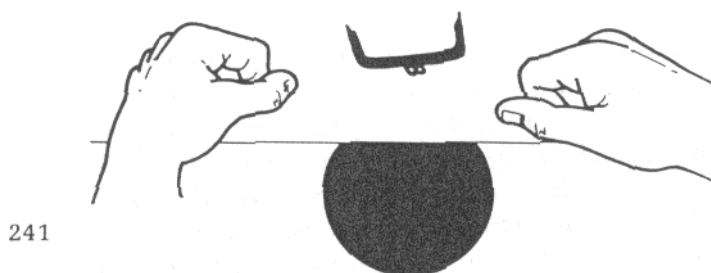

To set up for the routine, align the inner edge of the mat with the table edge and insert a portion of the hole beneath it directly in front of you so that most of it hangs behind the table (see next illustration). The purse frame rests on the table with the curled sides (on which the bag would normally hang) pointing toward the audience. Finger palm two coins in your left hand. The other two coins are in your right hand - one in finger palm, the other in classic palm. Both hands rest in relaxed fists on the table near the edge (fig. 241).

The Opening Sequence

Note: All patter will be in italics. "Ever see one of these before?" Pickup the frame by its right end between your right thumb and first finger (fig. 242). Place it into your left hand between thumb, first, and second fingers (fig. 243). "It's a bagless purse, a purse without a bag." Your right thumb and first finger regrip its right end. "Nothing to see, nothing to hear because there's no bag." Place the frame back into your left hand

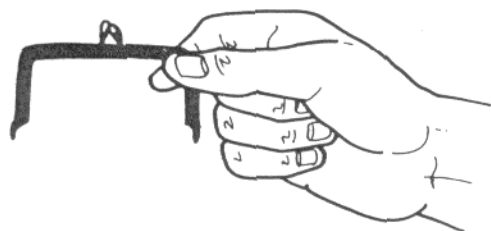

242

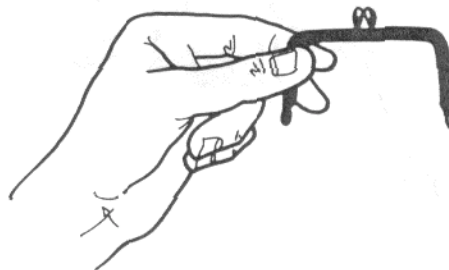

243

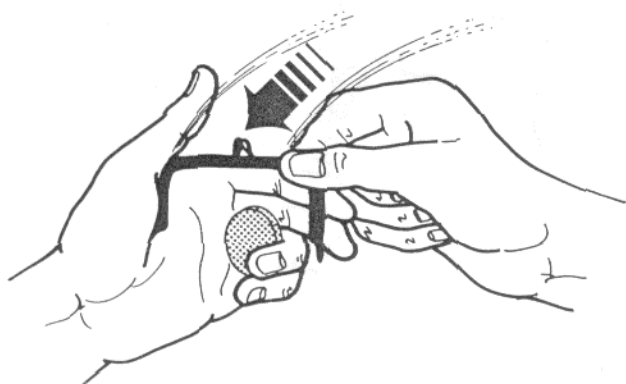

244

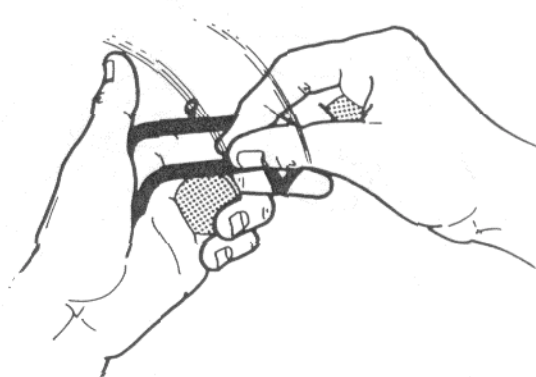

245

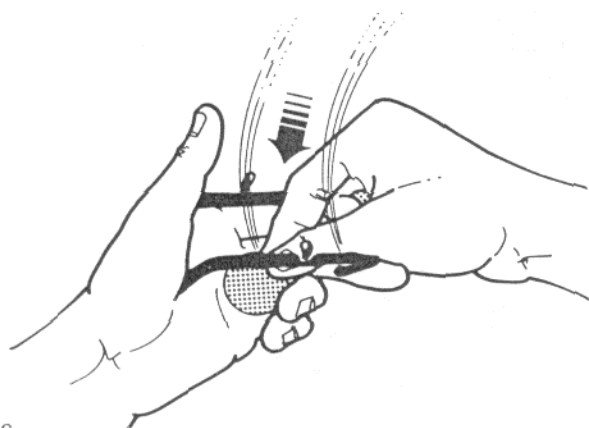

246

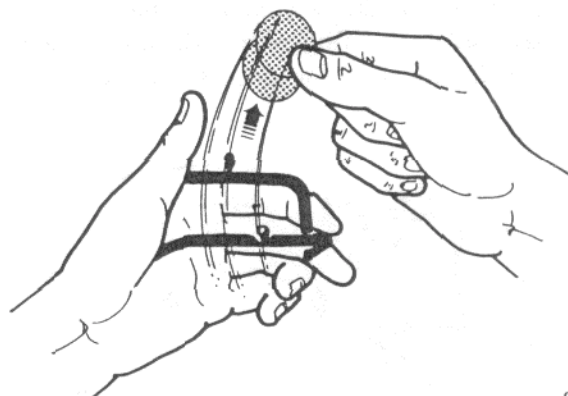

247

in production position, wedged between your thumb base and first and second fingers (fig. 244). "See anything? Hear anything? But it doesn't matter because I can open it up and take things out anyway." Suit action to words. Your right thumb and first finger snap open the frame (fig. 245), reach inside, and grasp the upper ends of the two finger palmed coins (fig. 246). Pull them out, spreading them (fig. 247). Toss them onto the table and continue, "Those ore half dollars from a purse without a bag."

Your right hand immediately returns to the purse and partially closes it, pulling it to the right (fig. 248). Snap the purse shut with the thumbs and first fingers of both hands at either ends. Lift the frame with your right hand. Your left hand arranges the two tabled coins as in Figure 249, and then moves beneath the frame. Extend your left first finger upward and wiggle it where the bag should be, saying, "Nothing to see..." (fig. 250). Raise the frame a bit, toward your right ear, and say, ". . . nothing to hear, no bag,"

248

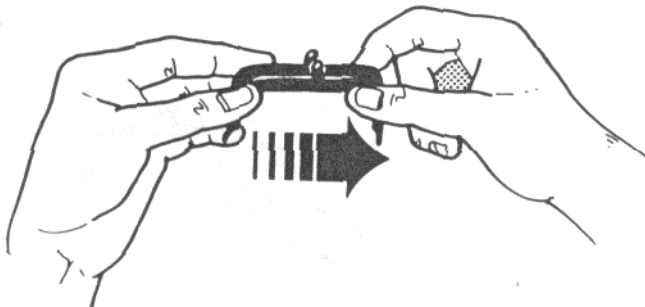

249



250

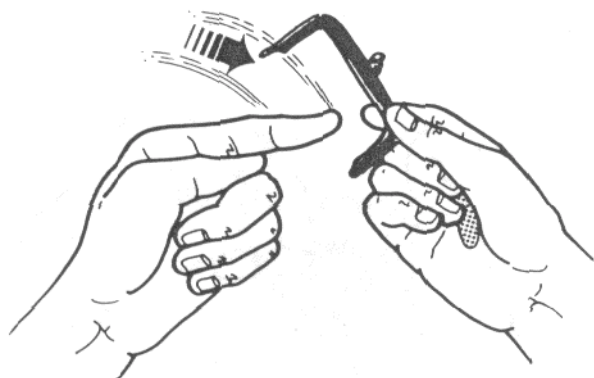

251



"But if you want to see it again, that's okay too." Place the frame back into production position in your left hand and snap it open with your right thumb and first finger. As you say, "I have another one right here," look downward into the frame and lower your right hand a bit (fig. 251). Move your right thumb onto the finger palmed coin. Raise your right hand, your thumb pushing the coin to just inside your fingertips (fig. 252). Insert your fingers into the purse and cleanly pull out the coin, pushing it past your fingertips with your thumb. Drop the coin onto the table, inward of the two already there (fig. 253).

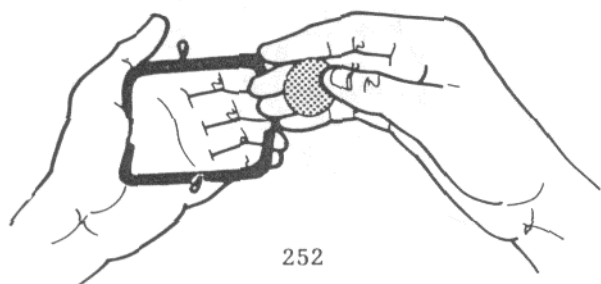

252

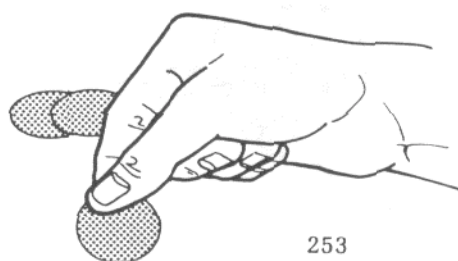

253

Snap the frame shut and place it, with your right hand, onto the table to your right with the "open" side toward you (fig. 254). At the same time your left hand picks up the just-produced coin and maneuvers it into palm-up finger palm in position for the Shuttle Pass. Do that move, apparently taking the coin from your right hand. Tap the coin on the mat where the frame's bag should be as you say, "That's the third half dollar from the purse without a bag" (fig. 255). Place that coin just to the left of the other two (fig. 256).

Pickup the frame with your right hand, saying, "Nothing to see, or hear." Transfer the frame to bet wee n your left thumb and first finger for a moment, "Sometimes people ask me if I keep things in the purse beside coins. . . " Transfer the frame back to your right hand so that it can place the purse back into your left hand in production position. Continue, ". . . and I do!" Snap open the purse with your right hand, and then make a palm-up gesture with it while your left hand drops to the table - just at the edge, as you say, "I keep something in here you wouldn't believe."

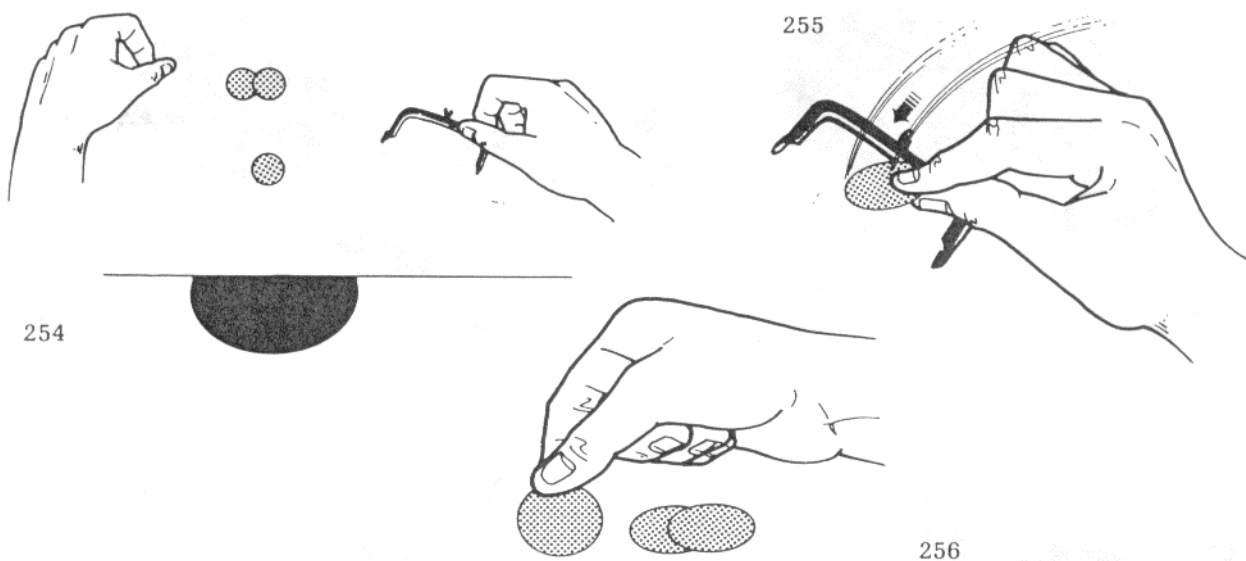

Turn your right hand palm down and extend your thumb and first finger into the purse until they can grasp the felt hole (fig. 257). Pull the hole up and out of the frame (fig. 258). Immediately let it flop open flatly on your right hand (fig. 259). Say, "Have you ever seen one of those before? That's a portable hole."

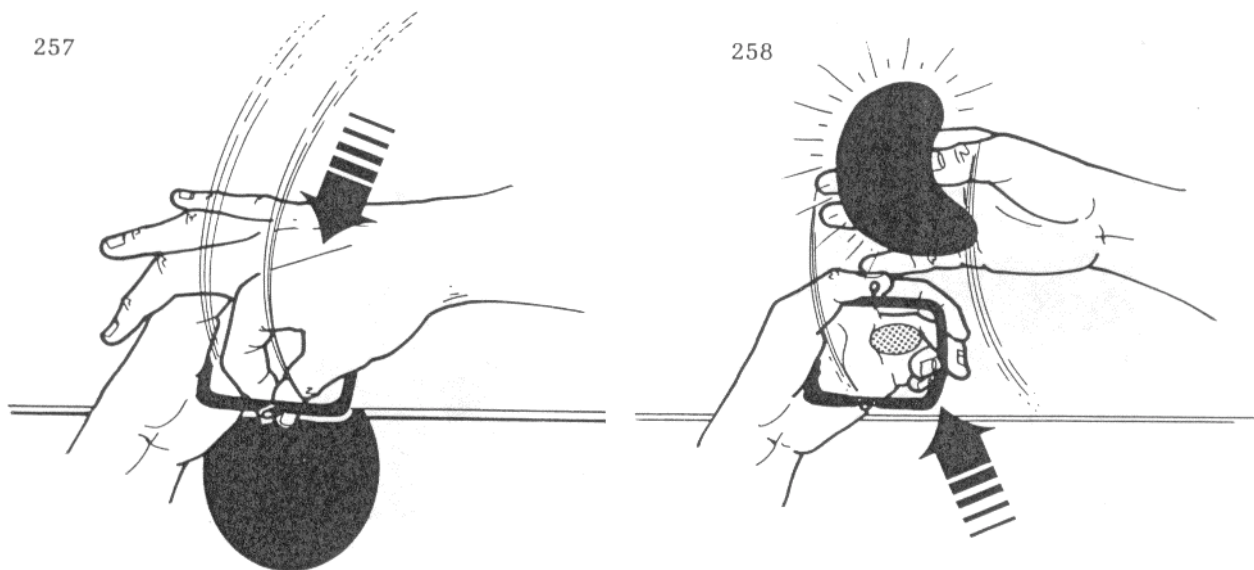

Your left hand turns palm down pushing the frame partially closed against the table (fig. 260). Leave the frame there and lift your palm-down left hand slightly. Two things happen simultaneously - your left hand turns palm up and your right hand turns palm down laying the hole over your left fingers (fig. 261). You must time this so that the coin which is finger palmed in your left hand isn't prematurely exposed.

"Yes, it's in ported -the genu in e article. Lots of magicians use these when they want to make something disappear, they just drop it in the hole and it vanishes. . . ." As you finish that sentence point downward into the hole with your right first finger (fig. 262). Immediately lower your right hand and slide your thumb

259

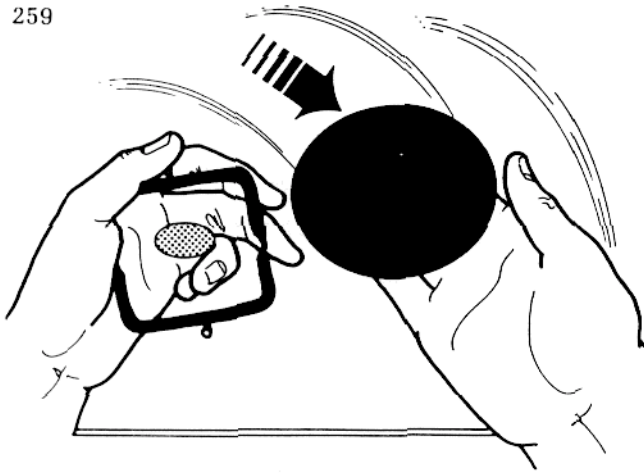

260

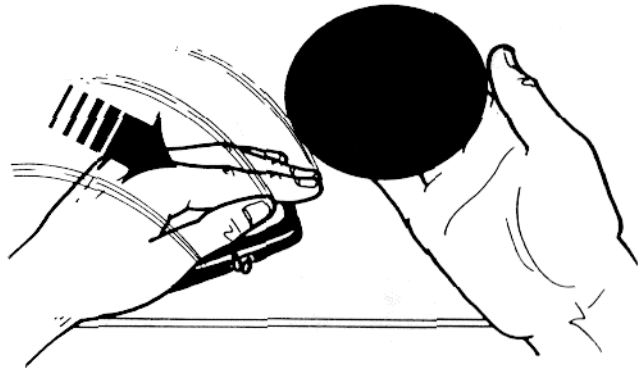

261

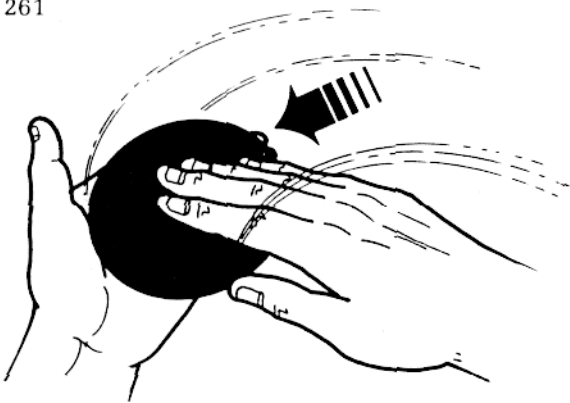

262

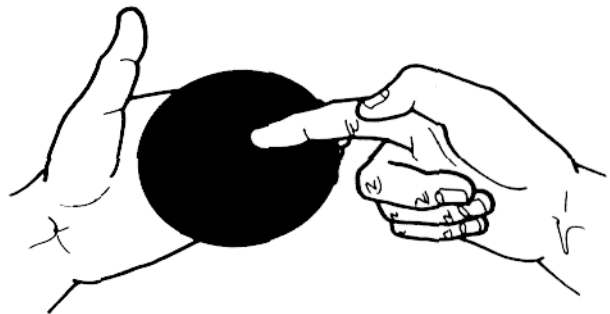

263

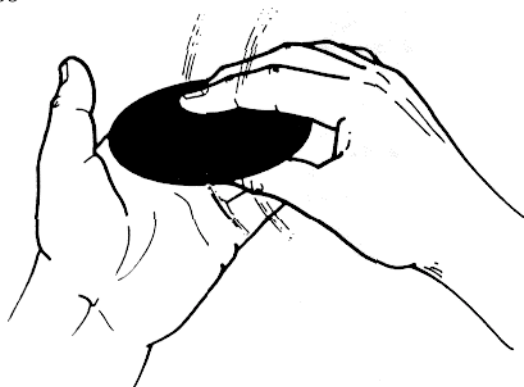

264

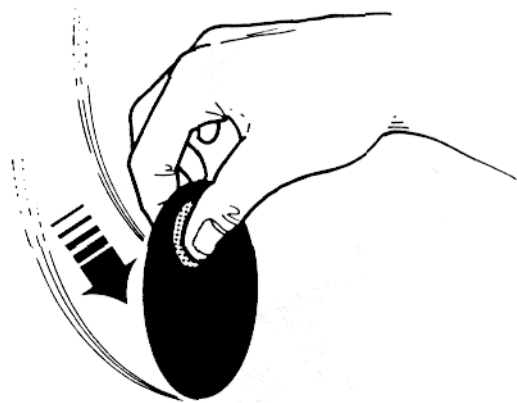

beneath the hole - and also beneath the coin in left-hand finger palm (fig. 263). Lower your right first and second fingers onto the hole directly over the coin and lift it. Your thumb slides the coin upward as your right hand bends at the wrist so the hole hangs downward (fig. 264). Note that the coin is now near the upper edge of the hole.

Point toward the center of the hole with your left first finger and say, "... actually goes into the hole. It's very convenient." Your left hand turns palm down and takes the hole between thumb and first finger exactly the same way your right hand holds it (fig. 265). Place the hole onto the table just to the left of the row of coins (fig. 266). Note that the concealed coin is beneath the inner edge of the hole.

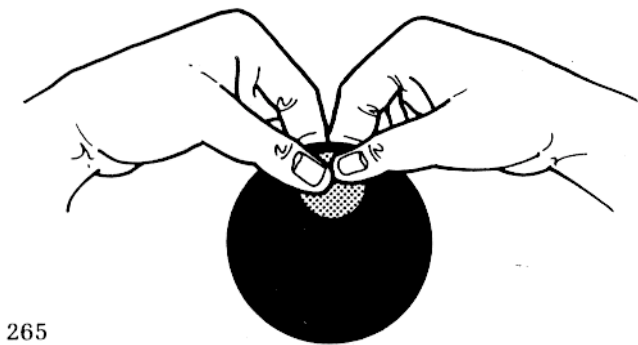

265

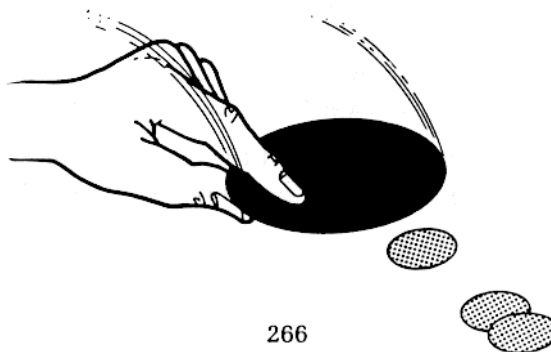

266

"Of course I can tell by the look in your eye that you don't believe a word of this - I didn't either ... until I saw it." Both hands pick up the purse and, holding it at either end, snap it shut. Your right hand lays the purse on the table to your right, open side toward you (fig. 267).

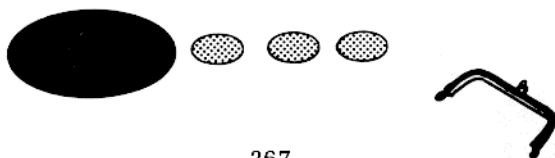

267

Arrange the three coins in a neat row - which is just to allow you to make sure that the left-end coin is in position for The Kick Move (about a quarter inch to the hole's left as already described).

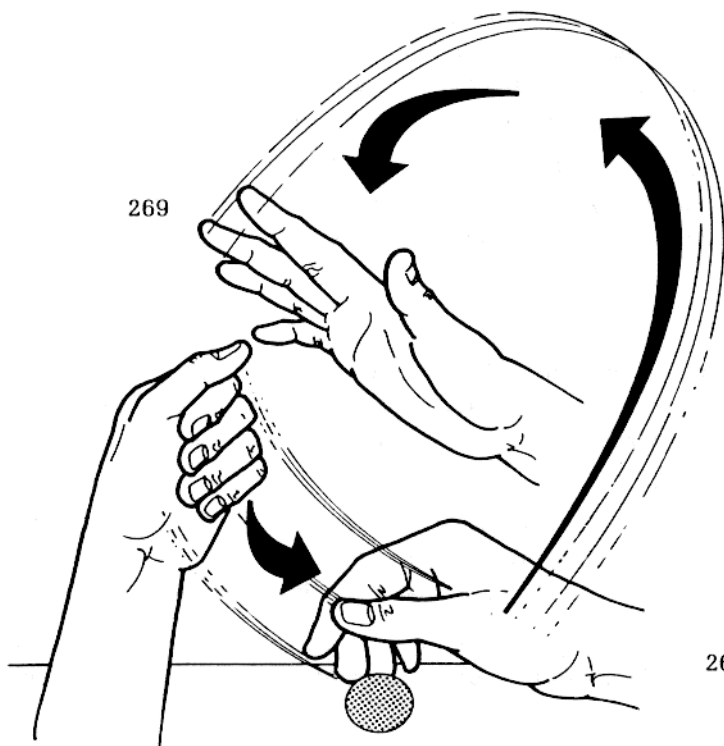

269

268

Part One

"So let me show you a little thing with a portable hole, a bagless purse, and three coins. Coin number one: the idea is simple, and when I say simple I mean to just drop the coin right into the hole. Gone without a trace, lost forever." Here's the action to go with those words. Your right hand picks up the right-end coin and does a Retention Pass into your left hand. As soon as your left fingers have closed your right hand begins a counter-clockwise circular swing first toward you and then to the right - over the table edge where it laps the coin simply by letting it slide off the fingertips (fig. 268). Without pausing your right hand continues moving, now outward and around until it waves over your left hand again (fig. 269).

Move your palm-up left fist over the hole, crumple your fingers and slowly open them at the same time pretending to toss the coin downward into the hole (fig. 270).

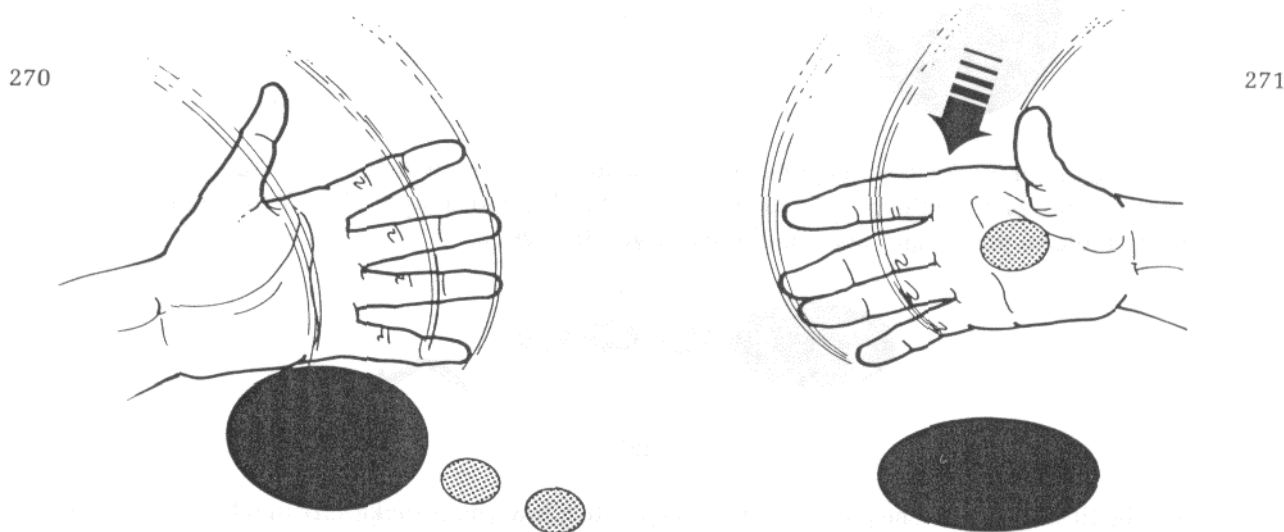

"That's one in the hole and two coins left and I'll try it again with coin number two which goes the same way (is coin [umber one." As you say that your left hand does The Kick Move as described, moving over the hole in a fist afterward. Crumple your fingers and pretend to drop the coin into the hole as you open your hand. "You see I take them out of a bagless purse and drop them into a portable hole - It's very weird."

"Once more the hard way in the other hand - watch it go, and it's gone." Vanish the third coin using Marla's Spider Grip Vanish as taught, your right hand (with the coin in classic palm) moving over the hole, opening its fingers with a downward tossing motion (fig. 271). Your left hand turns palm up as a finishing gesture.

Part Two

"The strange thing is every time I drop them in the hole they appear back inside the purse. Even though there's no bag the coins come back anyway." Your right hand (with a coin in classic palm) picks up the frame and puts it into production position in your left hand. Snap it open with your right thumb and first finger.

Raise your left hand a bit and peer inside the frame. At the same time drop your right hand and allow the classic palmed coin to drop to fingertip rest. Raise your right hand and insert your fingertips into the open frame and cleanly and quickly push the coin past your fingertips and pull it out of the frame.

As you finish the sentence, saying, ". . . even though there's no bag the coins come back. . . ." your right hand drops the coin on the table, snaps the purse shut, and places it back in its previous position on the table to your right.

As you say, "...anyway," do a large palm-up gesture with both hands - the first movement of the Frontal Imp Pass (fig. 272). Drop your hands into your lap - your left hand immediately picks up the coin already there. As you say, "Of course that's only one coin out of the purse. . ." your right hand comes up from beneath the table and gestures palmup toward the frame (fig. 273). Your right hand turns palm down and drops onto the table in Frontal Imp Pass position. As you finish the sentence, saying ". . . that still leaves two coins left in the hole," your left hand loads the coin into right hand thumb palm and immediately moves upward with two fingers extended downward over the hole (fig. 274). Turn your left hand palm up to show it empty, then let it drop onto the table in the same position as your right hand.

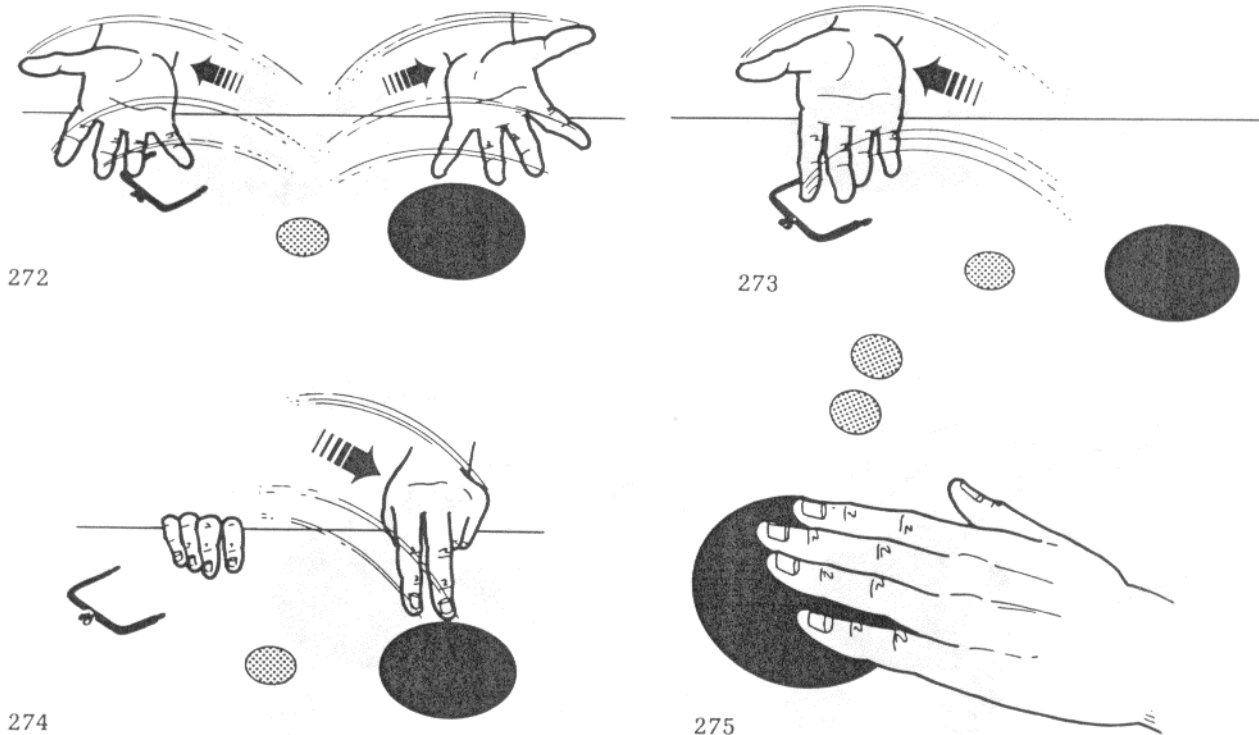

Say, "But if you think about it, even one coin coming. . ." both hands pull themselves onto the table in relaxed fists, the coin in your right hand transferred to fingertip rest. Your left hand immediately moves forward and picks up the visible coin from the table and holds it in palm-up finger palm. As you finish the sentence, saying ". . . out of a purse without a bag is rather bizarre," do The Shuttle Pass, your right hand apparently taking the coin and tapping the empty space near the frame where the bag should be. Your right hand drops the coin onto the table beside the hole (where the row was before).

Continue, ". . . but it isn't as good as two, so there's two." As you talk your right hand lifts the frame and places it into left-hand production position. Snap it open, reach inside and cleanly pull the coin that's finger palmed in your left hand out. Place that coin beside the one already on the table, snap the frame shut, and place it back on the table as before.

(That covering patter line, unbroken, is: "But if you think about it, even one coin coming out of a purse without a bag is rather bizarre, but it isn't as good as two - so there's two.")

You know I once did this trick for a guy who said, 'I know what you're doing - you're hiding the coins under the hole.'" At the same time turn your left hand palm down and pat the hole (fig. 275). The reason for this is so that you can feel where the coins are. It just takes a second. The coin you're really concerned about is the one that was secretly kicked under, and it should be near the center of the hole's right side. (Actually that depends on how hard you kicked it - it might also be in the center of the hole, which is even better, as you'll see in a moment, because then you don't have to adjust the hole as follows.)

"This guy actually thought I was taking the coins and slipping them tunder the hole when no one was looking." As you say that a few things happen simultaneously. Your right hand picks up one of the two visible coins and, holding it on your palm-up fingertips, moves toward the spectators. That provides enough misdirection for your left first finger to press lightly downward on the outer edge of the coin beneath the hole (the one at the inner edge) (fig. 276). That causes the coin's inner edge to rise so your thumb can slide beneath it (fig. 277). Drag the hole a tiny bit to the right until the coin that was kicked under is directly beneath the hole's center (fig. 278). (Of course if it's already there you don't have to do that.)

276

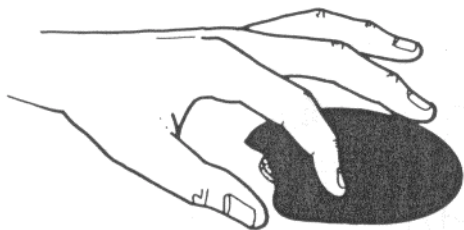

277

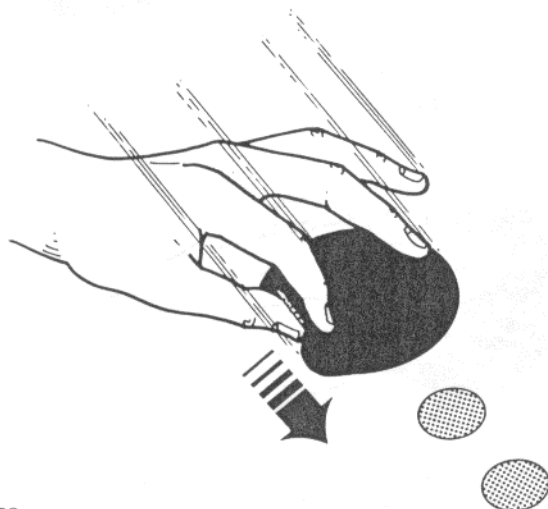
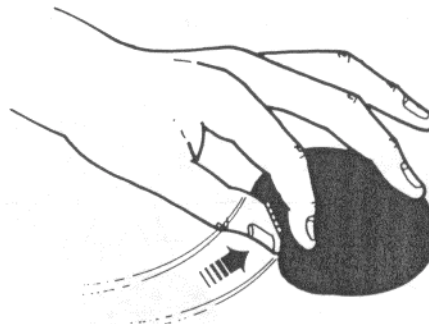

278

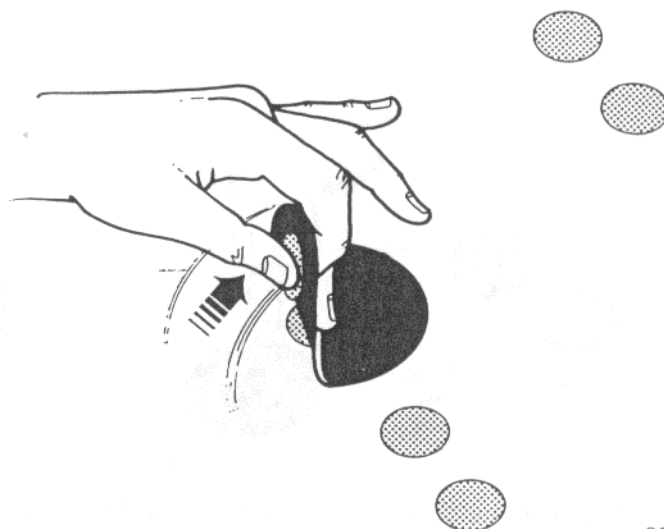

279

Lower your left second finger onto the hole directly above the centralized coin and press lightly downward. Your left thumb and first finger peel the inner end of the hole upward until it can go no farther because your second finger is pressing on it (fig. 279). Say, "If I did that. . ." your right hand turns palm down and maneuvers its coin to between thumb, first, and second fingers. Move that coin behind the hole

280

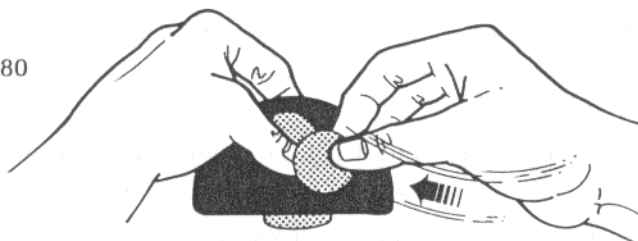

(fig. 280). Do a Retention Pass under cover of the lifted hole, your right hand retaining the coin in fingertip rest. Immediately lift the hole straight up with your left hand, leaving the coin that was beneath your second finger on the table, and say, ". . . you'd see me do it!" Lift that coin with your right hand between thumb and first finger, your left hand laying the hole back on the table afterward.

Drop the coin into palm-up finger palm in your left hand and do a Shuttle Pass, your right hand apparently taking the coin and tapping the bagless area of the frame as you say, "And I already told you they're not under the hole - they're inside the purse." Your right hand tables its coin beside the other visible coin on the table.

Your right hand lifts the frame as you say, "You can't see them or hear them. . . ." Put the frame into production position in your left hand, snap it open, and cleanly remove the coin that's in left-hand finger palm as you continue, ". . . but they're in there, you just have to know how to take them out." Table the coin beside the other two and place the frame back in its position on the table. "So that's three coins, gone and back, dropped into a portable hole." And now, just for you, I'll do the whole thing one more time."

Part Three

The props are layed out exactly as they were at the end of the opening sequence, just before you began Part One. Say, "You remember at the beginning I just took the first coin and dropped it right into the portable hole." Your right hand lifts the coin at the right end of the row in position for a Retention Pass but you're going to do it a bit differently. Hold your left hand palm down, fingers extended and slightly curled, thumb behind them, and move it beside your right hand (fig. 281). Do a fingertip-to-fingertip Retention Pass, i.e., your right hand moves the coin behind your left fingers, your hands forming a V (fig. 282). Do the move, pulling the coin back to fingertip rest, your left fingers moving away as if they held the coin. Your left hand moves directly over the hole and opens to show itself empty. At the same time your right hand settles to the table in a relaxed fist. The above patter line should be said as you actually vanish the coin (like narration).

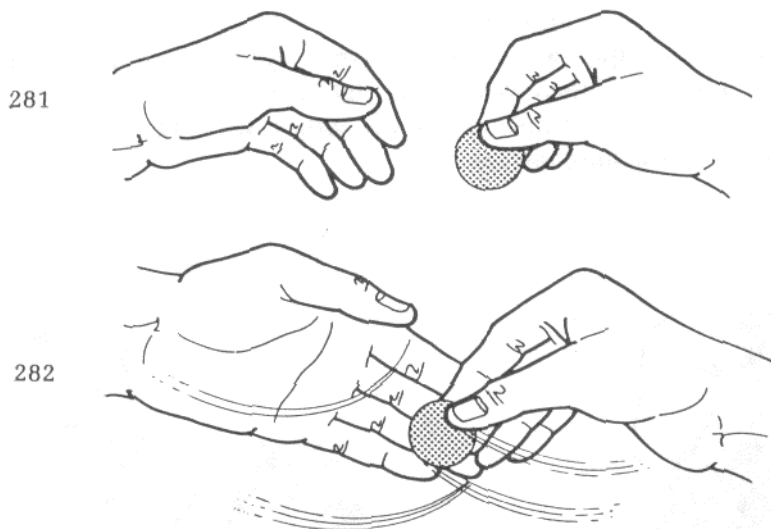

"No, I didn't lift the hole. . . ." Your left hand turns palm down as you lower your first finger onto the outer end of the coin hidden beneath the inner end of the hole. Press lightly downward so the coin's inner end rises and your thumb can slide beneath it. Now, at the precise moment that you say, "lif t the hole, " lift the hole letting it dangle downward (fig. 283). Continue, ". . . A didn't take any coins and hide them under tile hole. . . ." Extend your right first finger and, with it, slide the visible left-end coin beneath the hole - near its left side (fig. 284). It's important that the coin is as far left as possible and still be completely covered by the hole once it's lowered.

Continue, ". . . I simply took the coin and dropped it into the hole. . . ." Lower your left hand so the outer side of the hole is draped on the table. Your left second finger descends onto the coin that you've openly pushed beneath the hole (fig. 285). Your right hand moves behind the lifted portion of the hole and pushes the coin that's in fingertip rest to the fingertips and openly brings it out. Your left hand immediately lowers the hole and pats it flat while your right hand tables its coin beside the hole in position for The Kick Move (fig. 286).

Say, ". . . It was very very simple and it looked just like that." Move your left hand over the left-end coin and do The Kick Move as already taught, propelling the coin beneath the hole as you apparently pick it up, hold it over the hole, and vanish it as you drop it into the hole.

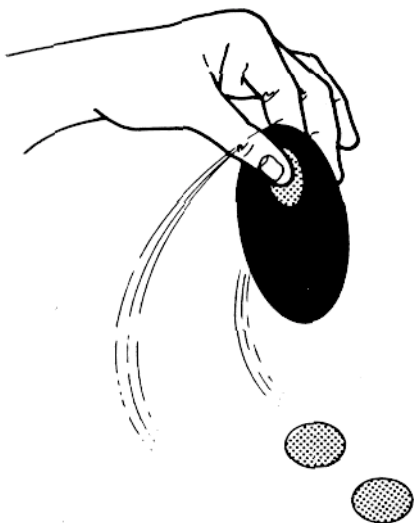

283

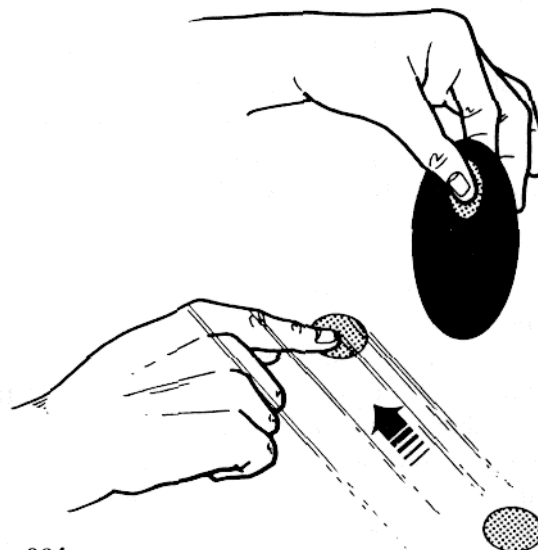

284

"Of course now you know that I take them out of a bagless purse and drop them into a portable hole. Once more, the hard way, long distance - very difficult like that, but it still goes into the hole." Your right hand lifts the remaining coin. Do the same sequence that you did at the very beginning of Part One, where you did a Retention Pass into your left hand and then waved your right hand in a large counter-clockwise circle, lapping the coin (that's "the hard way, long distance" in the patter). Wave your right hand over your left hand, which opens over the hole vanishing the coin.

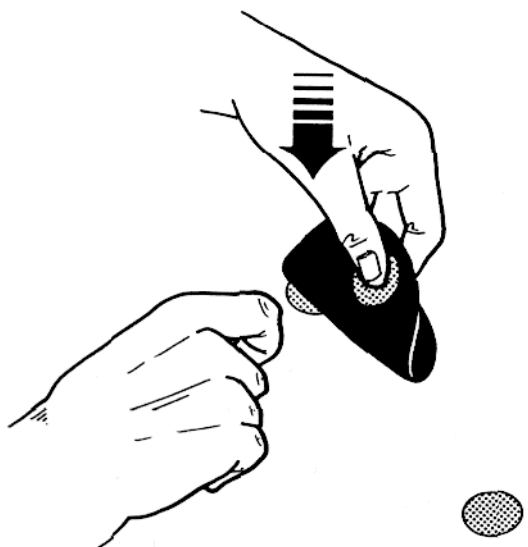

285



286

Say, "The strange thing is every time I drop them into the hole they reappear back inside the purse." Pick up the frame, place it into production position, and open it. "But not this time." Drop the frame onto the table. "This time they're really gone - they're not in the hole or the bagless purse." Pause a second. (You can even lift up a corner of the mat and peek beneath it.)

"Of course there's one more place they could be, and that's under the hole." As you say that your left thumb and first finger cleanly slide back the hole revealing the three coins (fig. 287).

287

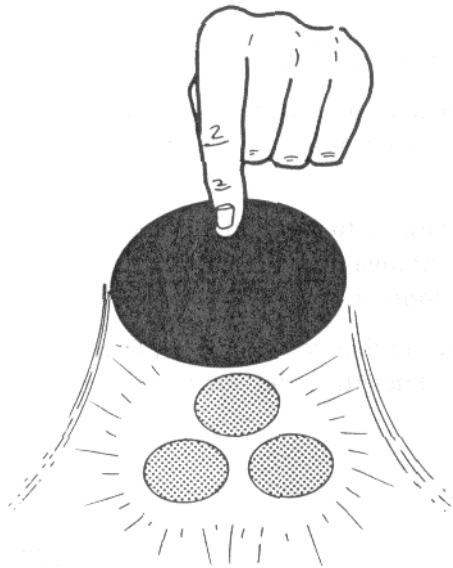

Standup Handling

David emphasized to me that this is definitely not as clean as the handling using lapping - but here, as is already obvious, you can be standing throughout the routine. This is extremely difficult, so be prepared. This sequence replaces Part One and most of Part Two, and you must set up as described after the opening sequence. That is, one coin concealed beneath the inner side of the hole, three coins in a horizontal row just to the right of the hole, each coin about an inch and a half from the hole. The frame rests, closed, on the table to your right, open end toward you.

Turn your left hand palm down and lower it over the left-end coin. Do The Kick Move, propelling the coin beneath the hole while apparently picking it up. Vanish the coin over the hole.

Your right hand lifts the right-end coin and does a Retention Pass into your left hand. Your right hand settles into a fist on the table for a moment afterward, the coin in fingertip rest. As you raise your right hand to wave it over your left hand transfer the coin to classic palm. Your left hand vanishes the coin over the hole.

Your left hand picks up the remaining coin in palm-up finger palm. Do a Shuttle Pass, apparently taking the coin with your right hand - tap the bagless area of the purse. Do a Retention Pass into your left hand, retaining the coin in righthand fingertip rest. Be careful to keep your left fingers curled slightly during this so you don't expose the finger palmed coin.

Make a gesture with your right hand and transfer the coin to classic palm. Open your left hand to show that the coin is still there, and then drop it on the table. Pick it up with your right hand and place it on your left fingertips in Spellbound position for The Thumb Palm Spider Vanish. Like this. Once the coin is in position your right first and second fingers move in front of it, thumb behind (fig. 288). Take the coin with your right hand, turning your left hand palm down and awkwardly extending your left first finger and thumb so the hand appears cramped.

Raise your right hand, your first and second fingers sliding the coin back into thumb palm (as already taught in the first coin switch in Wild Coin No. 1). Move your right hand over the hole and open your fingers as wide as you can while still retaining both coins - one in classic palm and the other in thumb palm (Fig. 289). Note that a small fold of flesh should automatically separate the coins if you've done the moves properly.

Your right hand settles back to the table in a relaxed fist and transfers the coin that's in thumb palm to finger-rest. At the same time your left hand turns palm up to show that it is empty.

Your right thumb and first finger pick up the frame and place it into production position in your left hand. Snap it open and reach inside, pushing the coin to your fingertips and plucking it out of the purse. Table it, snap the purse shut, and place it aside to the right.

Your left hand picks up the just-tabled coin in position for a Shuttle Pass. Do the move, apparently taking the coin with your right hand to tap the bagless area of the frame. Place the coin on the table where the row of coins was before.

Your right hand lifts the frame ("Nothing to see, nothing to hear"), places it into production position in your left hand, and opens it. Cleanly remove the coin that's in left-hand finger palm and table it beside the other coin. Snap the frame shut and table it.

You're now in exactly the same position that you would be in Part Two just before reproducing the third coin ("This thought I kept them under the hole," etc.), so continue from there as described.

288



289

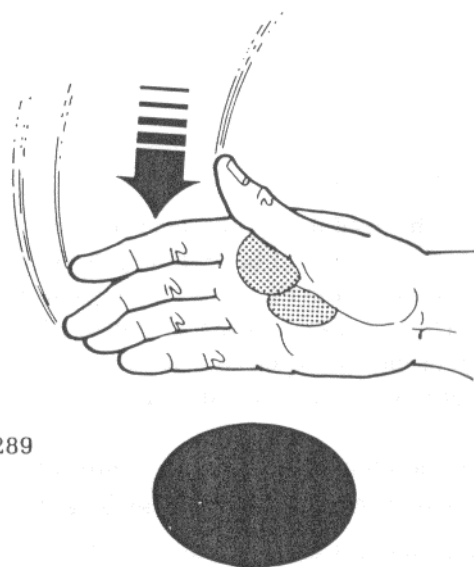

When you reach the end of Part Three and have to completely vanish the last coin you cannot, as in the regular routine, lap it. Any of the "complete" vanishes in Bobo would be appropriate, or you could sleeve the coin.

In Addition: I know you must be confused if you've just read the routine for the first, or even second, time. My head is still spinning from writing it!

Here are the bare bones so you have something to follow once you've got the individual moves down:

- Produce first 2 coins from frame
- Produce third coin from frame (from R. fingertips)
- Do Shuttle Pass
- Produce hole from frame
- Load extra coin under hole and table it
- Do Retention Pass and lap coin
- Do Kick Move

Do Spider Grip Vanish
 Reproduce first coin from frame (from R. fingertips)
 Do Frontal Imp Pass
 Do Shuttle Pass
 Reproduce second coin from frame
 Lift hole's inner end - Retention Pass behind it
 Lift hole completely - slide coin from beneath it
 Replace hole
 Do Shuttle Pass
 Reproduce third coin from frame
 Do Fingertip Retention Pass
 Lift hole and coin beneath
 Openly slide coin under hole - lower hole
 Produce coin from behind hole - table it
 Do Kick Move
 Do Retention Pass and lap extra coin
 Reveal coins beneath hole

David used to end the routine by producing a giant coin from beneath the hole after first revealing the three regular coins. There are no effects using giant coins in this book because I share David's opinion that they tend to detract from the overall effect. In other words, if you produce the giant coin at the end of the routine that is all the audience will remember. You might as well not do the rest of the routine because it's immediately forgotten once the giant coin is produced.

Since David was the first to develop and use the felt hole, and also the first to produce a giant coin from beneath it, I'm going to record his method (which is far superior to any others, published or not).

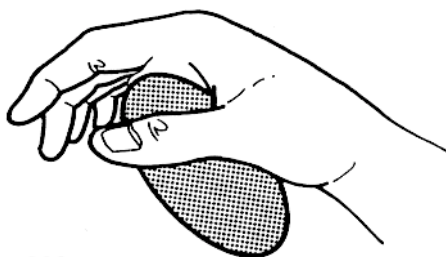

290

The only preparation is to have a giant coin in your lap throughout the routine. It should be placed so that it doesn't interfere with any of the other lapping and retrieving that goes on. Do the routine as described until the end of Part Three. Vanish and lap the last coin, show both hands empty, and pause. Patter and let your right hand drop into your lap. Your left hand grasps the inner end of the hole between thumb (beneath), and first and second fingers (above) and pulls it toward you revealing the three coins.

Back track for a moment. After your right hand drops into your lap it picks up the giant coin in Tenkai Palm (fig. 290). As your left hand pulls the hole toward you begin to raise your right hand until it's above the table edge. You must time this so that your left hand meets your right hand just as it rises above the table, your right hand bending back at the wrist (fig. 291). Your left hand positions the hole directly in front of the coin and immediately grasps the coin between thumb and fingers (fig. 292).

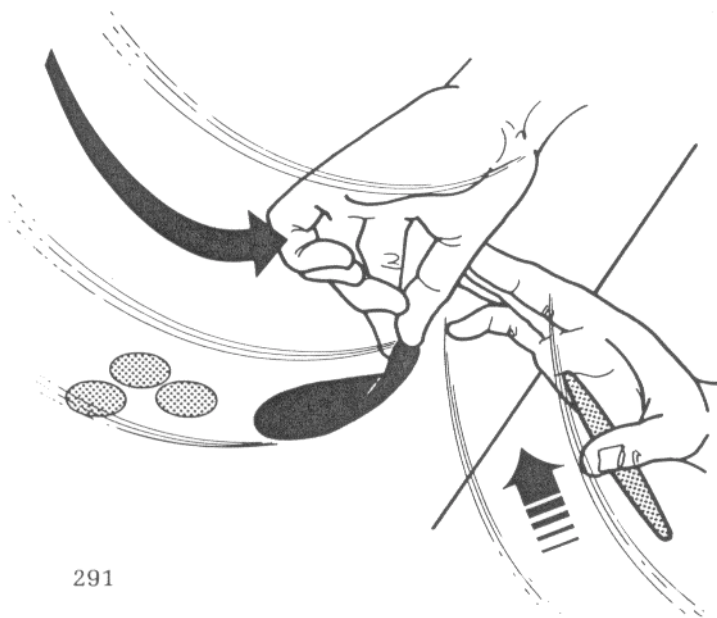

291

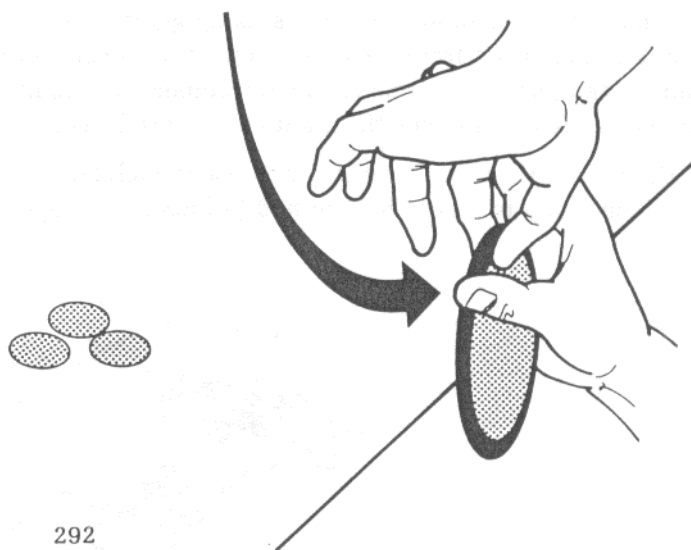

292

Move your left hand forward and place the hole (with the coin now beneath it) on the table, your right hand turning palm up in a gesture. You have perfect cover for the load because all eyes will be on the three coins on the left. Pause for another moment, patter about losing things in the hole, and cleanly draw the hole back to reveal the giant coin.

Resist temptation - don't use this! I know that sounds crazy, but try it out once or twice just to convince yourself that the routine is better without it.

SPELLBOUND

In a Twinkling

Wesley James

Years ago Wes said, "Here's the problem: do a Spellbound type of color change, but it must appear as if you just touch the coin with the tip of your finger - and it visibly changes!" Wes had a method, but he wouldn't show it to me at first because he was interested to see what I could come up with. Here, first, is Wesley's original method. Two of mine, and one of Geoffrey Latta's, follow.

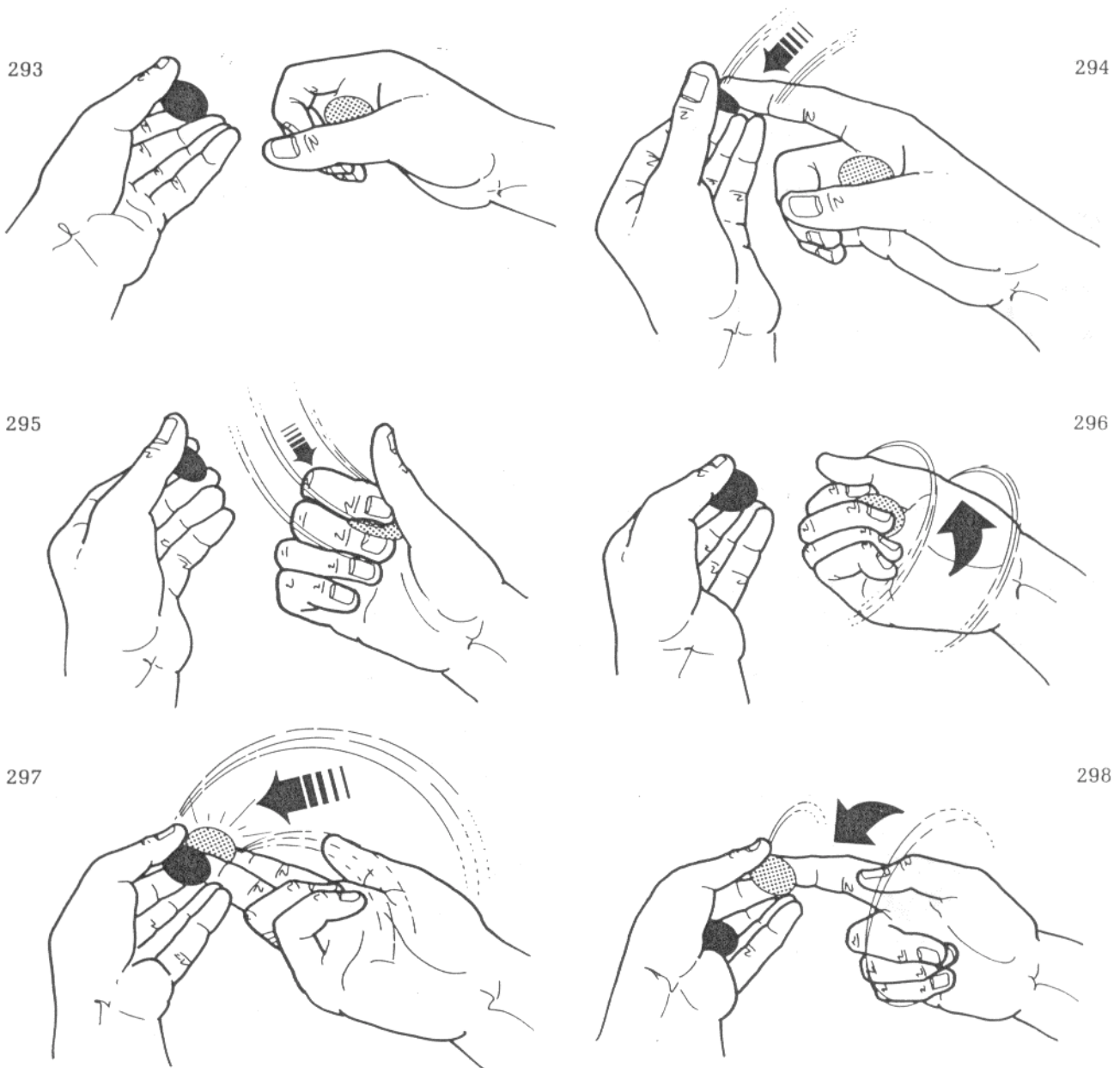

The basic mechanics are fairly simple, but the timing is extremely troublesome. To get into position hold a copper coin in Spellbound position at your left fingertips, and Downs palm a silver coin in your right thumb crotch (fig. 293). At rest position, from which you start, your hands are held in front of you - though

just a bit to your left -and about six inches apart. At rest your right fingers are relaxed and slightly curled.

Straighten your right first finger and tap the face of the copper coin twice (fig. 294). You must move your right hand to the left a few inches to do this, afterward moving it back to rest position, your fingers naturally curling again. Repeat the tapping once more, returning to rest position afterward. As your fingers naturally curl continue the movement, curling them farther. Your first fingertip moves above, and your second fingertip below, the palmed silver coin (fig. 295). Press these fingers together, clipping the silver coin tightly between them.

Now, a few things happen simultaneously. Your right hand starts moving to the left as if you're going to tap the copper coin again, turning palm up as it goes (fig. 296). Your first and second fingers straighten, shooting the silver coin to the left - in front of the copper coin (fig. 297). A split second later your left thumb relaxes just enough to allow the copper coin to fall inside your left fingers. Your left thumb and fingers immediately grasp the silver coin in Spellbound position, your right second finger curls, and your right hand turns palm toward you. Your first finger remains touching the face of the silver coin (fig. 298).

In Addition: Seems simple enough - the problem is to make it look as good as it sounds! The timing is crucial here and the only way you'll learn that is through practice. If your right fingers move quick enough, the spectators won't see the silver coin until it's at your left fingertips. Don't be tempted to try and release the copper coin at the same time that you shoot the silver coin across, because the spectators will see the copper fall. The silver must move in front of it first - then let it fall.

Touch Change One

Richard Kaufman

Here's my first solution to Wes James' challenge. It's not really true to his plot because you rub the coin with two fingers, even though it never seems to be covered from view.

To start, finger palm a copper coin in your right hand as hold a silver coin at Spellbound position at your left fingertips. Relax your right hand, your fingers curling slightly. Move your thumb onto the copper coin and push it diagonally upward and to the left until its upper edge is just below your first finger (fig. 299). Move your first finger inward a bit, onto the coin's upper edge, and push it upward a little more. Press downward with your first finger, tilting the coin to a horizontal position clipped between your first and second fingertips (fig. 300). All that, of course, takes only a second.

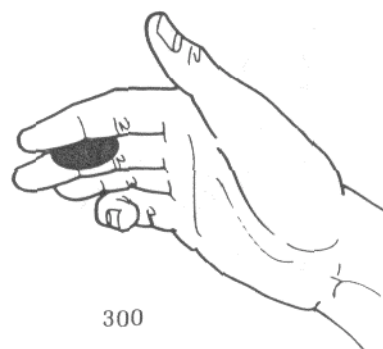
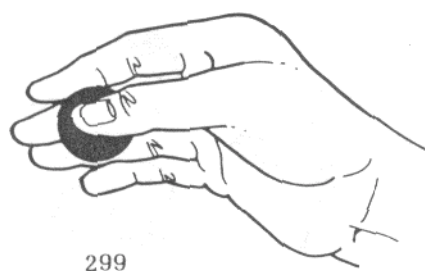

Naturally curl your third and pinky fingers and lift your thumb, moving your right hand beside your left hand, your extended first and second fingertips touching the right edge of the silver coin (fig. 301). Begin rubbing that coin, your second finger circling its perimeter (and your hand moving with it). You'll find that

by slightly curling your first and second fingers you can, while still touching the silver with your second fingertip, move them in front of it (fig. 302).

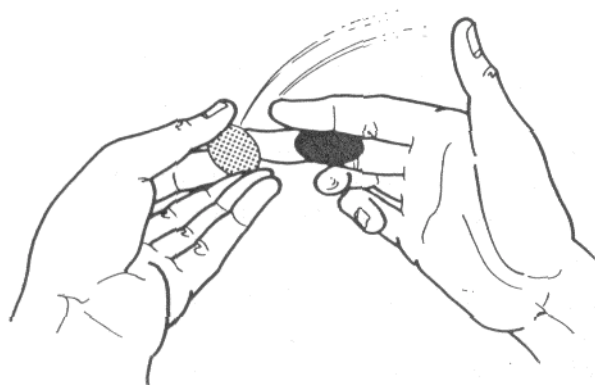

301

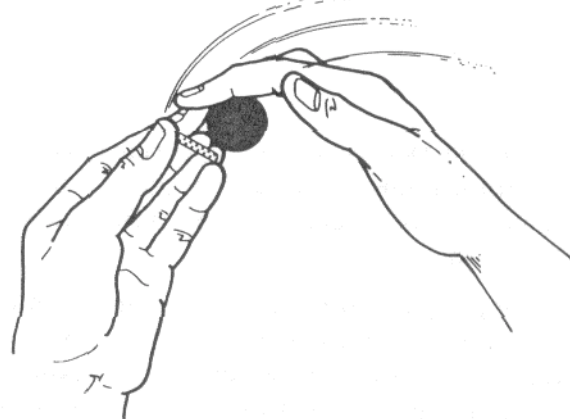

302

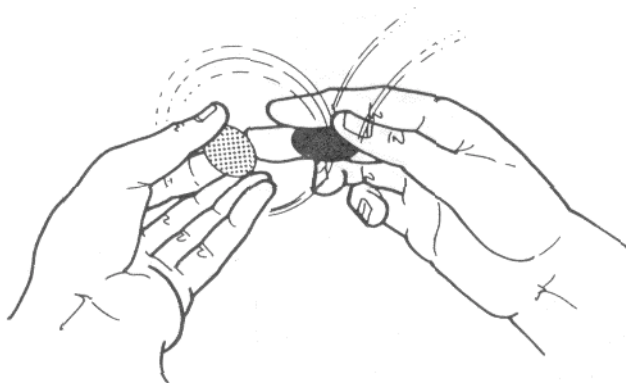

303

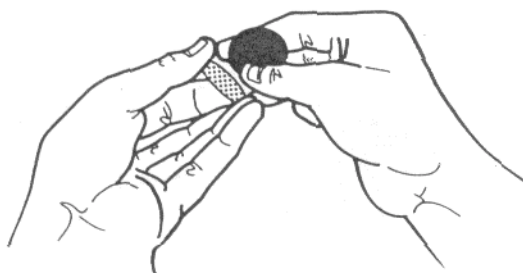

304

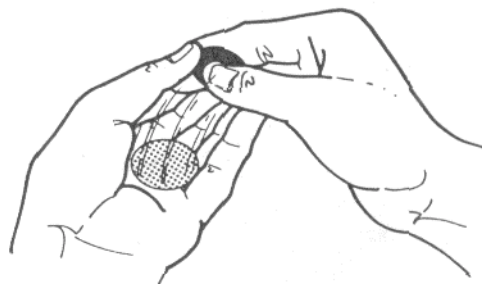

305

As you rub, lower your right thumb onto the copper's inner edge (fig. 303). When you reach the position shown in figure 302, and your second finger is at the extreme left edge of the silver coin, your right hand will obscure most of the silver from the audience. Your hand stays in that position for only a second - and it'll seem even less once you get it to flow. At that moment your right thumb pushes downward, snapping the copper to a vertical position partially behind your first and second fingers (fig. 304). It's directly in front of the silver coin. Your right hand immediately moves back, placing the copper into Spellbound position (fig. 305). Quickly move your right hand to the right, your second finger dragging along the face of the copper coin.

Touch Change Two

Richard Kaufman

To prepare, Downs palm a copper coin in your right hand and hold a silver coin in Spellbound position at your left fingertips. Your hands begin in a position very similar to Wesley's original method. Move your right hand to the left and extend your first finger. Touch the silver coin and then retract your right hand to rest position.

You're going to tap the silver coin again, while simultaneously loading the copper into position for the change (which occurs on the third tap). Relax your thumb and allow the copper coin to rest on the upper side of your curled second finger. Begin to straighten your first finger, simultaneously uncurling your second finger, carrying the copper coin on it until it can be grasped between your thumb and first finger (fig. 306). Without pausing continue your right hand's to-the-left movement and tap the silver coin with your first fingertip.



The copper coin is completely hidden from the spectators by your first finger. Move your right hand back to the right for just a moment, and then move it to the left again. This time it moves slightly farther than before so that your first finger moves completely across the face of the silver coin (fig. 307). Actually, as you can see in the illustration, both the copper coin and your thumb are also in front of the silver - but that isn't visible to the audience.

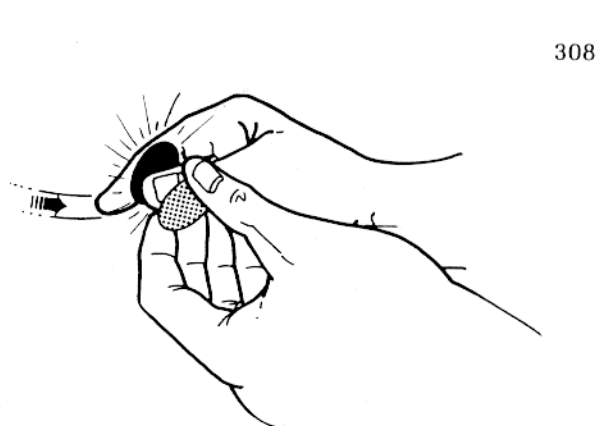
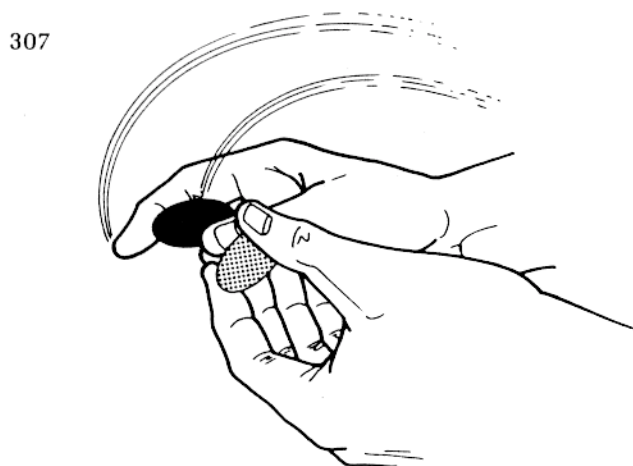

Pinch the copper between your thumb and first finger, snapping it to a vertical position (fig. 308). Without pausing your right hand moves backward, your thumb knocking the silver coin inside your left hand, and leaves the copper in Spellbound position. Immediately move your right hand away revealing the copper coin.

Touch Change Three

Geoffrey Latta

There's a silver coin finger palmed in your right hand and a copper coin in Spellbound position at your left fingertips. Your hands are about six inches apart. Start moving your right hand to the left, extending your first finger to tap the copper coin. As your hand moves your thumb pushes the silver coin upward (fig. 309). Simultaneously curl your second, third, and pinky fingers so the silver comes to rest horizontally on the upper side of your second finger (fig. 310). Move your thumb onto the right edge of the coin (fig. 311).

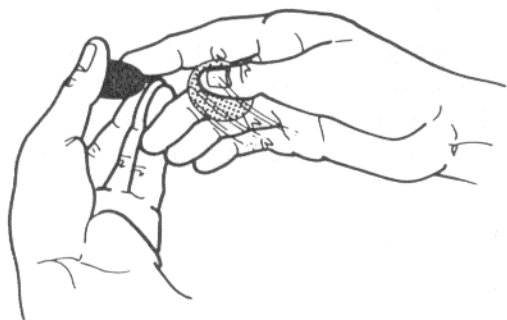

309

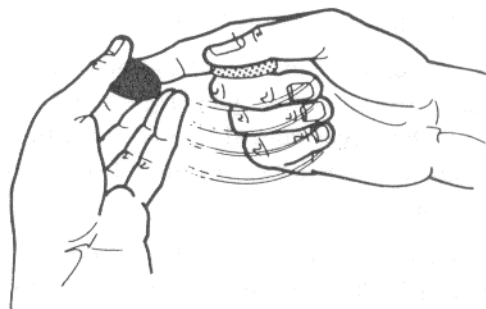

310

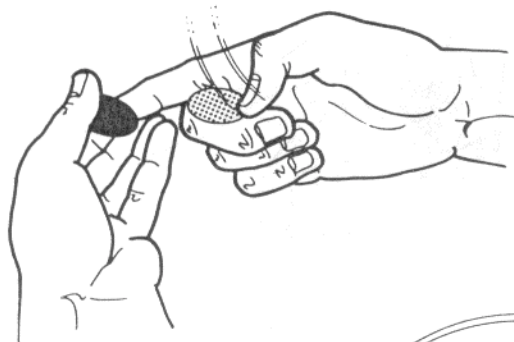

311

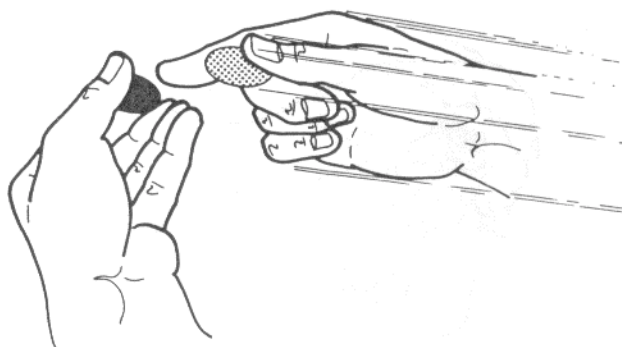

312

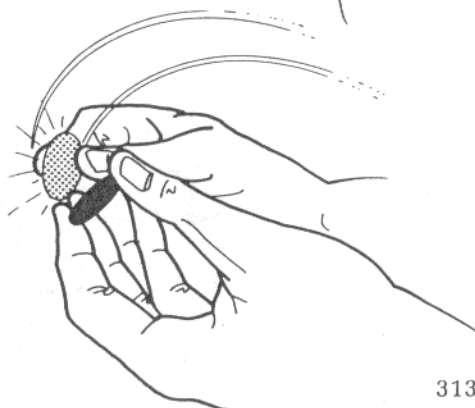

313

All that takes only a second, and should be done by the time your first finger taps the copper. Tap it once more, moving your right hand back to rest position afterward. As you start to move your right hand to the left again, for the third time, your thumb pushes the silver coin to the left (fig. 312). Once the coin has passed completely over your second finger it will snap to a vertical position held between thumb and first finger. Your thumb continues pushing it to the extreme tip of your first finger.

You must time your right hand's action so that the silver coin pops into view at the first fingertip just as your first finger reaches the copper coin (fig. 313). A second later your left thumb relaxes and lets the copper fall inside your left hand while your right hand guides the silver coin into Spellbound position and then moves away.

Spellmell Bound

Richard Kaufman

I saw David Roth do a continuous Spellbound change a few years ago - in other words he simply kept passing his hand over the coin and it kept changing. No pauses, grip changes, etc. He tipped it to me, but won't let me print it! Very frustrating. Here's my version, with his blessing. It's a continual change without any grip-changing - and it bears absolutely no resemblance to David's.

There's a copper coin finger palmed in your right hand, and your left hand holds a silver coin in Spellbound position. Move your right hand to the left, your right thumb moving behind, and your fingers in front of, the silver coin (fig. 314). Continue to move your right hand until the silver coin is in your right thumb crotch. Bend your thumb tip over the coin to hold it in place - flatly against the length of your thumb (fig. 315).

Start moving your right hand back to the right, your left fingers taking the copper coin from finger palm on the way (fig. 316). Separate your hands to show the first change.

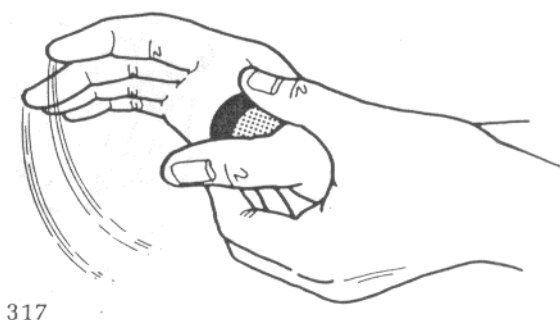
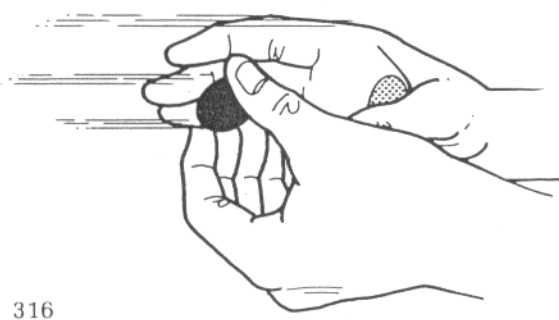
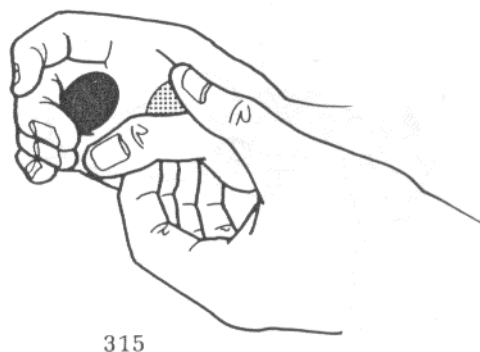

Move your right hand around the copper coin, your thumb behind it and your fingers in front of it as before. Your left thumb and fingers guide the copper into your right thumb crotch in front of the silver (fig. 317). Note that the coins are parallel with each other, about an eighth of an inch apart. Move your left thumb

and fingers together gripping both coins in their parallel positions. Bend your right hand inward at the wrist, pressing the copper against your thumb crotch (fig. 318). By slightly pressing your right thumb and first finger together at the base you'll find that you can grip the copper coin there as your left hand moves to the left and displays the silver coin (fig. 319).

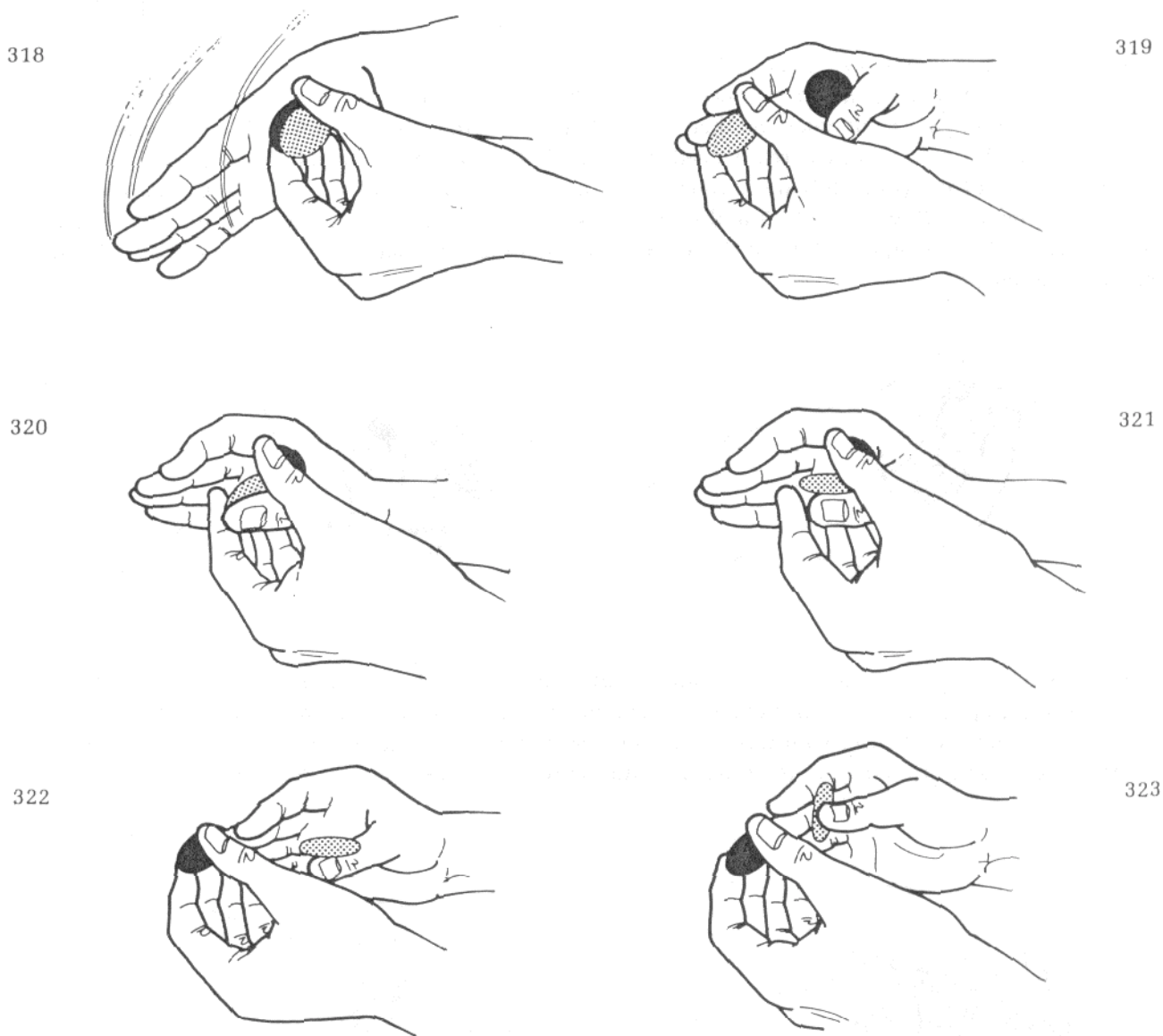

Move your hands together for the third change, your right fingers covering the coins from the front and your right thumbtip coming to rest on your left fingers directly behind the silver coin (fig. 320). Relax your left thumb allowing the silver coin to fall backward, resting horizontally on your right thumb (fig. 321). Continue moving your left hand to the right. It grasps the copper coin in Spellbound position and moves to the left displaying it (fig. 322). The silver coin remains balanced on your extended thumb, concealed behind your right fingers.

Move your right thumb behind your right fingers, pressing the silver coin flatly against them (fig. 323). Move your right fingers in front of the copper, the back of your thumb knocking it into your left hand. Press the silver coin into Spellbound position and move your right hand away revealing the fourth change.

Twisting With Victor

Wesley James

Very often when you're trying to build a good Spellbound sequence you'll come to a point where one coin rests inside your left hand and another is held at Spellbound position. What you usually have to do is place the visible coin in your right hand and then do the change with the other hand. That's always seemed both awkward and illogical. What you really need is a move that will enable your right hand to secretly steal one of the coins back from your left hand so you can continue with the sequence. That's what this move does. It's based on a sleight of Edward Victor's and also bears some resemblance to a Ken Krenzel item that appeared in print several years ago. Neither of those, however, had the steal-back, which is what makes Wesley's handling so useful.

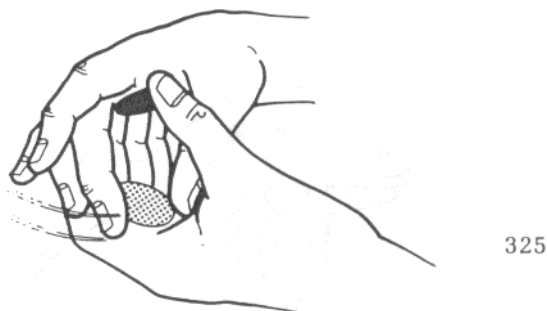
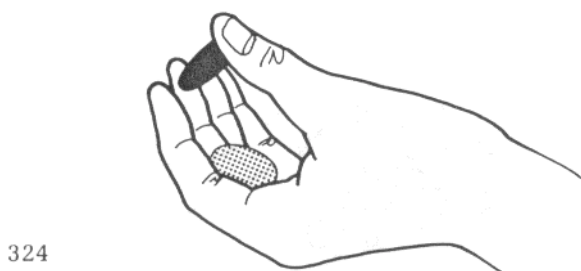

To start, a copper coin is held in Spellbound position in your left hand; another, silver, coin rests inside your left fingers (fig. 324). Your right hand, held palm toward you, moves in front of your left hand covering the copper from the audience. Your right thumb moves onto the right edge of the silver coin while your right second finger curls around from the other side and moves onto the left edge (fig. 325).

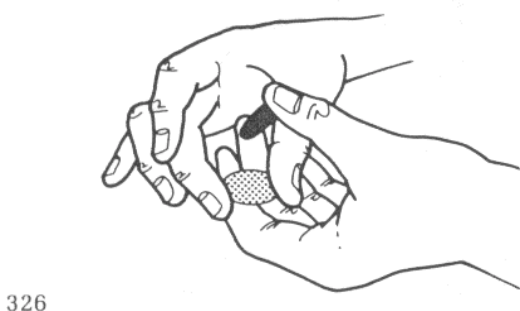

Your thumb and second finger lift the silver as your right hand moves to the left until the copper is pressing into your right thumb crotch (fig. 326). Pinch your thumb and second finger together, snapping the silver coin to a vertical position (fig. 327). When you do that your right thumb will automatically flatten against your right hand - gripping the copper in thumb palm. Your right hand moves to the right, taking the copper coin and, as smoothly as possible, leaving the silver in Spellbound position.

The Inertia Change

Tom Gagnon

Tom was inspired by John Cornelius' Metamorphosis Change which appeared in print years ago. Tom's version uses only one copper/silver coin (John's original used two regular coins) which is secretly reversed as your hands are waved over it.

328

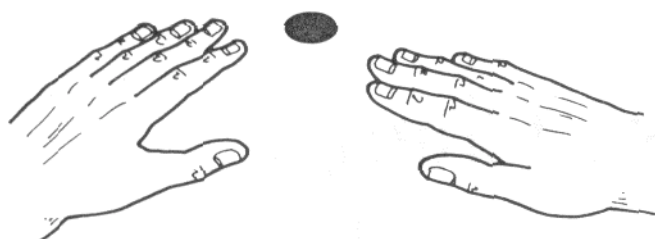

329

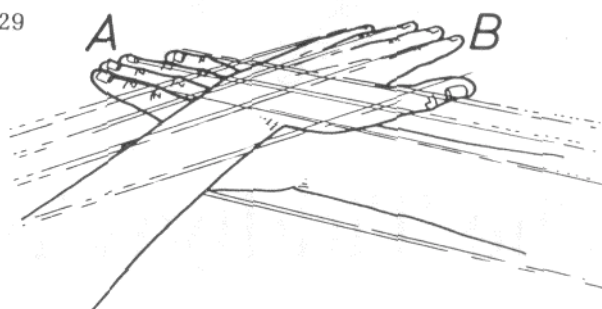

Place a copper/silver coin onto a close-up mat about six inches from the mat's inner edge. For teaching's sake let's say that it's copper side up. Show your hands completely empty and turn them palm down, Rest them on the mat about two inches to either side of the coin (fig. 328). Look at figure 329, which shows how you'll move your hands as you wave them over the coin. Your right hand crosses over the coin moving outward and to the left to position A, while your left hand crosses outward and to the right to position B. As they pass over the coin your right hand moves beneath your left hand. Do that once, moving your hands to A and B and then back again.

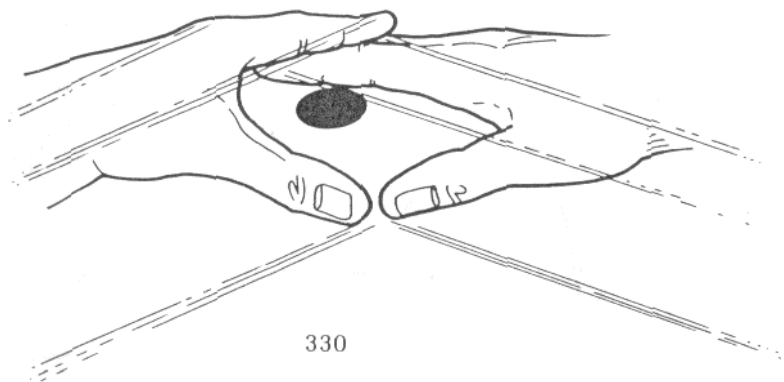

330

This time when you repeat that action the tip of your right second finger will strike the coin, flipping it over. In more detail: Begin the action again and, for now, pause when your hands are over the coin, your right hand beneath your left hand (fig. 330). Bend your right second finger inward so that its tip rests on the outer left edge of the coin (fig. 331). That's where your second fingertip strikes the coin (is it's moving. Move your hands back to starting position. Start the wave movement and, just as your right hand passes beneath your left hand, bend your second finger inward. A split second later it'll pass over the coin, striking it (fig. 332). Your hands continue to move without pausing, your right second finger immediately straightening again. Move your hands back to starting position, revealing the coin's change.

In Addition: A number of things combine to cause the coin to turn over when your second finger hits it your right hand's momentum, the "give" of the close-up mat, and the sudden release of pressure as your second finger snaps off the coin's edge. Your left hand covers all the dirty work from the audience, and the coin's flip over is instant.

331

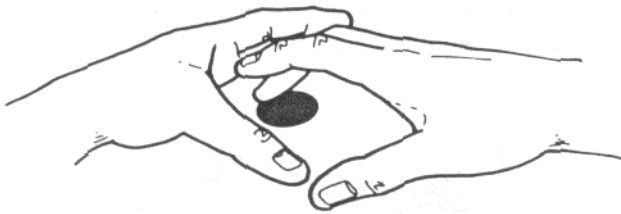

332

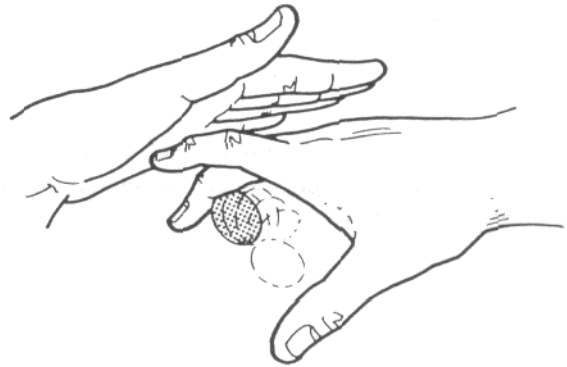

The Tiddlywinks Change

Tom Gagnon

Tom tells me that laymen flip over this, and I can understand why. It's an instant visible change beneath a glass that's as clean as you could want. You need a copper/silver coin, a close-up mat, and a shot glass whose inside is large enough to allow a coin to flip over inside it.

333

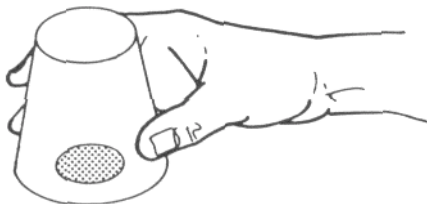

334

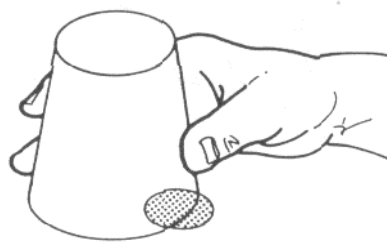

335

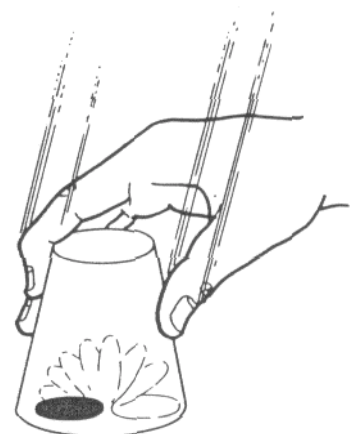

Place the coin onto the mat silver side up. Show your hands empty and place the glass mouth down over the coin (fig. 333). Your right hand lifts the glass and your left hand points to the coin. This time, when your right hand lowers the glass over the coin, leave a tiny bit of the coin's inner edge protruding from beneath the glass (fig. 334). Press downward on the inner end of the glass. This will, with some practice, cause the coin to snap upward and turn over while inside the glass (fig. 335). If the coin won't turn over the first few times you try it, try drawing the glass slightly toward you while it's pressing downward on the inner edge of the coin - then, when the coin snaps out from beneath the edge of the glass it should flip over. As you can see in the illustration the coin flips over toward the audience.

You can also perform the change on the palm of a spectator's hand! Tom also uses it for the following effect. Use a double-headed half dollar, and glue a miniature card to one side. Place the coin on a spectator's palm (unprepared side up). Cover it with the glass. Now, force the duplicate of the miniature card on the spectator (he selects it with his other hand, etc.). After he's looked at it, and replaced it, etc., do the Tiddlywinks Change and the miniature of the spectator's selection magically appears on the coin trapped beneath the glass.

Geoffrey Latta has developed two routines, *Glassed-In Attraction* and *Impossible Under Glass CS Switch*, which use Tom's move and are in his section of the book.

Spin to Win

Mark Levy

Mark showed this to me at least four years ago. It uses any copper/silver coin and is an instant change. Take a copper/silver coin and set it on edge on a table, held between your left thumb and right first finger in about-to-spin-it position (fig. 336). The copper side is toward the audience - it should be the only side they've seen up to this point.

336

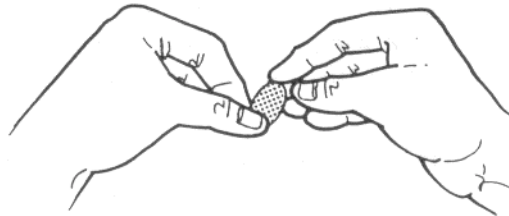

Quickly separate your hands spinning the coin as rapidly as possible (fig. 337). As the coin spins only the darker, copper, side will be visible - the silver side cannot be seen! Smack your palm-down right hand over the coin, flattening it onto the table. Slowly lift your hand. Either the coin will now be silver side up revealing a color change, or copper side up. If it's the latter simply pick up the coin, spin it, and smack it down again. This time it should be silver. If not, do it again. It only takes a few seconds each time. If it still hasn't fallen silver side up by the third try you're cursed: pack your bags and head for the hills before the ceiling falls in.

337

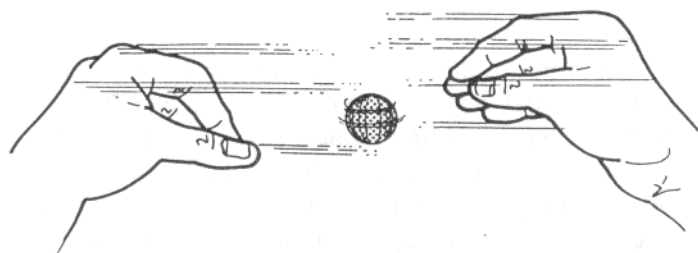

It's a perfect illusion. There's no question that only one coin is involved, and both sides of it are apparently seen in a very casual manner.

Silver Slippage

Bruce Berkowitz

This is a for-magician's-only sequence. You apparently do a normal Spellbound sequence and then the coin falls into your hand and hits another with a loud clink. When the coins are looked at the audience discovers they're both the same color.

The handling on this is finicky because it's based a lot on personal hand size. I'll teach it exactly as Bruce does it - though I'm warning you in advance that some of it may seem awkward. You must fiddle with the positions of the coins, and the tilt of your hands, etc., to get it to work smoothly.

To set up, classic palm a silver coin in your left hand. Also finger palm a copper coin in the same hand. Your right hand holds another silver coin in Spellbound position. To perform, straighten your left fingers moving your thumb onto the copper coin to hold it in place. Move your left fingers in front of the visible silver coin. Let the silver coin fall backward into right-hand finger palm. Your left fingers push the copper coin into Spellbound position, and your hand moves away to reveal the change.

Tilt your right hand to a completely palm-up position - the silver coin should automatically flip backward (toward you) and fall into classic palm (fig. 338). At the same time squeeze your right thumb and fingers together, snapping the copper to a vertical position. Also at the same time your left hand transfers the classic palmed extra silver coin to finger palm. (Simply let it drop to fingertip rest and then thumbpush it up to finger palm.)

Do a standard Spellbound change, your left hand covering the copper coin. The copper drops to righthand finger palm and the extra silver coin is left at your fingertips (fig. 339).

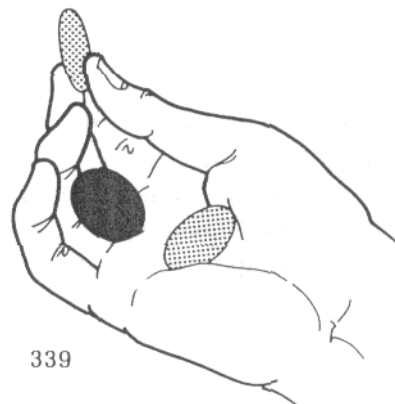
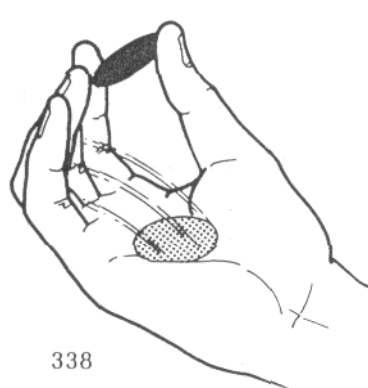

Turn your right hand palm down and your left hand palm up - place the visible silver coin into Spellbound position at your left fingertips. Separate your hands for a moment, moving your right thumb onto the finger palmed copper coin to hold it in place. Move your hands together, your right fingers covering the silver coin. Let the silver drop into left-hand finger palm and leave the copper in its place. Move your right hand away. Transfer the extra silver coin in your right hand from classic to finger palm. Move your hands together, your right fingers moving in front of, and your thumb moving behind, the copper coin in position for Vernon's classic original move. Your right hand moves to the left until it can grasp the copper coin in thumb palm. It immediately reverses direction, leaving the silver coin between your left fingers.

After you've separated your hands pause for a moment. Extend your right first finger and smack the visible silver coin into your left hand. It should hit the one already there with a loud clink. Open your hand to reveal two silver coins.

**The
SOL STONE
Section**

Turnover Vanish

Sol Stone

A visually deceptive coin vanish that's based on choreographed handling. Hold a half dollar on the first and second fingertips of your palm-up right hand. Your left hand is also palm up, just beside it (fig. 340).

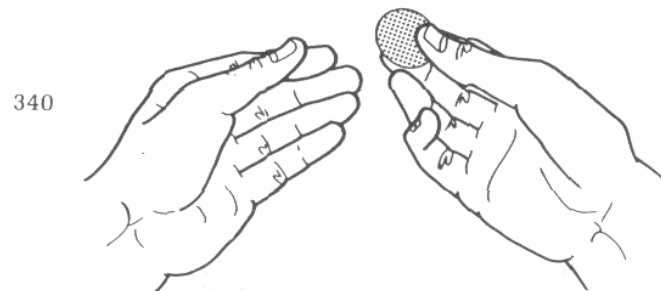

Turn your right hand over and place the coin onto your left first and second fingertips, your thumb moving onto it to hold it in place (fig. 341). Simultaneously turn your right hand palm up and your left hand palm down, placing the coin onto your right second and third fingers (fig. 342).

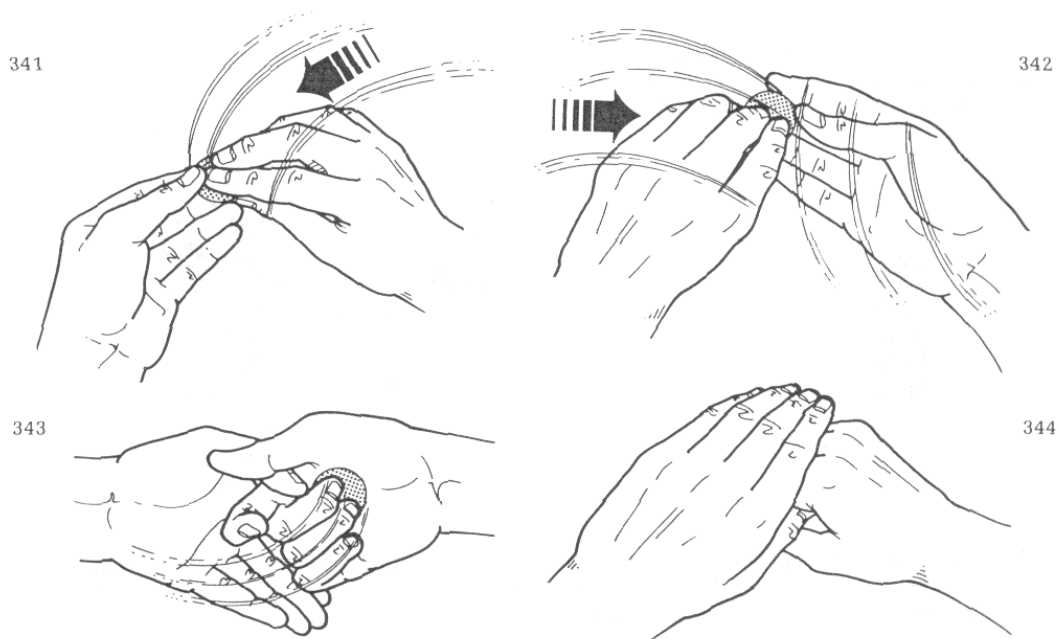

Begin turning your right hand palm down, at the same time curling your fingers so the coin goes into classic palm. Keep your left thumb partially in the right thumb hole as the right hand turns over (fig. 343). As soon as the coin is in palm drop your right fingers a bit and slide your left thumb into your right hand as far as it can go, your straightened left fingers over the back of your right hand (fig. 344).

Straighten your right fingers and, at the same time, draw your left hand away from you along your right fingers as if taking the coin (fig. 345). Curl your left fingers into a fist as the hand turns palm up, at the same time relaxing your right hand (fig. 346). Open your left hand to reveal the vanish.

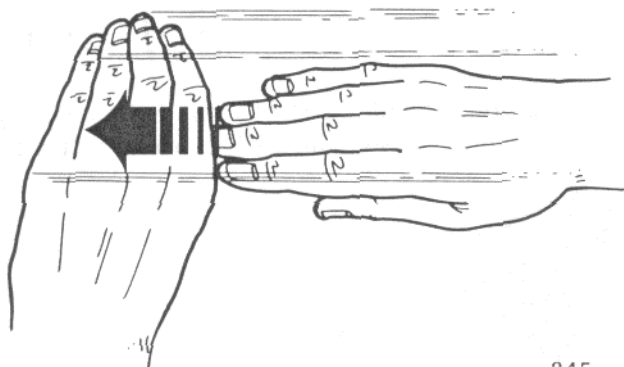

345

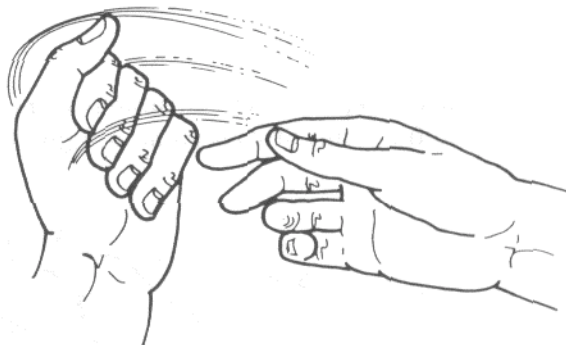

346

Ramsay Vanish Refined

Sol Stone

John Ramsay's vanish is a beautiful move - but you don't see it done too often because of the knack it takes to acquire. It's also just plain tough to do well. Sol, however, does it terrifically, and with just a slight change in technique you'll be able to do it too.



347

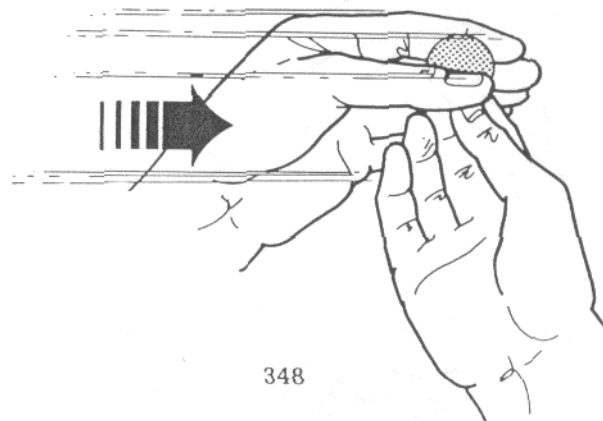

348

Your palm-up right hand holds the lower edge of a coin between thumb (on the inner side) and fingers (on the outer side) (fig. 347). Your left hand, held palm toward you with its fingers together and straight (though naturally curled) moves in front of the coin, your left thumb moving behind it (fig. 348).

Move your left hand far enough to the right so that you can touch the tip of your thumb to your second finger (fig. 349). Now, move your left hand directly to the left, your thumb and second finger knocking (pivoting) the coin downward into your right hand (fig. 350). Curl your left fingers into a fist and turn your right hand palm down. Open your left hand to show that the coin has vanished.

In Addition: Your right hand's grip on the coin must be very loose. If it's too tight the coin won't sink past the tops of your fingers in time and will be exposed.

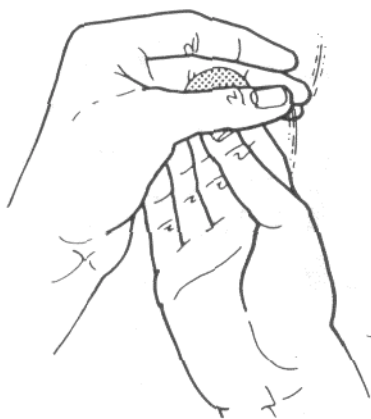

349

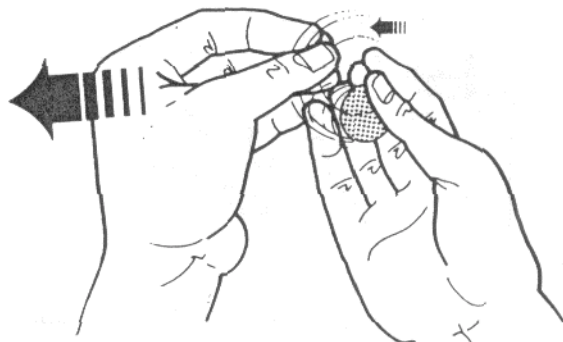

350

One-Hand Spectator Sleeve Change

Sol Stone

Sol first published his Soft Slewing technique in Apocalypse, but he didn't give away this revolutionary application. You must be standing, wearing a jacket, prepared to sleeve a coin. A half dollar is displayed between your right thumb and fingers and an English penny is finger palmed in the same hand.

Ask the spectator to stand on your left side and extend his or her left hand (fig. 351). Transfer the silver coin to solely between your right thumb and first finger as you turn your hand palm down (fig. 352).



351

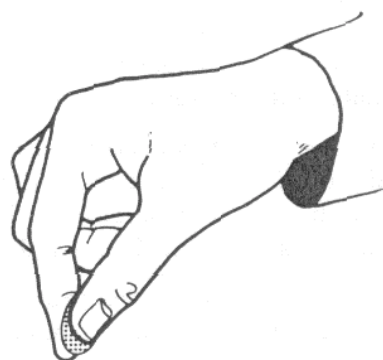

352

Take the spectator's palm-down left hand with your left hand and guide his thumb into your right thumb hole (fig. 353). As soon as his thumb is inside your hand rub your first finger briskly toward you against your thumb, snapping it backward and shooting the coin up your sleeve (fig. 354).

That'll take some practice because you have to be able to gauge the pressure of your first finger's snap, and the tilt of your hand, etc., so the coin flies unimpeded up your sleeve. Immediately move your thumb onto the finger palmed copper coin and push it to your fingertips (fig. 355).

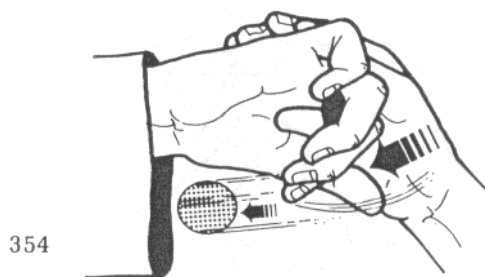
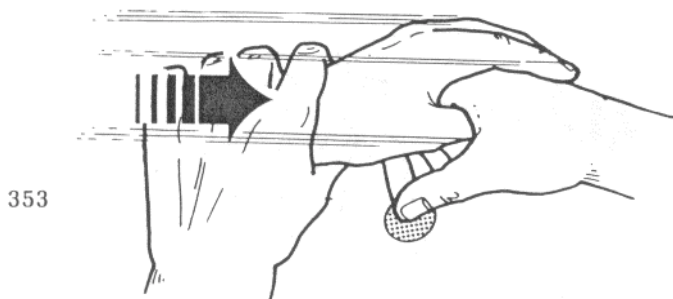

Your left hand guides the spectator's hand around your fingers to a palm-up position (fig. 356). Release the coin into his hand and press his fingers flatly closed.

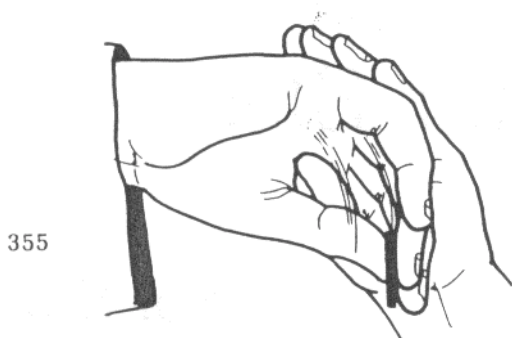

That's it - conclude as per whatever routine you're doing. The spectator will naturally assume he holds the silver coin.

Tumble Switch/Change

Sol Stone

This is an easy utility move, but you'll have to practice to make it smooth. It's the flow of the action that makes it deceptive. A silver coin is thumb palmed in your right hand and your left fingers hold a copper coin between thumb, first, and second fingertips.

Your palm-down right hand is held with your fingers pointing to the left, and your palm-up left hand is just to the left of it (fig. 357). Slide your right hand over the copper coin until it's in finger palm (fig. 358 in which the right hand is transparent). Curl your right fingers very slightly taking the copper into finger palm. Immediately start turning your right palm toward you (fig. 359).

As your right hand turns your left first and second fingers will automatically come up behind the thumb palmed silver coin (fig. 360). Your thumb moves onto the side of the coin that's facing you, completing the grip (fig. 361).

Your left fingers pull the silver out of thumb palm and move it to the left (fig. 362). At the same time your right hand turns partially palm up, and your left hand turns the silver coin over and lays it on your right first and second fingertips (fig. 363). Your right thumb rapidly moves onto the silver coin and completes the grip, your right hand turning over and placing the coin on your left first and second fingertips (fig. 364).



357

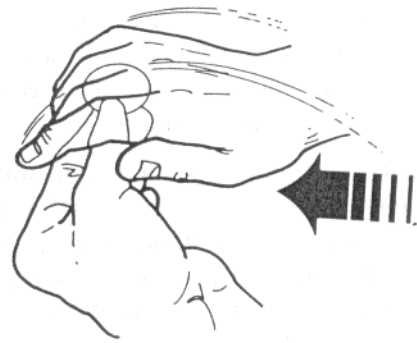

358

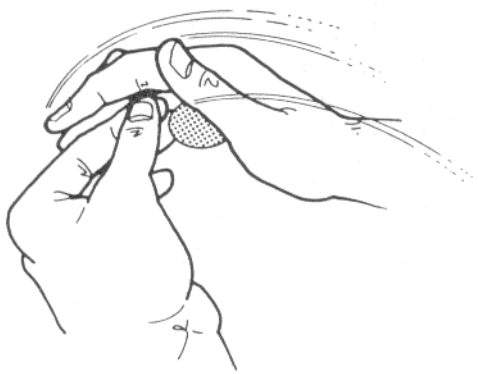

359

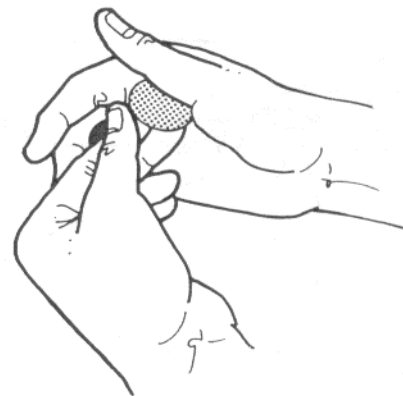

360



361

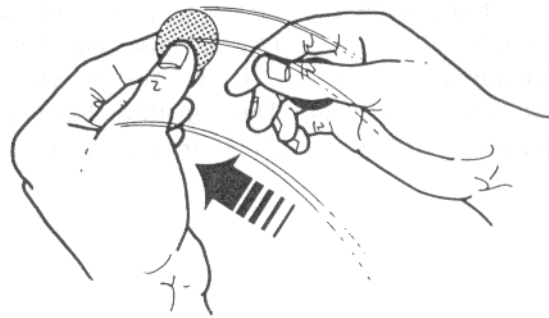

362

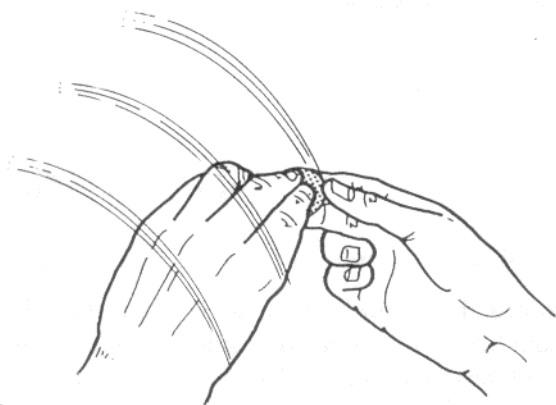

363

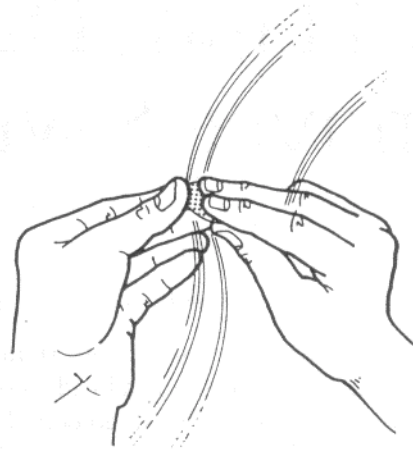

364

Now, depending on how you're going to utilize this, you also have to be able to do the same sequence in reverse. It's difficult to do backwards so take your time. Like this. Start at the exact same position as in figure 364, where you finished the sequence. Your palm-down right hand is still holding the silver coin, which rests on your left fingertips. Your right hand turns the coin over, turning palm up, at the same time your left hand turns palm down to grasp it between thumb, first, and second fingers.

Your right hand starts to turn palm down and stops for a second when your palm is facing you. Simultaneously your left hand turns palm up and places the silver coin back into right-hand thumb palm (fig. 365). Without pausing finish turning your right hand palm down, flattening it and laying the finger palmed copper coin onto your left fingertips (fig. 366). Retract your right hand, moving it to the right, revealing the copper coin. Turn your left hand over to display both sides of the coin.

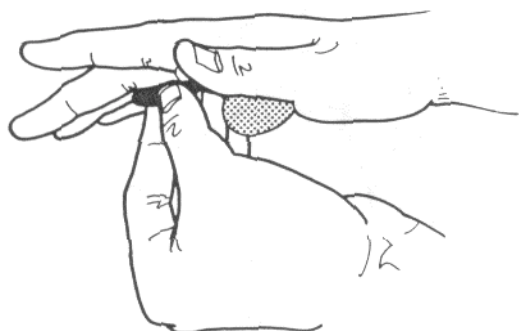

365

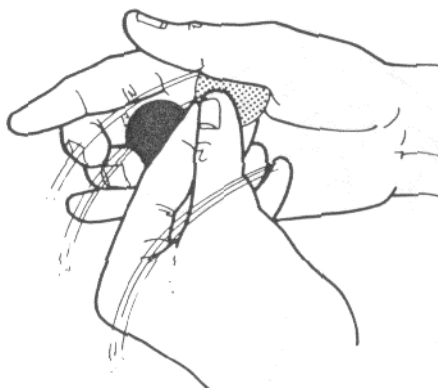

366

In Addition: I can only repeat myself: it must be done smoothly - think of a tumbling action. To use the move as an invisible switch, have a copper/silver coin finger palmed (silver side against your fingers) in your right hand. Your left hand holds a silver coin between thumb, first, and second fingers. Turn your right hand palm down and grasp the visible coin between your right thumb, first, and second fingers in position to begin the reverse sequence. Do everything backwards as already described and, when your right hand eventually slides to the right the gimmicked coin will be on your left fingertips silver side up.

One Hand Thumb Palm Turnover Switch

Sol Stone

Sol's been using this for over thirty years. It's a smooth one-hand exchange of one coin for another.

Finger palm a copper/silver coin in your right hand silver side against your fingers. Let's assume that the silver side of the gimmicked coin is a head. A regular silver coin lies on the table, tails side up. Your palmdown right hand moves over the tabled coin. Lower your thumb onto its inner end and press downward, enabling your first and second fingertips to slide beneath it (fig. 367).

Pull the coin upward with your thumb until your first fingertip extends completely across the face (fig. 368). Curl your first finger, sliding the coin upward along your thumb into thumb palm (fig. 369). Once the regular coin is securely gripped in your right thumb crotch straighten your right fingers and slap the gimmicked coin onto the table (fig. 370). Lift your hand showing the head side.

With a bit of practice the switch is undetectable.

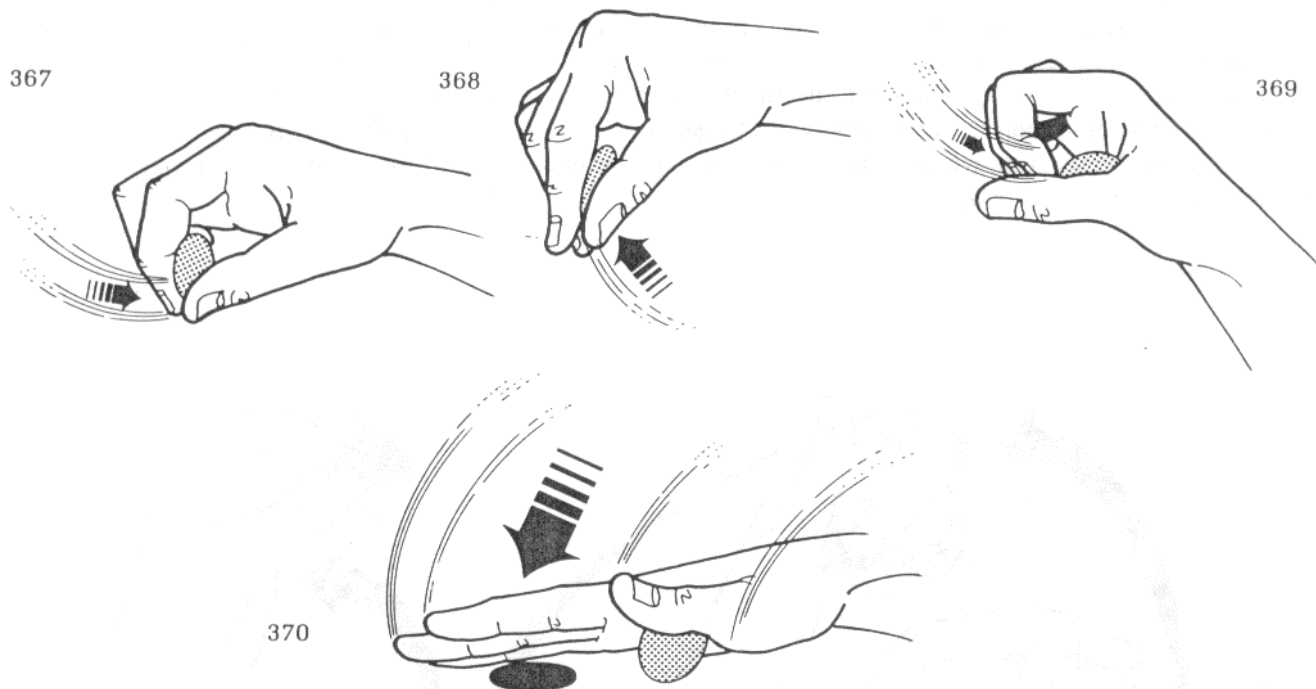

One-Hand Triple Spellbound No. 1

Sol Stone

Sol has two methods for this routine - this one uses a gimmicked coin, but the one that follows does not. This is also the simpler of the two. To prepare, a copper/silver coin is Downs palmed in your right hand crotch and your right thumb, first, and second fingers hold a brass or Chinese coin (fig. 371). You can flash



the empty right palm to the audience by bending your hand backward at your wrist, being careful, of course, not to flash the Downs palmed coin. Afterward turn your right palm toward you and tilt your fingers upward (fig. 372). The audience sees the backs of your fingers throughout the routine.

Two things will be happening at the same time during the routine. Your fingers will move the coins and your hand waves slightly up and down to cover the action. Everything must be exactly coordinated or the larger action of your moving hand won't be sufficient to cover the smaller action of your moving fingers. Let me give you an idea of the hand motion. You'll count, "One, Two, Three," as you do the change. On "One" you'll raise your hand, on "Two" you'll lower it, and on "Three" you'll raise it again.

On "One" (the first upward swing) your third finger moves onto the brass coin beside your second finger. At the same time your second finger moves behind the coin beside your thumb (fig. 373). Your thumb and first finger release the coin as you slightly straighten your second finger flipping the coin's edge toward you, the coin clipped between your second and third fingertips (fig. 374). Note that your first finger has also moved beside your second finger. Curl all your fingers inward. The Downs palmed coin goes between your first and second fingertips while, at the same time, your second and third fingers move the brass coin into lower Downs palm (fig. 375).

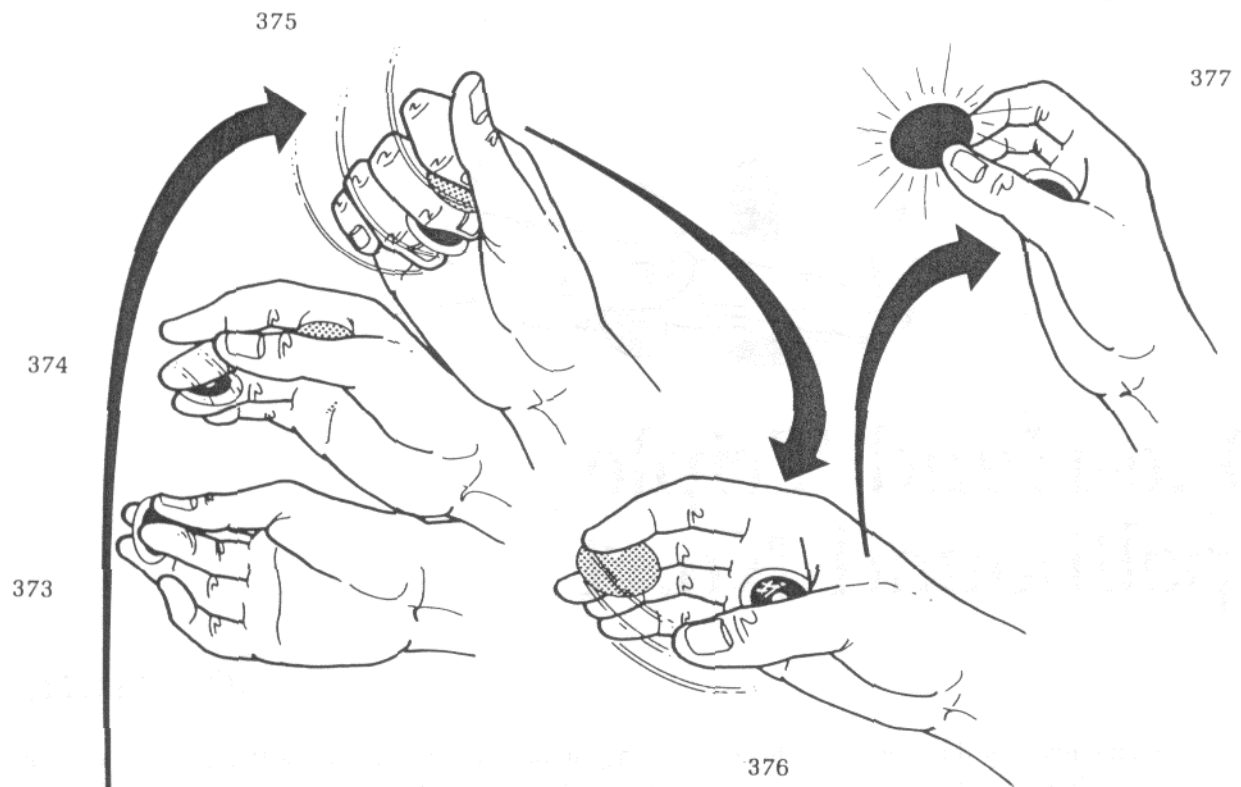

On "Two" (the downward swing) your thumb moves over the brass coin completing the Downs grip, and your fingers straighten with the clipped copper/silver coin (fig. 376).

On "Three" (the second upward swing) your thumb simply moves beneath the copper/silver coin and flips it face toward audience (fig. 377). Either side can face them.

That's the first change and with a bit of practice you'll be able to do it like Sol - instantly. The second change is much simpler; your thumb turns the copper/silver coin around so that its other side faces the audience. There's a little technique to it, and it's done with the same one-two-three up and down hand

swing. On "One" your first finger moves to the coin's inner side (fig. 378). Your thumb moves away allowing the coin to turn sideways, clipped between your first and second fingertips (fig. 379), On "Two" your thumb moves beneath the coin and flips its unseen side toward the audience, pressing the coin against your first finger. Your second finger, which will have been on the inner side of the coin after your thumb turns it, moves to the outer side next to your first finger (starting position).

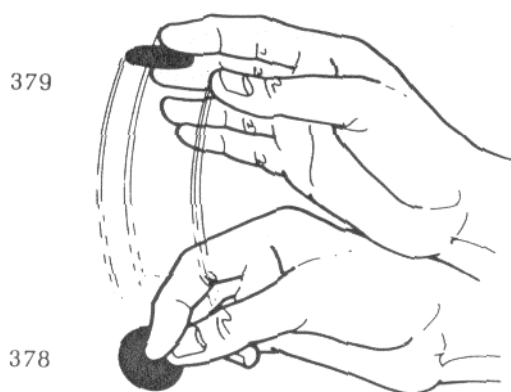

The change back to brass is the exact reverse of the first change. In other words, on "One" the copper/ silver coin is clipped sideways between your first and second fingertips. Curl your fingers inward, your first and second fingers depositing the copper/silver coin in Downs palm while your second and third fingertips clip the brass coin. Your thumb moves over the copper/silver coin completing the grip. On "Two" your fingers straighten, carrying the brass coin outward and leaving the copper/silver coin behind. On "Three" your thumb flips the brass coin back to starting position face toward audience. Turn it around a few times to display both sides and then hand it out for examination.

One-Hand Triple Spellbound No. 2

Sol Stone

This is the better method of the two because the palm of your hand (apparently empty) is toward the audience throughout the changes - it's also very difficult. Before you get involved with the triple change, which really just involves classic palming a third coin during the rest of the sequence and producing it at the end, I'll teach it as a copper to silver and back again change.

To prepare Downs palm a copper coin in your right hand and hold a silver coin between your right thumb, first, and second fingertips (fig. 380). Your hand is held palm toward audience at all times. Twirl the silver coin around a few times, your thumb moving beneath it and flipping it over to display both sides. End by leaving the coin in starting position.

Phase One

This change, like the preceding one, must be done in a one-two-three up and down wave of your hand (or, if your hand is directly in front of you, fingers pointing toward the audience, a right, left, right swing). On "One" (the first swing to the right) your second finger moves onto the coin's inner side. Your thumb moves away and your second finger straightens, flipping the coin's edge toward you (fig. 381). After the coin has turned your thumb should rest on the edge facing you (as in the illustration).

On "Two" (the swing to the left) your first and second fingers curl inward. Your thumb holds the silver coin in place so that it moves behind your curling fingers (fig. 382). Your fingers curl until you can clip the copper coin between your first and second fingers (fig. 383). Your thumb continues moving the silver coin farther behind your fingers as long as they curl - it goes into regular back clip.

On "Three" (the last swing to the right) your fingers straighten carrying the copper coin into view (fig. 384). The silver coin is concealed behind your fingers between the first and second joints. Your thumb immediately moves beneath the copper coin and flips it flatly against your first and second fingers (fig. 385).

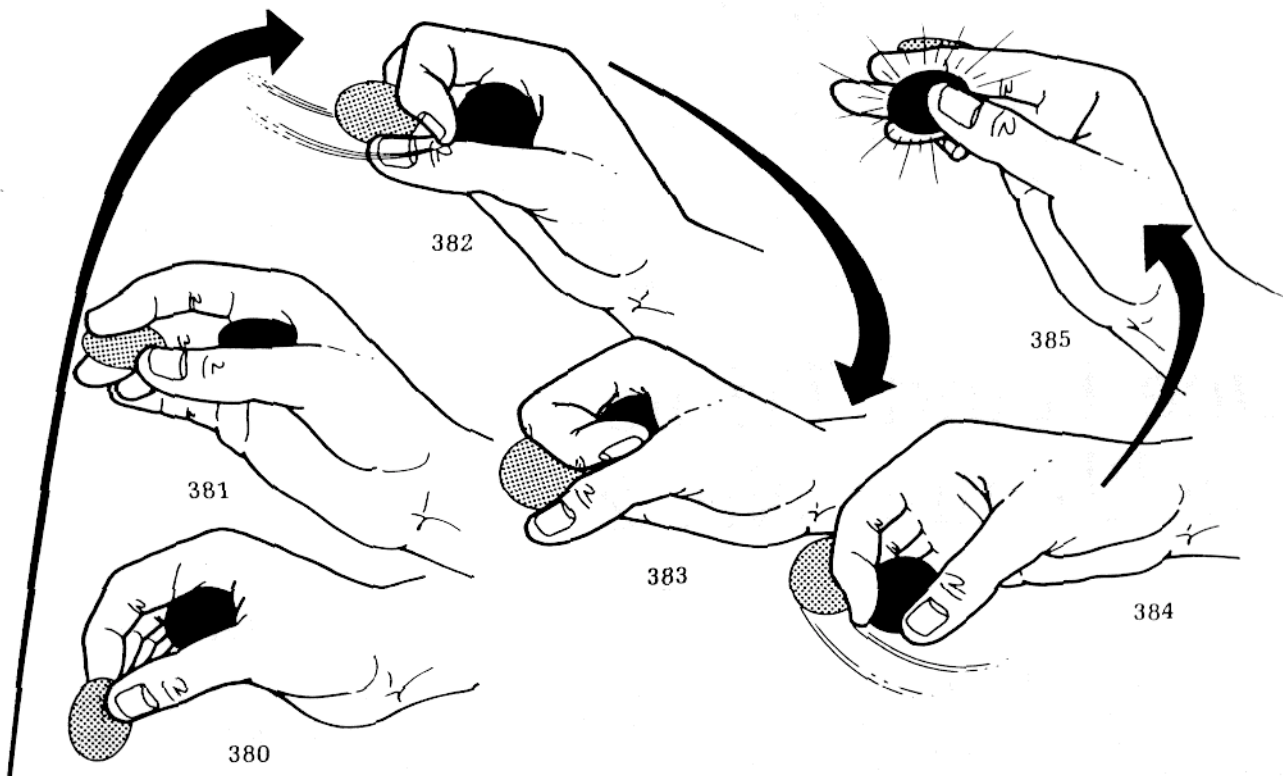

That's the first change, which also puts you in position for the repeat sequence which comes next. You'll eventually get a feel for the back clipping of the silver coin. You'll be able to feel its edge between your first and second fingers and you'll know when you've pushed it back far enough so that it won't show between your fingers on the front side.

Phase Two

This move has been previously described in Tarbell No. 7 in a different context. The second change also takes place during the same right-left-right hand swing. On "One" your third finger reaches up behind your hand, onto the upper side of the back clipped silver (fig. 386). Without pausing your third finger pulls the coin downward flipping it around and clipping it between your second and third fingertips (fig. 387). Continue to curl your fingers inward (fig. 388).

On "Two" your thumb and first finger move the copper's lower portion behind your second finger (fig. 389). Now begin to straighten your fingers, your second finger pushing the copper coin sideways, clipped between first and second fingertips (fig. 390). Note that your thumb remains on the edge of the copper throughout. Curl your fingers inward your thumb pushing the copper to back clip (fig. 391). As your thumb finishes pushing the copper it'll be in perfect position to move onto the edge of the silver (fig. 392 is an exposed view).

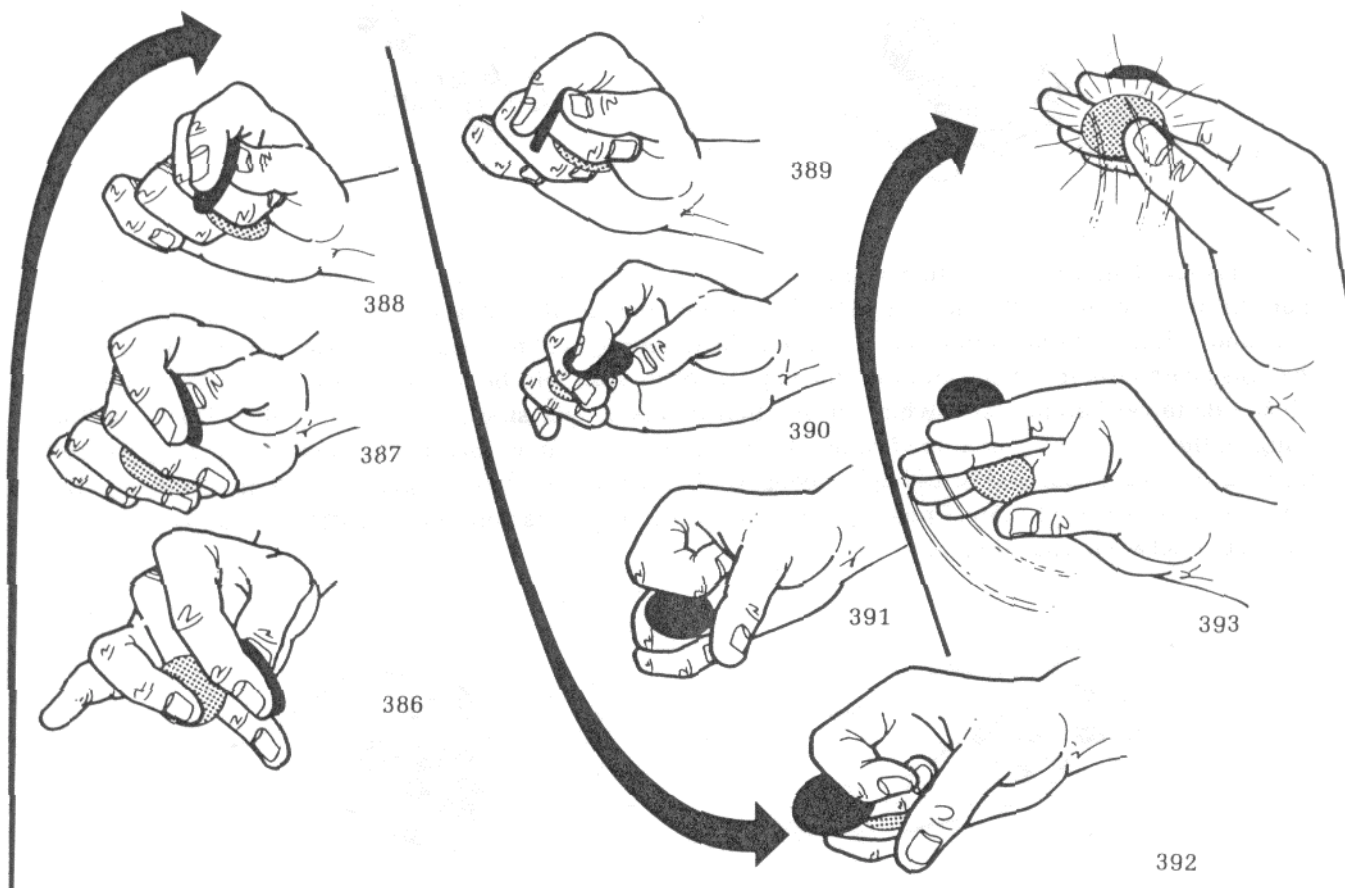

On "Three" straighten your fingers, your thumb holding the silver coin in place (fig. 393). Your thumb completes the action by flipping the silver upward flatly against your first and second fingers - starting position.

You probably don't believe that this can be done invisibly, but it can. When you can do it fairly rapidly with a smooth right-left-right wave of your hand the finger actions become invisible. Don't forget that on "One" you go right, "Two" you go left, and "Three" you go right again.

Repeat the change again, back clipping the silver and leaving the copper visible.

Phase Three

This will leave you back in starting position with the copper in Downs palm and the silver coin visible. Begin the second change (Phase Two) as already described, your third finger pulling the silver coin down to between second and third fingertips and clipping the copper between first and second fingertips (refer back to fig. 390). Now, instead of pushing the copper into back clip your fingers simply curl inward moving the copper into Downs palm (fig. 394). That's the position you should be in at the end of the second movement (to the left). On "Three" your fingers straighten. The copper coin is left in Downs palm and your thumb holds the silver coin in place (fig. 395). Your thumb pushes the silver up and you immediately start twirling it between your first and second fingertips.

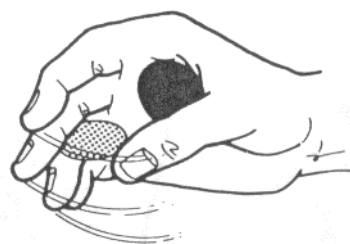
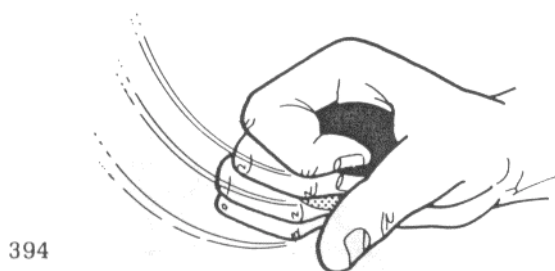

Sol has two handlings to do this as a triple change. One uses three regular coins - we'll get to that in a moment. It's obvious that by making one of the coins (the one that starts in Downs palm) a copper/silver coin, and holding a brass coin in view to start, the following will happen. On the first change (Phase One) the brass coin goes into back clip and the copper/silver coin will be brought into view (let's assume it's silver side toward audience - which means that it was copper side up in Downs palm). Do Phase Two bringing the brass coin back into view and back clipping the copper/silver coin. Do Phase Two again back clipping the brass coin and bringing the copper/silver coin into view copper side toward audience (this happens automatically). Now, finish by doing Phase Three Downs palming the gaffed coin and twirling the brass coin between your fingers.

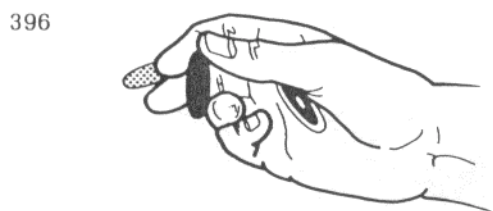

Relatively speaking, that's simple enough. To do it with three regular coins is, let's say, more interesting. You start with a brass coin classic palmed in your right hand, the copper coin Downs palmed in the same hand, and the silver coin held at your right fingertips in position as described. Do Phases One and Two as taught (Phase Two is done twice), ending with the copper coin visible at your fingertips and the silver coin back clipped. As you move your hand in the same up-downup movement your third finger moves in front of the copper coin's lower portion (fig. 396). Let go with your thumb and straighten your third finger, flipping the copper sideways. Your thumb moves onto the copper's edge as you curl your fingers, pushing it to back clip between your second and third fingers (fig. 397). Once your fingers are completely curled relax your palm and let the brass coin fall onto your fingertips. Your hand should be open by the end of the third movement (the last upward swing) displaying the brass coin on your fingertips (fig. 398).

Sol cleans up by coming over with his left hand. His left fingers clip the back clipped coins (fig. 399). His left fingers turn the brass coin over and leave it on his right fingers, then he lowers his left hand and curls it.

The angles are a bit different when you do this triple change because of the brass coin concealed in classic palm. It's really concealed by your right thumb base, which folds over in front of it naturally.

398

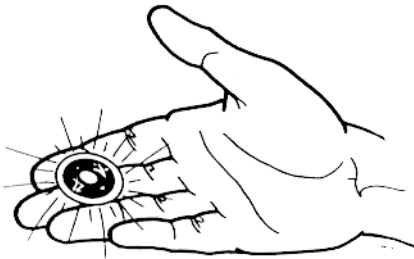

399

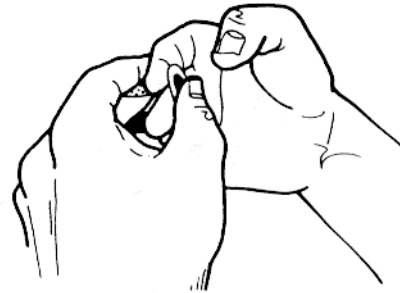

Hung Coin

Sol Stone

This is a much improved standup version of a routine that I originally wrote for Apocalypse, Vol. 1 No. 3. It's an unusual visual item that utilizes some of the back clip switching you've already learned in some of Sol's other effects.

400

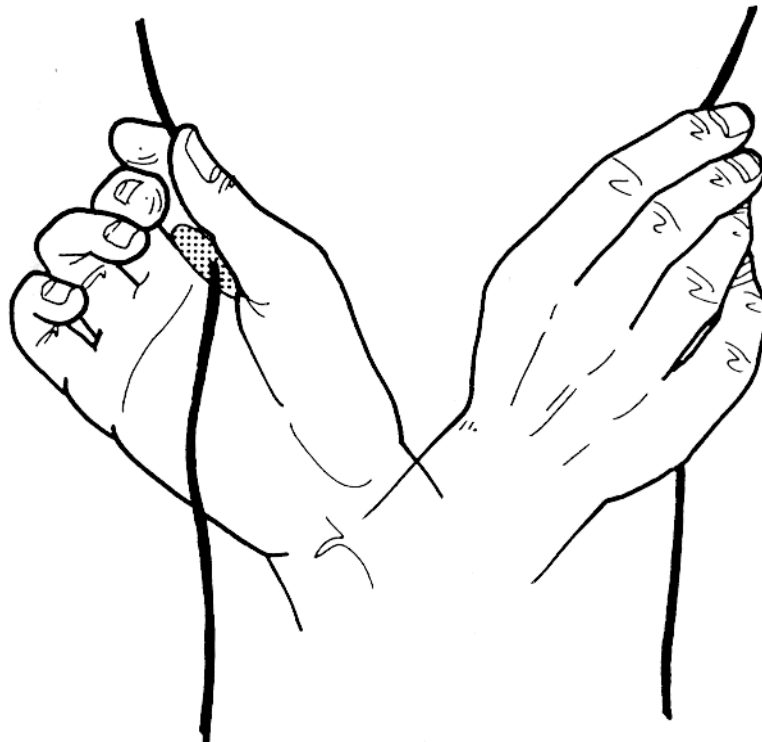

401

You need two identical Chinese (brass) coins with holes in their centers, and a two-foot length of string. You can use a shoelace, or whatever's handy. To prepare, thread one of the coins onto the string and place it into your right jacket pocket. Put the other brass coin in a pocket where your left hand can conveniently retrieve it.

To perform, both hands go into pockets - your left hand to openly get the brass coin, your right hand Downs palms the alreadythreaded brass coin and grasps the near end of the string between thumb and first finger. As your left hand brings out the coin ask a spectator to hold out his palm-up hand to temporarily hold the coin. Your right hand comes out as in figure 400, with the string held as described, and the threaded coin concealed in Downs palm (fig. 401 is the audience view).

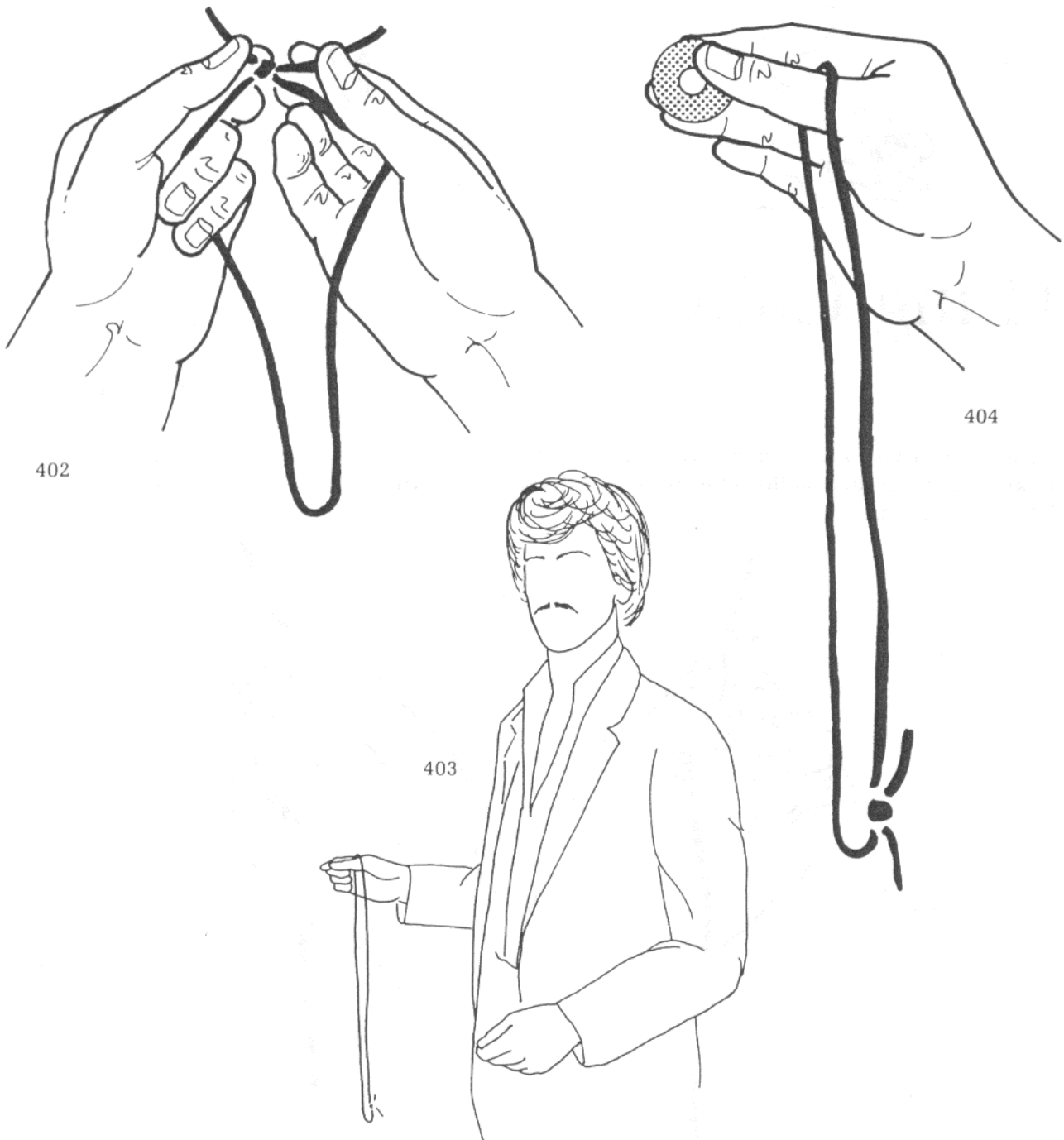

Your left hand grasps the dangling end of the string and brings it up so you can tie the ends together (fig. 402). Once that's done leave the loop draped around your thumb (fig. 403 shows your entire upper body so you can get an idea of the audience view - your empty right palm is toward them). Your left hand picks up the coin and places it between your right thumb, first, and second fingers (fig. 404).

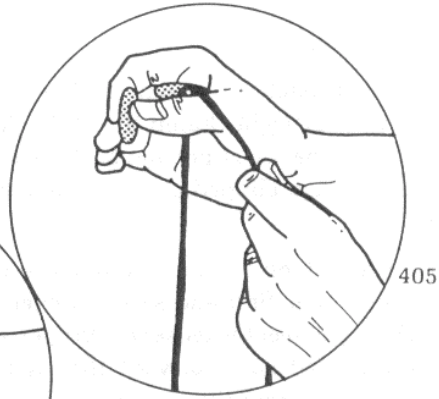

405

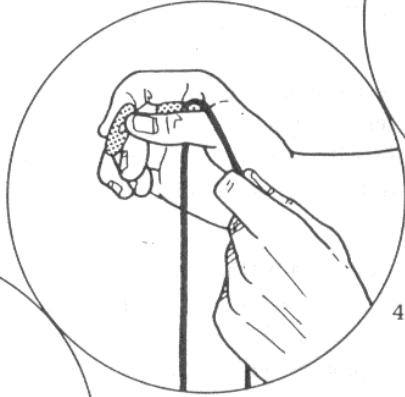

406

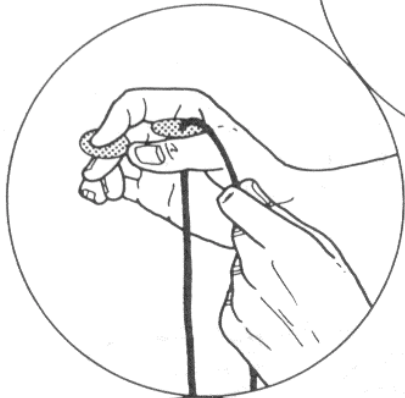

407

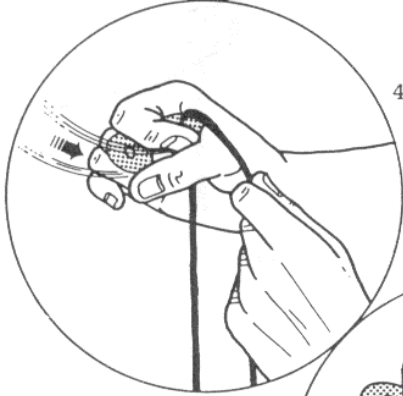

408

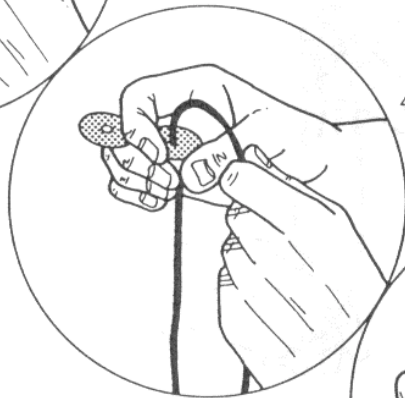

409

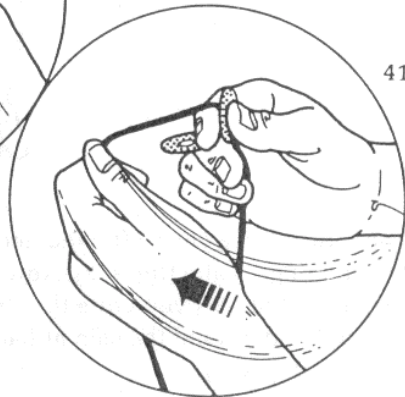

410

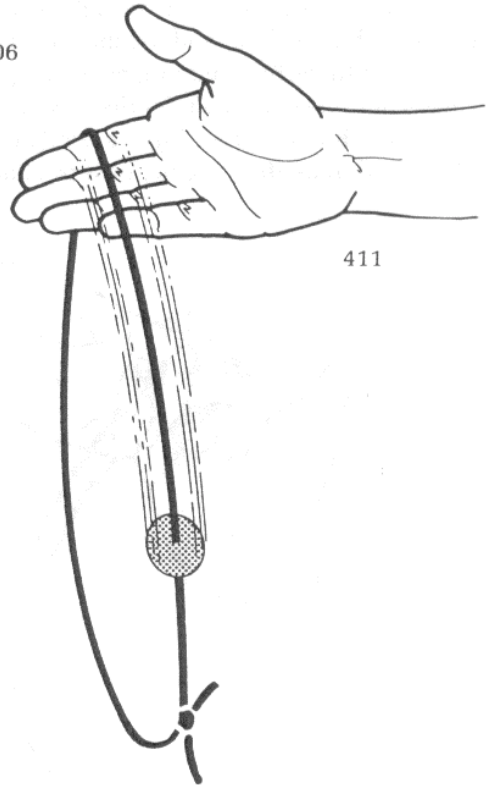

411

The Mirror Change

Your left hand reaches in front of your right hand and grasps the portion of the loop in front of and directly below your right thumb (fig. 405). At the same time your right second finger curls inward and moves in front of the lower portion of the coin (fig. 406). Straighten your second finger flipping the coin to a horizontal position, clipped between your first and second fingers with your thumb resting on its edge (fig. 407).

While your thumb holds that coin in place your first and second fingers curl inward. The coin moves to back clip. While your first and second fingers are curled they clip the Downs palmed coin between them (fig. 408). Once you feel the loose coin properly in back clip begin to straighten your first and second fingers moving the threaded coin outward (fig. 409). Note that your left hand moves with the threaded coin shielding the action from the audience.

When your fingers have straightened your thumb flips the threaded coin to a vertical position held between thumb, first, and second fingers. As you're completing the switch your left hand moves around your right fingertips and drapes the loop over the back of your hand (fig. 410). Note that your right thumb covers the hole in the coin for the moment. It appears to the audience as if you've simply transferred the loop from your thumb to your fingers, while you've secretly switched the coins. To reveal the penetration simply lift your thumb allowing the coin to slide downward to the loop's center (fig. 411).

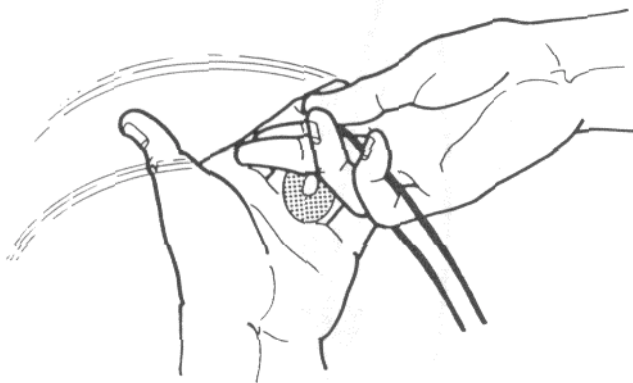

412

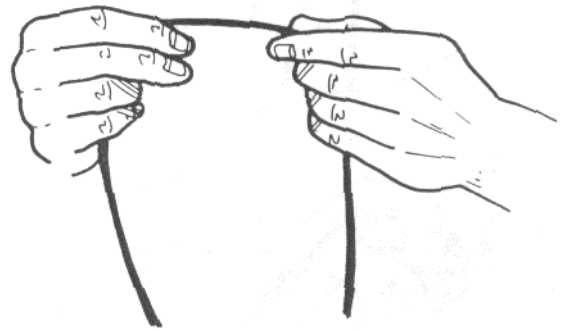

413

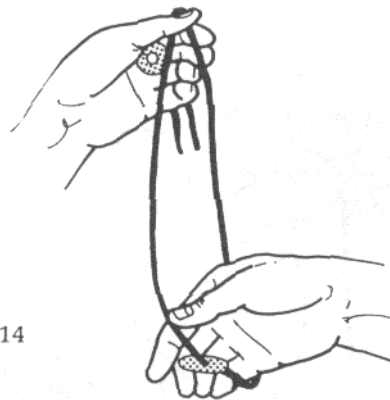

414

Pause for a second, then raise your left hand, moving it behind your right hand so that the back clipped coin falls into left-hand finger palm (fig. 412). Now swing your hands around in front of you (fig. 413 is the audience view). Separate them as you untie the string and, once it's open, grasp both ends with your left hand. Move your right hand around the coin at loop's center so that it rests on the insides of the fingers of your loosely closed fist (fig. 414).

Your left hand drops the ends letting them dangle and moves around your right hand, fingers outside and thumb inside (fig. 415). Slide your left hand to the left, as if pulling the coin off the string. Actually, of course, your right thumb holds the strung coin in place hidden inside your right fingers while your left thumb presses the string against the loose coin as it moves (fig. 416). Your left hand displays the coin while your right hand inserts the center of the string with the hidden coin into a spectator's breast pocket (fig. 417).

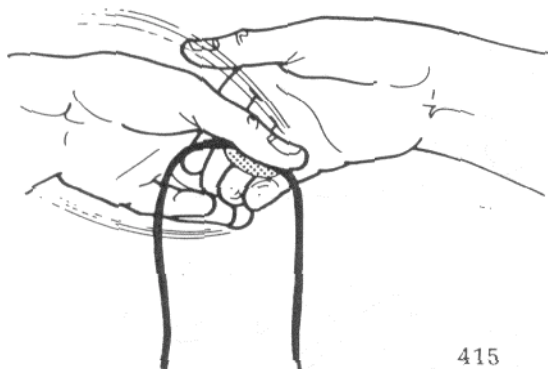

415

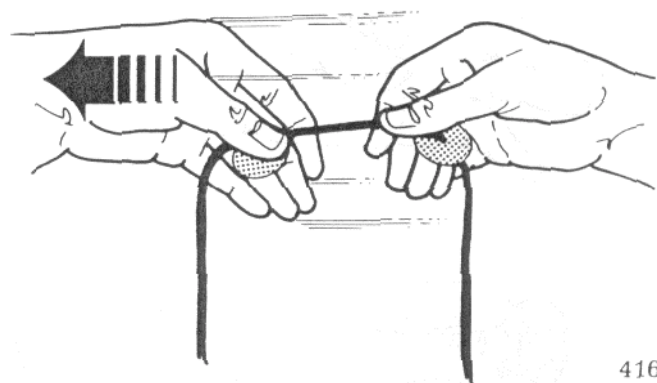

416

Vanish the loose coin any way that you like. Ask the spectator to grasp one end of the string in each hand and pull - the center will pop out of his pocket with the coin dangling on it (fig. 418).

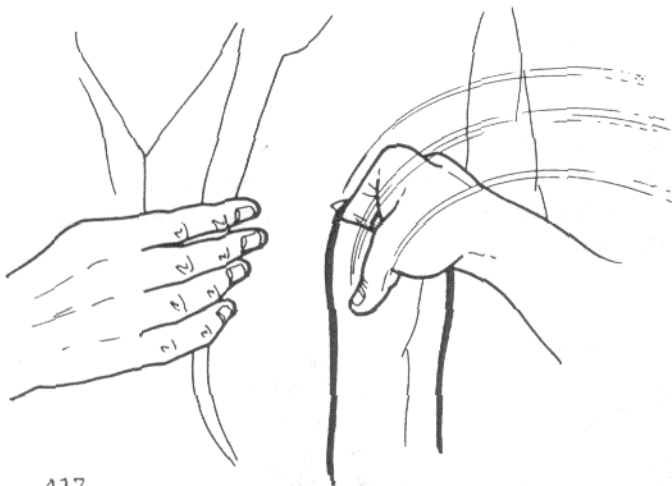

417

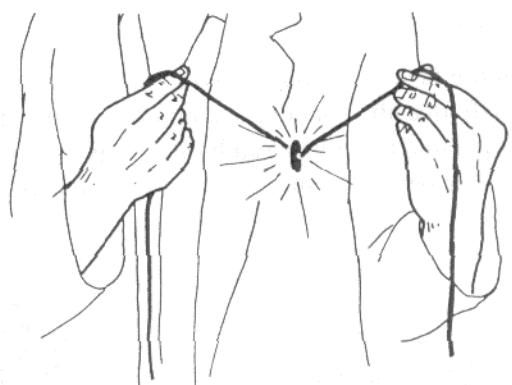

418

Pulling Silver

Sol Stone

This is Sol's version, inspired by both Harvey Rosenthal and Sawa, of the now classic coin routine where the performer visibly breaks a silver dollar into two halves, and then four quarters. Sol's version is a standup, no sleeving, no lapping, completely in-the-hands miracle.

When you start all the extra coins are concealed in your right hand. Four quarters are Downs palmed in your right thumb crotch (fig. 419). Two half dollars are clipped between your second and third fingers, your third finger curling around their edges to hold them in place (fig. 420). Finally, grasp the silver dollar between your thumb and fingers (fig. 421). You must hold the back of your right hand toward the audience at all times.

To perform, show your left hand empty. Turn it palm toward you and grasp the left side of the silver dollar between thumb, on back, and fingers, on face (fig. 422). Your left hand turns the coin over and places it back between your right fingers. Lower both hands and place the dollar into Spellbound position at your left fingertips (fig. 423).

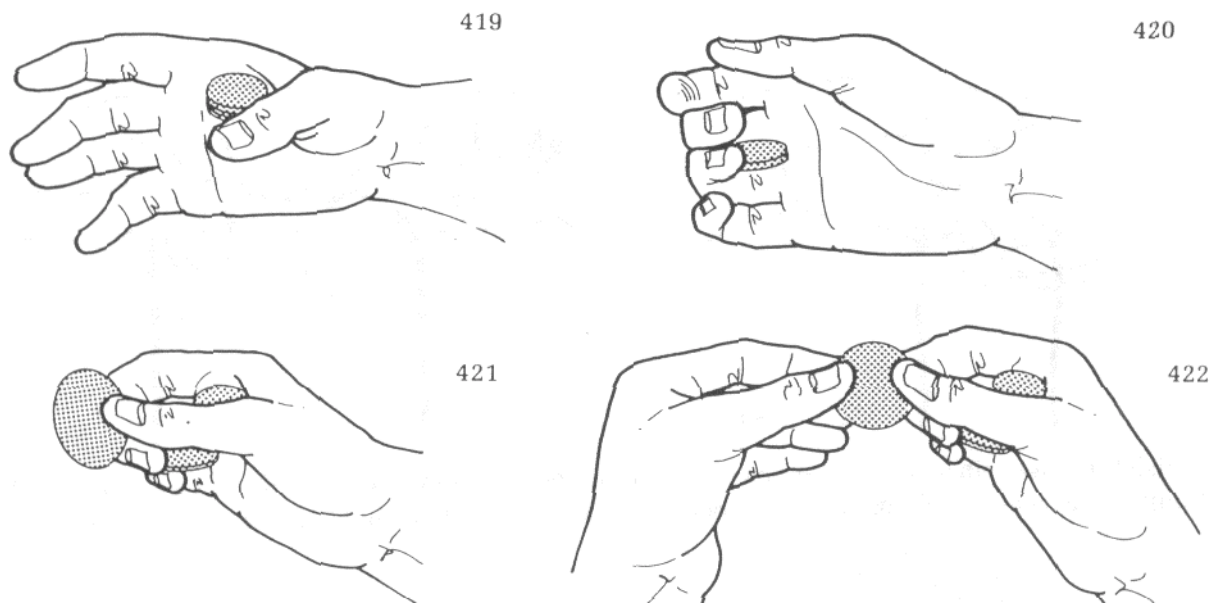

The First Break

Tap the face of the dollar with your right first finger and then move your right hand in front of the coin. Your left thumb immediately relaxes so the dollar falls backward into left-hand finger palm (fig. 424). Without pausing your thumb and fingers grasp the two halves, thumb above and fingers below: they're practically delivered into your waiting left fingers (fig. 425).

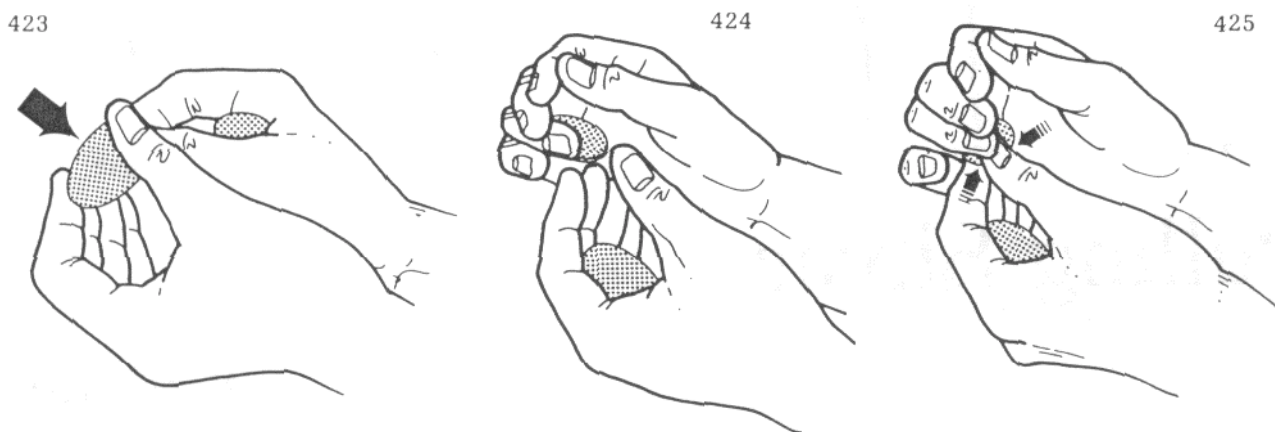

As soon as your left fingers have the coins your right hand starts moving back to the right. At the same time your left hand turns so that your hands are fingertip to fingertip (fig. 426). The halves are still concealed from the audience. Your left thumb pulls the innermost half dollar a little to the left allowing your thumb and fingers to grasp the right edge of the outermost half (fig. 427).

To effect the break bend your hands inward at the wrists, your right thumbtip allowing the right edge of the inner half to snap off it. The left edge of the outermost coin will drag across the face of the innermost

coin making a scraping noise (fig. 428). Separate your hands to display both coins. If you're careful you can turn your palms outward toward the audience - the dollar hidden in finger palm and the quarters in Downs palm (fig. 429).

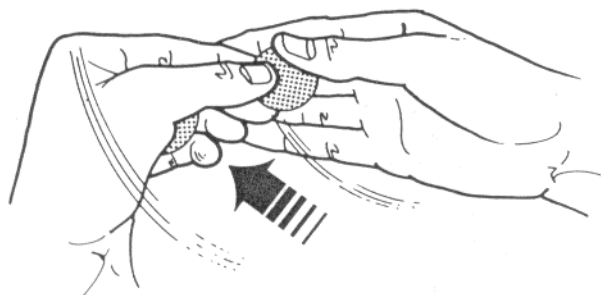

426

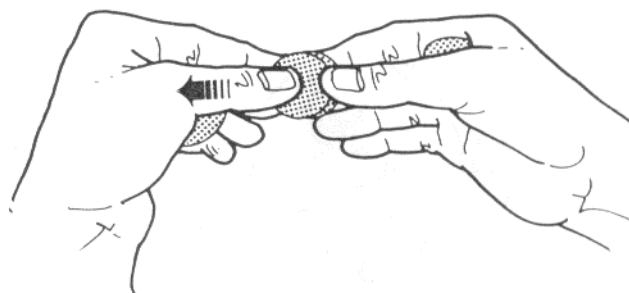

427

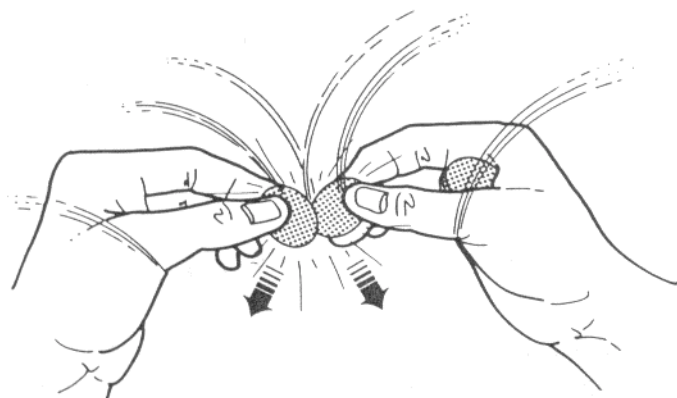

428

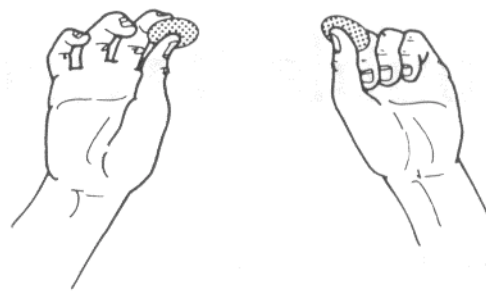

429

The Second Break

Place one half dollar behind the other and place both of them in left-hand Spellbound position. Straighten your right fingers as you move your right hand in front of the halves. Your right hand continues moving to the left until you can curl your fingers slightly and take the halves into right-hand finger palm

430

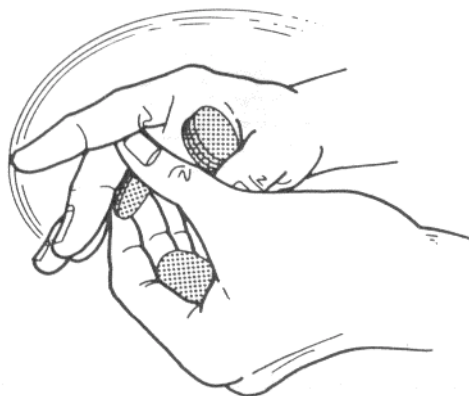

431

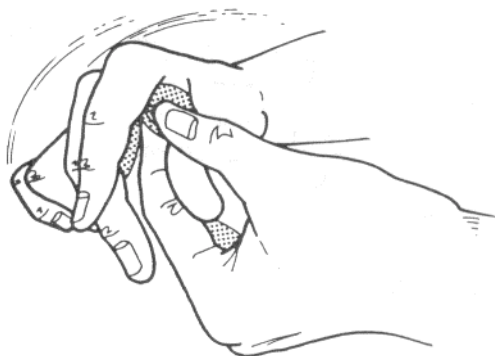

(fig. 430). Without pausing continue moving your right hand to the left until your left thumb and fingers can grasp the stack of quarters (fig. 431). Immediately reverse your right hand's direction, moving it back to the right, your left fingers holding the quarters. At the same time your left thumb slightly spreads the quarters (fig. 432).

As your right thumb and fingers pass the quarters they grasp two of them and pull them to the right with a sudden jerk (fig. 433). That leaves two quarters visible in each hand. Drop them to the table, letting them settle with some noise. You're left with some coins finger palmed in either hand, and they can be disposed of as you stick your hands in your pockets.

432

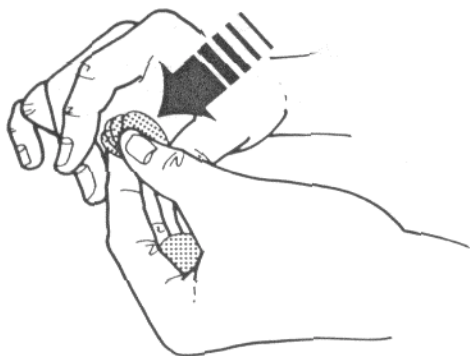

433



Double Twist

Sol Stone

In the May 1939 issue of *The Sphinx*, Victor Farelli published a coin routine called *Vice Versa* that used two copper/silver coins. Sol created this handling slightly after that, based partially on Farelli's routine. Recently a similar routine was published in *The Coins of Ishtar*, though without credit to Farelli.

To prepare place a silver coin in your outer right jacket pocket and a copper coin in your outer left jacket pocket. You also need two copper/silver coins: they're not identical. One has a silver head with a copper tail, the other has a silver tail with a copper head. (You'll only need those when you perform - for now, just to try the routine, use any two copper/silver coins that you have.) Place the two gimmicked coins into a pocket.

434

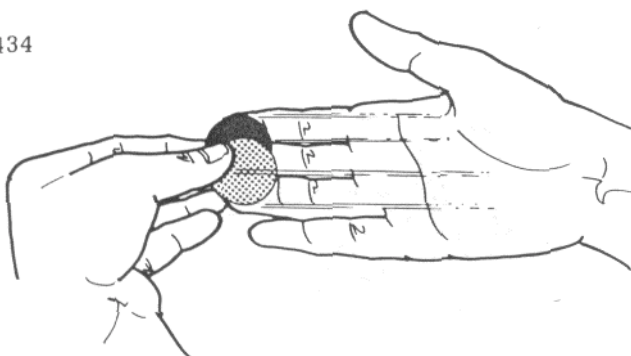

435

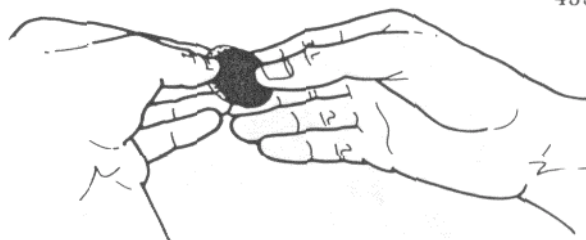

Your right hand reaches into the pocket and removes the two gimmicked coins. They rest on your right fingers, copper and silver heads up. The silver coin rests on top of the copper coin. Your left fingers pull the coins to your right fingertips (fig. 434). Your left fingers take the silver coin and slide it beneath the copper coin (fig. 435). Your left fingers take the copper coin and slide it beneath the silver coin, leaving it stepped outward (fig. 436). Your left hand holds both coins for a moment as your right hand turns over and grasps them, thumb beneath, first finger above. Your right finger placement is very important. Your

thumb is directly beneath your first finger, and your first finger rests only on the upper silver coin while your thumb rests only on the lower copper coin (fig. 436a is an exposed view).

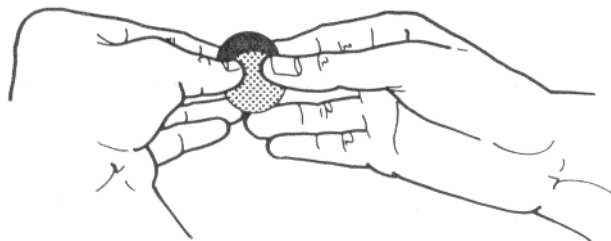

436



436A

Move your left hand away and start to turn your right hand over. As it rotates slide your first finger inward and your thumb outward, sliding the coins to opposite positions (fig. 437). Your left fingers take the silver coin and slide it beneath the copper coin. Your left thumb moves onto the copper coin and drags it onto the base of your left second and third fingers in finger palm (fig. 438). Close your left fingers into a fist and turn it over, also automatically turning the coin inside of it over). Place the right-hand silver coin onto the back of your left fist [fig. 439].

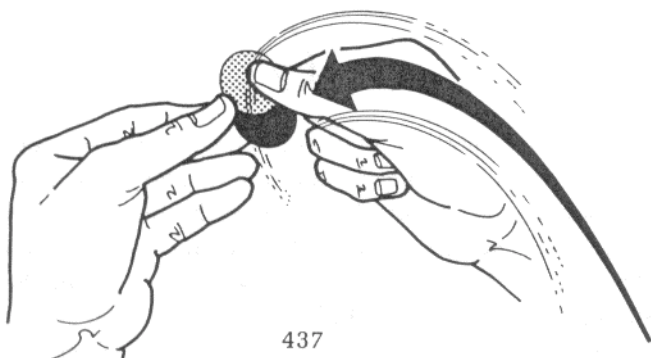

437

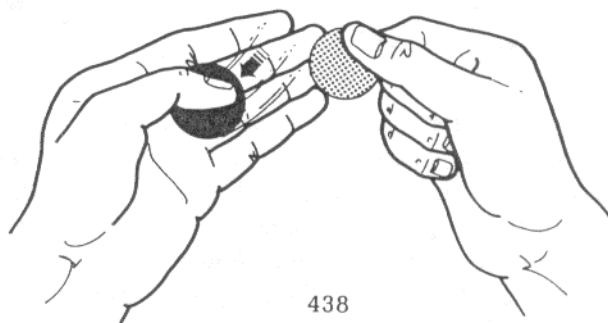

438

Flatten your right hand and cover the silver coin with your fingers (fig. 440). This is going to be difficult to describe (not to do, just to teach). Simultaneously turn both hands palm up, your right fingers holding the coin against the back of your left hand (fig. 441). Move your right hand to the right, revealing the copper coin (fig. 442). Open your left fist to reveal the silver coin.

439

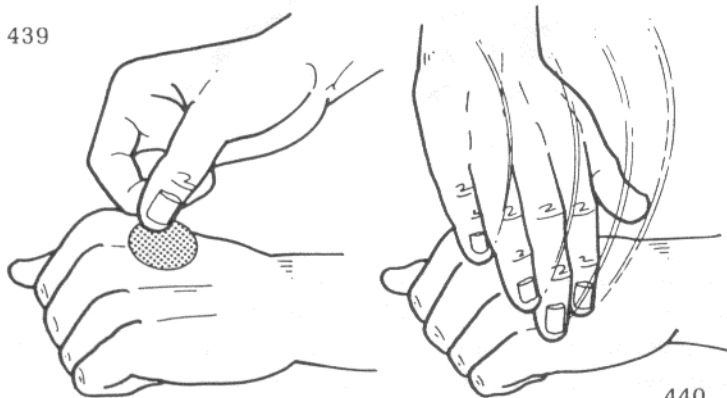

440

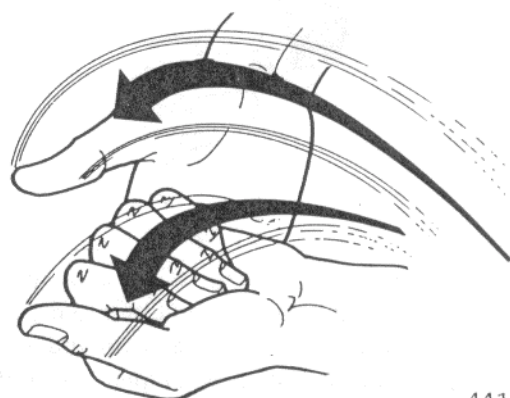

441

Curl your left fingers into a fist over the silver coin and turn your hand over. Drop your fingertips a bit allowing the inner edge of the coin to drop - the outer edge pressed against the flesh of the finger base (fig. 443 is a side view). Lower your fingers until the coin is almost vertical (fig. 444). Now, press them

upward again, squeezing the coin and flipping it over. This quick turnover is a secret move, and invisible once you practice it.

Your right hand places the copper coin on the back of your left fist. Cover it with your right fingers and repeat the two-hand palm-up turn already described. This time, open your left fingers first revealing the copper coin, then slide your right hand out from beneath it to reveal the silver coin (fig. 445). Close your left fingers and turn your fist over doing the secret turnover. Simultaneously turn your right hand over, closing your fingers (which keeps the coin, resting on your fingers, silver side up). Both fists are now palm down.

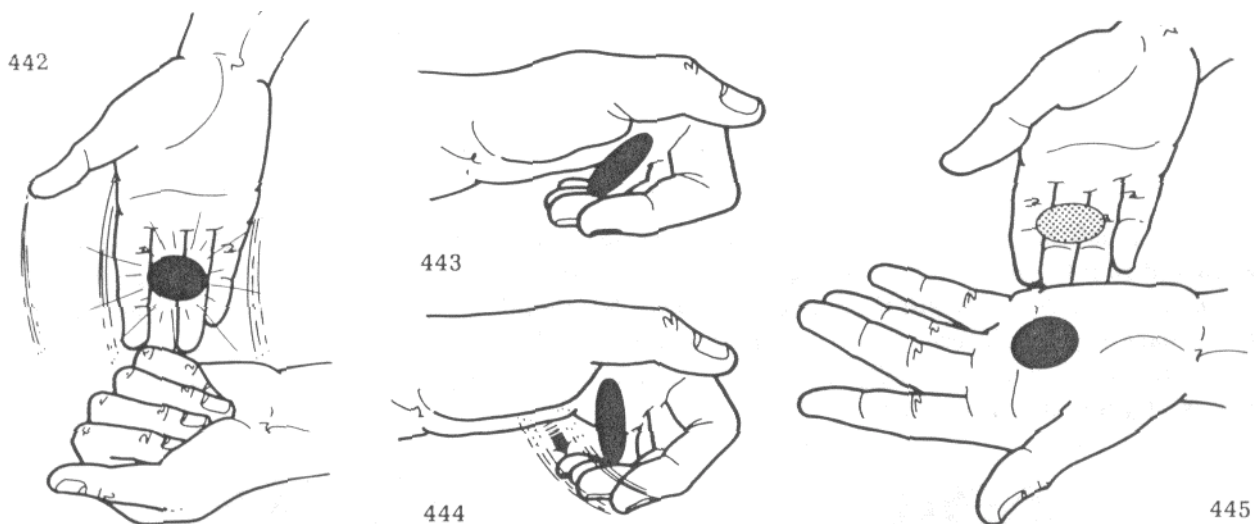

Turn both fists over and open them revealing the copper in your right hand and the silver in your left. Close both hands and turn them over. Do the secret turnover with both hands and immediately turn them palm up, opening them to reveal silver in your right hand and copper in your left. Bounce the coins forward to your fingertips. Place the copper coin beneath the silver coin, stepped inward, both coins held between your right thumb and second finger in position for the two-card monte type turnover move used at the beginning of the routine (though your right hand is palm up this time) (fig. 446). Turn your right hand over, your thumb pushing outward and your first finger pushing inward, sliding the coins to proper position (fig. 447). Turn your right hand palm up again, reversing the sliding motion. Drop the copper coin on your left fingers and curl them into a fist, automatically turning the coin over (silver side up).



Your right hand takes the silver coin and goes into your outer right jacket pocket (where the real silver coin is). Say, "I put the silver coin into my pocket and it jumps into my left hand." While in the pocket your right hand drops the gimmicked coin and grasps the regular silver coin in a fist. Take your right hand out of your pocket, keeping it closed. Open your left hand revealing the silver coin there. Say, "And I put the silver coin in my left pocket and it jumps to my right hand." Place your left hand into your outer left jacket pocket, drop the gimmick, and grasp the real copper coin. Take your left hand out of your pocket and open your right hand to display the silver coin. Then open your left hand to display the copper. Both are now examinable.

Half and Half

Sol Stone

Unusual item. Sol can do the rolldown flourish with both hands, and that's necessary in this routine. You have a stack of coins that's set up in advance. From the top down: copper/silver coin (silver side up), copper coin, silver coin, copper/silver coin (silver side up), copper coin, silver coin. That stack is held between your right thumb and first finger in roll-down position (fig. 448).

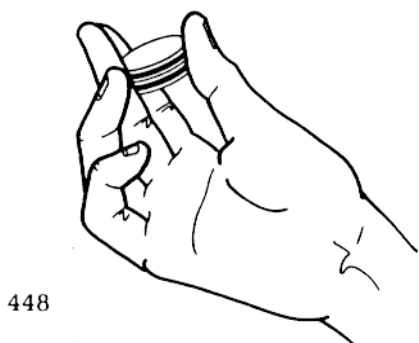

448



449

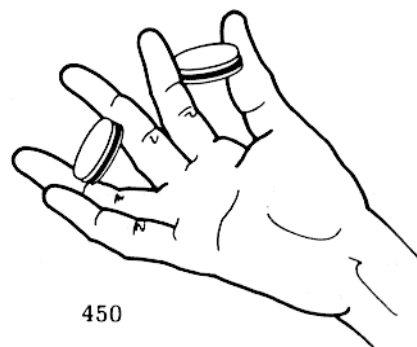

450

I'm not really going to teach the roll down flourish because all the best methods are already in print (see Buckley's Principles and Deceptions, Tarbell, and Bobo). So, I'll assume you're somewhat familiar with the move. Move your second finger onto the edge of the stack next to your thumb (fig. 449). Break the three lower coins and roll them down to between your second and third fingers (fig. 450).

Move your pinky beside your second finger, and your thumb on the other side of your second finger (fig. 451). Open the spread so that your pinky and second finger pull the rear silver coins off the stacks and spread them (fig. 452). Pause for a second - so far all you've done is roll out four silver coins.



451

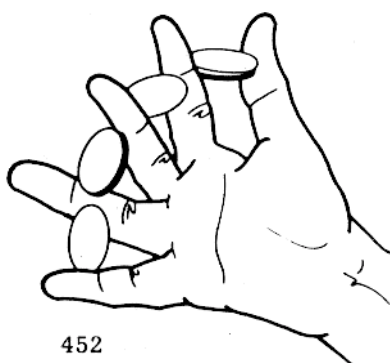

452

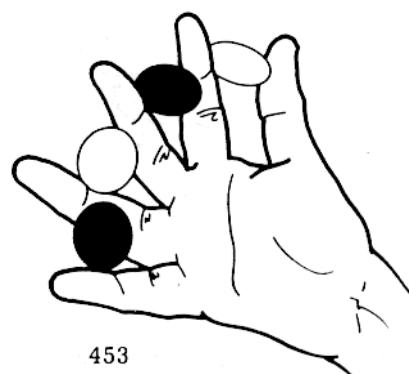

453

Your left hand takes the silver coins from between your pinky and third finger, and first and second finger, and pockets them. Move your fingers together and roll out the copper coins that are hidden behind the others still in your right hand (fig. 453). Glance at your hand and comment that the coins don't match any more. Your left hand takes the coins from between your fingers one at a time, starting with the one between thumb and first finger, and stacks them. Now simply hold that stack with your left thumb and first finger and do the roll down move - four coppers will show. (The natural action of transferring the coins from hand to hand reverses the stack.)

Silver Hole Switcheroo

Sol Stone

If you try this you'll know why I fought for it. You display a silver dollar with a small hole drilled in it near the edge. You drop a toothpick through the hole. You hand the toothpick to the spectator. You cover the hole with your thumb and drag it to the other end of the coin. After you lift your thumb the spectator can drop the toothpick through. Everything is examinable.

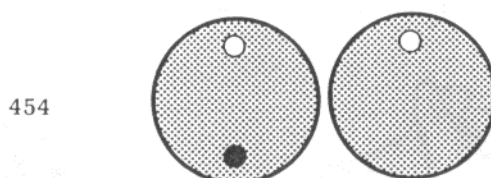

To prepare, drill a small hole near the edge of a silver dollar (fig. 454). That illustration shows both sides of the coin - on the back, at the edge opposite the hole, is a small black dot. It's a small circle of electrical tape that Sol cuts out with a hole puncher and simply sticks to the coin. The black dot is obviously the same size as the real hole.

To perform, your left hand holds the coin between thumb (above), and first and second fingers (below) (fig. 455). It's held at the extreme edge so that the hole is nearest you. Your right hand picks up a toothpick and slowly inserts it into the hole (fig. 456). Drop it through, letting it fall onto the table. (If you're standing have a spectator place his hand beneath the coin so the toothpick has somewhere to fall.)

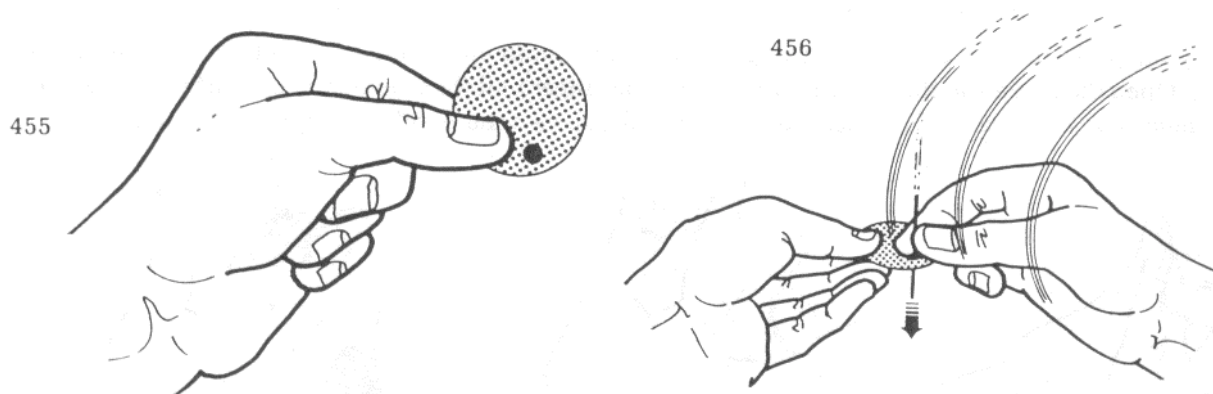

Your right hand picks up the fallen toothpick and moves toward the spectator to hand it to him. As your right hand moves your left hand secretly turns over the coin. (It's not really a secret movement - just something that seems unimportant and goes unnoticed.) In detail: As your right hand moves toward the spectator he's forced to look at it. Simultaneously extend your left second finger beneath the coin (fig. 457). Start turning your left hand over and, at the same time, slide your thumb and first finger over either side of the hole (fig. 458). The real hole, covered by your first finger, is near you - the black dot now visible on the opposite end of the coin. The hole appears exactly where it should - since you've turned your hand over it should be at the opposite end of the coin. The coin's rotation cannot be seen.

Once the spectator has the toothpick turn your right hand palm down and cover the black dot with your right first finger. Your thumb moves beneath the coin, directly beneath your first finger (fig. 459). The coin

should be lightly gripped so that you can simultaneously turn both hands palm up while still holding the coin (fig. 460). Note the positions of the hands - both are now palm up, your left thumb covering the real hole, your right thumb covering nothing (but the spectators think that's where the hole is).

457

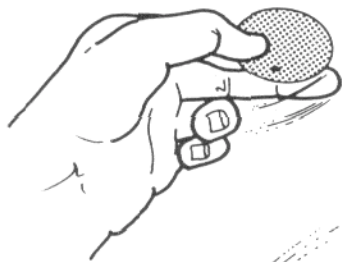

458

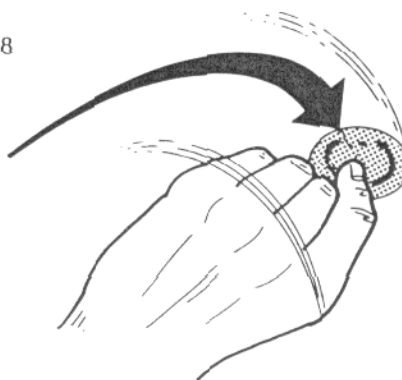

459



460

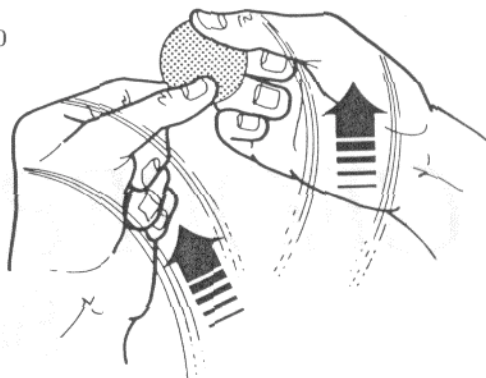

Slowly slide your right thumb toward you across the face of the coin, as if dragging the hole beneath it (fig. 461). When it cannot move any farther because of your left thumb start sliding both thumbs toward you, your right thumb covering the spot where your left thumb was (fig. 462). Your left thumb pushes the coin forward so that it's held solely by your right thumb and first finger.

461

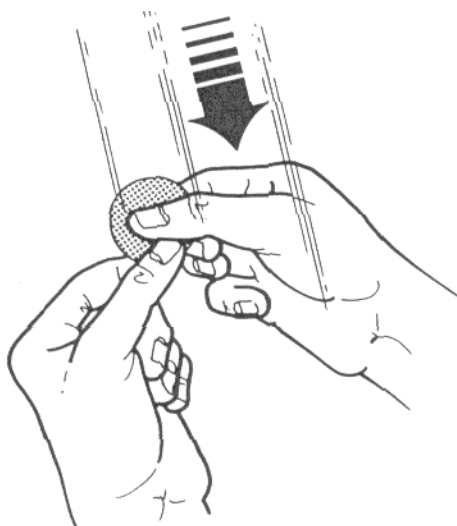

462

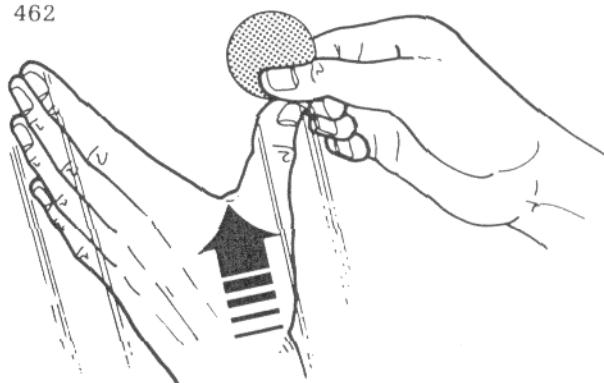

Your left thumb and first finger grasp the side edge of the coin (exactly as in the beginning) as you lift your right thumb revealing the hole. Allow the spectator to drop the toothpick through.

You can scratch the black dot off with your fingernail as you hand the coin out for examination. Sol simply pockets the coin most of the time.

The
GEOFFREY LATTA
Section

Ultimate Han Ping Chien

Geoffrey Latta

This technique, which is based on an idea by Johnny Benzais, is quite unlike anything you've ever seen. It'll fool anyone who knows the standard Han Ping Chien handlings and can be utilized to produce absolute miracles, as you'll see in some of Geoffrey's routines later on. It isn't easy, but if you learn it you'll use it of ten.

Handling No. I

(Each hand's action will be taught separately, then you'll combine them.) The Left Hand's Action. Break this down into two steps: get-ready, and release. To start toss a half dollar onto your palm-up left hand. It doesn't matter where it lands as long as it's on the palm area (fig. 463). Close your fingers into a loose fist don't squeeze them flat. Turn your fist over until it's almost palm down, but still tilted a bit to the right (fig. 464).

The coin should be falling loosely inside your fist. Once your hand has turned over the coin will be resting at the lower end, near your third and pinky fingers. You won't actually do this when you perform the move, but for now (to learn it), shake your fist a tiny bit to loosen the coin so that it falls a bit farther, its lower edge cradled by your pinky. The only part of your pinky which actually touches the coin is the extreme tip, which presses it very lightly against the heel of your hand (fig. 465 shows how the coin rests, the left hand is transparent). Other than that one place the coin is loose and sort of floats inside your fist. It does not come in contact with any skin other than your pinkytip. If you lightly shake your hand you should be able to feel the coin wobble around. Once you've completed the initial get-ready turn your fist palm up again, leaving it tilted slightly to the right (fig. 466).

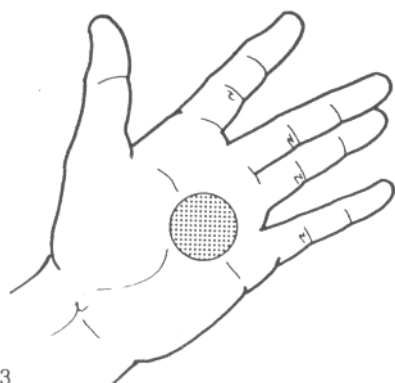

463

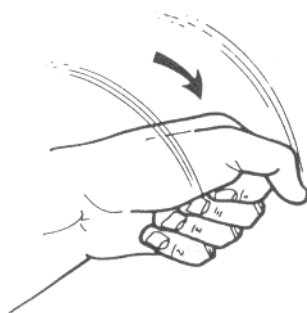

464



465

The other part of your left-hand's action is the release. Your right hand will later cover this. If you've properly loosened the coin all you have to do is simultaneously relax your left pinky and smoothly move your fist to the left. The coin will drop out of your fist and onto the table (fig. 467). The coin does not move to the right - it stays exactly where it was and your hand moves away. When your fist moves the coin stays momentarily in space then falls downward. Do not jerk your fist to the right in an effort to eject the coin because that's wrong! That can be seen. Simply moving your fist out of the way of your right hand (which is what'll eventually happen) won't be noticed because it is a reaction - not an action. Don't jerk your fist to the left, either. just move it. If the coin is held loosely, only by your pinkytip as described, it will fall out.

The Right Hand's Action. Let's assume for the moment that your right hand is empty. Hold it, palm up fingers outstretched and together, in front of and slightly to the right of you (fig. 468). Turn your hand palm down, at the same time curling your fingers into a loose fist (fig. 469).

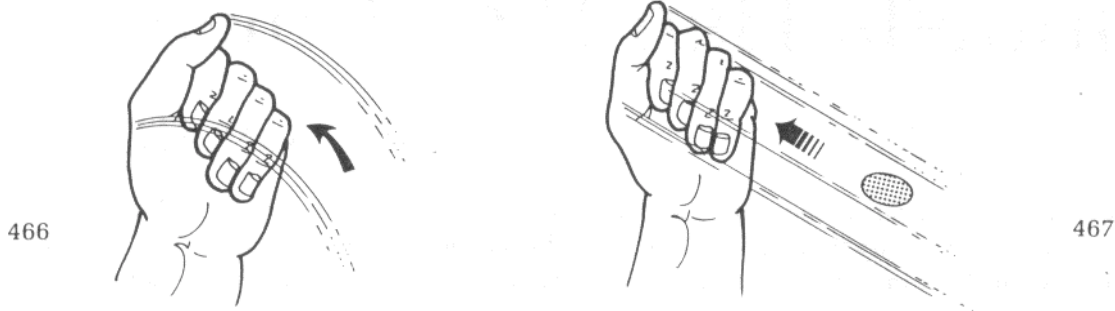

I've marked a spot X on the table so you know where your right hand will move to (later the coin will fall onto that spot). Your right hand moves from its palm-down fist in a short hop to X, opening its fingers (fig. 470). The movement is semi-circular; up, out, and down, as if you were rolling your hand over the top of a beach ball.

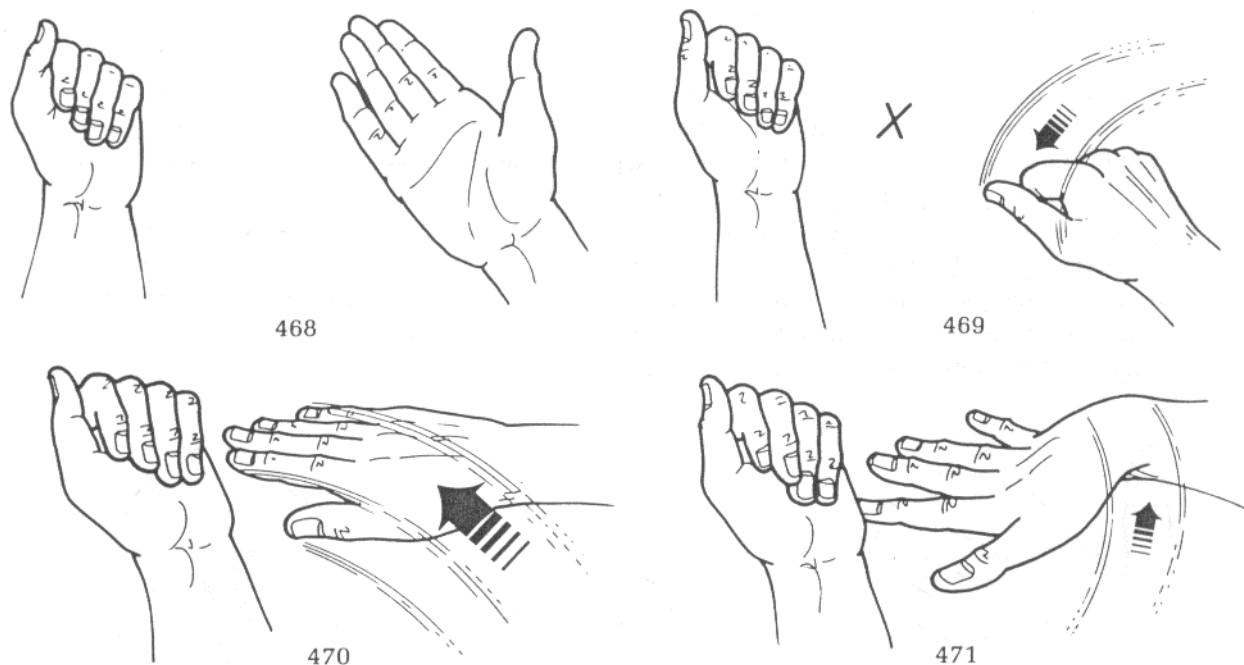

A few little, but important, things happen when your outstretched fingers hit the table. First, they spread (but remain relaxed), and second, the back of your hand bends upward (fig. 471). It'll hurt to do this at first, but it's only for a second because you immediately lift your hand straight up.

Now that you're familiar with what your right hand's going to do, put three coins in it. They're spread on your palm area with one in classic palm position. Your hand is ready to begin its sequence. Turn your right hand palm down, closing its fingers into a fist. One coin is retained in classic palm and two fall to the inside of your fingertips. Now shoot your right hand forward in its hopping (up, over, and down) motion to the table, at the same time straightening your fingers. When your hand lands on the table the two loose coins will be trapped beneath your spread fingers (fig. 472). (Don't smash your hand down because you'll dislodge the palmed coin. Bending the back of your hand upward may be a bit uncomfortable, but it makes your hand appear flat even though a coin is palmed.)

The Combined Action. Initially your hands are positioned so that your palm-up left hand is directly in front of you and your palm-up right hand is in front of your right shoulder (fig. 473 is an audience view). There's a single coin on your left palm and three coins on your right palm (one of which is in classic palm position). It will appear to the audience that the coin in your left hand vanishes and reappears in your right hand (the final sequence in a simple Coins Across).

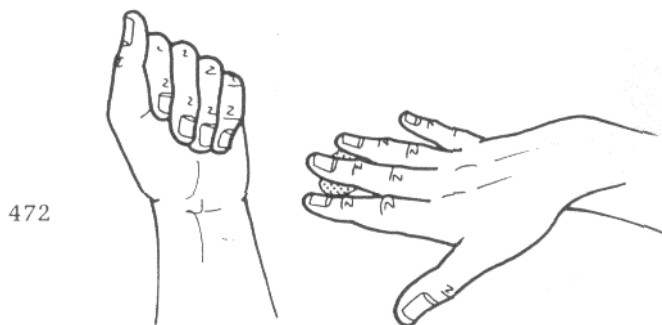

Do the left-hand get-ready, turning your fist down and up, loosening the coin so that it's held by your pinkytip. Turn your right hand palm down letting two of its coins fall onto the insides of your fingers and retaining the third in classic palm.

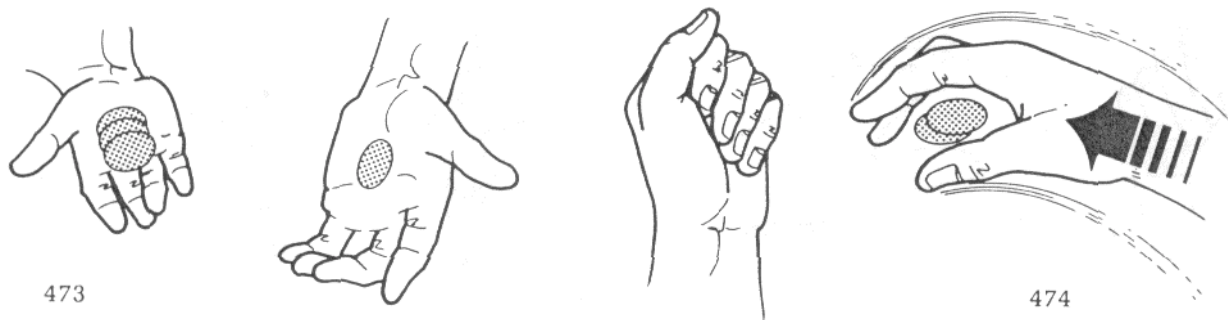

Here's where the timing comes in. Both hands perform their actions as already taught simultaneously. (Actually your left hand just does the release, since it's already done the get-ready.) There is one key moment that will clinch the illusion. Your right hand shoots forward in its hopping motion, its fingers straightening (fig. 474). When it reaches the point just shown your left hand moves smoothly to the left and out of the way. The left-hand coin will remain suspended in midair for a split second before falling (fig. 475). At that moment your right fingers land on it and push it downward onto the table (fig. 476). Actually the two coins which are trapped by momentum beneath your descending right fingers will push the lefthand coin downward.

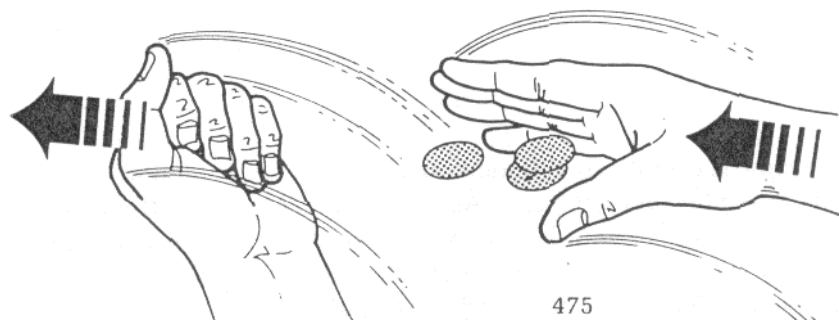

Your right hand lands on the table, fingers spread, back of the hand lifted so that it bends your fingers backward a bit, with three coins visible through the fingers (fig. 477). After a beat lift your right hand showing three coins. Pick them up and let them drop inside your closed right fist. Say your magic

mumbo-jumbo and open your left hand to show that its coin has vanished. Open your right hand revealing four coins.

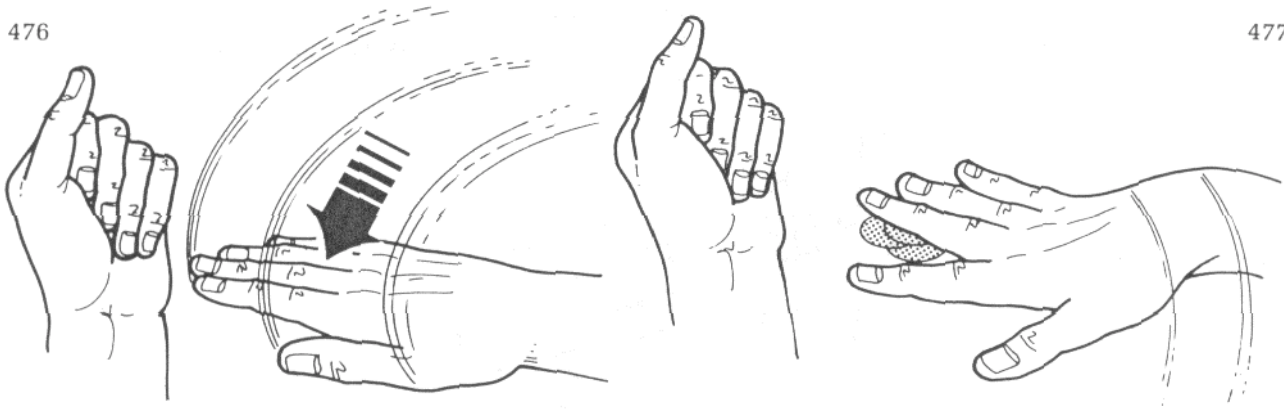

Handling No. 2

Display a coin on your palm-up left hand. Close it into a fist and do the get-ready so that the coin is held loosely by your pinkytip and the fist is almost palm up. Your right hand, held palm down, is relaxed. Both hands are held near you at the same height above the table (fig. 478).

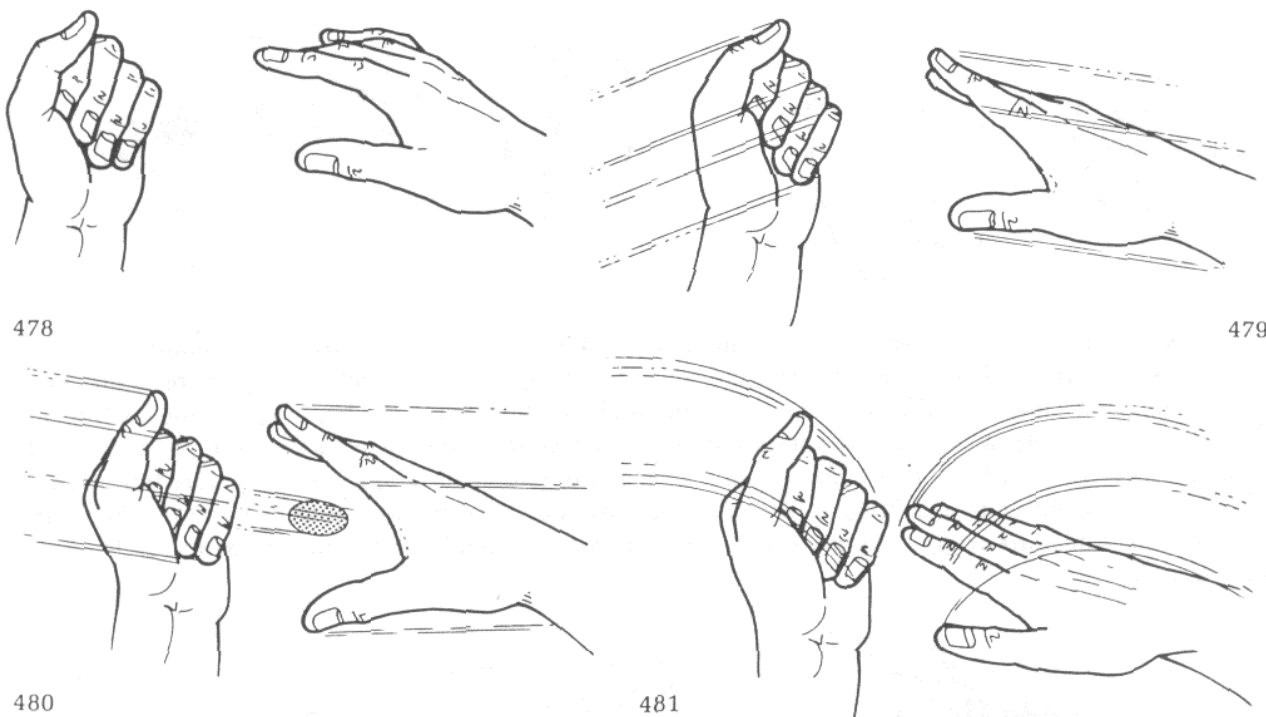

The timing on this handling is completely different (and simpler, too). Simultaneously move both hands forward and downward toward the table (fig. 479). As they move relax your left pinky allowing the coin to drop out. It'll move forward because of your left hand's momentum (fig. 480). Your right hand moves over it as it falls, covering it and slamming it onto the table (fig. 481). Your right hand's actions are the same now, spreading its fingers and bending slightly backward at the wrist.

Be careful not to jerk your left fist toward the table, simply move it forward and relax your pinky. As soon as it's released the coin it moves away, increasing the apparent distance between the hands.

Isolation Placement

Geoffrey Latta

In order to do complex routines utilizing Geoffrey's handling of Han Ping Chien you have to be able to isolate one of a number of coins in your left hand so that you can hold the others securely and release only one for the move.

Stack a group of four half dollars on your left palm. The bottom coin is on the base of your pinky and the others are spread inward and to the left (fig. 482). Simultaneously close your fingers into a fist and turn your hand palm down. The coins will automatically slide into a neat stack at the base of your pinky (fig. 483).



Press your pinky tip lightly against the inner coin's face (fig. 484). Tilt your fist slightly to the right, allowing all the coins behind the one touching your pinky to slide to the right (fig. 485). They should roll until they're nestled between your first and second fingers (fig. 486). Curl your first and second fingers inward, pushing the stack of three coins against your thumb base locking them in place.

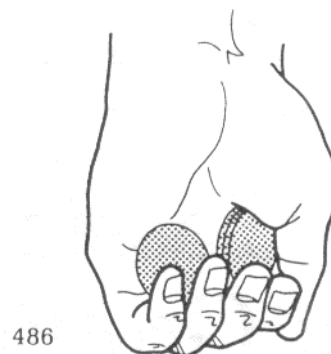
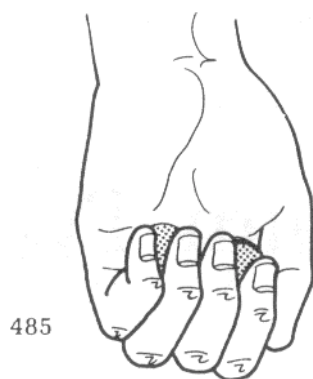
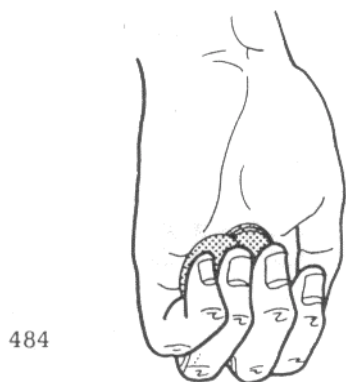

This is going to take some concentration and practice because, once you turn your left fist up, ready for the move, you must relax your pinky so that the single lower coin is very loose and ready to slide out, while tightly gripping the stack of coins between thumb, first, and second fingers.

One-Hand Turnover Switch

Geoffrey Latta

This utilitarian switch is a streamlined version of Sol Stone's One-Hand Switch, though Geoff has not seen Sol's move and developed it independently. For teaching's sake let's assume that a copper coin lies on the table. A copper/silver coin is in your right hand in fingertip rest, copper side against your fingertips (fig. 488).

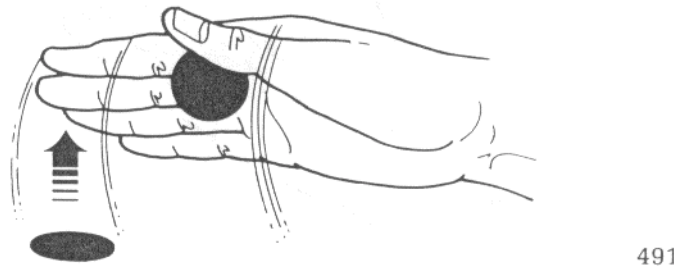
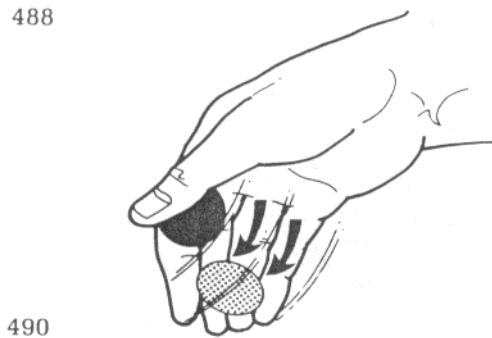
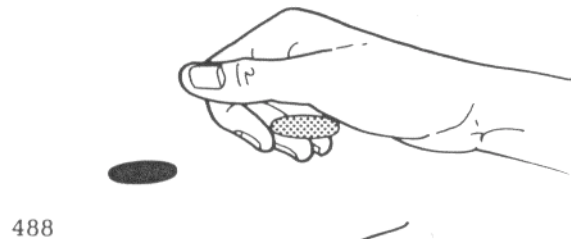

Move your right hand over the tabled coin, your thumb moving onto its inner edge. When your thumb presses downward (you must be working on a soft surface) the outer end of the coin will rise slightly. Slide your fingers beneath the copper, your thumb guiding it along the left side of your first finger (fig. 489). Lift your right hand and turn it palm down, straightening your fingers (fig. 490). Immediately slap it onto the table and raise your hand, leaving the gimmicked coin copper side up on the table (fig. 491).

Curl your fingers into a loose fist, your thumb pushing the copper coin to fingertip rest as your hand settles to the table behind the visible coin.

If there's no soft surface available Geoff will do the move on his left hand.

To Classic Palm Two Coins of a Group

Geoffrey Latta

Here's another bit of finesse that combines David Roth's technique for Classic Palming One Coin of a Group with another move so that two coins can be palmed.

Drop a stack of four half dollars on your right hand, which is palm up. Turn your hand over, your fingers curling into a loose fist, the coins stacking inside your fingers. Do Roth's technique, and then turn your hand and palm up again to display the coins - one will be in classic palm (fig. 492). Move your left first finger onto the top (outermost) coin and drag it inward onto the coin in classic palm as you say, "Four coins which you've examined" (fig. 493).

Move your left hand away and turn your right hand over loosely curling your fingers. Two coins should stay in classic palm and the other two will stack inside your fingers.

You may have to use the coin that your left first finger is dragging to push the coin that's resting partially on the coin in classic palm out of the way.

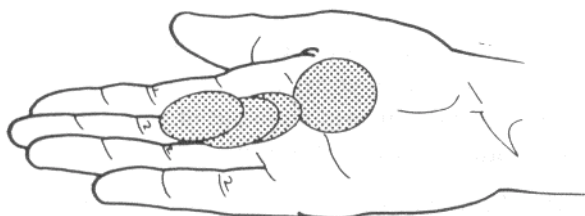

492

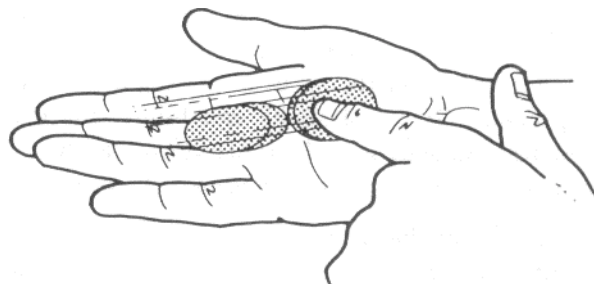

493

Thumb Touch Coins Across

Geoffrey Latta

This routine uses only one move - Geoff's Han Ping Chien. The application is also fairly easy. There is, of course, a catch: you must be able to act, and well. If you convey the proper impressions to the audience this is one of the cleanest coins across routines you could possibly want. It uses only four coins and can be done either standing or sitting.

494



495



Display the four coins and drop them on your left palm. Close your hand and do Isolation Placement as already described, getting one of the coins ready. Look at your left fist and give it a slight upward shake. Follow the path of the invisible coin as it travels across to your right hand. Glance in front of you, just a bit to your right, as if you see the coin in midair (fig. 494 is the audience view). You've followed the path of the imaginary coin to your right hand and, when it reaches it, pretend to grab it, your hand turning palm up with your thumb behind your straightened fingers (fig. 495).

Do it with conviction. If you don't really believe that your right hand has caught a coin then there's no way you can convince the audience. It works, too - they'll think you're actually holding a coin in your right hand.

Now, simply place the coin that you've caught with your right hand onto the table. Of course, you do the Han Ping Chien move so that as your right hand smacks down onto the table, your left hand moves smoothly to the left. The isolated coin slides out of it and, as your right hand descends, your fingers push it downward onto the table. The illusion is perfect, as if you were simply smacking the "caught" coin onto the table. It's also a little easier than some other applications of the move because there's nothing else in your right hand to worry about (no extra coins, etc.).

After you lift your right hand, leaving the single coin on the table, turn it over to show it empty. Turn it palm down and make a fist. Shake your left hand and open it to display three coins. Maneuver them by shaking your hand so that they're stacked inward in position for Isolation Placement. Do the move as you close your hand and turn it over, getting another coin ready for the Han Ping Chien. Then, turn your left fist up again. Give it a shake and follow the invisible coin, catching it with your right hand, which immediately smacks it to the table as you do the move. The second coin will slide out of your left fist and, as your right fingers push it downward, clink against the coin already on the table,

Simply repeat the entire business as described to get the third and fourth coins across. Remember that your aim has to be good here so that each coin that's released from your left hand lands on the coin or coins already on the table.

Standup Spectator Coins Across

Geoffrey Latta

You need only four coins for this standup anytime, anywhere, coins across into a spectator's hand. Let the spectators examine the coins. When you get them back display them on your palm-up right hand. Do Geoff's technique for Classic Palming Two Coins of a Group as already taught. Afterward two coins are classic palmed in your palm-down right hand and the other two rest inside your curled right fingers. Move your thumb onto the inner edges of the coins so you can straighten your fingers, still holding them (fig. 496). Toss the two coins into your palm-up left hand from a distance of about eight inches, immediately closing it. Silver will be seen flying into your left hand and it's impossible to tell that there are fewer than four coins.

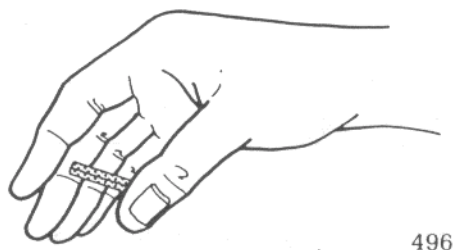

Ask a spectator to hold one of his hands palm up between you and rest your right hand lightly on top of it (fig. 497). Give your left fist a shake and follow the flight of the imaginary coin with your eyes as it travels from your left fist to his hand. Time it right and, when you look at his hand relax your right palm a bit and

drop one of the two palmed coins onto his hand. The second coin remains in palm. (There's nothing I can explain about this, which is an old idea. It's just control that comes with practice. You should be able to classic palm four coins and let them drop one at a time.)

Lift your right hand so they can see the coin. Say, "That's the first one." As you say, "Three left," very quickly open and close your left fist (a la Ross Bertram) flashing some silver. They won't be able to see how many coins are there - but it looks like three if you're casual about it. Move your right hand back over his hand and repeat the action again, shaking your left fist and watching the coin travel to his hand. When it arrives relax your right palm and allow the second coin to drop onto the first with a clink.

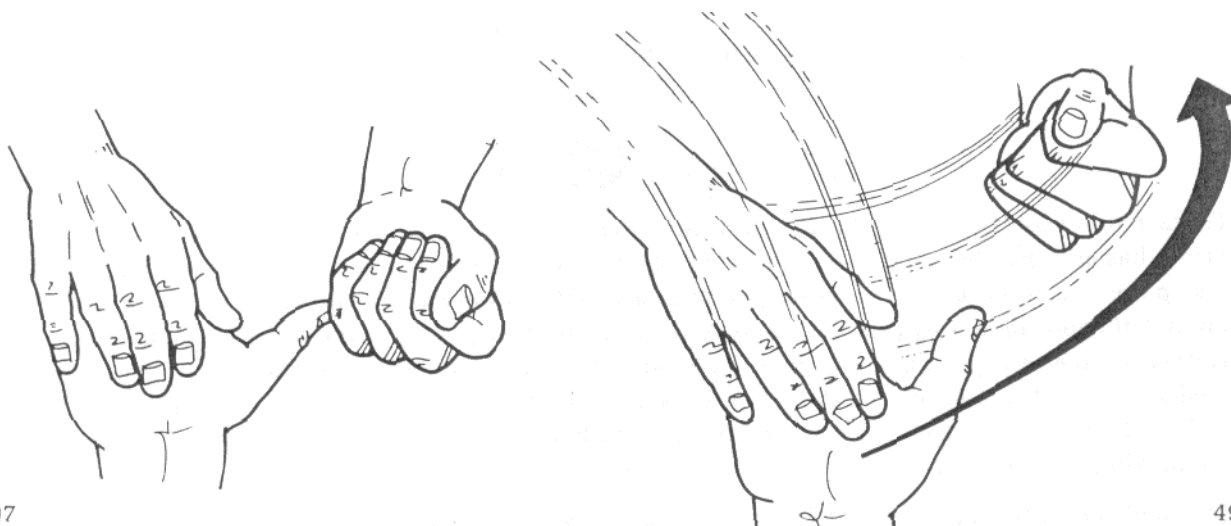

Move your right hand away so they can see both coins. Open your left hand to show two coins still there. As you close your left hand do Isolation Placement getting one of the coins ready. Your right hand picks up the two coins from the spectator's hand and does the Roth technique for Classic Palming One Coin of a Group, turning palm up afterward to display them. Do Geoff's Han Ping Chien on the spectator's hand. Briefly: your palm-up left fist should be directly beside the spectator's hand. Your right hand turns palm down, one of its coins dropping to fingertips. It does its little hop forward onto the spectator's hand, fingers straightening and pushing the coin that slides out of your left fist downward (fig. 498). Immediately lift your right hand and say, "Two."

Cover his hand again, shake your left fist, and follow the invisible coin over to his hand. Relax your right palm and allow the third coin to drop onto the two already there. Lift your right hand to reveal three coins and open your left fist to display the last coin.

Your right hand picks up the coins that are in the spectator's hand. At the same time your left hand does the Han Ping Chien get-ready so the last coin is ready for the move. Again, your palm-up left fist is beside the spectator's hand. Your palm-up right hand displays the three coins, turns palm down, and hops onto the spectator's hand. You do the move during that so the coin in your left hand is added beneath the coins your right hand puts on the spectator's hand. Don't lift your right hand, though - your fingers remain pressed over the coins. Move your thumb beneath his fingers and curl them closed, asking him to "Hold tightly." Move your left hand away, make your magic gesture, and then open it. Ask the spectator to open his hand revealing four coins.

In Addition: The handling for the third coin is the one I prefer. Geoff sometimes does it like this. Start when they have two and you have two. Your right hand picks up both coins from your left hand and holds them between thumb, first, and second fingers. The upper coin is in Retention Pass position, the lower coin just goes along for the ride. Do the Retention Pass into your left hand, dropping the lower coin and stealing the upper coin into fingertip rest. It appears as if you've placed both in your left hand. Your right fingers push the stolen coin into classic palm. Continue as described, moving your right hand over the spectator's.

Cosmic Coins Across

Geoffrey Latta

This is ultra clean - clean to the point that it satisfies almost any visual conditions you could think up. Your hands never touch, only four coins are shown at all times (both sides, too), and both hands are shown empty at all times. You'll have to try it to see how to-the-point every move is. There's not even any palming!



To start, four coins lie on the table in a horizontal row about a half inch apart, the coin that's second from the right has an expanded shell over it (fig. 499). Hold your left hand palm up. Your palm-down right hand picks up the coin at the left end of the row and holds it in Retention Pass position. Place that coin into your palm-up left hand simulating (but not doing) a Retention Pass. Repeat with the second coin (the one now on the left end of the row) placing it into your left hand. Pick up the third coin, with the shell on it, and, holding it shell side toward audience, do a Retention Pass, apparently placing it with the others in your left hand. The shelled coin should smack against the coins in your left hand just before it's stolen back into your right hand, making the proper noise.

The shelled coin remains in fingertip rest on your curled right fingers. Your right thumb and first finger pick up the fourth coin and toss it into your left hand from a few inches away, your left fingers quickly opening and closing to receive it. Make your magical gesture and open your right hand revealing the shelled coin sitting, shell side up, on your fingers. Turn your right hand over and slap the coin onto the table. Lift your hand and turn the coin over so the shell side is up again. Show your right hand otherwise empty.

Open your left hand revealing three coins. Turn it over, slapping them onto the table. Lift your hand and turn the coins over and show it empty.

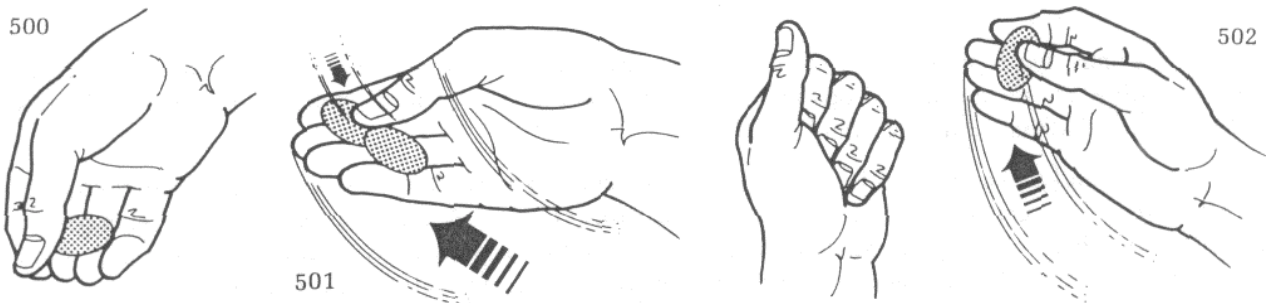

Both hands pick up their coins and display them on the fingers - three in the left and one in the right. Turn your hands over, closing your fingers into fists. Your left hand does Isolation Placement, preparing one of the coins for Han Ping Chien. The coin in your right hand remains resting on your curled fingers. jingle the coins in your left hand as if the second coin has jumped. Begin to simultaneously straighten your right fingers and turn the hand palm up. As you do your thumb lands on the edge of the shell nearest your fingertips (fig. 500). Without pausing it lifts the shell and slides it inward until it leans three-quarters off the coin beneath it (fig. 501). Note that your thumb continues to rest partially on the shell.

Begin to raise your right hand, tilting your palm toward you. As you do your right thumb slides the shell over the lower coin (fig. 502). Say, "The second coin has jumped." Now, turn your right hand palm down

Ultimate Han Ping Chien

Geoffrey Latta

This technique, which is based on an idea by Johnny Benzais, is quite unlike anything you've ever seen. It'll fool anyone who knows the standard Han Ping Chien handlings and can be utilized to produce absolute miracles, as you'll see in some of Geoffrey's routines later on. It isn't easy, but if you learn it you'll use it of ten.

Handling No. I

(Each hand's action will be taught separately, then you'll combine them.) The Left Hand's Action. Break this down into two steps: get-ready, and release. To start toss a half dollar onto your palm-up left hand. It doesn't matter where it lands as long as it's on the palm area (fig. 463). Close your fingers into a loose fist don't squeeze them flat. Turn your fist over until it's almost palm down, but still tilted a bit to the right (fig. 464).

The coin should be falling loosely inside your fist. Once your hand has turned over the coin will be resting at the lower end, near your third and pinky fingers. You won't actually do this when you perform the move, but for now (to learn it), shake your fist a tiny bit to loosen the coin so that it falls a bit farther, its lower edge cradled by your pinky. The only part of your pinky which actually touches the coin is the extreme tip, which presses it very lightly against the heel of your hand (fig. 465 shows how the coin rests, the left hand is transparent). Other than that one place the coin is loose and sort of floats inside your fist. It does not come in contact with any skin other than your pinkytip. If you lightly shake your hand you should be able to feel the coin wobble around. Once you've completed the initial get-ready turn your fist palm up again, leaving it tilted slightly to the right (fig. 466).

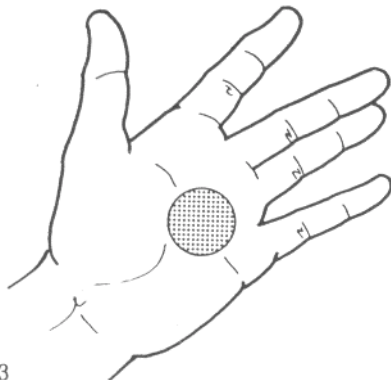

463

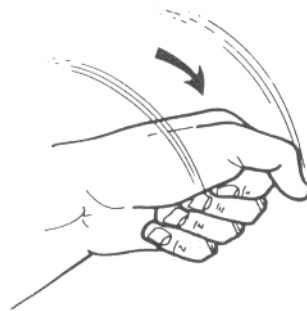

464



465

The other part of your left-hand's action is the release. Your right hand will later cover this. If you've properly loosened the coin all you have to do is simultaneously relax your left pinky and smoothly move your fist to the left. The coin will drop out of your fist and onto the table (fig. 467). The coin does not move to the right - it stays exactly where it was and your hand moves away. When your fist moves the coin stays momentarily in space then falls downward. Do not jerk your fist to the right in an effort to eject the coin because that's wrong! That can be seen. Simply moving your fist out of the way of your right hand (which is what'll eventually happen) won't be noticed because it is a reaction - not an action. Don't jerk your fist to the left, either. just move it. If the coin is held loosely, only by your pinkytip as described, it will fall out.

The Right Hand's Action. Let's assume for the moment that your right hand is empty. Hold it, palm up fingers outstretched and together, in front of and slightly to the right of you (fig. 468). Turn your hand palm down, at the same time curling your fingers into a loose fist (fig. 469).

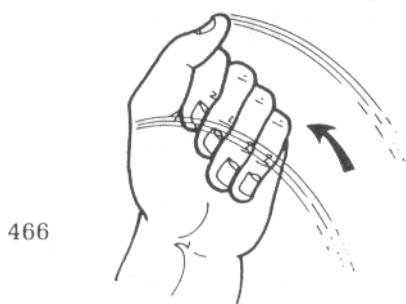

466

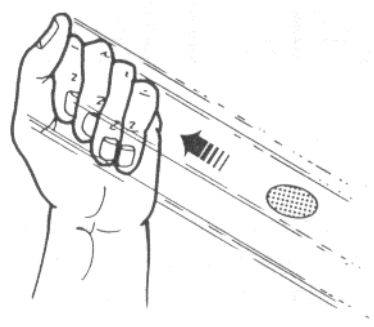

467

I've marked a spot X on the table so you know where your right hand will move to (later the coin will fall onto that spot). Your right hand moves from its palm-down fist in a short hop to X, opening its fingers (fig. 470). The movement is semi-circular; up, out, and down, as if you were rolling your hand over the top of a beach ball.



468



469

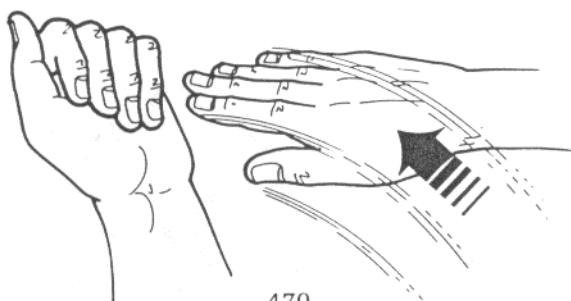
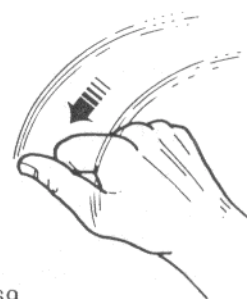

470



471

A few little, but important, things happen when your outstretched fingers hit the table. First, they spread (but remain relaxed), and second, the back of your hand bends upward (fig. 471). It'll hurt to do this at first, but it's only for a second because you immediately lift your hand straight up.

Now that you're familiar with what your right hand's going to do, put three coins in it. They're spread on your palm area with one in classic palm position. Your hand is ready to begin its sequence. Turn your right hand palm down, closing its fingers into a fist. One coin is retained in classic palm and two fall to the inside of your fingertips. Now shoot your right hand forward in its hopping (up, over, and down) motion to the table, at the same time straightening your fingers. When your hand lands on the table the two loose coins will be trapped beneath your spread fingers (fig. 472). (Don't smash your hand down because you'll dislodge the palmed coin. Bending the back of your hand upward may be a bit uncomfortable, but it makes your hand appear flat even though a coin is palmed.)

The Combined Action. Initially your hands are positioned so that your palm-up left hand is directly in front of you and your palm-up right hand is in front of your right shoulder (fig. 473 is an audience view). There's a single coin on your left palm and three coins on your right palm (one of which is in classic palm position). It will appear to the audience that the coin in your left hand vanishes and reappears in your right hand (the final sequence in a simple Coins Across).

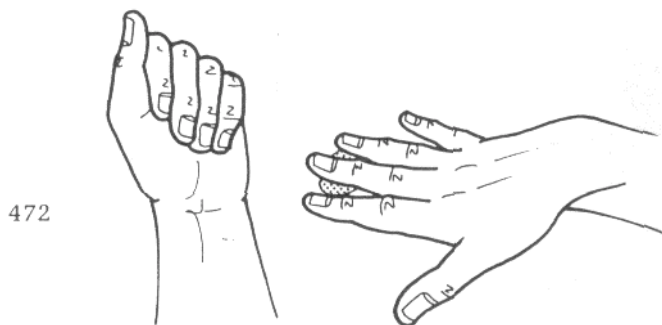

Do the left-hand get-ready, turning your fist down and up, loosening the coin so that it's held by your pinkytip. Turn your right hand palm down letting two of its coins fall onto the insides of your fingers and retaining the third in classic palm.

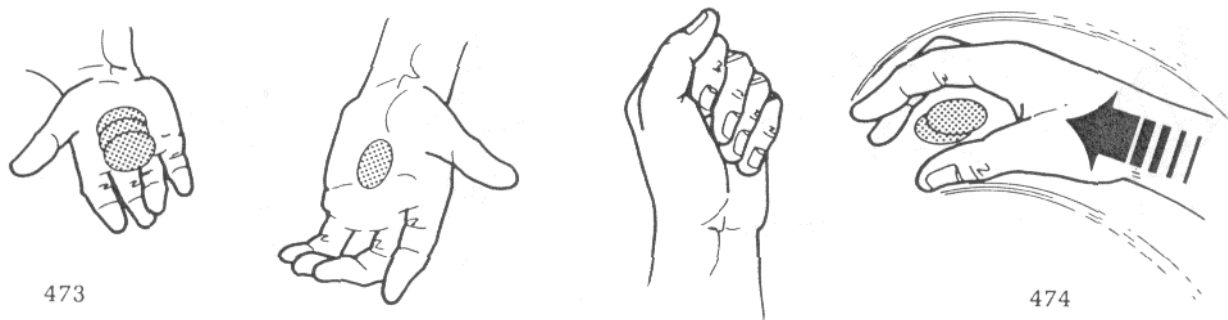

Here's where the timing comes in. Both hands perform their actions as already taught simultaneously. (Actually your left hand just does the release, since it's already done the get-ready.) There is one key moment that will clinch the illusion. Your right hand shoots forward in its hopping motion, its fingers straightening (fig. 474). When it reaches the point just shown your left hand moves smoothly to the left and out of the way. The left-hand coin will remain suspended in midair for a split second before falling (fig. 475). At that moment your right fingers land on it and push it downward onto the table (fig. 476). Actually the two coins which are trapped by momentum beneath your descending right fingers will push the lefthand coin downward.

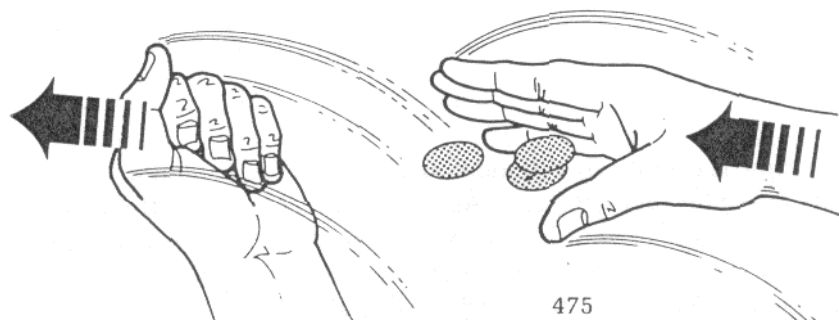

Your right hand lands on the table, fingers spread, back of the hand lifted so that it bends your fingers backward a bit, with three coins visible through the fingers (fig. 477). After a beat lift your right hand showing three coins. Pick them up and let them drop inside your closed right fist. Say your magic

mumbo-jumbo and open your left hand to show that its coin has vanished. Open your right hand revealing four coins.



Handling No. 2

Display a coin on your palm-up left hand. Close it into a fist and do the get-ready so that the coin is held loosely by your pinkytip and the fist is almost palm up. Your right hand, held palm down, is relaxed. Both hands are held near you at the same height above the table (fig. 478).

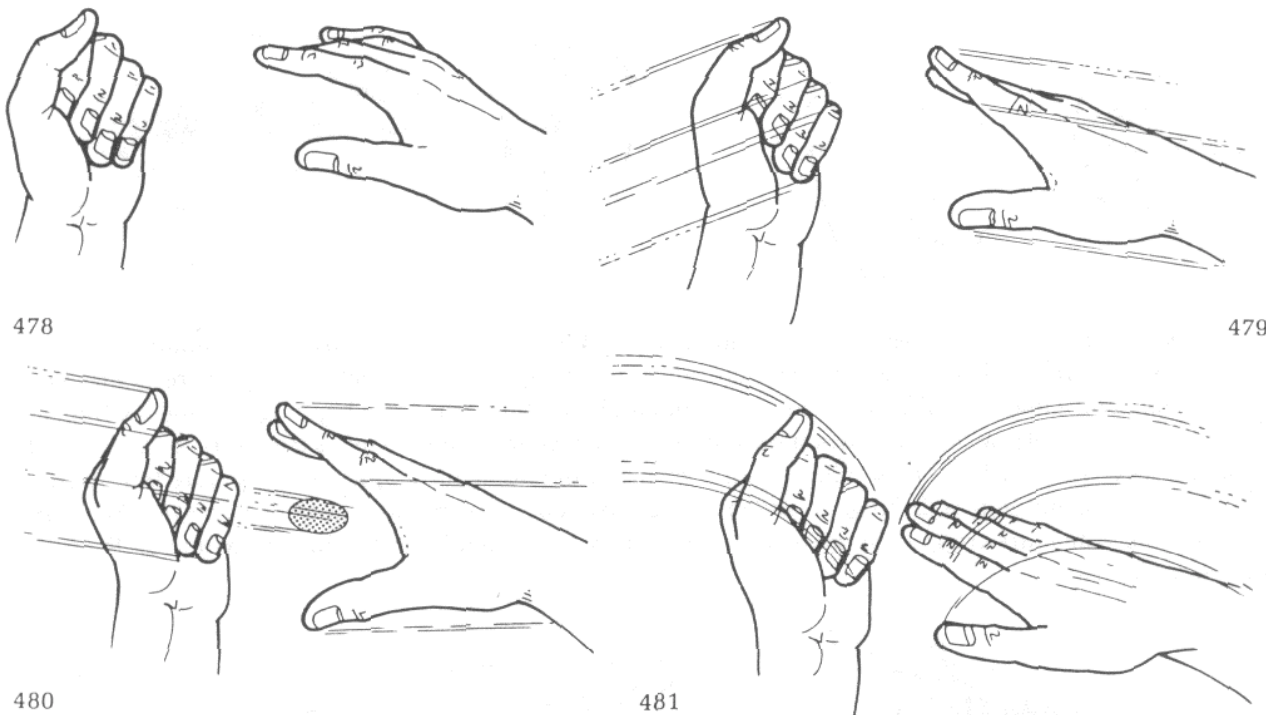

The timing on this handling is completely different (and simpler, too). Simultaneously move both hands forward and downward toward the table (fig. 479). As they move relax your left pinky allowing the coin to drop out. It'll move forward because of your left hand's momentum (fig. 480). Your right hand moves over it as it falls, covering it and slamming it onto the table (fig. 481). Your right hand's actions are the same now, spreading its fingers and bending slightly backward at the wrist.

Be careful not to jerk your left fist toward the table, simply move it forward and relax your pinky. As soon as it's released the coin it moves away, increasing the apparent distance between the hands.

Isolation Placement

Geoffrey Latta

In order to do complex routines utilizing Geoffrey's handling of Han Ping Chien you have to be able to isolate one of a number of coins in your left hand so that you can hold the others securely and release only one for the move.

Stack a group of four half dollars on your left palm. The bottom coin is on the base of your pinky and the others are spread inward and to the left (fig. 482). Simultaneously close your fingers into a fist and turn your hand palm down. The coins will automatically slide into a neat stack at the base of your pinky (fig. 483).



Press your pinky tip lightly against the inner coin's face (fig. 484). Tilt your fist slightly to the right, allowing all the coins behind the one touching your pinky to slide to the right (fig. 485). They should roll until they're nestled between your first and second fingers (fig. 486). Curl your first and second fingers inward, pushing the stack of three coins against your thumb base locking them in place.

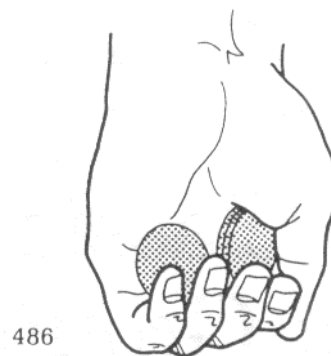
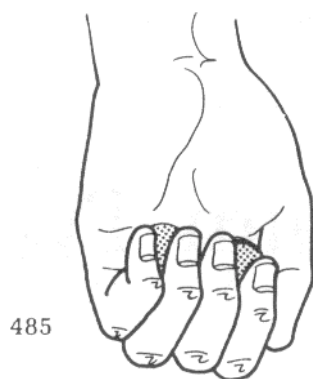
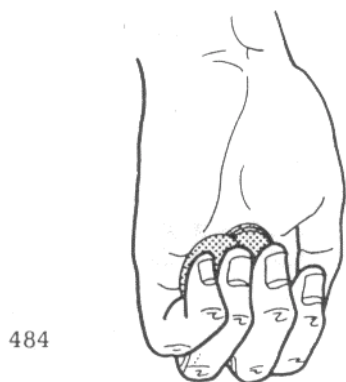

This is going to take some concentration and practice because, once you turn your left fist up, ready for the move, you must relax your pinky so that the single lower coin is very loose and ready to slide out, while tightly gripping the stack of coins between thumb, first, and second fingers.

One-Hand Turnover Switch

Geoffrey Latta

This utilitarian switch is a streamlined version of Sol Stone's One-Hand Switch, though Geoff has not seen Sol's move and developed it independently. For teaching's sake let's assume that a copper coin lies on the table. A copper/silver coin is in your right hand in fingertip rest, copper side against your fingertips (fig. 488).

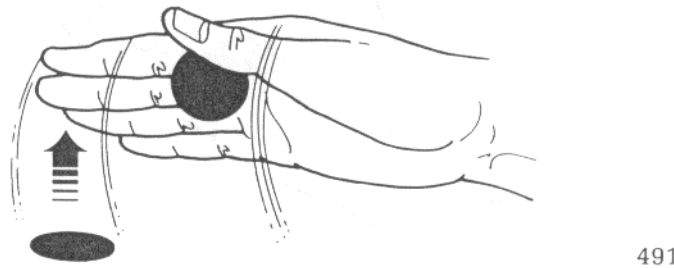
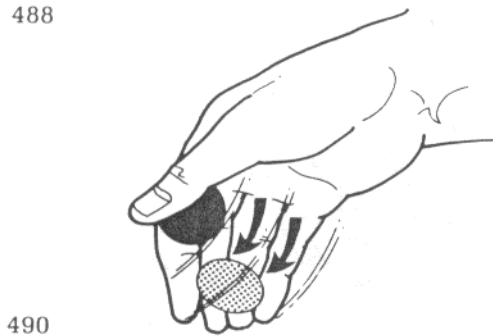
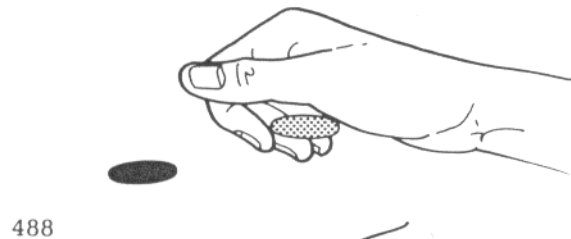

Move your right hand over the tabled coin, your thumb moving onto its inner edge. When your thumb presses downward (you must be working on a soft surface) the outer end of the coin will rise slightly. Slide your fingers beneath the copper, your thumb guiding it along the left side of your first finger (fig. 489). Lift your right hand and turn it palm down, straightening your fingers (fig. 490). Immediately slap it onto the table and raise your hand, leaving the gimmicked coin copper side up on the table (fig. 491).

Curl your fingers into a loose fist, your thumb pushing the copper coin to fingertip rest as your hand settles to the table behind the visible coin.

If there's no soft surface available Geoff will do the move on his left hand.

To Classic Palm Two Coins of a Group

Geoffrey Latta

Here's another bit of finesse that combines David Roth's technique for Classic Palming One Coin of a Group with another move so that two coins can be palmed.

Drop a stack of four half dollars on your right hand, which is palm up. Turn your hand over, your fingers curling into a loose fist, the coins stacking inside your fingers. Do Roth's technique, and then turn your hand and palm up again to display the coins - one will be in classic palm (fig. 492). Move your left first finger onto the top (outermost) coin and drag it inward onto the coin in classic palm as you say, "Four coins which you've examined" (fig. 493).

Move your left hand away and turn your right hand over loosely curling your fingers. Two coins should stay in classic palm and the other two will stack inside your fingers.

You may have to use the coin that your left first finger is dragging to push the coin that's resting partially on the coin in classic palm out of the way.

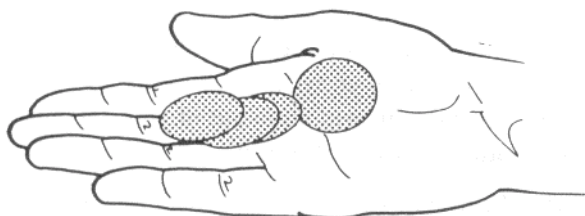

492

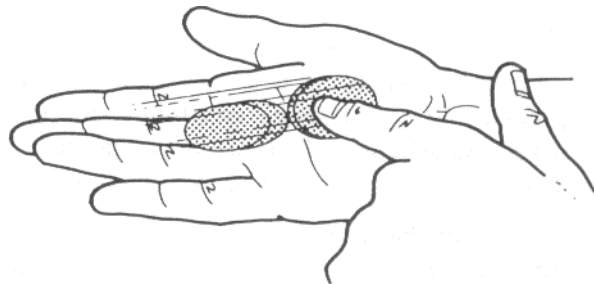

493

Thumb Touch Coins Across

Geoffrey Latta

This routine uses only one move - Geoff's Han Ping Chien. The application is also fairly easy. There is, of course, a catch: you must be able to act, and well. If you convey the proper impressions to the audience this is one of the cleanest coins across routines you could possibly want. It uses only four coins and can be done either standing or sitting.



494



495

Display the four coins and drop them on your left palm. Close your hand and do Isolation Placement as already described, getting one of the coins ready. Look at your left fist and give it a slight upward shake. Follow the path of the invisible coin as it travels across to your right hand. Glance in front of you, just a bit to your right, as if you see the coin in midair (fig. 494 is the audience view). You've followed the path of the imaginary coin to your right hand and, when it reaches it, pretend to grab it, your hand turning palm up with your thumb behind your straightened fingers (fig. 495).

Do it with conviction. If you don't really believe that your right hand has caught a coin then there's no way you can convince the audience. It works, too - they'll think you're actually holding a coin in your right hand.

Now, simply place the coin that you've caught with your right hand onto the table. Of course, you do the Han Ping Chien move so that as your right hand smacks down onto the table, your left hand moves smoothly to the left. The isolated coin slides out of it and, as your right hand descends, your fingers push it downward onto the table. The illusion is perfect, as if you were simply smacking the "caught" coin onto the table. It's also a little easier than some other applications of the move because there's nothing else in your right hand to worry about (no extra coins, etc.).

After you lift your right hand, leaving the single coin on the table, turn it over to show it empty. Turn it palm down and make a fist. Shake your left hand and open it to display three coins. Maneuver them by shaking your hand so that they're stacked inward in position for Isolation Placement. Do the move as you close your hand and turn it over, getting another coin ready for the Han Ping Chien. Then, turn your left fist up again. Give it a shake and follow the invisible coin, catching it with your right hand, which immediately smacks it to the table as you do the move. The second coin will slide out of your left fist and, as your right fingers push it downward, clink against the coin already on the table,

Simply repeat the entire business as described to get the third and fourth coins across. Remember that your aim has to be good here so that each coin that's released from your left hand lands on the coin or coins already on the table.

Standup Spectator Coins Across

Geoffrey Latta

You need only four coins for this standup anytime, anywhere, coins across into a spectator's hand. Let the spectators examine the coins. When you get them back display them on your palm-up right hand. Do Geoff's technique for Classic Palming Two Coins of a Group as already taught. Afterward two coins are classic palmed in your palm-down right hand and the other two rest inside your curled right fingers. Move your thumb onto the inner edges of the coins so you can straighten your fingers, still holding them (fig. 496). Toss the two coins into your palm-up left hand from a distance of about eight inches, immediately closing it. Silver will be seen flying into your left hand and it's impossible to tell that there are fewer than four coins.

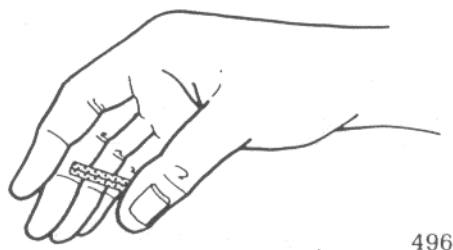

Ask a spectator to hold one of his hands palm up between you and rest your right hand lightly on top of it (fig. 497). Give your left fist a shake and follow the flight of the imaginary coin with your eyes as it travels from your left fist to his hand. Time it right and, when you look at his hand relax your right palm a bit and

drop one of the two palmed coins onto his hand. The second coin remains in palm. (There's nothing I can explain about this, which is an old idea. It's just control that comes with practice. You should be able to classic palm four coins and let them drop one at a time.)

Lift your right hand so they can see the coin. Say, "That's the first one." As you say, "Three left," very quickly open and close your left fist (a la Ross Bertram) flashing some silver. They won't be able to see how many coins are there - but it looks like three if you're casual about it. Move your right hand back over his hand and repeat the action again, shaking your left fist and watching the coin travel to his hand. When it arrives relax your right palm and allow the second coin to drop onto the first with a clink.



497

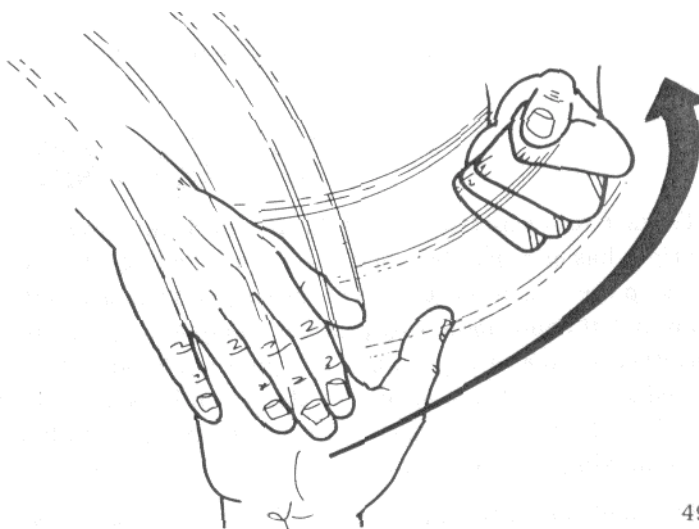

498

Move your right hand away so they can see both coins. Open your left hand to show two coins still there. As you close your left hand do Isolation Placement getting one of the coins ready. Your right hand picks up the two coins from the spectator's hand and does the Roth technique for Classic Palming One Coin of a Group, turning palm up afterward to display them. Do Geoff's Han Ping Chien on the spectator's hand. Briefly: your palm-up left fist should be directly beside the spectator's hand. Your right hand turns palm down, one of its coins dropping to fingertips. It does its little hop forward onto the spectator's hand, fingers straightening and pushing the coin that slides out of your left fist downward (fig. 498). Immediately lift your right hand and say, "Two."

Cover his hand again, shake your left fist, and follow the invisible coin over to his hand. Relax your right palm and allow the third coin to drop onto the two already there. Lift your right hand to reveal three coins and open your left fist to display the last coin.

Your right hand picks up the coins that are in the spectator's hand. At the same time your left hand does the Han Ping Chien get-ready so the last coin is ready for the move. Again, your palm-up left fist is beside the spectator's hand. Your palm-up right hand displays the three coins, turns palm down, and hops onto the spectator's hand. You do the move during that so the coin in your left hand is added beneath the coins your right hand puts on the spectator's hand. Don't lift your right hand, though - your fingers remain pressed over the coins. Move your thumb beneath his fingers and curl them closed, asking him to "Hold tightly." Move your left hand away, make your magic gesture, and then open it. Ask the spectator to open his hand revealing four coins.

In Addition: The handling for the third coin is the one I prefer. Geoff sometimes does it like this. Start when they have two and you have two. Your right hand picks up both coins from your left hand and holds them between thumb, first, and second fingers. The upper coin is in Retention Pass position, the lower coin just goes along for the ride. Do the Retention Pass into your left hand, dropping the lower coin and stealing the upper coin into fingertip rest. It appears as if you've placed both in your left hand. Your right fingers push the stolen coin into classic palm. Continue as described, moving your right hand over the spectator's.

Cosmic Coins Across

Geoffrey Latta

This is ultra clean - clean to the point that it satisfies almost any visual conditions you could think up. Your hands never touch, only four coins are shown at all times (both sides, too), and both hands are shown empty at all times. You'll have to try it to see how to-the-point every move is. There's not even any palming!

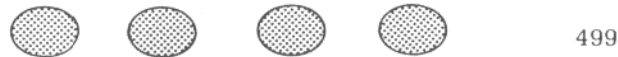

To start, four coins lie on the table in a horizontal row about a half inch apart, the coin that's second from the right has an expanded shell over it (fig. 499). Hold your left hand palm up. Your palm-down right hand picks up the coin at the left end of the row and holds it in Retention Pass position. Place that coin into your palm-up left hand simulating (but not doing) a Retention Pass. Repeat with the second coin (the one now on the left end of the row) placing it into your left hand. Pick up the third coin, with the shell on it, and, holding it shell side toward audience, do a Retention Pass, apparently placing it with the others in your left hand. The shelled coin should smack against the coins in your left hand just before it's stolen back into your right hand, making the proper noise.

The shelled coin remains in fingertip rest on your curled right fingers. Your right thumb and first finger pick up the fourth coin and toss it into your left hand from a few inches away, your left fingers quickly opening and closing to receive it. Make your magical gesture and open your right hand revealing the shelled coin sitting, shell side up, on your fingers. Turn your right hand over and slap the coin onto the table. Lift your hand and turn the coin over so the shell side is up again. Show your right hand otherwise empty.

Open your left hand revealing three coins. Turn it over, slapping them onto the table. Lift your hand and turn the coins over and show it empty.

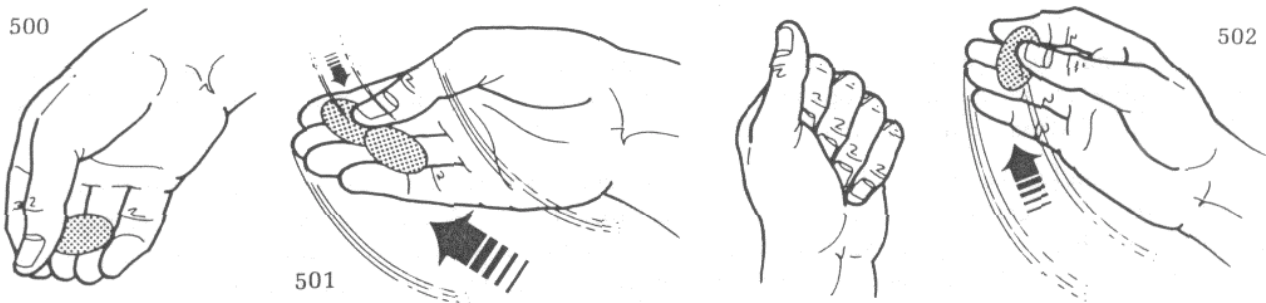

Both hands pick up their coins and display them on the fingers - three in the left and one in the right. Turn your hands over, closing your fingers into fists. Your left hand does Isolation Placement, preparing one of the coins for Han Ping Chien. The coin in your right hand remains resting on your curled fingers. jingle the coins in your left hand as if the second coin has jumped. Begin to simultaneously straighten your right fingers and turn the hand palm up. As you do your thumb lands on the edge of the shell nearest your fingertips (fig. 500). Without pausing it lifts the shell and slides it inward until it leans three-quarters off the coin beneath it (fig. 501). Note that your thumb continues to rest partially on the shell.

Begin to raise your right hand, tilting your palm toward you. As you do your right thumb slides the shell over the lower coin (fig. 502). Say, "The second coin has jumped." Now, turn your right hand palm down

and slap its shelled coin onto the table at the same time doing the Han Ping Chien so that your left fist releases one of its coins and moves to the left. Two coins will be trapped beneath your right fingers, one with a shell over it. Lift your right hand and immediately turn the two coins beneath it over. Show it empty.

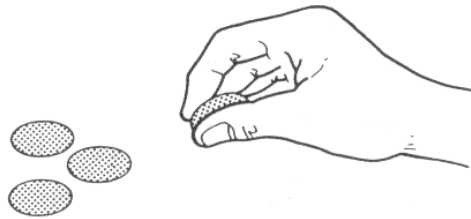

503

Open your left hand showing two coins, turn it over slapping them to the table, lift it, turn the coins over, and show your hand empty.

Both hands move simultaneously. Your right hand picks up the regular coin and places it on top of the shelled coin and lifts both. Your left hand places one of its coins on top of the other and lifts both. Both hands display their coins on the fingers of each palm-up hand. Turn your hands palm down. Your left hand does Isolation Placement getting one coin ready. Your right hand classic palms one of its coins (via the Roth technique), and allows the shelled coin to rest on the insides of the fingers.

Relax your right palm allowing the palmed coin to fall onto the shelled coin with a clink. Turn your right hand palm up, straightening your fingers, your right thumb picking up the shell (which is between the two real coins) and spreading it inward as already described - three coins are shown. Raise your right hand as before, your thumb pushing the shell over the bottom coin. Turn your right hand over, slapping its two coins onto the table at the same time doing Han Ping Chien so that three coins are under it by the time it hits the table.

Lift your right hand to show three coins and turn them over. Show your hand empty. Open your left hand to show one coin. Turn it over, slapping it onto the table. Immediately turn the coin over and show your hand empty. Your right hand stacks its coins so that the shelled coin is on bottom and picks them up. Your left hand lifts the single coin. Both hands display their coins on the fingers.

Close both hands into fists. Your left hand does the get-ready for Han Ping Chien while your right hand classic palms one of its coins. Relax your right hand, allowing the palmed coin to drop with a clink. As you open your right hand your right thumb pulls the shell (which is over the bottom coin) upward and spreads it inward so that four coins appear to be there. Raise your right hand, your thumb pushing the shell back over the bottom coin. Turn your hand over and slap it onto the table, doing Han Ping Chien so that four coins are beneath it when it's lifted. Immediately turn the coins over and show your right hand otherwise empty. Open your empty left hand.

The coins on the table should be spread. Move your right hand over the shelled coin and slide your thumb beneath it (fig. 503). Your thumb pulls the coin into finger palm. Move your right hand over another coin and relax your thumb, letting the coin drop out of the shell onto one of the tabled coins. The shell is retained in finger palm. Take those two coins and drop them on a third, drop those on a fourth, and have them examined.

Silver Extraction No. 1

Geoffrey Latta

I've always liked this effect - laymen love it. I saw the props laying on Geoff's desk and asked him about them. He showed me three different handlings and I like two of them - so I'm including only those two! This one is more difficult. You need all the usual stuff for Boris Zola's trick: a small glob of silver about the size of a nickle (usually an irregularly shaped piece of melted solder), and a clear plastic disk the size of a half dollar. You also need an expanded shell that fits over the disk.

To prepare place the shell over the clear disk and hold that in finger palm on your palm-up right hand. The silver glob is in Deep Back Clip beneath the shelled disk (fig. 504 is an exposed view). Your palm-up left hand holds a cigarette lighter. Your hands are held comfortably in front of you and you should be standing near a table. Remember to keep your right fingers tilted downward so you don't expose the silver glob.

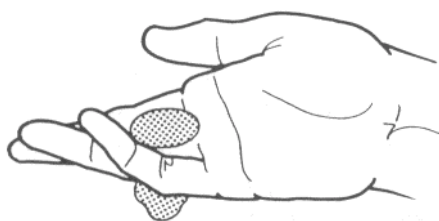

504

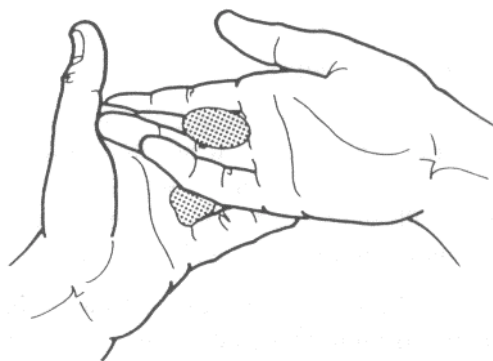

505

To perform, extend your left hand toward the spectator, handing him the lighter. As you retract your left hand after he's taken it, move it directly beneath your right hand (fig. 505). Allow the silver glob to drop onto your left fingers in finger palm as they pass beneath and immediately curl your left fingers into a loose fist, the glob in fingertip rest.

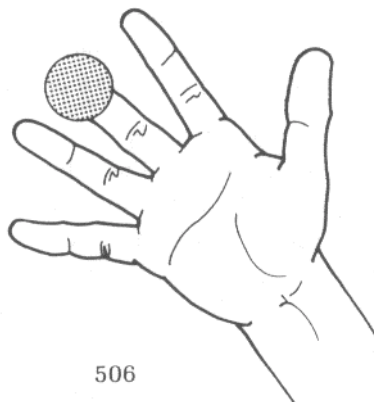

506

Your right thumb pushes the shelled disk onto the extreme tip of your second finger. Spread your fingers and display the coin (fig. 506). Close your fingers into a fist as you turn your hand palm down. Push the shelled disk into classic palm and as you lower your fingers let the disk drop out of the shell to fingertip rest.

Lower your left fingers a bit and move your thumb onto the glob (fig. 507). Do that as you ask the spectator to wave the lighter (lit, of course) beneath your right fist. Make sure he doesn't get too close or you'll be in trouble. Shove your left fingertips into the thumbhole of your right hand (fig. 508). Your left thumb pushes the silver glob to your left fingertips as you pretend to pull it out of your right fist (fig. 509). Move your right thumb onto the disk and push it to your fingertips as you turn your hand palm up to display it (fig. 510). Turn your hands palm down and drop both on the table for examination.

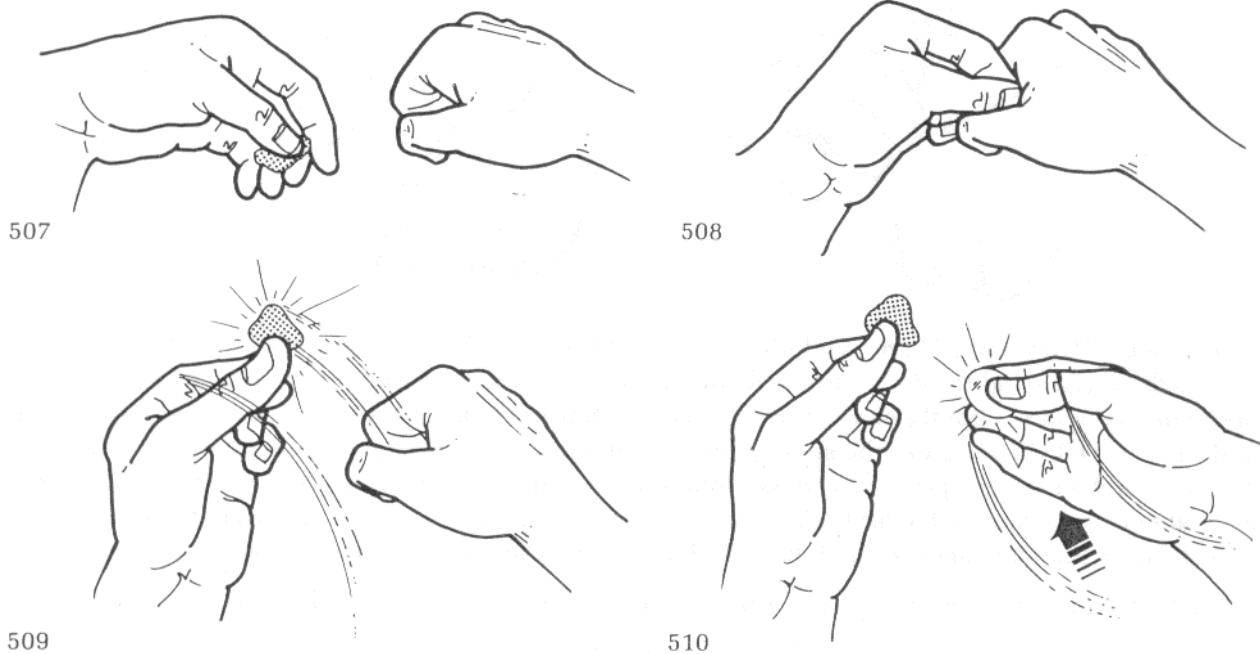

Silver Extraction No. 2

Geoffrey Latta

Geoff uses this handling mostly for laymen. That's because the action occurs in the spectator's hand. In your right jacket pocket have the silver glob and lighter. The clear disk is inside the expanded shell in a convenient pocket.

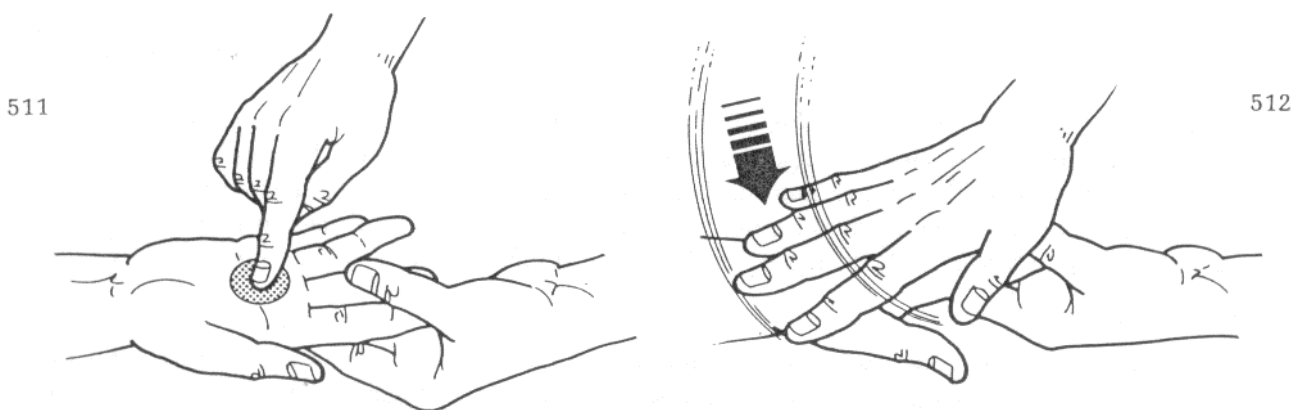

To perform, remove the shelled disk and display it shell side up, taking advantage of the fact that your hands are otherwise empty. Ask a spectator to extend his right hand, palm up, fingers straight. Lay the

shelled disk on the base of his fingers for a second and press it downward with your right first finger (fig. 511). Pick it up and say, "I'm going to try and steal this from your hand." Place it back on his hand (still on his finger base) and immediately cover it with your palm-down right hand - your right second finger base directly over and pressing on the shell (fig. 512). Push downward on his hand so that he's forced to push upward. Say, "I'm going to lift my hand and try and take the coin - but I want you to also try and take it."

513

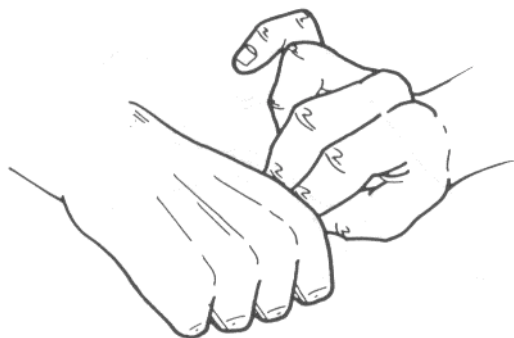

514

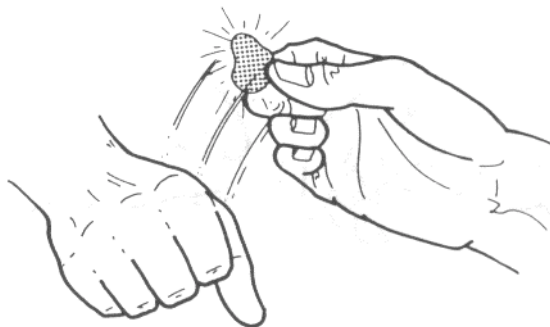

Count aloud, "One, Two, Three," and lift your hand straight up. The spectator will close his hand into a fist immediately, around the disk. The shell will adhere to your second finger base. It won't stay there for more than a second so rapidly and naturally curl your fingers. Immediately reach into your right pocket and drop the shell. Finger palm the silver glob and come out of the pocket openly holding the lighter.

Hand the lighter to the spectator and ask him to light it and wave it around his closed fist. When he's done that once or twice reach over to the thumb hole side of his fist and insert your right fingertips into it (fig. 513). Your thumb pushes the glob to your fingertips as you pretend to pull it out of his fist (fig. 514).

Drop it onto the table, or onto his other hand, and ask him to open his hand revealing the clear disk.

In Addition: Geoff also uses this switch for a copper-silver transposition in a spectator's hand. You have to use an expanded English penny shell with a silver coin inside, since a half-dollar shell won't fit over an English penny, but the mechanics of the switch remain the same. The unique thing about this switch is that your hands are obviously empty before it happens.

Wild Coin No. 3

Geoffrey Latta

After David Roth had developed his Wild Coin handlings he called Geoff on the phone and described them. Geoff then developed the following three handlings which tackle the Wild Coin plot from an entirely different angle than David's. Though none of these handlings involve lapping, they're easier to perform if you're sitting at a table. Each method begins and ends the same way, and three central change series are described - read all three, try them, and select the one you prefer (though Geoff always uses the third one).

Set-up Sequence

To prepare, place three silver coins in a small purse (of the type already described). Two copper coins are classic palmed in your right hand, and a copper/silver coin is in fingertip rest (in the some hand) resting in a relaxed fist on the table. Your left hand shakes the purse, jingling the coins, and hands it to a spectator.

Ask him to open it, remove the coins, examine them, and place them back in the purse. After he's done all that take the purse from him and set it open on the table in front of you, just a bit to your right (fig. 515).

The Fake Take Out

Raise your right hand and start moving it toward the purse, at the same time straightening your fingers. Your thumb moves beneath the copper/silver coin and holds it in place beneath your fingers (fig. 516).

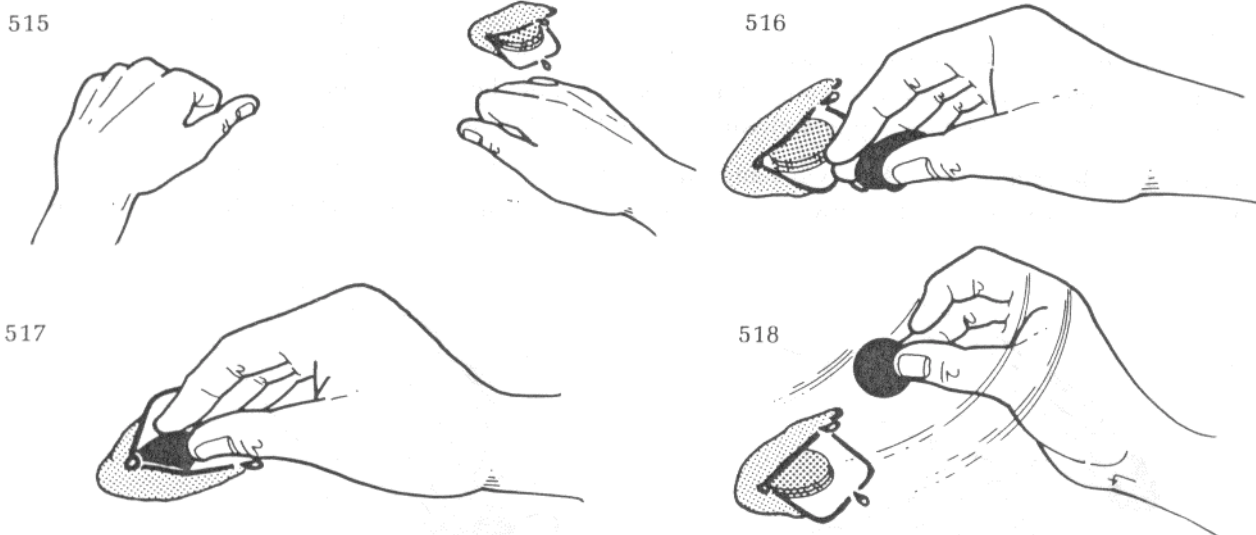

Insert your fingertips into the purse, your thumb pushing the copper/silver coin to your fingertips (fig. 517). All of this takes place inside the purse and is hidden from the audience. Drag the coin across the coins actually resting in the purse as you remove it for display (fig. 518). It appears as if you've merely reached inside the purse and removed one of the silver coins.

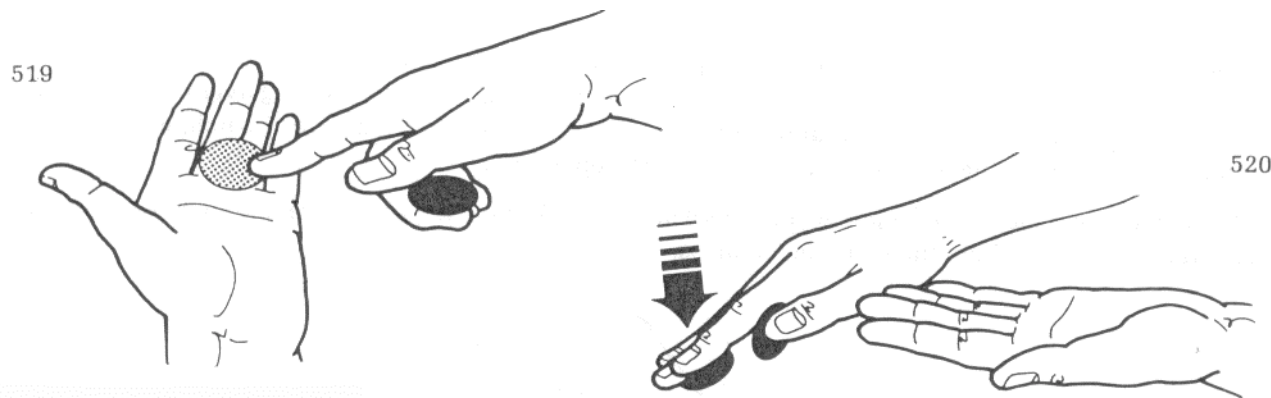

Change Series No. I

Drop the apparently silver coin onto your palm-up left hand in finger palm. Pause for a second and point to it with your right first finger. At the same time relax your right palm and allow one of the classic palmed coppers to drop to fingertip rest (fig. 519). Curl your right first finger and move your hand away.

Curl your left fingers into a fist and say your magic words. The copper/silver coin will automatically turn over as you make the fist. Open your fingers revealing a copper coin, which now rests somewhere on your palm area. Your right hand moves over the copper and begins the One-Hand Turnover Switch, picking up the copper/silver coin and switching it for the real copper coin in fingertip rest. As you turn the coin over slap it onto the table in front of your left hand (fig. 520). When you lift your right hand you'll find that the copper/silver coin will be back in position, held beneath your straightened fingers by your thumb, for the Fake Take Out.

Without pausing your right fingers go into the purse and do The Fake Take Out apparently removing another silver coin - actually, of course, it's the silver side of the copper/silver coin. Drop the silver coin onto your palm-up left hand in finger palm. Close your left fingers and open them, revealing that the silver coin has changed to copper. At the same time your right fingers curl and allow the second copper to drop onto them in fingertip rest. Once you've opened your left fingers your right hand picks up the copper coin and does the One-Hand Turnover Switch, switching in the real copper coin as it's slapped onto the table. Place it onto and overlapping the copper coin already there, spread to the right (fig. 521).

Your right hand immediately moves to the purse and does The Fake Take Out, apparently removing the third silver coin from the purse (and without the scraping noise this time!). Drop it onto your palm-up left hand in finger palm. Open and close your left fingers, changing the coin to copper. Your right hand places it onto and overlapping the two coppers already on the table (obviously you cannot turn it over).

(After I've described the other two handlings and the end sequence there will be a sleight Geoff sometimes uses at this point to show both sides of all three coppers before going into the end sequence.)

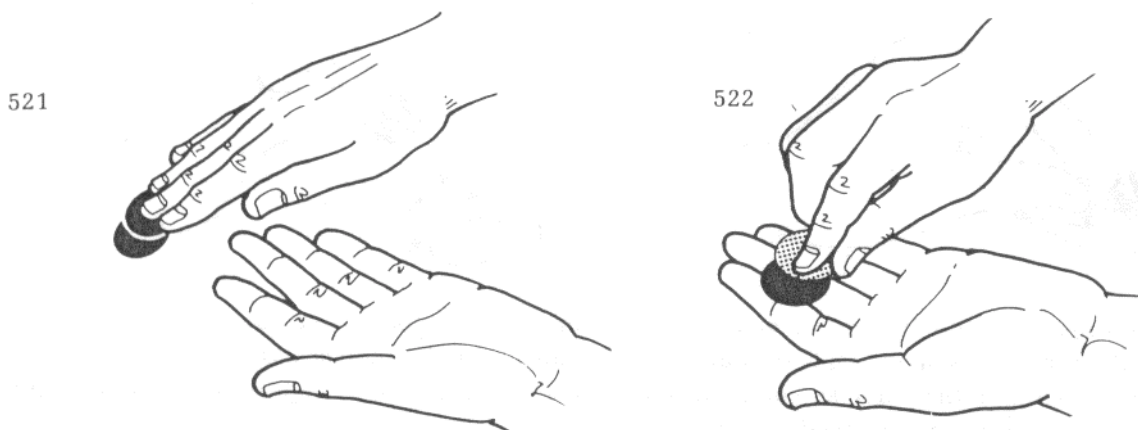

Change Series No. 2

Do the first change sequence until you've apparently removed one of the silver coins from the purse, placed it on your palmup left hand, and done the one-hand change secretly turning over the copper/silver coin. Open your left hand to reveal that it's copper and do the One-Hand Turnover Switch, your right hand slapping it onto the table and switching in the real copper coin.

Your right hand moves to the purse and does The Fake Take Out, apparently removing the second silver coin from the purse. Now, the handling changes.

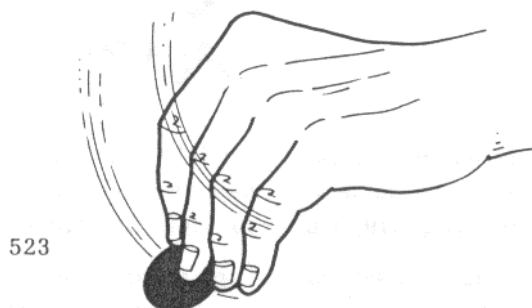

Your right hand places the silver coin onto and overlapping the copper coin that's on the table, lifts both, and places them on your left fingers (fig. 522). Move your left thumb onto the coins. Turn your left hand palm down, your left thumb pushing the copper/silver coin - now copper side up - onto the table (fig. 523). The real copper is retained beneath your left fingers by your thumb. This is an old change of Stewart Judah's from Bobo.

Once the copper/silver coin has been placed on the table your left fingers curl into a fist and your left hand turns palm up. Crumple your fingers and say your magic word, opening them to reveal a copper coin. Simultaneously your right hand transfers its copper coin from classic palm to fingertip rest.

Your right hand reaches to the copper coin that's on the table and does the One-Hand Turnover Switch, leaving a real copper on the table and concealing the copper/silver coin in right-hand fingertip rest. Your left hand places its copper coin onto and overlapping the one on the table. Then, your right hand moves to the purse and does The Fake Take Out, apparently removing the third silver coin from the purse. Place the silver coin onto your palm-up left hand in finger palm. Your right hand picks up the two coppers from the table and holds them, spread, between thumb, first, and second fingers (fig. 524). Move your left thumb onto the left edge of the silver coin and press lightly downward so that the right edge lifts (fig. 525).

Your right hand guides the silver coin between the coppers (fig. 526). Your right finger positions are: thumb on the upper side of the top copper coin, first finger on the underside of the copper/silver coin in center, and second finger on the underside of the lowermost copper coin. Start to close your left fingers, allowing them to turn your right hand over (fig. 527).

Your right second fingertip releases the copper coin it's been resting against and it falls onto your left palm. Your right hand immediately moves upward with the two seemingly copper coins (fig. 528).

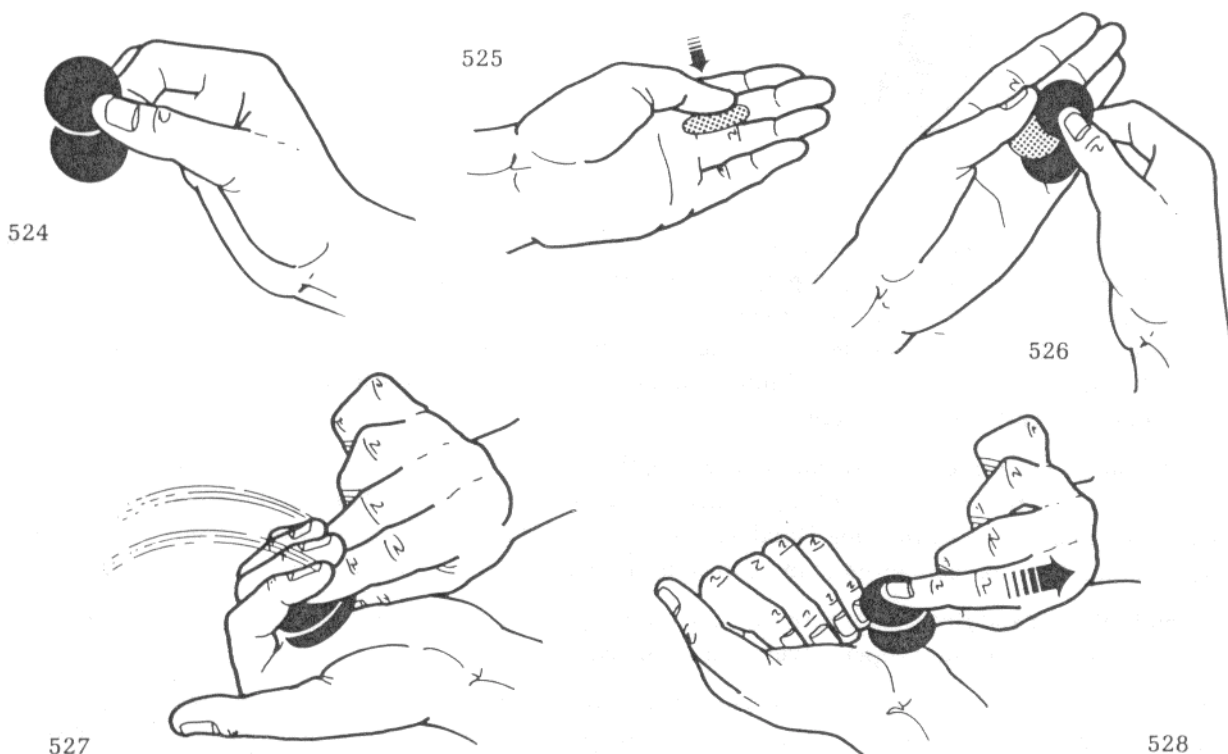

Your right hand places its two coins on the table. Crumple your left fingers and then open them, revealing a third copper coin. Place it onto and overlapping the two already on the table.

Change Series No. 3

(The set up for this is basically the same, though one of the real copper coins is finger palmed in your left hand to start, leaving only one copper classic palmed in your right hand.) Insert your right fingertips into the purse and do The Fake Take Out, apparently removing one of the silver coins. Do a Retention Pass into your left hand while keeping your left fingers curled so you don't expose the copper coin in finger palm. The copper/silver coin remains in your right hand, of course, in fingertip rest. Open your left hand revealing a copper coin. Show both sides of the copper as you table it.

Do The Fake Take Out again, removing the second silver coin from the purse. Do a Retention Pass, ostensibly placing it into your left hand. It's retained in your right hand in fingertip rest. Move your right thumb onto the inner edge of the copper/silver coin and push it up along your fingers (fig. 529). When it's pushed far enough it'll naturally flip over and fall back to fingertip rest - now silver side up.

Your right hand reaches to the copper coin already on the table and does the One-Hand Turnover Switch, leaving the copper/silver coin on the table copper side up and taking the real copper coin in fingertip rest. As you do that say, "That leaves one copper coin here. . . ." Your right hand immediately moves toward the purse, at the same time transferring the copper to thumb palm. Once your thumb has gripped the coin your fingers straighten and dangle over the purse as you continue, ". . . one silver coin here...." Now, move your right hand over your left fist and do The Vernon Load secretly dropping the thumb palmed copper into it as you conclude, and one silver here." (The Vernon Load will be described later in CopSilBrass.)

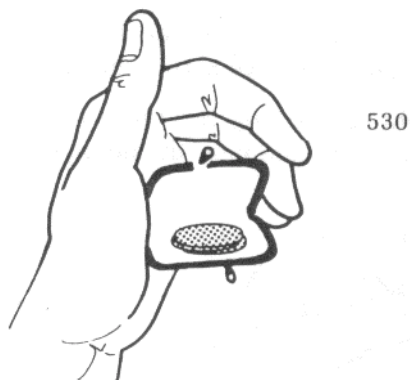
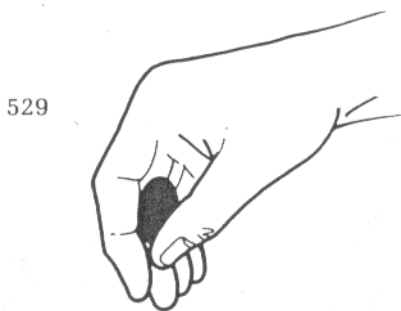

Open your left fist revealing another copper coin. At the same time your right hand relaxes and lets the classic palmed copper drop to fingertip rest. Your left fingers flip their coin over a few times. Your right hand reaches to the copper/silver coin that's on the table and does the One-Hand Turnover Switch as you say, "One copper here. . . ." Your left hand slaps its coin onto the table next to the other copper as you continue, ". . . another copper here. . . ." Your right hand moves to the purse and does The Fake Take Out as you conclude, ". . . and one silver here."

Do a Retention Pass into your left hand, retaining the coin in right-hand fingertip rest. Flip the coin over with your thumb so that it's silver side up as already described. Your right hand picks up one of the copper coins on the table and does the One-Hand Turnover Switch placing the copper/silver coin onto the table copper side up. The real copper ends in righthand fingertip rest afterward.

Your right thumb and first finger turn over the other copper coin that's been lying on the table and places it onto and overlapping the copper/silver coin to the right.

Curl your right fingers transferring the copper coin to thumb palm. Do The Vernon Load as you wave your right hand over your left fist, secretly loading the copper coin inside it. Open your left hand to reveal the copper and then place it onto the table with the others.

End Sequence

This is Geoff's handling of an Al Baker technique originally described in Bobo. Your right hand picks up all three coppers from the table and holds them stacked in finger palm in your palm-up hand. Your left hand picks up the purse while your right hand jingles the coins to cover any noise made by the silvers in the purse.

Your left hand's grip on the purse is important - your third finger presses the hinge of the frame against the base of your thumb (fig. 530). Your first and second fingers are curled rather widely around the front of the purse so there's a space behind them. Tilt the mouth of the purse slightly toward you.

Move your palm-up right hand in front of your left hand, your right pinky resting on and hugging your left first finger (fig. 531). It appears to the spectators that your right hand turns palm down and drops the coins into the purse. It's difficult to explain how to make that look convincing because the coppers actually go between the purse and your first and second fingers - right into finger palm! Your right hand doesn't just turn over, your whole forearm, from fingertips to elbow, rotates (fig. 532). And, it doesn't just turn, but hops a bit as it does - in other words your hand moves up a little, turns over, and then descends. More than anything else it's the body language of your entire arm that conveys the impression that you've dropped the coins into the purse.

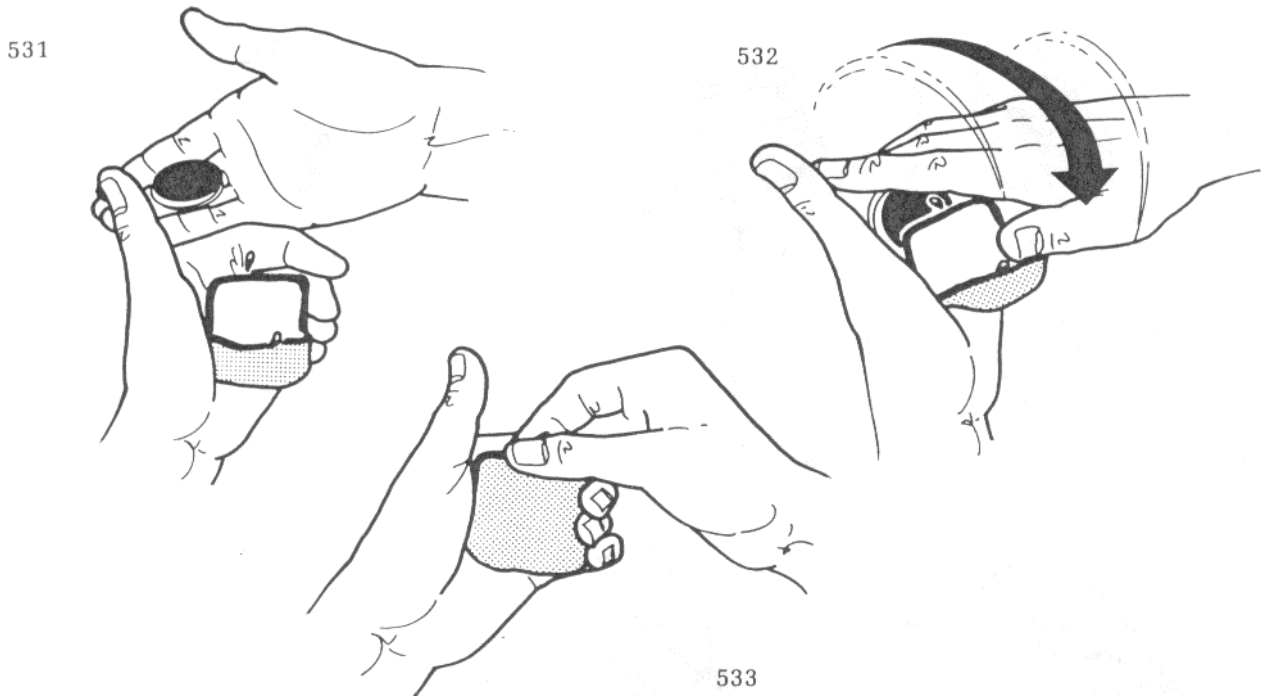

So, when your hand turns over the stack of coppers will drop into left-hand finger palm. Your right thumb immediately moves behind the purse and snaps it shut (fig. 533). Your right hand lifts the purse, jingles the coins, and hands it to a spectator to open. At the same time your left hand settles into a relaxed fist on the table. When the spectator opens the purse he'll find that the coppers have changed back to silvers.

In Addition: What follows is an optional display sequence that you could use after Change Series No. 1, before you ostensibly drop the coppers back into the purse. It isn't necessary in Change Series No. 2 or No. 3 because both sides of all the coppers are shown during the sequence.

Multiside Display Sequence

Three copper coins lie on the table overlapping each other - the one farthest to the right is the copper/silver coin. Lift and place them onto your palm-up left hand as in figure 534; the bottom coin in finger palm and the other coins spread toward your fingertips.

Turn your right hand palm down and rest your second and third fingers flatly on the uppermost coin (fig. 535). Note that your first finger rests on the middle coin - which protrudes visibly to its left. Press downward with your fingertips so that your thumb can slip beneath the top two coins (fig. 536 is an exposed view). Your thumb immediately starts pushing the center coin to the left (fig. 537). Don't worry about the noise it makes scraping against the top coin because that's covered by the ambiguity of the pick up. Simultaneously your left hand tilts palm toward you concealing the fact that it holds only one coin (the spectators think it holds two), Your right hand also turns palm toward you (fig. 538).

Your right hand moves forward and places the visible copper coin onto the table. Do the One-Hand Turnover Switch, leaving the copper/silver coin on the table copper side up. The real copper coin ends in fingertip rest. Rapidly move your right hand over your left hand, which turns palm up beneath it. Your right second and third fingers lay the concealed copper onto and overlapping (to the right) the one already there (fig. 539). Immediately draw your right fingertips back so the second copper coin is visible. Pick it up, simulating your previous actions, placing it onto and overlapping the copper coin already on the table. Turn it over simulating, but not doing, the switch. Finally, your right hand moves back to your left hand, picks up the third copper coin, and places it onto the two already on the table.

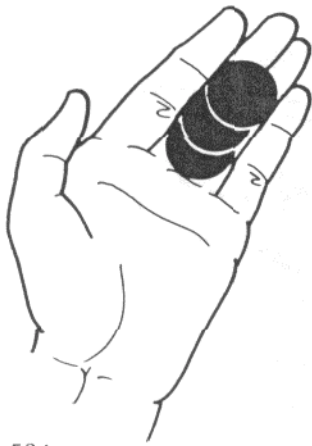

534

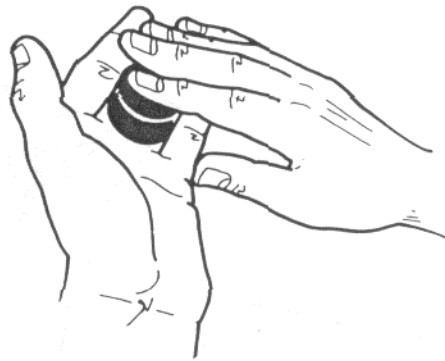

535

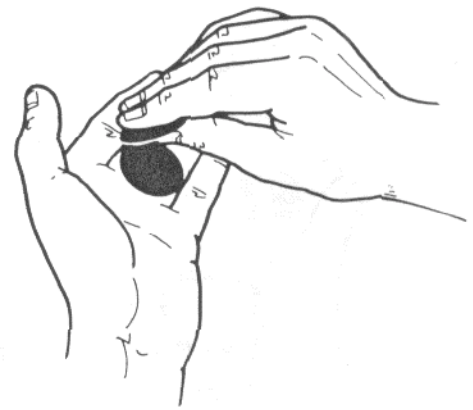

536



537

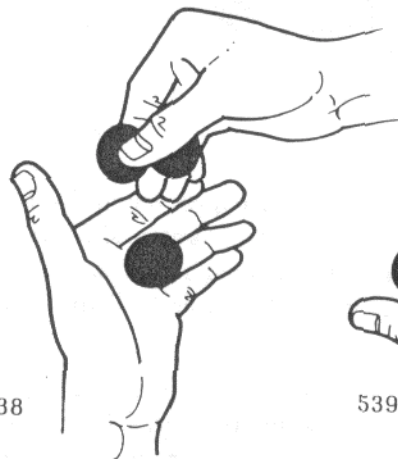

538

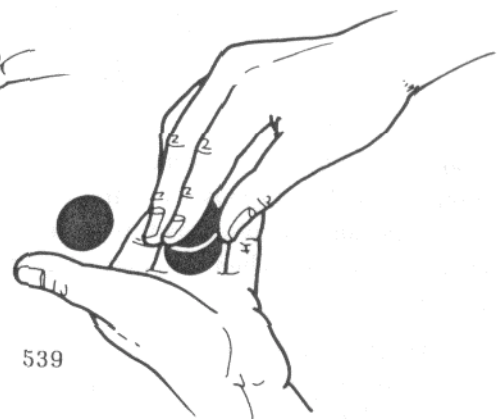

539

QuadraQuicksand Coins Away

Geoffrey Latta

This is a terrific routine for laymen - and it'll even fool magicians, too. Geoff doesn't claim the presentation, but his combination of it and some wonderfully deceptive handling make it unique. It's simply a one-at-a-time four coin vanish that can be done standing and surrounded.

You need three coins and an expanded shell to match. To begin, lay the coins on your palm-up left hand as in figure 540; the bottom coin is in finger palm, the shell is directly above it, and the other two coins above that. All are spread outward toward your fingertips. Say, "I've got four coins. What's going to happen is I'm going to close my hand, take one of the coins, and throw it away." As you talk do exactly what you say, closing your left hand into a fist and turning it over. The shell will automatically slide over the bottom coin. Your right hand comes over and, though it never gets closer than about six inches, pretends to take a coin from your left hand and toss it away (fig. 541).

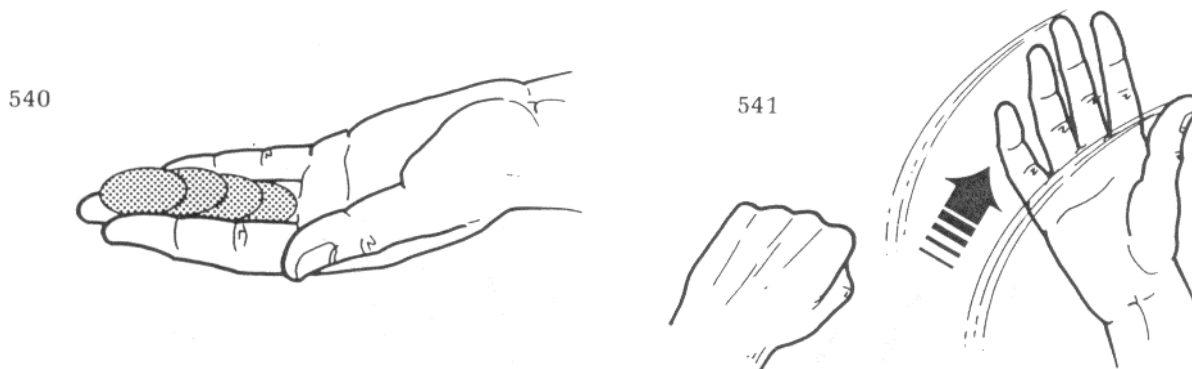

Continue, "And when I do this, of course, I'll only have three left." As you say, ". . . three left," turn your left hand palm up and open it revealing only three coins. "And now that I've explained the premise, we'll get on to the magic." You should be able to see the action of the patter - you're going to ignore the fact that the magic is actually happening.

Go back to the last patter line because the action starts from there. When you say, "And now that I've explained. . . on to the magic," your right hand comes over and your right second and third fingers push the three coins into a stack (fig. 542). Your thumb rests on the stacks inner edge and presses downward so that your second and third fingertips can move beneath it and lever it to a vertical position (fig. 543). Your right hand takes the coins and moves to the right.

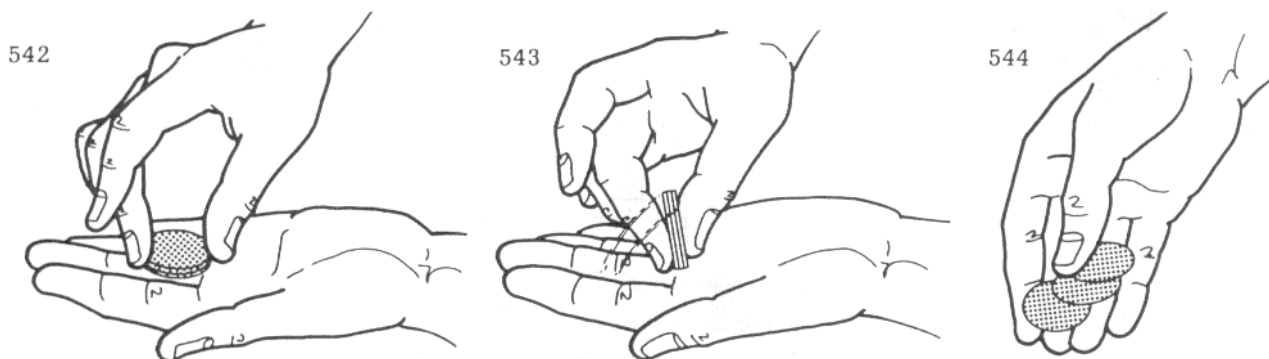

Do Roth's technique for Classic Palming One Coin of a Group, turning your hand palm up afterward to display the coins with one in classic palm position. Don't stay in this position too long or the shell's edge will be spotted. After a brief pause turn your right hand palm down while loosely curling your fingers. One coin will remain in palm and the other two will fall onto the insides of your fingers. Move your thumb onto the inner edge of the shell and, as you turn your hand partially palm up, lift the shell and spread it inward as already described in Cosmic Coins Across. Your right hand appears to hold three coins (fig. 544).

Transfer the coins onto your palm-up left hand with the lowermost coin in finger palm and the shell above it. As you transfer say, "That's three coins left. I'm going to close my hand and throw one away." Close your left hand and pretend to throw one away with your right hand as before. The shell slides over the bottom coin. Open your left hand, turning it palm up to reveal two coins and continue, no, throw one away - at that point there will be only two left. Are you following this?"

"All right, there are only two left." As you say that do the Utility Switch, your left hand turning palm down and your right hand turning palm up. One coin is tossed from hand to hand. The shelled coin is retained in left-hand finger palm. Two coins are visible afterward in your right hand. "I've been telling you what I'm going to do." As you say that bounce the right-hand coins into classic palm position. Turn your hand over curling your fingers. Both coins are retained in palm, though it must appear as if you've turned your hand over and dropped them onto your curled fingers (fig. 545). Say, "I'm going to take the two coins and put them in my hand ..." Move your right thumb behind your curled right fingers and straighten them as if they held the coins (fig. 546). Move your right hand over your left hand, which turns palm up as if to receive the coins (fig. 547).

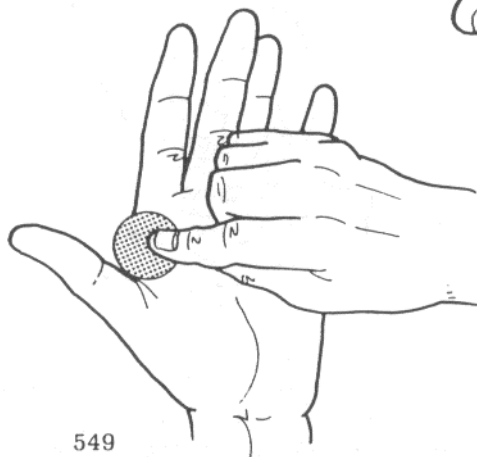
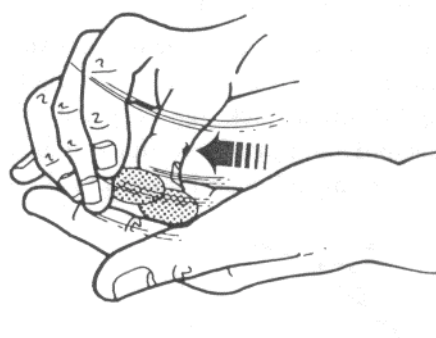
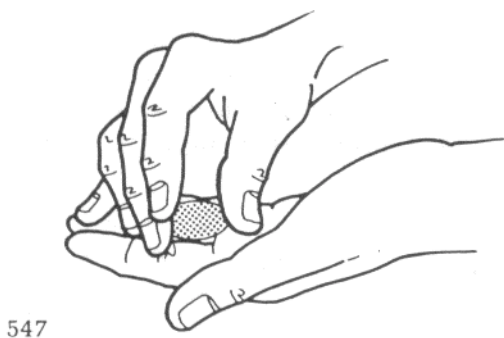

With a bit of practice the finger palmed shell will be between your right thumb and fingers when your left hand turns up (as shown in the illustration). Your right thumb and fingers immediately grasp the shell, lift it, and move it a little to the right so that it lies overlapping the real coin (fig. 548). Continue without pausing, ". . . close my hand, and throw one away. Then there'll be one left." Do exactly as you say, closing your left hand and turning it over. Your right hand pretends to throw another coin away, and your left hand turns palm up and opens, showing one coin. Say, "I can see you're having problems with this."

"Look, I'm going to take the coin, put it in my hand, close my hand, and then throw the coin away." As you patter your right hand lifts the shelled coin and, holding it shell side toward audience, does a Retention Pass. When you do the vanish hold the coin over your left thumb crotch (fig. 549). That way the spectators will think you've hidden the coin behind your hand - you'll see why that's important in a moment.



". . . and it'll be gone, right?" At the same time raise your closed left fist, holding it backs of fingers toward audiences (fig. 550). Open your hand, keeping your thumb pressed tightly against it (fig. 551), saying, "...Right! I mean it'll be ... oh, forget it!" As you say, "...forget it," your left hand makes an appropriate gesture, like a downward swish, so that its back is seen (fig. 552).

In Addition: Geoff does this thing tongue in cheek. You have to if you're going to use this patter and not sound obnoxious. Geoff often laughs with the spectators as he's doing the routine: it get progressively funnier as each coin vanishes.

The sucker bit with your left thumb at the end is Manuel's, and it serves an important purpose. It takes the heat off your right hand, which is in a vulnerable position at that point.

Here's the unbroken patter. "I've got four coins. What's going to happen is I'm going to close my hand, take one of the coins, and throw it away. And when I do this, of course, I'll only have three left. Now that I've explained the premise we'll get on to the magic. That's three coins left. I'm going to close my hand and throw one away ... no, throw one away - at that point there'll be only two left. Are you following this? All right, there are only two left. I've been telling you what I'm going to do. I'm going to take the two coins and put them in my hand, close my hand, and throw one away. Then there'll be one left. I can see you're having problems with this. Look, I'm going to take the coin, put it in my hand, close my hand, and then throw the coin away, and it'll be gone, right? Right! I mean it'll be ... oh, forget it. Wait, I've got another trick. . .

Glassed In Attraction

Geoffrey Latta

Geoff was working on the old premise where three silver coins vanish from one hand one at a time and reappear in the other hand which contains three copper coins. Dai Vernon and Sam Aronson have published methods in *Select Secrets* and *The Art of CloseUp Magic*. Geoff has changed the premise by isolating the copper coins beneath a glass on the table. The routine is a brilliant application of Tom Gagnon's Tiddlywinks Change.

You need a glass about the size of an old-fashioned glass (sort of a triple shot glass). Geoff prefers a fluted one with a scalloped design cut into the bottom. You also need six coins - three silver, two copper,

and a copper/silver coin. Stack them so that they appear to be three silvers and three coppers [the coppers on top of the silvers) and place them in the glass.



553

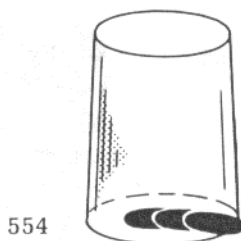

554

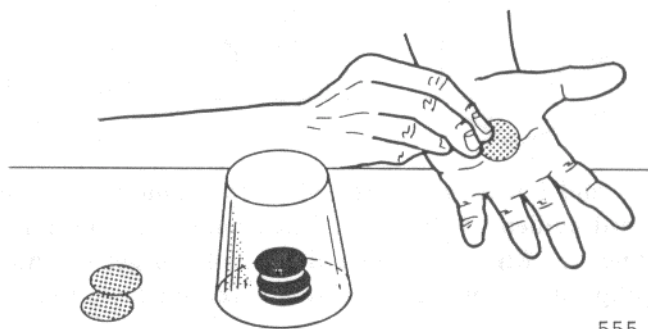

555

To perform, spill the coins (while still stacked) out of the glass and into your left hand. Place them onto the table, separating them into two spreads - coppers to the left and silvers to the right (fig. 553). Pick up the glass, which has been lying nearby, and turn it mouth down over the copper coins, leaving a bit of the copper/silver coin's edge protruding from beneath the glass on your side (fig. 554).

Your right hand picks up one of the silver coins and does a Retention Pass, apparently placing it into your left hand (fig. 555 is an audience view. Note that your hands are held to the left of the glass during the vanish so everything can be clearly seen). After the move your right hand settles into a relaxed fist on the table with the silver coin in fingertip rest.

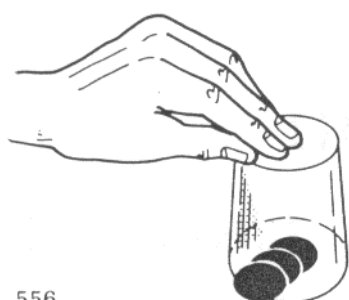

556

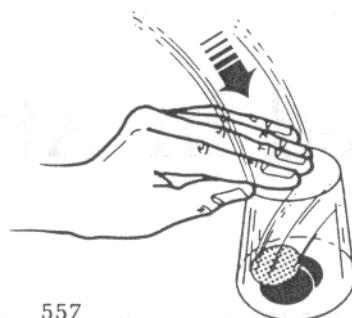

557

Turn your left hand palm down, at the same time holding your fingers together and straight with your thumb behind them as if holding the coin. Lower them onto the glass (fig. 556). Push downward, doing the Tiddlywinks Change, flipping the copper/silver coin silver side up. It appears as if the silver coin drops through the glass (fig. 557).

Pause for a second and lift the glass with your left hand. Your right hand immediately swings around and in front of the coins (fig. 558). There's one less copper coin than there should be and you can't give the spectators time to count. Your right first finger moves up against the side of the lowermost coin of the stack and your thumb moves on top of the silver coin (fig. 559). In a continuing motion your right hand sweeps inward, flipping the stack over (fig. 560). It immediately moves upward, your thumb pushing the silver coin that was in fingertip rest to your fingertips (fig. 561). Though it's an illogical sequence it appears as if your right hand has picked up the silver coin that penetrated the glass.

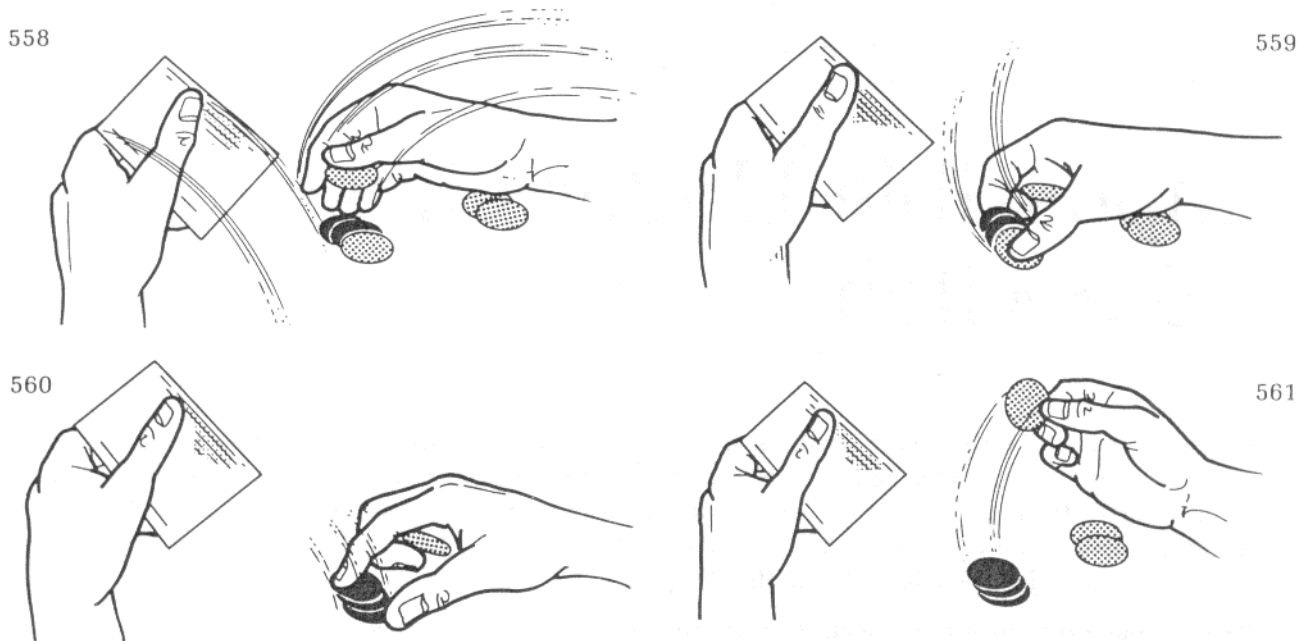

Place that silver coin on the table an inch or two in front of the three copper coins. Reverse count the copper coins onto the silver coin one at a time, leaving them spread inward, overlapping. The copper/silver coin is the last coin and it goes on top, spread farthest inward (fig. 562). Place the glass over the coins leaving the inner edge of the copper/silver coin beneath its lip in position for Gagnon's move.

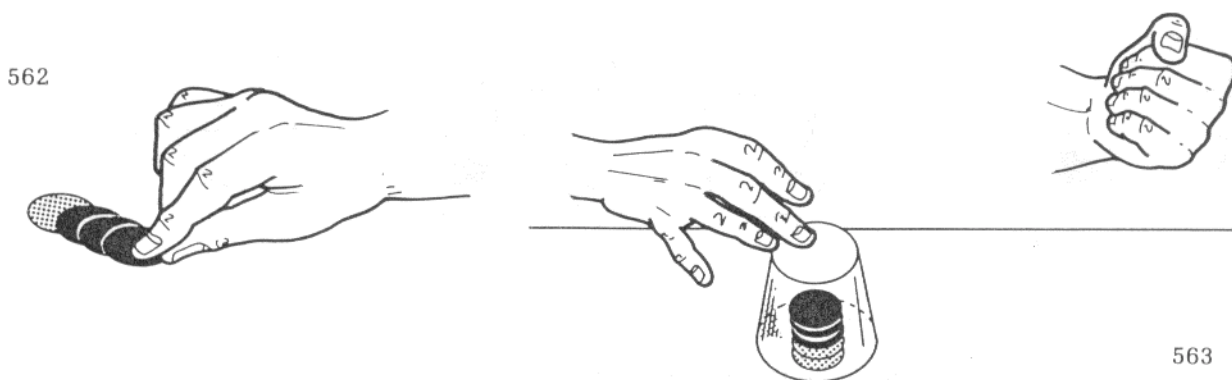

Your right hand picks up another silver coin, does a Retention Pass into your left hand, and settles onto the table in a relaxed fist with the coin in fingertip rest. Your left hand presses the silver coin through the glass exactly as before, doing the Tiddlywinks Change. When your left hand lifts the glass your right hand curves around in front of the stack and flips it over, lifting the switched-in silver coin as described. Place it onto the table just in front of the stack and reverse count the coins onto it - first the silver coin, then the three coppers. The copper/silver coin goes last. As before, the coins are overlapping and spread inward. Cover them with the glass in position for the Tiddlywinks Change.

Your right hand picks up the last silver coin and does a Retention Pass into your left hand. Your left fingers remain closed as you extend your left hand away from you (fig. 563 is the audience view). At the same time your right hand classic palms the silver coin. Move your right hand onto the top of the glass and say, "This time it'll travel long distance." Make a small jerking motion with your left hand toward the glass and a second later your right hand presses downward causing the copper/silver coin to flip over. Open your left hand to show it empty. It picks up the glass and your right hand flips over the stack substituting the real silver coin as described, lifting it for display. (You have to transfer the silver coin from classic palm to fingertip rest before doing the last move, and the best time is as you show your left hand empty.)

To clean up put some of the coins away (including the gimmick) and go into another routine which uses less coins, like a copper/silver routine.

Impossible Under Glass

CS Switch

Geoffrey Latta

Here's another of Geoffrey's applications of Tom Gagnon's Tiddlywinks Change. You need two glasses, two copper/silver coins, and a copper coin and a silver coin. The two gimmicked coins are classic palmed in either hand - the one in your right hand copper side against palm, and the one in your left hand silver side against palm. The two regular coins are on the table about a foot apart, silver on the right and copper on the left, with a glass beside each one (fig. 564).

Extend your first fingers and push the coins toward the spectators as you say, "Examine them." While the coins are being looked at your hands return to relaxed fist rest position near you on the table. Allow the classic palmed coin in each hand to drop to fingertip rest. When the coins have been replaced on the table move both hands forward and do Geoff's One-Hand Turnover Switch simultaneously with both hands. It appears as if both hands simply turn over their coins - both sides of each, the copper on the left and silver on the right, are clearly seen. The coins that you've switched out are left momentarily in fingertip rest.

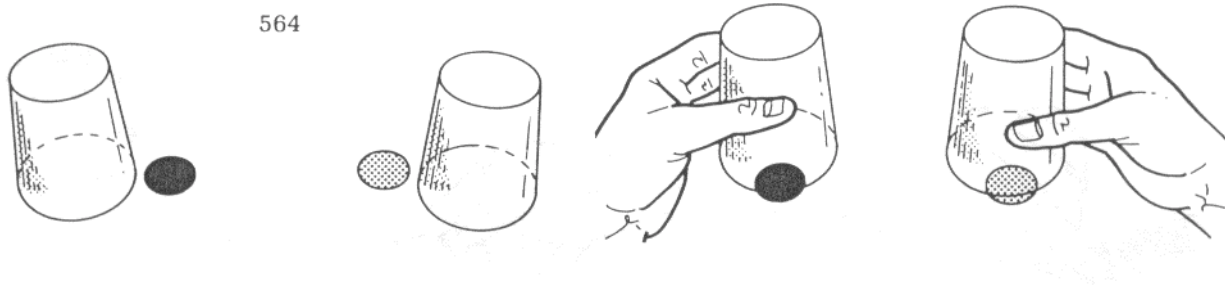

Raise your hands, your second and third fingers pushing the coins into classic palm in each hand. Your fingers grasp the top (actually the bottom) of each upside-down glass, lift them, and place them over the coins in Tiddlywinks Change position with just a bit of each coin's inner edge protruding from beneath each glass (fig. 565). Say, "Two coins, separated by two walls of glass, completely isolated, change places!" As you finish the sentence do the move simultaneously with both hands and the coins will appear to change places.

Pause for a second, lift the glasses, and place them aside. Curl your fingers and allow the classic palmed coin in each hand to fall to fingertip rest as you lower your hands to the coins on the table.

First, your right hand reaches to the silver coin on the left and does the One-Hand Turnover Switch, switching out the gimmick and leaving the regular silver on the table. A moment later your left hand does the same with the copper on the right.

CopSilBrass

Geoffrey Latta

This is a masterpiece of construction: David Roth has called the second transposition the best use of a copper/silver coin he's seen. It's one of the most visually astounding coin routines you'll ever learn. You need three regular coins - a copper, a silver, and a brass (or Chinese) coin. These are in a small purse (the same type that's been described for the Wild Coin routines). A copper/silver coin is behind the purse, silver side against the material. This is in your pocket. There is no lapping, so you can do it standing. You must work on a soft surface, though it doesn't have to be a close-up mat in this case.

The Set Up Sequence

Remove the purse from your pocket with your right hand, held between thumb on the inner side and fingers on the outer side (fig. 566). Your thumb holds the coin in place behind the purse. Place the purse on the table, the coin hidden beneath it.

Show your hands empty. Pick up the purse (the coin still concealed beneath it) holding it on your outstretched right fingers (fig. 567). Your left hand approaches and grasps the left side of the purse, thumb beneath and fingers above (fig. 568). The coin remains on your right fingers as you lift the purse, taking it to the left and shaking it. At the same time your right hand turns inward, the coin in fingertip rest. Your curled fingers push the coin into classic palm (silver side against palm).

566

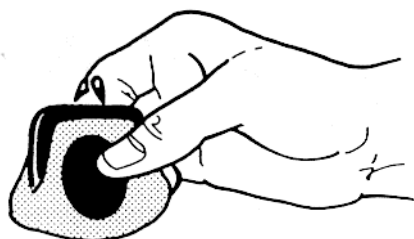

567

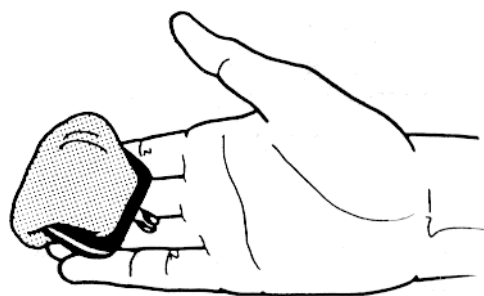

568

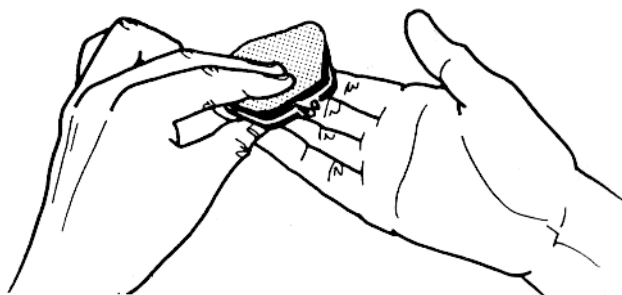

Your right fingers open the purse and your left hand turns it over, dumping the coins onto the table. As the coins fall your right fingers curl so you can transfer the copper/silver coin back to fingertip rest (silver side up). Your left hand continues holding the purse throughout the following right-hand switching sequence. Your right hand moves to the coins on the table and grasps the silver coin between your thumb and first finger by pushing downward on the inner edge with your thumb so your first finger can slide beneath it. Lift the coin and turn it over, moving it slightly forward (fig. 569). Repeat with the brass coin. When you turn over the copper coin do the One-Hand Turnover Switch, simulating the two previous turnovers.

As your right hand returns from the switch your thumb slides the switched-out copper down to fingertip rest. Your left hand, which has been holding the purse, places it onto your right fingers over the copper coin. Without pausing your right hand places the purse, with the copper beneath it, onto the table somewhere to your right.

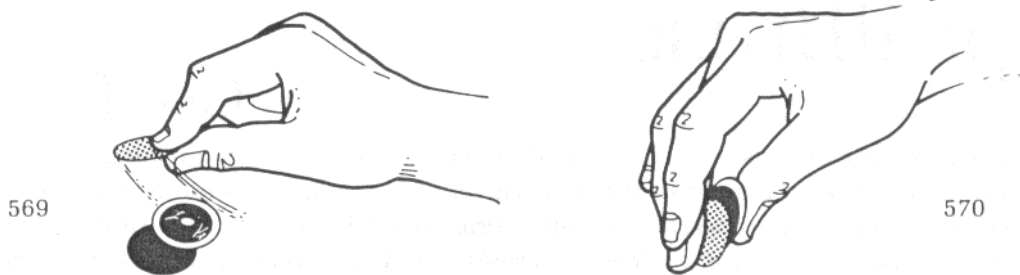

The First Transposition

Your right hand places the silver coin onto the copper, and both of those onto the brass. Your right thumb moves beneath the stack's inner end and levers them up against your fingers (fig. 570). You're going to do an Al Baker steal. Turn your left hand palm down and curl your fingers inward so they point toward you (fig. 571 shows both hands just prior to the steal). Your right hand swings once to the right (a small wind-up) and then to the left, relaxing its fingers. Your thumb retains the brass coin while both coins in front of it fly into your left hand (fig. 572). Watch the coins as they fall onto your left fingers - they must both be silver side up. If you've bent your wrists inward during the toss they'll naturally fall that way.



It appears as if your right hand has just tossed the coins into your left hand, which closes into a fist. Raise your left hand and shake the coins inside, at the same time classic palming the brass in your right hand. Turn your right hand partially palm up, fingers pointing to the left, and move it beside your left fist. Your right thumb and first finger reach into the thumb hole and pull out the copper/silver coin (the uppermost coin) silver side up (fig. 573). Leave it resting on your right fingertips and close your hand into a fist.

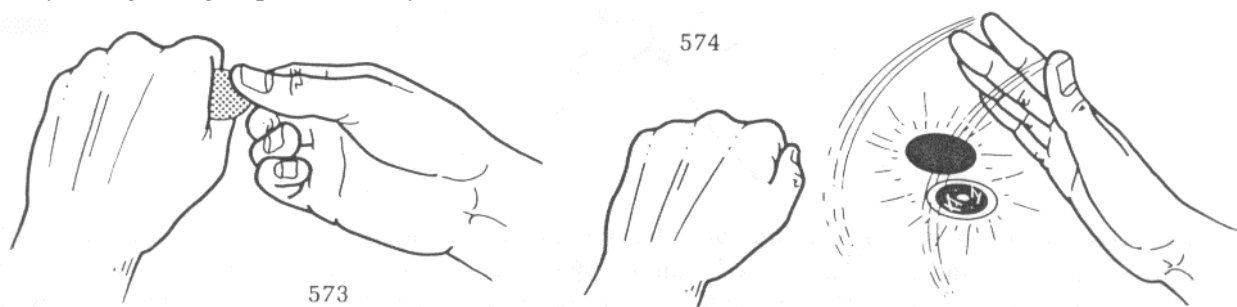

Relax your right palm allowing the brass coin to fall onto the copper/silver coin with a clink. Your right hand swings forward straightening its fingers and slapping its coins onto the table (they turn over before they hit the table). Lift it, revealing the copper and brass coins (fig. 574). Turn your left hand palm up and open it revealing the silver coin.

The Second Transposition

Your right hand picks up the copper coin, places it on the brass coin, and places both of those on the silver coin. Place the stack, slightly spread, onto your palm-up left hand (fig. 575). Close your fingers and turn your fist over. Your right thumb and first finger reach into your left thumb hole and pull out the copper/silver coin (on the bottom of the stack) silver side up. Your left hand does Isolation Placement, getting the brass coin ready to be Han Ping Chien-ed and locking the silver coin in position. Turn your left fist palm up (fig. 576).

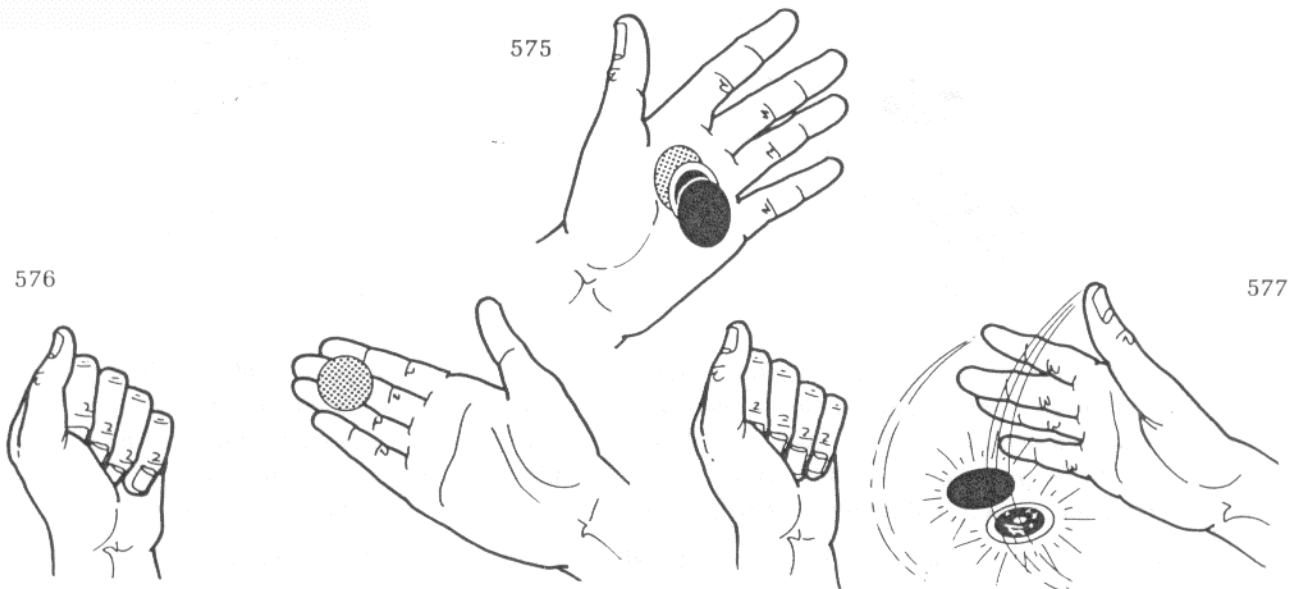

Do Geoff's Han Ping Chien, your right hand simply turning over and slapping its coin onto the table (also automatically turning it copper side up) while your left hand moves smoothly to the left - the brass coin getting smacked to the table by your right fingers. Lift your right hand revealing the copper and brass coins (fig. 577). Open your left hand showing the silver coin - drop it to the table.

The Third Transposition

Your right thumb moves onto the purse so you can slide your fingers beneath it. Once you've picked up the purse swing your right hand in front of you, the purse resting on your outstretched fingers. Your left hand lifts the purse, thumb beneath and fingers above, and your right hand tilts palm toward you to conceal the copper coin on your fingers. As your left hand moves upward with the purse your right hand classic palms the copper.

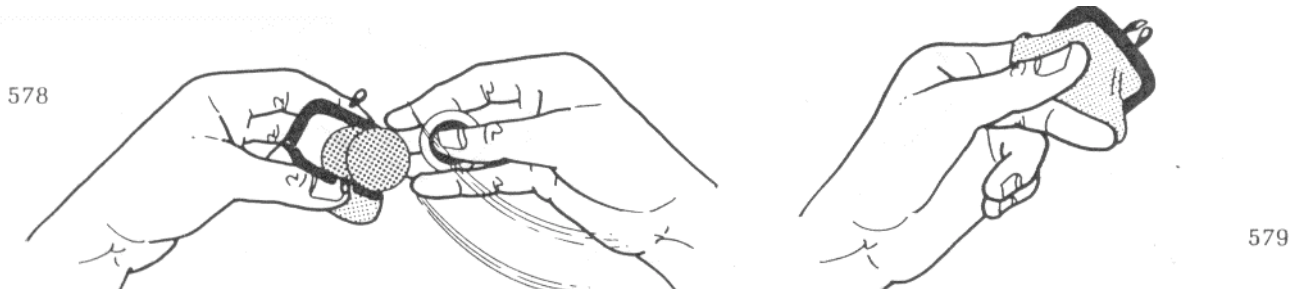

Your right hand moves to the tabled coins and stacks them silver onto copper onto brass. Your thumb moves beneath the stack and levers it upward against your fingers in preparation for the Al Baker steal again. Your right hand lifts the stack and holds it beside (just above and to the right of) your left hand. Do the Baker steal as you toss the coins into the purse. Your right thumb retains the brass coin (fig. 578). Your left thumb snaps the purse closed. Curl your left second finger behind the purse (fig. 579). Raise the purse

to your left ear and shake it, at the same time straightening your left first and second fingers, flipping the purse around (the point is to reverse the copper/silver coin inside). At the same time your right hand transfers the brass coin to High finger palm - between the center joints of your second and third fingers (fig. 580).

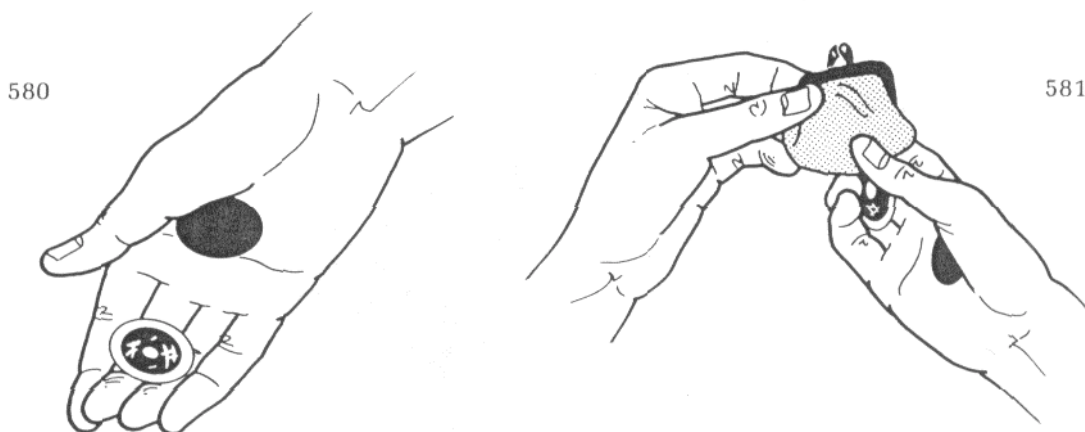

Your left hand descends and places the bottom of the purse between your right thumb and fingers (fig. 581). Your left fingers open the purse and remove the copper/silver coin silver side toward audience (it'll be directly in front of the real silver coin). Place it on the table for the moment. Your left hand moves quickly back to the purse, closes it, and places it onto the table in front of the spectator. Your left hand picks up the copper/silver coin and maneuvers it into finger palm while your hand is palm up.

As your left hand does that your right hand transfers the brass coin to thumb palm. That's going to be difficult at first because of the copper coin in classic palm. A little practice will make it flow easily. Straighten your right fingers a bit once the brass has been transferred, holding them naturally curled and relaxed.



Curl your left fingers into a fist while the silver coin remains in finger palm. It must remain isolated there. Your right hand approaches your left fist to make a magic wave over it, and in the process loads the thumb palmed brass coin into it via Vernon's Loading Move. Briefly: Your left fingers are curled, but held slightly away from the heel of your hand (fig. 582). Your right hand moves over your left fist. Your right thumb relaxes, allowing the brass coin to drop inside your left hand, sliding between your left first and second fingertips and the heel of your hand (fig. 583). Immediately move your right hand forward and then back in a waving motion.

Squeeze your left fingers into a tight fist, forcing the copper/silver coin out of finger palm and onto the brass coin copper side up. Open your left hand revealing the copper and brass coins. At the same time your right palm relaxes and allows the classic palmed copper to drop to fingertip rest.

Shoot your left hand forward a little, causing the copper coin to slide forward into finger palm (fig. 584). Move your hands next to each other and do a Utility Switch. Your left hand turns palm down retaining the copper/silver and dumping the brass onto your now palm-up right hand. It coalesces with the copper already there. Drop those two coins onto the table. Ask a spectator to open the purse, where he'll find the silver coin. The gimmicked coin is in your left hand and can be disposed of whenever you get a moment.

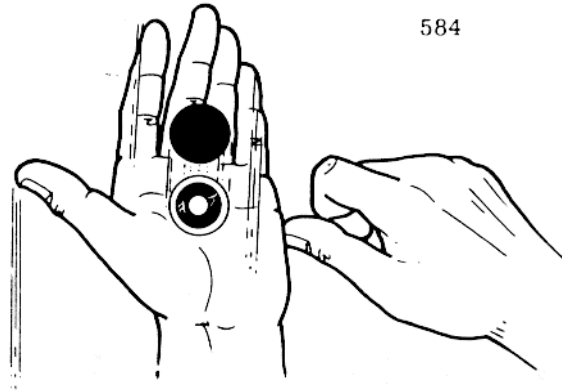

In Addition: Recently Geoffrey has done the first transposition a little differently. Instead of using the Al Baker Steal as described he places the coins into his palm-up left hand one at a time, simulating a Retention Pass each time, and actually doing one when the brass coin is ostensibly placed into the hand. Make sure you let the brass coin hit the copper/silver coin already there with a clink before you pivot it back into right-hand fingertip rest. Then toss the silver coin into your left hand from a short distance.

Miracles sometimes occur, but one has to work terribly hard for them.

Chairn Weizmann

EDWARD MARLO
On
The Sympathetic Coins

Olam's Instant Sympathy

Edward Marlo

The four coin assemblies which follow this one have never been published before. This first appeared in *Tops*, June 1975, as *Instant Coin Assembly*. It seems to have gone unnoticed and since it certainly deserves a place in the literature I'm using it to introduce the four new assemblies. The particular approach in each of the five cases is different, and the way the routines progress visually also varies. In this case, where four coins are covered by four cards, three of the coins vanish before any are shown to have joined the "leader" coin.

The routine is impromptu, all you need are four cards, four quarters (borrowed, if possible), and a mat. (If you don't wish to borrow the coins you can, of course, use half dollars or English Pennies. The cards should be the Ace, Two, Three, and Four of a suit, because the coins will vanish from beneath them in numerical order! The cards should be in the order, from the top down; Three, Ace, Two, Four.

To perform place the quarters, all tail side up, in a square formation on the mat about a foot apart from each other. Your left hand holds all four face-down cards (which have already been shown to the audience) in dealing position. Thumb off the top two cards without reversing their order and take them with your right hand; thumb above, fingers below. That leaves two cards in your left hand. Both thumbs push the top cards slightly off the lower cards (your right thumb pushing to the left, and your left thumb pushing to the right) (fig. 585). Turn your hands over to briefly flash the faces of the cards again (fig. 586). Turn them palm down.

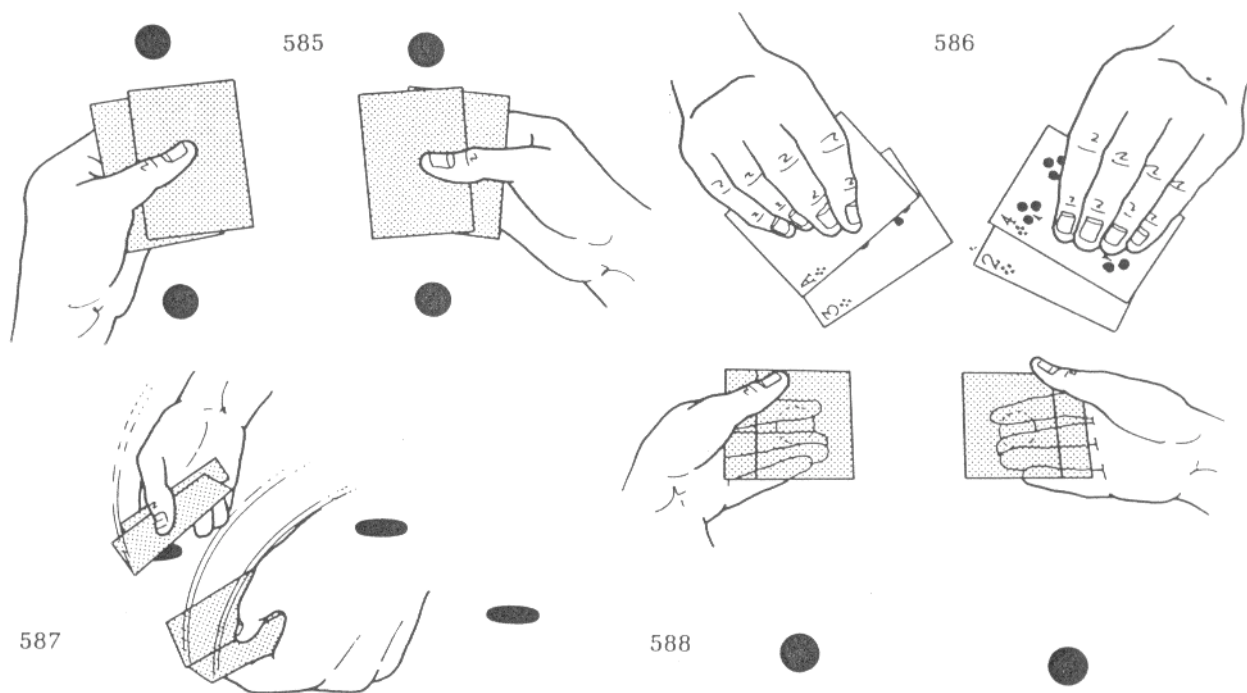

Lower your hands over the two outer coins (your left hand over the outer-left quarter and your right hand over the outright quarter), at the same time tilting your hands forward so the outer ends of the cards touch the table (fig. 587). The lower sides of your first fingertips press downward against the outer edges of the quarters (fig. 588 in which the cards are transparent). Your second fingers are naturally pressing on the inner edges of the coins.

Press lightly downward with your second fingers, causing the outer edges of the quarters to rise (fig. 589 is an exposed view). Slide your first fingers beneath the coins, clipping them firmly between first and second fingertips (fig. 590 in which the cards are transparent).

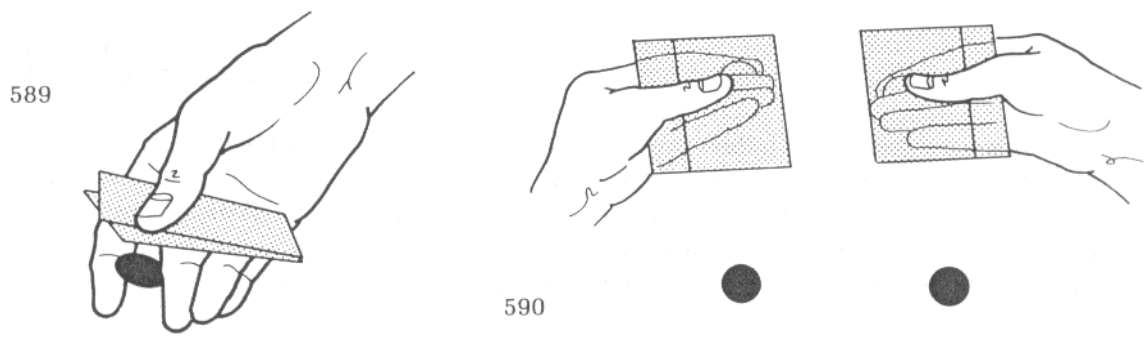

Slightly lift your thumbs, releasing the upper cards of both pairs, letting them begin to slide onto the table, while at the same time your hands move apart (fig. 591). As your hands move apart (leaving the top cards on the table) you'll find that by slightly dropping your second fingers and pushing lightly inward with your first fingers you can cause the quarters to flip head side up beneath the cards (fig. 592 is an exposed view).

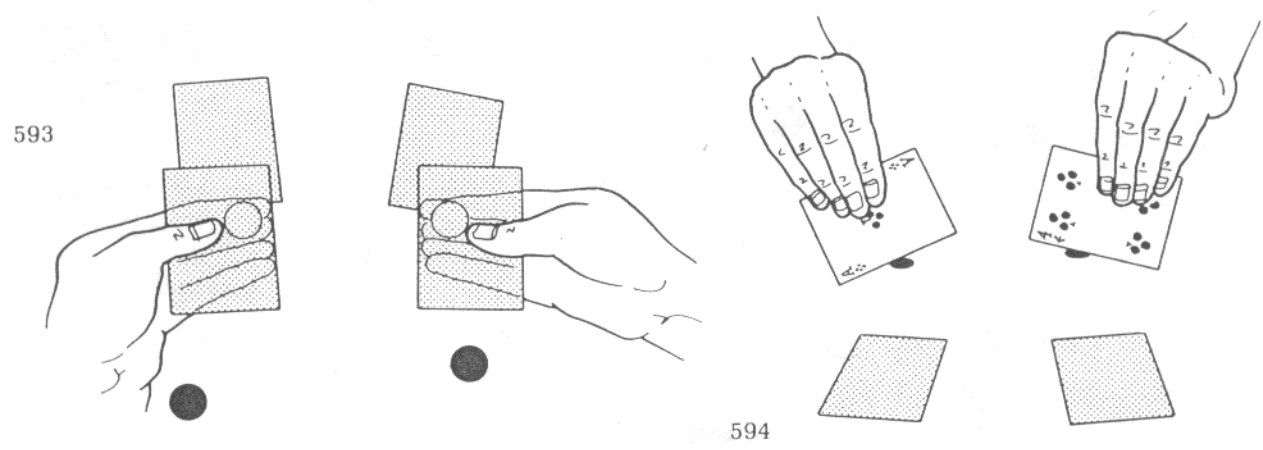
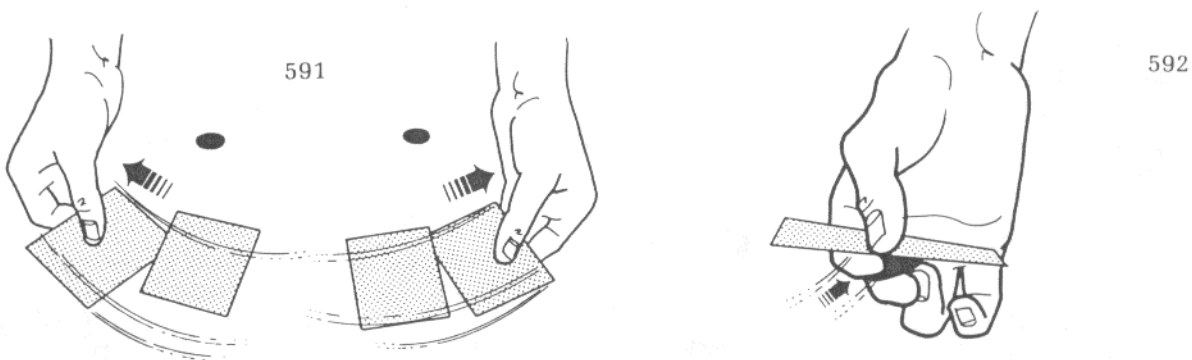

Your thumbs now press lightly downward on the inner edges of the coins (through the cards), allowing your first fingers to slip out from above the coins and move beneath them (fig. 593 in which the cards are transparent). With a bit of practice this simultaneous double steal is both easy and invisible.

Turn your hands palm down displaying the faces of the cards to the audience. At the same time your fingers, which cover the coins, pull them back a little (fig. 594). After a moment turn your hands palm up again, pushing the coins back to beneath the center of each card.

Begin to cover the two inner coins, then lift your hands again as if you've changed your mind. Your right hand places its card on top of the left-hand card, outgged diagonally to the right (fig. 595). At the same time your right second finger slides the coin beneath its card inward and to the left - to beneath the lefthand card where it's held by your left first finger (fig. 596 in which the cards are transparent).

Turn your right hand palm down and push the inner-right coin forward a little, saying, "This will be the leader coin." Your right hand takes the outer card as before as if to cover the inner-right coin. Before you get too far, however, change your mind again and put the right-hand card back where it was on top of the left-hand card. While your right hand is there it pushes both hidden coins into alignment, and moves them to the very tips of your left fingers (fig. 597 in which the cards are transparent). Your right hand moves away, turns the inner-right coin head side up, and pulls it back to its previous position as you say, "If he's going to be the leader he's got to use his head."

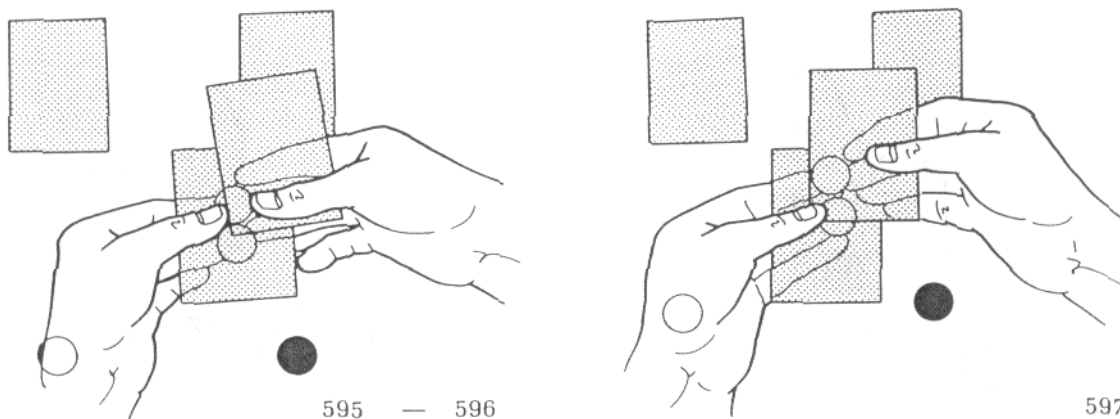

Your right hand takes its card again, but your left hand covers the coin at the inner right (fig. 598 in which the cards are transparent). Note that the coin that was already there is to the right of the other two being added. You'll find it an easy matter to put the card down neatly and take your left hand away without any chance of pulling the hidden coins out because of the way they were held at the extreme fingertips.

(At this point, just to check, your right hand holds the Ace; the Two is at the outer left; the Three at the outer right; the Four at the inner right.)

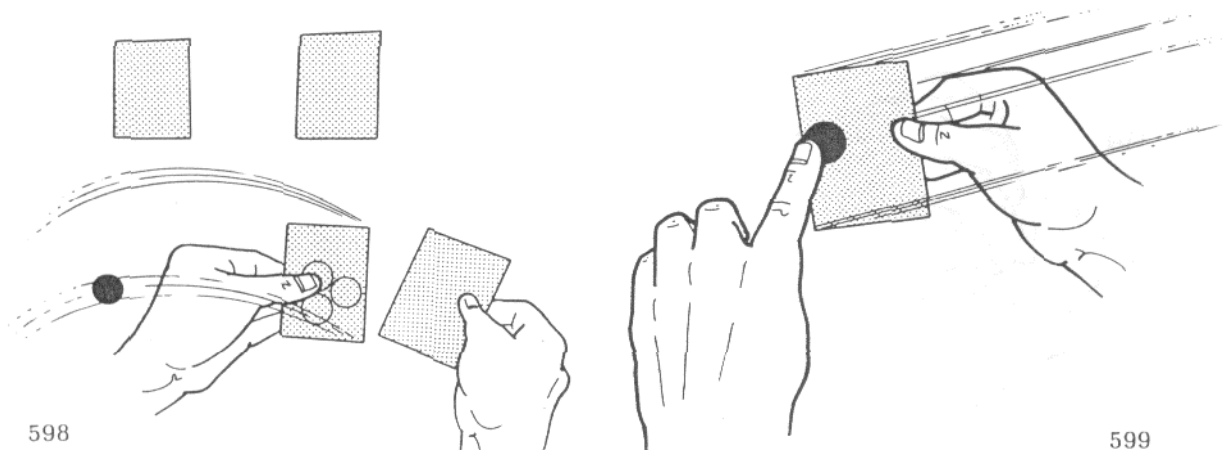

Lower your left first fingertip onto the inner-left coin and hold it in place as your right hand slides its card beneath it (fig. 599). Lift your right hand with the coin balanced on the back of the card and hold it beside your palm-up left hand (fig. 600). Move the card's left long side onto your left hand - along the line where the fingers meet the palm (fig. 601). Lift your right hand, tilting the back of the card toward you. The coin will fall to the lower side of the card (fig. 602). Without pausing your right thumb reaches down, its tip

moving onto the coin. Pull the coin upward and, at the same time, lift the card and close your left fingers (fig. 603). It appears as if you've simply dumped the coin into your left hand.

600

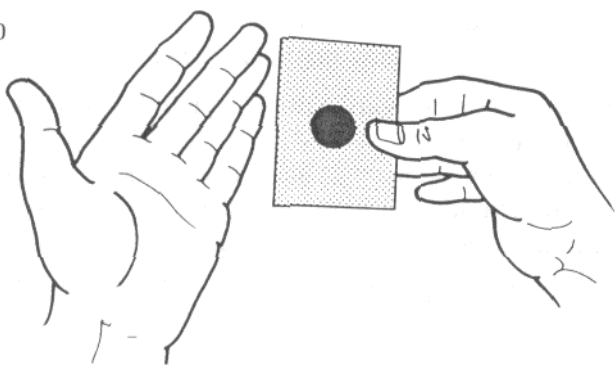

601

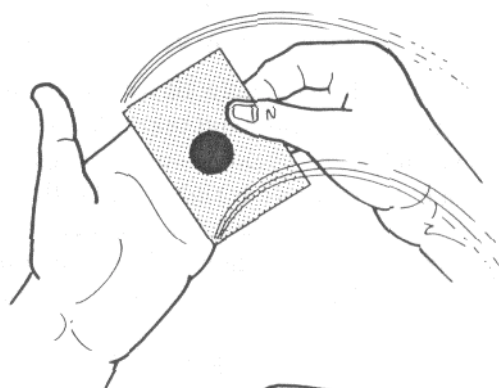

602

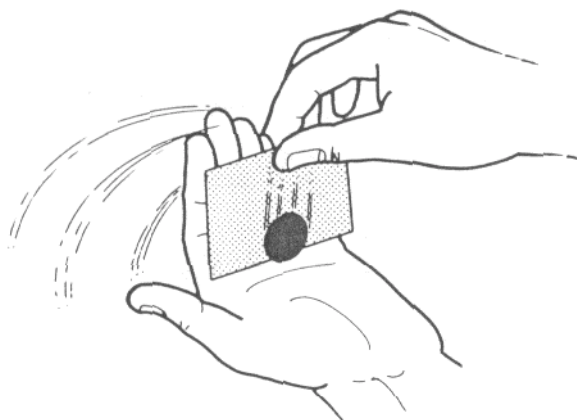

603

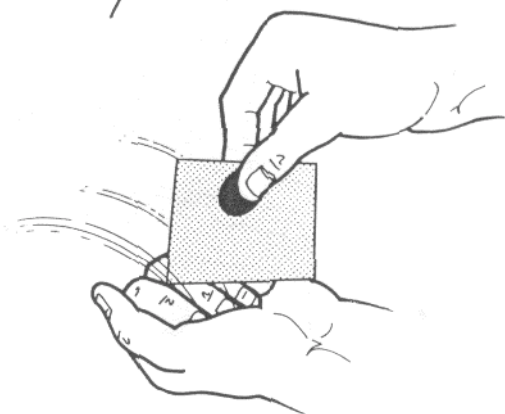

Brush the card's lower side against your left fist and then open it to show that the coin is gone. Say, "The first coin has vanished from under the Ace." Lay the face-up Ace, with the coin hidden beneath it, onto your left fingers (fig. 604). Your right hand reaches to the card at the outer left and grasps it; thumb at inner side, second finger at outer side, and first finger resting lightly on top. Lift the card and snap its outer side off your second finger saying, "The second coin has vanished from beneath the Two," as you turn the card face up.

604

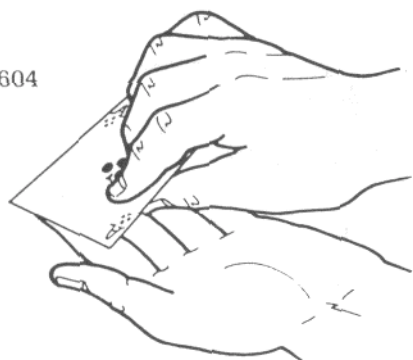

605

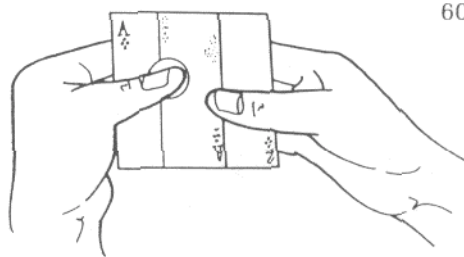

Place the Two beneath the Ace so that its left long side holds the coin in place (fig. 605 in which the cards are transparent). Your right hand grasps the card at the outer right and, exactly as you did with the Deuce, snap it face up and say, "The third coin has vanished from beneath the Three." Both hands now turn palm down to display the backs of the cards, the coin between the left-hand cards concealed by your left fingers (fig. 606). Both hands turn palm up again.

Your right hand places the Three beneath the Two, and then takes all three cards between thumb (above) and fingers (below) (fig. 607). Press firmly downward with your thumb to hold the coin securely in place between the Ace and Two. Your left fingers move onto the left long side of the facedown card at the inner right to hold it in place as your right hand slides the left side of the Ace beneath it (fig. 608). Relax your right thumb's pressure allowing the coin to slide out from beneath the Ace and Two and join those already beneath the Four.

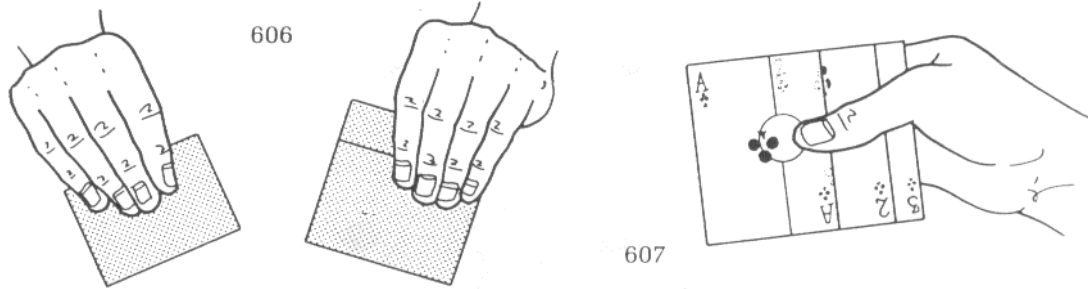

Say, "No, wait. Let's do it this way, instead." As you talk your right hand pulls its three cards to the right and leaves them on the table a few inches to the right (fig. 609). Very cleanly flip over the Four revealing all four coins beneath it, saying, "Seems like they all used their heads, too!" (fig. 610).

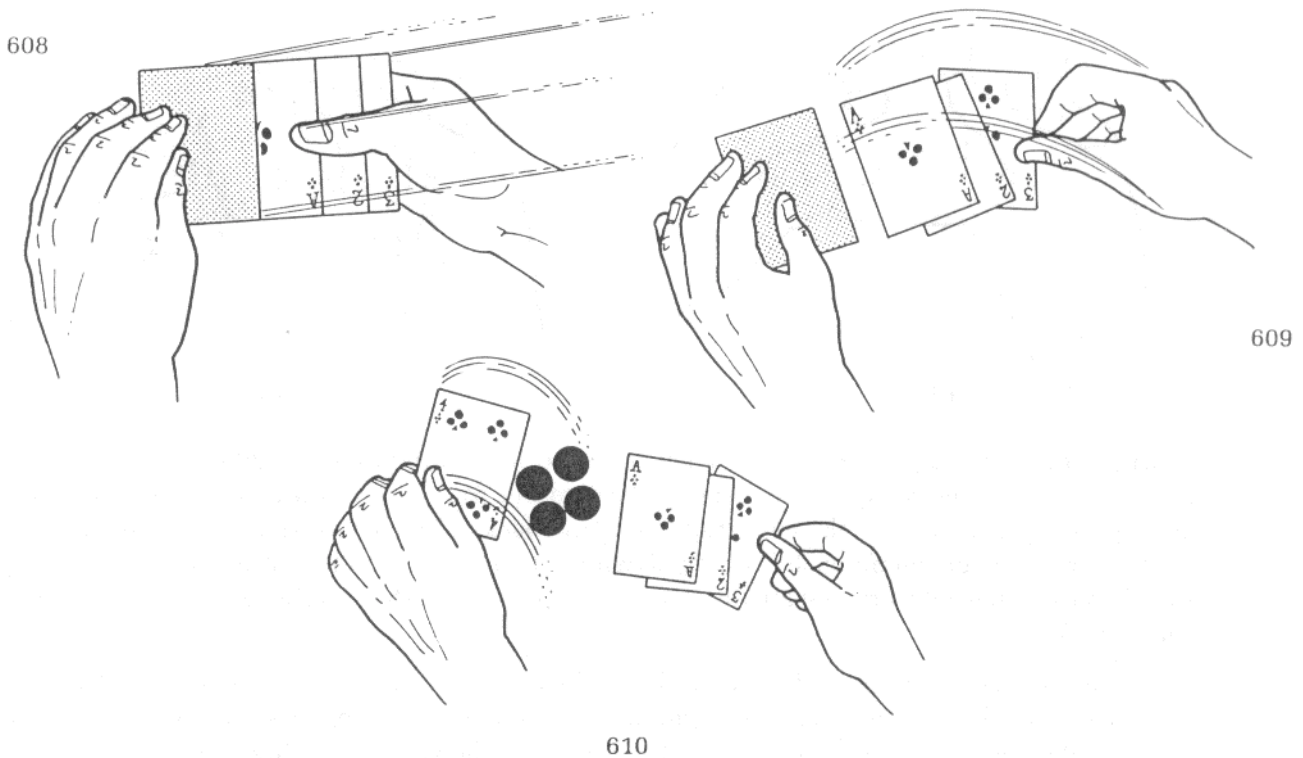

Simplex Matrix

Edward Marlo

In Ed's words: "The method that follows is in no way offered as an improvement (over Schneider's Matrix), or for that matter is it any different in effect. The only reason for its being is that it's easy and direct, with a minimum of finger flinging and card twisting. With the routine performed in a rhythmic tempo the coins assemble so easily and quickly that even magicians may be surprised at the conclusion."

You must be working on a mat. Borrow four quarters (you can use halves if you like) and lay them out in a square, about a foot apart from each other. Your left hand holds four face-down cards in a fan (fig. 611). Your palm-up right hand takes the top card at its right long side between thumb (above) and fingers (below) (fig. 612). Your right hand turns palm down to display the card's face. Note that your fingertips are at the edge of the card (fig. 613).

611

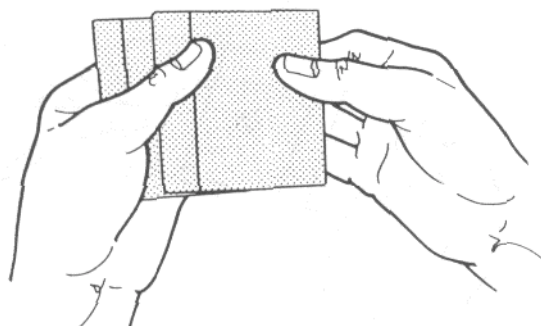
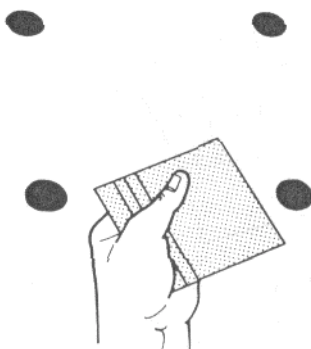

612

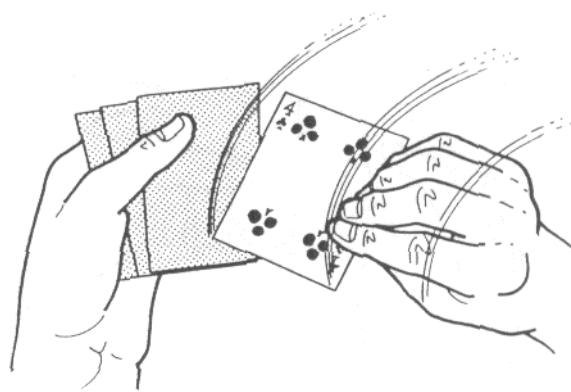

613

Turn your right hand palm up again and begin moving it toward the outer right coin. As it travels extend your second, third, and pinky fingers beneath the card (fig. 614 in which the card is transparent). Without pausing lower the card over the outerright coin, the backs of your fingers pressing downward onto it (fig. 615). While your thumb pushes lightly downward on the card to hold it in place your fingers pivot toward you, moving out from beneath the card with the coin beneath them (fig. 617 in which the fingers are transparent).

Once your fingers are completely clear of the card your right hand begins to slide inward, turning palm up as it goes (fig. 618). It moves in a straight line toward the inner right coin. Your hand stops when the coin concealed beneath your fingers is directly in front of the visible coin (fig. 619).

At the same time your left hand places the next card into your right hand, between thumb and fingers (fig. 620). Once your left hand has moved away with the two remaining cards your right hand tables the card it holds over the two coins beneath it. Note that its natural action, which is to hold the card in place with the thumb and swivel the fingers out from beneath it, is exactly the same as the steal of the first coin.

Your right hand takes one of the two cards remaining in your left hand and covers the outer-left coin, then takes the last card and covers the inner-left coin. Both of the just-covered coins should be just right of center beneath the cards (fig. 621 in which the cards are transparent). At this point, while the audience thinks there is a coin beneath each card, there are two at the inner right, and none at the outer right.

614

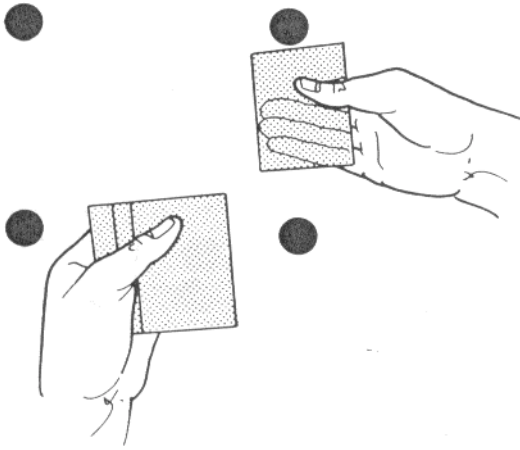

615

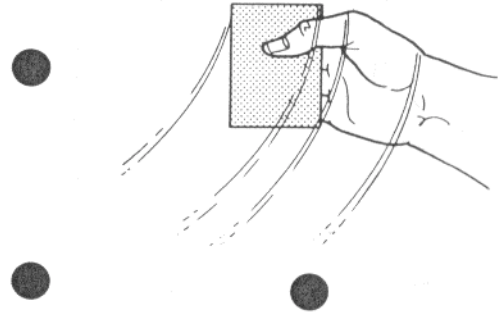

617

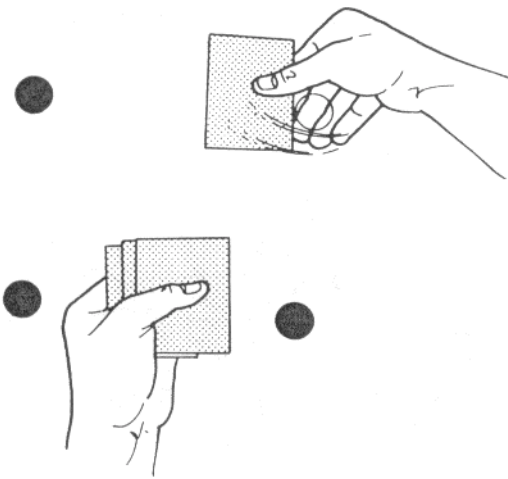

618

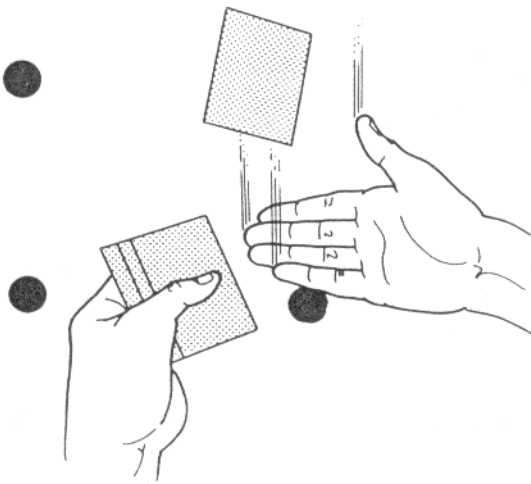
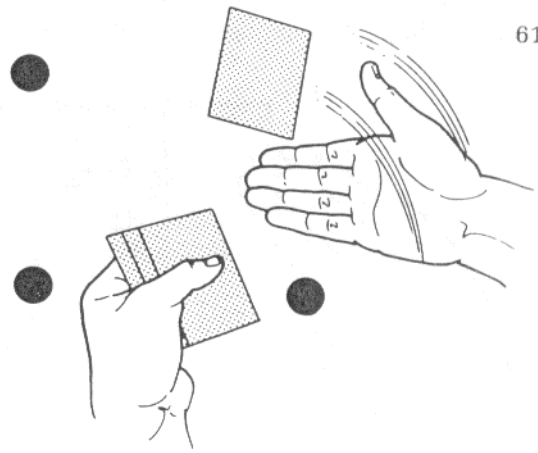

619

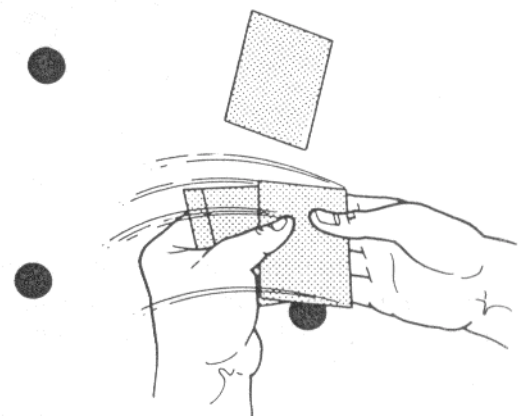

620

Hold your left hand over the outer-left card and your right hand over the inner-right card. Both hands snap their fingers. Your right hand immediately lifts the card beneath it by its right long side, thumb above

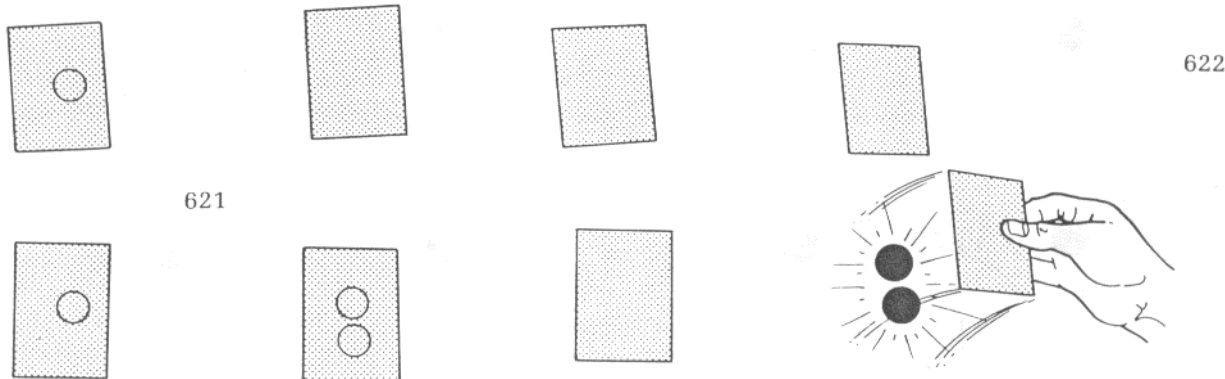

and fingers beneath, revealing two coins, saying "Two here" (fig. 622). Don't pause. Your right hand flips its card face up end over end (so it's still held the same way). Your left fingers press downward on the left long side of the outer-left card as your right hand slides its face-up card beneath it, trapping the coin between the cards (fig. 623). Your right hand lifts both cards and turns palm down to display the other side, saying, ". . none here" (fig. 624). (Call this the Scoop Vanish.)

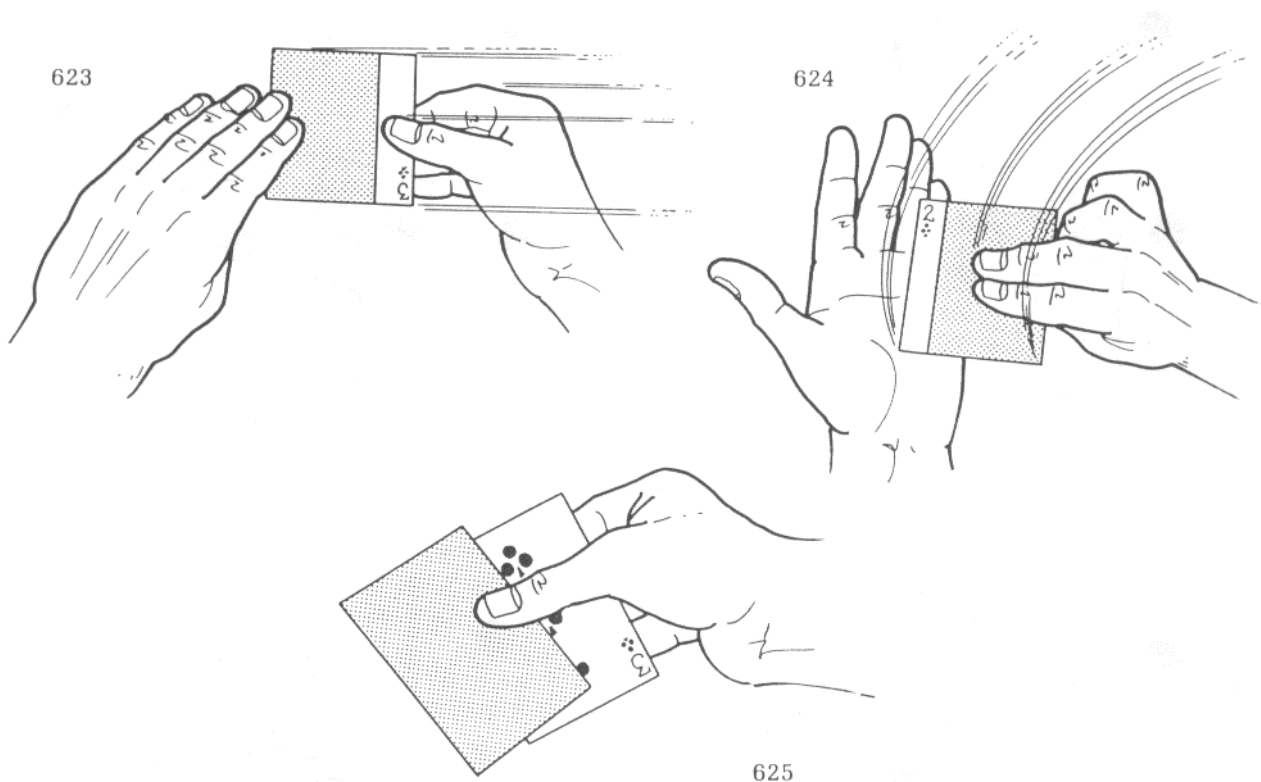

Turn your right hand palm up and move it over the inner-right coins. Press lightly downward with your thumb so your fingers can slide the face-up card to the right (fig. 625). The coin between the cards will join the two beneath the face-down card. Your right hand turns the card it still holds face down, holding it by its right long side.

Your left hand snaps its fingers over the inner-left card. Repeat the Scoop Vanish as described, this time at the inner-left corner (and with both cards face down).

once the vanish has registered for a moment your left hand lifts the inner-right card revealing three coins. Your left hand immediately tosses its card, face up, to the mat's outer-left corner. Arrange the three coins at the inner right in a horizontal row (fig. 626). Bend your right hand at the wrist and cover the coins so they're left partially exposed (fig. 627). Raise your right thumb a bit and slide the lower card toward you, out from beneath the upper card (which remains partially covering the coins). Your right hand turns its card face up and tosses it onto the card already at the outer left.

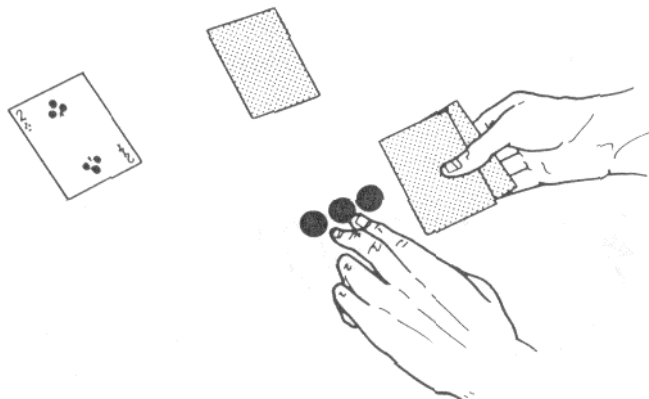

626

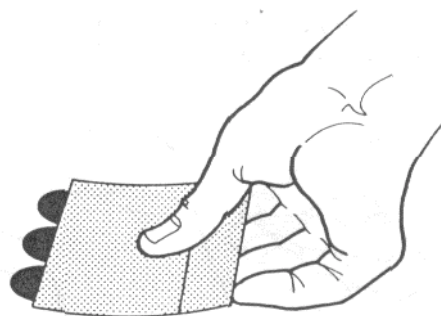

627

Turn your right hand palm down and move your thumb onto the center of the inner long side of the card covering the three coins. Push the card forward, ostensibly to cover the coins completely, but actually to set up for the Dingle-Schneider Pickup Move, i.e., until your thumbtip hits the inner edge of the extra coin beneath the card. Raise both hands, one over each of the remaining face-down cards. Start to snap your fingers, then change your mind. Lower your right hand over the inner-right card and do the Pickup Move so that three coins are seen, the fourth coin concealed beneath the card.

Your left hand moves a coin from one end of the row forward, between the other two, to form a triangle. Replace the right-hand card, adding the fourth coin.

End by lifting the card at the outer right with your left hand, turning it face up and tossing it onto those already at the outer left. Lift the last card to reveal all four coins.

In Addition: If you don't already know it, the Dingle-Schneider Pickup Move (which was developed by both men independently) is described later on in David Arthur's *SeeSaw 'Sembly*.

Mario adds: "The idea of sliding a coin secretly under a hand is not new - Dr. Daley used a similar procedure in a routine published in *The Phoenix*. I do not recall such a maneuver being done with the hand palm up and obviously empty. The pinching of a coin secretly between two cards was used by Mike Spooner and published in an Ellison Poland book, however Spooner used the idea to secretly obtain and transport a coin during the initial layout of the coins, but not to actually vanish a coin and then secretly add a coin using a one-ahead approach."

Quick Coinvergence

Edward Marlo

This version bears some resemblance to *Instant Sympathy*, but its technique is much speedier and quite revolutionary. Some of the techniques from *Simplex Matrix* are used. The only preparation is to have six

dimes in your left pants pocket. You should be standing when you perform this and, as with the other routines, working on a mat.

Remove any four cards from the deck and place them in a face-down pile on the table directly in front of you. Place the deck aside. Your left hand reaches into your pocket and removes all six dimes in a stack. Turn your left hand palm up and cover the sort-of spread stack with your thumb (fig. 628). The audience is not aware of how many dimes you have - and you shouldn't mention it! It'll appear, however, as if only four dimes are used. Your left thumb pushes the top dime to the right (fig. 629).

Your right hand takes the dime and places it at the outer left corner of the square you're going to lay out. Your left thumb pushes off the next dime, your right hand taking it and placing it at the inner-left corner. The third dime is taken and placed at the outer-right corner.

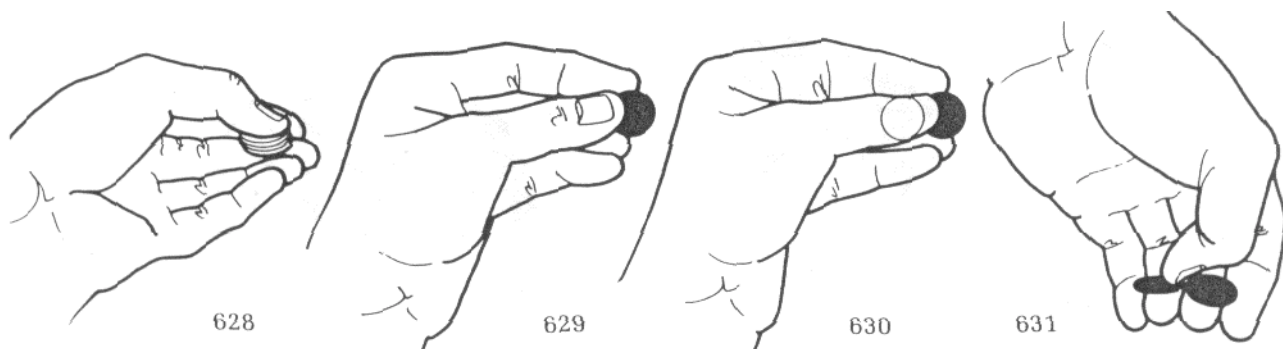

When your left thumb pushes over the fourth dime it will conceal the last two beneath it (fig. 630 in which the thumb is transparent). Your right hand takes the fourth dime and tables it at the inner-right corner. At the same time your left hand turns palm down, closing into a relaxed fist - but with the fingers still dropped open. Your left thumb quietly slides the top dime to the left, separating the dimes so one rests on your second fingertip and the other on your third fingertip (fig. 631). Note that the dimes' edges touch.

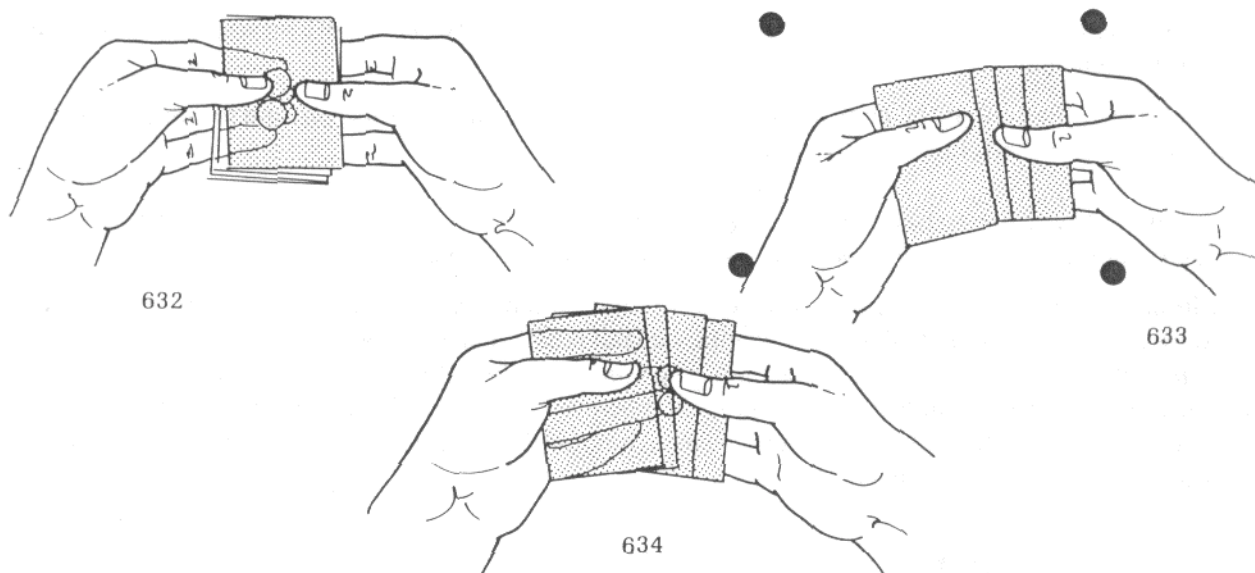

Your right hand lifts the packet of cards and lowers it onto your left hand, which turns palm up beneath it. The cards go onto to lie balanced on the dimes, covering them (fig. 632 in which the cards are transparent). Both hands work, spreading the cards to the left in a small fan (fig. 633). During this your left second and third fingertips slide the dimes beneath the lowermost card (farthest to the right) and, with the aid of your right fingers, maneuvers them so that they're held by the extreme edge (fig. 634 in which the cards are transparent).

Your right hand slides the lowermost card out from beneath the fan, your left fingers holding the dimes in place against the face of the third card. Your right hand covers the dime at the outer right, doing the initial steal already described in Simplex Matrix, tabling the card and sliding the stolen dime beneath the palm-up hand's fingers as it moves toward the coin at inner right,

Your right hand stops when it's halfway between the inner and outer corners. Your left hand comes over to your right hand, and your right thumb and fingers grasp the fan's lowermost card. Your right second and third fingers nip the right edges of both concealed dimes so they're firmly supported beneath the card once your left hand moves away (fig. 635 in which the card is transparent). Continue moving your right hand inward until the inner end of the card covers the dime that's visible on the table. Push downward with your thumb and slide your fingers out from beneath the card, releasing the two dimes held at your fingertips so they fall onto the table. The fourth dime, which was hidden beneath your fingers, also stays beneath the card, but it's farthest to the right and -shouldn't interfere with the others. All four dimes are now loaded under that card.

Your right hand places the two remaining cards, one at a time, over the dimes on the left side. Clap both hands above the layout. Your right hand picks up the card at the outer right at its right long side (thumb above, fingers below) showing the coin beneath it has vanished. Without pausing, use that card to scoop up the card at the outer-left corner, trapping the dime between the cards. (Your left fingers can help by holding the left long side of the tabled card in place as the other card moves beneath it.) Lift both cards and place them into your left hand, held at the fingertips.

Your right hand removes the lowermost card from your left hand and uses it to scoop up tile card and dime beneath it at the inner-left corner, placing those two cards beneath the one already in your left hand. Your right hand turns over the card at the inner right to reveal four dimes (fig. 636).

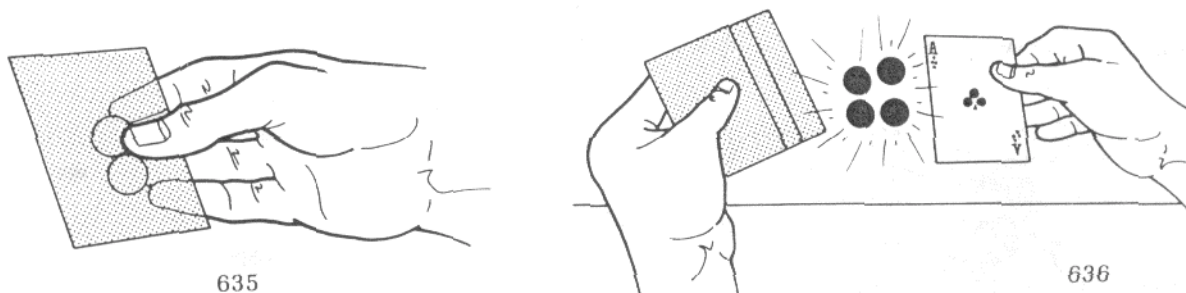

Turn the right-hand card face up and toss it onto the center of the mat. Take the bottom card from your left hand and toss it, face up, onto the center of the mat also. Take the lowermost of the two cards remaining in your left hand and toss it face up with the others. As your right hand takes the last card from your left hand, curl your left fingers slightly and turn your hand palm down into a relaxed fist. Your right hand immediately gathers the four dimes at the inner right and tosses them into your left hand which half-opens to catch them. Place them back in your pocket to end. The clean up should be done casually - the routine is over as far as the spectators are concerned so don't act suspicious.

"They're Here, No There, No Where?"

Edward Marlo

Often someone like Marlo will take a mass-marketed gimmick and apply it in ways undreamed of by its inventor. Both this routine and the next are examples of just such a case. Marlo has developed ingenious

handlings of Tim Wenk's E Pluribus Unum gimmick. The idea of soldering coins together in a group is not new by any means. It is only Weak's application of the gimmick that is original, and Marlo's approach is entirely different. The only sleight per se that is used in the routines is the Dingle-Schneider Pickup Move (and that move appears, unfortunately, without any credit in Weak's manuscript).

You need a gimmick which consists of three quarters soldered together in a triangle (fig. 637). You also need four regular quarters, four playing cards, and a mat. You must be seated at a table opposite the audience. Have the gimmick in your lap.

To perform, your right hand gestures as you patter and drop your left hand into your lap. Pick up the gimmick and hold it on the fingers inside your closed fist (fig. 638). As your right hand lifts the packet of four face-down squared cards your left hand ascends to the table. Your right hand moves to the left and places the cards onto your left hand, which turns palm up to receive them (fig. 639).

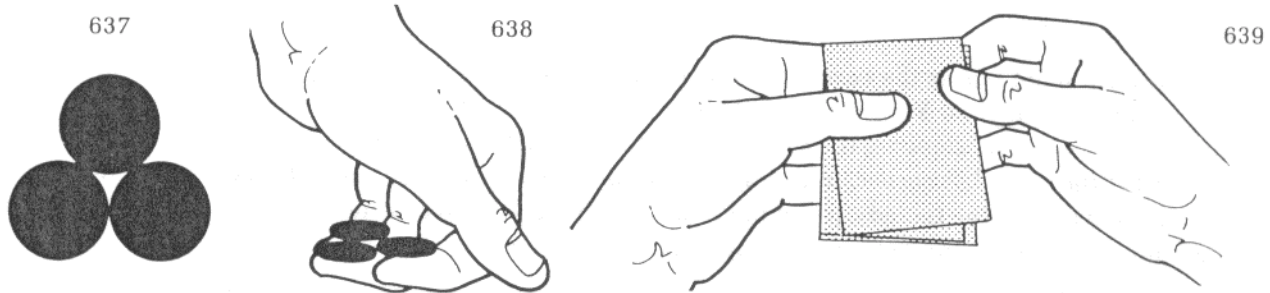

Both hands spread the cards to the right into a small fan, your left fingers pushing the gimmick to the right beneath them until it's under the upper card (fig. 640 is an exposed view). Your right hand moves away while your left hand holds the whole business. Arrange the four quarters into the standard square formation, the two inner quarters an inch or two from the table edge (fig. 641).

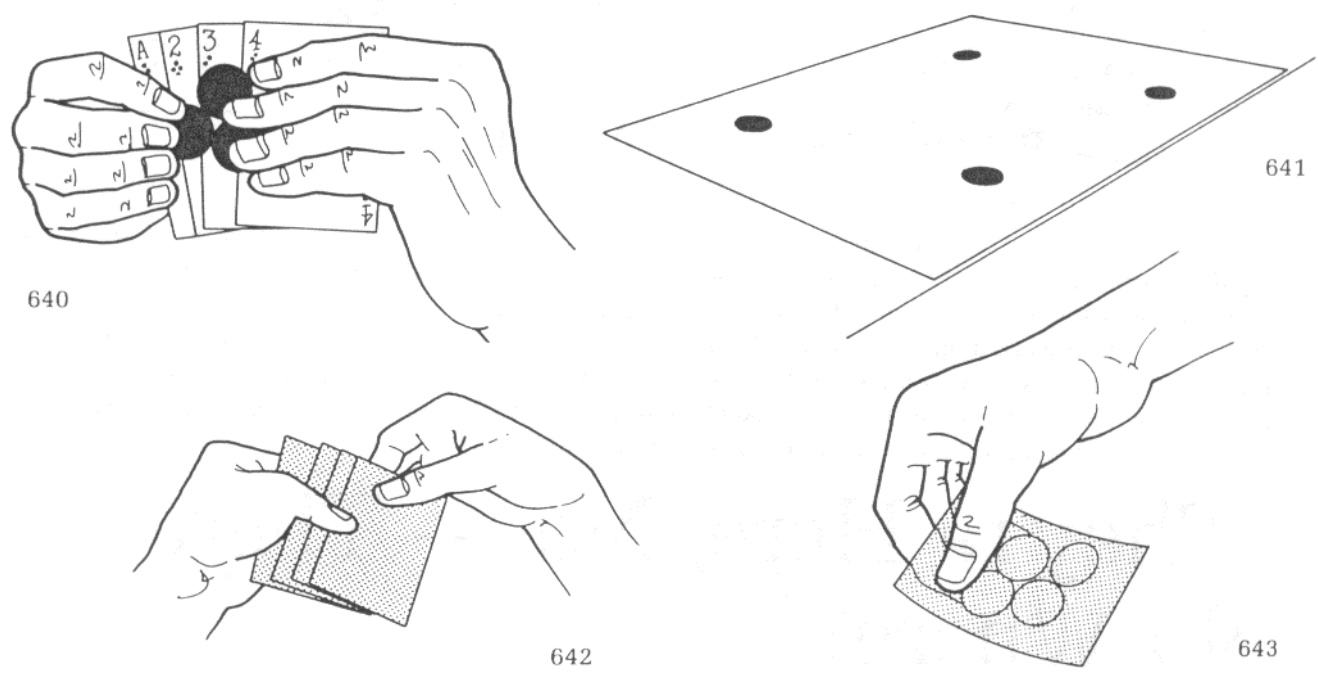

Your right hand returns to the cards and takes the top card at its outer end, your left hand bending slightly inward at the wrist to facilitate this (fig. 642). Your fingers move onto the gimmick and, as you take the card away, retain it beneath. Place the card over the quarter at the inner right, being careful not to let the gimmick hit the coin already there (fig. 643 in which the card is transparent).

Cover the remaining coins one at a time, angling the cards as shown in Figure 644, which just makes the Pickup Move easier when you get to it.

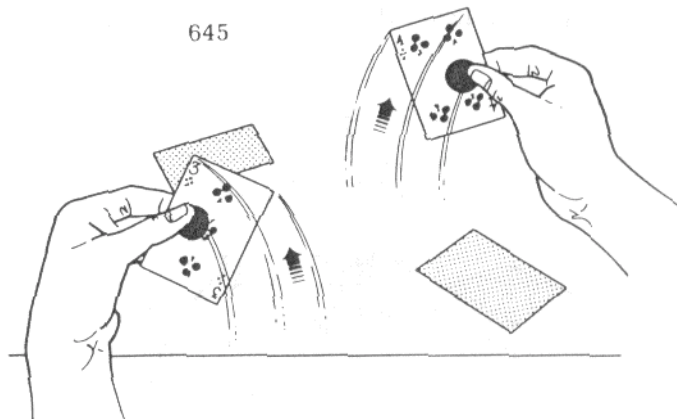
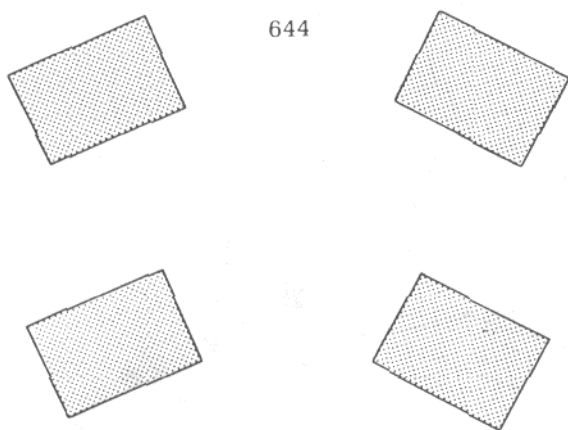

Snap your fingers. Move your left hand over the card at the inner left, and your right hand over the card at the outer right. Both hands lift those cards simultaneously doing the Pickup Move - it appears as if both coins have vanished (fig. 645). Without pausing your left hand lays its card onto the table, face down and horizontally, as in Figure 646, the coin stays hidden beneath it. Your right hand lays its card onto that card, spread slightly forward (fig. 647).

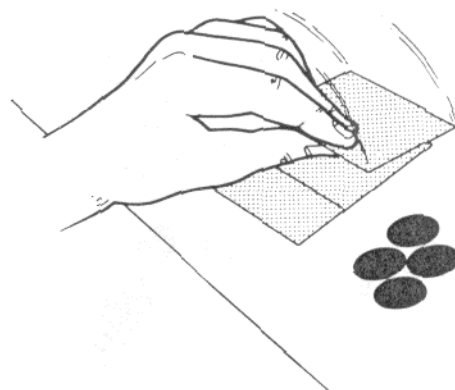
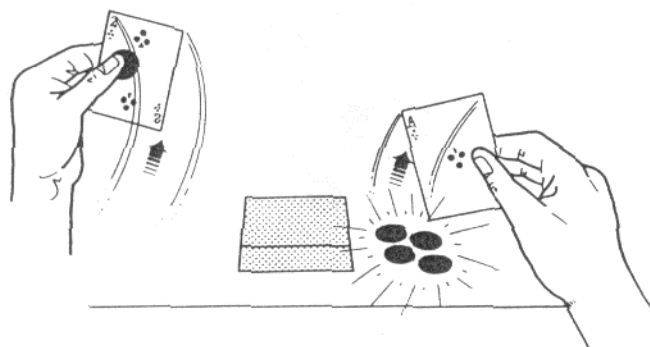
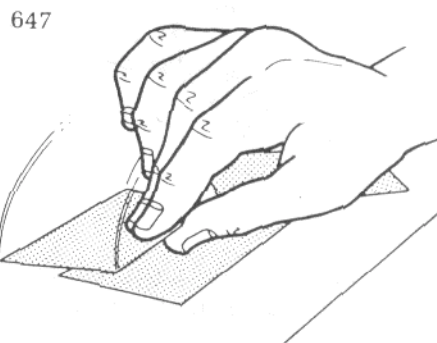
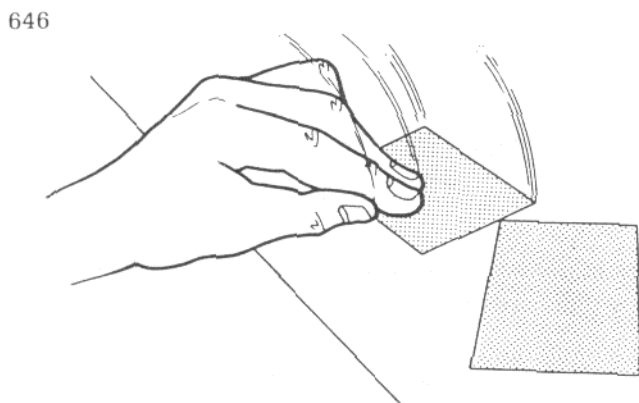

Both hands immediately move: your right hand over the card at inner right and your left hand over the card at outer left. Your left hand does the Pickup Move while your right hand simply lifts its card revealing all four coins beneath it (fig. 648). Your left hand lays its card onto the two already in the center of the mat, spread slightly forward (fig. 649),

Lower your right hand slightly until it's a few inches above the tabled coins, simultaneously touching the quarters with your left fingers as if to arrange them (fig. 650). Lower the card until its lower side is pressed against the table. Your left thumb immediately kicks the gimmick toward you, off the table and into your lap (fig. 651). Lever the card face down over the remaining single coin (fig. 652).

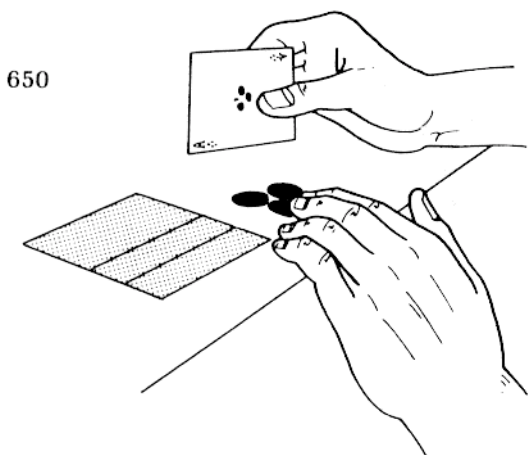

650

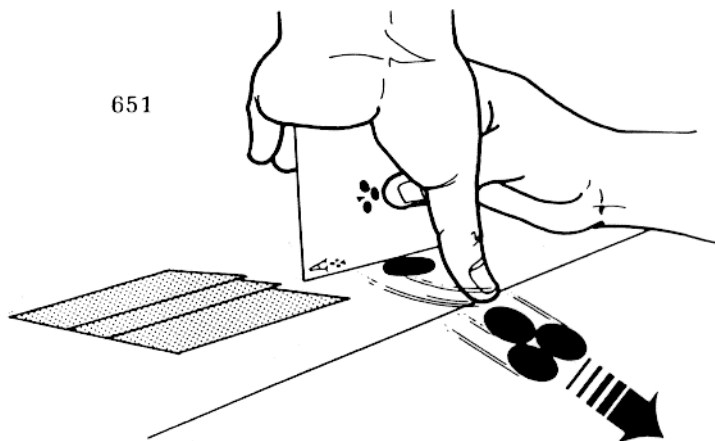

651

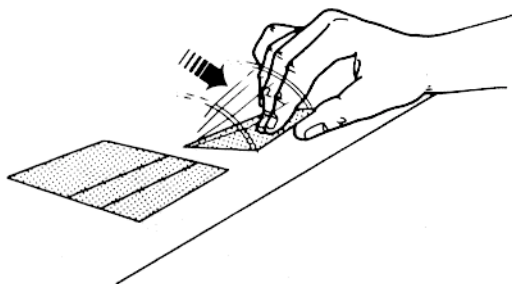

652

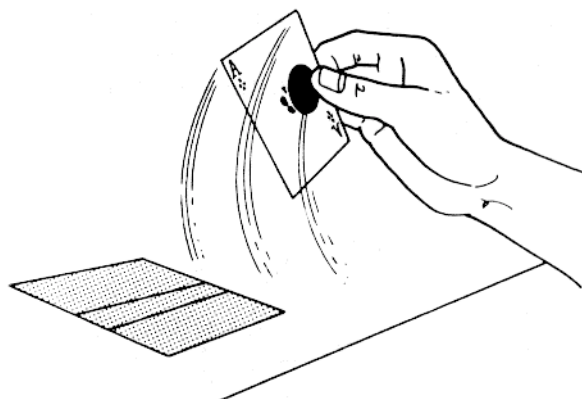

653

Raise your hands and snap your fingers. Do the Pickup Move with the card at the inner right showing that all four coins have instantly vanished (fig. 653). Lay that card onto the others, spread outward in a similar manner.

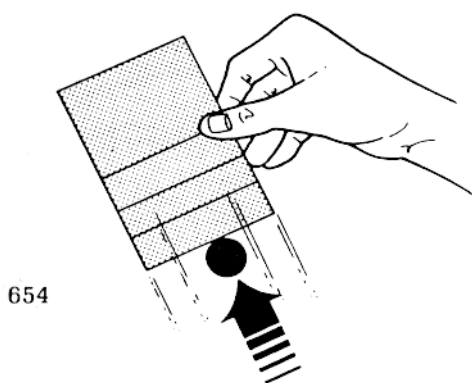

654

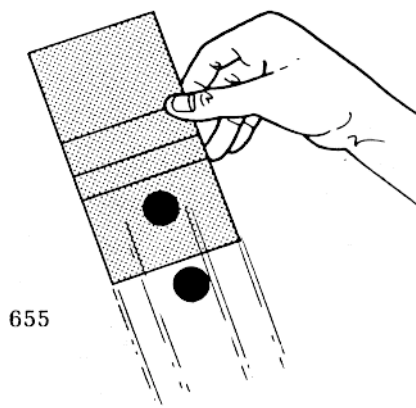

655

Pause for a moment, then wave your hands over the cards. Turn your right hand palm up and grasp the right ends of all the cards between thumb and fingers. Slide them forward to reveal a coin (fig. 654). Let the bottom card drop and continue moving your hand forward until the second coin, on top of that card, is visible (fig. 655). Let the next card drop and move the remaining two forward until the third coin is visible,

then let the third card drop. Lift the remaining card and slide it beneath the coin which rests on the table near you (fig. 656).

The next routine, What Happened?, can be used immediately after this.

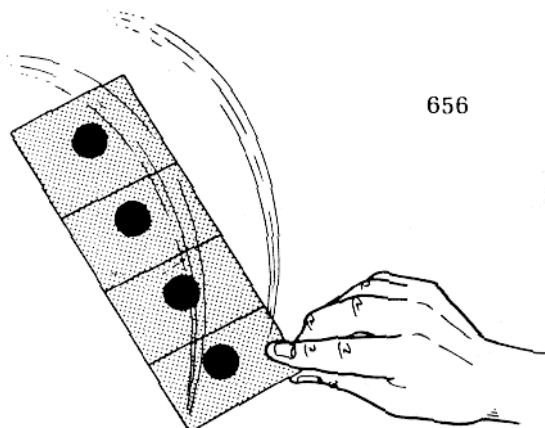

What Happened?

Edward Marlo

This can be used on its own, or as a logical follow-up to the preceding routine. Let's assume you've just finished that one and are going to continue. Allow your right hand to drop into your lap and pick up the gimmick, holding it on the fingers of your palm-up hand.

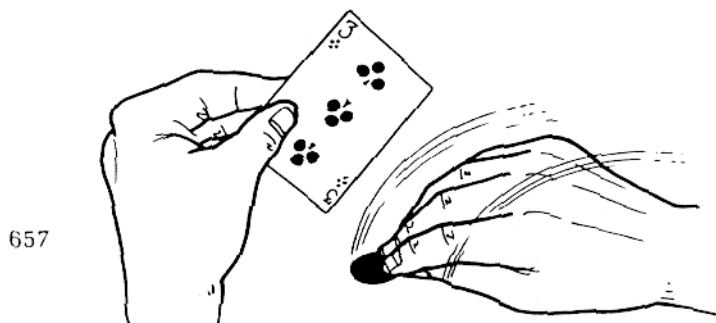

Your left hand gathers the quarters that are on the table and drops beneath the table edge as if to put them away since the routine seems to be over. Actually, though, your left thumb pushes one of the quarters onto the gimmick in your right hand, and your right hand comes out from beneath the table with the coins displayed. Say, "Well, I don't usually do this, but would you like to see it again?" As you talk your left hand silently places the three coins it holds somewhere in your lap, out of the way (other things will be lapped later on).

All that takes only a few seconds, and by the time the spectator says "yes" your left hand should be above the table again, arranging the four cards, face down, in the usual square layout. Lift the card at the inner left with your left hand and turn your right hand palm down to thumb off the loose coin onto the table (fig. 657). Place the card over the coin. Your right hand remains palm down afterward.

Your right thumb pushes the gimmick forward so that one of its coins appears at your fingertips (fig. 658). Your left hand lifts the inner side of the card at the outer left as you stick your right fingertips beneath it (fig. 659). As soon as the coin is covered by the card your right thumb pulls the gimmick back, moving the coin under your fingertips again (fig. 660). Withdraw your hand from beneath the card and lower it onto the table as if the coin was beneath it.

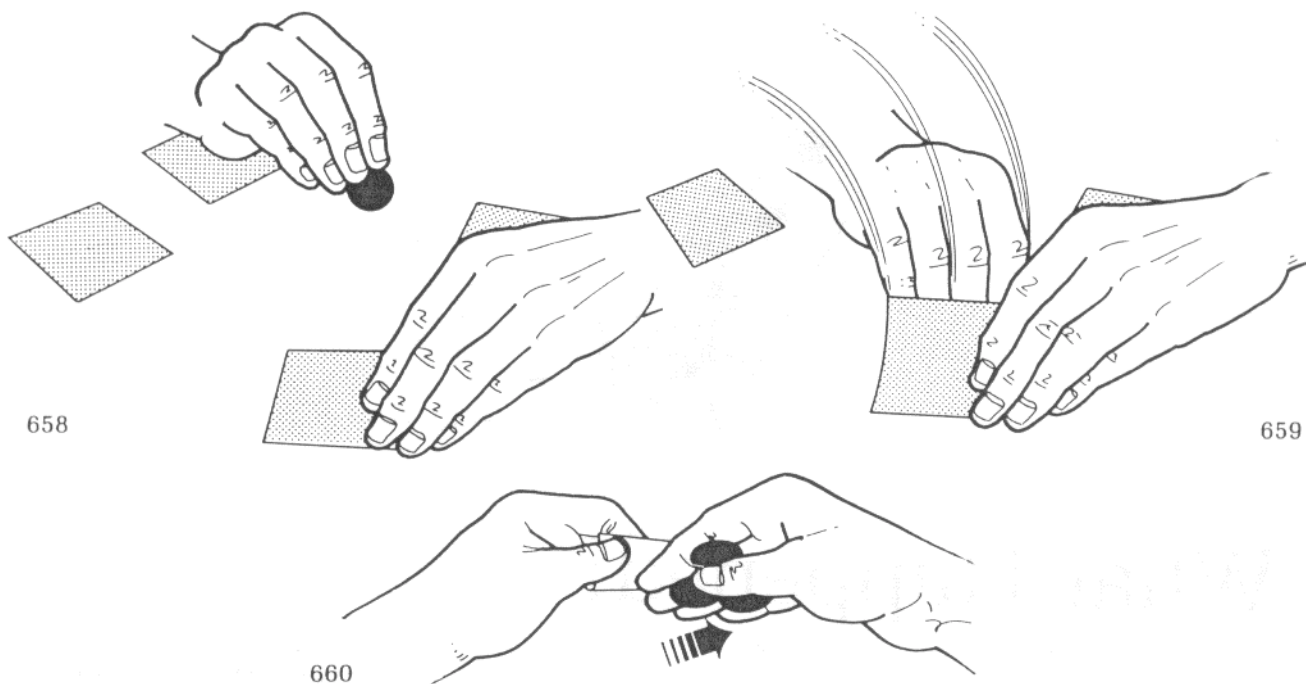

Repeat the same fake placement at the outer right, pushing the gimmick partially into view and pulling it back again as your left hand lowers the card over your fingers.

Repeat again at the inner right - this time, however, actually place the entire gimmick beneath the card and leave it there. When your left hand lowers the card over the gimmick leave the outermost coin sticking out from beneath it (fig. 661). With your right first finger push that coin to the right, beneath the card, also pivoting the gimmick (fig. 662 in which the card is transparent).

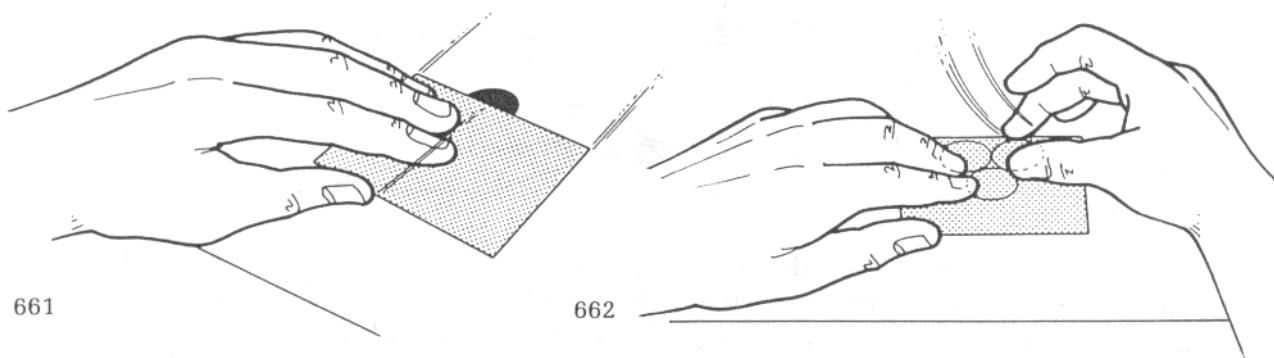

The spectators think that there is a coin beneath each card. Actually there are no coins beneath the outer cards, one beneath the inner-left card, and three (the gimmick) beneath the inner-right card.

Lift the card at the inner left with your left hand to show that the coin is still there. Replace it, snap your fingers, and do the Pickup Move showing the coin has vanished. A moment later your right hand grasps the card at the inner right and draws it back a bit to reveal two coins. At the same time your left hand moves

back to the table edge and lets the hidden coin slide into your lap (fig. 663). Return the card to its position at the inner left as your right hand slides its card forward until the gimmick is covered, and also getting it ready for the Pickup Move (i.e., slide the card forward until your thumbtip feels the innermost coin of the gimmick touching it).

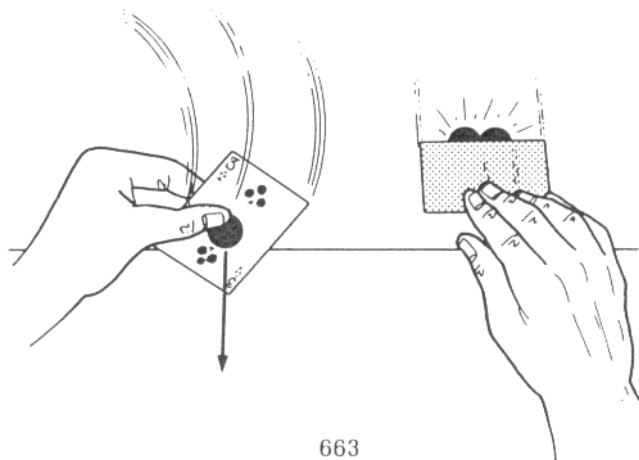

Both hands snap their fingers and then move at the same time. Your left hand lifts the card at the outer left, your right does the Pickup Move at the inner right. Act surprised that there are no coins at the inner right and move both hands toward you, your right hand placing its card with the gimmick behind the card in your left hand (fig. 664).

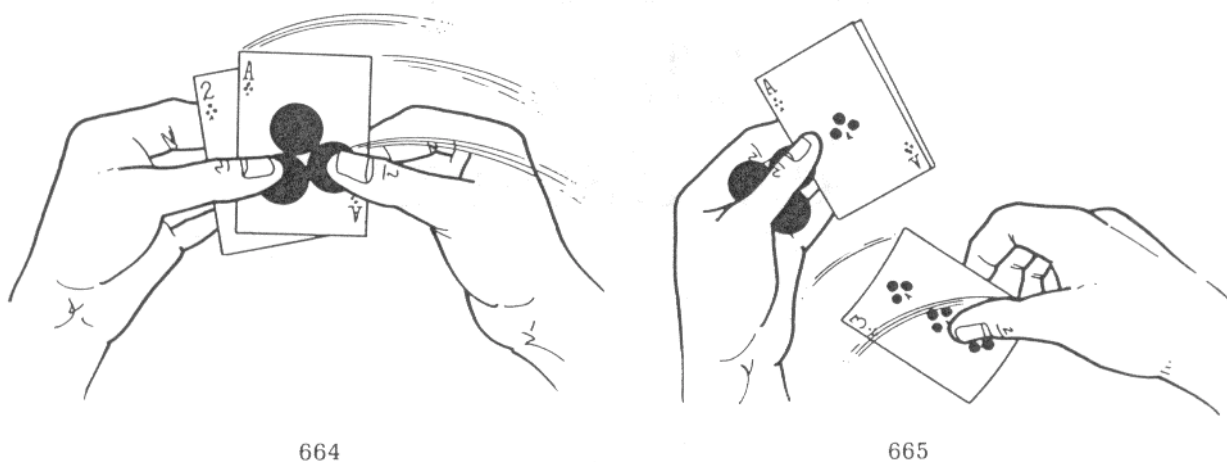

Your right hand quickly turns over the cards at outer right and inner left to show no coins. At the same time your left thumb pulls the gimmick into finger palm (fig. 665). Your right hand comes back to your left hand and tosses the cards it holds, one at a time, onto the table to end as your left hand settles into a relaxed fist on the table or drops into your lap.

In Addition: If you use Roth's technique for lapping more than one coin (see Ultra Coin Assembly) you can lap the gimmick from the position shown in Figure 664. Simply move your hand back to the table edge and let it go.

**SLYDINI:
Three
New Sleights**

Table Tilt Vanish

Slydini

Tony has managed to hold onto this and the two sleights which follow for many years - none have ever appeared in print. This vanish is universally applicable like the Revolve Vanish, and I'm sure it will quickly find its way into many of your routines.

You must be seated at a table opposite-the audience. The fingers of your palm-down left hand rest on the table in front of your left shoulder, while your palm-up right hand (at the table edge) holds the coin by its edges between thumb and second finger (fig. 666). Note that the coin is broadside toward the audience.

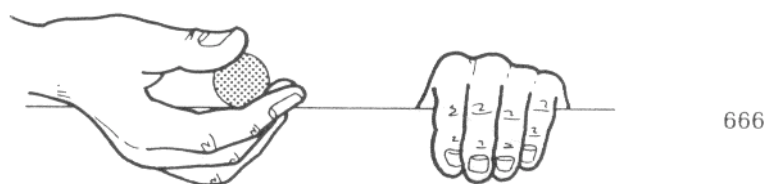

Begin turning your body to the left. As your body turns both hands start to move: your left hand rises, turning palm up and moving about four inches beyond the table edge; your right hand turns palm toward you (the back of your hand toward the audience - figs. 667 and 668 show two stop-action views).

At the precise moment that your right hand is in the position shown, when the coin is concealed from the audience by the back of your hand, simply drop it into your lap (fig. 669). Without pausing your right hand moves over your left hand and pretends to place the coin (which has already been lapped) into it (fig. 670).

Immediately tilt your right palm up toward the audience and close your left fingers into a fist (fig. 671). Wave your right hand over the closed fist a few times, then slowly open it revealing the vanish (fig. 672).

That's basically what happens, though there are a few more technical points that add to the deceptiveness. It's very important that your body turns and both hands move to the left simultaneously. It sounds strange to say this, but you communicate the intention of movement to the left, and that is imparted to the coin. In other words, because you are moving to the left you give the impression that the coin is also moving to the left. Once you attain that ability of transferring the intention of movement to the coin you've accomplished half the illusion.

There's also an attention shift that occurs midway through the move. You can break the sleight into two parts - the display of the coin and the placing of it into your left hand. In the first part all attention is on your right hand and the coin, while your left hand is ignored. In the second part you turn to the left, raise your left hand and turn it palm up, and turn your right hand palm toward you. Your shift of attention to your left hand and its movement will pull all eyes away from your right hand. Its slight palm-toward-you turn will go unseen.

Finally, you must NOT break your right hand's action into two separate movements. It turns palm toward you and drops the coin as it's already moving to the left. Done without pauses the secret drop is undetectable.

667

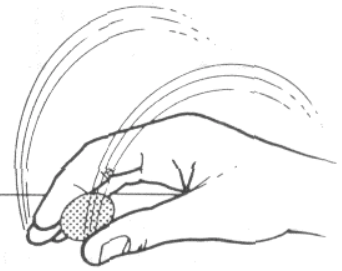
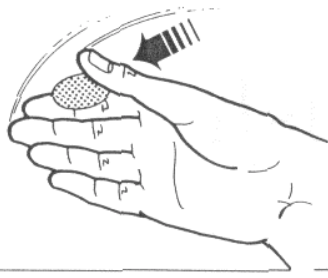
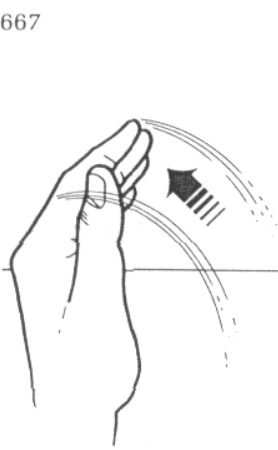

668

669

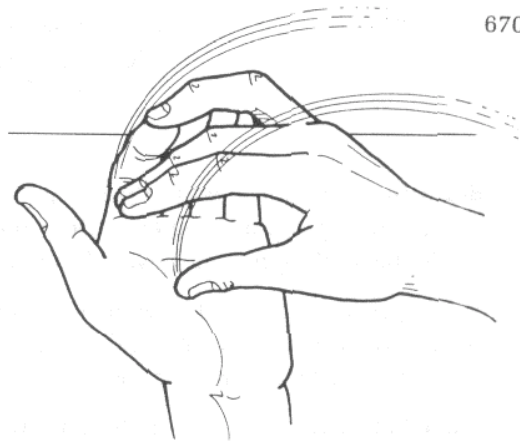
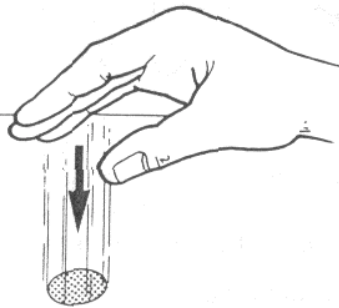

670

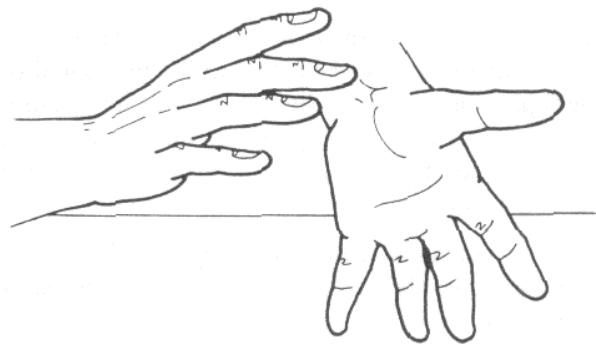
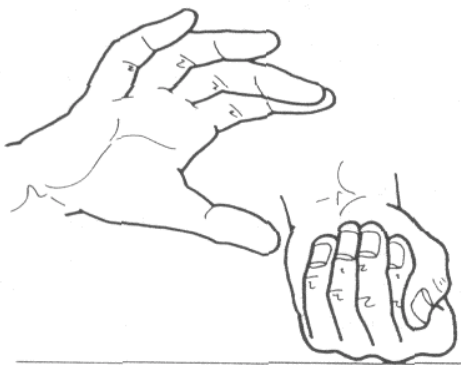

671

672

Palm Tilt Production

Slydini

There are two handlings for this, and the sitdown version is a perfect follow-up to the Table Tilt Vanish just described so I'll teach that one first. The standup handling will follow.

You should be seated at a table opposite the audience with a coin in your lap. Face forward and broadly wipe your hands against each other a few times (fig. 674). Lean back, relax, and allow both hands to drop into your lap (fig. 675). Look directly at the spectators and shrug, as if to say, "I don't know where the coin went, either."



Turn your head to the right as if you see a coin floating in the air about two feet away (fig. 676). Lean forward, raise your right hand, and reach for the coin (fig. 677). At the same time your left hand grasps the coin that's been in your lap between thumb and first finger. Pretend to grab something with your right hand. Lean back and retract your right hand, bringing it across your body to your left elbow - at the same time raising your left hand to be beneath your right elbow (fig. 678). Keep the back of your left hand toward the audience to conceal the coin.

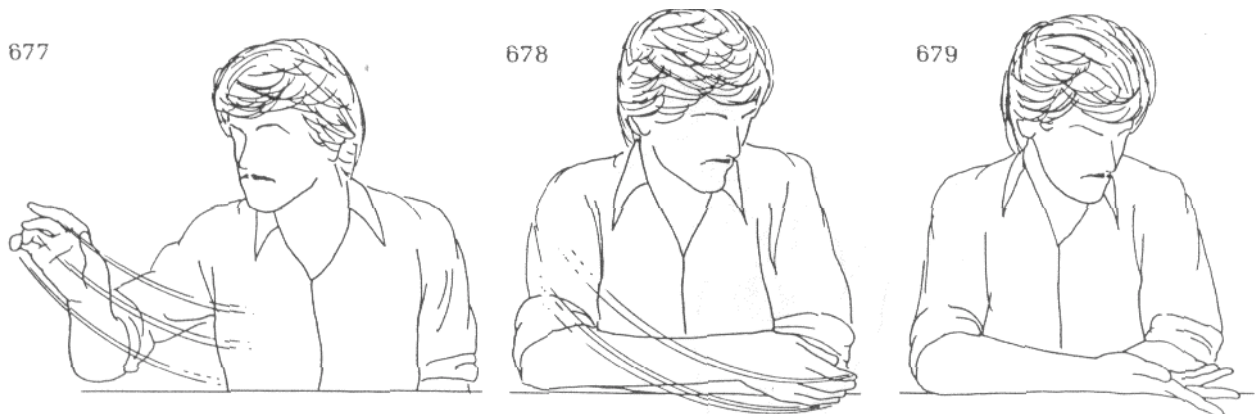

Tilt your right palm toward the audience to show it empty (fig. 679). Then, turn it back toward you and separate your hands. As your hands pass each other your left hand loads the hidden coin into a right-hand Downs palm (fig. 680). Immediately separate your hands, your left hand turning palm up (fig. 681).

Bend your right hand back at the wrist and reach to your right, as if plucking something from the air (fig. 682). The coin is concealed behind your thumb. Move your right hand directly over your left hand and pretend to drop the invisible coin onto it. Reach to your right again (though not as far as last time - the back of your hand remains toward the audience) and repeat the pantomime of plucking something from the air

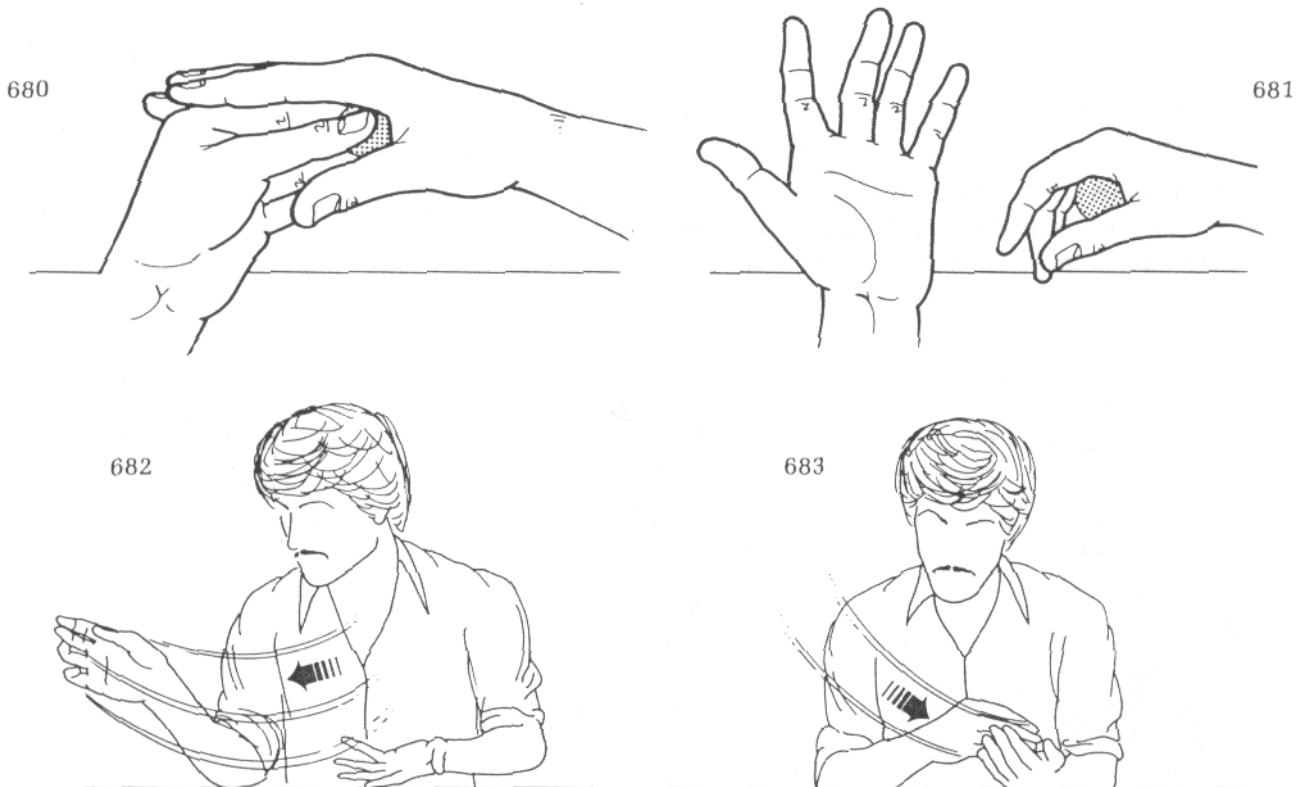

and dropping it onto your left palm. This time, though, tilt your left palm a tiny bit toward you - just enough so that the palm is no longer visible to the audience (fig. 683). Relax your right hand and allow the Downs palmed coin to drop onto your left palm (fig. 684). Your left fingers remain straight during this, and your right hand immediately moves forward - to directly in front of you to continue the plucking action.

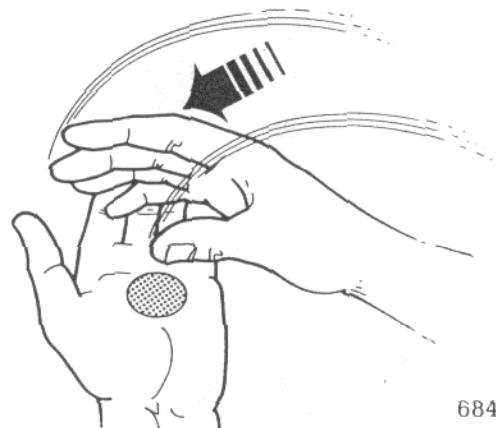

Do that once or twice more, making small tossing motions toward your left hand. Now, close your left fingers into a fist and lower your hand slightly. Wave your right hand over it and slowly open your left fingers to reveal the coin.

The Standup Handling

Let's assume that you've just done a Retention Pass, apparently placing the coin into your left hand and actually retaining it in your right hand in classic palm, Open your left fingers to show that hand empty. The spectator must be standing directly to your right.

Turn your left hand palm down again. Extend your right hand until it's directly in front of the spectator, practically under his or her nose (fig. 685). Both hands, now palm down, spread their fingers wide (fig. 686). Simultaneously turn both hands palm up, but close your right fingers (fig. 687). At the same time look directly at the spectator and say, "Gone."



Without pausing turn both hands palm down again, spreading your right fingers as before. This is very subtle: it appears to the spectator that he's seen both hands empty. He literally cannot see your right hand, though, because it's so close to him!

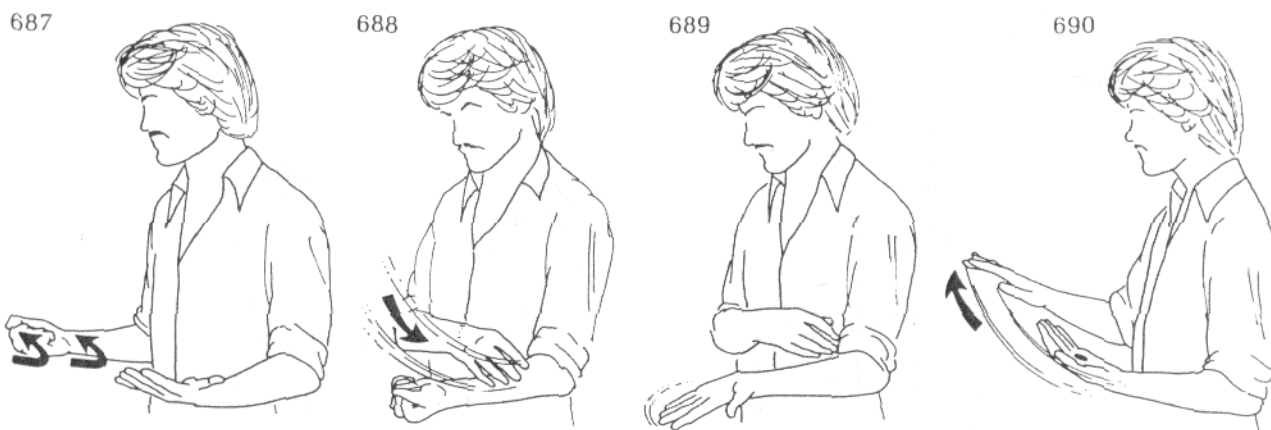

Turn your left hand palm up and rapidly sweep your right hand over it, closing your left fingers (fig. 688). Your right hand freezes over your left forearm after passing over the closing fingers. Do not drop the coin into your left hand yet.

Look at the spectator and say, "You think I did something funny, don't you?" Smile and slowly open Your left fingers to show the hand empty (fig. 689). Pause only a moment, then sweep your right hand over your left hand and outward without pausing, in the process dropping the coin onto your left palm (fig. 690). At the same time, of course, your left hand tilts slightly toward you so that the coin cannot be seen by the spectator (fig. 691 is the spectator's view).

Make a few light tossing motions toward your left hand, keeping your eyes on your right hand throughout. After a few seconds close your left fingers and lower your hand. Wave your right hand over it, then open your fingers to reveal the coin.

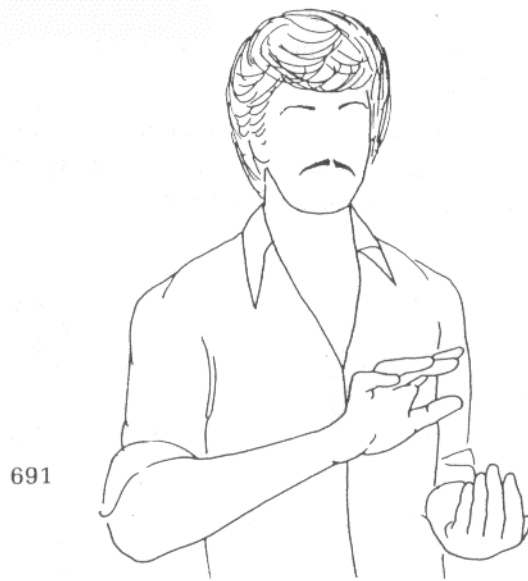

Automatic Sleiving

Slydini

Don't let the brevity of this description deceive you - this is the most ingenious method for sleiving a coin without any of the usual telltale jerks or bodily twitches that you'll probably ever read. Slydini, noting that most coin men appear to be having a muscle spasm when they sleeve a coin, decided that there simply must be a better way!

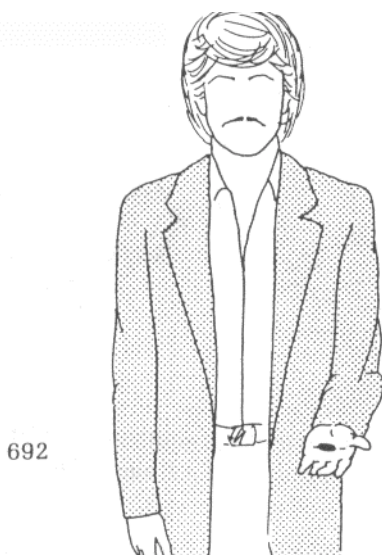

You must be standing, and the audience can be standing almost anywhere - it doesn't matter. A coin rests on your palm-up left hand, which is held directly in front of you, fingers pointing forward (fig. 692). Extend your palm-down right hand directly in front of you, pointing toward a spectator, and say "Watch" (fig. 693).

Stick your left thumb up in the air - it's going to act as a "stop" for your right hand in a moment (fig. 694). Swing your right hand in a counter-clockwise quarter circle toward your left hand (fig. 695). When your hands meet your right palm should be a fraction of an inch above your left palm, and your thumbs should mesh (fig. 696). In other words your extended left thumb hits your right thumb crotch. That causes your right hand to stop moving suddenly, and its momentum is imparted to the coin lying on your left palm which promptly flies up your right sleeve (fig. 697).

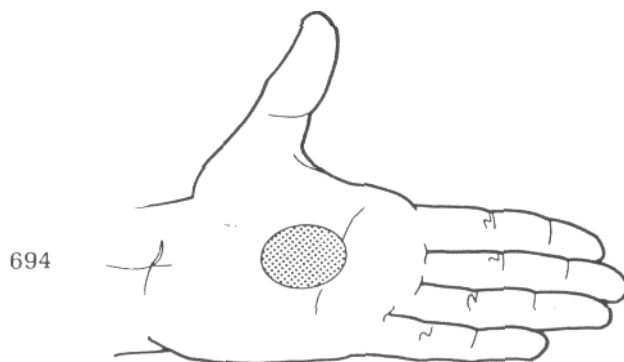

Without pausing simultaneously curl your left thumb and fingers into a fist and lift your right hand, moving it around in a waving motion (fig. 698). After some appropriate mumbo jumbo open your left hand to show the vanish.

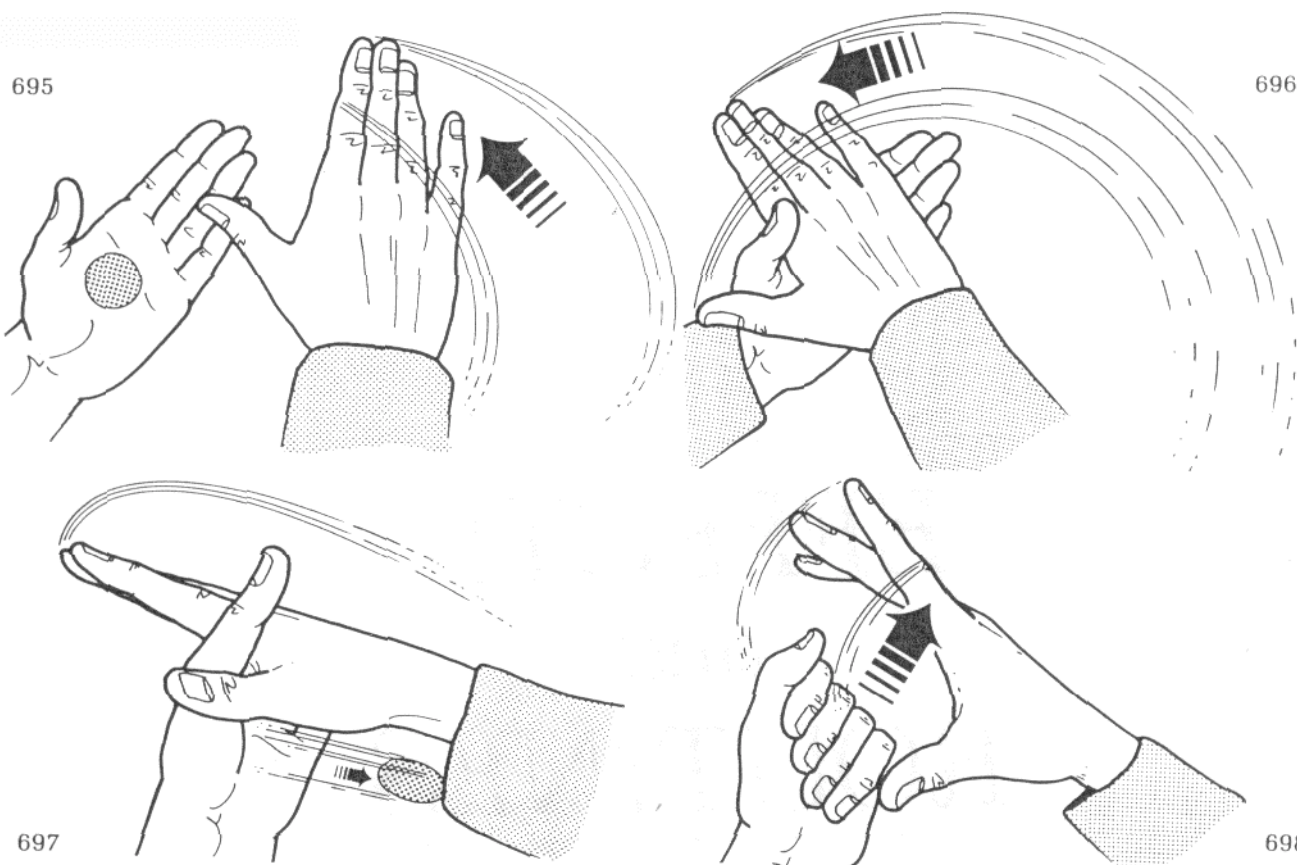

In Addition: This is going to take some practice because there's a knack involved. it's worth it, though, because your left hand does not appear to move at all. (Actually it does move, though it happens so quickly that it's invisible.)

Also, it's very important to extend your right hand toward the spectator just prior to the move because that sets the position of your sleeve so it hangs downward fully open. If you did the move without first extending your arm you'd probably miss because the sleeve is always twisted slightly and partially closed.

EFFECTS
And
ROUTINES

Key to the Orient

Scott Weiser

All of Scott's plots are interesting, and his methods are also ingenious applications to accomplish them. You'll be amazed at how cleverly he utilizes Edge Grip in this effect. You must be seated at a table opposite the audience (though it's possible to do this while standing, and I'll mention one obvious method later). You need two identical Chinese coins with holes in their centers, and a regular padlock and key. The metal hook of the lock must be able to fit fairly comfortably through the center of either coin (so, you may have to use a smaller lock). It's easy to get into position.

Drop the lock (which is closed), its key, and one of the Chinese coins onto the table. The other coin rests on your right thigh. Pick up the lock and display it - ignore the coin on the table for the moment. Give the lock and its key to a spectator and ask him to open it. As he's doing that your right hand drops into your lap and grasps the duplicate coin in Curl Palm (see Roth's section on Edge Grip technique if you don't remember this). Immediately raise your right hand back to the table, where it rests in a relaxed fist.

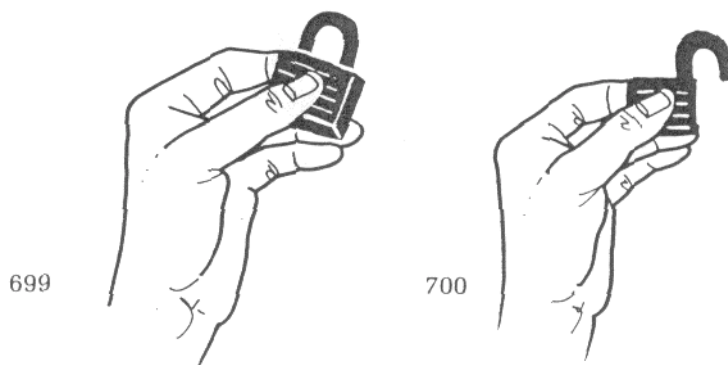

Extend your left hand to the spectator to take the lock, asking him to keep the key. When you take the lock grasp it between your left thumb, first, and second fingers as in figure 699. Twist the upper portion of the lock, the hook, around so that the prong that normally would go into the base extends downward to the right (fig. 700).

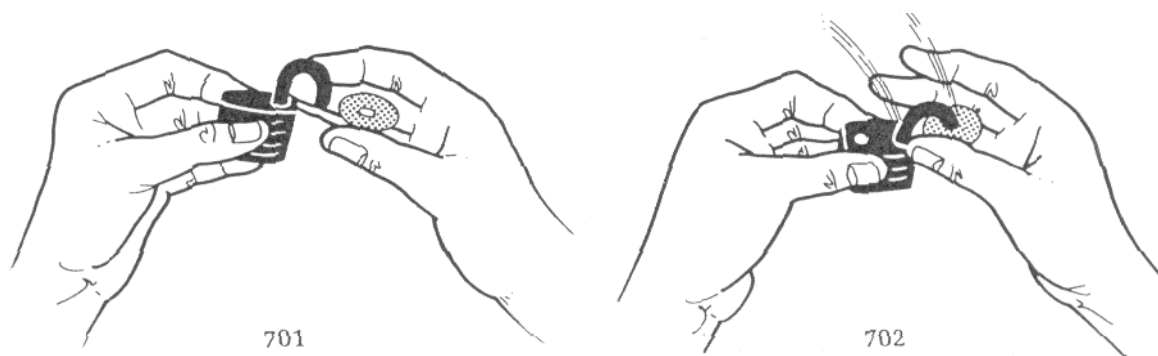

Retract your left hand, at the same time raising your right hand slightly, transferring the coin from Curl Palm to Edge Grip (fig. 701). All you're apparently about to do is place the lock into your right hand and close it. Your left hand guides the prong of the lock downward through the center of the coin (fig. 702).

Without pausing your fingers turn the base of the lock around so it's in closing position (fig. 703). Continuing, your left first and second fingers move beneath the lock's base while your left thumb moves on top of the hook (fig. 704). Press your thumb and fingers together, closing the lock.

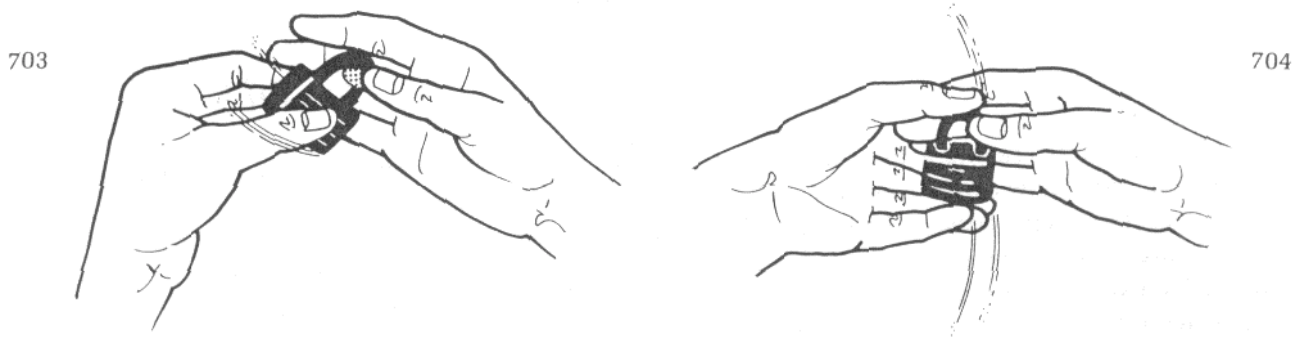

Touch your right thumb and second fingertips together. They should be just inside the hook (that is, between the prongs that extend downward into the base of the lock) (fig. 705). You'll find that you can securely grip the lock by wedging your thumb and second fingertip up against the prong in front of them. Lift your right hand to Edge Grip Display, showing the lock (fig. 706 is the audience view).



The loading, closing, etc., takes only a few seconds in performance. All the movements are natural enough so the audience can be staring directly at your hands and not see anything.

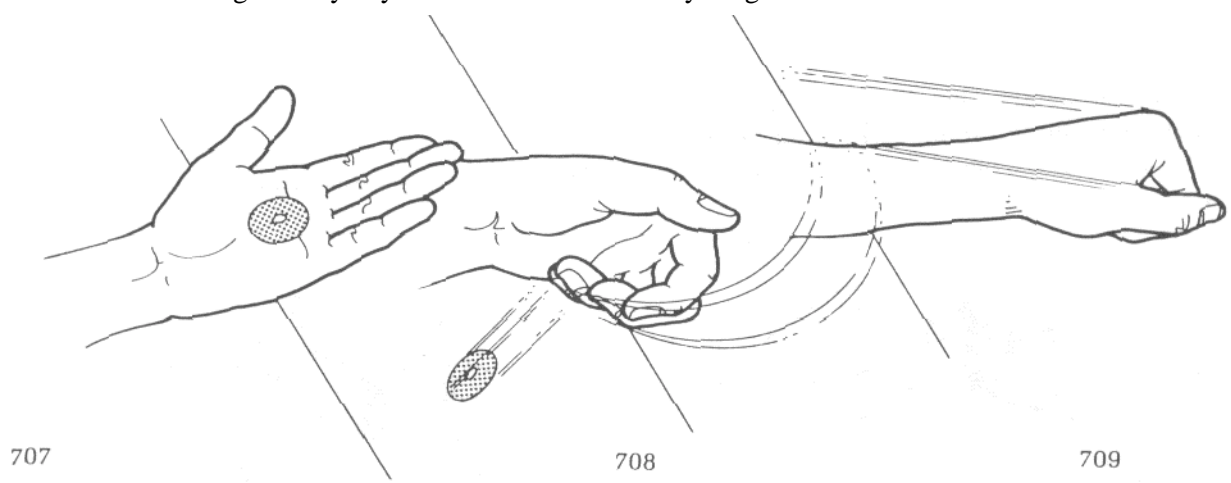

Your left hand draws attention to the coin that's on the table. You can have it examined if you like. Pick it up and maneuver it onto the center of your palm-up hand. Your hand is at the table edge in position for Slydini's Revolve Vanish (fig. 707). Your hand turns palm down, fingers curling at the same time (fig. 708). The coin drops into your lap a second before your curling fingers cover your palm. Your hand immediately moves forward over the table (fig. 709). (Obviously that's a brief description. For the real work you'll have to read *The Best of Slydini and More*. You should, however, be able to learn at least the physical action from the above description.)

Move your right hand fairly close to your left hand and, in the same motion, toss the lock into it (fig. 710). Your left fingers open and close very quickly, catching it. The spectators should not be able to see the coin on the lock if your hands are close enough before the throw. Snap your right fingers and then open your left hand, dropping the lock on the table - the coin, of course, is locked on it. Show your hands empty and ask the spectator to open the lock and remove the coin.

In Addition: The concept, and the idea of loading the coin on the lock while it's in edge grip, are what's important here - the end of the routine can be handled many different ways. You don't, for instance, have to use the Revolve Vanish. Any onehand vanish that laps the coin will do. Also, once you've gotten rid of the loose coin, you can simply show that it's vanished from your left hand and then open your right hand to show its appearance on the lock, i.e., your hands remain apart the entire time.

Finally, as I mentioned earlier, you can do this while standing using sleeving techniques. You would start with the extra coin up your right sleeve. As the spectator opens the lock you retrieve the coin into Curl Palm. Load it onto the lock as described and display it. Take the visible coin with your left hand and, using Dr. Roberts' technique (which is described in Bobo), sleeve it as you close your hand into a fist. Throw the lock into your left hand and finish as described.



Framed

Scott Weiser

Another clever offbeat plot and method. You need a two-sided purse frame (which is simply a purse frame that has two compartments from which you've removed the bag). You also need a regular silver coin, an expanded silver shell, and two Chinese coins that are the same size as the half dollar and will fit in the shell. You can substitute copper coins for the Chinese if you like. You must be seated at a table opposite the audience. Place the silver coin in your lap. Place the silver shell over one of the Chinese coins and place the other Chinese coin on top of that. Finger palm that two-coin stack (with the shell on the innermost coin, shell-side outward) in your left hand (fig. 711). The double purse frame lies on the table.

Your left hand rests in a relaxed fist on the table while your right hand lifts the purse frame and displays it to the audience. Place the purse frame into your left hand (which is held palm toward you), held between your thumb base and the tips of your first and second fingers (fig. 712). Say, "As you can see this purse frame has two compartments. One compartment was manufactured in The United States, the other in China. Even stranger is the fact that each compartment produces coins indigenous to its own country. I'll show You."

Say, "If I open the American compartment I'll produce a half dollar." Your right hand snaps open one of the two compartments. Reach inside with your thumb, first, and second fingers and grasp the shelled Chinese coin (fig. 713). Pull it out of the purse frame and lay it, shell side up, on the table just to the left.

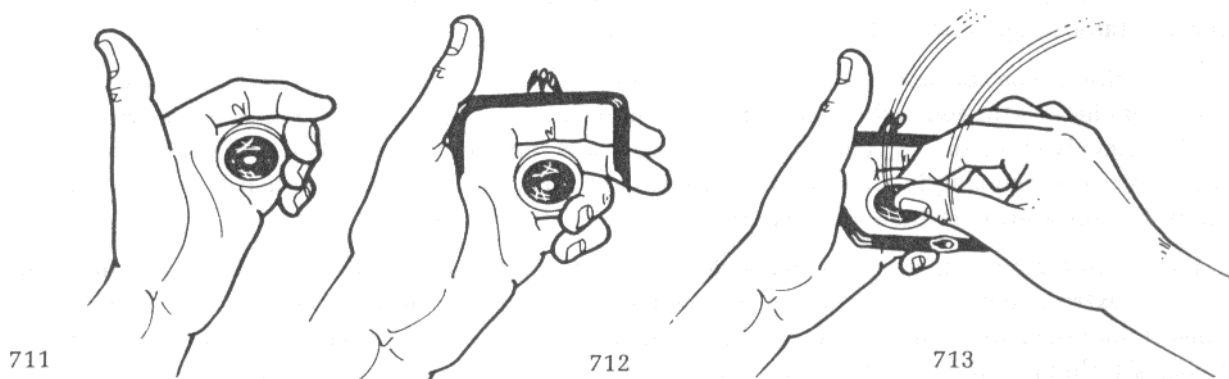

Continue, "...and that leaves nothing there." As you say that you perform a subtlety of Johnny Paul's. Turn your right hand palm down and insert your first, second, and third fingers into the frame (fig. 714). Now turn your hands palm toward audience and wiggle your right fingers (fig. 715 is the spectators' view). Almost immediately lower and turn your hands back to their original positions and pull your fingers out of the purse. That whole bit takes only a second, but it's a terrific visual convincer because both hands appear to be completely empty.

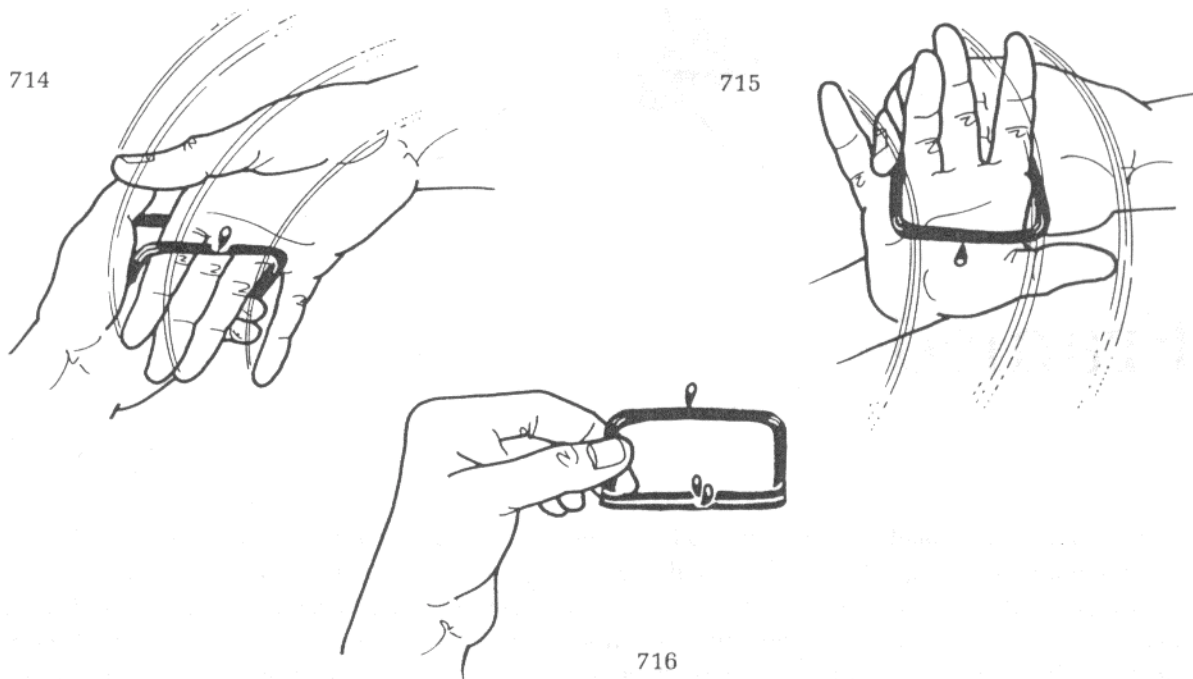

Continue, "But if we look into the Chinese compartment we find a Chinese coin." Your right fingers snap open the other compartment and reach inside. Pull the Chinese coin that's in finger palm out of the purse and table it about four inches to the right of the shell.

Extend your left hand toward the spectator giving him the purse frame to examine. As you do, your right hand drops to your lap and classic palms the silver coin. Immediately raise it back onto the table, where it rests in a relaxed fist. Lean forward to take the purse frame back with your left hand. Raise your right hand and snap open one of the compartments and regrip the purse with your left thumb, first, and second fingertips (fig. 716).

Say, "Stranger still, these compartments remain loyal to their own country." Turn your right hand palm down, fingers together and straight, and lower them onto the Chinese coin that's on the table (fig. 717). Slide it toward you until it falls off the table and into your lap (fig. 718). Immediately curl your fingers inward and allow the classic palmed silver to drop to fingertip rest. Move your thumb onto it and simultaneously turn your hand palm up and straighten your fingers, your thumb holding the silver coin in place behind them (fig. 719).

Continue, "If I take the Chinese coin and drop it through the American compartment it turns into a half dollar." As you say, ". . . it turns. . .," turn your right hand palm down directly over the purse. Drop the half dollar through, allowing it to fall onto the table (fig. 720). Show both hands empty.

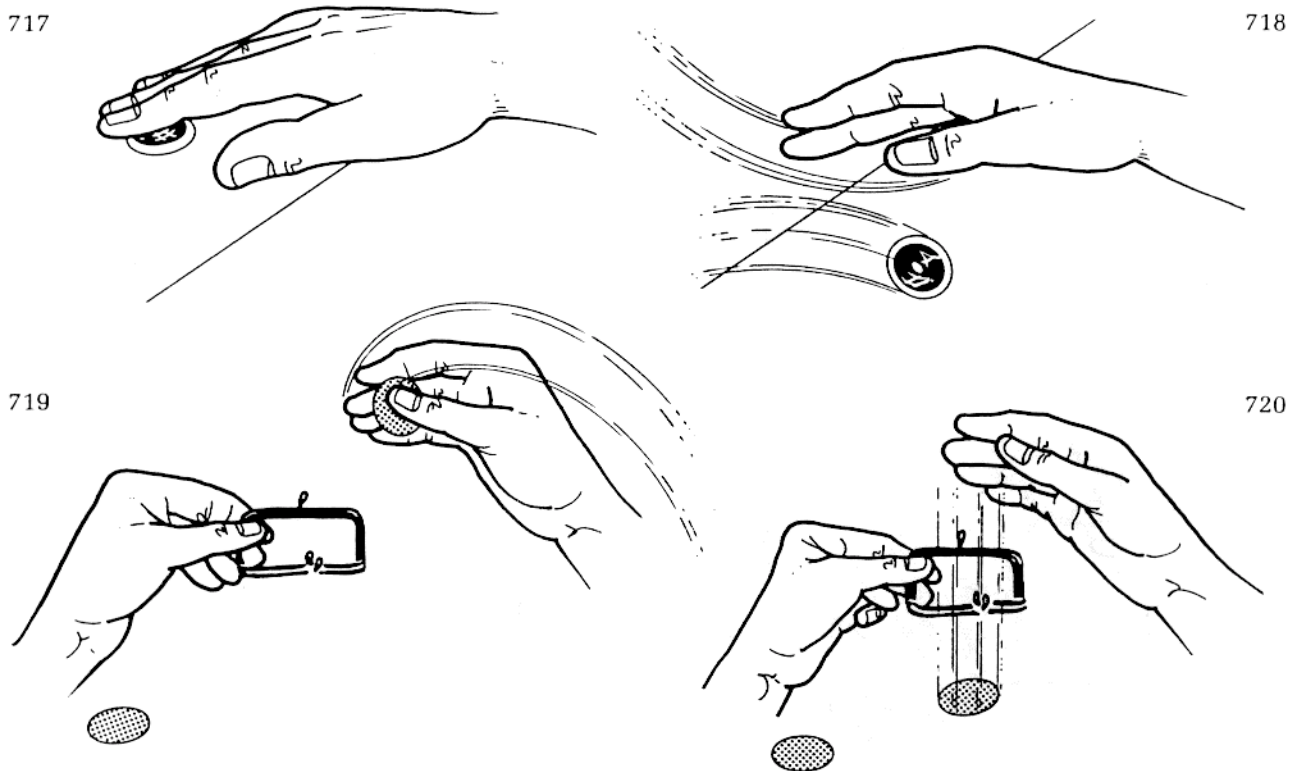

Close the open compartment and open the other one. Your right hand picks up the shelled Chinese coin it rests on your first and second fingers (fig. 721). Your thumb moves onto the inner end and levers it upward so that it faces directly toward the audience, your hand partially palm up (fig. 722).



Move your right hand in front of the purse so that your right pinky hugs the frame (fig. 723). Say, "And, likewise, if I drop the half dollar into the Chinese compartment it turns into a Chinese coin." As you talk turn

your right hand inward, palm toward you - gravity will pull the Chinese coin out of the shell and it'll fall through tile purse onto the table (fig. 724). It's a simple wrist turn.

Now, two things happen simultaneously - and both as soon as the Chinese coin hits the table. Your left hand tosses the purse outward onto the table and your right hand swings inward, tossing the shell into your lap (fig. 725). It immediately reverses direction, moving outward in a palm-up gesture (fig. 726). You're clean and everything is examinable.

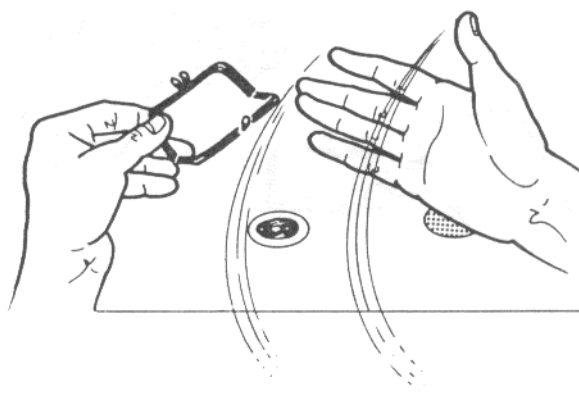
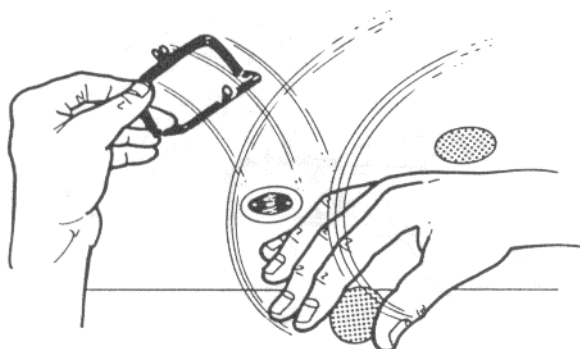
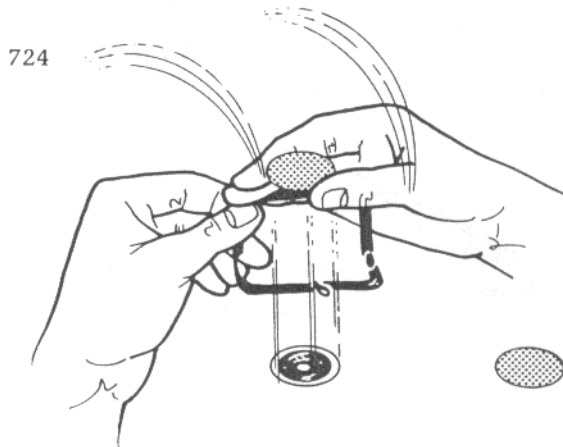
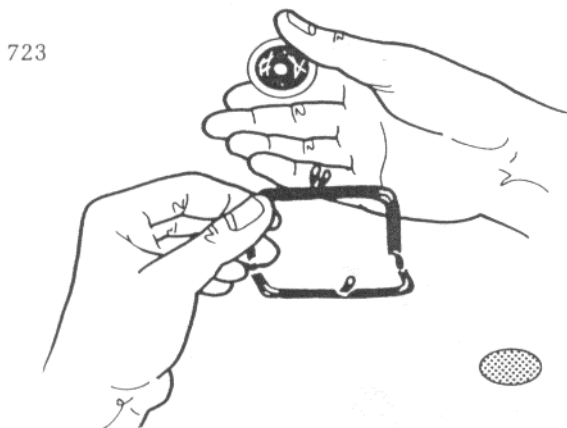

Visual Drop Switch

Richard Kaufman

This originally appeared in *Apocalypse*, Vol. 1 No. 1, and is (I think) the only item in this book which is being described exactly as it's already been.

You can use this two ways - as a visible change, or as a secret switch. Since it's used in *Framed Again* as a visible change, that's the way I'll teach it. A copper coin is openly held at your left fingertips. A silver coin is in High Finger Palm in your right hand. (High Finger Palm is, briefly, when the coin is positioned between the center and outermost joints of your second and third fingers (fig. 727). As in regular finger palm, the coin is kept in position by a natural curl of your fingers.)

Begin to move your hands together, your right hand turning palm toward you, fingers pointing to the left. Your left hand guides the copper's lower edge behind your first finger, between your first and second fingers (fig. 728).



727

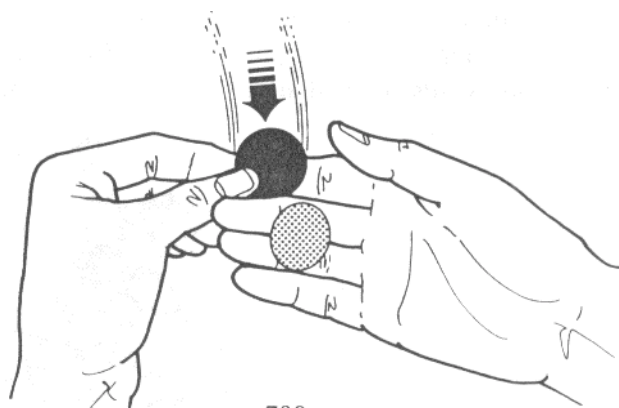

728

Your right thumb moves onto the upper portion of the silver coin and pushes it upward a bit (fig. 729). You'll find that if you press your right thumb forward its tip will press against the copper coin, while its pad still holds the silver coin (fig. 730). Also press your right first finger flatly against the lower portion of the copper's face and move your left hand beneath your right (fig. 731 is an audience view; fig. 732 is your view).

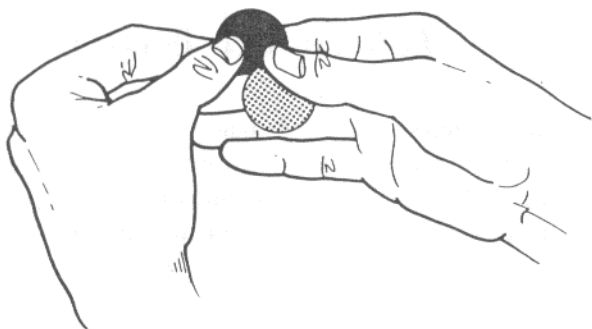

729

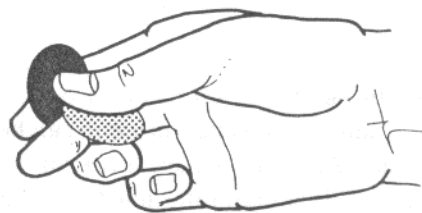

730

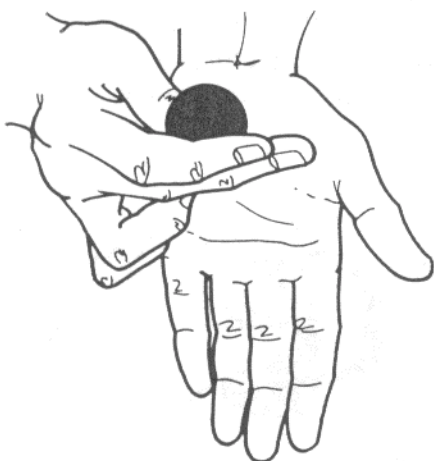

731

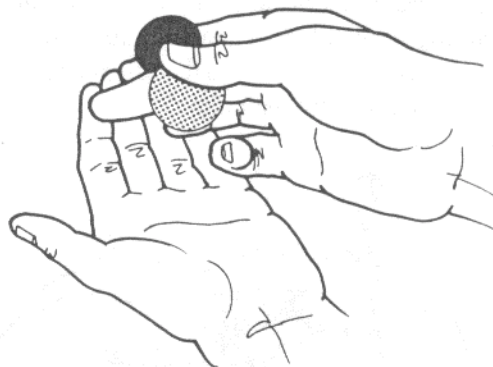

732

Your thumb controls both coins, and the timing for the change is automatic. Simply lift your thumb while keeping your first and second fingers relaxed: the silver coin will drop onto your left hand and the copper coin will tilt back to clipped position (fig. 733).

In Addition: The change is instant and appears to occur in full view. The concept is unusual, but you should have no trouble with the mechanics once you've tried it a few times.

if you wish to switch in a copper/silver coin after displaying a real silver, try this. The gaffed coin is in High Finger Palm copper side toward you. Do the change exactly as described. When the switch occurs (as you say something like, "Heads, tails.") the gaffed coin will drop and automatically flip over so that it lands silver side up, while the real silver coin tilts backward to clip position.

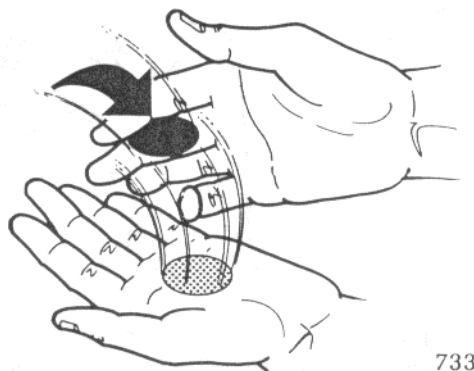

Framed Again

Richard Kaufman

I wanted to be able to do Scott's wonderful routine without having to lap or use a shell. This handling appears the same to the audience and can be done anytime. It also teaches a new way to get into Edge Grip with one hand. All you need are three coins - two coppers and a silver. These are finger palmed in your left hand with the silver coin innermost (i.e., farthest away from your fingers). Have the double compartment purse frame in your right hand.

Shake the purse frame and ask the spectators if they hear anything. Put the frame in your left hand in production position, wedged between your thumb base and first and second fingertips. I'm not going to repeat all of Scott's patter so you'll have to flip back once you've learned the moves. Open one compartment of the purse, reach inside, and remove the silver coin with your right hand. Place it on the table to the right. Do the Johnny Paul subtlety already taught in Scott's routine, inserting your right fingers into the purse and turning your hands palm toward audience to show them apparently empty. You're actually concealing the coppers in left-hand finger palm.

734

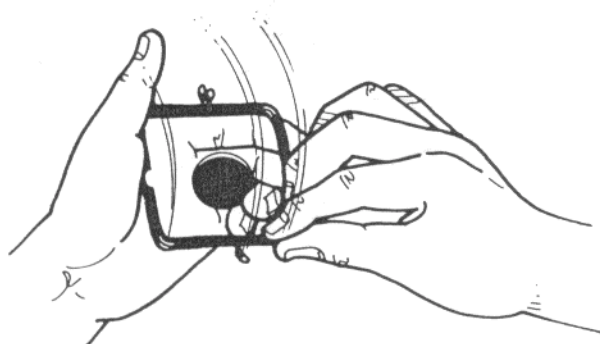

735

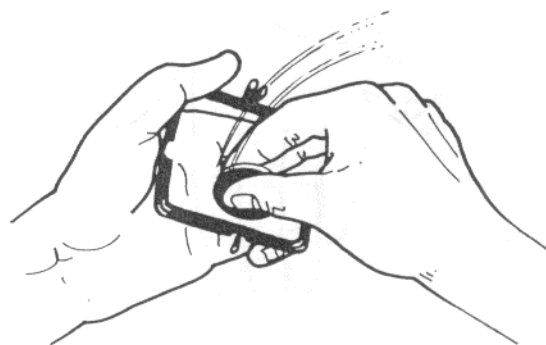

After you've lowered your hands and turned them palm toward you again, snap the purse shut and open the other compartment as far as you can (fig. 734). Reach inside, grasping the coppers between your right

thumb, first, and second fingers (fig. 735). Your thumb pulls the inner coin upward until it's behind your fingers as you openly remove the copper which remains at your fingertips from the purse (fig. 736). Place the visible copper onto the table to the left of the silver coin. Curl your right fingers as you retract your hand afterward, the hidden copper in fingertip rest.

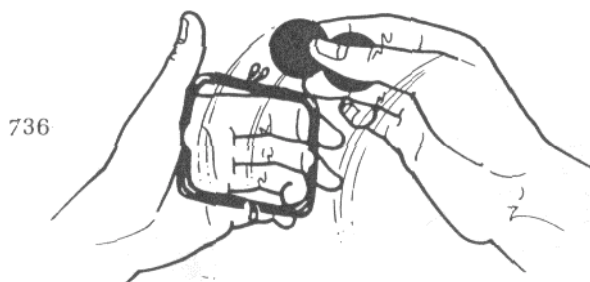

Getting Into Edge Grip: Method Three

The copper coin is already in fingertip rest (fig. 737). Raise your hand slightly. Two things happen at the same time: your hand rotates at the wrist so that your palm faces left (and your fingers point in the same direction), and your third and pinky fingers curl (figs. 738 and 739 show two progressive views). You have to time it so that the copper coin balances on your third finger as it curls, remaining in a horizontal position. Move your thumb onto the copper's inner edge and the coin will be in Edge Grip (fig. 740).

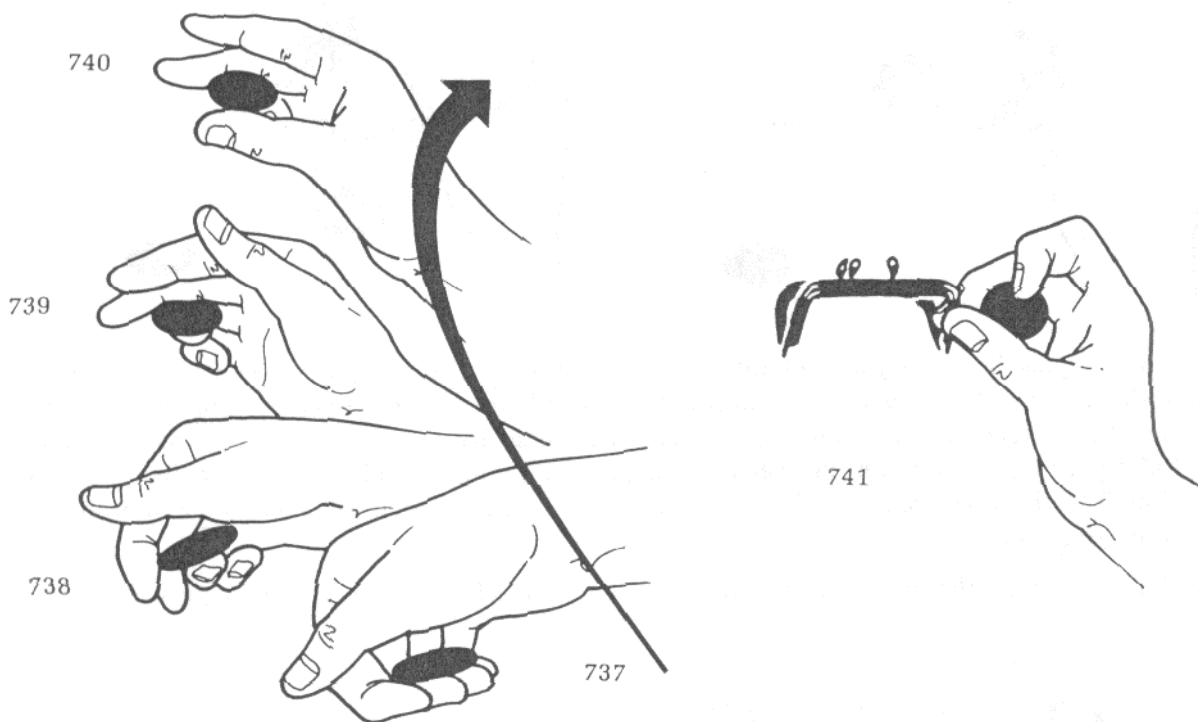

Your left hand places the purse frame between your right thumb and second finger in Edge Grip Display (fig. 741). Place the purse frame back between your left thumb, first, and second fingers (which is the same way your right hand just held it). That frees your right hand. Lower it to the table turning it palm down and letting the copper coin drop to fingertip rest.

Lower your right hand over the silver coin. Your thumb moves onto its inner edge and presses downward enabling your fingertips to move beneath it. (This is Geoffrey Latta's One-Hand Turnover Switch.) Your thumb drags the silver coin up along the side of your first finger while you raise your hand, turning it palm

down over the purse frame. You don't have much time here - the copper coin will drop through the frame as soon as your fingers have straightened sufficiently (fig. 742). Your thumb holds the silver coin in place against the side of your first finger. Once the copper coin hits the table your right fingers curl, your thumb pushing the silver coin to fingertip rest. Immediately get the silver coin into Edge Grip as just described and place the purse frame between your right thumb and second finger in Edge Grip Display. Your left hand turns over both copper coins on the table.

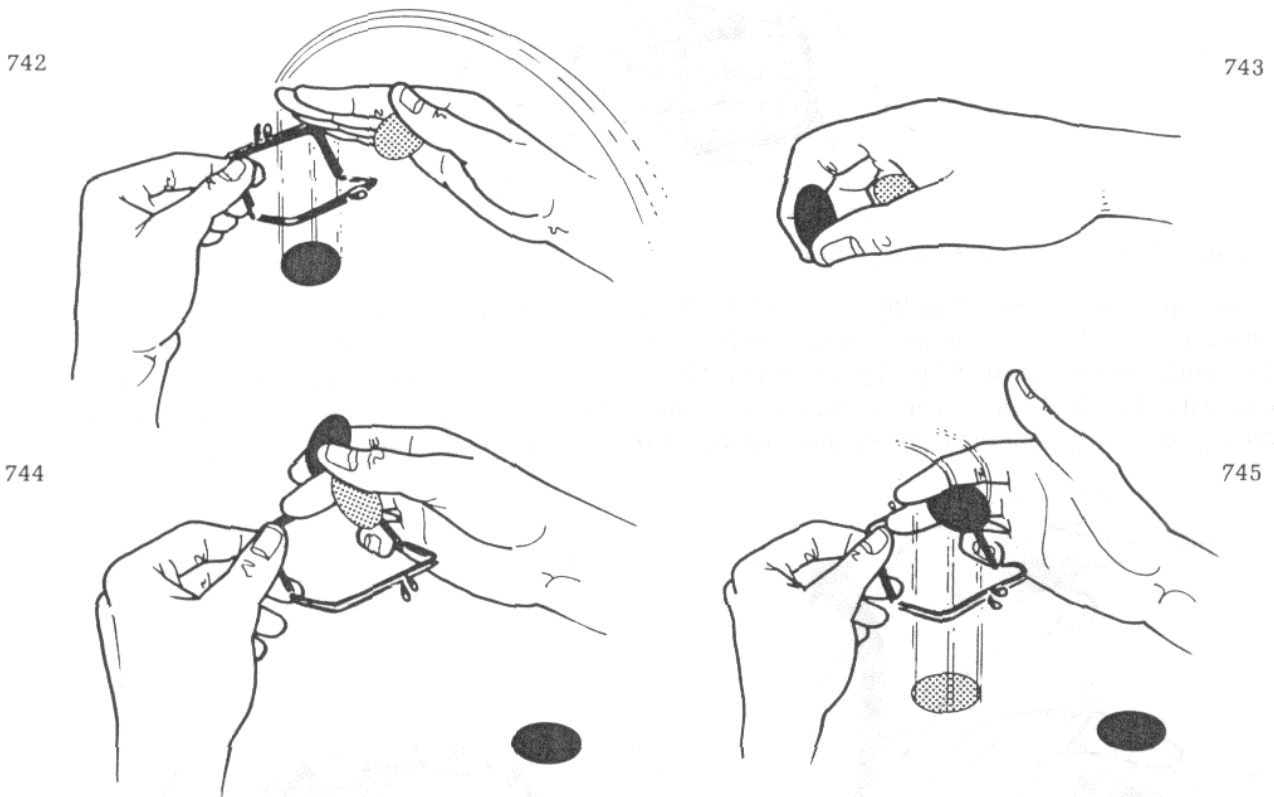

Place the purse back between your left thumb, first, and second fingertips. Lower your right hand allowing the silver coin to fall back to fingertip rest. Your right hand descends over the copper coin on the left. Slide your first finger beneath it and nip the coin's right edge between your first and second fingers (fig. 743). Raise your right hand over the open frame in position for my Visual Drop Change (fig. 744). Lift your right thumb - the silver coin will drop through the purse frame and the copper coin will drop to a clipped position (fig. 745).

That's it. You're left with the extra copper in your right hand, which can be sleeved or simply ditched in a pocket.

Iron Curtain Coins

Scott Weiser

This tabled Coins Across routine uses an absolutely astounding concept which, as far as I know, is completely original with Scott. All you need are four coins and a close-up mat. You can be either standing or sitting since there's no lapping.

Display the four coins on your palm-up right hand. Get one of them into classic pal in position using Roth's technique for Classic Palming One Coin of a Group. Display them again, turning your hand palm down afterward and letting the three loose coins gather in a stack inside your fingers. Toss them into your left hand, which closes immediately afterward. It appears as if you've simply placed the four coins in your left hand.

Turn both hands to palm-down fist position and give them a slight shake. Turn both fists palm up. Open your right hand and allow its coin to slide to the left, off your hand and onto the table. Open your left hand and allow its three coins to slide to the right, onto the table (fig. 746). Each time a coin travels from your left hand to your right the appearance will be shown exactly the same way.

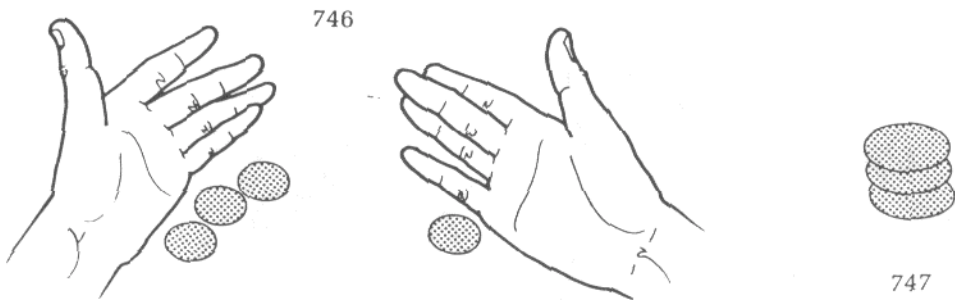

Arrange the left-hand coins in a row, overlapping and spread outward (fig. 747). Turn your left hand palm down, fingers outstretched and straight, and lower it over the three coins. Your fingertips rest on the outer edge of the outer coin (fig. 748). Your thumb levers the two coins to a vertical position pressing them against the insides of your left fingers (fig. 749). Continue curling your fingers, your hand forming a fist which rests on the table - the coin you haven't picked up lies on the table just behind your thumb base (fig. 750). It appears as if you've picked up all three coins.

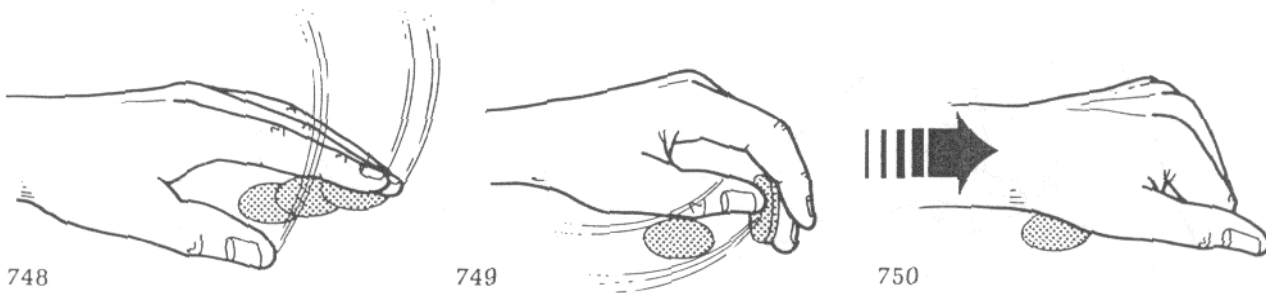

The Iran Curtain Move

Your right hand picks up the single coin on the right and holds it between thumb, first, and second fingertips (fig. 751). Note that your fingertips are pulled back so that as much of the face of the coin is exposed as possible. Hold the face of the coin directly toward the audience and raise your right hand, turning it palm up (fig. 752). Your right hand is in line with your left hand, and about a foot to its right.

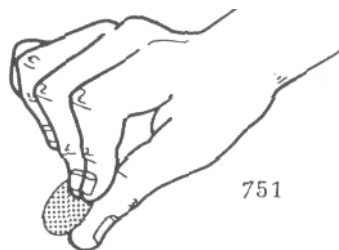

Say, "The first coin has already traveled..." As you say the next portion of the sentence, "... from here. . .," your right hand moves downward and to the left in a quarter counter-clockwise circle (fin. 753).

The lower side of your thumb lands on the single coin lying on the table (fig. 754). At precisely that moment your left hand moves upward, turning palm up, to the left (fig. 755). As you complete the sentence, ". . . all the way over to here," slide your right hand to the right in a slight outward arc (fig. 756). The tabled coin is slid beneath your thumb and concealed from the audience by your fingertips and the visible coin (fig. 757 is the audience view).

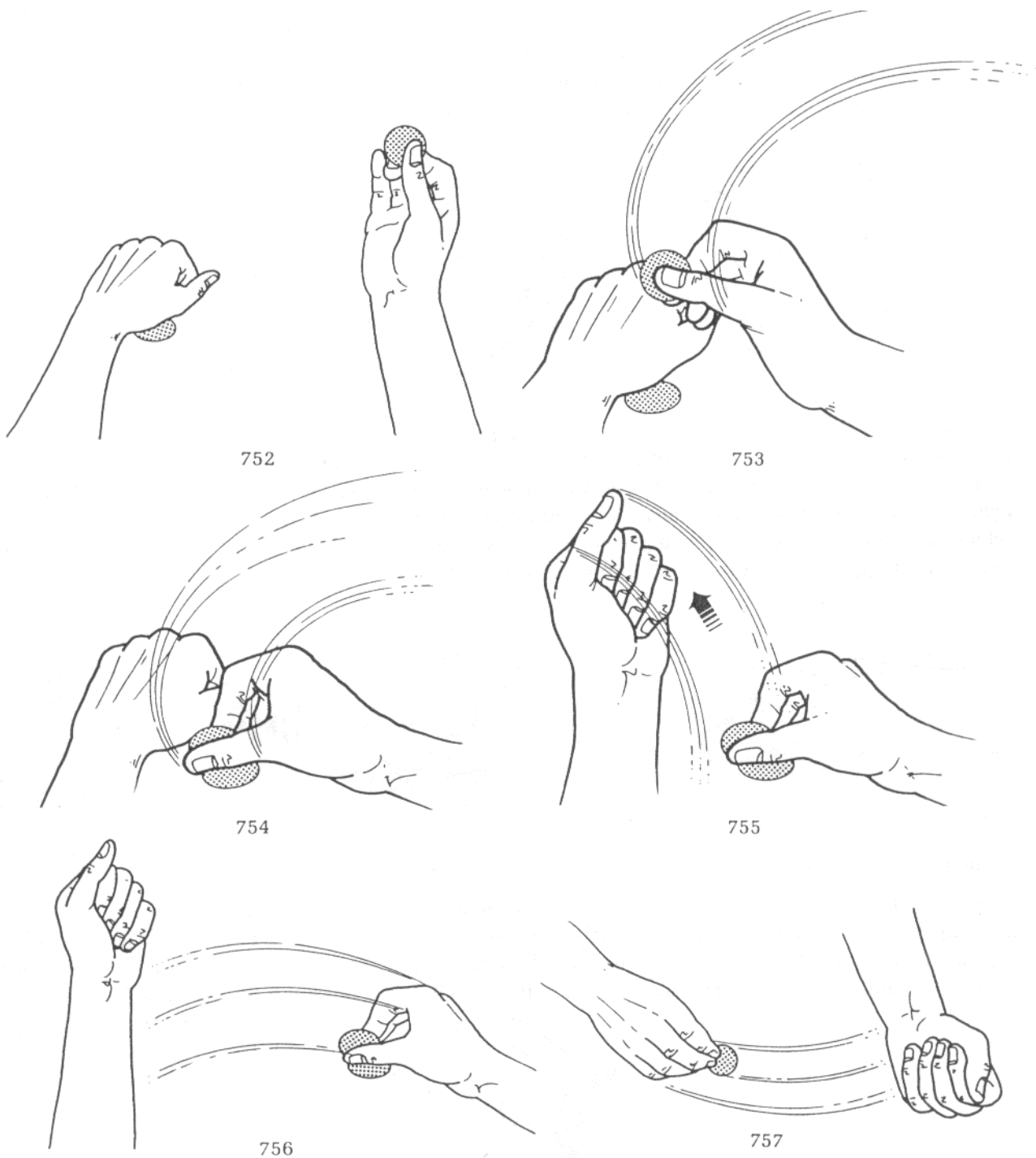

Here's the unbroken patter: "The first coin has already traveled from here all the way over to here." The entire move is done in that time. The technique is simple, so relax when you do it. Make sure to keep both your fingertips and the visible coin pressed lightly against the table so the audience cannot see beneath them.

After you've done the next move extend your right fingers over the visible coin (as you would when doing certain types of retention vanishes) and curl them, the coin in fingertip rest. As you close your fingers dig them under the coin that's on the table, clipping its outer edge (fig. 758). (Your thumb base (:an hold the inner edge of the coin in place to make that easier.) The coin is hanging out the underside of your fist. Lift both fists and, holding them palm down over the table, give them a slight shake. As your right hand shakes it jerks upward and "hops" the coin that's dangling inside. Turn both hands palm up. Open your right hand and allow its two coins to slide onto the table; open your left hand and allow its two coins to slide onto the table.

Your left hand turns over and picks up both of its coins. As it forms a fist it pushes one of them out the back letting it fall onto the table. (More specific detail on doing that appears in Roth's Deep Back Clip Steal.) The coin that's been pushed out lies on the table in position for The Iron Curtain Move.

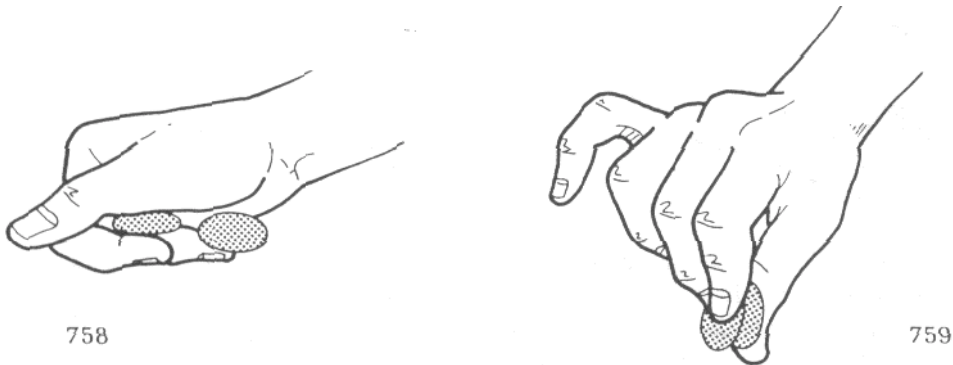

Your right hand turns over and picks up its two coins between thumb, first, and second fingers (fig. 759). Note that your thumb extends all the way down behind the coins. Turn your right hand palm up and say, "The second coin has also traveled...." As you say, ".... from here...." do the downward circular movement with your right hand so that your thumbtip lands on the tabled coin behind your left fist (fig. 760). Immediately raise your left fist, turning it palm up and moving it slightly to the left. As you finish the sentence, ". . . all the way over to here," your right hand moves to the right sliding the coin beneath your thumbtip, completely covered by the two coins in front of it (fig. 761 is the audience view).

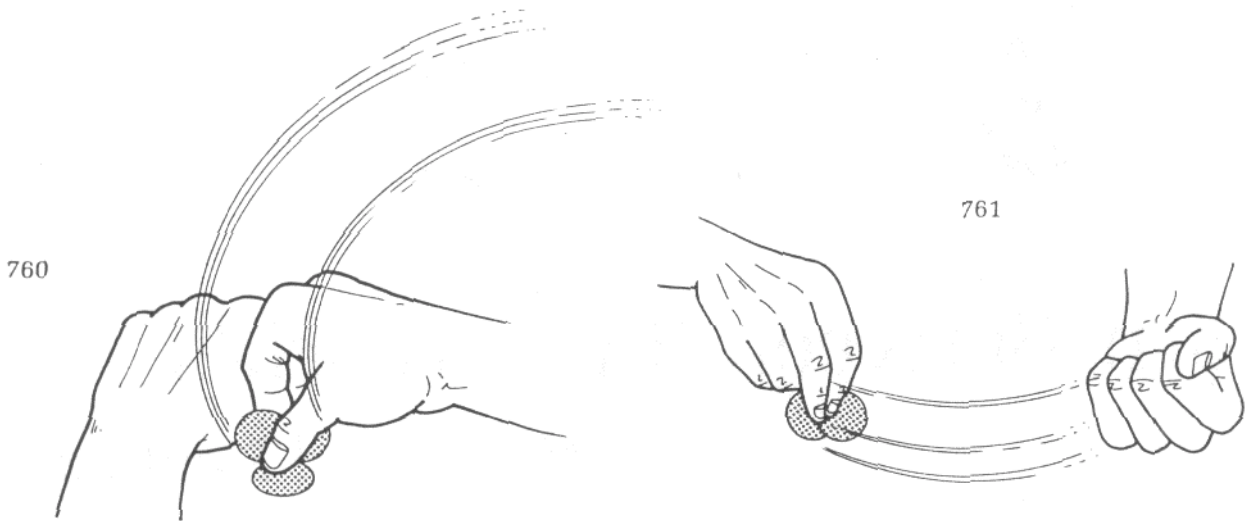

Once your right hand has moved back, lower your right fingertips onto the outer edges of the two visible coins and press downward, lifting your thumb (fig. 762). The coins will tilt backward slightly. Move your thumb beneath the tabled coin and lever all three coins upward against your fingers (fig. 763). All this, of course, is covered from the audience by the backs of your fingers. Close your right hand into a fist.

Hold both palm-down fists over the table and shake them. Turn them palm up. Open your right hand letting its three coins slide onto the table; open your left hand letting its coin slide onto the table.

Move your palm-down left hand over its coin and pretend to pick it up, actually leaving it on the table as your hand settles into a palm-down fist in front of it. I can't really explain how to do that so you'll have to experiment a bit. It's similar to the fake pick up you already did when there were three coins on the table and you picked up two.

Your right hand picks up its three coins in position at the fingertips for The Iron Curtain Move. Do the move, sliding the last coin to the right beneath your thumbtip.

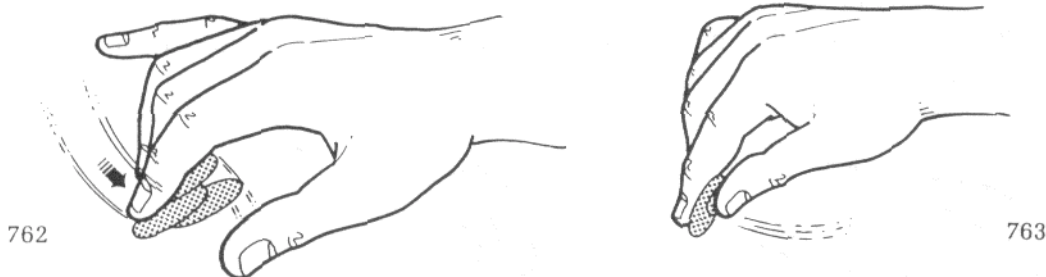

Pause here; you should be in the position shown in figure 764. Your thumb should be pressing lightly against the back of the innermost coin. Lift your hand and straighten your fingers: your thumb pulls the coin that's against it upward (hidden behind your fingers) and the other two coins fall onto the one on the table (fig. 765). The substitution is invisible and it appears as if you've simply lifted your hand.

The stolen coin will be in fingertip rest when your fingers curl. Transfer it to classic palm as you reach forward to pick up the three coins on the table. Once you've picked them up turn both fists palm down. Shake them, turn them palm up. Open your right hand, then your left, to reveal the passage of the last coin.

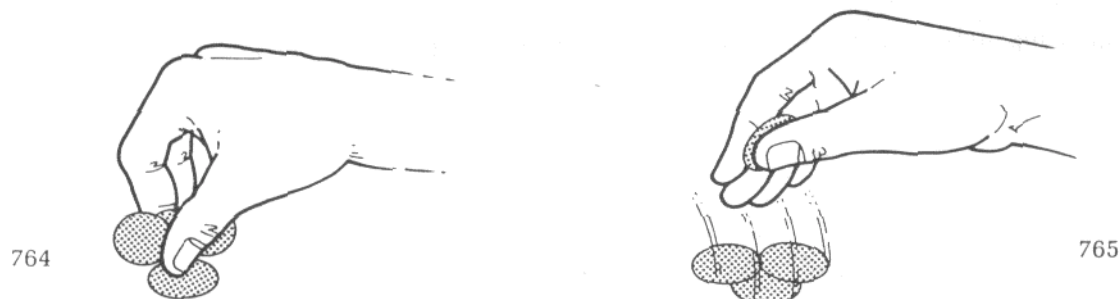

Torn Between Two Worlds

Weiser and Kaufman

Here's what the audience sees. You display a half dollar on both sides, then literally break it in half. One piece is placed into the spectator's hand. You display the other piece on your palm-up left hand (which is seen to be otherwise empty). Your left hand closes and opens and the piece changes to copper. When the spectator opens his hand it's seen that his piece has also changed to copper. You take the piece from him and fit it together with your, then restore the two copper pieces into a whole coin which can be examined.

If it sounds good, and you're going to do it, you'll have to have the following coins cut: half a silver coin, half a copper coin, and half a copper/silver coin (fig. 766). All the pieces must fit together and match, i.e., so that each, when fitted with either of the other two, looks like a whole and proper coin. A jeweler will be able to cut the coins for you.

You also need a tube of "Krazy" type instant bonding glue and a regular copper coin. Using the glue (and being extremely careful, too) attach the copper/silver half coin to the silver half coin with one drop. Afterward one side of the coin will look perfectly normal and the crack will be invisible. The other side will be half copper and half silver.

You must be seated at a table opposite the audience. Classic palm the regular copper coin in your right hand, and then palm the half copper piece crossways beneath it (fig. 767). The glued coin rests on your partially palm-up right fingertips (fig. 768).

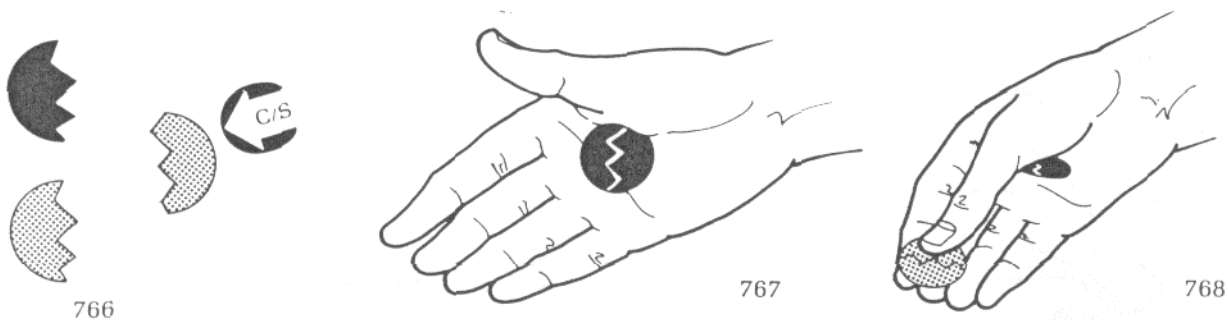

To perform bring the apparently whole silver coin out, held as just described. Your right thumb pushes it to the left into your waiting left fingers (fig. 769). Your left hand turns over to display the coin's other side, covering the portion that's copper (fig. 770). Don't pause, your left hand turns palm up again rather quickly. Grasp half of the coin in each hand between thumb and fingers and break it (fig. 771). There should be a nice crack when the glue comes apart. The pieces are positioned so that your right hand holds the real silver piece, while your left hand holds the copper/silver piece.

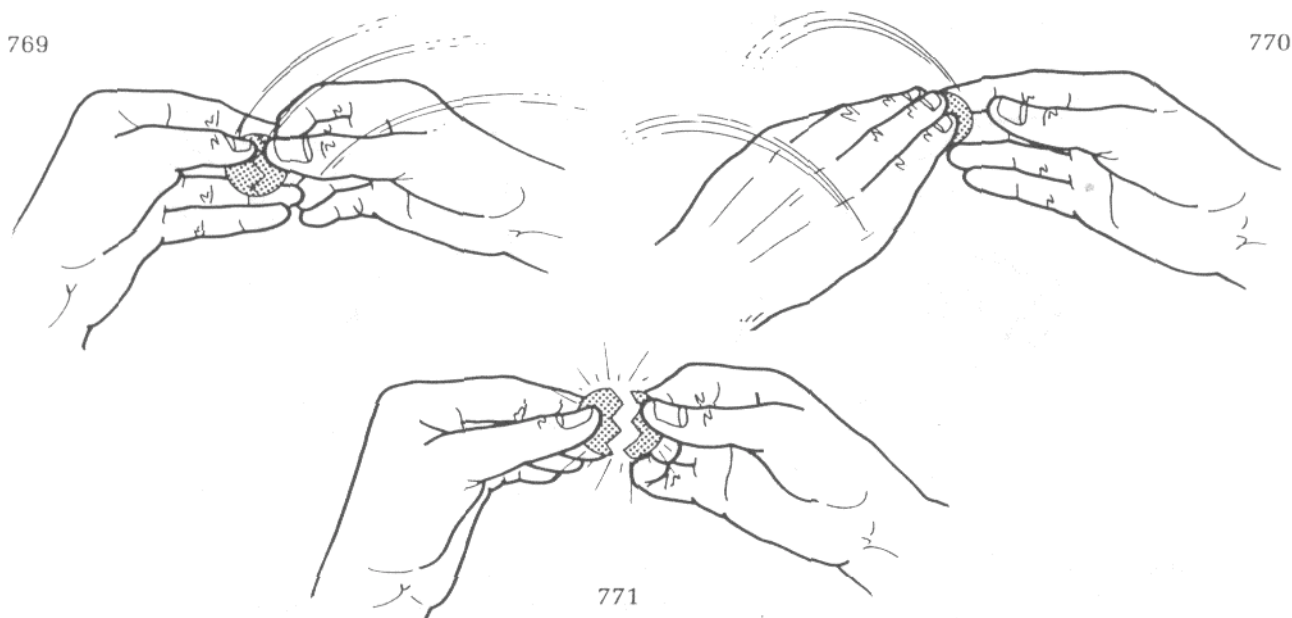

Drop the real silver piece on the table and reposition the copper/silver piece in finger palm on your palmup left hand (fig. 772). Display that piece and patter for a moment while your right hand settles to the table in a relaxed fist and allows the copper piece to drop to fingertip rest (the whole copper remains classic palmed). Ask the spectator to extend one of his hands, palm up, over the table. Immediately raise your

right hand, partially straightening your fingers and holding the piece in place inside them with your thumb (fig. 773). Lower your fingers over the silver piece that's on the table - the back of your thumb resting on it (fig. 774). Slide your hand toward you, dragging the piece off the table so it falls into your lap (fig. 775).

772

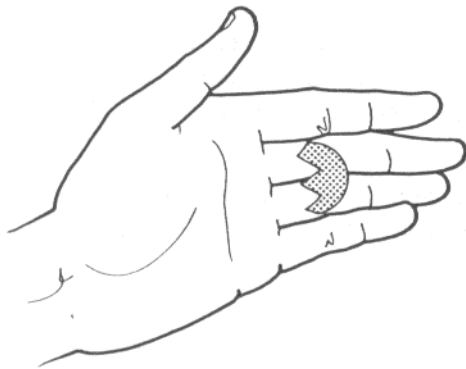

773

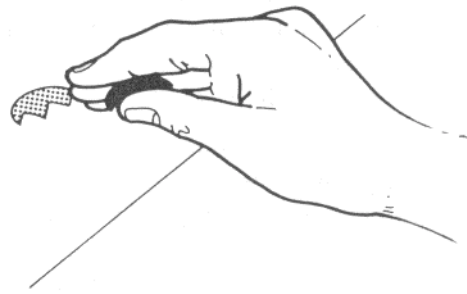

774

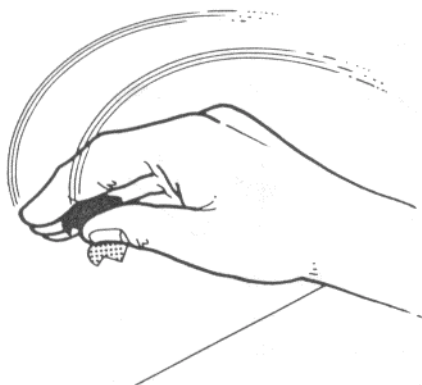

775

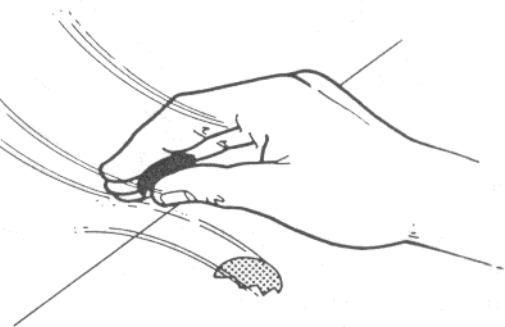

Without pausing raise your right hand and move it over the spectator's, pressing the copper piece onto his fingers (fig. 776). Note that your thumb moves beneath his fingers. Gently close his fingers over the copper piece (without letting him see it) and turn his fist over.

776

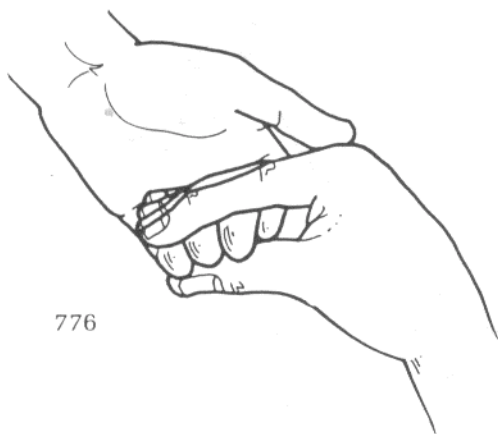

777

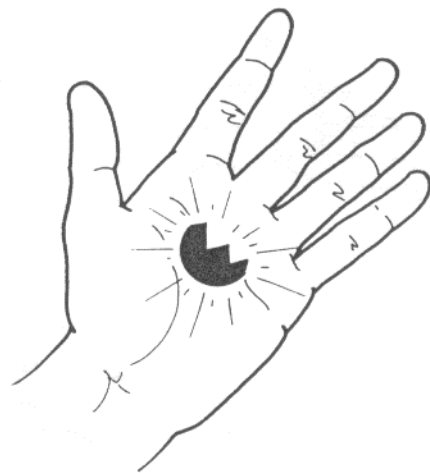

Draw attention back to the silver piece that's on your left hand. Close your fingers, say your magic word, and open them. The piece will automatically turn over because of the placement, and it'll change to copper (fig. 777). Ask the spectator to open his hand, revealing that his piece has also changed to copper. Take the piece from him with your right hand and fit it into the piece lying on your left palm. Pick both up and hold them in Spellbound position in your left hand (fig. 778). The crack should run vertically, allowing you to hold both pieces without any trouble.

Allow the whole copper that's classic palmed in your right hand to drop to fingertip rest. Move your right hand in front of the coin at your left fingertips, your thumb moving behind the pieces and your fingers hanging loosely beneath your left fingers (fig. 779). Your right thumb takes the pieces into thumb palm and immediately moves back to the right, your right fingers pressing the copper coin against your left fingers so it doesn't fall (fig. 780). The whole copper is really dragged around your left first finger and up into Spellbound position (fig. 781).

778



779



Move your right hand away revealing the restored coin, which you toss onto the table toward the spectators. Your right hand goes into your right jacket pocket for another prop, or a silver coin, or whatever, and leaves the pieces behind.

780



781



Stick It!

John Bentz

A description of this effect could read like an ad. An English penny is wrapped in a small piece of napkin and its shadow remains visible through the paper during the rest of the trick. You cleanly push three straight pins through the center of the coin. They can be left sticking half through and both sides of the napkin can be shown. You pull out two of the pins and let the spectator pull out the third. Everything can be immediately handed out for examination. It really looks even better than that!

There is some one-time advance preparation - you need an English penny (called the copper hereafter) with a hole through its center about the size of a regular penny. Take two short pieces of black electrician's tape and cover both sides of the hole (fig. 782). You also need three straight pins and a small piece of napkin (one quarter of a paper napkin - about six inches square) that's been prefolded into sixteenths, which is four folds (fig. 783).

Classic palm the prepared coin in your right hand and drop the other items on the table (on your close-up mat) and you're ready. To perform, introduce the pins and stick them, upright, into the mat's outer right corner (fig. 784). Show the piece of napkin and a regular copper coin and let the spectators examine everything.

Fold the napkin into quarters (i.e., fold it in half and then half again) so it forms a little three by three inch pocket and lay it on the table directly in front of you, open end toward you. Lift the upper layer (only) of the napkin with your left thumb and fingers. At the same time your right fingers curl into a loose fist, your palm relaxes, and the prepared coin falls to fingertip rest. As you raise your hand and your fingers straighten your thumb moves onto the coin to hold it in place. (This is the same one-hand switch already described in Torn Between Two Worlds.)

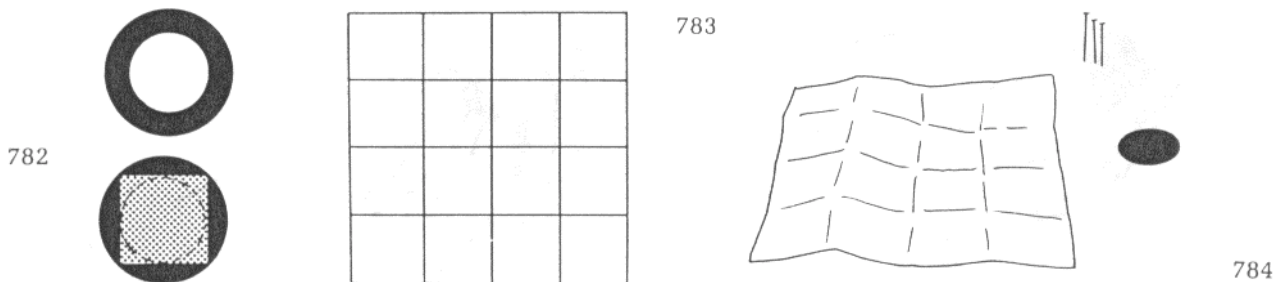

Lower Your fingers over the real copper and slide it toward you on the table. It'll eventually fly off the table and into your Lip. Without Pausing your right hand moves slightly upward and your right thumb pushes the switched-in copper forward so its forward edge protrudes past your fingertips (fig. 785). Insert the coin into the napkin beneath the single layer lifted by your left hand. Push it all the way to the far corner and then fold the napkin twice more so it's about an inch and a half square. When you make those two final folds, always fold under so the shadow of the coin remains in view beneath a single layer (fig. 786).

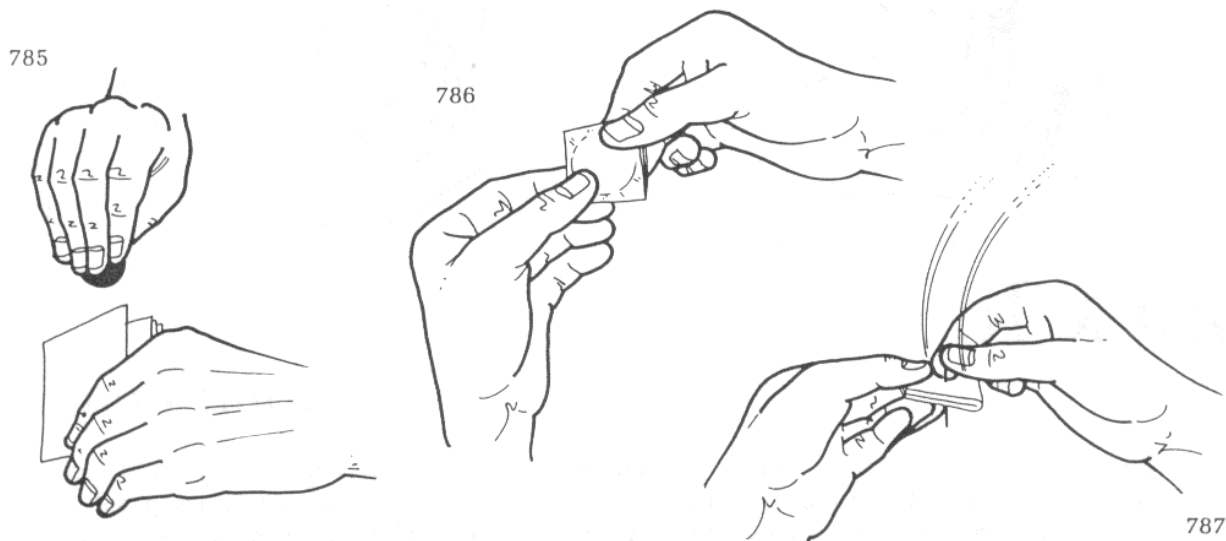

Hold the coin by its edge through the napkin with your left hand and allow the spectators to briefly touch it just to see that you haven't switched it for a cardboard disk (or whatever). Pick up one of the pins with your right hand and stick it through the center of the coin (fig. 787). Turn your left hand over very slowly to display both sides. Insert the second pin through the coin at a small distance from the first pin. You can let the spectators peek beneath the napkin as you push the pin through. Insert the third pin in still another place (fig. 788).

Pause for a second to allow the effect to sink in. Then pull out the first two pins one at a time and stick them back in the mat. Lean forward and extend your left hand to the spectator inviting him to pull out the third pin. As he does your right hand drops into your lap and finger palms the regular copper. As you lean back afterward raise your right hand onto the table. Let the spectator stick the pin into the mat beside the others.

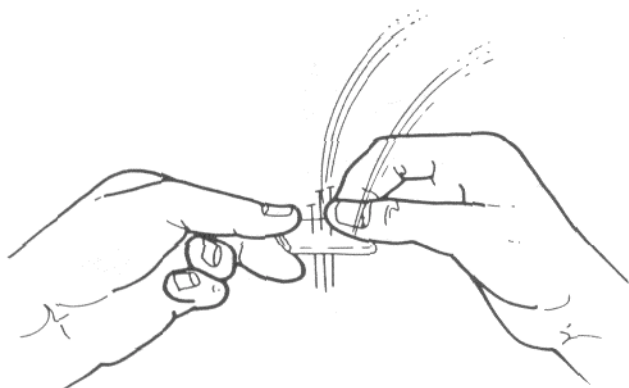

788

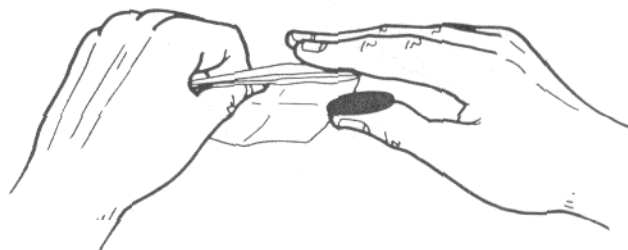

789

Unfold the napkin until it's back to quarters (a three inch square, and still folded twice) and lay it on the table directly in front of you, exactly as it was when you initially inserted the coin. Your left thumb lifts three layers at the inner open end (leaving only one layer on the table). Turn your right hand palm down and move your thumb beneath the finger palmed copper coin. Straighten your fingers a bit so that the coin is balanced on your thumb (fig. 789).

Move your right hand over the tabled napkin, your thumb moving into it (fig. 790). Your thumb moves the coin into the napkin until it's almost directly beneath the gaffed coin, but stepped inward a bit (fig. 791).



790

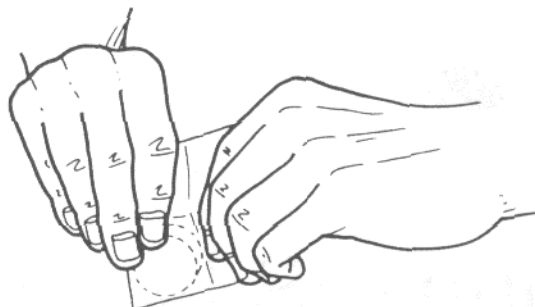

791

Your left hand moves around to the extreme corner of the napkin where the coins rest and grasps it, thumb above and first and second fingers below - also grasping the coins (fig. 792). Turn your left hand palm down swinging the napkin downward and away from you (fig. 793). Raise the tip of your left first finger and allow the real copper to drop out onto the table. That should be no problem because it's lower than the gaffed coin - you should have no trouble retaining the upper coin and releasing the lower.

Immediately sweep your left hand toward you until the napkin's lower end passes behind the table edge. At that moment relax your thumb and fingers, releasing the gaffed coin so it can fall into your lap (fig. 794). Without pausing your left hand turns palm up and tosses the napkin forward on the table for examination (fig. 795).

792



793

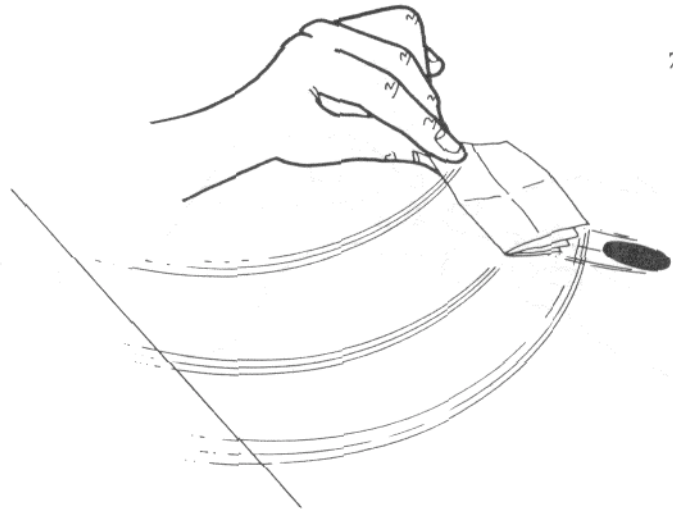

794

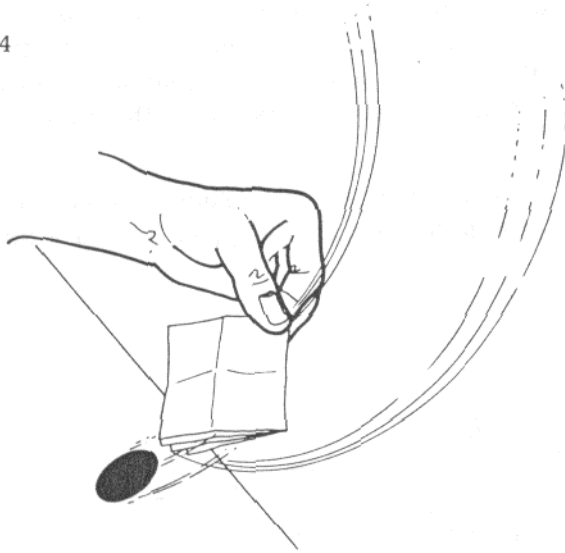

795

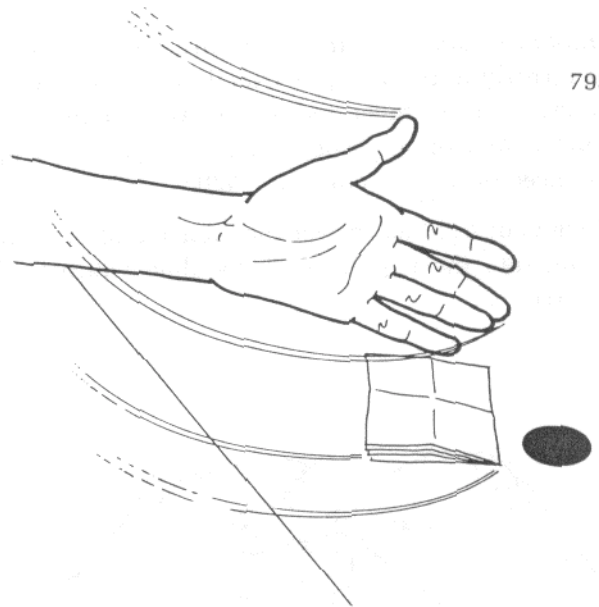

Copper/Silver No. 1

Roth, Latta, Arthur, et al.

When using the Shuttle Pass, this seems to be the first sequence that comes to mind. It's credited to a number of people because all have come up with it independently and it's never, to my knowledge, been in print. Four more copper/silver sequences are described after this, and all follow the standard plot where the two coins change places.

To start, have an extra copper coin classic palmed in your right hand. Two coins, one copper, the other silver, lie on the table. The copper is on the left and silver on the right. Pick up the copper coin with your left hand and let it lie on your palmup hand in finger palm. Do the Shuttle Pass apparently taking the coin with your right hand to show its other side. Place it back on the table in its original position.

Your right hand lifts the silver coin, flashes both sides, and moves it over your left palm in Retention Pass position (fig. 796). Note that your left fingers are slightly curled, concealing the copper coin in finger palm from the audience. You're subliminally showing the hand empty. Do the Retention Pass, your right hand stealing the silver back into fingertip rest as your left fingers close. As your right hand descends to a relaxed fist position on the table it classic palms the coin.

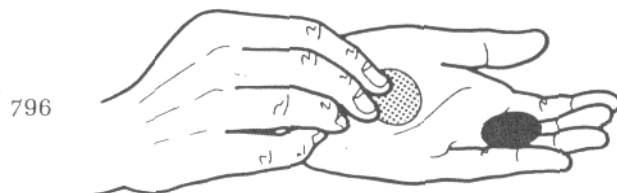

Your right hand picks up the copper coin from the table, displays it for a second, and does a Palm Change. The copper coin will appear to change to silver. Open your left hand revealing the copper coin.

Copper/Silver No. 2

David Arthur

The preceding sequence leaves you with the extra copper coin in right-hand classic palm, the position from which you begin this sequence.



Your right hand picks the silver coin up from the table and does a Palm Change keeping the hand closed afterward in a palmdown fist. Your left hand picks up the copper coin as you say, "Remember that the copper's over here." Close your left hand into a palm-down fist also.

Say your magic words and turn your right hand partially palm up, opening the fingers and displaying the copper coin (fig. 797). After a second close your hand and do the Palm Change again.

As soon as you've closed your right hand your left hand places its copper coin on the table. Say, "Naturally that leaves the silver coin in my right hand." Open your right hand over the table, dropping the silver coin (the extra copper in classic palm).

In Addition: There's a particular rhythm to this that makes it effective. It has to do with the rapid back and forth jump of the copper coin from left hand to right hand and back again. The spectators should have the feeling that the coins jump as quickly as they can look from one hand to the other.

Copper/Silver No. 3

David Arthur

This is David's version of a J.C. Wagner idea that appeared in his excellent book *Seven Secrets*. Again, the previous sequence leaves you in position to begin this one, with the extra copper in right-hand classic palm.

Your left hand picks up the copper coin that's on the table and maneuvers it into Shuttle Pass position. Do the Shuttle Pass, your right hand apparently taking the copper and placing back in your left hand, held between thumb, first, and second fingers (fig. 798).

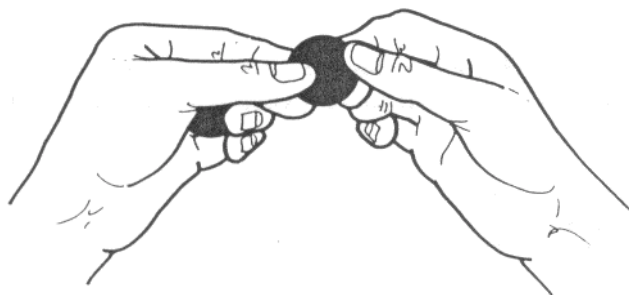

798

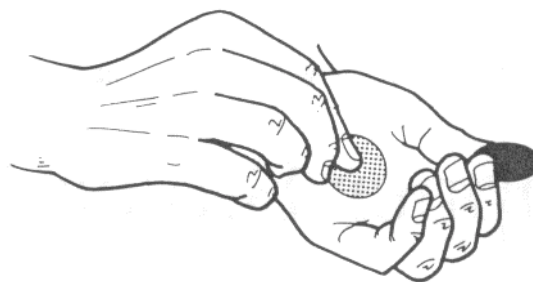

799

Your right hand picks up the silver coin and holds it over your left palm in Retention Pass position (fig. 799). Do the vanish and, without pausing, let the copper coin held by your left fingers fall inside the hand - it'll clink against the copper already there (fig. 800). It looks and sounds exactly as if both coins have been dropped into your left hand.

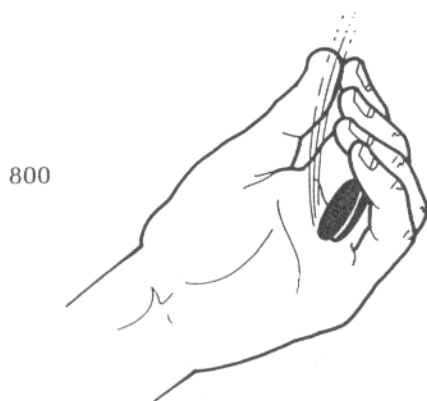

800



801

During that action say, "Please hold out your left hand, palm up." Put both coppers into their hand, your thumb moving beneath their fingers (fig. 801). Gently close their fingers and turn the hand over. Ask him to reach into the thumb hole and pull out one of the coins (it does not matter which). Take the copper coin from them and do any Spellbound type of change, leaving you with a silver coin. When they open their hand they'll find the copper coin.

Copper/Silver No. 4

Geoffrey Latta

This sequence uses Geoff's handling of Han Ping Chien. The extra copper coin should be finger palmed in your right hand. Pick up the visible copper coin and place it into finger palm on your palm-up left hand. Place the silver onto it, overlapping and spread inward (fig. 802). Do the Utility Switch, turning your left hand palm down and your right hand palm up beneath it. The silver coin moves from hand to hand while the copper is retained in left-hand finger palm. The silver falls onto your right hand and coalesces with the copper already there.

Curl your right fingers slightly, flipping the two coins over so the copper coin is now on top. Turn your hand over at the same time straightening your fingers - the two coins fall and are caught horizontally between your thumb and fingers, copper on bottom (fig. 803). Toss both coins into your left hand, onto the finger palmed copper. Close your left fingers into a fist and turn the hand over. As you do squeeze your fingers tightly, forcing the three coins (stacked) out of finger palm and against the bases of your second and third fingers, the silver coin resting on your fingertips. Tilt your hand a bit to the left, letting the stack roll into Isolation Placement position, your pinkytip resting on the silver coin.

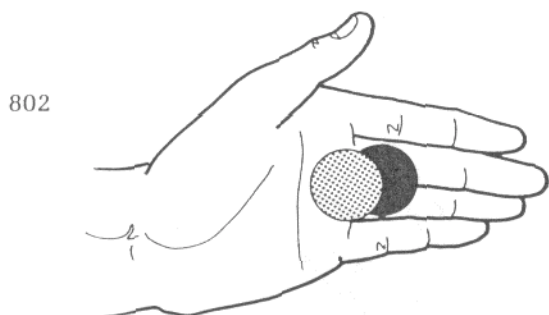

Your right hand, held palm toward you, reaches into the left thumb hole and grasps both coppers between thumb, first, and second fingers (fig. 804). Pull both coins to the right. The silver coin is left behind in position for Han Ping Chien. Continue to pull the coppers to the right until they're just inside the thumb hole. Leave one there, locked in place between your thumb, first, and second fingers as in Isolation Placement, and simply remove the other (fig. 805).

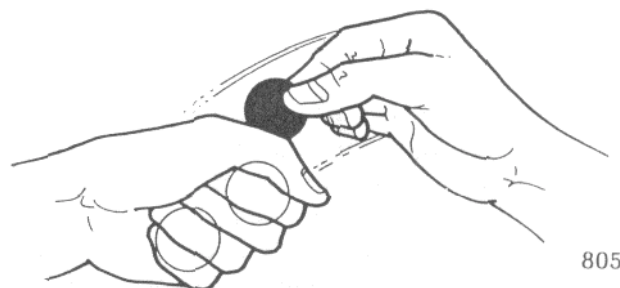
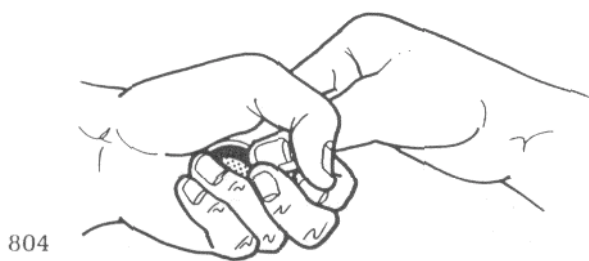

Turn your right hand palm up and openly bounce the copper into classic palm position. At the same time your left fist turns up. Now you're set to do Han Ping Chien. Your right hand turns palm down, retaining the copper in classic palm. It shoots forward in its little hop to the table and, on the way, your left hand moves smoothly to the left releasing the silver coin, which is smacked downward to the table by your right fingers. Immediately spread and lift them so the silver is visible. Then, open your left fingers revealing the copper coin.

Copper/Silver No. 5

Geoffrey Latta

I don't know how Geoff thinks of offbeat stuff like this: it's terrific. You must be seated at a table in position to lap a coin. If you've Shuttle Passed after Copper/Silver No. 4 then you're already in position with the extra copper finger palmed in your left hand. If you haven't, do it now.

Your right fingers pick up the silver coin and place it onto and overlapping the copper coin on the table. Pick both up and place them between your left thumb, first, and second fingers (fig. 806). You're about to use Edge Grip, and you'll get into it as described in Hanging Coins Plus (which is Method Two). Do the basic Edge Grip "put" as already taught, lowering your hands, your right hand taking the silver coin and ostensibly placing it into your left hand (all as described in Hanging Coins Plus). Your left hand places the copper coin into Edge Grip Display in your right hand and Your hands separate. At this point there's a copper coin in your left fist, another copper coin visible in right-hand Edge Grip Display, and a silver coin in right-hand Edge Grip.



Swing your right hand toward you to blow on the copper coin (fig. 807 is the audience view). Figure 808 shows your right hand's next movement - it swoops down in a semi-circular motion, first to the table edge and then immediately forward over the table. As it passes the edge of the table it drops the coin (a Slydini technique from the One Coin Routine). When your hand reaches the center of the table slap it flatly downward. The silver coin in Edge Grip will flip flatly against the table beneath your fingers as they hit the table. Raise your right hand to reveal the silver coin, then open your left hand revealing the copper coin.

In Addition: I've lightly glossed over the Edge Grip technique because it's fully described in another part of the book.

Make sure to swing your right hand toward you to blow on the copper coin - that's your justification for bringing it forward (and past the table edge). With some practice you'll be able to swing your right hand past the table edge and release the coin without any hesitation.

Starfish Copper/Silver

Herb Zarrow

Herb has two versions of this - both have the same effect, though one uses an extra coin. They're based on a sleight of his which originally appeared in Tarbell No. 7.

Handling No. 1

This uses the extra coin, and is easier than the second handling because of that. Hold your left hand palm up and spread your fingers apart starfish style. Balance a copper coin on your second finger and a silver coin on your pinky (fig. 809). An extra silver coin is classic palmed in your right hand. To the audience it'll appear as if you merely pass your right hand over your left hand and the coins change places.



Move your palm-down right hand beside your left hand, your fingers pointing toward the coins (fig. 810). Note that your right thumb is held comfortably against your hand. To start, move your right hand forward covering the coins until the copper coin is directly beneath the base of your right first finger (fig. 811). Nip the copper's edge between your thumb and the side of your first finger and continue moving your hand until the classic palmed silver coin is over your second finger (fig. 812).

Relax your palm and begin to retract your right hand leaving the silver coin on your second finger. As your right hand moves toward you your palm will pass directly over your pinky. When it does classic palm the silver coin (fig. 813). Change your hand's direction, moving it to the right, so that your pinky is guided behind the thumb palmed copper coin (fig. 814). As your right hand moves away it lays the copper flatly on your pinky (fig. 815).

Handling No. 2

This method eliminates the extra coin, but it's very difficult. The starting position is the same: your left hand is palm up, fingers spread, a copper on your second finger and a silver on your pinky. Your right hand is held, fingers together and straight (pointing toward the coins), beside your left hand as described.

Begin moving your right hand over the coins. As your right palm passes over the silver coin that's on your pinky classic palm it. Your hand keeps moving. A second later your right thumb will be in position to nip the edge of the copper coin as taught, pressing it against the side of your first finger.

Continue moving your hand until the classic palmed silver is directly over your second finger. Release it. immediately retract your right hand, pausing when your pinky is behind the thumb palmed copper coin. Wave your right hand to the right, laying the copper on your pinky and revealing the change.

810

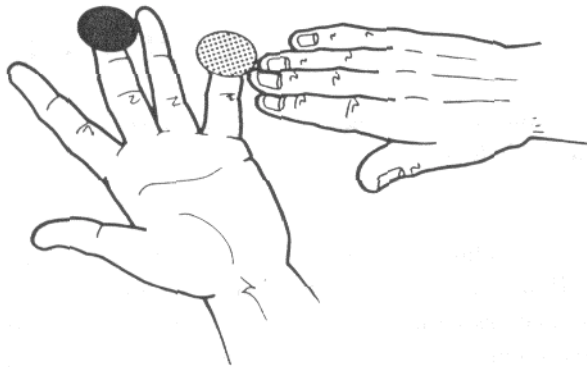

811

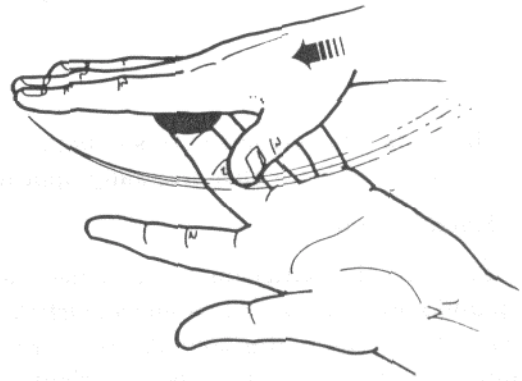

812



813

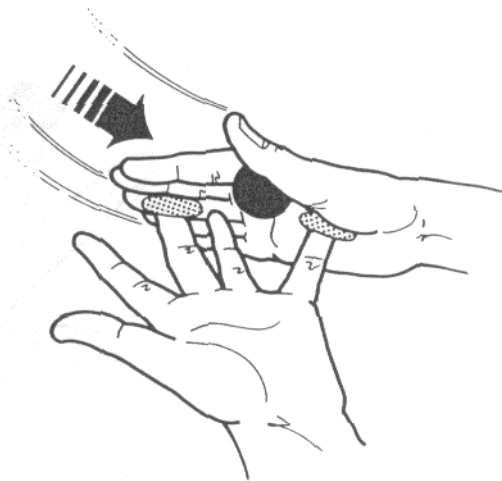

814

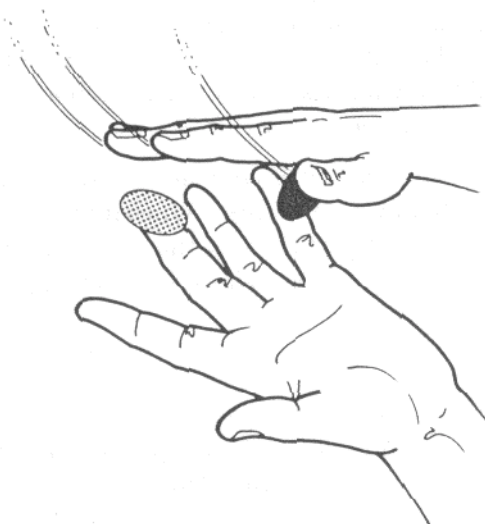

815

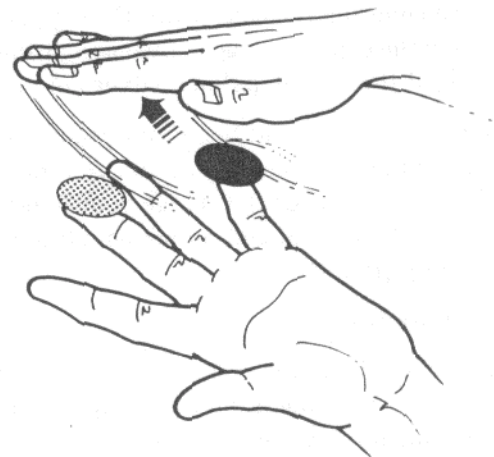

In Addition: Neither handling is easy. Ideally your right hand should not appear to stop at any time. With some practice this can look like trick photography.

Imperial Ishtar

Ken Krenz

The routine that's come to be known as The Coins of Ishtar is really quite old -the basic effect, that of three coppers and three silvers doing a simultaneous coins across from hand to hand, is Paul N. Rylander's and appeared in *The Sphinx* many years ago. Most of the handlings that have appeared have used gimmicked coins, but this one does not; any six coins (three of each kind) can be used, because of that you can use, say, three English Pennies and three quarters (though I'll teach it using three half dollars and three English Pennies). You can be either standing or sitting, though you must have a table to work on.

Hold three silver coins on your palm-up right hand and three copper coins on your palm-up left hand. Display the coins for a moment. Both hands close: your right hand does the Roth technique for Classic Palming One Coin of a Group; your left hand does Isolation Placement getting one of the coppers ready for Geoffrey Latta's Han Ping Chien.

After each hand has performed its actions both fists are turned palm up. Turn your right hand over and do Latta's Han Ping Chien (Handling No. 1), one of the coppers flying beneath your right hand as it slaps two of its silver coins onto the table (fig. 816). The third silver coin remains in right-hand classic palm.

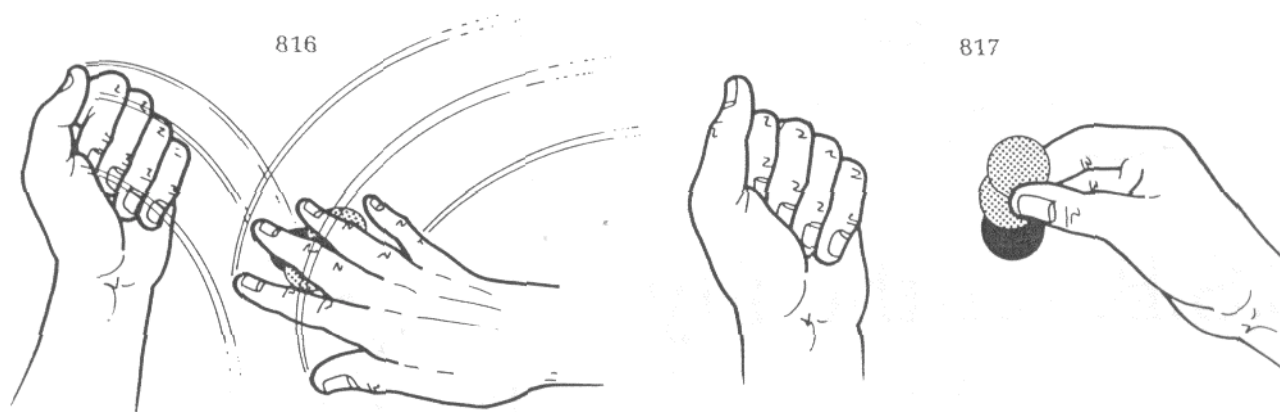

Raise your right hand a bit and pick up the two silvers and one copper beneath it between your thumb, first, and second fingers (fig. 817). Now, several things happen at the same time. Turn your right hand palm up and raise it about six inches, simultaneously relaxing your right palm so the classic palmed silver coin falls onto the table. As your right hand is turning up, your left hand turns palm down and slaps its two coins over the silver coin that's fallen from your right hand (fig. 818).

Lift your left hand and pick up the two coppers and one silver between thumb, first, and second fingers (fig. 819). The first pair of coins has transposed.

Close both hands into fists letting the coins drop inside them. Turn both fists over: your right hand does the Roth technique again, classic palming one of the two remaining silver coins; your left hand does Isolation Placement, getting one of the two remaining coppers into position for the first handling of Latta's Han Ping Chien. Turn both fists palm up.

Repeat the double Han Ping Chien sequence as already described, first doing Geoff's HPC to get another copper coin beneath your right fingers, and then doing Ken's addition to get the classic palmed (in your right hand) silver beneath your left fingers. Afterward there'll be two silvers and one copper in your left

hand and two coppers and one silver in your right. Display the two three-coin spreads in your palm-up hands as at the end of the first transposition.

Close both hands into fists letting the coins drop inside. Turn both fists palm down. Your right hand classic palms the last silver coin (via Roth's technique) while your left hand gets the last copper coin ready for Han Ping Chien using Isolation Placement.

To show the last transposition and conclude, repeat the double Han Ping Chien sequence again as described.

In Addition: The handling is consistent throughout the routine - everything appears exactly the same each time the coins jump, and there's absolutely nothing to detect.

The method is designed to be done rapidly because, as Ken points out, the Ishtar premise is repetitious and the second and third transpositions become anticlimactic. In order to avoid that Ken's handling is extremely clean and direct, without any extra movements or fumbling. Hint: Try incorporating the muscle pass into the second HPC action.

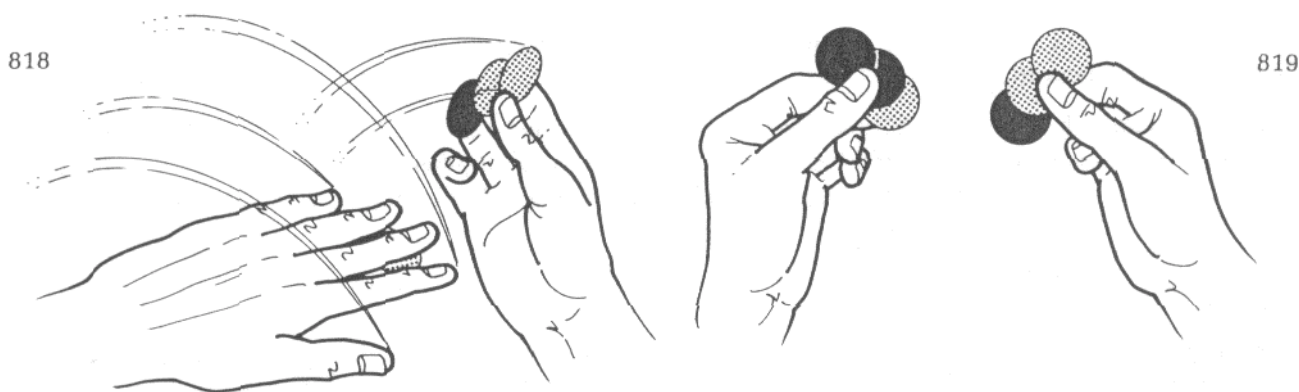

C.S.B. on the Fly

Fernando Roman

For this unusual hybrid of Copper/Silver/Brass and Coins Across you'll need five coins: two matching coppers, two matching brass, and a silver coin. Classic palm one copper and one brass in your right hand, the copper against the palm. You must be seated at a table opposite the audience.

Bring out the three other, different, coins held in a small fan between your right thumb and first finger. The coins are stacked so that the copper is on the inside, the brass is in the middle, and the silver's on the outside. Turn your right hand palm down and let the silver slide onto the table. Toss the copper and brass coins onto your palm-up left hand in finger palm; they should be spread slightly. Do a two-coin Shuttle Pass, your left hand turning palm down retaining the coins in finger palm while your right hand performs its actions, drawing the two coins that were classic palmed out from beneath your left fingers. You'll find that the two switched-in coins will clink at the proper time during the move.

Your right hand places the copper and brass coins onto the table beside the silver coin. Pick up the silver and hold it over your palm-up left hand (your fingers curled slightly to conceal the finger palmed coins) ready for a Retention Pass. Do the move, apparently placing the silver into your left hand; it ends, of course, in right-hand fingertip rest.

Push the silver coin into classic palm as your right hand reaches forward to pick up the copper and brass coins from the table. Hold the copper and brass on your first and second fingertips. Do a Palm Change, dropping the silver coin and pushing the copper and brass into classic palm. When you open your right fist afterward the silver coin will be seen by the audience. Open your left hand revealing the copper and brass coins.

Drop all the coins on the table. Your right hand picks up the silver coin and does a Retention Pass into your left hand. The silver coin ends in right-hand fingertip rest. Your right thumb and first finger grasp the copper coin and hold it slightly above your left fist. Open your left fingers a bit, keeping them curled enough so that the audience cannot see that the silver coin is not in your hand (as it should be). Drop the copper into your left hand and, at the same time, snap your right second and third fingers against your palm, clicking the silver coin against the copper and brass. The silver coin should hit at the same moment that the copper coin would hit the silver if it were in your left hand. The silver actually remains in righthand classic palm after it's pushed there.

Pick up the brass coin from the table and toss it into your left hand, your left fingers opening briefly. It should strike the copper already there and clink. Turn your closed left fist over. Make your magical gesture and let the silver coin in your right hand fall to fingertip rest (the copper and brass remain in classic palm). Open both hands, slapping their coins onto the table. Lift them to reveal the silver coin beneath your right hand and the copper and brass beneath your left.

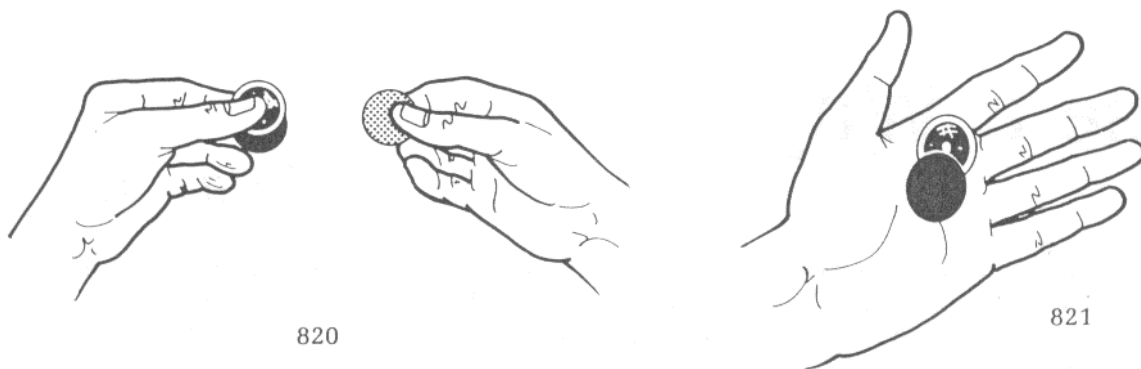

Each hand picks up its coin (or coins) and turns palm up holding them between thumb and fingers (fig. 820). Note which coin is in the next (i.e., innermost) position in right-hand classic palm. Let's assume it's the copper. Lower your hands, your right hand dropping the silver coin onto the table. Arrange the other two coins on your palm-up left hand, brass on first finger base and copper overlapping it, though spread diagonally inward and to the right (fig. 821). Curl your left fingers into a fist at the same time turning your hand over. The brass coin will be caught between the flesh of your thumb base and first finger, and the copper will fall to fingertip rest. Push the copper coin toward your wrist and then Pull your fingertips back so that it dangles outside, held only by your fingertips (additional details on this type of action are in Roth's Deep Back Clip Steal).

Simultaneously lower both hands. Your right hand picks up the silver coin and your left fist, which is at the table edge, relaxes allowing the copper coin to fall straight down into your lap (fig. 822). Immediately raise both hands turning them partially palm up. Lower them a bit and curl your right fingers into a fist, the silver coin in fingertip rest. Relax your right palm and allow the copper coin to fall onto the silver coin.

Both hands slap their coins onto the table. Lift them revealing the copper and silver on the right and only the brass on the left. Your right fingers place the brass coin onto your palm-up left hand, which is at the table edge in position for Slydini's Revolve Vanish (which has already been described in Key to the Orient). As you turn your left hand palm down, closing it into a fist, do the move. The brass coin should be thrown inward because of the wrist turn, avoiding the copper coin already in your lap (fig. 823).

At the same time your right hand picks up the copper and silver coins, taking them into fingertip rest as your hand closes into a fist. Raise both fists a bit. Relax your right hand allowing the classic palmed brass to drop onto the copper and silver coins. Slap both hands onto the table and lift them revealing all three coins beneath your right hand and none beneath your left.

822

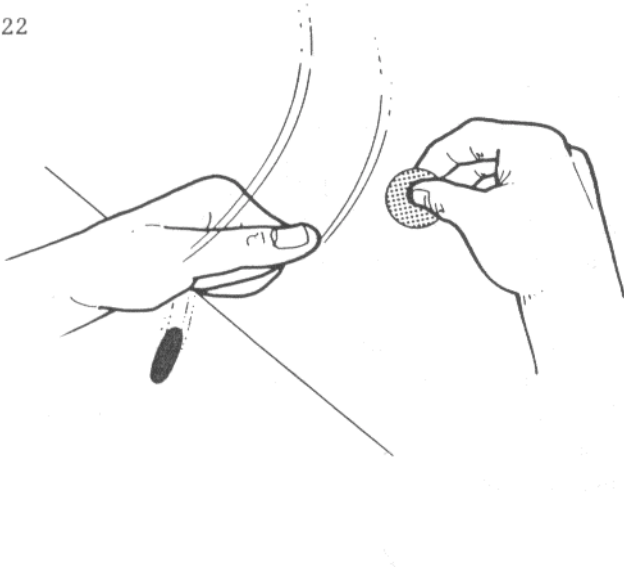

823

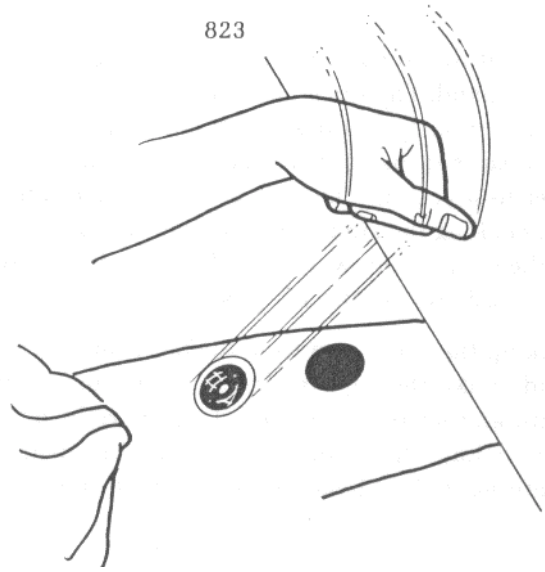

Erase a Way

Mark Levy

There are a number of ways to use this. it's impromptu, but involves some lapping, so you must be seated at a table opposite the audience. Place a half dollar (though you can actually use any coin) on the table directly in front of you. It does not have to be close to the edge. Your right hand holds a pencil between thumb, first, and second fingers with the eraser downward.

Lean forward and partially cover the coin with your left hand (fig. 824). Your left pinky rests along the table and the inner side of your hand is raised. Your left thumb and first finger rest lightly on the coin to hold it in place during the erasing. Lower your right hand, moving the eraser onto the coin (fig. 825).

824

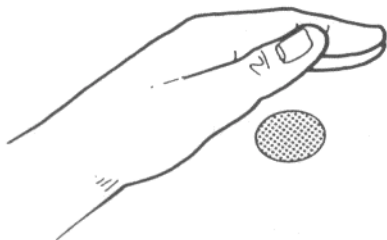

825

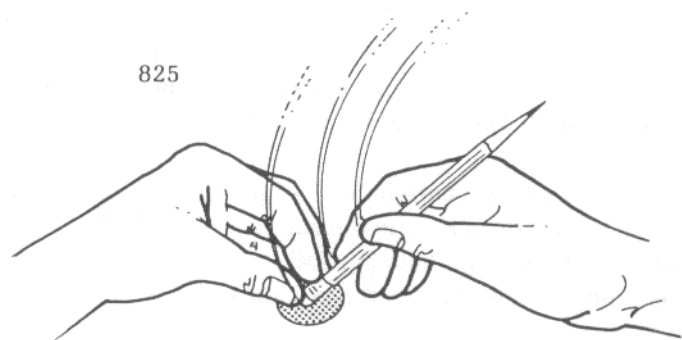

Begin a slight back and forth right-hand motion, rubbing the eraser against the coin. On one of the toward - you rubs lift your left thumb and first finger slightly and sweep the coin off the table and into your lap with the eraser (fig. 826). The action should be completely covered by the back of your left hand.

Here's one way that Mark uses the move. Finger palm a half dollar with a 1981 date in your left hand. Take another half dollar with an older date and let the audience examine it. Mention the date and say you'd prefer to have a newer coin. Place the coin on the table and do the move, then pretend to pick it up and show the one in your left hand.

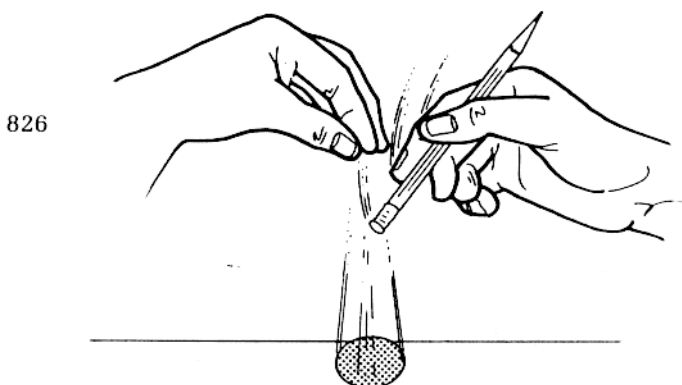

ESPenny Miracle

Mark Levy

Here's an offbeat mental item with coins. You write a prediction on a piece of paper and give it to a spectator to hold. You spill a glassful of pennies of all different dates on the table for them to examine, scooping them back into the glass afterward. The glass is given to the spectator, who selects one of the pennies, the date of which matches your prediction. Everything is examinable.

It's clever. You need two duplicate glasses. Fill one with about twenty-five pennies of the same date (say, 1974) and place it between your knees. You must be seated at a table opposite the audience. Take the other glass and fill it with about twenty-five pennies of various dates. Put four pennies with 1974 dates on top of them and you're ready to perform.

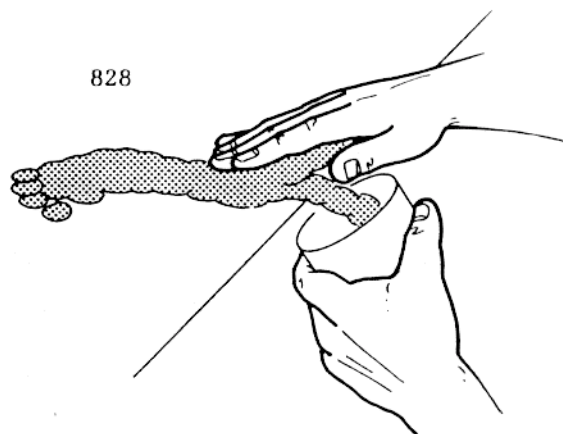
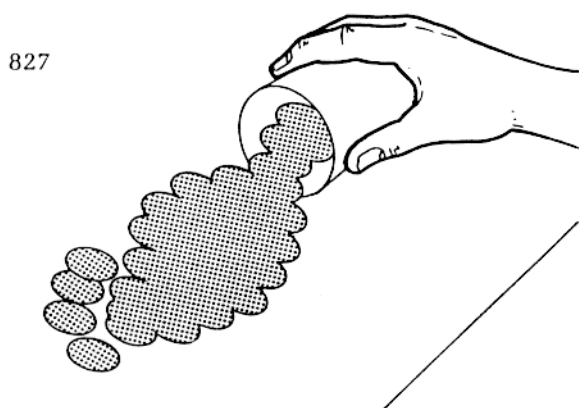

Display the glass filled with pennies and place it on the table. Write 1974 in large numerals on a piece of paper and fold it several times. Hand it to a spectator for safekeeping, asking him to hold it in full view at all times.

Pick up the glass and spill the pennies onto the table from left to right (fig. 827). You must keep the four 1974 pennies on the left as shown. Transfer the glass to your left hand and spread the pennies out with your right hand.

After the spectators have looked at the pennies to make sure most of the dates are different your left hand moves the glass to just below the table edge while your right hand scoops the pennies into it (fig. 828). Scoop up all but the four 1974 pennies. As you lean forward to reach for them at the outer left your right arm will completely obscure your left hand from the audience (fig. 829). Your left hand quickly switches glasses, placing the one it holds between your legs and grasping the one with all 1974 pennies. It moves upward to the table edge as your right hand sweeps the four 1974 pennies into it. Raise the glass above the table.

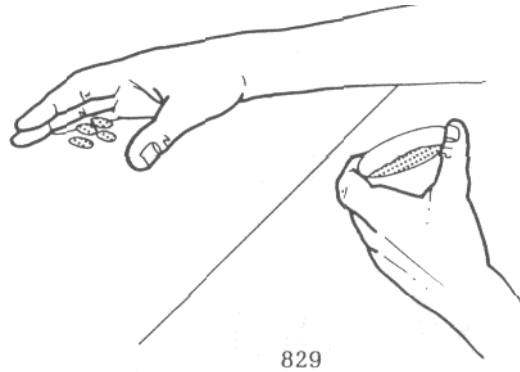

Hand the glass to a spectator and ask him to hold it beneath the table and, without looking, select a penny. He's then to hand the glass to you beneath the table. take it with your right hand and, as you bring it up on your side, switch it for the one with all different pennies. Let him read the date on his penny out loud, and then open your prediction which, needless to say, matches.

Odd Coin Transit

Bruce Berkowitz

This clever impromptu routine uses only four coins, three silvers and a copper, and can be done either sitting or standing (for teaching's sake I'll assume that you're standing at a table).

To start, all four coins are on the table. Pick up the three silvers with your right hand and do Roth's technique for Classic Palming One Coin of a Group, then turn your hand palm up to display the coins, one of which is in classic palm position. Turn your hand over retaining one coin in palm and catching the other two at your fingertips in a stack. Without pausing toss them into your left hand, which immediately closes into a fist around them. Turn your left fist palm down.

As attention is momentarily on your left hand your right hand settles into a relaxed fist and allows the classic palmed coin to drop to fingertip rest. Lower your right hand over the copper coin that's on the table and, as you pick it up, do Geoffrey Latta's One-Hand Turnover Switch. As you straighten your right fingers during the switch move your left fist beneath them. When you slap them down, they go onto the back of your left fist (fig. 830). I'll assume you've flipped back to Geoff's section and reminded yourself of his handling of the switch. When you do it here your thumb must drag the copper coin farther up along the side of your first finger than it normally would - that's necessary for the loading move (which is Ross Bertran's) which follows (fig. 831). (A variation of L'Homme Masque's Load.)

Begin to slowly turn your hands palm up and, as you do, you'll notice that when they're palm toward you the hidden copper coin will be directly above the left thumb hole (fig. 832). Without pausing relax your right thumb and drop the copper into the hole (fig. 833). Immediately turn both hands palm up keeping your right fingers pressed against the underside of your left fist (fig. 834). Slowly draw your right hand to the right, revealing the silver coin on your fingers (fig. 835). Open your left fingers to show two silvers and a copper. Turn both hands over dumping the coins onto the table.

830

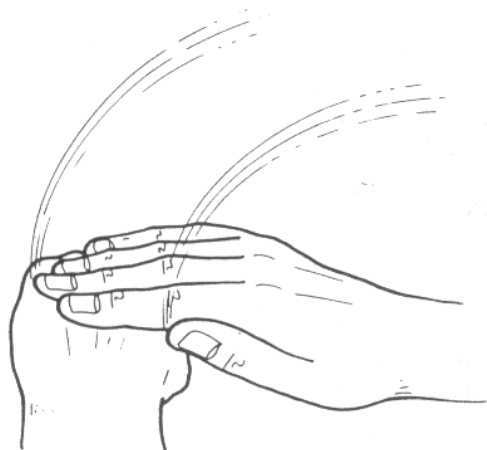

831

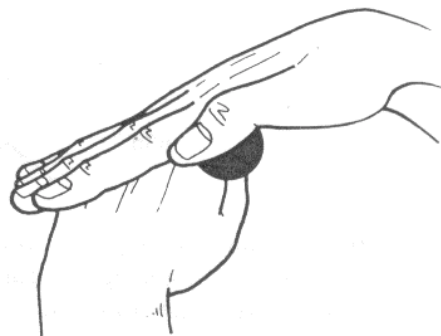

832

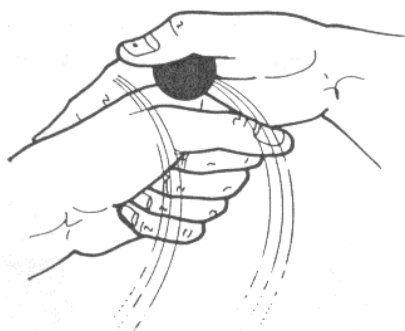

833

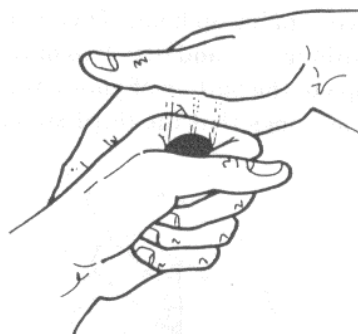

834

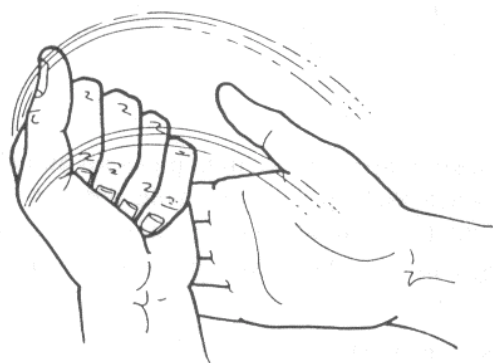

835

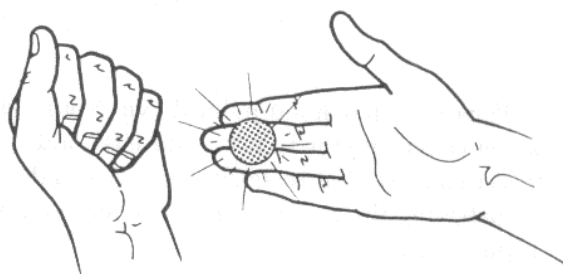

Raise your hands and show both completely empty. Openly slide the copper coin over to the single silver coin on the right. Say, "The first silver coin has jumped over, switching places with the copper." Your right hand picks up the two silver coins at the left and apparently puts both into your left hand while actually retaining one. There are dozens of ways to do this - any click pass will do. (You can use Geoff Latta's Half Retention Pass taught in his Standup Spectator Coins Across). Afterward, your right fingers push the stolen silver coin into classic palm. Your left hand is in a palm-down fist.

Pick up the silver coin on the table and, simulating the action of the One-Hand Turnover Switch, slap that coin onto the back of your left fist. As your right hand moves from your left fist back to the table to pick up the copper coin let the classic palmed silver coin fall to fingertip rest. Pick up the copper and, as you apparently slap it onto the back of your left fist, do the switch. While keeping your right fingers pressed firmly on your fist raise your hands a bit and turn them palm toward you - loading the copper into your left hand (fig. 836). Ask, "Can you see the coins between my fingers?" After they've said "No" lower your hands turning them backs up again. Simply raise your right hand revealing two silver coins on the back of your left fist.

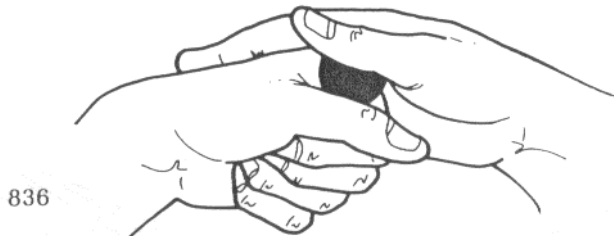

Pick them up and move your right hand away. Turn your left hand palm up and open your fingers revealing a silver and a copper. Both hands turn palm down, dumping the coins onto the table. Openly slide the copper from left to right, joining the two silvers already there.

Say, "Let's recapitulate what's happened up to now." Describe your actions as you go. Like this. Pick up the three silver coins and do the Roth technique, getting one into classic palm position and then displaying them on your palm-up hand. Turn your hand over and toss the two coins that remain loose into your left hand. Continue and then two of them jumped across one at a time." As you finish the sentence let both coins drop out the bottom of your left fist one at a time (fig. 837). Keep your fingers closed afterward - the audience assumes that the third silver coin is still in there.

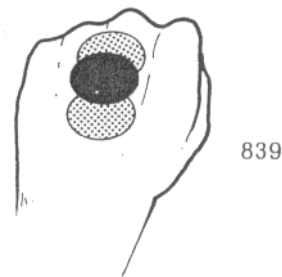
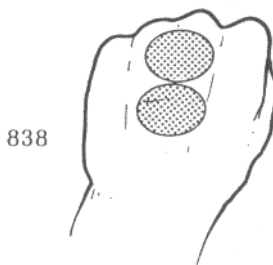
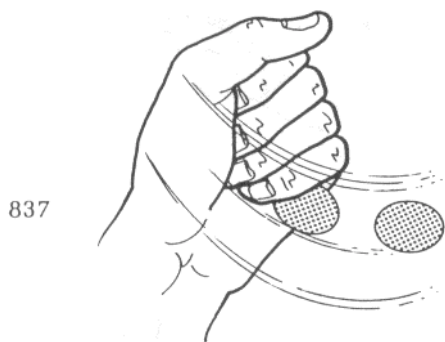

Turn your left hand palm down. Your right hand, simulating the switch, picks up and slaps the two silver coins onto the back of your left hand as in figure 838. Pick up the copper coin and slap it on top of the silver coins so that rests evenly between them (fig. 839). Pause for a second, curling your right fingers and transferring the silver coin from classic palm to fingertip rest. Do the switch as you apparently turn the copper coin over.

Immediately raise your right hand about six inches revealing three silver coins. Lower your right fingers onto them again and, as you turn your hands palm up (exactly as you did when the first coin jumped), load the copper coin into your left thumb hole. Afterward your right hand moves to the right displaying the three silvers on its fingers. Slowly open your left hand revealing the copper coin.

In Addition: Notice that the timing on each load of the copper coin into your left fist is different - that makes this very deceptive.

Open Travelers No. 1

Richard Kaufman

This is based on the Marlo-Jennings card plot, though here done with coins. Two utility sleights are used - The Sliding Concealment Transfer (which opens up new applications of the Roth Thumb Base Slide) and the Table Slide HPC. You need five coins, and must be working on a close-up mat seated opposite the audience. To start, four coins are in your right hand and the extra coin is finger palmed in your left hand.

Display the four coins on your palm-tip right hand. Turn it palm down and do the Roth technique for Classic Palming One Coin of a Group. At the same time your left hand rests on the table, fingers partially open, and lets the finger palmed coin fall onto the table (fig. 840). This is the Table Slide HPC. The heel of your left hand is pressed firmly against the table so the audience cannot see beneath it. Curl your thumb so its tip rests against the left edge of the coin (fig. 841).

Your next two actions must be properly timed. Your right hand tosses three of its coins onto the table just to the right of your left hand (one coin retained in classic palm) and, as they land, your left thumb kicks the coin beside it to the right (fig. 842). The four coins appear to have been thrown by your right hand.

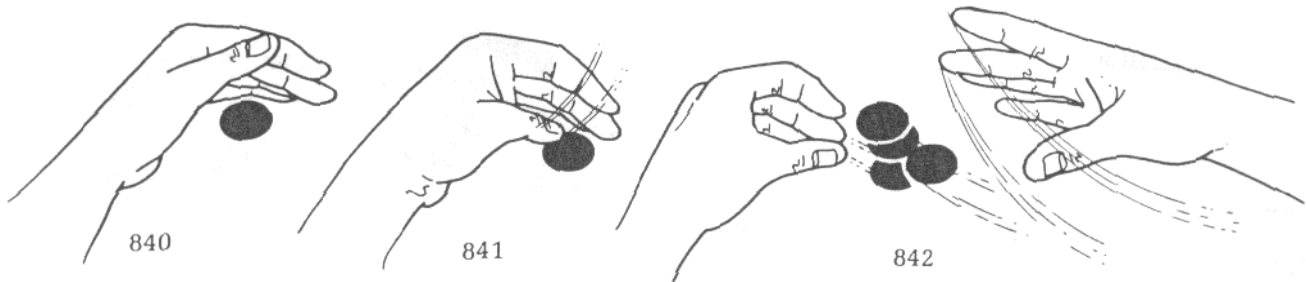

Without pausing your left hand lines the coins up as in figure 843. Show your left hand empty, turn it palm down, and lower it over the coins so that your thumb base contacts the left-end coin (fig. 844). Sliding that coin beneath your thumb base as already taught in David Roth's Ultra Coin Assembly, move your left hand a tiny bit inward and then to the right - the coins beneath it as in figure 845, in which the hand is transparent.

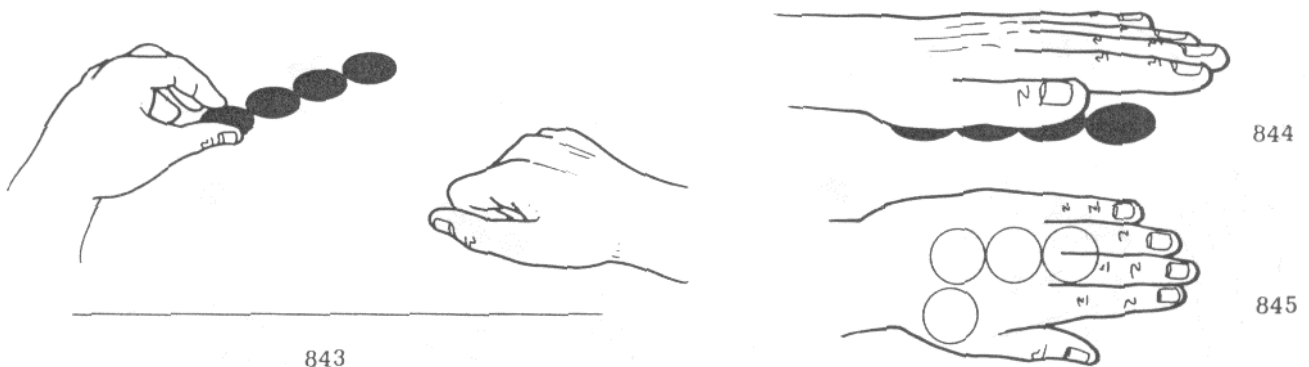

Extend your right first finger and insert it beneath your left hand and pretend to slide an invisible coin out (fig. 846). Say, "I'm going to make one of these coins invisible and move it over here," and slide your first finger to the outer right corner of the mat (fig. 847). "You probably don't believe me because you can't see the coin - but it's right there." Jab the spot with your finger. Jab it again, this time doing David Roth's Pop Out, a coin visibly appearing beneath your fingertip (fig. 848).

The Sliding Concealment Transfer

Both hands move simultaneously. You're going to secretly transfer the coin that's beneath your left thumb base to beneath your right hand. Your left hand moves inward and to the right in a quarter circle, while your right hand moves inward and to the left (fig. 849). At about 7 o'clock (on the circle of movement) your left hand suddenly turns palm up - this will propel the coin beneath it to the right (fig. 850). At the moment that your left hand turns palm up your right hand must be sliding beneath it, moving toward the three coins at outer left. If you've timed it right the coin will not be visible as it slides beneath your right hand (fig. 851 is an exposed view).

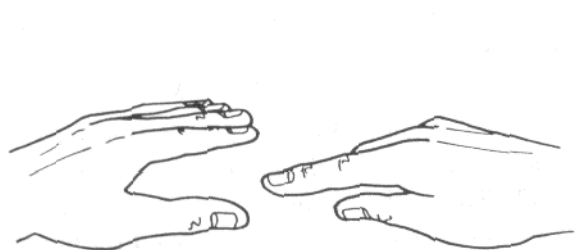

846

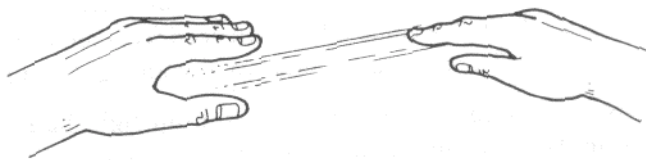

847

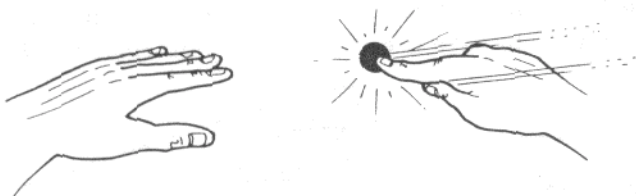

848

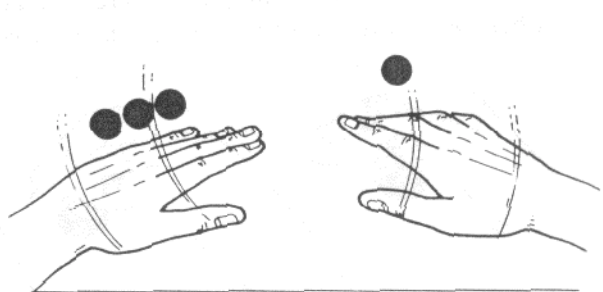

849

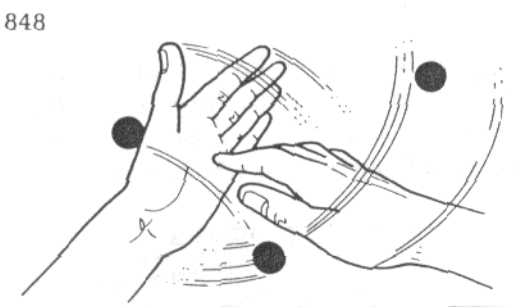

850

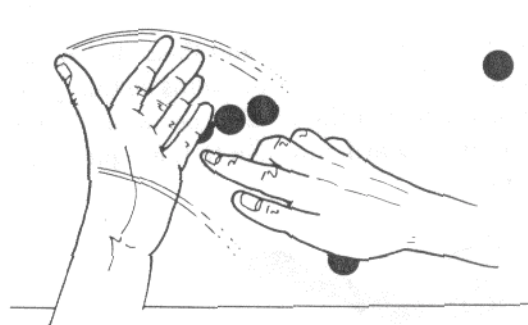

851

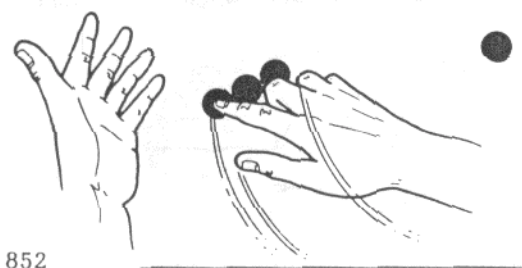

852

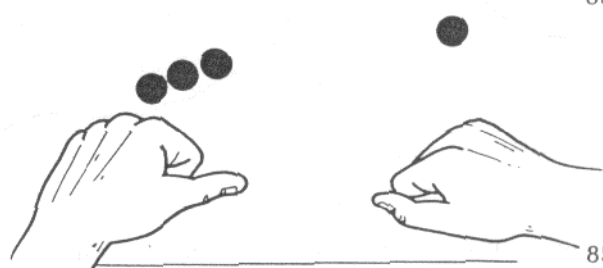

853

With a bit of practice you'll be able to catch the sliding coin beneath your right thumb base in sliding position. Your left hand moves to the left, out of the way, and your right hand moves forward, your extended right first finger touching each of the coins as you say, "Three to go" (fig. 852).

Both hands move to rest position - that's relaxed fists at the inner corners of the mat (fig. 853). As your right hand moves to that position lift it slightly and curl your fingers so the concealed coin slides against your fingertips (fig. 854). With a slight finger curl/squeeze your fingertips can wedge themselves beneath the coin, raising it to fingertip rest. You must be able to do that imperceptibly.

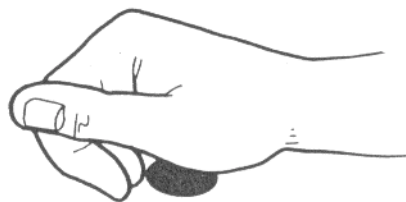

854

Move your left hand forward, straightening your fingers as you cover the three coins at outer left, getting the left-end coin beneath your thumb base as already described. Lift your right hand and, as you move it toward your left hand, your second and third fingertips classic palm the coin. Extend your first finger beneath your left hand and pretend to drag another coin to the right. Do Roth's Pop Out to make that coin appear overlapping the first one with a clink (fig. 855). Immediately do The Sliding Concealment Transfer.

Repeat the entire sequence of moves for the third coin. After that third coin has appeared at the outer right, and there's only one coin left at the outer left, pause and say, "Let's make the last one more difficult by moving it farther away." Your right first finger drags that coin to the inner left corner of the mat (fig. 856). Cover the coin with your left hand, getting it beneath your left thumb base in position to lap it as described for the final coin in Roth's Ultra Coin Assembly. Your right hand does Pop Out to produce the fourth coin at the outer right and, a second later, your left hand laps the coin and turns palm up.

855

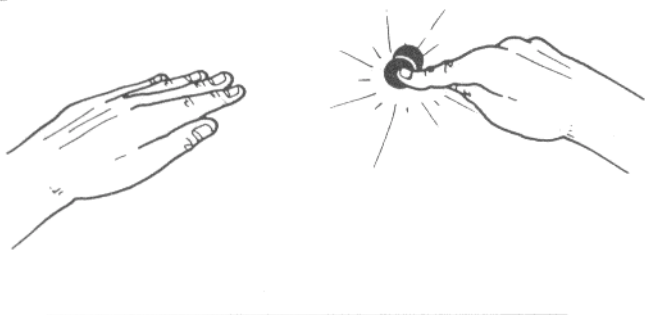

856

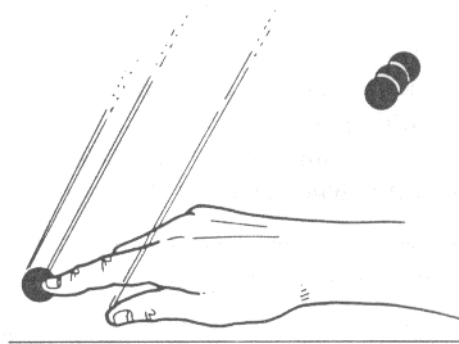

Open Travelers With Edge Grip

Kaufman and Arthur

David Arthur suggested, after seeing Open Travelers, that applying Edge Grip might clean things up a bit. He was right, and I worked out this handling, including a sure-fire way to do Roth's Pop Out move from Curl Palm. The set up and basic structure of the routine remain the same. To start, one coin is classic palmed in your right hand and four coins are visible at your right fingertips. Allow those coins to drop into your right hand, mixing with the classic palmed coin. Turn your right hand palm down so all five coins fall in a stack inside your fingers. Do Roth's method for getting into Edge Grip (the first one) so that as your right hand drops four of the coins onto your palm-up left hand your left fingers kick the fifth coin into Edge

Grip between your right thumb and second finger. Your left hand places the four coins back in your right hand in Edge Grip Display.

Your right hand turns palm down and lays the coins at the outer left corner of the mat, and then retracts to rest position. Your left hand arranges the four coins as already described, and covers them getting one in position for The Sliding Concealment Transfer.

When your right hand is in relaxed fist rest position the coin is naturally transferred to Curl Palm. Lift your right hand and do the business where you pretend to drag an invisible coin to the outer right. Keep your thumb pressed loosely against the side of your hand to provide some cover for the Curl Palmed coin (fig. 857).

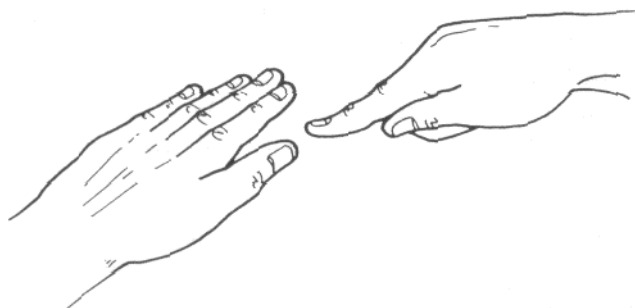

857

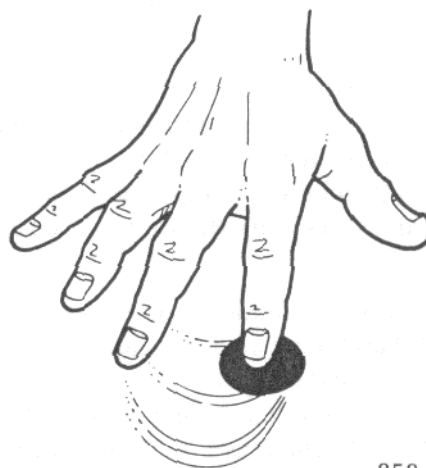

858

The Curl Palm Pop Out

Hold your right hand about six inches behind the spot on the table you intend to jab with your first finger and produce the coin. Shoot your hand forward and at the same time simply straighten your other fingers, tilting your hand ever so slightly to the right. The coin in Curl Palm will move outward beneath your straightening second finger and, as it reaches the tip, flip to a horizontal position beneath your first fingertip (fig. 858). Your other fingers are slightly spread.

Your second finger literally pulls the coin outward. The slight tilt of your hand will cause the coin to move beneath your first finger.

As soon as the coin has appeared do The Sliding Concealment Transfer. Afterward your right hand will have the extra coin concealed in fingertip rest. Your left hand reaches to the outer right and lifts the justproduced coin. Both hands move upward - your right hand transferring its coin to Edge Grip (using method three as taught in Framed Again), and your left hand placing the coin between your right thumb and second finger in Edge Grip Display.

Pause. Your left hand covers the coins at outer left getting one beneath thumb base. Your right hand turns palm down and places its visible coin at outer right. Move the invisible coin to the outer right and do Curl Palm Pop Out, producing it. Do The Sliding Concealment Transfer so the extra coin ends in righthand fingertip rest.

Your left hand lifts both coins at outer right and, after your right hand has risen and transferred the concealed coin to Edge Grip, places them in Edge Grip Display.

Conclude the routine following the same pattern, producing the third coin, doing the transfer, and then lapping the extra coin as you produce the fourth coin at outer right.

Open Travellers No. 2

Geoffrey Latta

After Geoff saw Open Travelers No. 1 he developed the following handling, which tackles the problem from an entirely different approach. You need four coins and a matching shell (which is over one of the coins at the start).

Display the four coins in your hands, show both sides briefly, and place the shelled coin onto the table to the right. The three remaining coins lie on your left palm, spread inward from your second finger base (fig. 859). Begin to close your left fingers, at the same time turning your hand over. Your second and third fingertips should press upward against the lowermost coin once they've curled inward. They push the lowermost coin out of your fist so that it dangles, held by your fingertips, as already taught in Roth's Deep Back Clip Steal.

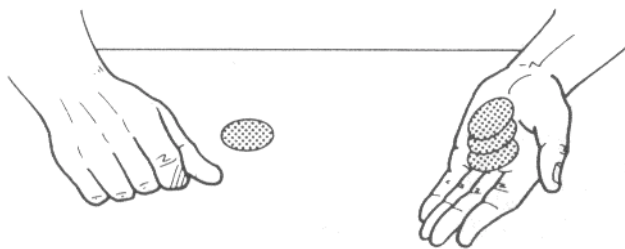

859

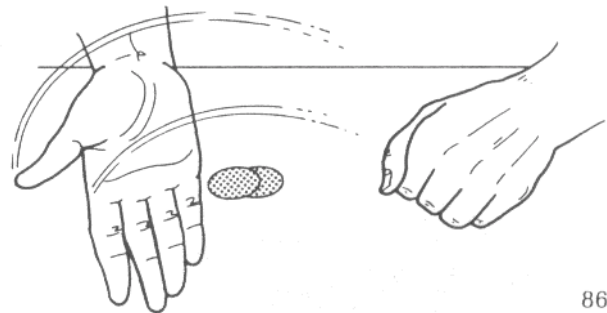

860

Your right hand pretends to take one of the coins from your left hand and place it onto the single coin on the table to your right. The coin is, of course, invisible. Afterward show your right hand empty on both sides. Turn it palm down and lower it over the shelled coin, pressing against it with the base of your second finger. After a second or two the shell will adhere to your hand if you lift it. Don't pick your hand up much, however, simply enough to move it a bit to the right so that when you lower it the shell will overlap the coin. Raise your right hand to show the two coins (fig. 860).



861

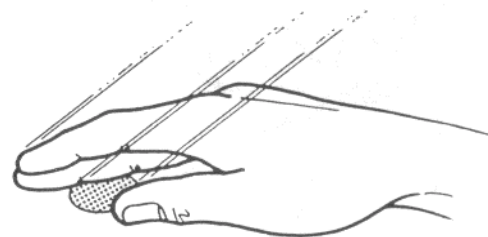

862

The patter line, "The first coin has traveled from here to here," will cover the open steal of the coin from your left hand. Like this. As you say, "The first coin . . . - 11 your right hand moves over the two tabled coins; your fingers on the outer edge and your thumb on the inner edge of the shell (fig. 861). At this point you've completely covered the coins from the audience. Your right thumb and fingers move the shell to the left so that it falls over the tabled coin (fig. 862). Continue, ". . . has traveled. . .," and immediately raise your right hand, your fingers together and straight with your thumb behind them as if holding a coin (fig. 863). As you raise your right hand turn it slightly to the left as in the illustration.

As you continue, ". . . from here. . ." a number of things happen simultaneously. First, both hands begin to move to the left, though your right hand moves much faster so it catches your left hand (fig. 864). As it moves your left fist turns over and, as the coin comes into view, your right thumb and fingers grab it (fig. 865). As soon as your right hand has the coin it freezes, while your left hand continues to move (fig. 866). Your left hand stops, too, after another few inches. Then, your right hand taps the half dollar against your left wrist (fig. 867). (This is a move which both Geoff and Scott Weiser have come up with independently.) That happens when you finish saying, "...from here...."

863

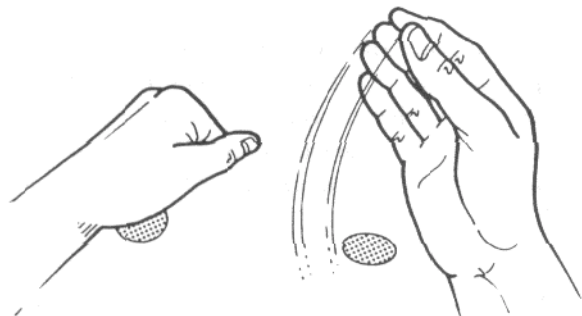

864

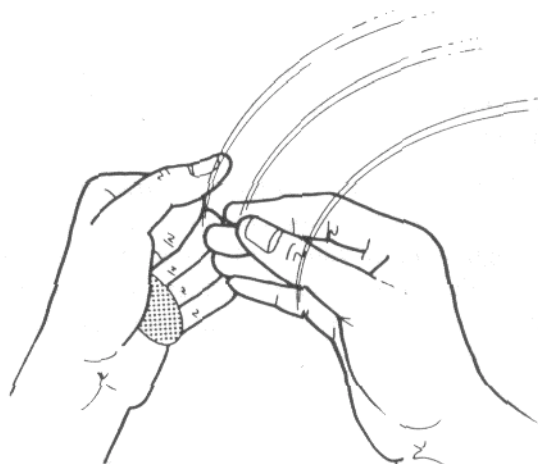

865

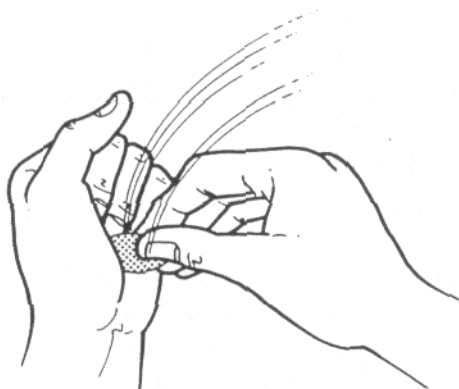

866

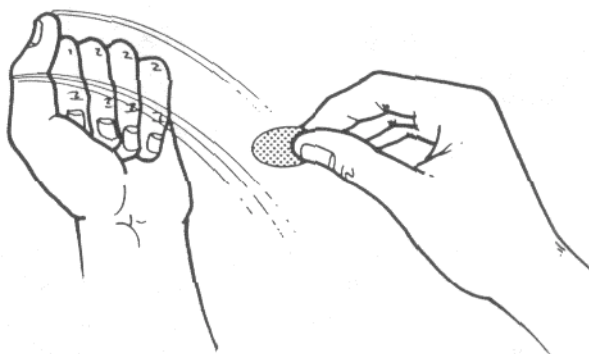

867

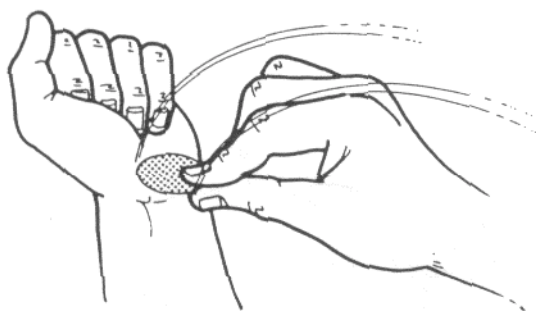

868

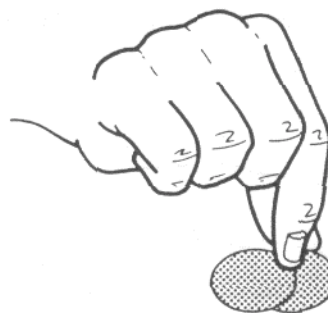

As you finish the sentence, saying, ". . . to here," your right hand slides the coin it holds beneath the shelled coin on the table - the shelled coin overlapping it and spread to the right (fig. 868).

Open your left fingers to display two coins. As you close your hand and turn it palm down get another coin into stealing position, hanging out of the fist.

Your right hand pretends to take another visible coin and place it onto the two already on the table, then turns palm (town and secretly spreads the shell to the right by picking it up beneath your second finger base

as already described. When you lift your hand there will apparently be three coins on the table. Repeat the fake pick up, sliding the shell over one of the coins, and do the steal from your left hand as you say, "The second coin has traveled from here to here." Slide the coin in your right hand beneath the two on the table and you're set to repeat the patter to make the final coin go across.

Invisible Noise

Joe Safuto

If you've ever wanted to do a close-up version of Copentro, without any gimmicks, Joe's routine should be exactly what you're looking for. You must be seated at a table opposite the audience. You need six half dollars, two identical glasses, and an opaque hanky. Place three of the coins into one of the glasses and place that into your lap. The other three coins lie on the table beside the glass and hanky. The other three coins lie on the table beside the glass and hanky.

To perform, allow all the props to be examined, then drop the coins into the glass. The hanky should be lying near the table edge in a spread condition. Lean forward, your right hand reaching for the visible glass. At the same time your left hand drops into your lap, picks up the loaded glass, and moves upward to just beneath the table edge (fig. 869). Your right hand picks up the glass that's on the table and spills the coins to the left. At the same time your left hand moves upward a bit more, your first finger and thumb grasping the edge of the hanky and lifting it (fig. 870).

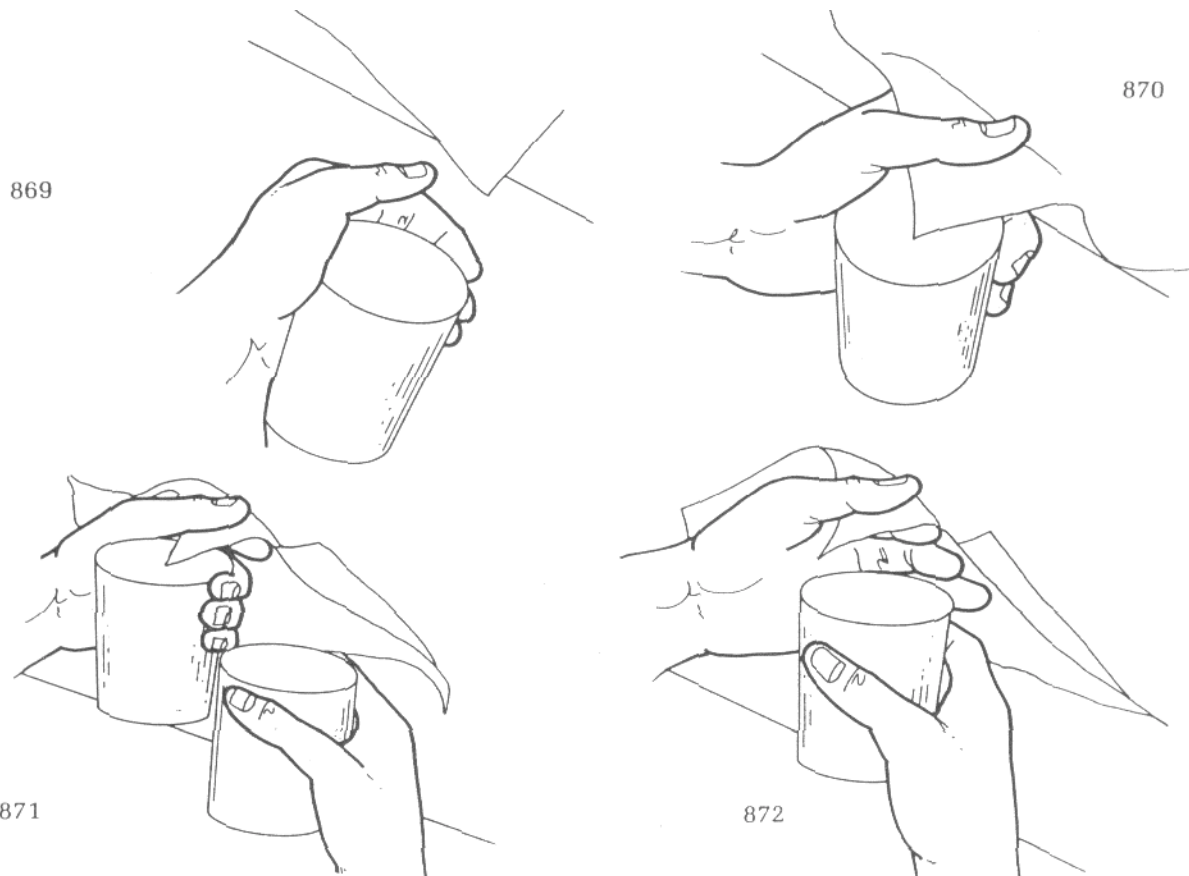

Swing your right hand around toward you, moving it behind the hanky (fig. 871). Without pausing drop that glass into your lap and grasp the glass held by your left hand (fig. 872). Move it forward beneath the center of the hanky and leave the now covered glass on the table to the left of the coins.

Drop your right hand into your lap and set the glass between your legs, mouth upward, directly beneath the table edge at center (fig. 873). At the same time your left hand arranges the visible coins in a horizontal row on the table to the right of the covered glass (fig. 874).

873

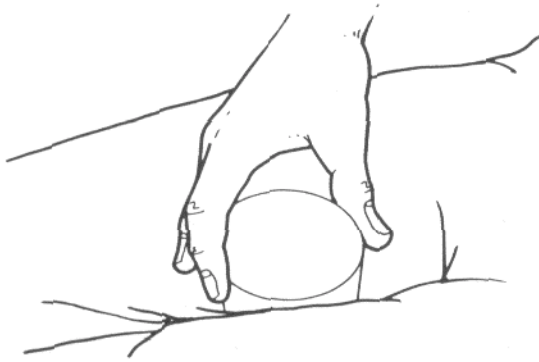

874

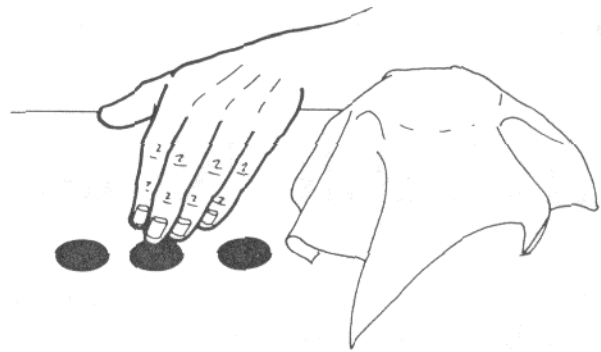

875

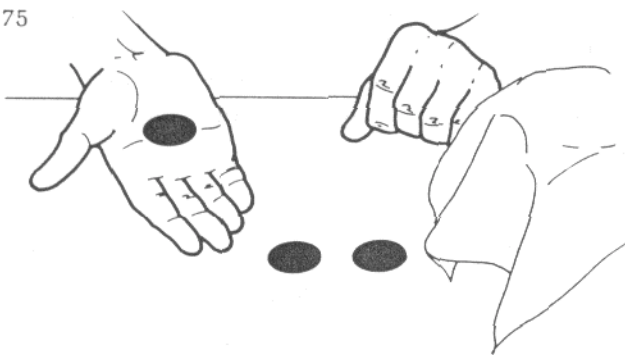

876



Pick up one of the coins and hold it on your palm-up right hand in classic palm position (fig. 875). Pretend to dump that coin into your left hand, which immediately closes into a fist. Your right hand moves back to the table edge and drops so that your fingers rest on the table, but the rest of your hand hangs over the edge (fig. 876). Your right palm should be directly over the glass held between your legs.

877



Raise your left hand over the covered glass and pretend to drop the coin into it. At the same time relax your right palm and allow the classic palmed coin to fall into the glass with a clink (fig. 877). Since sound is omni-directional the spectators will hear the sound as if it came from the covered glass on the table.

Show both hands empty. Your right hand picks up the second coin. Repeat the vanish and then proceed exactly as already described so the second coin is heard to fall into the covered glass on the table.

Show both hands empty. This time, your left hand lifts the remaining coin and holds it in palm-up finger palm. Apparently dump the coin into your right hand. Your left hand relaxes and moves to the table edge and rests there, the lower side of your pinky along the edge (fig. 878). That hand is directly over the glass in your lap. Your right hand, supposedly holding the coin, moves over the covered glass and pretends to toss the coin downward into it. Simultaneously relax your left fingers and allow the finger palmed coin to drop into the glass.

Show your hands empty, lean back and relax, and allow your right hand to drop into your lap. It picks up the glass that's between your legs and moves upward to just beneath the table edge. Your left hand sharply pulls the hanky off the tabled glass to reveal the coins inside, and continues moving back to the table edge to place the hanky's edge between your right thumb and first finger (fig. 879).

Your left hand moves back to the visible glass and spills out the coins. It moves behind the hanky, which your right hand raises, and drops the glass into your lap. Grasp the loaded glass and move it beneath the center of the hanky, pushing the now covered glass back to the left. (This is the same switch you did at the start, though with the opposite hands.) Set the just-lapped glass upright between your legs.

Offer to repeat the routine. Repeat the first vanish, classic palming the coin in your right hand as your left hand pretends to drop it over the covered glass, but do not release the right-hand coin. Look puzzled because there's no sound. Your right hand picks up the second coin and does a finger palm vanish into your left hand. Again, your left hand moves over the glass and pretends to drop the coin in - but no noise. Your right hand moves back to the table edge as before, but retains the coin in finger palm.

878

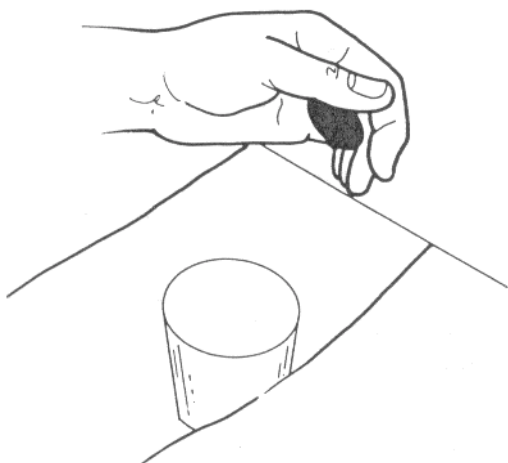

879



Your palm-down left hand lifts the third coin and pretends to place it at your right fingertips, your left thumb pulling it into finger palm. Your right hand immediately moves over the covered glass and pretends to drop the coin in.

Apologize for the lack of noise, and ask the spectator to press the spot on the table where the first coin was. At the same time gesture with your left hand and move your right hand back to the table edge in position to drop the classic palmed coin into the glass in your lap. When the spectator pushes, relax your palm and allow the coin to drop. Ask him to push the spot where the second coin was - this time allow the finger-palmed coin in your right hand to drop.

Your right hand reaches forward to the spot where the third coin was, at the same time moving your left hand back to the table edge in position to drop its coin into the glass. Pretend to pick the coin up and toss it into the glass, at the same time dropping the left-hand coin into the lapped glass. Show your hands empty and let a spectator remove the hanky to reveal the coins back in the glass.

Sleeved Coin Cut

Richard Kaufman

This is basically a combination of a Scarne idea and Ben Braude's De-Sleever move, both of which appeared in *The Phoenix* in the late forties. You need a deck of cards and two matching half dollars (you can use quarters if you prefer). You must be standing, wearing a jacket, with the extra coin classic palmed in your right hand. Have the other coin in your left jacket pocket.

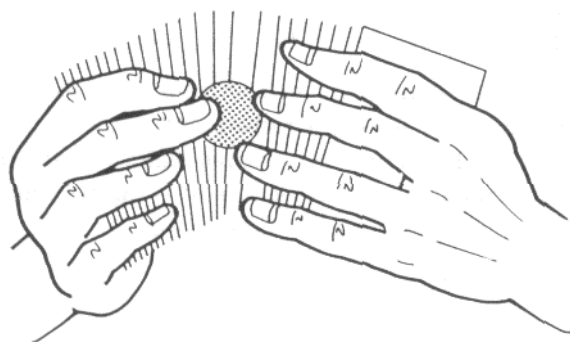

880

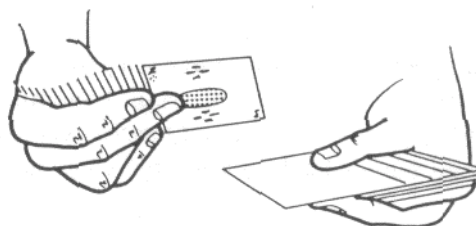

881

Hand the deck to a spectator for shuffling. When he's finished your left hand brings out the coin for display in palm-up finger palm, ready for *The Shuttle Pass*. Do the move, apparently taking the coin with your right hand. Give it to the spectator to hold.

Take the deck from him and hold it, face down, in natural dealing position in your left hand. Spread the cards from hand to hand, your right second fingertip reaching between your left second and third fingers. Move it beneath the coin and pull it to the right, pressing it lightly upward against the spread (fig. 880 is an exposed view).

Ask the spectator to remove any card, breaking the spread at that point - your right hand lifting all the cards above the selection. As your hands separate your right second fingertip presses the coin upward against the bottom of the upper portion (fig. 881).

Have the spectator replace his card onto the lower portion in your left hand. Immediately place the righthand cards on top, loading the coin above his selection. Hold the deck fairly tightly in dealing position your left fingers will prevent the loaded coin from shooting out the side of the deck during the Braude sleeving move. Extend your left hand toward the spectator and ask him to place the coin onto the deck, pretty close to center.

Both arms now move at the same time. Extend your left hand to your left, turning slightly. At the same time raise your right hand in a palm-up gesture (fig. 882). Lower your right hand, turning it palm down, until it's directly in front of you. At the same time swing your left hand in a quarter circle toward your right hand, stopping when it's directly beneath. The coin that's on the deck will continue to move because of your left hand's momentum, flying off the deck and up your right sleeve (fig. 883).

Without pausing your right fingers begin rubbing the top of the deck in small circular motions - as if rubbing the coin through the cards. Lift your fingers revealing the vanish and show your right hand empty. Your right hand cuts the deck at the natural break provided by the coin, lifting all the cards above it. Extend your left hand toward the spectator and ask him to lift the coin and look at the card beneath it which is his selection.

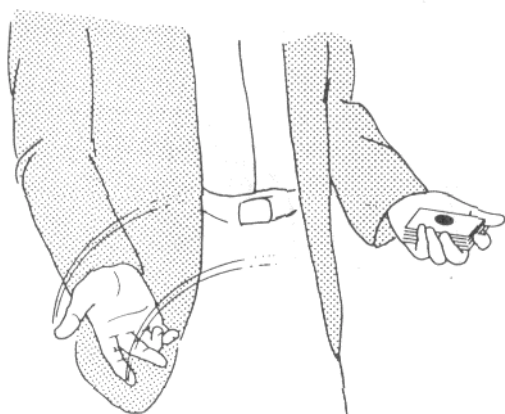

882

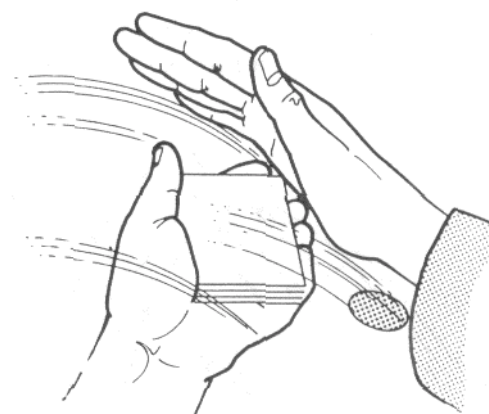

883

Telling Tails Vanish

Danny Korem

The idea of secretly tossing a coin inside your shirt is not new, but this is a sure-fire handling covered by a perfectly logical action: doing a heads/tails flip of a coin. You must be standing, wearing a button-down shirt.

884

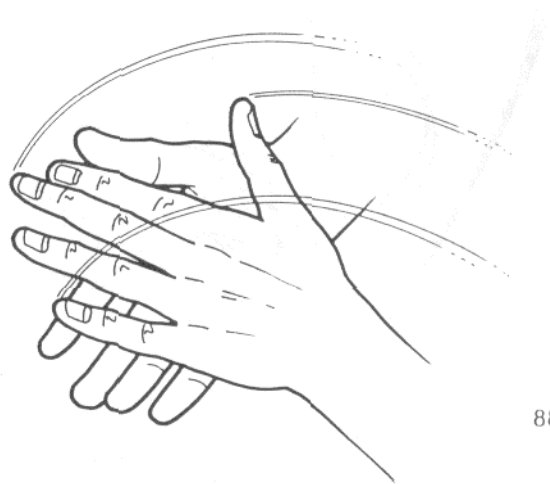

885

Hold the coin in your palm-up right hand between thumb, first, and second fingers. Your hand should be held comfortably close to your body, just above waist level (fig. 884). Move your thumb beneath the coin and flick it upward so it spins end over end as it flies. Say, "Call it - heads or tails?" Catch the falling coin on the center of your palm-up right hand and slap your left hand over it (fig. 885).

You're going to move your right hand out from beneath your left hand, raising it slightly to turn it palm down, and then slap it onto the back of your left hand. During your right hand's palm-down turn the coin will be tossed into your shirt.

In detail: Move your right hand to the right (fig. 886). Note that it already has started to turn over. Turn your hand over in a large to-the-left arc, passing in front of the shirt opening (fig. 887). That's when the coin is tossed - but since you're probably trying this slowly the first few times it won't work. You've got to do this quickly - the same speed that you would really perform the action at. Your right hand's over and down swing will impart enough motion to the coin to propel it between the flaps of your shirt. Obviously you must also practice a little so your aim is good!

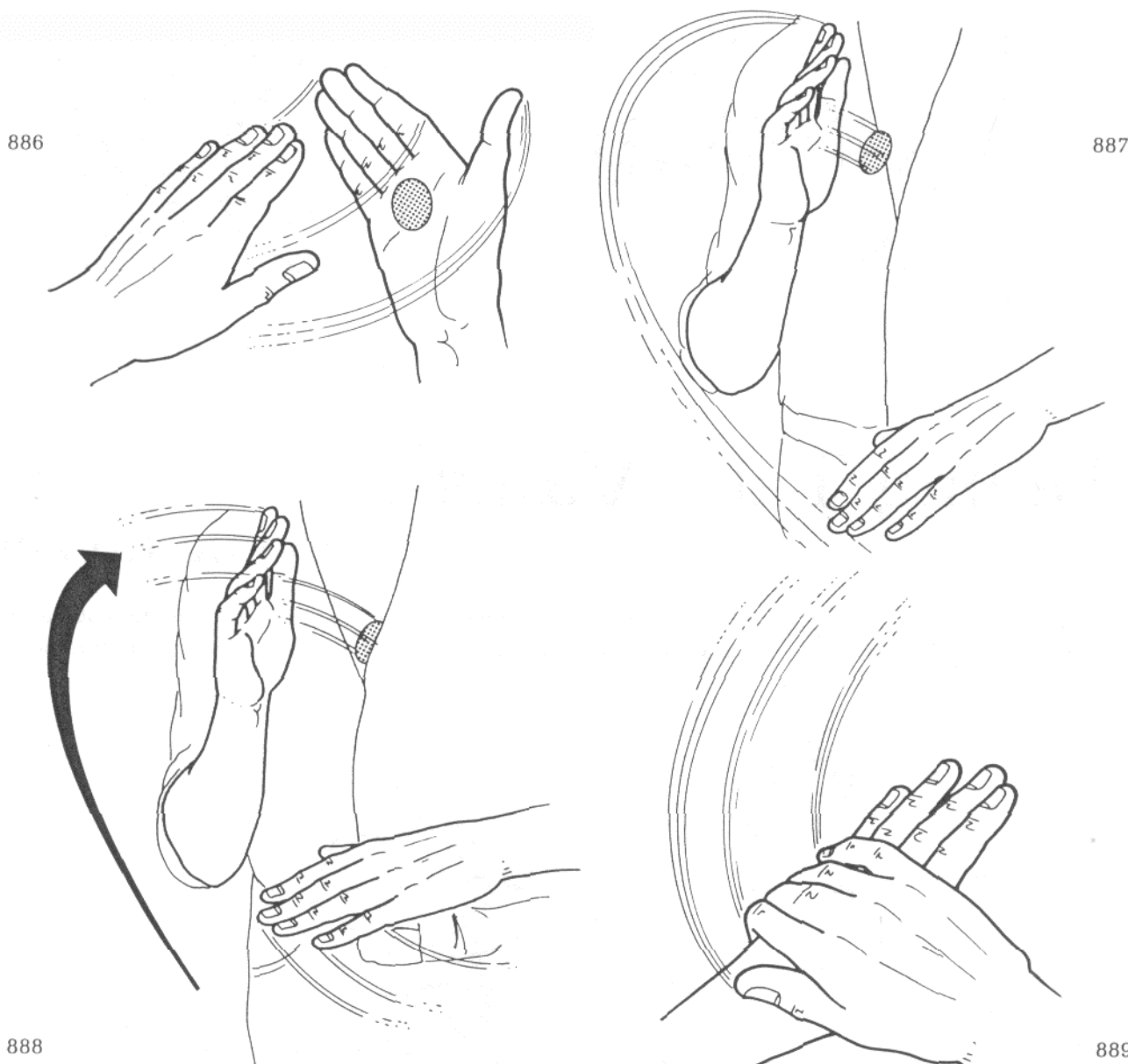

One other thing happens at the same time. Your left hand moves slightly closer to your body (fig. 888). That covers (if any is needed) the possibly illogical move of your right hand closer to the body. Actually your right hand moves so quickly that it won't be noticed.

To complete the action, slap your palm-down right hand onto the back of your left hand and pause for a moment (fig. 889). Lift your hand to reveal the vanish.

In Addition: Danny pointed out an important point in the way the right hand is held. Your fingers should be pointing toward the left at about a forty-five degree angle throughout the move, regardless of whether your right hand is palm up or down. That facilitates the secret toss, aiming the coin in the proper direction.

The Melting Coin

Les Shore

This is a very unusual item. It's a superior visual illusion where a borrowed quarter appears to melt (and drip!) away into nothingness. It's completely standup, requires no sleeving or lapping, and can be done impromptu once you prepare the matchbook.

First, get some magician's wax and a silver Crayola brand crayon. You must melt both and mix them together so you get a silvery wax that is also sticky. Mix up a batch of the stuff so you'll have plenty enough to do the routine at least fifty times. Take a very small piece, less than half the size of a dime, and roll it into a ball.

Take any booklet of paper matches and open it. Tear off about five matches on the right side and place the ball of wax onto the inner right corner of the outer flap (fig. 890). Close the book and put it into your pocket and you're ready to perform.

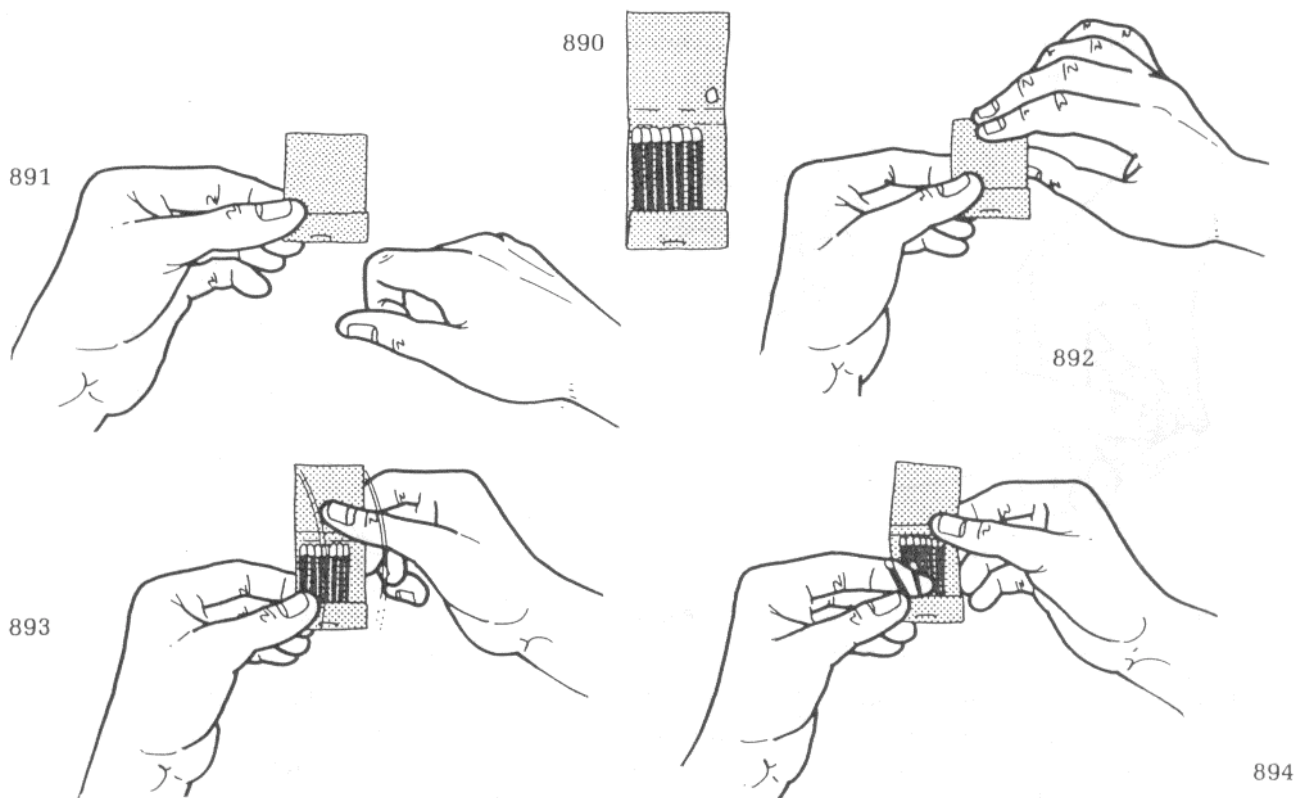

Borrow a quarter, look at it for a moment, and then hand it back to the spectator. Bring out the book of matches and hold its inner left corner between your left thumb and fingers (fig. 891). Turn your right hand palm down and insert your thumb into the side of the book (fig. 892). Using just your thumb, pop the cover open. Your thumb should naturally fall into position covering the wax (fig. 893).

Bend two matches upward with your left first finger and, at the same time, your thumb pulls the wax loose (fig. 894). Slide the wax to the right until it's clear of the book, and then move it beneath the book. At the same time your left hand begins to close the book, bending the cover so that it goes beneath the two vertical matches (fig. 895). Once the book is closed your right fingers press the wax lightly beneath the book so it sticks there.

Tear off one of the matches with your left hand and turn your right hand over, your fingers concealing the wax (fig. 896). Light the match with a downward stroke.

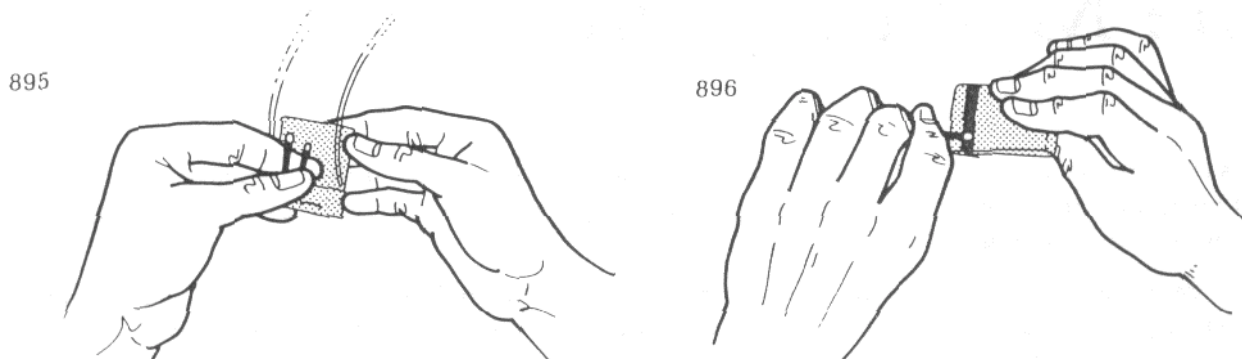

You're going to have to move quickly now, so don't actually light the matches the first time you try this. Once the match is lit turn your right hand palm up again. Ask the spectator to grasp the sides of the matchbook as in figure 897. When you leave the book in his hand pull the wax off and conceal it in your right fingers as you turn your hand palm down. Immediately pick up the quarter with your right hand and stick the wax onto its back, near the lower edge (fig. 898).

Once the spectator has a firm grip on the book, your left hand lights the vertical match still attached to the book with the one already lit (fig. 899). Blow out the loose match and discard it.

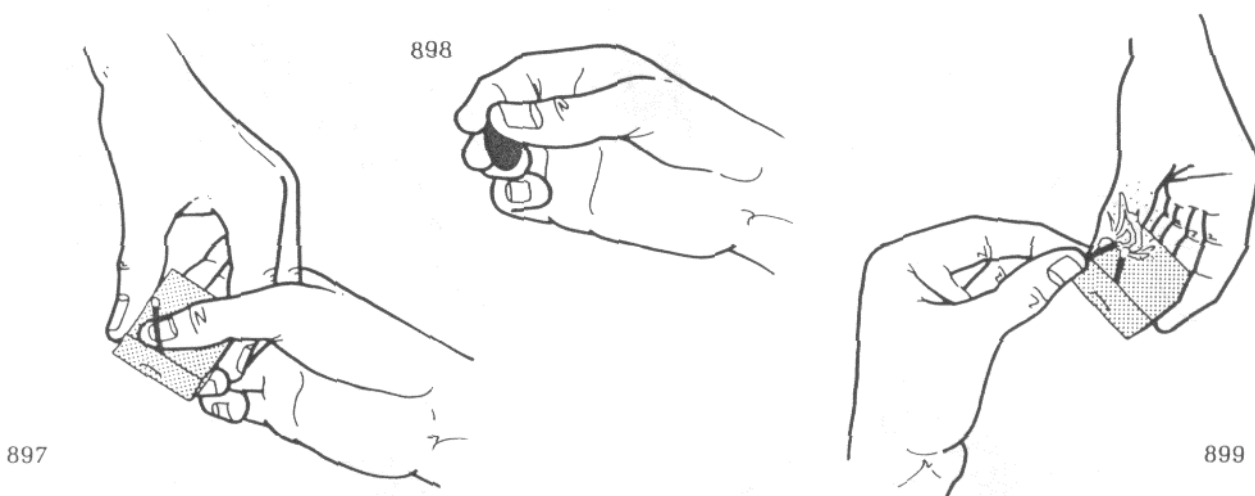

Your palm-down right hand lowers the end of the quarter with the wax on it over the flame - the wax will begin to melt and in a second or two a small drop of silver will drip onto the matchbook (fig. 900).

Do a fingertip-to-fingertip Retention Pass (already taught in Roth's Portable Hole, Part Three) apparently taking the coin with your left fingertips. Your right hand immediately moves to the matchbook at its right end, thumb above and fingers beneath, and takes it from the spectator. Press the quarter beneath it and it'll stick because of the warm wax. Wave it in small circular motions and tell the spectator to take the matchbook back and do the same thing beneath (well beneath!) your left hand. Of course when he takes the matchbook back it should be the same way he gripped it before so he won't feel the quarter beneath it.

Once he's waved it beneath your left fingers a few times blow out the match and wait until some of the smoke rises and reaches your fingers. At that moment open them with a crumpling motion (fig. 901).

Tear off the burned match and stick the book in your pocket. Make sure you offer to reimburse the spectator!

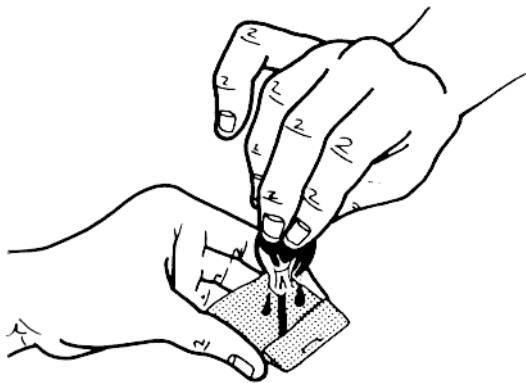

900

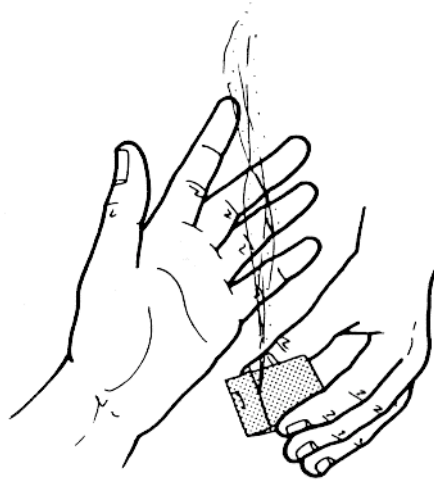

901

Shuttle Pass No. 2

Friedhoffer

This is another handling of the Shuttle Pass, and it's based on Howie Schwarzman's method which appeared in Bobo. It's a bit simpler than the Roth handling, but not as versatile.

One coin rests in palm-up finger palm in your left hand; the coin to be switched in is clipped between your right first and second fingers (fig. 902). Your right hand is held palm down, relaxed, a few inches away from your left hand.

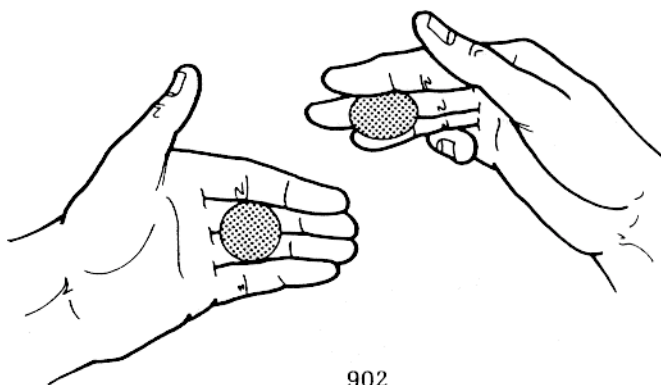

902

Your hands come together, your right thumb moving onto the coin in your left hand (fig. 903). Your right first and second fingertips shield this from the front. Without pausing your thumb moves to the right of the concealed coin. Both hands now move simultaneously: your left hand turns palm down while your right hand turns palm up. As your right hand turns your thumb pushes the clipped coin upward into view (fig. 904).

Continue turning until your right hand is completely palm up and your left hand is completely palm down. Your left thumb and fingers grasp the coin (fig. 905). Separate your hands, keeping your left hand palm down (the coin in finger palm concealed from the audience).

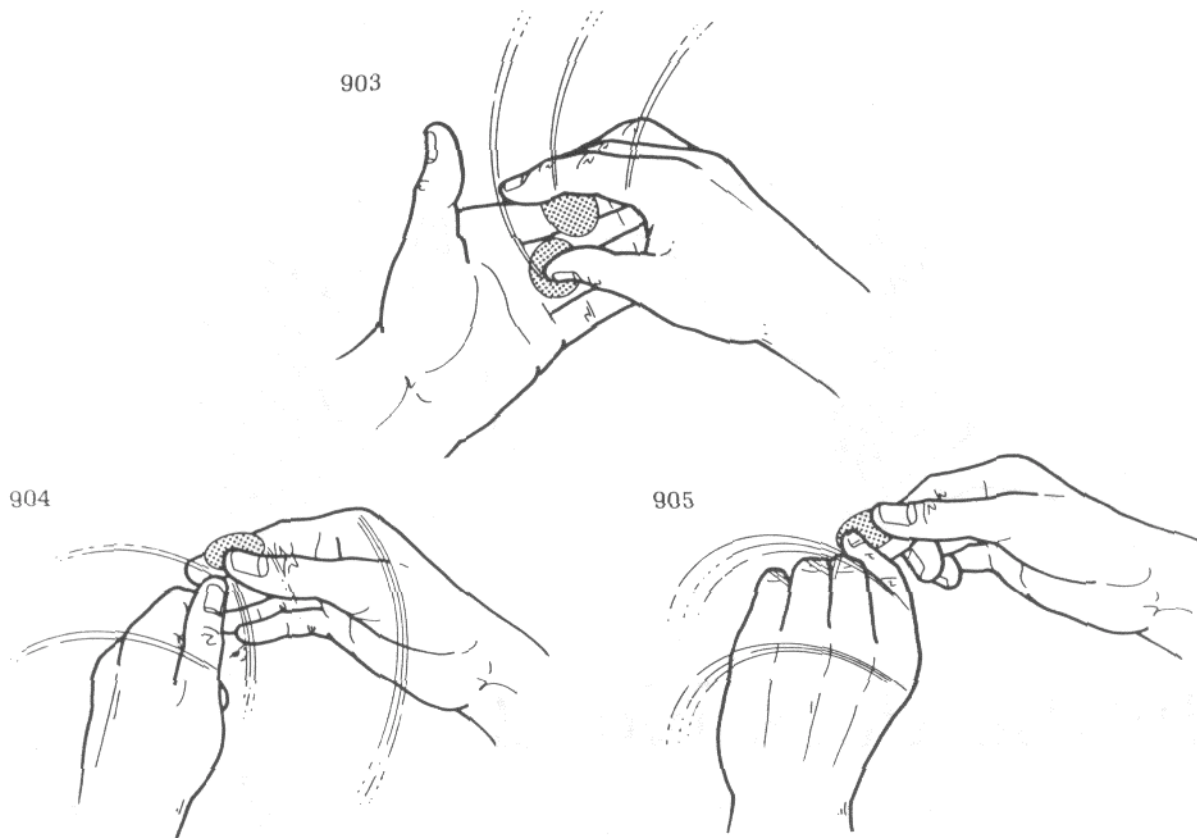

The Panda's Purse

David Arthur

By using principles of David Roth's (from his Okito box work and The Purse and Glass routine) David Arthur has put together this excellent routine with four coins and a purse. It's impromptu, can be done standing (though you need a table to work on), and uses only four coins and the purse. Place the coins into the purse before you begin.

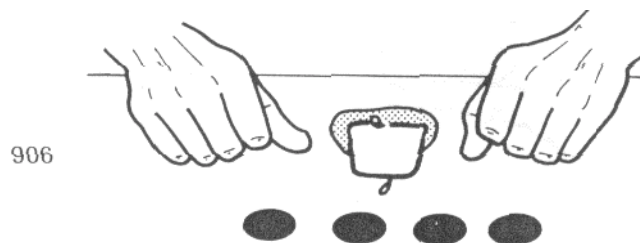

To perform, open the purse and dump the coins onto the table. Arrange them in a horizontal row and place the open purse just behind them, mouth toward audience (fig. 906). Your right hand turns palm down and picks up the coins from left to right, stacking them as it goes. Do the Roth technique for Classic Palming One Coin of a Group and turn your hand palm up afterward to display the coins. Do the Latta

technique for Classic Palming Two Coins of a Group, dragging a second coin over the one already in classic palm. (These techniques are explained in detail in the Roth and Latta sections.) When you turn your hand palm down two coins will be retained in classic palm and two will fall onto the insides of your fingers.

Both hands move simultaneously. Your left hand picks up the purse and holds it between thumb and fingers inside your hand, opening (mouth) upward. Your right thumb moves onto the uppermost of the two coins resting on your fingers and pushes it toward your first finger (fig. 907). Raise your right hand turning it palm toward you so that it's directly over the open purse (fig. 908).

Without pausing your right hand descends, to apparently place all four coins into the purse. Guide the lower coin into the purse, pressing it against the inner part of the frame (fig. 909). Your right thumb will be able to guide the upper coin behind the purse as your hand descends (fig. 910). Move your hand downward until the coin is completely hidden behind the purse and snap it shut (fig. 911). You may find this easier to do if you lift your right pinky so that your fingers are able to get inside the purse with less effort. It's a quick thing, so practice it until you've worked up some speed. It must appear as if you've placed the coins into the purse.

907

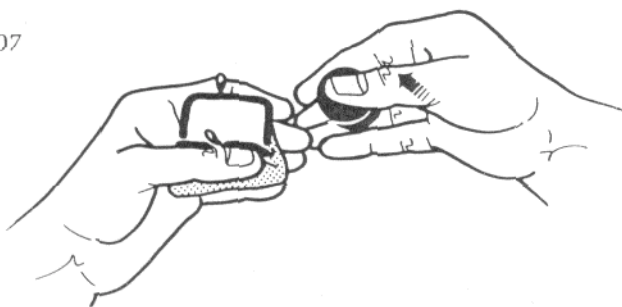

908

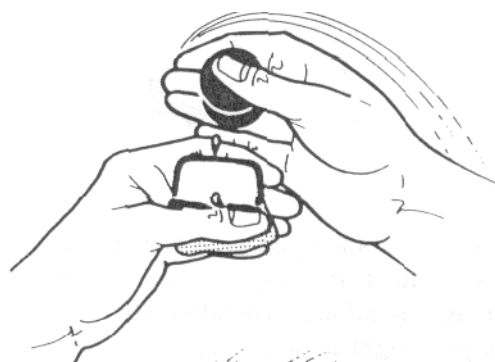

909

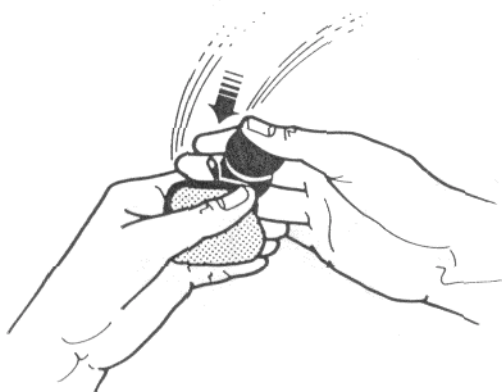

910

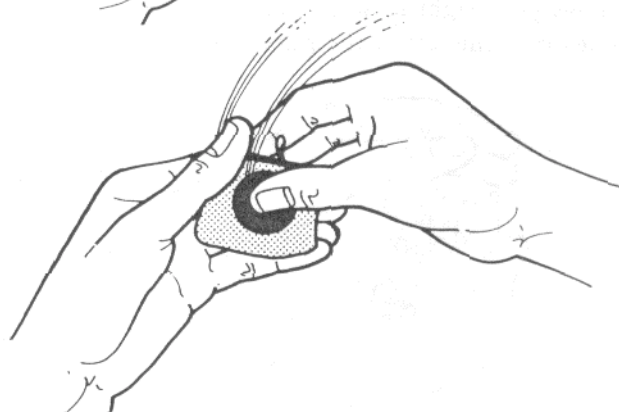

911

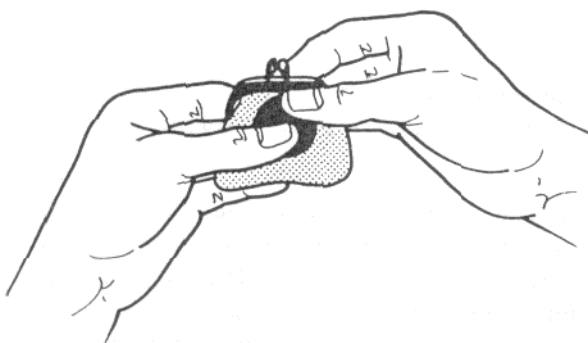

912

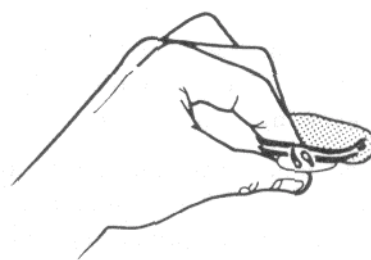

Your left hand takes the purse and places it onto the table with the coin hidden beneath it (fig. 912). The situation is two coins classic palmed in your right hand, one coin in the purse, and one coin hidden beneath it. As your left hand lays the purse down your right hand settles to the table in a relaxed fist,

The First Coin

Your right hand pretends to pluck a coin from the purse, remaining about two inches above it. At the same time your left hand turns palm up, fingers spread (fig. 913). Move your right hand over your left hand, slightly curling your left fingers around the back of your right hand (fig. 914). As you ostensibly place the invisible coin you've taken from the purse onto your left palm relax your right palm and allow one of the classic palmed coins to fall into your left hand (fig. 915). This is hidden from the audience by your left fingers. Without pausing move your right hand away, closing your left fingers into a fist.



913

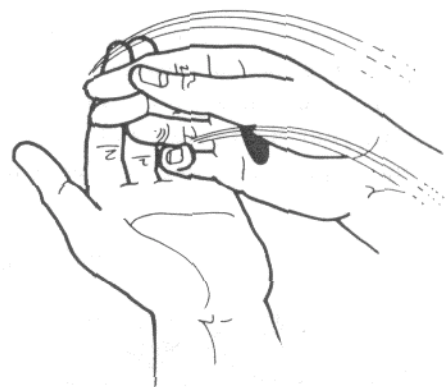

914

Pause for a second and open your left fingers revealing the coin. Push it to finger palm with your left thumb and do a Shuttle Pass, apparently taking it with your right hand, (Actually the coin that's in classic palm in your right hand is substituted while the original coin remains in left-hand finger palm.) After the Shuttle Pass your right hand places the visible coin between your left thumb and fingers, and your left hand tables it to the left of the purse (fig. 916).

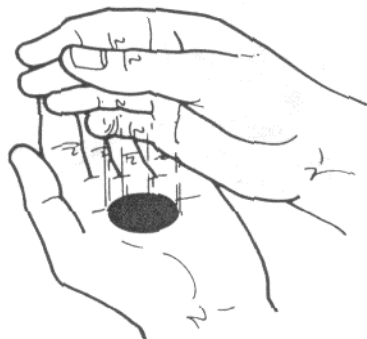

915

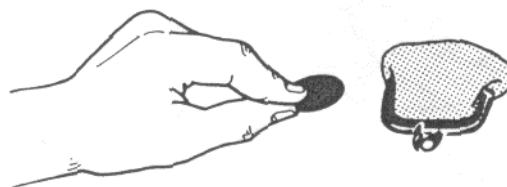

916

The Second Coin

You've already done the work for this one. Simply close your left hand into a palm-up fist. Show your right hand empty and pretend to pluck another coin from above the purse. Toss it toward your left hand, which opens revealing another coin.

Turn your left hand over and pick up the coin that's lying beside the purse (the just-produced coin remaining in finger palm). Turn your left hand palm up and pull the coin that you've just picked up onto the coin in finger palm, overlapping it, spread inward (fig. 917). This application of Han Ping Chien is from David Roth's Purse and Glass routine. Your palm-down right hand grasps the purse between thumb (beneath - holding the hidden coin) and first and second fingers (above) (fig. 918). Lift it, holding it broadside toward audience just above the table. Raise your left hand and say, "Two coins have already jumped out. . . ." Lower your left hand and turn it palm down beside the purse. As you do your right hand

raises the purse, your right thumb releasing the hidden coin. It falls to the table and coalesces with the single coin that falls from your left hand (one remains in finger palm) (fig. 919). Finish the sentence, "11 . . . and two are left in the purse." You have to time the move so it appears that your left hand just dumps its coins onto the table.

917

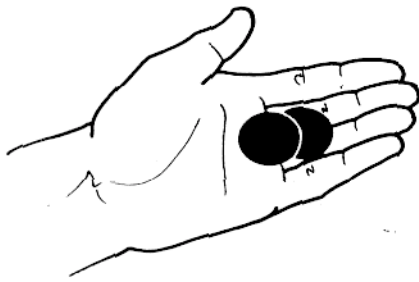

918

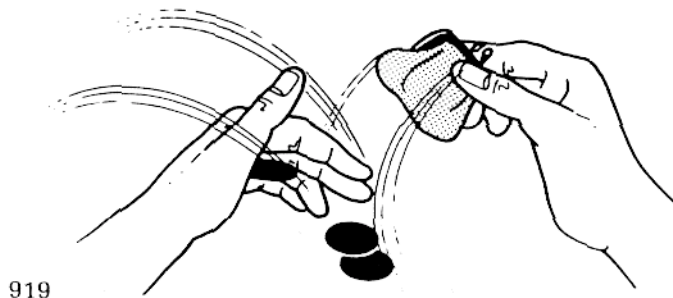
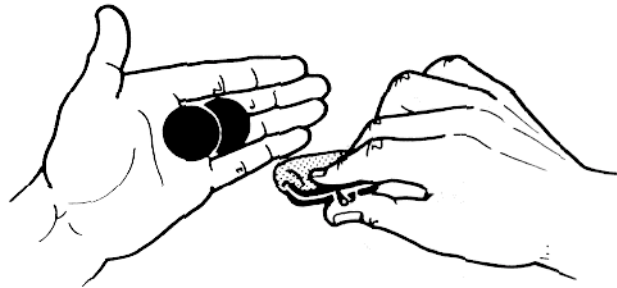

919

The Third Coin

Your right hand tables the purse to the right of the two coins. Close your left hand into a fist and turn it palm up. Pretend to pluck another coin from the purse and toss it toward your left hand. Open your left fingers to reveal another coin. Place it onto the table with the two coins already there.

The Fourth Coin

Show your hands empty. Pick up the purse and open it, removing the coin that's inside with your right hand. Your left hand holds the open purse inside it between thumb and fingers. Your right hand displays the coin, which rests directly over the inner portion of your second finger (fig. 920). Move your right hand in front of your left hand so your right third finger hugs your left first finger (fig. 921).

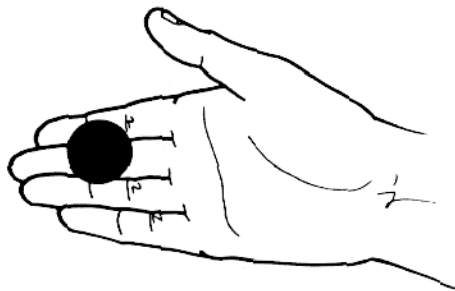

920

As you turn your right hand palm down your third finger moves above the inner edge of the coin and then straightens, clipping it between your second and third fingers (fig. 922). When your hand is palm down the coin actually dangles in the purse for a moment (as shown in the illustration). Turn your right palm toward you keeping your right pinky pressed against your left first finger so the audience cannot see between your hands (fig. 923).

Your left thumb closes the purse a bit, just enough so that your right hand can lower the coin behind it (fig. 924). Move your right thumb onto the coin and hold it against the back of the purse, sliding it to center (fig. 925). Turn your right hand palm up and grasp the purse from beneath between thumb and fingers (fig. 926).

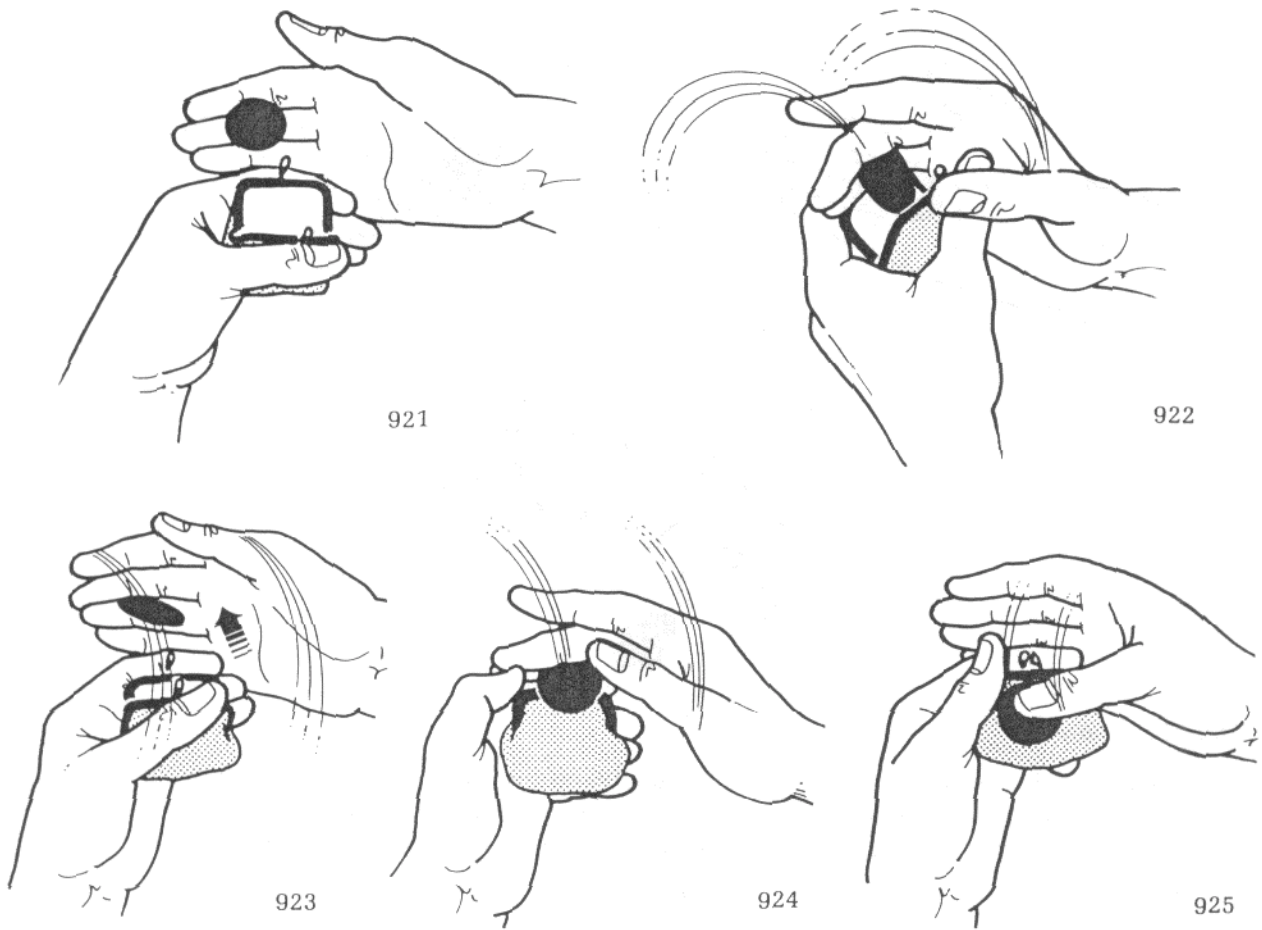

Your left hand grasps the left end of the purse and, as it lifts it taking it to the left, your right thumb pulls the coin behind your right fingers (fig. 927). Your right hand settles into a relaxed fist with the coin in fingertip rest as your left hand tables the purse to the right of the three visible coins.

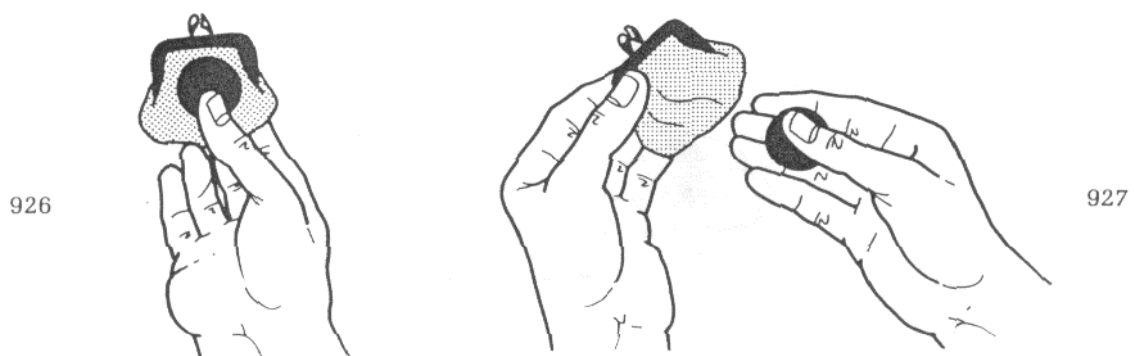

Pickup one of the coins with your left hand and maneuver it into palm up finger palm. Do a Shuttle Pass, apparently taking it with your right hand. Your left fingers lift another coin and place it beside the one already held between your right thumb and fingers. Pickup the remaining coin and display it (fig. 928). Turn both hands palm down and place the coins on either side of the purse (fig. 929).

Close your left hand into a palm-up fist. Pretend to pluck the last coin from the purse with your right hand and toss it toward your left hand. Open your left fingers to reveal the final coin. Drop it onto the table to the left of the purse - everything can be examined.

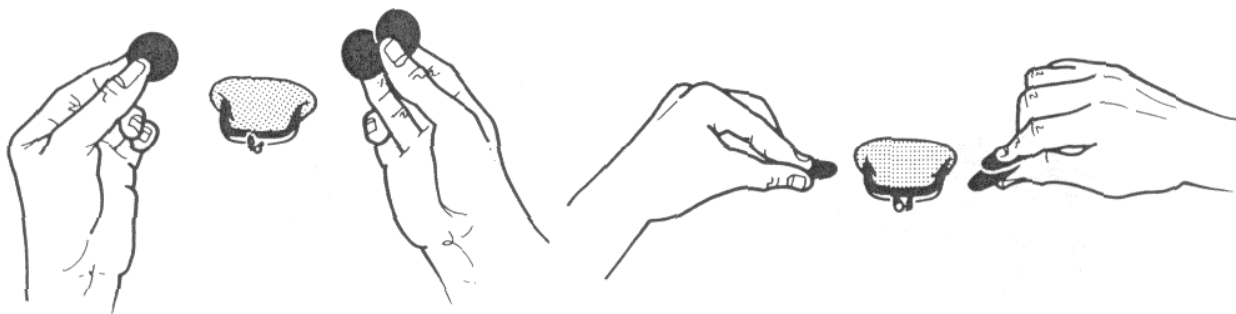

928

929

Melifluous Meld

David Arthur

David has an unusual method for visibly melding two quarters into a half dollar. To prepare, finger palm a half dollar in your left hand. Borrow two quarters from a spectator.

Hold the borrowed quarters between the thumb, first, and second fingers of each hand (fig. 930). Your hands are almost palm up - or, at least as much as possible without exposing the finger palmed half dollar. Move the right-hand quarter over your left palm in Retention Pass position (fig. 931). Do the move, your left second, third, and pinky fingers closing over the coin for so it appears).

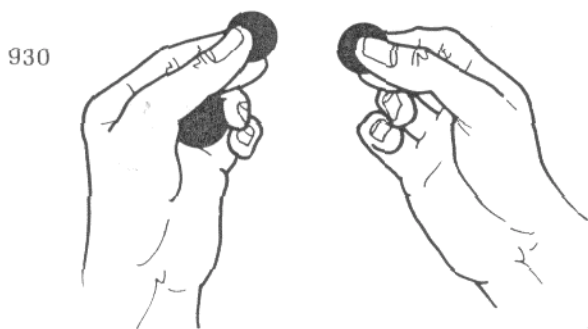

930

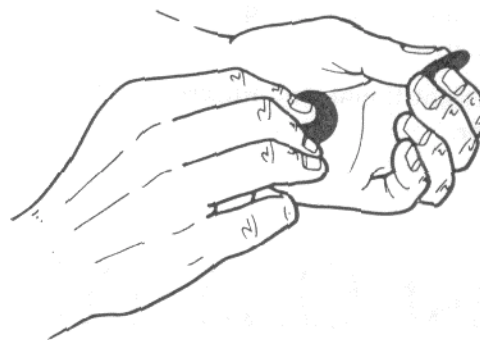

931

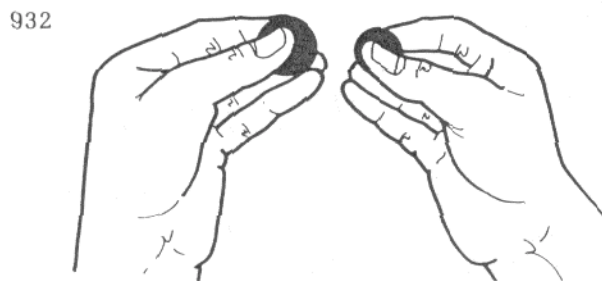

932

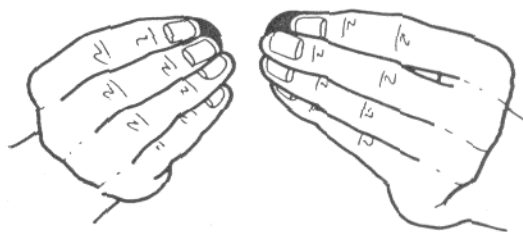

933

Your right hand classic palms the quarter as it moves away. It returns to take the quarter from your left hand. Both hands close into palm-down fists. The just-taken quarter is in right-hand fingertip rest. Ask the spectator how many quarters you have in each hand. No matter what he says turn both hands palm up and move your thumbs inside: your right thumb pushes the quarter from fingertip rest into view past your

fingertips, your left thumb pushes a tiny bit of the half dollar's edge into view (fig. 932 is your view; fig. 933 is the audience view). Say, "One in each hand."

The right-hand quarter is held by your thumb, first, second, and third fingers. Bend your right hand back at the wrist (fig. 934). Swing it forward snapping its quarter against the inside of the half dollar with a clink (fig. 935). Repeat this again.

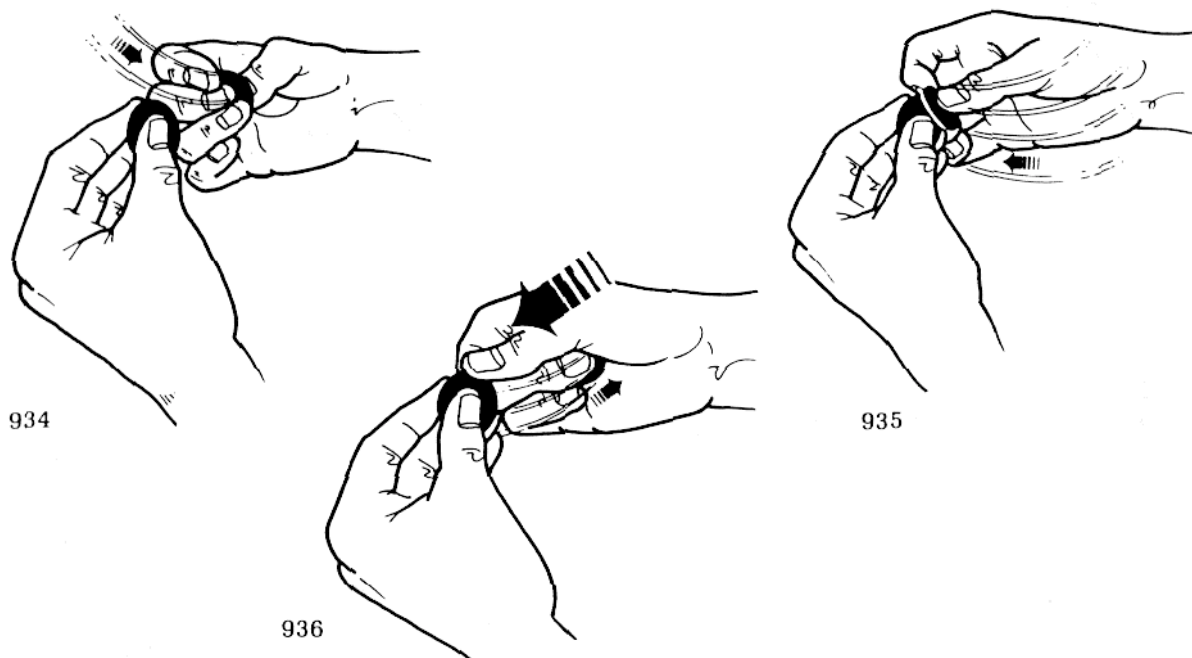

Start to do it a third time (by this time you should have established a beat and rhythm) but, as your right hand swings forward to clink the coins, your third finger snaps the quarter inward into classic palm (fig. 936). Your first and second fingers move forward to the half dollar as if they held the quarter. The moving quarter should strike the quarter already in classic palm at the exact moment that it would've struck the half dollar.

Your right thumb and fingers grab the half dollar and turn it over a few times before handing it to a spectator.

Last One Through

David Arthur

This is how David applies Geoffrey Latta's second handling of Han Ping Chien to the last coin in a Coins Through the Table routine. Let's assume that you're seated at a table opposite the audience and that you've already made the first three coins pass through the table (they're moving from your left hand, which is above the table, to your right hand, which is beneath). Your palm-up left hand holds a single coin, your palm-down right hand holds the other three coins from above between thumb, first, and second fingers (fig. 937). Your right hand is close to the table, the bottom of the lowest coin almost touching it. Your left hand is above it and to the left.

Move your right hand toward you until it passes the table edge. Simultaneously relax your thumb and fingers a bit so the bottom coin drops into your lap (fig. 938). This happens as soon as the stack is beyond the table edge - there's no pause. Your right hand immediately begins moving away from you, the opposite way, over the table again. When it passes your left hand both hands move forward together (fig. 939).

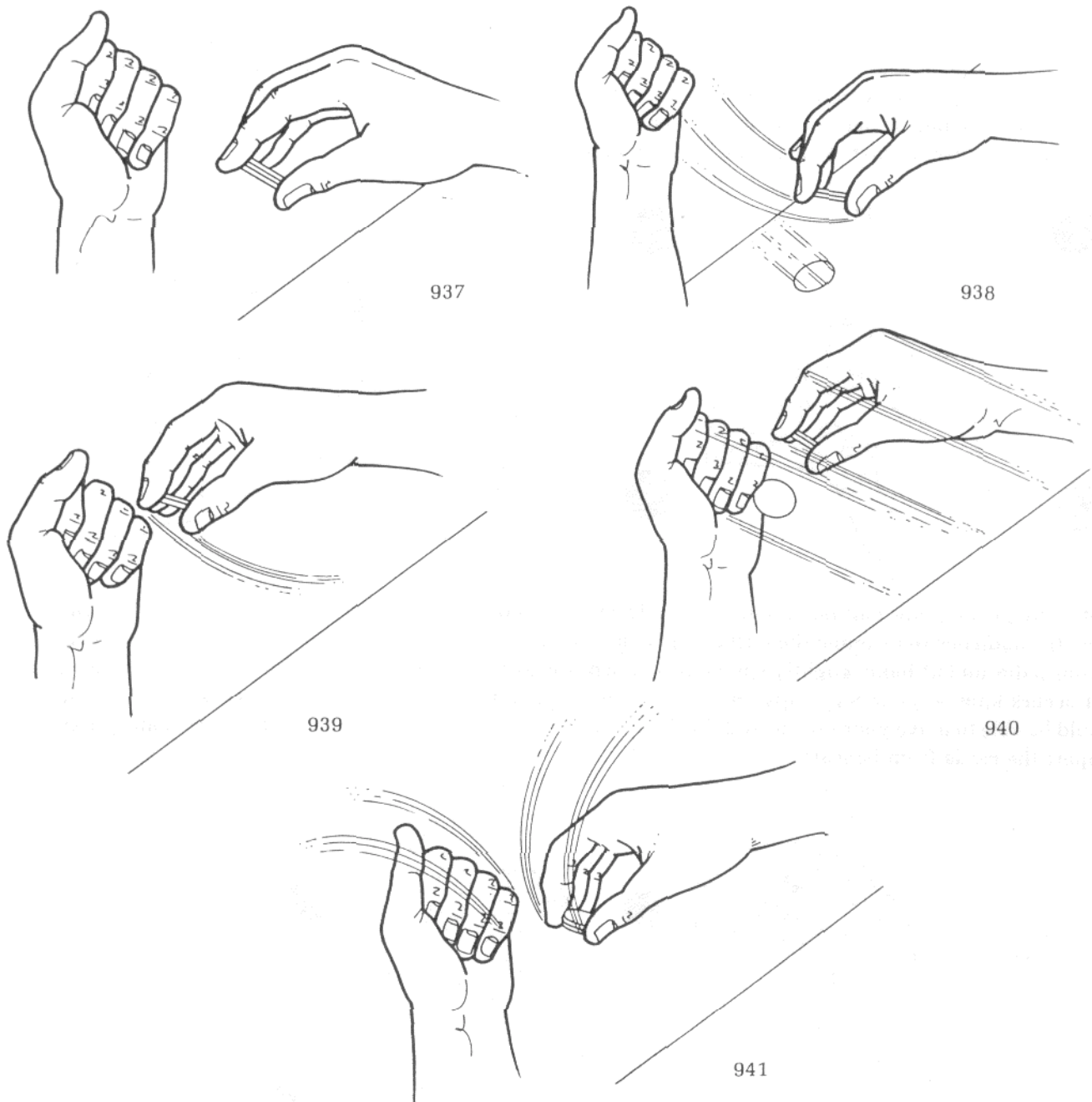

As they move relax your left pinky and allow the coin to slide out. It'll fly forward as it falls because of your left hand's momentum (fig. 940). You've got to aim carefully here because the falling coin must land beneath the two coins in your right hand (fig. 941).

Your right hand immediately lifts all three coins and spreads them for the spectators to see. Take them beneath the table picking up the lapped coin on the way. Show your left hand empty and bring your right hand up with four coins to end.

SeeSaw'Sembly

David Arthur

Paul Gertner gets credit for the basic premise - where four coins assemble and then immediately jump back to the four positions from which they started (see Apocalypse Vol. 2 No. 11). Paul's method uses six coins and an expanded shell - David's uses only four coins. There is no preparation, though you must be working on a close-up mat. You can be either standing or sitting.

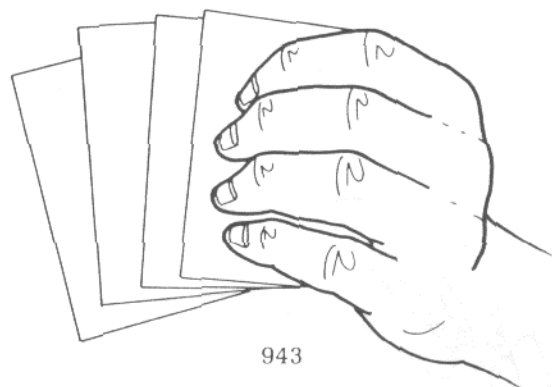
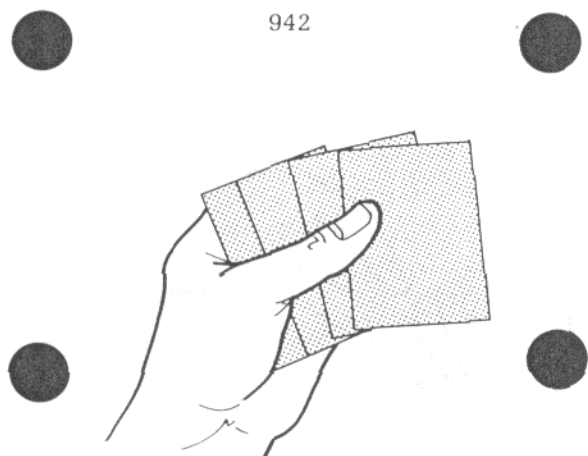

Start by placing four half dollars in a square formation on the mat. Take any four cards from a deck and allow the audience to examine them (they can examine the coins, too). Take the cards back and hold them in your palm-up left hand, slightly spread face down (fig. 942). The grip is important because of the steal that occurs later - your fingertips rest on the face of the bottom card (fig. 943 is an exposed view). You should be able to move your second and third fingers and straighten them while your first finger and pinky support the cards from beneath.

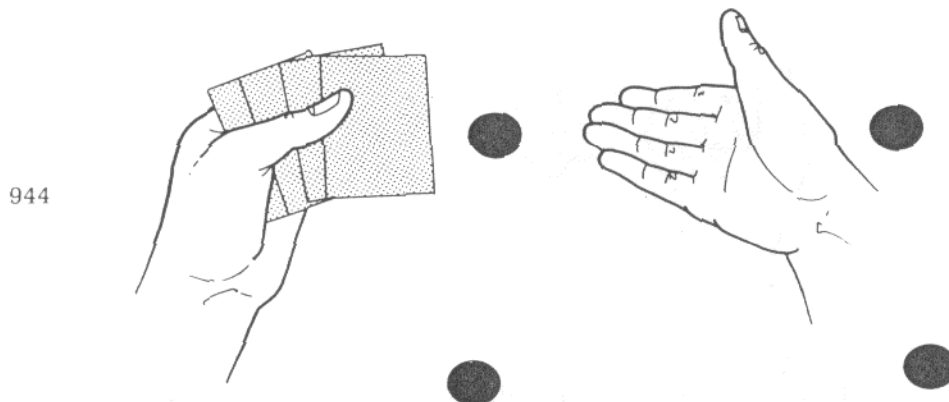

Move your hands toward the coin at the outer left, pausing when each hand is about two inches from the coin (fig. 944). A couple of things are going to happen rather quickly. Start moving your hands together so they're just above the table. You've got to time things so that your right second fingertip is near the coin when the right long side of the fan hest - to - t he-right card is about to cover the coin (fig. 945).

As your left hand moves to the right to cover the coin your right second fingertip snaps to the left, straightening and kicking the coin to the left (fig. 946). With a bit of practice you'll be able to kick the coin right between your second and third fingertips (fig. 947). Your third finger moves onto the coin's inner edge and presses downward, tilting its outer end upward so your second finger can slip beneath it (fig. 948). Press these fingers together, clipping the coin between them.

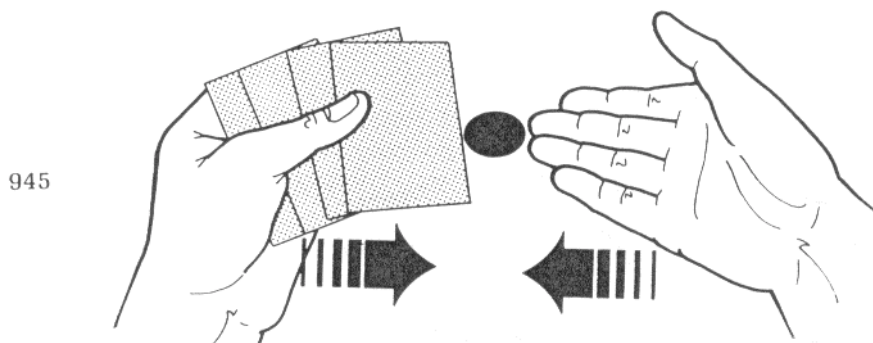

There's more. A second after your right finger kicks the coin your thumb and fingers grasp the uppermost card. Your left hand moves to left with the stolen coin beneath the three cards it still holds (fig. 949). Table the right-hand card.

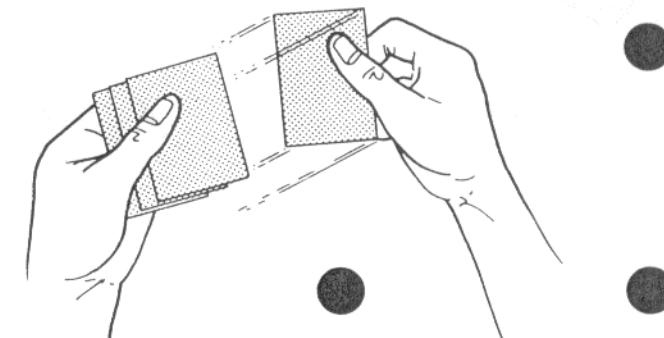
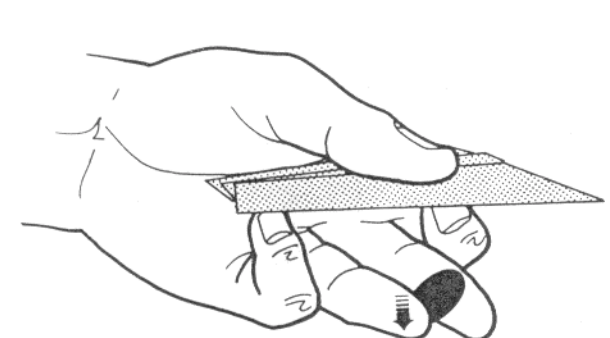
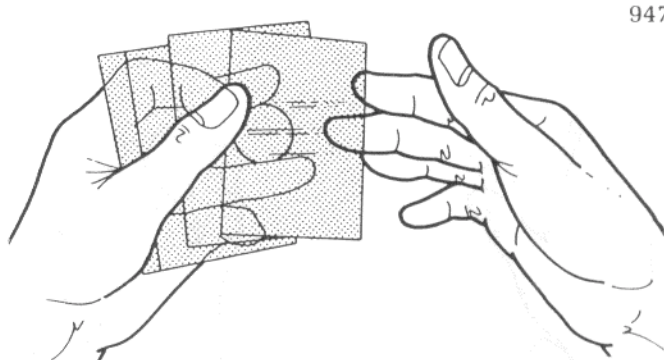
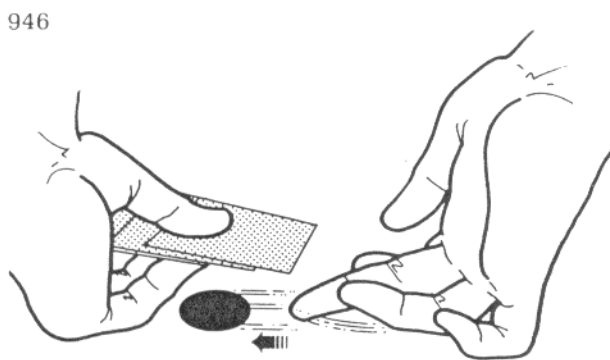

The point of all this detailed technique is to avoid the common faults of this type of move. It often looks like your left hand moves over the coin (having moved too far to the right) and then moves back again before your right hand covers the coin with the card. There's usually some kind of tip off in the left hand's movement. David's move looks exactly as it should - your left fingers appear to be nowhere near the tabled coin (and they aren't!). There's no back and forth movement of the left hand, either.

That's the basic steal, and it'll be used again later in the reverse assembly sequence. To continue, your right hand moves back to your left hand to take the next card. It approaches palm up, finger straight and together. Your thumb moves onto the back of the top card while your fingers move beneath your left fingers (fig. 950). By relaxing your left second and third fingers the coin will fall flatly onto your right fingers. Your right thumb draws the top card to the right and, as your right hand moves away, the card moves over the stolen coin, covering it. Place that loaded card onto the coin at the outer right, being careful not to let the coins clink.

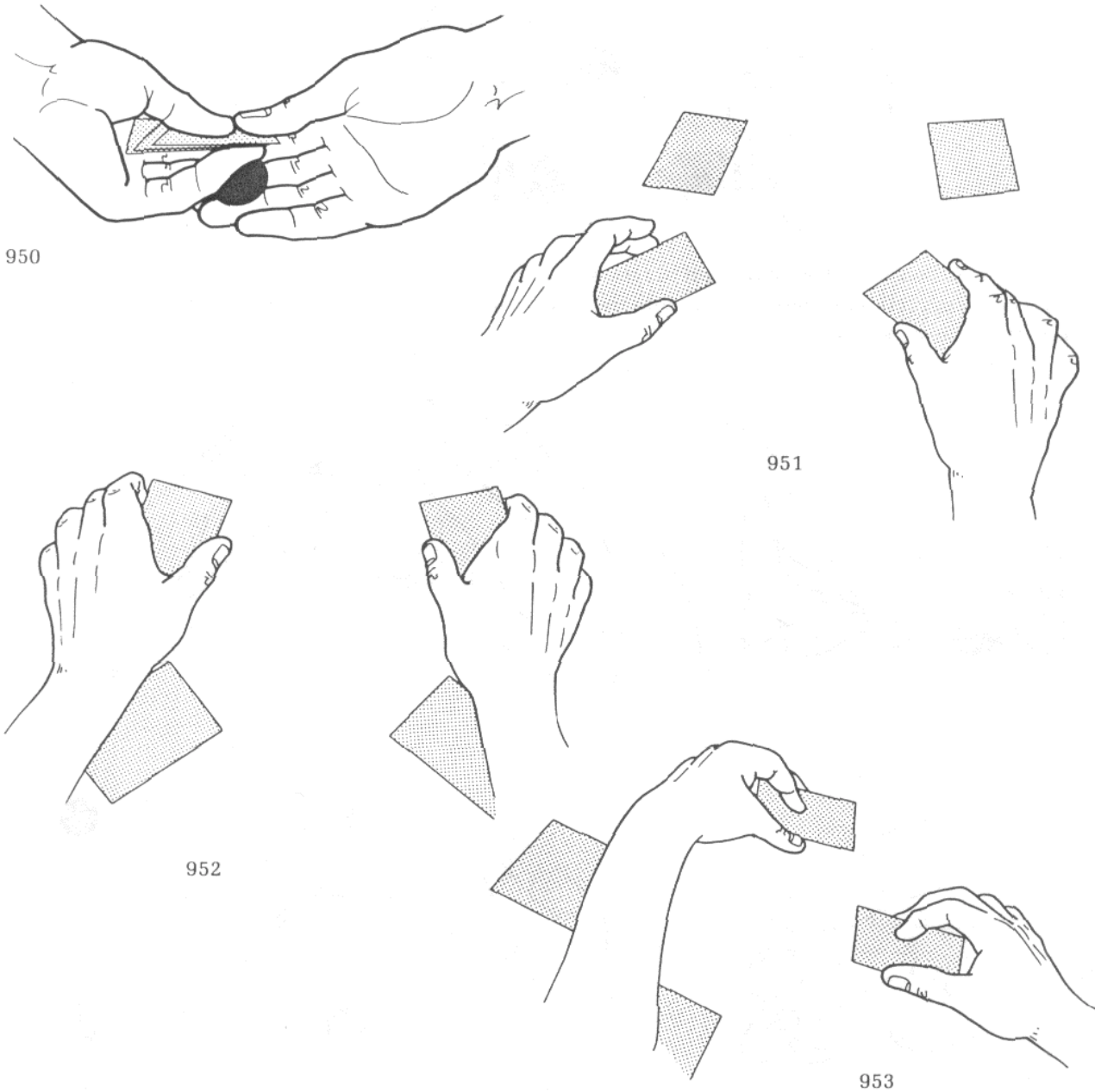

Take one of the remaining cards in each hand and place them onto the coins at the inner corners, angled toward the center (fig. 951). Your palm-down hands approach the outer cards, your thumbs moving onto their inner sides and your fingers onto their outer sides (fig. 952). Turn your hands, angling the cards to match the inner two. As you do you'll find that your right thumb will contact the secretly loaded coin beneath the outer right card and push it. That's okay - you're positioning it for the Pickup Move.

Relax your hands, letting go of everything and patter about the four coins under the four cards, etc. Move your right hand to the card at the inner right and your left hand to the card at the outer right, grasping the cards as you would for the Pickup Move (which I'll describe, and you'll do, in a moment) (fig. 953). Lift both hands, your left hand doing the Pickup Move so that only one coin is seen beneath its card. Like this. The card is grasped between your thumb (on the inner long side) and second finger (on the outer long side), with your first fingertip resting lightly on top - directly above the coin (fig. 954). Slide your hand away from you until your thumbtip feels the coin hitting it and, as soon as you do, lift the card's inner side. The coin will come with it, held between your thumb and first finger (fig. 955). Lift the card off the table and allow its outer long side to snap off your second finger (fig. 956). All of this is done in one smooth motion. Note that your left thumb is parallel to the card's long side - that'll become important later on. The position is slightly different from Al Schneider's original handling.

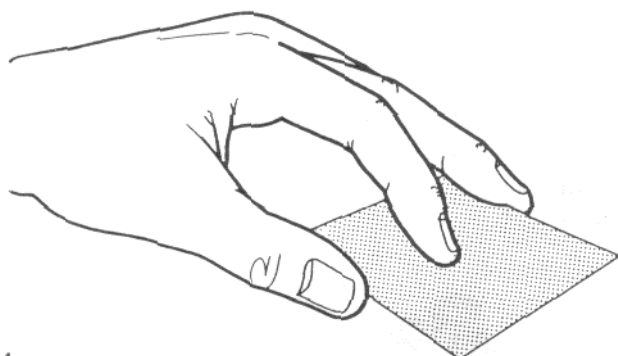

954

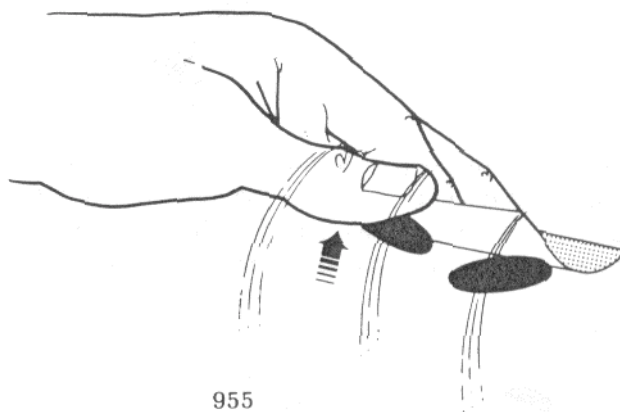

955

Okay - at the same time that your left hand does the Pickup Move with the outer-right card, your right hand lifts the inner right card. Replace both cards. Snap your fingers and, with the same hands as before, pick up the same cards again. This time your right hand does the Pickup Move and your left hand does not (fig. 957). Two coins appear beneath the card at the outer right, while none appear beneath the card at the inner right.

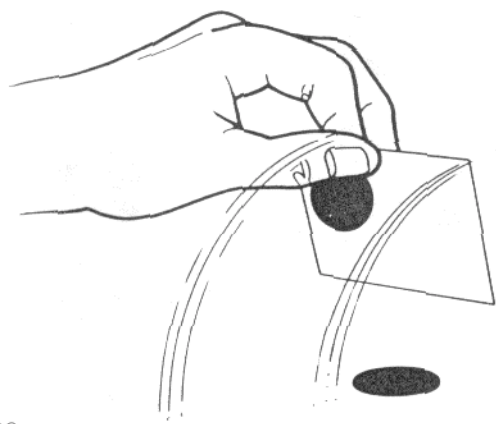

956

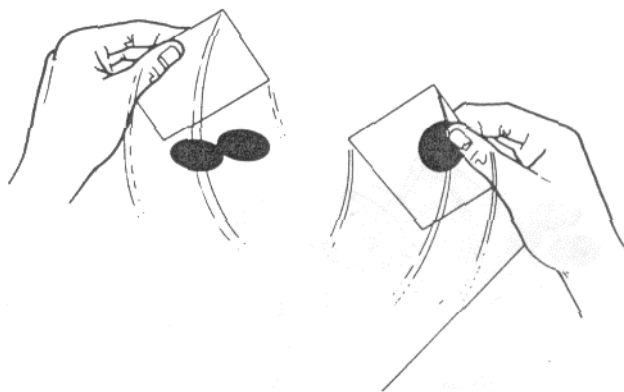

957

Lay the left-hand card onto the inner-left card and lift both, a coin seen beneath (fig. 958). Place both cards on top of that coin. At the same time your right hand covers the two cards at the outer right. There are now three coins beneath the outer-right card.

Snap your fingers. Simultaneously your left hand does the Pickup Move with the inner left cards, and your right hand lifts the outer-right card (fig. 959). Three coins are at the outer right and none at the inner left.

Say, "That leaves one coin under here." Your left hand descends to just above the table and guides the outer left corners of its cards beneath the center of the outer-left card (fig. 960). Your left thumb holds the concealed coin firmly against the face of the bottom card. As soon as they're able, your left second, third,

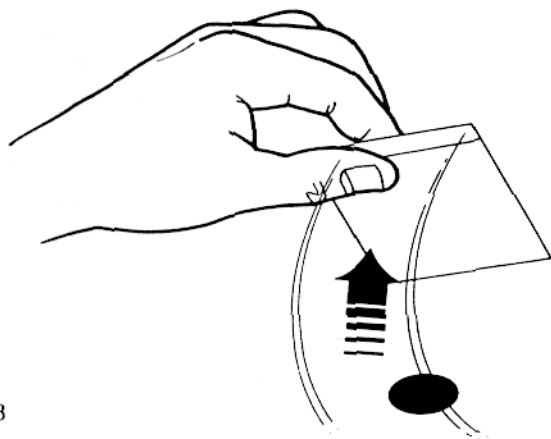

958

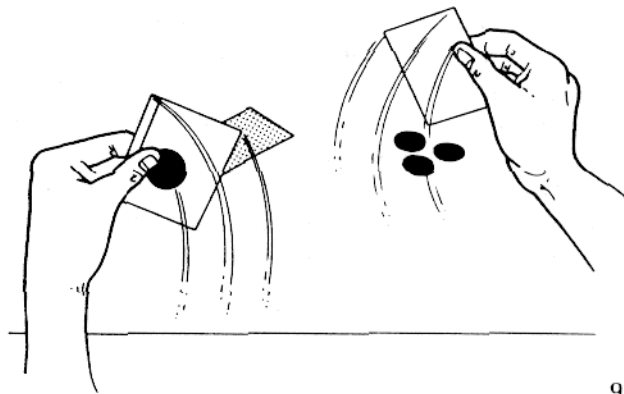

959

and pinky fingers pull the outer-left card flush with the lower cards (fig. 961). Your left hand continues to slide until it's exactly where the outer-left card originally was. Raise your hand leaving the coin on the table (fig. 962). It appears as if you've lifted the cards to display the coin. (The move is based on an item of Frank Paglia's which appears in Apocalypse Vol. 1 No. 8).

960

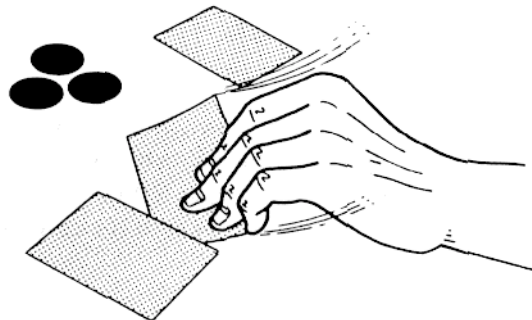

961

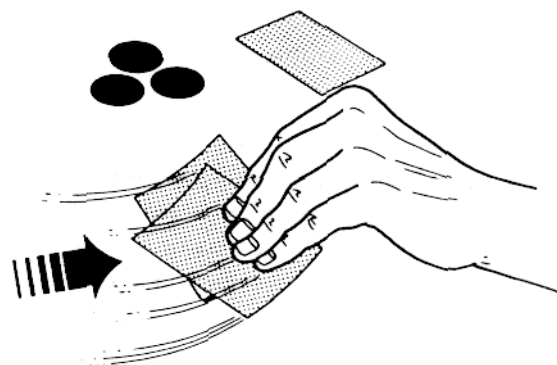

962

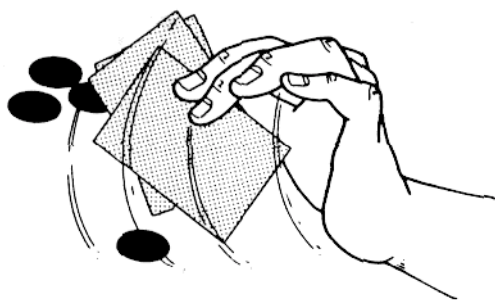

963

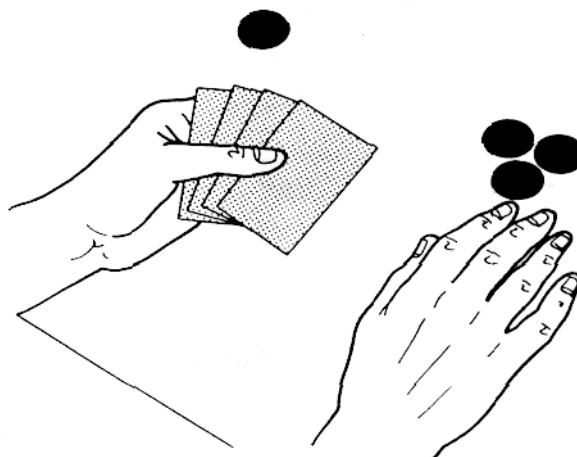

Place all four cards together and hold them in face-down dealing position in your left hand. Say, "The last coin is the most difficult - it'll jump from here (indicate the outer left) to here (indicate the outer right and, as you do, casually arrange the coins as in figure 963 with your right fingers)."

Spread the cards in your left hand in preparation for the basic steal that you used to start the routine. Move your hands over the single coin at the outer left and cover it, simulating the steal, but not actually doing the move. One card is left over that coin. Move your hands over the coins at outer right in position for

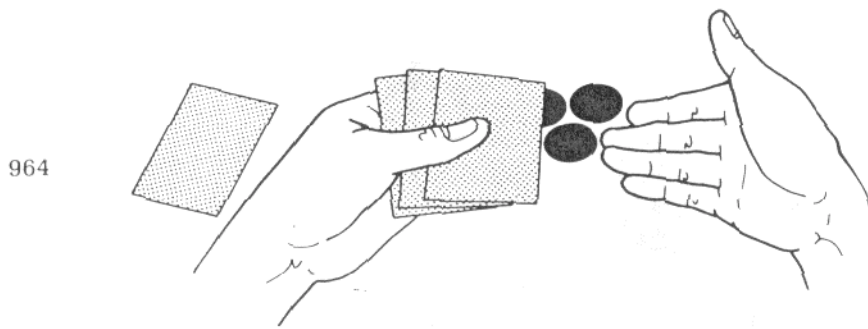

the steal with the innermost coin (fig. 964). Do the move, your left hand moving away with the coin and two cards as your right hand covers the two (thought to be three) coins there (fig. 965). Note that the outer edges of the two coins are left sticking out from beneath the card.

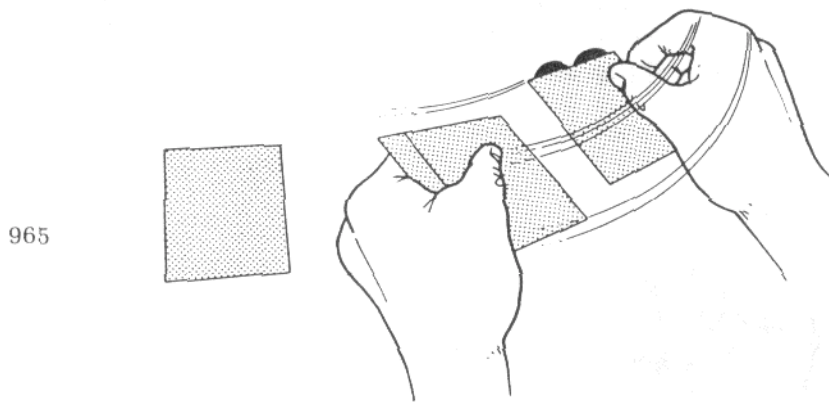

Your right hand takes the upper card and places it at the inner right, while your left hand takes the lower card (with the coin hidden beneath it) and places it at the inner left. The inner cards are angled as before.

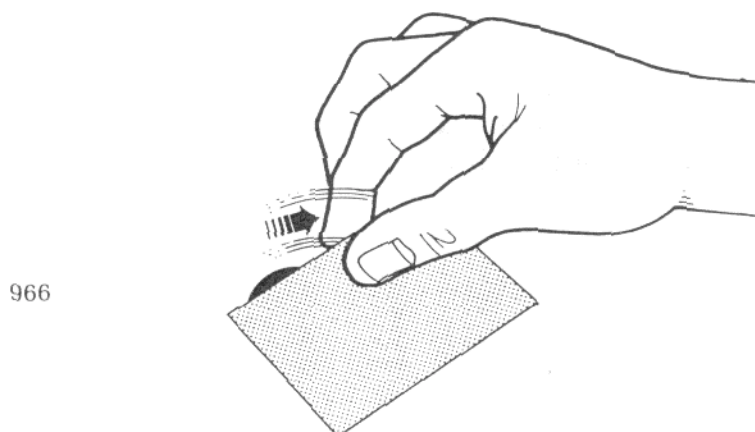

Angle the outer cards as well, your right hand pushing the coin on the right (sticking out from beneath the outer-right card) back a bit (fig. 966).

Your left hand lifts the outer-left card showing a coin beneath it as you say, "This coin will jump over and join the other three." Immediately slide the card forward again covering the coin,

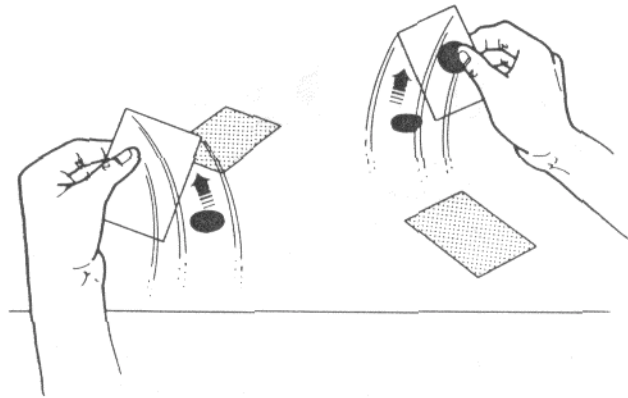

967

Snap your fingers and say, "Oops, I think it backfired." As you speak your left hand grasps the inner-left card and your right fingers grasp the outer-right card. Both hands pick up their cards at the same time your right hand slides its forward until the inner coin hits your thumb and immediately does the Pickup Move, your left hand simply lifts its card (fig. 967). One coin is seen beneath each card.

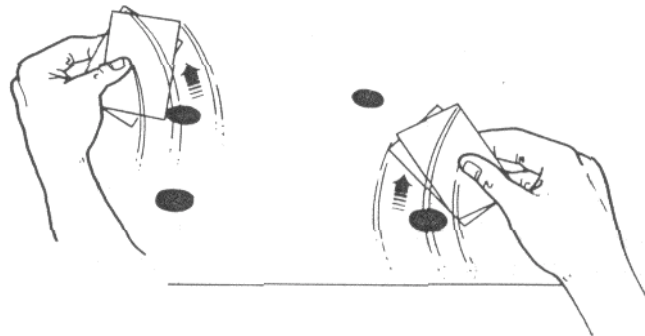

968

Again, both hands move at the same time. Your left hand lays its card onto the outer-left card and lifts both, while your right hand slides the card it holds beneath the inner-right card doing the Paglia loading move already described and lifting both cards (fig. 968). The coins have jumped back!

FINISHING TOUCHES

The C.S.B.Q. Coins Across

Geoffrey Latta

This is based on the Walt Rollins coins through table routine on p. 450 of *Modern Coin Magic*. The set-up is simple. Put the following four coins in a small purse of the type used throughout the book: English Penny, Half Dollar, Chinese (brass) coin, and a quarter. The copper coin and the quarter must be at either ends of the stack. You should be seated at a table opposite the audience, working on a close-up mat. A copper/silver coin is finger palmed in your left hand, copper side against the fingers.

To perform, hand the purse to a spectator. Tell him to open it and look at the coins inside (he is not supposed to take them out). At the same time rest your palm-down left hand on the table and allow the finger palmed coin to drop onto it. Your hand completely covers this from above.

Take the open purse back from the spectator with your right hand, held between thumb (on the inner side) and fingers (on the outer side) (fig. 969). The copper coin should be directly beneath your thumb inside the purse. If it isn't turn the purse around so it is. Your fingers pinch the bottom of the purse and push it upward, stepping the outer three coins higher than the copper (fig. 970). (This is a Roth technique.) You'll find that your thumb can actually hold the copper coin in place through the purse's fabric as you push the other three coins upward.

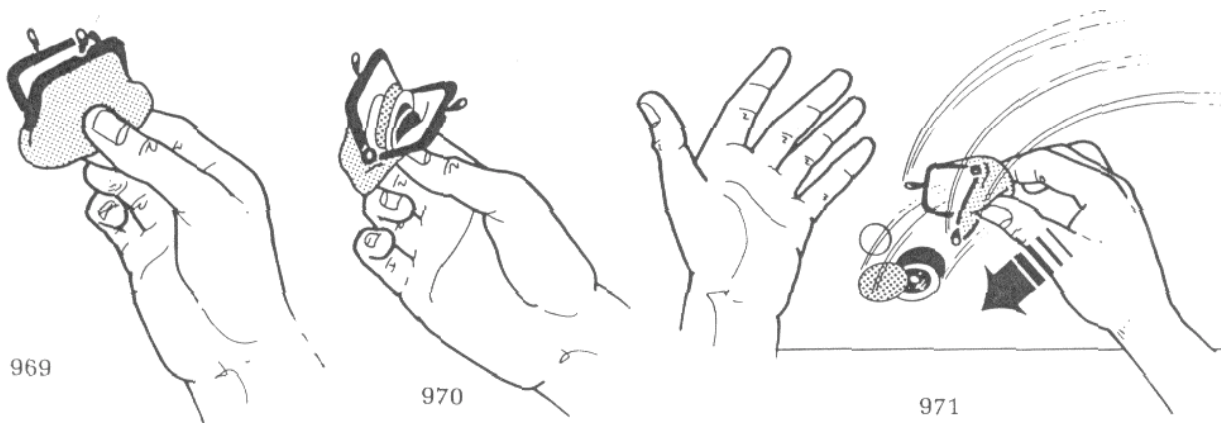

Your right hand should be above, and just to the right of, your left hand. Now, two things happen simultaneously. Your right hand turns over, spilling three coins from the purse - the copper will remain inside, trapped by your thumb's pressure. At the same time your left hand moves to the left. The three coins falling from the purse will join the copper coin already on the table and it'll appear as though all four simply fell from the purse (fig. 971).

Close the purse and place it on the table to your right where it's out of the way. Line up the coins in a horizontal row on the table about an inch apart from each other. The order, from left to right, is: copper, silver, brass, quarter.

The Brass Coin

Turn your right hand palm down and lift the copper coin with your thumb (beneath), first and second fingers (above). Place it into your palm-up left hand, which immediately closes into a fist around it (simulating a Retention Pass). Pick up the silver coin and repeat that, putting it on top of the copper with a clink and closing your fingers around it. Repeat with the brass coin, this time doing a Retention Pass so the

coin is retained in fingertip rest in your right hand after it clinks against the silver coin in your left hand. Your right thumb and first finger pick up the quarter and toss it into your left fist from about four inches away, your left fingers rapidly opening and closing to catch it.



Turn both hands palm down, say the magic word, and turn your right hand palm up, opening it to reveal the brass coin. Turn your left hand palm up and open it to show the quarter, silver, and copper coins. Turn both hands palm down, at the same time curling your fingers so the coins fall onto them (fig. 972). Lower your thumbs onto the coins and straighten your fingers, turning the coins over and placing them on the table (fig. 973). This method of placing the coins on the table keeps the proper side of the copper/silver coin upward. Keep it in mind because you'll use it again later on.

The Silver Coin

Hold your left hand palm up. Your right hand lifts the quarter and places it into your left hand, which closes over it, again simulating a Retention Pass. Your right hand picks up the copper coin and does a Retention Pass as you apparently place it into your left hand. (Don't forget to let the copper coin clink on the quarter before you pivot it back into your right hand.) Your right hand settles to the table in a relaxed fist and secretly turns the copper/silver coin over (copper side up) as explained in Wild Coin No. 3, at the beginning of Change Series No. 3.

Your right hand moves forward, lifts the silver coin, and does Geoff's One-Hand Turnover Switch as you ostensibly move the silver coin toward the spectators for a closer look. After the move the copper/silver coin will be on the table silver side up, and the silver coin will be in right-hand fingertip rest. As your right hand moves forward to lift the tabled silver coin it classic palms the silver coin in fingertip rest.

Pick it up and drop it onto the quarter already in your left hand, letting it clink against it. Close your left fingers quickly afterward. Say, "The silver coin will travel next." At the same time uncurl your first finger and let them get a peek at the silver coin (fig. 974). Don't worry about them not seeing the copper coin they'll only be looking for the silver coin at that moment.

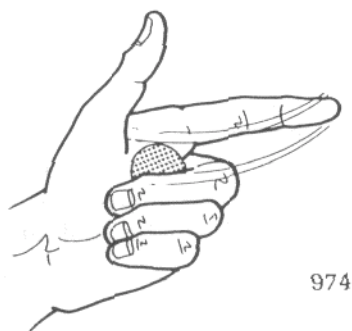

Curl your first finger again and turn your left fist over. Your right hand lifts the brass coin and makes a palm-down fist. Allow the classic palmed silver coin to fall onto the brass coin with a clink. Turn your right hand palm up and open it showing both coins. The coins in your left hand should be resting on the insides of the fingers. Slowly turn your left hand palm up, at the same time straightening your fingers so the coins do not turn over - a copper and a quarter will show. Place those coins onto the table. Turn your right hand palm down and drop its coins onto the table.

The Quarter

Hold your left hand palm up. Place the copper coin onto it, in the center, and place the quarter onto that, spread slightly to the right (fig. 975). Close your hand and do Isolation Placement, getting the quarter ready to be Han Ping Chiened. Your right hand lifts the silver and brass coins and holds them inside your right fingers as in figure 976, silver inside brass.



Do Geoff's Han Ping Chien, the quarter flying out from your palm-up left fist and landing beneath the coins in your right hand. Things are a little different here: you don't spread your right fingers when you slam the coins onto the table. Simply turn your right hand over during the move as usual and smack its coins onto the table trapping the quarter beneath them. Immediately square the coins with your thumb and fingers, covering them from the front (fig. 977). Lift the brass coin and move it forward, lowering it so that it overlaps the front edge of the silver coin (fig. 978). Raise your right hand and turn it palm up to show it empty. The quarter remains hidden beneath the silver coin, and the brass coin helps to cover the fact that the silver coin is elevated above the table.

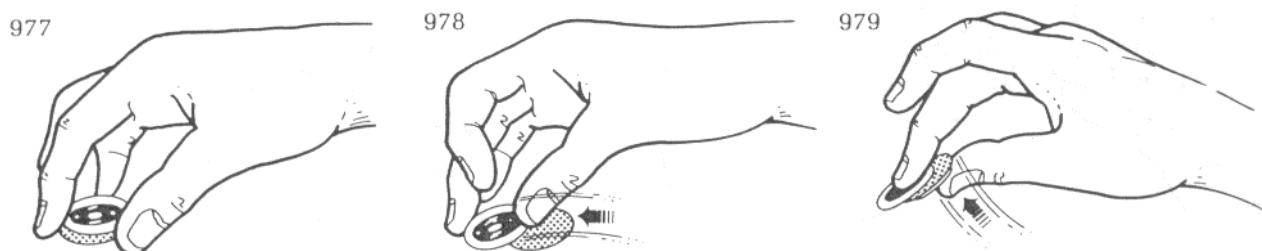

Turn your right hand palm down and lower your second finger onto the outer edge of the brass coin. Push downward, levering the inner ends of both coins upward so your thumb can slip beneath them (fig. 979). Lift the stack and make a fist around it.

Both hands are in palm-down fists as you say whatever mumbo-jumbo is apropos. Turn both fists palm up and open your right hand revealing three coins. Open your left hand revealing the copper coin. Both hands close into loose fists as they turn palm down, your thumbs move onto the coins, and you straighten your fingers to turn the coins over as you place them onto the table.

The Copper Coin

Turn your left hand palm up and place the copper coin onto it in palm - up finger palm. Close your fingers into a fist, automatically turning the coin over, now silver side up. Do the get-ready for Geoff's Han Ping Chien.

Your right hand lifts the quarter, brass, and silver coins and holds them on the curled fingers so that the silver is on top. Do the Roth technique for Classic Palming One Coin of a Group (the silver) and then turn your hand palm up to display the coins, the silver in palm-up classic palm. Do Han Ping Chien, apparently tossing the three right-hand coins onto the table. Actually the silver coin is retained in classic palm. The

quarter and brass coin join the apparent silver coin which secretly falls from your palm-up left fist. After the move is completed raise your right hand and move it back toward you, letting it settle to the table in a relaxed fist. Let the silver coin drop from classic palm to fingertip rest.

Your right thumb and first finger lift the quarter, turn it over, and move it toward the audience. Repeat the same thing with the brass coin. Do the One-Hand Turnover Switch as you apparently repeat the same thing with the silver coin. After the move your right hand moves back to the table edge and simply lets the copper/silver coin slide Off Your fingertips and into your lap.

Immediately lift your right hand, show it empty, and wave it over your left hand. Open your left hand to show that it, too, is empty. Cleanly push the purse toward a spectator. He'll open it and find the copper coin inside, and you are clean - everything is examinable.

Shirting the Issue

Sol Stone

I'd wanted to include a new "complete" vanish in the book but hadn't been able to locate one until Sol agreed to release this. It's one of the best handlings for secretly shirting a coin, and can be used as either a vanish or change. The only requirements are that you're standing and wearing a button-down shirt.

The first two movements are similar to Sol's Turnover Vanish. Hold a coin on the first and second fingertips of your palm-up right hand, your thumb resting lightly on its edge to hold it in place. Your hand should be held comfortably in front of you just above waist level, about an inch or two from your body (fig. 980). Your right hand turns palm down and lays the coin onto your left first and second fingers (fig. 981). Your left thumb moves onto the coin to complete the grip.

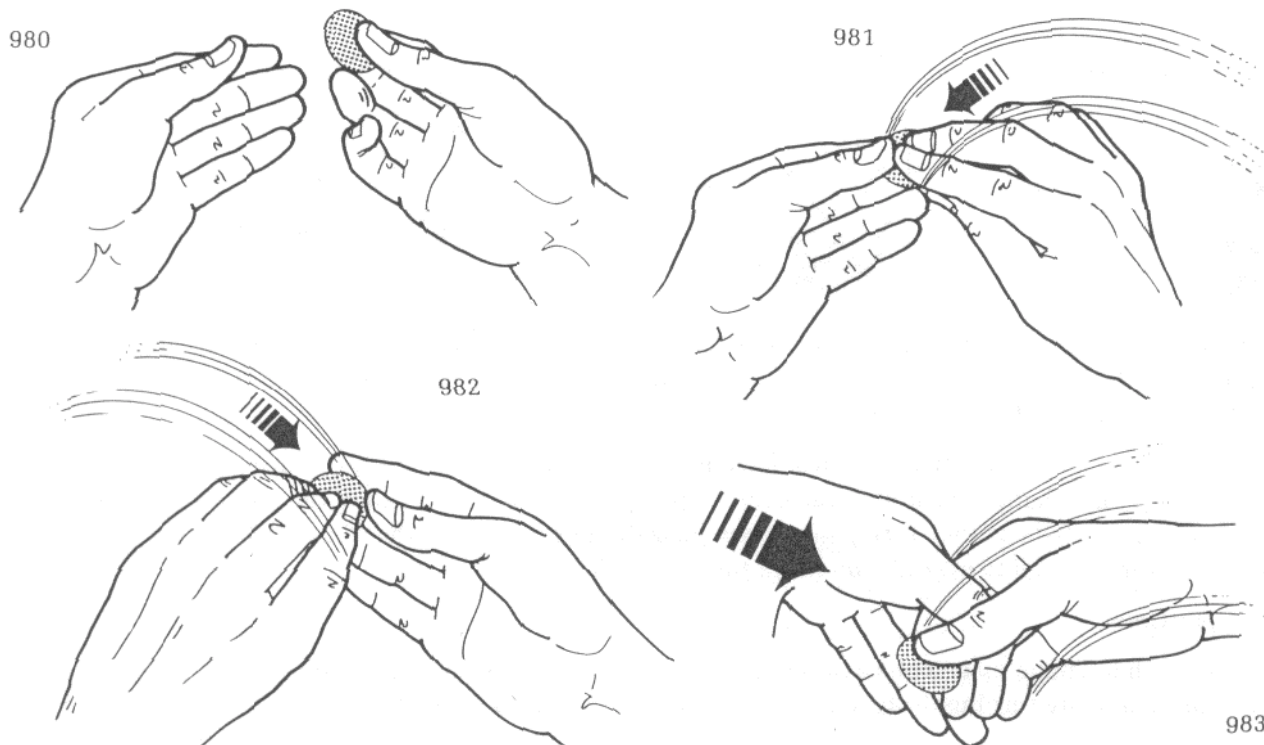

Both hands turn over simultaneously - your right hand to palm up, your left to palm down. Lay the coin back on your right first and second fingertips (fig. 982). Turn your right hand palm toward you and slide your left hand over your right hand, your left thumb moving into the right thumb hole (fig. 983). Figure 984

is an audience view which shows how your straightened left fingers cover your right fingers from the audience.

We have to back track for a moment. When your right hand turns palm toward you, and your left thumb moves over it, thumb sliding into thumb hole, it's really a both-hands-moving-together type of action. (Your hands should still be only an inch or two from your body.) As your hands move toward each other your right thumb and first finger, carrying the coin, bend inward (fig. 985). Without pausing they enter the opening of your shirt (fig. 986). You don't have to stick them in very far - just the tips are sufficient.

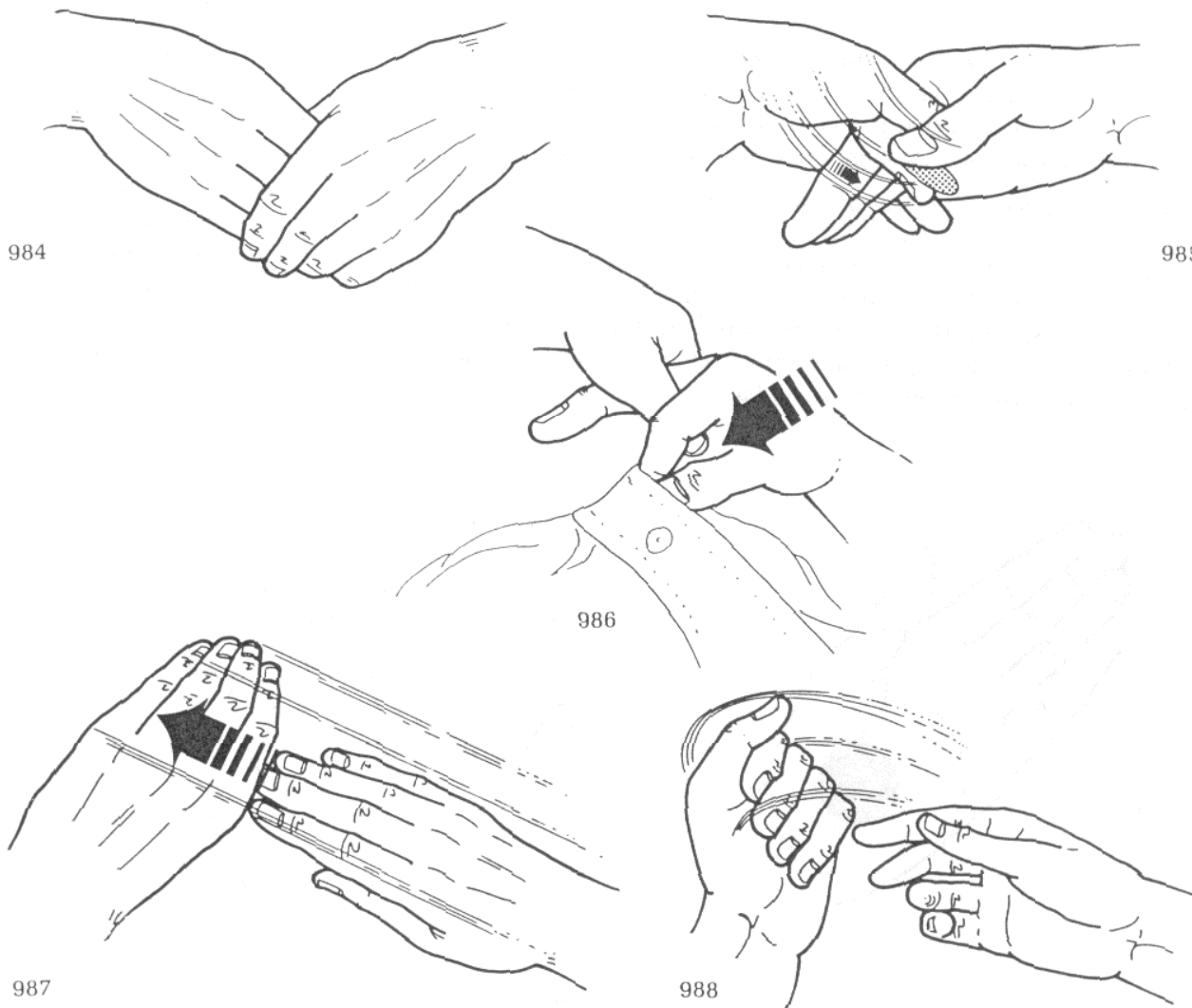

Snap your thumb lightly to the left, kicking the coin in that direction so it falls inside your shirt. Immediately straighten your right fingers and slide your left hand toward their tips (fig. 987). As soon as it clears your right fingers your left hand forms a fist and turns palm up (fig. 988). Turn your right hand palm up to show it empty. Open your left hand to show that the coin has vanished.

In Addition: As with all of Sol's sleights, this must be done smoothly so that it flows. The fluid motion is part of what makes it deceptive.

To use this as a change simply classic palm a different coin in your left hand before you begin. Do the vanish exactly as described and, when you open your left hand at the end, a transformation will be revealed.

Glass-Topped Coin Through Table

John Cornelius

One of John's specialties is the Muscle Pass, by which he can squirt a coin out of a modified classic palm into the air. It's a knack that takes a lot of practice to acquire, and John has it down to a science. Jon Racherbaumer pointed out that this is the first secret use of the Muscle Pass he's seen. This application is based on the Benzais Card Through Table which appeared in *CloseUp Card Magic*.

You must be seated at a glass-topped table with the spectator on your right. Take a half dollar and do a Retention Pass into your left hand, which closes into a fist. Ask the spectator to cup his hands in an open prayer type position and hold them, palm up, beneath the table. As he's moving to that position your right hand moves beneath the table in a palm-down relaxed fist (which is the position it's in after the Retention Pass, with the coin in fingertip rest). Push the coin into a modified classic palm, farther back than usual - nearer your wrist (fig. 989). That position facilitates the propulsion of the coin when you contract your palm and thumb base.

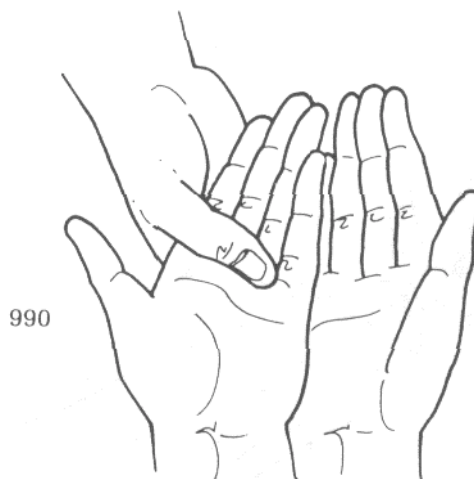
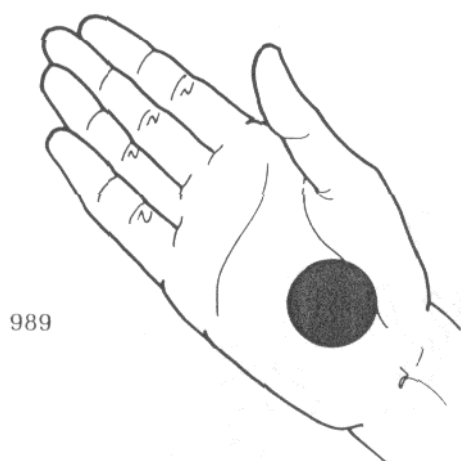

Turn your hand palm down and grasp their hands, thumb beneath, fingers above, asking, "Feel my fingers and thumb?" Turn your hand palm up and grasp their hands as in figure 990, which is their view. Note that they cannot see the coin because it's hidden by your right thumb base - similar to the Kaps Subtlety already described.

Make sure they're looking directly at their hands before you continue. Move your left hand over the table, turn it palm down, and pretend to transfer the coin it ostensibly holds to your fingertips. At the same time raise their cupped hands to an inch or two beneath the glass. Bring your left fingers down onto the table and push. At the same time do the Muscle Pass, squirting the coin concealed in your right palm

upward. It'll ricochet off the table and into their hands - it's hard to miss (fig. 991 is an exposed view; fig. 992 is their view through the table). Note that the coin appears beneath your left fingers beneath the table and they see it fall into their hands. The illusion is perfect.

991

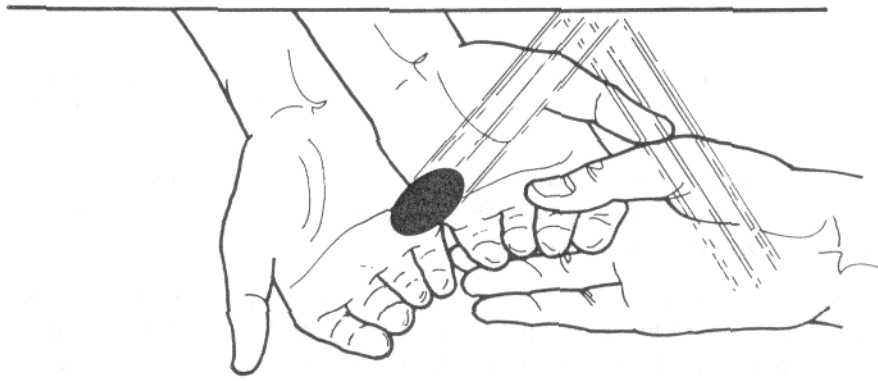

992

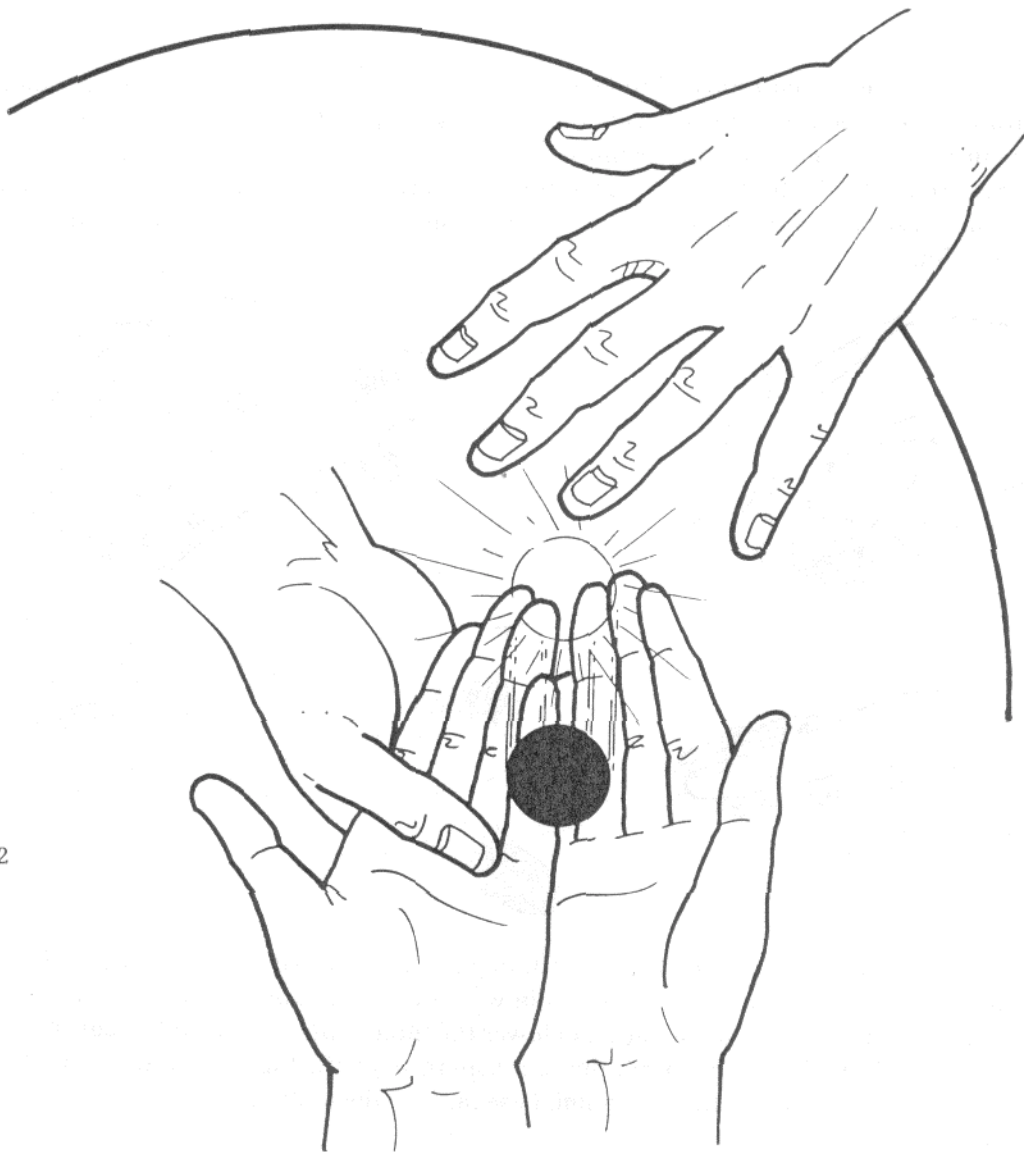

Molecular Coins Through Table

Derek Dingle

Derek demonstrated this routine while we were going over some material in preparation for his new book, *The Complete Works of Derek Dingle*. Portions of this had originally appeared in *The Pallbearer's Review* (January, 1973), though improperly described.

The reason I'm including it here is because elements of it are antecedents of Geoffrey Latta's *Ultimate Han Ping Chien* and David Arthur's *Last One Through*. Though Geoffrey had neither seen nor heard of Derek's handling until I showed it to him, Derek's handling (which does predate Geoff's) was obviously created in the same train of thought. The only requirements are that you be seated at a table opposite the audience, and that you use four identical coins.

The First Coin

Have the coins examined and then returned to you. Show your hands completely empty and stack the coins directly in front of you about two inches from the table edge. Openly move your right hand beneath the table. Lower your palm-down left hand over the stack so that the coins can be grasped between your thumb and first finger (fig. 993). Note that the lower side of the hand is pressed firmly against the table so that the spectators cannot see under it. At this point the stack is shielded from the audience by the backs of your first and second fingers.

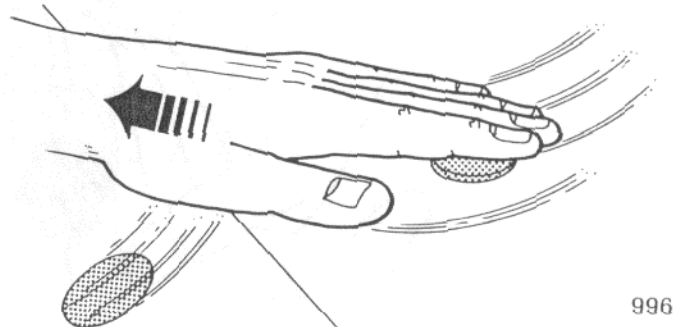
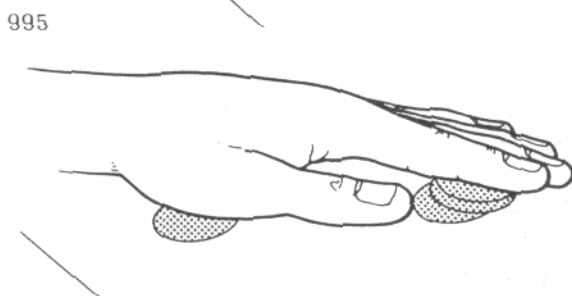
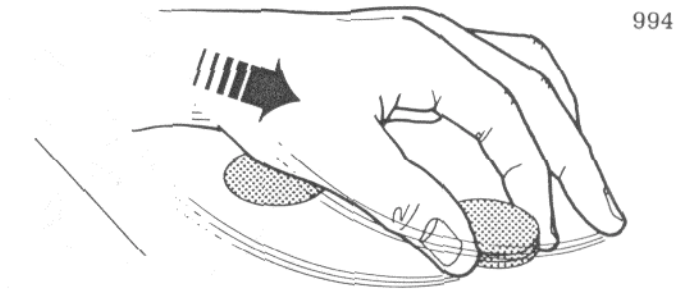
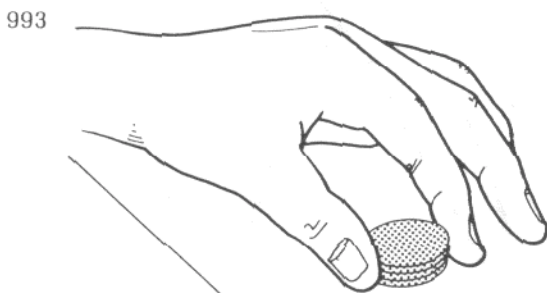

Lift only the top three coins and move them forward, diagonally outward and to the right (fig. 994). Pause when your left thumb base is directly over the coin which you've left on the table as shown in the illustration. Press your left hand lightly downward and lower the three coins onto the table, covering them with your fingers (fig. 995). Say, "I'm going to rub the first coin through the table." Retract your left hand just enough so that the coin hidden beneath your thumb base falls off the table and into your lap (fig. 996).

Make a few rubbing motions with your hand - but don't overdo it: this is not the Marlo move where the coin is rubbed backward beneath your hand.

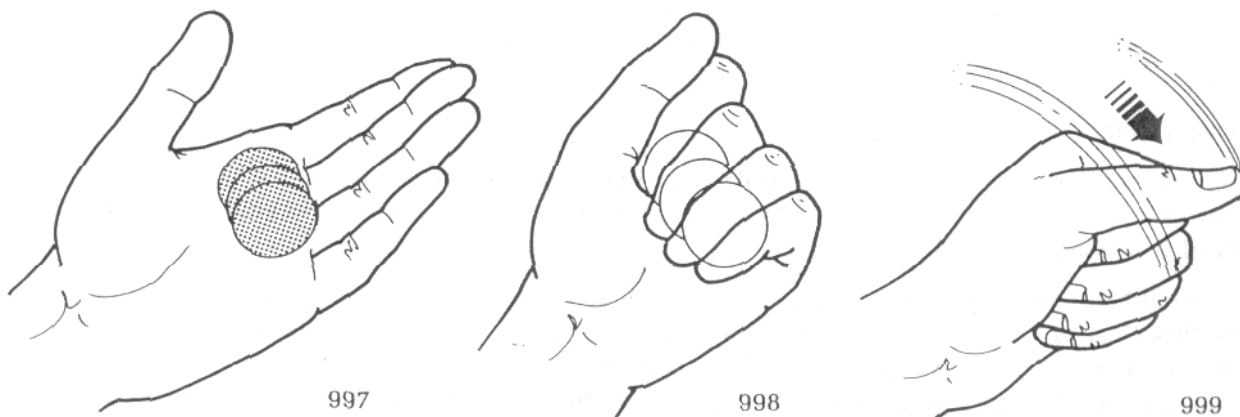

Bend your right hand inward at the wrist and pick up the just-lapped coin. Move your hand back beneath the table and snap the coin upward against it making a noise. Lift your left hand revealing only three coins. Pick those up and let them rest on your palm-up left hand so that the center coin is directly in line with your second finger (fig. 997). Close your left fingers into a fist over the coins, your second fingertip pressing on the center coin to hold it, and the coin to its left, in place Fig. 998 in which the hand is transparent). The coin farthest to the right is gripped very loosely inside your third and pinky fingers.

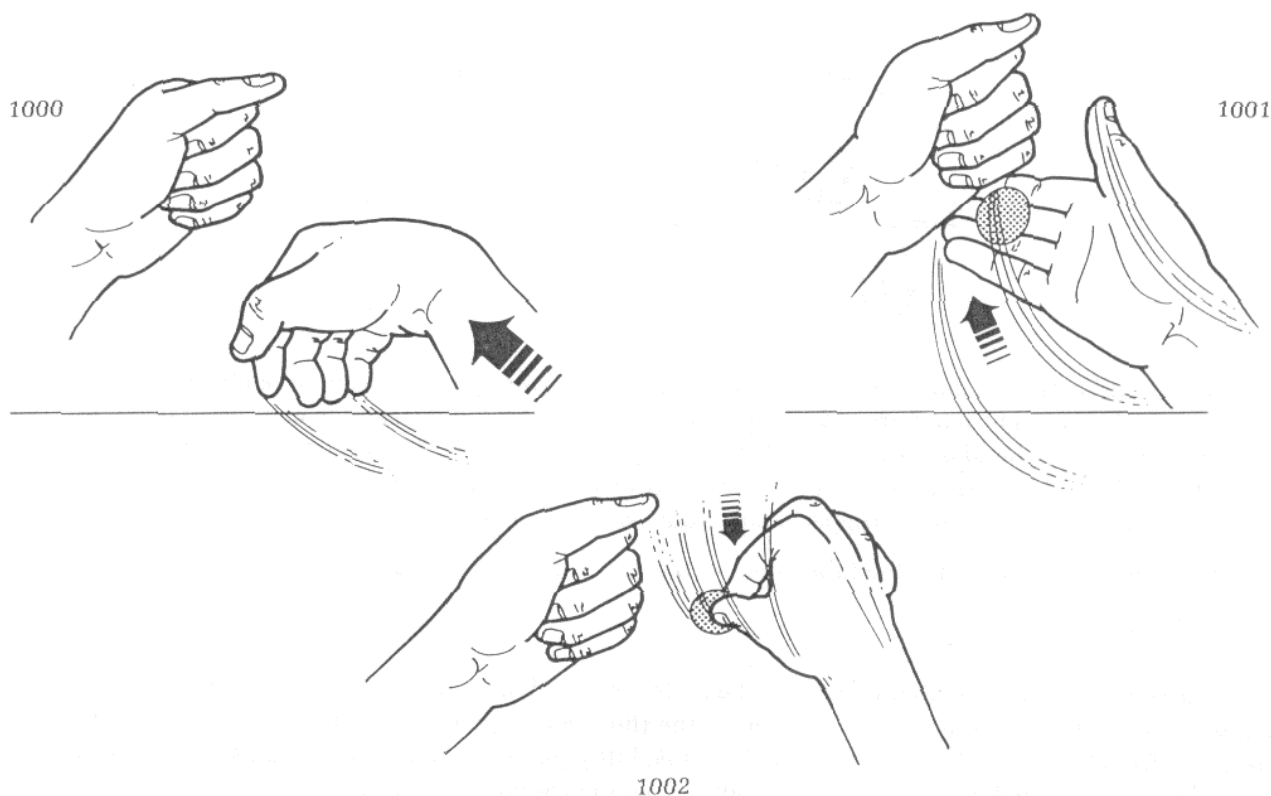

Tilt your fist upward to a vertical position, holding it about an inch above the table (i.e., simply turn your hand at the wrist so the thumb hole is pointing directly upward, the backs of your fingers facing the right) (fig. 999). Move your right hand toward you and, on its way out from beneath the table, leave the coin it holds in your lap. Without pausing bring your right hand above the table directly in front of you directly in back of your left hand (fig. 1000). Note that your right hand should be palm down, fingers curled into a loose fist as if holding a coin.

Two things happen simultaneously. Your right hand begins to move outward and turn palm up. It passes directly beneath your left hand, which relaxes and allows the lowermost loose coin to drop out of it and onto your right fingers (fig. 1001). Other than relaxing its pinky your left hand does not move. Your right hand continues moving forward, grasping the coin it holds between thumb and first finger and turning palm down to tap it on the table (fig. 1002). Say, "That's one - through a solid table." You're now one ahead.

The Second Coin

Your right hand takes its coin and, as soon as it's beneath the table again, snaps it into classic palm. Pick up the coin already in your lap and hold it between your thumb and first finger. Move your hand beneath the center of the table.

Slap your left hand onto the table, turning it palm down and spreading its fingers. Lift it to reveal only two coins. Pick those up and display them on your palm-up left hand for a moment. Close your left fingers into a fist and turn it palm down, your second or third finger pushing one of the coins backward so it dangles outside your fist held in place by only your fingertips. (This has been described before - see Roth's Deep Back Clip Steal for more details.)

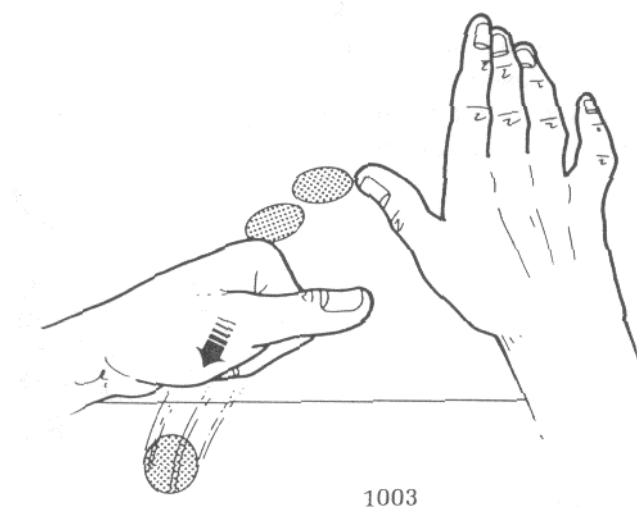

Bring your right hand out from beneath the table with its two coins spread, held between the thumb and first finger. Move your right hand around and in front of your left hand, tossing its coins onto the table. Simultaneously your left hand moves back to the table edge and allows the dangling coin to drop into your lap (fig. 1003). (This is a modification of a Vernon move from Kangaroo Coins.) Without pausing your right hand lifts the two coins it has just dropped while your left fist moves forward a bit.

Your right hand moves beneath the table and, on the way, picks up the just-lapped coin.

The Third Coin

Once your right hand is beneath the center of the table your left hand turns palm down, fingers straight, and slaps its coin onto the table. A second later let the third coin in your right hand, which you've been holding away from the others, fall onto them with a clink. Lift your left hand revealing a single coin. Pick it up and hold it on your palm-up hand for display. As you close your fingers into a fist tilt your hand sideways so it's in the same position for Han Ping Chien as in the handling for the first coin (i.e., in a vertical position with the thumb hole pointing upward). Remember that your fist should be about an inch above the table.

While still beneath the table your right hand grips its three coins in a fanned spread between thumb and first finger (fig. 1004). Note that the uppermost coin is spread outward, and the lowermost inward. Raise

your right hand above the table so its three coins are visible and say, "The one remaining in my left hand Bend your right hand back at the wrist, tossing the lowermost coin into your lap (fig. 1005) as You continue, ". . . will join these three. . . ." As you finish the sentence, saying, "11 ... in my right hand," your right hand snaps outward at the wrist tossing the two coins it holds forward - directly beneath your left hand. At the same time your left pinky relaxes (your left hand does not move, though!) so the single coin slides out and coalesces with the two thrown from your right hand (fig. 1006). Show your right hand empty, then pick up the three coins and go under the table with them.

The Fourth Coin

As your right hand goes beneath the table it picks up the fourth coin between thumb and first finger. Slap your left hand onto the table as you simultaneously let the fourth coin hit the others. Bring all four coins out from beneath the table to end.

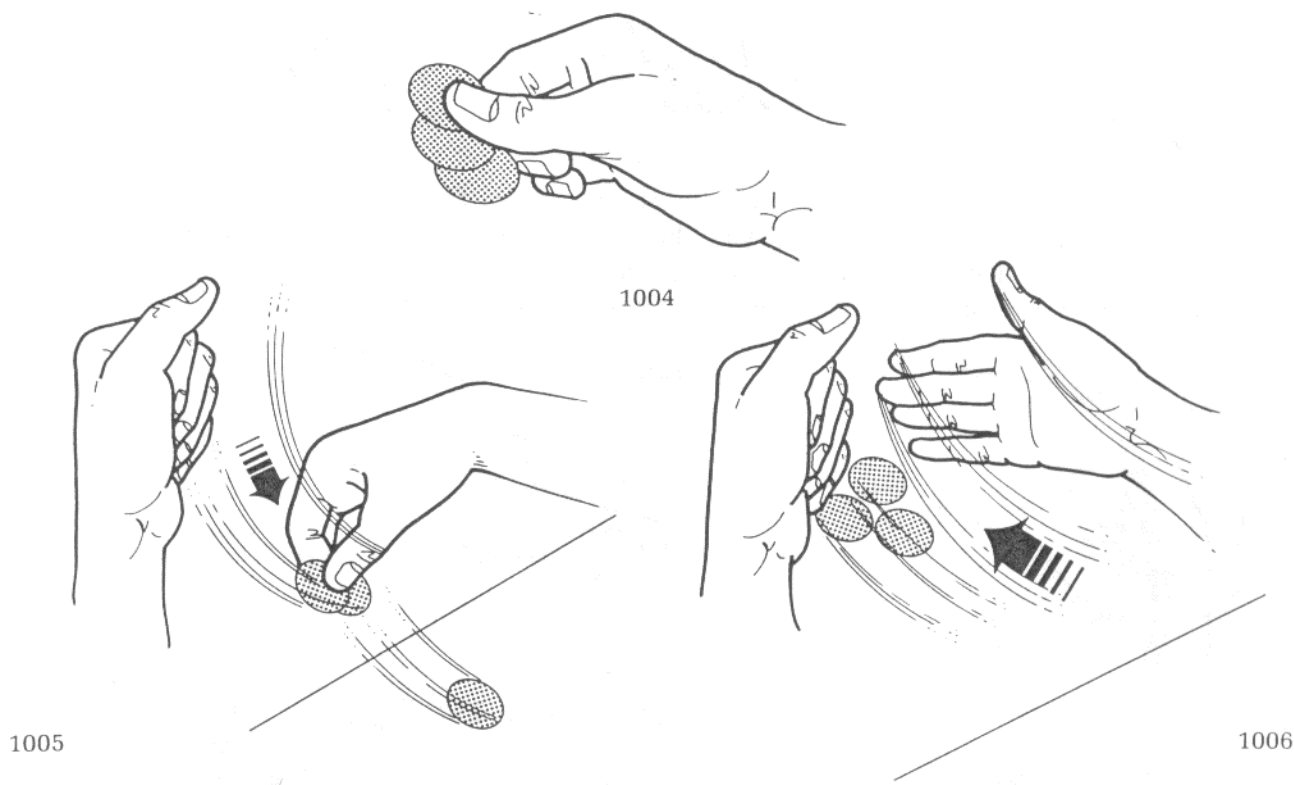

The Nefarious Nest of Boxes

Derek Dingle

The basic idea for this appeared in an old Phoenix. To set up, obtain a nest of boxes set - the small plastic kind where all the lids and bottoms are the same color. Separate all the boxes and lids and lay everything on the table. Take all the lids except the largest and stack them one inside the other - place those aside. Stack all the bottoms except for the largest, turn them over, and place them into the largest bottom (fig. 1007 is a schematic view). Cover that with the largest lid and place the whole thing on the table. Finger palm the rest of the lids that you've placed aside in your right hand, openings toward you (fig. 1008).

To perform, borrow a quarter and have it marked. Take it between thumb, first, and second fingers of your right hand and Retention Pass it into your left hand. Once your left fingers have closed into a fist your

right hand drops away with the quarter in fingertip rest (fig. 1009). Raise your left fist and make a remark. At the same time your right thumb slides the quarter into the lids (fig. 1010).

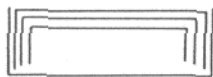

1007

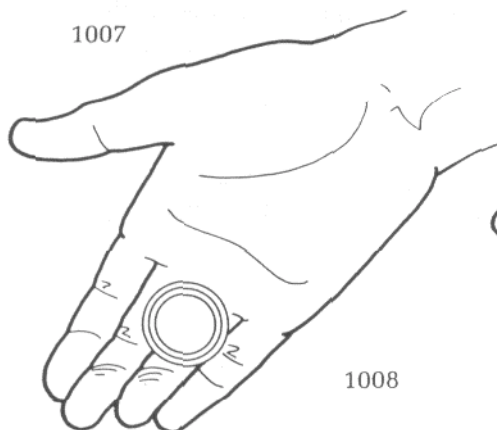

1008

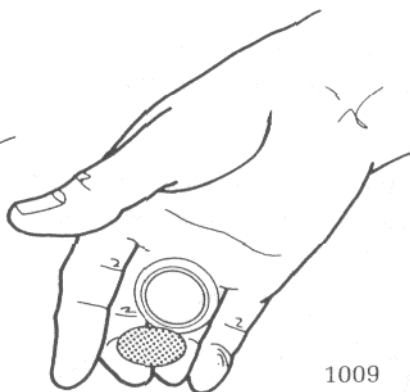

1009

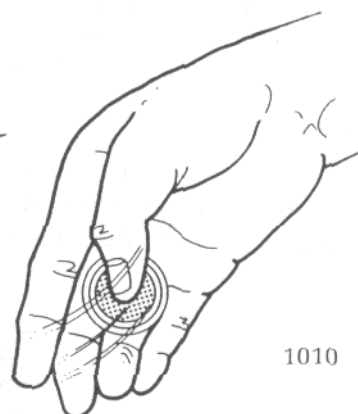

1010

Your right hand reaches forward and lifts the box from the table, thumb above, first finger beneath (fig. 1011). Raise your hand and turn it palm up, your thumb dragging the box over the lids as your fingers straighten (fig. 1012). Note that the lids rest in High Finger Palm on your second and third fingers, which are dropped a bit so your first finger conceals the extra thickness from the front.

1011

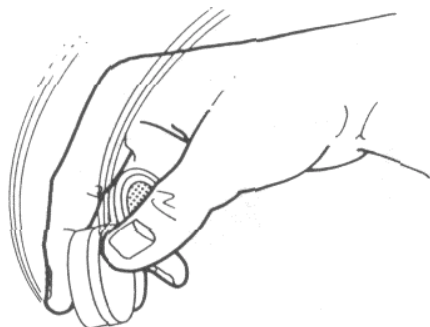

1012

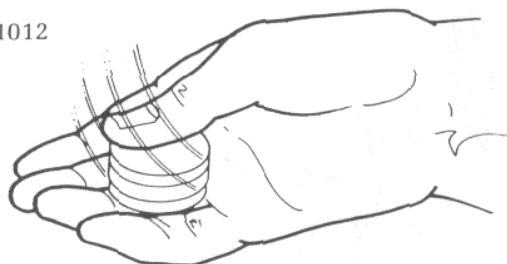

1013

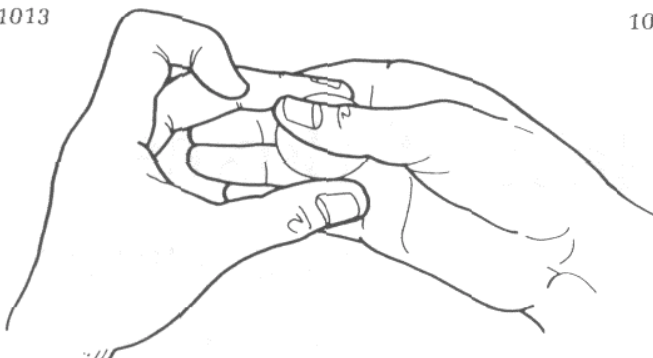

1014

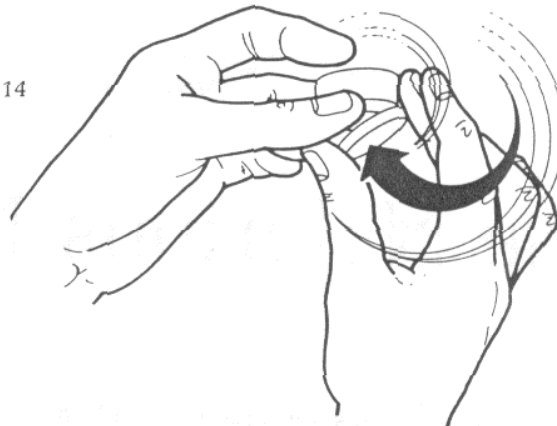

Crumple your left fingers, opening them and making a tossing motion toward the box. Shake your right hand up and down a few times so the spectators hear the coin rattle - it sounds as if it's in the box! Turn your left hand palm down and take the box and lids beneath it from your right hand, thumb at inner side and second finger at outer side (fig. 1013). Rotate your left hand so the top of the box faces directly toward the spectators. Show your right hand empty and, with it, remove the large lid. Turn the lid around and place it beneath the box, over the other lid (fig. 1014 shows the lid just before it's flush with smaller lids). Rotate both hands so the bottom of the box is once again parallel with the table.

Move your right first finger onto the top of the open box (onto the supposed lid of the inner box) and slide the box to the right (fig. 1015). Note that your right thumb begins to move beneath the bottoms to complete

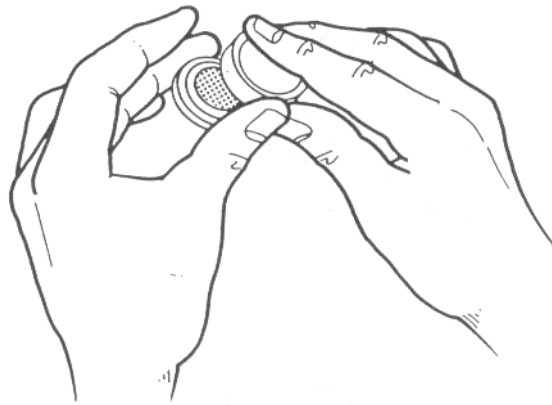

1015

the grip. At the same time, to avoid exposing the insides of the lids remaining in your left hand, your left thumb tilts them toward you so they're held by your second finger (on the outer side) and your thumb (on the inner side) (fig. 1016).

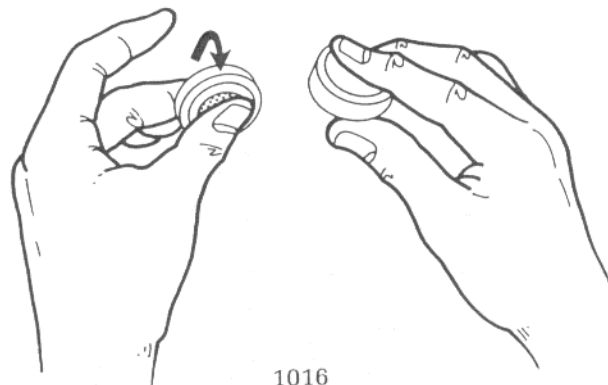

1016

Separate your hands a bit, your right hand taking the bottoms and turning them inside toward audience. Say, "When you take off the lid there's another box inside." Lower your left hand slightly keeping it palm toward you, straighten its fingers, and pull the lids inside it to a High Finger Palm. At the same time your right hand flips the bottoms over and turns palm up so they're held between thumb and second finger as in figure 1017.

Move your hands together as just shown, so your right hand is directly in front of your left hand - the box almost in line with the lids. Your right thumb levers the box toward you so the smaller bottoms fall out, openings upward, onto your right third finger (fig. 1018). Without pausing your third finger kicks the bottoms over again so they do another somersault right onto the lids (fig. 1019). All of this is covered from the audience by the backs of your right fingers.

Without pausing your left thumb moves onto the bottoms and presses them firmly into the lids. Immediately turn your left hand palm down, rasping the whole works between thumb beneath, and second finger above. Both hands set the items on the table (fig. 1020). Your left fingers pluck off the large lid and then push the closed smaller boxes toward the spectator for him to open and find his marked coin.

1017

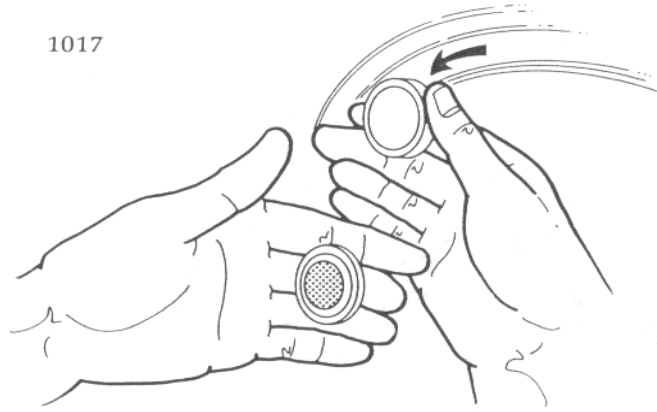

1018

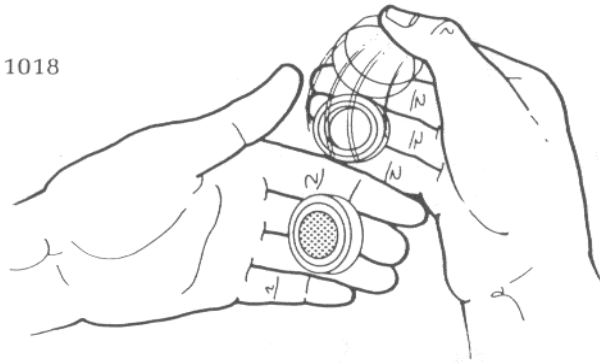

1019

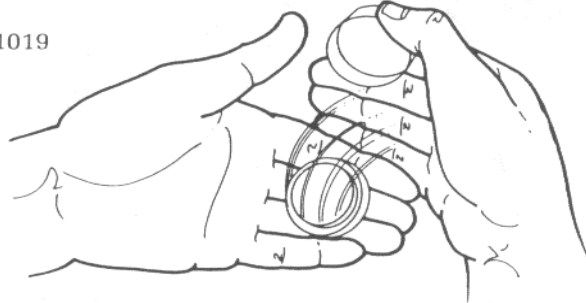

1020

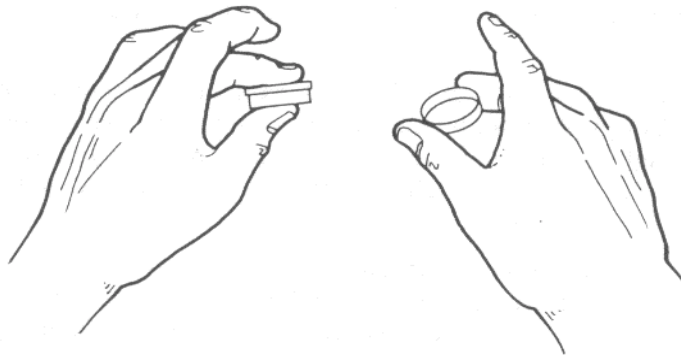

David Roth on The Retention Pass

I would've described this handling in David's section, but he decided to release it only after the rest of the book had been set in type. It's necessary to use it for the routine which follows. This text is basically a transcript of a tape Roth made in which he described the move to me. It's based on Dai Vernon's A Coin Vanish which appears on p. 30 of Modern-Coin Magic.

"The first thing is that the coins must be shiny - that's very important. It's better with silver than copper, and it absolutely has to do with the amount of light bouncing off the coin.

"Your right hand holds a half dollar between the thumb and first two fingers so that as much of the coin is exposed as possible. Your right hand lowers the coin onto your left hand between the bases of your first and second fingers. Well, you don't actually place it on your hand - but the back of your right thumb nail does touch momentarily (fig. 1021 is an audience view). One of the biggest mistakes everyone makes is trying to do the move on the way to the left hand.

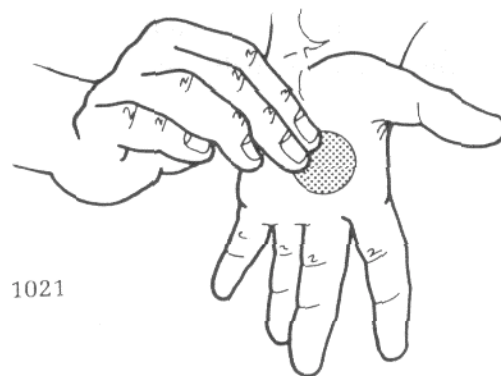

"The reason you don't actually lower the coin itself onto the hand is so that a space remains between it and the palm. Later on, when you steal the coin, that space will speed up the action so the coin won't scrape against your left hand as it's turning over.

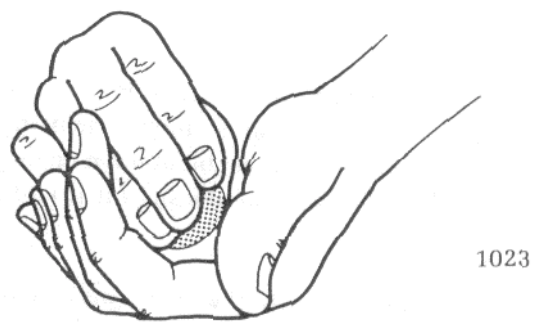
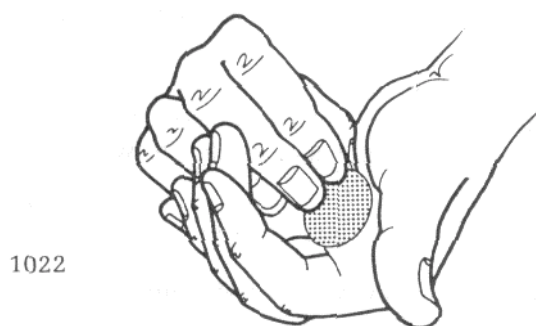

"Okay, so your right hand comes over and appears to place the coin on your left palm - but don't let go of it, and don't pause either. Immediately begin to curl your left fingers until your left pinky touches your right pinky (fig. 1022 is an exposed view). At that moment you know that your left fingers are forming an adequate screen for the move.

"While your right thumb and first finger continue to lightly grasp the coin, your second and third fingers extend, moving onto the coin's face (fig. 1023 is an exposed view). They do not have to extend all the way across the coin's face - just as far as they can comfortably go.

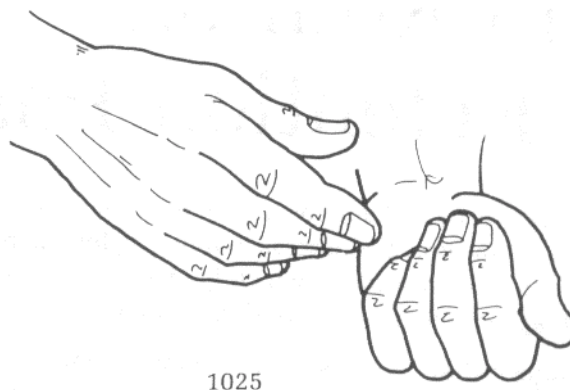
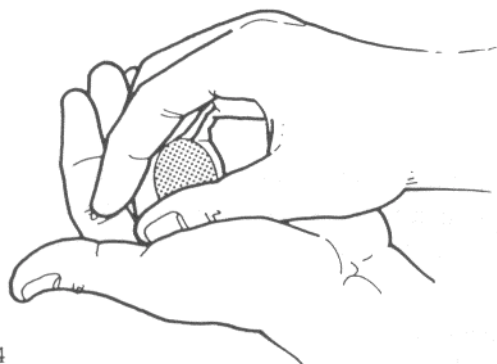

"Now, simply curl your second and third fingers, the coin in fingertip rest. Your thumb and first finger do not move or bend in any way (fig. 1024). There's a tremendous tendency to pull back with your first finger, but that causes the knuckle to pop up and you'll always spot a Retention Pass because of that. A simple act of will - a conscious effort - not to move your thumb or first finger is necessary.

"You don't even begin to move your right second and third fingers over the coin until it feels like there is no room to do the sleight. Once your second and third fingers have pulled the coin into fingertip rest your right hand moves away, slightly lifting the thumb (fig. 1025). With some practice the illusion is perfect: it's all in the timing.

IV

David Roth

It takes a different type of construction in an effect to fool other magicians - this routine was created for that purpose. All you do is vanish four coins using an apparently identical Retention Pass each time. Now, even if you know just the tiniest bit about coin magic it's obvious that problems arise, such as where to put each coin so the following one doesn't hit it and make noise.

The Vanishes

You must be standing with the four coins on a table in front of you. Show your hands empty. Pick up the first coin and do a Retention Pass into your left hand. Afterward your right hand drops to your side with the coin in fingertip rest. Crumple your left fingers and open your left hand to reveal the vanish.

Extend your right hand to pick up the second coin and classic palm the first coin as you do. Do another Retention Pass. Afterward your right hand drops to your side with the second coin in fingertip rest

(fig. 1026). Lower your thumb onto the second coin's inner edge, a bit to the left on its circumference (fig. 1027). Lift the coin, pivoting it into lower finger palm (fig. 1028). At the same time crumple your left fingers and open them to show the vanish.

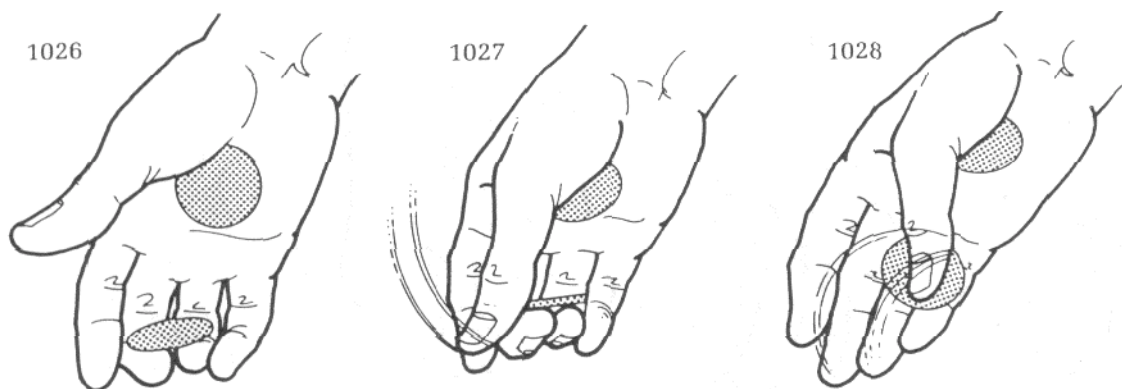

Lift the third coin and do another Retention Pass. Once the coin is in fingertip rest immediately extend your thumb downward behind it. Since the coin should project slightly beyond your fingertips its inner edge will press against the crease of your thumb (fig. 1029). If you curl your fingertips a tiny bit you'll find that the coin will pop upward to a vertical position against your thumb (fig. 1030). Lower your fingers a bit and straighten your thumb against the coin, holding it in classic thumb palm (fig. 1031).

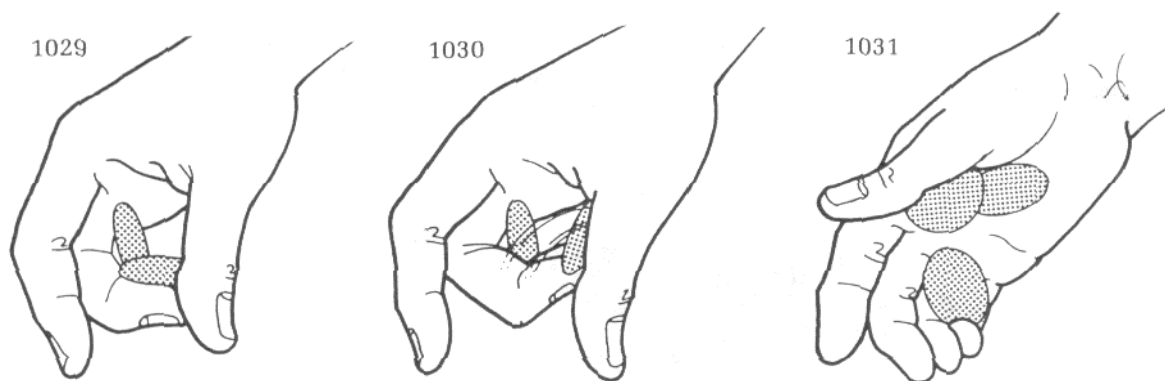

Extend your right first finger and press the back of your palm-down left fist in a magic gesture (fig. 1032). Lower your right hand to your side, turning your left fist palm up at the same time. As you open your left fingers to show the vanish your right first and second fingers curl inward to above and below the

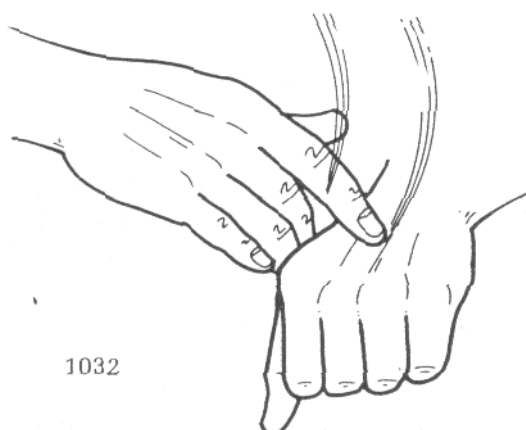

thumb-palmed coin (fig. 1033). Lift your thumb slightly away from the hand and the coin will almost automatically turn a bit (fig. 1034). If you wrap your thumb around the coin's edge you'll find it's now in Downs palm (fig. 1035).

Lift the fourth coin and do another Retention Pass. Afterward, when your right hand drops to your side, you'll be concealing four coins in four different positions (fig. 1036). From the front, though, it appears casual and relaxed. Crumple your left fingers and open them to show the fourth vanish.

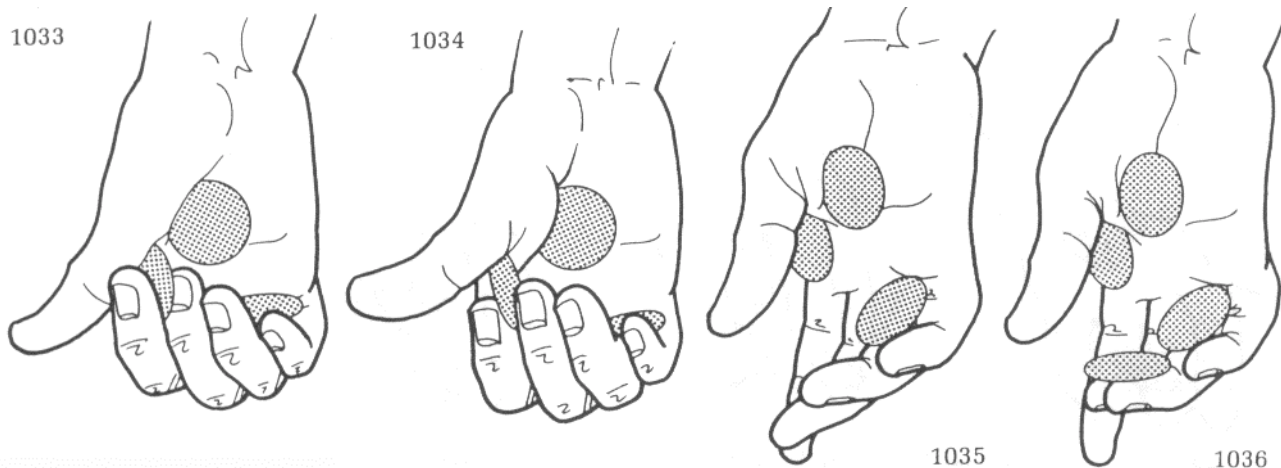

The Reproductions

Turn slightly to your left and raise your right hand, back toward audience. Pretend to catch something between your thumb and fingers and immediately drop the coin that's in fingertip rest onto your palm-up left hand in finger palm. As you display that coin for a moment your right first and second fingers curl inward to above and below the Downs palmed coin (fig. 1037). Move your hands together in the Shuttle Pass action, your left hand turning palm down retaining the coin in finger palm, and your right hand turning only partially palm up - at the same time straightening your first and second fingers (fig. 1038). Don't turn your right hand too far or you'll expose the other palmed coins.

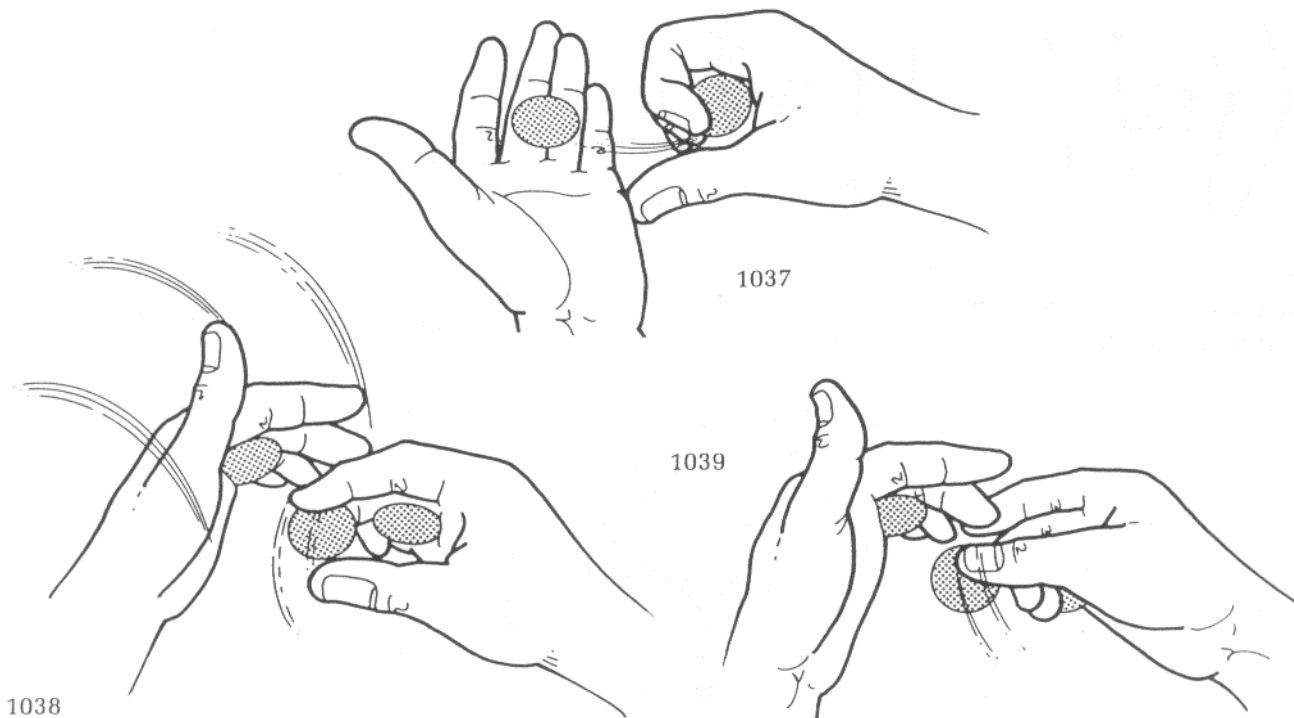

Your right thumb moves onto the coin clipped between your fingers and presses it flat against your second finger, your first finger curling out of the way (fig. 1039). Turn your right hand palm down and move it over the table. Drop the coin.

Extend your left hand and produce the finger-palmed coin at your fingertips. Afterward pull it back into palm-up finger palm (Shuttle Pass) position. Do another Shuttle Pass, this time doing the variant described in Wild Coin No. 1. In other words your right hand simply mocks catching the coin from your left hand (the coins in classic and finger palm stay where they are), turns palm down, moves over the table, and lets the lower finger-palmed coin drop onto the table.

To end, both hands turn palm up and produce their coins at the fingertips, dropping them to the table afterward.

Chinaman's Chance

Dai Vernon

There is no better way to end this book than with a simple two-coin transposition that has that Vernon Touch. This has never appeared in print before, and with Vernon's permission it was relayed to me and described by David Roth.

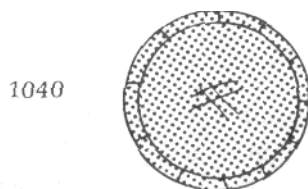

You need a silver coin and matching shell (both must be silver all the way through), and a Chinese coin with a hole in it., center. To prepare, turn the shell upside down and make a few lines with a pencil around the center (fig. 1040). The lines should be very light. (Note: if you cannot obtain a silver shell and are going to use a half dollar minted after 1964, which has copper in the center, you can stick a small piece of aluminum foil dull side up into the shell.) Either way, after you've prepared the shell place it over the silver coin making sure it still shows both a head and a tail afterward.

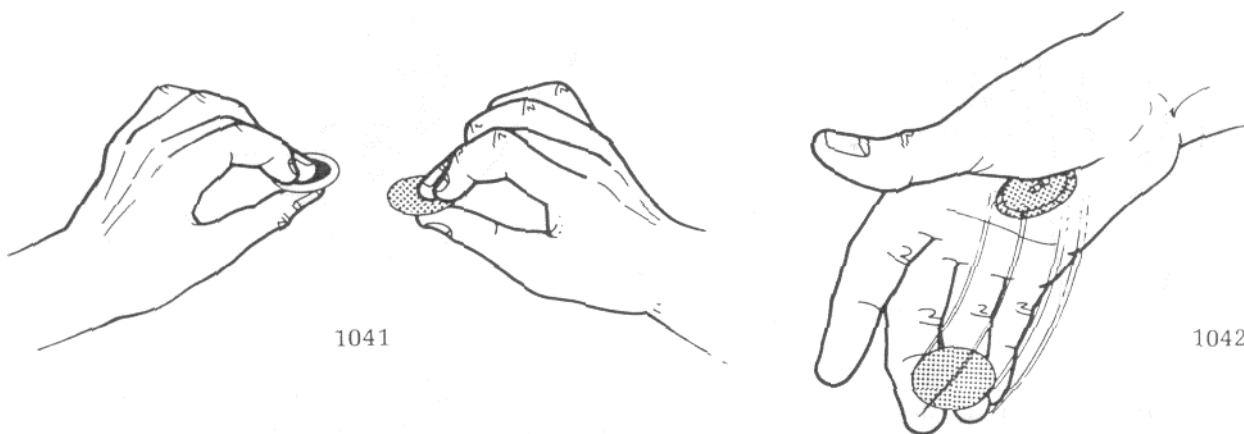

To perform, bring the coins out and display them, your right hand holding the shelled silver and your left the Chinese coin. Both coins rest on the fingers of your palm-up hands. Grasp the coins between the second finger and thumb of each hand curling your other fingers and turning your hands over (fig. 1041). Turn your hands palm up and close them into fists. Turn them palm down so the coins are in fingertip rest in each hand.

As you patter about testing the spectators' observation your right fingers push the shelled silver coin upward into classic palm. Lower your fingers immediately, the coin still resting on them although the shell

has been retained in classic palm (fig. 1042). Say, "Silver here, Chinese here," as you turn your hands partially palm up to display the coins on your fingers. The classic-palmed shell is concealed in your right hand using the Kaps Subtlety described in Roth's Standup Copper/Silver Classic (fig. 1043).

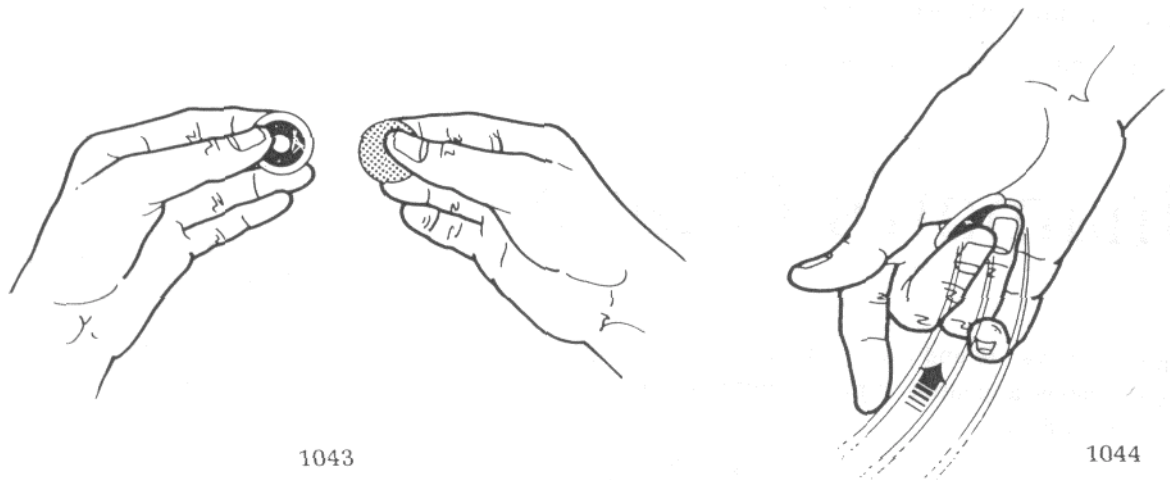

Switch the coins as you patter, taking the Chinese with your right hand and the silver with your left. Both hands close into fists. The Chinese coin, on your right fingertips, is slid upward along the base of your thumb and maneuvered quietly into the shell (fig. 1044). Relax your palm once the coin is in the shell and lower your fingers slightly. The shelled Chinese coin should now be in fingertip rest.

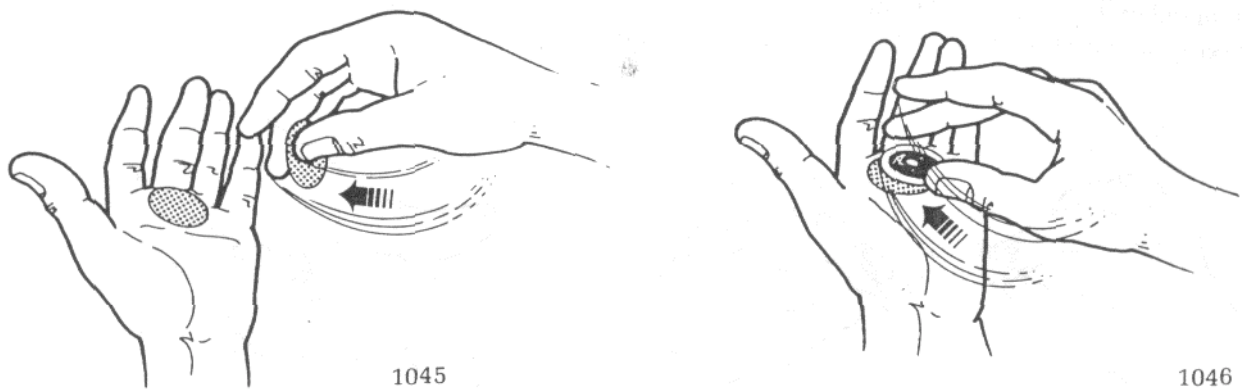

Turn your left hand palm up and then open it, displaying the silver coin. At the same time lower your right thumb onto the shelled Chinese coin (fig. 1045). Straighten your right thumb and fingers and lay the shelled Chinese coin Chinese side up onto the silver coin (fig. 1046). It will appear as though the silver coin is visible through the hole in the Chinese coin's center, though what they're actually seeing is the inside of the shell.

Close your left hand and turn it palm down. The thumb and first finger of your palm-down right hand reach inside your left thumb hole and grasp the lowermost coin, the shelled Chinese, and bring it out (fig. 1047). The shell is toward the audience so it appears to be the half dollar.

Rotate the shelled coin as you turn your right hand palm up so the shell remains toward the audience by flipping the coin around with your second finger. Close your hand into a fist and push the shell into classic palm, allowing the Chinese coin to remain in fingertip rest afterward. Open your hand again, turning it partially palm up using the Kaps Subtlety to conceal the shell in classic palm. After you pause a second turn Your left hand palm up and open it to reveal the silver coin. Both hands turn palm down and drop the coins on the table to end.

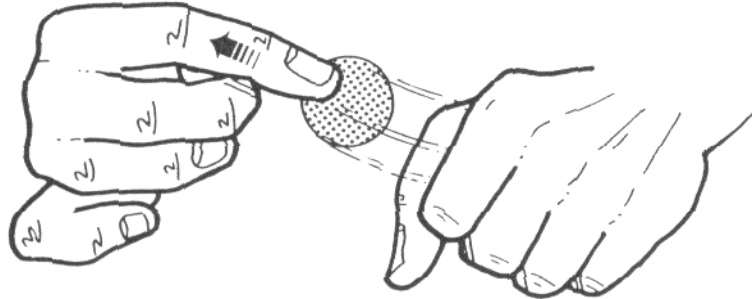

1047

Silver and gold are not the only coin; virtue too passes current all over the world.

Euripides