



GOVERNMENT OF INDIA

# GUIDELINES FOR PLANNING AND DESIGN OF PIPED IRRIGATION NETWORK

PART-I & II



JULY 2017



MINSITRY OF WATER RESOURCES, RIVER DEVELOPMENT & GANGA REJUVENATION  
CENTRAL WATER COMMISSION  
GOVERNMENT OF INDIA





सत्यमेव जयते

**GOVERNMENT OF INDIA**

# **GUIDELINES FOR PLANNING AND DESIGN OF PIPED IRRIGATION NETWORK**

**PART-I & II**



**CENTRAL WATER COMMISSION**

**MINISTRY OF WATER RESOURCES, RIVER DEVELOPMENT & GANGA REJUVENATION**

**GOVERNMENT OF INDIA**

**NEW DELHI**



# CONTENTS

MESSAGE.....	I
FOREWORD.....	II
PREFACE .....	III

## **PART-I SOURCE TO OUTLET**

<b>CHAPTER-1 INTRODUCTION.....</b>	<b>1</b>
1.1 Piped Irrigation Network (PIN) .....	2
1.2 Advantages of Piped Irrigation Network over Canal Distribution Network (CDN).....	2
1.3 Disadvantages of Piped Irrigation Network .....	3
1.4 Application of Piped Irrigation Network .....	3
<b>CHAPTER-2 PIPED IRRIGATION NETWORK (PIN) PLANNING .....</b>	<b>5</b>
2.1 General .....	5
2.2 Piped Irrigation Network Planning .....	6
2.3 Data Required for Piped Irrigation Network Planning.....	6
2.4 Route Selection of Pipe Network.....	7
2.5 Guiding Principle for deciding Carrying Capacity of Pipe/Canal.....	7
2.6 Design of a Network for Irrigation by Rotation .....	10
2.7 Preliminary Carrying Capacity of Distributary / Minor .....	10
2.8 Procedure for Deciding the Carrying Capacity of Main / Branch Line .....	11
2.9 Water Losses and Irrigation Efficiencies.....	11
2.10 Capacity Factor:.....	12
<b>CHAPTER-3 HYDRAULICS OF PIPE FLOW .....</b>	<b>13</b>
3.1 Free Surface Flow .....	13
3.2 Pipe Flow or Pressurized Flow.....	13
3.3 Steady Flow .....	13
3.4 Friction Loss (Major Loss).....	14
3.5 Minor Losses .....	17
3.6 Total Minor Losses .....	19
3.7 Total Loss of Head.....	20
<b>CHAPTER-4 DESIGN STANDARDS FOR PIPED IRRIGATION NETWORK .....</b>	<b>21</b>
4.1 General .....	21
4.2 Permissible Velocity .....	21
4.3 Permissible head .....	21
4.4 Exit Pressure at Irrigation Outlet for flow irrigation .....	21
4.5 Exit pressures at Irrigation Outlet for Micro Irrigation .....	21
4.6 Determination of pipe diameter .....	21
4.7 Overburden for buried pipes.....	21

4.8	Land Acquisition .....	22
4.9	Inspection Path.....	22
4.10	Cross drainage works .....	22
4.11	Pump Stand.....	22
4.12	Air vent .....	22
4.13	Vacuum Relief Valves .....	22
4.14	Drain Valves.....	22
4.15	Scour Valves.....	22
4.16	Working Space and Trench size .....	22
4.17	Bedding for Pipes .....	23
4.18	Maximum size of ICA for single point pumping for Micro Irrigation .....	23
4.19	Size of silt to be removed .....	23
	<b>CHAPTER-5 PIPE IRRIGATION NETWORK DESIGN.....</b>	<b>25</b>
5.1	General .....	25
5.2	Classification of Piped Irrigation Network (PIN).....	25
5.3	Economic Size of Pipe.....	26
5.4	Life Cycle Cost Analysis .....	26
5.5	Pipe Materials .....	30
5.6	Structure and Layout of Piped Irrigation Networks .....	44
5.7	Optimization of the Layout of Branching Networks .....	44
5.8	Piped Irrigation Network Design.....	49
5.9	Software Programmes .....	51
5.10	Water Hammer.....	51
5.11	Some examples of Pipe Network analysis .....	52
5.12	Structural Design of Buried Pipelines .....	57
	<b>CHAPTER-6 INTAKE AND DESILTING ARRANGEMENTS.....</b>	<b>63</b>
6.1	General .....	63
6.2	Desilting Arrangements.....	68
6.3	Diggy.....	72
	<b>CHAPTER-7 DESIGN OF PUMPS.....</b>	<b>75</b>
7.1	General .....	75
7.2	Types of Pumps .....	75
7.3	Consideration in Pump Selection .....	75
7.4	Terminology and Definitions .....	76
7.5	Dimensioning of Pump House.....	78
7.6	Power Supply Arrangements.....	78
	<b>CHAPTER-8 OPERATION AND MAINTENANCE.....</b>	<b>79</b>
8.1	General .....	79
8.2	Operation Check list for Pumps .....	79

8.3	Check list for Operation during the irrigation season.....	79
8.4	Maintenance Check List .....	80
8.5	Choking of Pipes by excess silt.....	80
8.6	Maintenance of Pumps .....	80
8.7	Maintenance of Valves.....	81
	<b>CHAPTER-9 FIELD AUTOMATION AND CONTROL.....</b>	<b>83</b>
9.1	General .....	83
9.2	Need for SCADA.....	83
9.3	Features of SCADA.....	83
9.4	Cost.....	84
	<b>CHAPTER-10 PIPED IRRIGATION NETWORK EXAMPLE .....</b>	<b>85</b>
10.1	General .....	85
10.2	Network Layout.....	85
10.3	Chak boundaries, Outlet Location .....	85
10.4	Capacity Statement .....	87
10.5	Canal Option .....	87
10.6	Pipe Option.....	87
10.7	Cost Comparison - Canal Vs Pipe .....	87
10.8	Computer Analysis.....	91
	<b>APPENDIX.....</b>	<b>92</b>

## **PART-II OUTLET TO FIELD**

	<b>CHAPTER-11....OUTLET TO FIELD.....</b>	<b>112</b>
11.1	General .....	112
11.2	Formulation of Guidelines for Pressurised Piped Network .....	112
11.3	Major Components: .....	112
11.4	Water storage tank.....	113
11.5	Pumping unit .....	113
11.6	Filtration unit .....	113
11.7	Piped line distribution network.....	114
11.8	Hydrant/Outlet assembly.....	114
11.9	Estimation of horse power of pumping unit.....	114
11.10	Model Computations for 5000 Ha Command Area .....	115
11.11	Estimation of Peak Crop Water Requirement .....	115
11.12	Size of Storage Tank.....	115
11.13	Capacity of Pump .....	115
11.14	Micro-Irrigation system.....	116
	<b>APPENDIX.....</b>	<b>117</b>
	<b>COMPOSITION OF THE COMMITTEE.....</b>	<b>123</b>
	<b>REFERENCES.....</b>	<b>124</b>

## LIST OF FIGURES

### PART-I

Figure 2.1	Canal Distribution Network (CDN) .....	5
Figure 2.2	Pipe Irrigation Network (PIN) .....	6
Figure 2.3	Scheme of Main Steps of Piped Irrigation Network Project .....	9
Figure 3.1	Free Surface Flow .....	13
Figure 3.2	Pipe or Pressured Flow .....	13
Figure 3.3	Law of Conservation of Mass .....	14
Figure 3.4	Law of Conservation of Energy .....	14
Figure 3.5	Shape of Inlet and Loss Coefficient .....	17
Figure 3.6	Contraction Loss Coefficient (by Gardel) .....	18
Figure 3.7	Enlargement loss, $f_e$ (Experimental Values by Gibson) .....	18
Figure 3.8	Valve Loss Coefficient $f_v$ , Valve Openings .....	19
Figure 3.9	Bend Loss Coefficient, $f_{be}$ .....	19
Figure 3.10	Curve Loss Coefficient, $f_b$ .....	19
Figure 4.1	Pump Stand .....	22
Figure 4.2	Trenching for Pipes .....	23
Figure 5.1	Tree Piped Irrigation Network .....	25
Figure 5.2	Looped Piped Irrigation Network .....	26
Figure 5.3	Optimization of Pump/Pipeline System .....	26
Figure 5.4	Flow diagram with flat rate of annual charges .....	28
Figure 5.5	Flow diagram in case of inflation .....	28
Figure 5.6	Flow diagram for replacement cost .....	28
Figure 5.7	Proximity layout –(a) application of kruksal's algorithm (b) application of Sollin's algorithm.....	45
Figure 5.8	120° Layout - Case of 3 Hydrants.....	45
Figure 5.9	120° Layout – Case of 4 hydrants.....	47
Figure 5.10	120° Layout – Case of 4 hydrants (different Configuration).....	47
Figure 5.11	Least Count Layout.....	48
Figure 5.12	Piped Irrigation Network Optimisation.....	48
Figure 5.13	Pipes in Series.....	49
Figure 5.14	Pipes in Parallel.....	50
Figure 5.15	Network modelled in WHAMO.....	53
Figure 5.16	Output of WHAMO simulations.....	54
Figure 5.17	Pipe network with two loops.....	55
Figure 5.18	Schematic diagram of the model of the pipe network with two loops.....	55
Figure 5.19	Output of WHAMO simulations.....	56
Figure 6.1	Valve tower situated within an earthen dam .....	63
Figure 6.2	Simple Concrete block-Submerged Intake .....	64
Figure 6.3	Wet Intake tower standing in the river or reservoir .....	64
Figure 6.4	Dry Intake tower standing in the river or reservoir .....	64
Figure 6.5	Section of a typical twin well type of river intake .....	65
Figure 6.6	Typical Installation in an Earth dam-sloping Intake (Ref: IS: 11570- 1985) .....	65
Figure 6.7	Approach Geometry- Semicircular Type Intake Structure (Ref: IS: 11570- 1985) .....	66
Figure 6.8	Typical Installation in an Earth dam-Tower Type Intake (Ref: IS: 11570- 1985) .....	66
Figure 6.9	Typical Installation in an Earth dam-Tower Type Intake (Type II) (Ref: IS: 11570- 1985).....	67
Figure 6.10	Typical Installation in a Concrete/Masonry dams (Ref: IS: 11570- 1985) .....	67
Figure 6.11	Water is drawn from Canal Intake through Syphonic action in Balh Valley Medium Irrigation Project in HP .....	69
Figure 6.12	Tube Settler .....	69
Figure 6.13	Lamella clarifier.....	70
Figure 6.14	Flow distribution from a conventional inlet in a tube settler .....	70
Figure 6.15	Tube settler type desilting arrangement in Nadaun Medium Irrigation Project, HP .....	71



Figure 6.16 Aerial View of Tube settler type desilting arrangement provided in Balh Valley Medium Irrigation Project, HP .....	72
Figure 7.1 Head terms used in Pumping .....	76
Figure 7.2 Typical Pump performance curve .....	77
Figure 9.1 Open Control SCADA Network Architecture .....	84
Figure 10.1 Canal Network of Kholra Distributary and Location of Arangi Minor .....	85
Figure 10.2 Contour Map, Chak Boundaries and outlet area.....	86
Figure 10.3 Alignment of Arangi Minor with RD and curves.....	86
Figure 10.4 Tree diagram of Arangi Minor.....	87
Figure 10.5 Canal Cross-sections.....	88
Figure 10.6 Canal L-Section of Arangi Minor Line.....	89
Figure 10.7 Computer Analyses for Arangi Line (UGPL) .....	91

**PART-II**

Figure. 11.1 Systematic layout of the components .....	112
Figure 11.2 Water storage tank .....	113
Figure 11.3 Pumping unit with solar system .....	113
Figure 11.4 Filtration unit.....	114
Figure 11.5 Piped line distribution network .....	114
Figure 11.6 Hydrant / Outlet assembly .....	114

<b>Table No:</b>	<b>LIST OF TABLES</b>	<b>Page</b>
<b>PART-I</b>		
Table 2.1	Comparison of Irrigation efficiency of CDN & PIN .....	12
Table 3.1	Manning's Coefficients of roughness.....	15
Table 3.2	Friction Factors In Darcy-Weisbach Formula .....	16
Table 3.3	Values of Roughness Projection .....	16
Table 3.4	Recommended $C_R$ Values in Modified Hazen-Williams Formula (At 20° C) .....	17
Table 3.5	Loss Coefficient for Sluice Valves.....	18
Table 3.6	Loss Coefficient for Butterfly Valves.....	18
Table 5.1	Illustration of computations for LCC Analysis based on assumed parameters .....	28
Table 5.2	Comparison of various Pipe Materials .....	32
Table 5.3	Various Pipe material & Dia. Available.....	43
Table 5.4	Details of methods applied .....	49
Table 5.5	Values of Impact factor .....	58
Table 5.6	Values of deflection coefficient .....	58
Table 5.7	MS Pipe Deflection for Specified Burial Depth .....	59
Table 6.1	Design of Tube Settlers.....	73
Table 10.1	Cost Comparison – Canal vs Pipe .....	90
Table 10.2	Details of off taking pipes.....	90
<b>PART-II</b>		
Table- 11.1	Cropping pattern for Rabi & Kharif .....	115
Table-11.2	Parameters to compute capacity of pump .....	116

डॉ अमरजीत सिंह  
Dr. AMARJIT SINGH  
सचिव  
SECRETARY  
Tel. : 23710305 / 23715919  
Fax : 23731553  
E-mail : secy-mowr@nic.in



भारत सरकार  
जल संसाधन, नदी विकास और  
गंगा संरक्षण मंत्रालय  
श्रम शक्ति भवन,  
रफी मार्ग, नई दिल्ली-110 001  
GOVERNMENT OF INDIA  
MINISTRY OF WATER RESOURCES,  
RIVER DEVELOPMENT &  
GANGA REJUVENATION  
SHRAM SHAKTI BHAWAN,  
RAFI MARG, NEW DELHI-110 001  
<http://www.wrmin.nic.in>

### Message

Water is precious and a limited natural resource. Development, conservation and management of water as a national resource; overall national perspective of water planning and coordination in relation to diverse uses of water and interlinking of rivers is the prime mandate of Ministry of Water Resources, River Development and Ganga Rejuvenation.

Agricultural sector is the major consumer of water. Conveyance and application of water by traditional methods of open canal network system has inherent problems viz; land acquisition, wastage of farm land, low irrigation efficiency, seepage etc. Use of pressurized pipe system and micro irrigation in the command is envisaged to achieve maximum efficiency in water applications, which will result in coverage of larger areas bridging the gap between Irrigation Potential Created (IPC) and Irrigation Potential Utilised (IPU). Use of underground pressurized pipe systems with outlets in place of field channels to obviate wastage of farm land and efficient use of water is one of the mission objectives of Pradhan Mantri Krishi Sinchayee Yojana (PMKSY).

I am happy to know that Central Water Commission in consultation with various Central Organisations, State Governments, Academic Institutions, Private and other Agencies across the country has brought out "**Guidelines for Planning and Design of Piped Irrigation Network**" for conveyance and application of water with the aim of improving the irrigation efficiency and addressing the land acquisition issues. I hope this publication shall be of immense help to the administrators, planners, designers and implementing agencies in achieving the Prime Minister's vision of *Har Khet Ko Pani and More Crop per Drop*.

Dr. Amarjit Singh

**Narendra Kumar**



**CHAIRMAN**

Central Water Commission,  
MoWR, RD & GR,  
Government of India,  
3<sup>rd</sup> Floor, Sewa Bhawan, R K Puram,  
New Delhi-110066

## **Foreword**

Irrigation practice in the country traditionally has largely been undertaken as Canal Distribution Network starting from rivers, dams and reservoirs for the purpose of carrying water mostly through gravity up to the outlets and from the outlets to the agricultural field through water courses or field channels. The usual flow irrigation through canals results in low water use efficiency; both in terms of conveyance efficiency and field application efficiency.

With rising population and lifestyle changes and the consequent demand on water resources, the water available for irrigation will get reduced in the near future. Moreover, water availability per capita has reduced substantially and India is already in water scarce zone and climate change may further aggravate the problem. India has to adapt itself in this changing scenario. Efficiency has to be brought in every sector of water utilisation including irrigation and Piped Irrigation Network is a step in that direction.

Efficient irrigation system would help in achieving the objective of the more crop per drop and thus increase the farmers' income. One such window for achieving this is formation of robust micro irrigation system with piped irrigation network for conveyance, distribution and application. For its introduction, robust guidelines taking into account the success and failure of the past is the need of the hour. As it is a recent concept, no readymade guidelines/BIS standards are available in India. Keeping in view the importance of the matter as well as participation of stakeholders, a committee is constituted under the chairmanship of Member (WP&P), CWC in April, 2016 to formulate guidelines on Piped Irrigation Network. Accordingly, the "*Guidelines for Planning and Design of Piped Irrigation Network*" have been prepared. This document has been prepared, considering the technical advancements and with active participation of the experts in the field of water resources, irrigation, water supply and agriculture from various State Governments, Central Agencies and professionals in the private sector.

I would like to congratulate the Committee and all the officials of CWC involved in preparing these comprehensive guidelines through a widely consultative process. I sincerely hope that the guidelines shall be used extensively as reference document as well as a guide for action by policy-makers, administrators and technical professionals.

( Narendra Kumar )

S Masood Husain



**MEMBER (WP&P)**

Central Water Commission  
MoWR, RD & GR,  
Government of India  
2<sup>nd</sup> Floor, Sewa Bhawan,  
R K Puram, New Delhi-110066

## **Preface**

Irrigation is the largest consumer of water. However, the water use efficiency in irrigation is low. One of the measures for improving this efficiency is the use of micro irrigation system in the farmer's field. Further canal system requires large area and consequently involves land acquisition issues. This has led to the use of underground piped network replacing the open canal system in some parts of the country, while reducing the water loss.

Guidelines/BIS standards regarding piped irrigation networks are not available in India so far. Considering its need, Ministry of Water Resources, RD & GR constituted a Committee under the chairmanship of Member (WP&P), CWC to formulate guidelines on Piped Irrigation Network. The Committee included representatives of various State Governments, Central agencies including BIS, private organizations and pipe manufacturers. The composition of the committee and its terms of reference are annexed at the end of this document.

The Committee held five meetings at New Delhi since 21<sup>st</sup> July 2016. The Committee in its first meeting decided that a workshop could be convened where national/ international participants may share their experiences along with State Governments and Agencies involved in Piped Irrigation System. Accordingly, an international workshop with the collaboration of ICID was held during March 17-18, 2017 at CWC, New Delhi wherein delegates from various State Irrigation/Water Resource Departments, Central agencies and private organisations from India as well as experts from countries like Australia, China and Turkey participated. This provided valuable inputs in the preparation of the guidelines. Various related issues were deliberated in detail and the guidelines were finalized by the Committee.

These guidelines for "Planning and Design of Piped Irrigation Network" comprising 11 Chapters are divided into two parts. Part-I of the guidelines covers from source to outlet containing 10 chapters and the Part-II covers from outlet/hydrant to field application (Micro-Irrigation part). An attempt has been made to include all relevant aspects of piped irrigation network system. Emphasis has been laid for inclusion of design standards for various components involved in piped irrigation network. This would help in standardising the design practice being followed throughout the country. Designs illustrations have been provided for each component of the system wherever possible. Experiences and case studies of some projects have also been incorporated in the document.

At the outset, I would like to place on record my sincere thanks and gratitude to all the members and invitees of the Committee for their valuable contribution.

The formulation of these guidelines would not have been possible but for the untiring and dedicated efforts of Shri Pradeep Kumar, then Chief Engineer (PAO) and presently Member(RM), CWC and his team for convening meetings and conducting international workshop, Shri T K Sivarajan, Chief Engineer (Design), CWC and his team for preparation and final compilation of the whole document of Part-I and Shri Navin Kumar, Chief Engineer (Irrigation Management), CWC and his team for preparing the Part-II of the guidelines for Micro Irrigation System. I gratefully acknowledge and appreciate their sincere efforts.

I hope these guidelines will be very useful to the planners, designers, implementing authorities and all concerned regarding various aspects of piped irrigation network including micro irrigation system in the country.

Any suggestions for improving the contents will be highly appreciated.

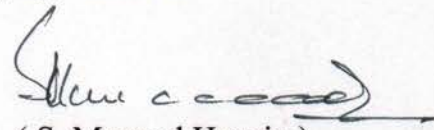

( S. Masood Husain )

## **ACKNOWLEDGEMENTS**

### **I. Co-ordination and Consultation Team – Project Appraisal Organisation(PAO), CWC**

1. *Shri Pradeep Kumar, Member(RM), CWC (Then Chief Engineer, PAO)*
2. *Shri Piyush Ranjan, Director, PA(N)*
3. *Shri Anil Kumar Singh, Dy Director, PA(N)*
4. *Shri Sharad Kumar K, Asst Director, PA(N)*
5. *Shri Durgendra Singh, Asst Director, PA(N)*
6. *Smt Manju Rani, PA to Director, PA(N)*

### **II. Design aspects, Drafting & Compilation Team – Design(N&W) Organisation, CWC (Part-I)**

1. *Shri T K Sivarajan, Chief Engineer, Designs(N&W), CWC*
2. *Shri P Devender Rao, Director, BCD(N&W)*
3. *Shri Panneer Selvam L, Deputy Director, HCD(N&W)*
4. *Shri Rakesh Gaurana, Deputy Director, BCD(N&W)*
5. *Shri Praveen Annepu, Assistant Director, BCD(N&W)*
6. *Smt Harsitha, Assistant Director, HCD(N&W)*

### **III. Irrigation Management Team-Irrigation Management Organisation(IMO), CWC (Part-II)**

1. *Shri Navin Kumar, Chief Engineer, IMO, CWC*
2. *Shri G L Bansal, Director, CWC*
3. *Shri B. C. Vishwakarma, Director, IP(S)*
4. *Shri.Ashish Kumar, Assistant Director, IP(S)*





## PART-I

### SOURCE TO OUTLET

*This part covers various aspects with regard to Planning, Design, Operation and Maintenance of Pipe Irrigation Network from the source of water to the outlet from where water actually ready for delivery to the individual chak.*



# CHAPTER - 1

## INTRODUCTION

Historically Irrigation development in the country has been undertaken as Canal Distribution Network emanating from rivers, dams and reservoirs for the purpose of carrying water mostly through gravity up to outlets and from outlets to agricultural field through water courses or field channels. In earlier times canals were unlined; later on these unlined canals have been improved by lining to increase their water carrying efficiency which led to extend water deliveries to additional fields which had not been irrigated previously. Canals are designed hydraulically to provide the most efficient cross section for the transportation of irrigation water. There is no further scope in improving the efficiency of the hydraulically most efficient canals section with most efficient lining. Therefore the overall efficiency that can be achieved by canal conveyance and distribution has reached the upper limit which is about 35-60%.

With the increasingly greater demand on limited water supplies in many parts of country, there is an urgent need for its efficient utilization by reducing losses at various reaches in the irrigation system. Replacement of existing canals with pipe lines or new schemes with pipe lines wherever feasible in order to improve irrigation efficiency or to further extend the area of irrigated agriculture is the need of the hour. Field application of water through micro irrigation methods improves overall efficiency of the project to a great extent. Piped irrigation can be accomplished many a times through gravity and/or use of pumps to lift the water into the distribution network.

With rising population, demand for commodities and change in life style, more and more demand for water resources from other sectors is projected, leaving less water for irrigation as the availability is finite in nature. With rising population, per

capita water availability has reduced drastically from 5177 cum in the year 1951 to 1567 cum in the year 2011. As per international standards, ***now India is already in water stress zone*** (if water availability is between 1000 to 1700 cum per year) with threats of climate change may further aggravate the problem. By the year 2050, with projected population of the order of 1.6 Billion, the water availability will further reduce to 1140 cum nearing to water scarce situation. India as a country has to adopt itself to this changed scenario. Efficiency has to be brought in each water use activity including irrigation for sustaining the food, water, shelter and employment requirement of the human and animal population.

Piped Irrigation System provides one of such options which if implemented properly can curtail irrigation water demand without compromising with net irrigation requirement (NIR) but by improving the water use efficiency. The estimated overall efficiency with piped irrigation network is of the order of 70-80%. Experience gained from several States and many Countries in arid and semi-arid zones has shown that Piped Irrigation Network (PIN) techniques are replacing successfully the traditional open canal methods. However, some of the projects already constructed with PIN are not showing expected performance due to various reasons including improper planning and lack of maintenance.

*For proper planning, design and implementation of Piped Irrigation Network in the country, the need for suitable guidelines is felt necessary by the Ministry of Water Resources, River Development and Ganga Rejuvenation (MoWR, RD&GR) and Central Water Commission (CWC). Accordingly, this guideline on PIN has been prepared.*

*This Guideline consists of two Parts. Part- I covers Planning and Design of Piped Irrigation Network (PIN) from the Source of water to Outlet.*

*The Portion below the Outlet to Field / Micro Irrigation is dealt in the Part-II of the Guidelines (Below Minor Up To Micro Irrigation System in the Field)*

### 1.1 Piped Irrigation Network (PIN)

A Piped Irrigation Network (PIN) is a network of installation consisting of pipes, fittings such as valves, pumps (if necessary) and other devices properly designed and installed to supply water under pressure from the source of the water to the irrigable area.

For surface irrigation method, where large heads are not required, the underground pipe line system is used which is essentially a low pressure system, also known as ‘open or semi closed’ system. This system is open to atmosphere and where the operating pressure seldom exceeds 5m to 6m. The available level differences of falling topography provide the operating head for the system under gravity for the low pressure flows.

Where large heads are required, underground pipe line system is used which is essentially a high pressure system, also known as ‘closed’ system. This system is not open to atmosphere and where the operating pressure exceeds 10m for drip and 20m for sprinklers. Usually gravity head is not sufficient to create such a high pressure; therefore, pumps are used for this kind of system.

### 1.2 Advantages of Piped Irrigation Network over Canal Distribution Network (CDN)

The following are the advantages of PIN over Canal Distribution Network (CDN):

- i. As most of a piped distribution system underground, right of way problems are significantly reduced, allowing more direct and rational layouts to be chosen. Because outlet location is not limited by topography, pipe systems are better able to accommodate existing patterns of land ownership with the minimum of disruption compared with new irrigation development using CDN.
- ii. Cross Drainage and Cross Masonry (Communication) structures can be omitted or minimized.
- iii. Irrigation works become obstacles in the way of free drainage of water during rainy season and thus results in submerging standing crops and even villages.
- iv. No damage due to heavy rainfall or flood during monsoon.
- v. More Suitable option for flood prone area.
- vi. No hindrance in movement to the farmers and farm equipments.
- vii. Increase in CCA as compared to canals, as the water losses are negligible and acquired land for canal network can also be used for cultivation as Piped Irrigation Network is under ground.
- viii. Better option for undulating fields.
- ix. Because of shorter transit times for water from source to field, lower conveyance losses and the smaller volumes of water in the conveyance system, pipe systems can deliver a supply which is more flexible in both duration and timing, in a way not possible CDN, so enabling intensification and diversification into higher value crops.
- x. Less execution time for PIN as compared to CDN.
- xi. The important targets of the modernization of irrigation schemes and digital management will be achieved when water is delivered through Piped Irrigation Network.
- xii. In case of canals, the marshes and the ponds caused by excessive seepage, in course of time become the colonies of the mosquito, which gives rise to vector borne diseases and this can be minimized by adopting Piped Irrigation Network. Further salinity and water logging can be reduced.
- xiii. Increase in project efficiency of the Piped Irrigation Network is about 20% as compared to CDN.
- xiv. Fertilizers/chemical can also be mixed with the water.
- xv. Quantity of water supplied by Piped Irrigation Network is easily measureable; hence water auditing can be accurately measured.

### **1.3 Disadvantages of Piped Irrigation Network**

- i. Initial cost is generally higher as compared to CDN.
- ii. Piped Irrigation Network may not be suitable if the irrigation water contains large amount of sediments. Desilting arrangement would be necessary in such cases.

### **1.4 Application of Piped Irrigation Network**

The Pipe Irrigation Network systems especially are to be preferred over CDN alternatives in the following situations:

- i. Where water is valuable both, in terms of the crops which can be grown and limited availability as evidenced by low reservoir capacity or restrictive controls on water abstraction from river or groundwater sources,
- ii. Where poorly cohesive soils would result in high seepage losses from open canals,
- iii. Where irrigable land cannot be reached by an open canal system due to high ground levels.



## CHAPTER - 2

# PIPED IRRIGATION NETWORK (PIN) PLANNING

### 2.1 General

A Piped irrigation network is a network installation consisting of pipes, fittings and other devices properly designed and installed to supply water under pressure from the source of the water to the irrigable area.

Pipelines also permit the conveyance of water uphill against the normal slope of the land and, unlike open channels, can be installed on non-uniform grades. The use of buried pipe allows the

most direct routes from the water source to fields, and minimizes the loss of productive land (since crops can be planted on the fields above the pipelines).

An analogy between the Canal Distribution Network (CDN) and Pipe Irrigation Network (PIN) is pictorially depicted in Fig 2.1 & Fig 2.2 below.

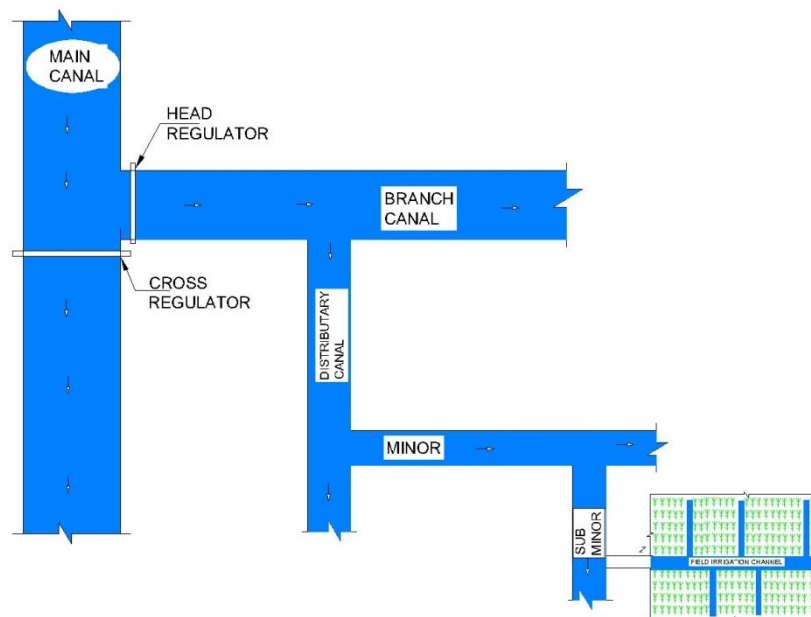

Figure 2.1 Canal Distribution Network (CDN)

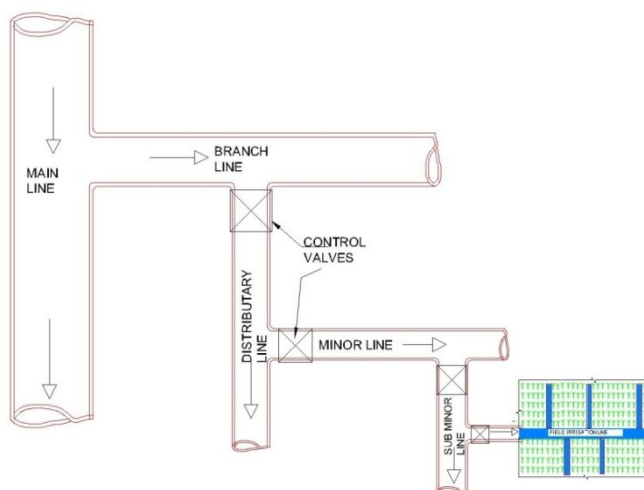

Figure 2.2 Pipe Irrigation Network (PIN)

## 2.2 Piped Irrigation Network Planning

The planning and layout of Piped Irrigation Network unlike CDN is not controlled by the command area to be irrigated and the source of supply. The layout of main lines and branches is generally fixed on the consideration of economy. For the layout of minors and distributaries, points of off take may be suitably selected but their layout is more or less governed by the blocks of areas to be irrigated taking into consideration watersheds and drainages. The main lines and branches are feeder lines for distributaries and generally no irrigation is done directly from them. Irrigation outlets are provided on distributaries or minors off taking from distributaries.

The stage for general planning and layout of Piped Irrigation Network arises after the general feasibility of the project has been established. The area to be irrigated by pipe line system shall be planned by preparing land use maps, preferably on a scale of 1:50,000, showing on them the area already under cultivation, soil types, habitation roads, drainage and contours of the area. The intensity of irrigation to be provided in the project shall be decided after taking into account the factors like socio economic factor, area and intensity of the irrigation being achieved on the other projects in the neighborhood etc.

The important crops of the area and their water requirements shall be determined in consultation

with the department of agriculture and the agriculturist of the area proposed to be served allowing for the anticipated change in crop pattern due to introduction of wet farming in the area. Knowing thus the duty for various crops, the area under cultivation under different crops, the intensity of irrigation, the culturable area to be commanded shall be worked out and marked on the map. Areas that are higher and may not be supplied with the flow/gravity irrigation should be marked on the map with separate colour and the pumping requirements for that area need to be worked out separately. *Main steps in planning of Piped Irrigation Network Scheme as per FAO shown in fig 2.3.*

## 2.3 Data Required for Piped Irrigation Network Planning

The following data is required for planning and layout of a Pipe system:

- i. Topographical map of the area
- ii. Subsurface data
- iii. Texture and salt component of the soil
- iv. Soil characteristics including mechanical properties and shear parameters
- v. Permeability of the soil in relation to seepage losses
- vi. Rainfall data
- vii. Water availability Subsoil water level in the area and quality of the underground water
- viii. Possibility of water logging and salination
- ix. Availability of suitable construction material
- x. Existing drainage and drainage facilities



- xi. Existing crop pattern
- xii. Existing communication and transportation facilities
- xiii. Socio economic study and agro economic survey of the project area
- xiv. Adequate investigation should be carried out to collect the data given by digging trial pits and bore holes, where necessary, to ascertain the nature of soil encountered along different alternative alignments.

## 2.4 Route Selection of Pipe Network

- i. Length of pipelines in the network is minimal, as much as possible.
- ii. Pumping is avoided if possible or least pumping effort is needed.
- iii. High water pressure is avoided.
- iv. Numbers of appurtenances (gate valve, check valve, drain, air release valve, pressure break valve) are minimized.
- v. Very low or high velocities are avoided because low velocities cause sedimentation in pipes and high velocities cause corrosion of pipe.
- vi. This results into most economical system.
- vii. If horizontal pipe sections are used, release of air and drain the dirt will not be possible. So, in case of horizontal ground surface, artificial slopes are given to pipes to be laid.

## 2.5 Guiding Principle for deciding Carrying Capacity of Pipe/Canal

The carrying capacity of the Piped Irrigation Network/CDN shall be maximum of;

- a) The carrying capacity calculated on the basis of the fortnightly crop water requirement as per the design cropping pattern and planned Irrigated Cropped Area (ICA) of the project as per Administratively Approved project report but considering 12 days flow period in a Fortnight.

OR

- b) The carrying capacity calculated on basis of due water entitlement of the Culturable Command Area (CCA) of the Pipe line or distributary as per the provisions Acts of State Level Authorities.

OR

- c) The carrying capacity calculated on basis of the operation schedule of the pipe/canal or distributary. The operation on the basis of 12 days on and 2 days off in a fortnight is preferable or as per the requirement.

The procedure to work out carrying capacity of canal for above alternatives is as given below:

### 2.5.1 Carrying capacity of Pipe on the basis of crop water requirement:

The fortnightly crop water requirement of the planned ICA of the canal/pipe shall be calculated by Modified Penman Method. For this, the cropping pattern approved by concerned Authority shall be considered. The ICA of the Pipe line shall be decided after completion of detailed command area survey of project. Once the design cropping pattern and ICA of the Pipe is finalized the fortnightly crop water requirements / Net Irrigation requirement (NIR) is worked out by Modified Penman Method. The gross Irrigation requirement (GIR) of canal/pipe shall be calculated by adding the conveyance losses up to crop root zone as indicated in Table 2.1 of Para 2.7.

For estimating Crop Water Requirement “A Guide for Estimating Irrigation Water Requirements” (Published by MoWR RD & GR, Yr-1984) may be referred. It can also be estimated by using software like *CROPWAT* by *FAO*.

### 2.5.2 Design discharge of Pipe on the basis of due water entitlement as per provisions Acts of State Authorities:

As per the provisions in Acts of Water Resources Regulating Authority of States, the irrigation water is to be supplied to the WUAs on volumetric basis as per their due water entitlement. The outlet capacity in  $m^3/s$  or  $l/s$  authorized per hundred hectares of Culturable Commanded Area (CCA) is called Basic Discharge Coefficient (BDC). The BDC not only defines the size of outlet for each outlet area but also form the basis for the design of the distribution pipes/canals in successive stages. The BDC depends on the agro climatic zones and defined at chak head.

It is essential to decide the master plan of WUA & their water entitlement at design stage. The canal/pipe carrying capacity shall be decided such that due water entitlement will be supplied to all the WUAs in command area of all lines of project.

To calculate the canal/pipe carrying capacity on basis of water entitlement, following guidelines shall be followed;

- a) The master plan of all the probable WUAs in command area of project is to be prepared, once command area survey and tentative alignment of all the canals/Pipe line is finalized.
- b) The locations where water is to be supplied to the WUA is to be identified.(entry point in jurisdiction of WUA)
- c) The water entitlement of the individual WUA and all the WUA on individual canal/Pipe line shall be worked out. The water entitlement of WUA and entire canal/pipe line shall be decided on basis of the CCA of WUA and CCA of canal/pipe line. The total due water entitlement thus worked out shall be considered as Net water requirement (NIR) of canal/pipe

line. By adding canal/pipe line losses (efficiencies) the gross water requirement (GIR) is calculated. The season wise and fortnightly gross water entitlement and net water entitlement for canal/pipe shall be worked out. On the basis of fortnightly water requirement, the canal/pipe design carrying capacity shall be decided.

Efficiencies & design rotation period of canal to be considered shall be as given in Table 2.1 below.

### **2.5.3 Design discharge of Pipe/canal on basis of the operation schedule:**

The ultimate aim of pipe/canal conveyance system is to provide the irrigation water to the planned ICA of the project. In flow irrigation system the rotational water system is followed and water is supplied by rotations of 14 days as per the requirement. To supply the water in 14 days for entire planned ICA in command, it is very essential to prepare the operation schedule of all the minor, distributary, and branch Lines off taking from main Line/Canal at design stage.

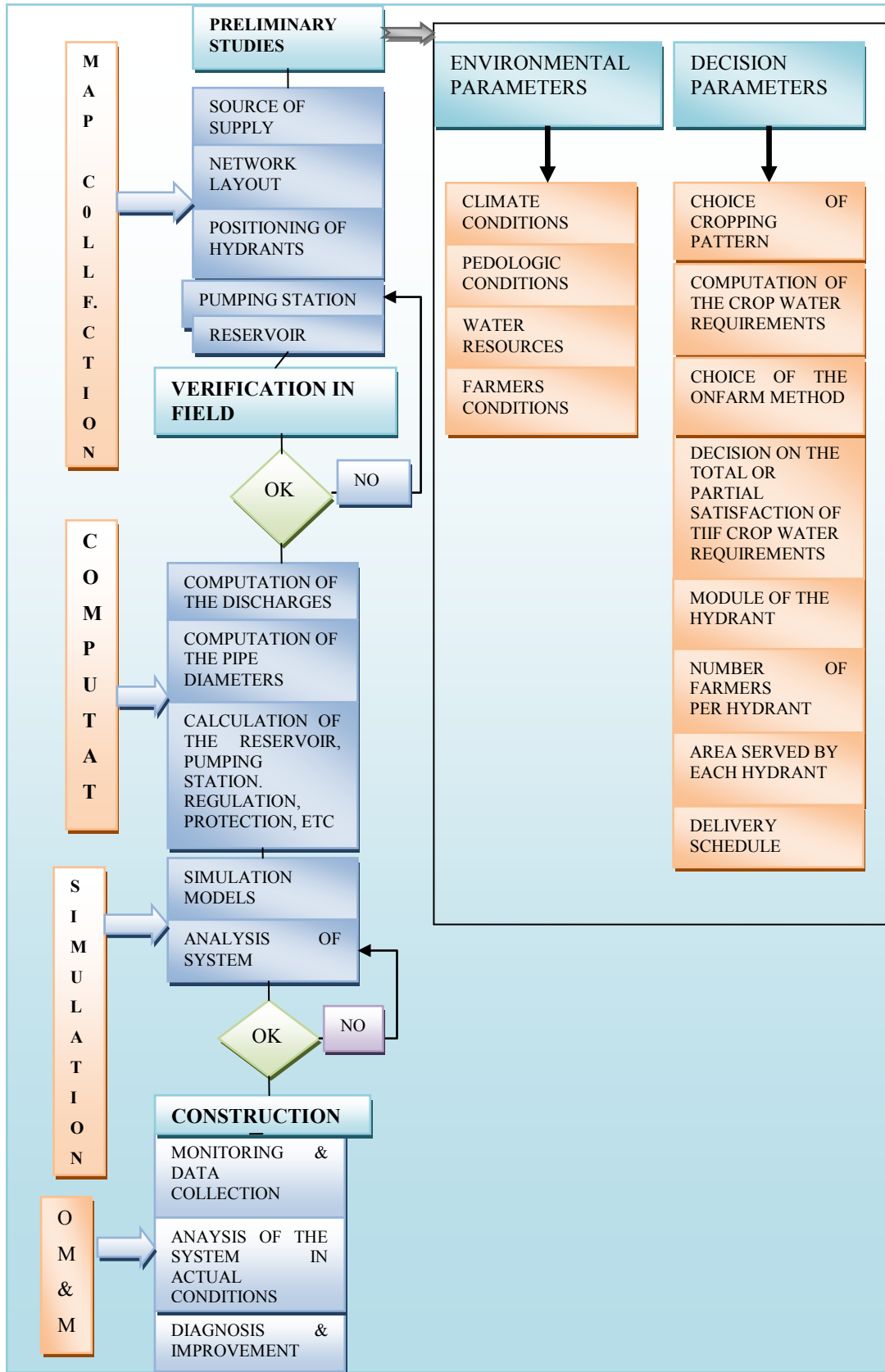

Figure 2.3 Scheme of Main Steps of Piped Irrigation Network Project

In case of Pipe irrigation system, it shall be designed in such a way that entire outlets in the command is run at the same time and rotation of turn on the basis of holding of CCA, among the beneficiaries in the command of an outlet. The operation schedule of every individual off taking line shall be planned such that the flow period of the outlet is limited to 12 days in a fortnight 14 days. Accordingly the design carrying capacity is provided to each minor, distributary and branch line. The operation schedule of all off individuals grouped in the command of an outlet shall be tabulated in a statement, where off off-take and their rotation period shall be written from tail to head. On basis of above guidelines, the carrying capacity of canal shall be worked out.

Canal efficiencies & design rotation period of canal to be considered shall be as given in *Table 2.1*.

## 2.6 Design of a Network for Irrigation by Rotation

When pipe irrigation system is designed to run entire outlets in the command at the same time. Due consideration must be given to strictly maintain the water level in the source. Abusive use of water is immediately detected at once by the rightful user whose supply vanishes in so far as the area of the chak/block is comparatively very small.

With Piped Irrigation Network, it can be easily designed to kept the discharge of pipe outlet proportionate to it culturable area, and entire outlets to run at a time, hence there is no head, middle and tail reach differentiation of the command. It is essential to form user group before execution of the Piped Irrigation Network and hand over the network immediately to the user group for further supervision and protection.

With Piped Irrigation Network, a hydrant is provided to an individual having farm holding more than 2 hectare in a command of an outlet. Rotation only among the hydrant is necessary and it can be performed in following way.

### 2.6.1 Rotation at hydrant level

Each outlet of the network is supplied with the duty of water corresponding to the total area served by the outlet. This discharge or stream size is then rotated through the hydrant provided at individual plots in turn and for a period of time proportional to their size.

### 2.6.2 Rotation at branch level

In the case of small estates, the stream size equivalent to the duty of the area served by one hydrant might prove to be insufficient. This situation can be overcome by grouping several hydrants on a given branch. It is the duty corresponding to the area serviced by the branch which is then rotated to each hydrant in turn. A flow regulator corresponding to the stream size is placed at the head of the branch. Organized in this way, the branch has the same function as the sub-minors of an open-channel irrigation system.

The general structure of the network must be designed to allow for a division of the sector into blocks each of which is serviced by a specific branch. No hydrant may be connected directly to the network upstream of the branches which supply the blocks. The layout of the upstream components of the network can be optimized.

## 2.7 Preliminary Carrying Capacity of Distributary / Minor

Detailed layout planning of Piped Irrigation Network (PIN) should be done after completion of detailed command survey. The procedure for deciding carrying capacity of Distributaries / Minor is given below:

- i. It shall be presumed that the fortnightly peak water requirement at the outlet head with Piped Irrigation Network is to fulfill with a flow period of 12 days, in a fortnight. The discharge at the chak head is kept proportionate to the chak areas. Thus the time of period of entire outlets is constant and delivering (equitable distribution) same amount of total volume of water per ha.
- ii. Plan Chaks (5-8 ha) size to receive 5 to 7 lps discharge at outlet head, suitable for surface water application methods.

- iii. Estimate maximum running days of PIN (Entire outlets) in the respective fortnight for water requirement by using appropriate efficiency from root zone to outlet head having proportionate discharge.
- iv. Determine carrying capacity of minor / distributary in different reaches considering appropriate conveyance efficiency as given in Table 2.1.

## 2.8 Procedure for Deciding the Carrying Capacity of Main / Branch Line

- i. Prepare a statement of fortnightly net irrigation requirement (NIR) at root zone in mm and cum as per methods given in Para 2.4 for approved crop pattern for unit irrigation command area (ICA) Say 100 ha or 1000 ha.
  - ii. Select the fortnight having maximum irrigation requirement i.e. peak water requirement and use this peak water requirement for designing the system.
  - iii. Convert the peak water requirement of root zone to the requirement at Main Canal/Pipe or Branch head using appropriate efficiencies.
  - iv. Workout the total volume of water required at canal head for complete ICA of the system. Convert it to CCA.
  - v. Workout Canal/Pipe capacity for delivering the peak volume in a given flow period (if rotation is adopted for distributaries use 12 days flow period for the peak rotation).
  - vi. Increase the capacity by using capacity factor.
- In a similar manner workout the capacity of canal in different reaches considering respective I.C.A.

## 2.9 Water Losses and Irrigation Efficiencies

To account for losses of water incurred during conveyance and application to the field, and efficiency factor should be included while calculating the project irrigation requirements. The project efficiency is normally divided into three stages each of which is affected by a different set of conditions.

- a) **Conveyance Efficiency,  $E_c$**  : Ratio between water received at inlet to a block of fields and that released at project head.

- b) **Field Canal/Pipe line efficiency,  $E_b$**  : Ratio between water received at the field inlet and that received at the inlet of the block of fields.
- c) **Field application Efficiency,  $E_a$**  : Ratio between water directly available to the crop and that received at the field inlet.
- d) **Project Efficiency,  $E_p$**  : Ratio between water made directly available to the crop and that released at the head works, or  $E_p = E_a E_b E_c$
- e) **Distribution Efficiency,  $E_d$**  :  $E_b E_c$
- f) **Farm Efficiency,  $E_f$**  :  $E_a E_b$

Conveyance losses in **canals** consist of two components i) Evaporation losses and ii) Seepage losses. The evaporation losses depend on the climatic zone and temperature variation whereas the seepage losses depend on the type of sub-soil, Ground water levels and type of lining and wetted area of the canal. **With most effective lining and most efficient canal section the adopted efficiency for canals** are 0.90 for Main/Branch Canal, 0.90 for distributary, 0.87 for minor/sub-minor and 0.90 for field channels. With the above the canal conveyance efficiency from source to minor works out to be  $0.90 \times 0.9 \times 0.87 \times 100 = 70.5\%$  and *Source to Field Channel (Distribution Efficiency)* is about 63% ( $70.5\% \times 0.9$ ).

As the piped net works are a closed system, there will be neither evaporation losses nor absorption/seepage losses except some leakages at fittings. Therefore, Design conveyance efficiency from Source to Minor should not be lower than 0.95 and with Field Canal/Line Efficiency of 0.95, the project efficiency works out to be about 90% ( $.95 \times 95\%$ ).

### 2.9.1 Field Application Efficiency

For the purpose of working out the water requirement at the head of the pipe line the field application efficiency for micro irrigation as specified in part-II of the guidelines shall be adopted as not less than 90% in case of drip and not less than 75% in case of sprinkler irrigation. In case of surface irrigation methods, the field application efficiency of not less than 60 % for non- ponded/ponded crops.

### 2.9.2 Project efficiency

Over all irrigation efficiency for micro irrigation with sprinkler shall not be less than 68% (95% $\times$ 95% $\times$ 0.75) against the present canal based conveyance system of 47.25% (70% $\times$ 90% $\times$ 0.75). Similarly for drip irrigation, it shall not be less than 81.23% (95%  $\times$  95%  $\times$  0.9) against the present canal based conveyance system of 56.7% (70% $\times$ 90% $\times$ 0.90).

### 2.9.3 Comparison of project efficiency based on Canal Vs Pipes

Table 2.1 gives a comparison of indicative project Irrigation efficiency of Canal Distribution Network (CDN) and Piped Irrigation Network (PIN).

### 2.10 Capacity Factor:

It is experienced that after construction of the conveyance system, the various unanticipated water demands as mentioned below arises due to various reasons which affects the carrying capacity of system assumed at the time of design.

- i. The drinking and industrial water requirement demands.
- ii. The letting out of water in rivers, nala during scarcity period.
- iii. The demands for lift irrigation schemes on uncommand side of the Canals/Lines.

- iv. The increased water demand due to the rich cropping pattern (Water intensive) adopted by farmers in comparison with the cropping pattern provided in Administrative Approved Project Report.
- v. The demand for letting the water in storage tanks in command area and recharging of the command area during monsoon period.
- vi. Increase in ICA of project with aging (ICA of project becomes equal to CCA due to conjunctive water use)

The above are the unanticipated water demands which could not be avoided. However it becomes very difficult to full fill the above demands simultaneously with regular irrigation water demands. Ultimately the rotation period of canal/pipe line gets prolonged which badly affects the irrigation management and resulting in reduction in yield of the crops. In order to take care of the unanticipated demands in future, some provision is to be made in the carrying capacity of main and branch lines by adding capacity factor. For the design purpose, a capacity factor of 1.10 shall be considered for Main line and Branch lines while deciding carrying capacity. No allowance is made for distributaries and minors as the capacity of these can be increased by increasing velocity without much loss in head

Table 2.1 Comparison of Irrigation efficiency of CDN & PIN

Method of conveyance/ irrigation		Micro Irrigation		Surface Irrigation
		Sprinkler	Drip	
Canal based Conveyance	Conveyance Efficiency (%)	70	70	70
	Field Canal Efficiency	90	90	90
	Field Application efficiency (%)	75	90	60
	<b>Overall efficiency (%)</b>	<b>47.25</b>	<b>56.7</b>	<b>37.8</b>
Pipe based Conveyance	Conveyance Efficiency (%)	95	95	95
	Field Pipe Efficiency	95	95	95
	Field Application efficiency (%)	75	90	60
	<b>Overall efficiency (%)</b>	<b>67.68</b>	<b>81.23</b>	<b>54.15</b>
<b>Increase of overall efficiency (%) (Pipe against Canal )</b>		<b>20.43</b>	<b>24.53</b>	<b>16.35</b>

Source:

a) *FAO, Irrigation Water Management: Irrigation Scheduling*

b) *Guidelines for Estimating Irrigation Water Requirement (Technical Series-2), Ministry of Irrigation, GoI, May 1984*

**Average increase in overall efficiency is about 20%. By adopting Piped Irrigation Network system the most important goal of National Water Mission of improving irrigation efficiency by 20% can be achieved.**

## CHAPTER - 3

# HYDRAULICS OF PIPE FLOW

### 3.1 Free Surface Flow

The flow in an open channel or in a closed conduit having a free surface is referred to as free-surface flow or open-channel flow (Figure 3.1). Free surface is usually subjected to atmospheric pressure.

### 3.2 Pipe Flow or Pressurized Flow.

A conduit flowing full will have no free surface, then the flow is called pipe flow, or pressurized flow (Figure 3.2).

### 3.3 Steady Flow

#### 3.3.1 Law of conservation of Mass

If it is assumed that water is incompressible, from the law of conservation of mass the Continuity equation of flow can be established as follows (Fig 3.3).

$$Q = A_1V_1 = A_2V_2 = A_3V_3 = \text{Constant}$$

Where,

Q = Discharge

$A_i$  = Cross-sectional area

$V_i$  = Velocity of flow

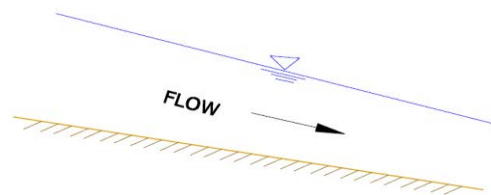

Open Channel Flow

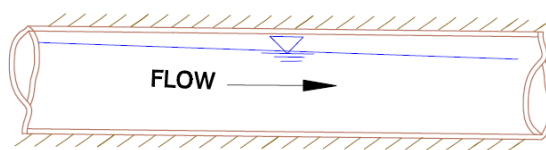
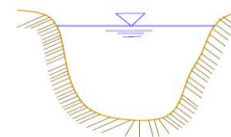

Free surface flow in closed conduit

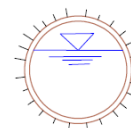

Figure 3.1 Free Surface Flow

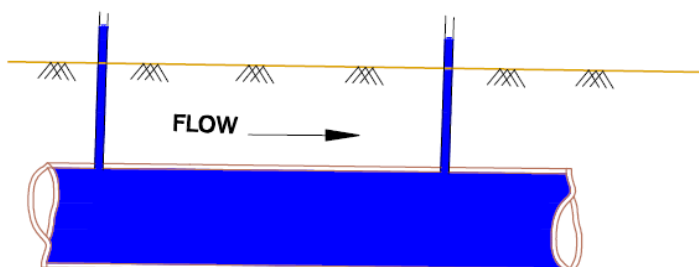
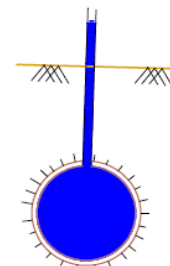

Figure 3.2 Pipe or Pressurized Flow



**3.3.2 Law of Conservation of Energy**

The total energy of pipe flow consists of elevation head, pressure head and velocity head. Between Point (1) and (2), total energy may be conserved in perfect fluid (Figure 3.4). However, if the water begins to move, head loss generated by friction will occur. So, actually the energy equation will be as follows.

$$Z_1 + \frac{p_1}{w} + \frac{V_1^2}{2g} + \Delta E = Z_2 + \frac{p_2}{w} + \frac{V_2^2}{2g} + \Delta H$$

Where,

$\Delta E$  is energy addition to the system by pump,

$\Delta H$  is the total head loss between points (1) and (2)

It is very important to estimate the head losses for hydraulic engineering in steady condition.

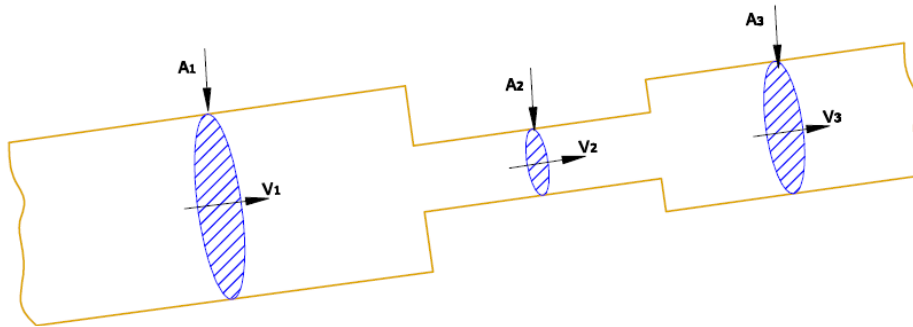

Figure 3.3 Law of Conservation of Mass

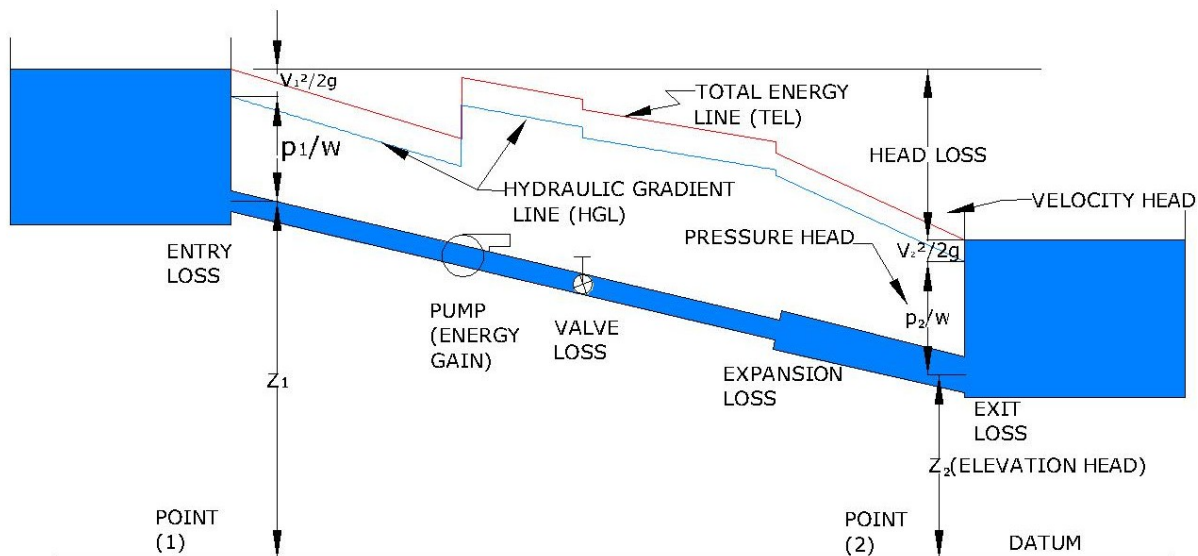

Figure 3.4 Law of Conservation of Energy

**3.4 Friction Loss (Major Loss)**

There are a various formulae available for calculating the head loss in pipes. However, Hazen-Williams formula for pressure conduits and Manning’s formula for free flow conduits have been popularly used.

**a) Hazen William Formula**

$$V = 0.849C \cdot r^{0.63} S^{0.54}$$

$$V = 4.567 \times 10^{-3} C \cdot d^{0.63} S^{0.54}$$

$$Q = 1.292 \times 10^{-5} C \cdot d^{2.63} S^{0.54}$$

Where,

- Q = discharge in cubic metre per hour
- D = diameter of pipe in mm
- V = velocity in m/s
- r = hydraulic radius in m
- S = slope of hydraulic grade-line (Head loss/ Length of conduit) and
- C = Hazen Williams coefficient

**b) Manning’s formula**

$$V = \frac{1}{n} r^{\frac{2}{3}} S^{\frac{1}{2}}$$



where

- V = velocity in m/s
- r = hydraulic radius in m
- S = slope of hydraulic grade-line
- N = Manning’s coefficient of roughness (Table 3.2)

The coefficient of roughness for use in Manning’s formula for different materials as given in *Table 3.1*. may be adopted generally for design purposes unless local experimental results or other considerations warrant the adoption of any other lower value for the coefficient. For general design purposes, however, the value for all sizes may be

taken as 0.013 for plastic pipes and 0.0015 for other pipes.

**c) Darcy-Weisbach’s Formula**

$$S = \frac{H}{L} = \frac{fV^2}{2gD}$$

where,

- H = head loss due to friction over length L (m)
- f = dimensionless friction factor (*Table 3.2*)
- g = acceleration due to gravity in m/s<sup>2</sup>
- V = velocity in mps
- L = length in meters
- D = diameter in meters

**Table 3.1 Manning’s Coefficients of roughness**

Type of lining	Condition	n
<b>Glazed coating of Enamel Timber</b>	In perfect order	0.01
	a) Plane boards carefully laid	0.014
	b) Plane boards inferior workmanship or aged	0.016
	c) Non-Plane boards carefully laid	0.016
	d) Non- plane boards inferior workmanship or aged	0.018
<b>Masonry</b>	a) Neat Cement plaster	0.013
	b) Sand and cement plaster	0.015
	c) Concrete, Steel trowled	0.014
	d) Concrete, wood troweled	0.015
	e) Brick in good condition	0.015
	f) Brick in rough condition	0.017
	g) Masonry in bad condition	0.02
<b>Stone Work</b>	a) Smooth, dressed ashlar	0.015
	b) Rubble set in cement	0.017
	c) Fine, well packed gravel	0.02
<b>Earth</b>	a) Regular surface in good condition	0.02
	b) In ordinary condition	0.025
	c) With stones and weeds	0.03
	d) In poor condition	0.035
	e) Partially obstructed with debris or weeds	0.05
<b>Steel/BSWC</b>	a) Welded	0.013
	b) Riveted	0.017
	c) Slightly tuberculated	0.02
	d) Cement mortar lined	0.011
<b>Cast Iron &amp; Ductile Iron</b>	a) Unlined	0.013
	b) Cement mortar lined	0.011
<b>Asbestos Cement</b>		0.012

Plastic(smooth)	0.011
-----------------	-------

Note: Values of *n* may be taken as 0.015 for unlined metallic pipes and 0.011 for plastic and other smooth pipes.

**d) Colebrook-white formula**

$$\frac{1}{\sqrt{f}} = -2 \log_{10} \left[ \frac{k}{3.7d} + \frac{2.51}{Re\sqrt{f}} \right]$$

where

- f = Darcy’s friction coefficient
- Re = Reynold’s number  
= velocity x Diameter/viscosity
- d = diameter of pipe
- k = roughness projection (Table 3.3)

**e) Modified Hazen William’s formula**

The Modified Hazen William’s formula has been derived from Darcy-Weisbach and Colebrook-White equations and obviates the limitations of Hazen-Williams formula.

$$V = \frac{(3.83 \times C_R \times d^{0.6575} \times (g \times S)^{0.5525})}{\nu^{0.105}}$$

where

- C<sub>R</sub> = coefficient of roughness ( Table 5.5)
- D = pipe diameter in m
- g = acceleration due to gravity (m/s<sup>2</sup>)
- S = friction slope
- ν = viscosity of liquid (m<sup>2</sup>/s)

For circular conduits,  $\nu_{20^\circ\text{C}}$  for water =  $10^{-6} \frac{\text{m}^2}{\text{s}}$  and  $g = 9.81 \frac{\text{m}}{\text{s}^2}$

The Modified Hazen William’s formula derived as

$$V = 143.534 C_R r^{0.6575} S^{0.5525}$$

$$h = \frac{[L(Q/C_R)^{1.81}]}{994.62 D^{4.81}}$$

where

- V = velocity of flow in m/s
- C<sub>R</sub> = pipe roughness coefficient  
(1 for smooth; <1 for rough pipes; Table 5.5)
- r = hydraulic radius in m
- s = friction slope
- D = internal diameter of pipe in m
- h = friction head loss in m
- L = length of pipe in m
- Q = flow in pipe in m<sup>3</sup>/s

The recommended C<sub>R</sub> Values in Modified Hazen-Williams Formula (at 20<sup>0</sup>C) are given in table 3.4.

Table 3.2 Friction Factors In Darcy-Weisbach Formula

Sl. No.	Pipe Material	Diameter(mm)		Friction Factor	
		From	To	New	For Design Period of 30 Years
1	Concrete (RCC,PSC&PCCP)	100	2500	0.01 to 0.02	0.01 to 0.02
2	AC	100	600	0.01 to 0.02	0.01 to 0.02
3	HDPE/PVC	20	100	0.01 to 0.02	0.01 to 0.02
4	SGSW	100	600	0.01 to 0.02	0.01 to 0.02
5	CI (for non-corrosive waters)	100	1000	0.01 to 0.02	0.053 to 0.03
6	CI (for corrosive waters)	100	1000	0.01 to 0.02	0.034 to 0.07
7	Cement Mortar or Epoxy Lined mettalic pipes (Cast Iron, Ductile Iron, Steel,BSWC)	100	2000	0.01 to 0.02	0.01 to 0.02
8	GI	15	100	0.014 to 0.03	0.0315 to 0.06

Note : Reference may be made to IS 2951 for calculation of Head loss due to friction according to Darcy-Weisbach formula

Table 3.3 Values of Roughness Projection

Sl.No	Pipe Material	Value of ‘k’ mm
-------	---------------	-----------------

		New	Design
1	Metallic pipes-Cast iron and Ductile Iron	0.15	*
2	Metallic Pipes-Mild Steel	0.06	*
3	Asbestos Cement, Cement Concrete, Cement Mortar or epoxy lined steel, CI and DI pipes	0.035	0.035
4	PVC,GRP and other plastic pipes	0.003	0.003

Note : Reference may be made to IS: 2951 for roughness values of aged metallic pipes

Table 3.4 Recommended  $C_R$  Values in Modified Hazen-Williams Formula (At 20° C)

Sl. No.	Pipe Material	Diameter (mm)		Velocity (m/s)		$C_R$ Value when New	$C_R$ Value For Design Period of 30 years
		From	To	From	To		
1	Concrete (RCC,PSC&PCCP)	100	2500	0.3	1.8	1	1
2	AC	100	600	0.3	2	1	1
3	HDPE and PVC	20	100	0.3	1.8	1	1
4	CI/DI (for water with positive Langelier's index)	100	1000	0.3	1.8	1	0.85
5	CI/DI (for water with negative Langelier's index)	100	1000	0.3	1.8	1	0.53
6	Metallic pipes lined with cement mortar or epoxy (for water with negative Langelier's index) (CI,DI,Steel,BSWC)	100	2000	0.3	2.2	1	1
7	SGSW	100	600	0.3	2.1	1	1
8	GI (for water with positive Langelier's index)	15	100	0.3	1.5	0.87	0.74

Note : These average  $C_R$  Values that result in maximum error of  $\pm 5\%$  in the estimation of surface resistance

### 3.5 Minor Losses

#### 3.5.1 Contraction Losses

Loss of head,  $h_c$ , due to contraction of cross-section. The loss is caused by a reduction in the cross-sectional area of the stream and resulting increase in velocity. The loss of head at the entrance to a pipe from a reservoir is a special case of loss due to contraction

#### i) Entrance Loss

$$h_{ce} = f_{ce} V^2 / 2g$$

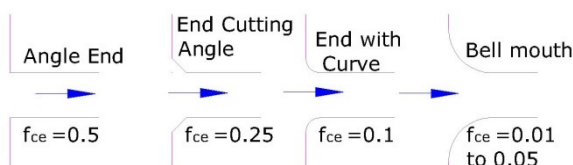

Figure 3.5 Shape of Inlet and Loss Coefficient

#### ii) Contraction Loss

$$h_c = f_c V^2 / 2g$$

or

$$f_c = \frac{h_c}{\frac{V^2}{2g}} = \frac{1}{2} (1 - \phi) \left( \frac{\delta}{90^\circ} \right)^{1.83(1-\phi)^{0.4}}$$

(as given by Gardel equation)

Where,

$$\phi = \frac{A_2}{A_1} = F_2 / F_1, \text{ Ratio of areas of the pipe}$$

$$\xi_v = f_c$$

It is noted that the contraction loss coefficient is always smaller than the corresponding expansion loss coefficient. Also,  $\zeta_v$  increases substantially with the contraction angle  $\delta$ ; and the above equation yields moderate losses for contraction angles below  $\delta < 30^\circ$ . For  $\delta = 90^\circ$ ,  $\zeta_v = (1-\phi)/2$ , i.e., the loss increases linearly with the decrease in the contraction ratio.

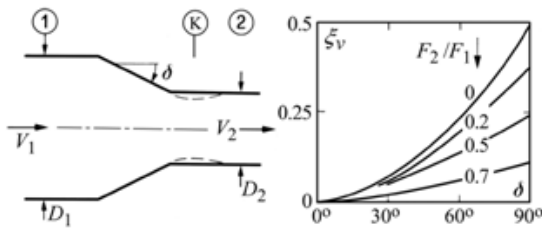

Figure 3.6 Contraction Loss Coefficient (by Gardel)

**3.5.2 Loss of head due to enlargement of section**

Loss of head,  $h_e$ , due enlargement of cross section is caused by increase cross-sectional area of the stream with resulting decrease in velocity. The enlargement may be either sudden or gradual. The loss of head at the outlet end of a pipe into a reservoir is a special case of loss due to sudden expansion.

**i) Exit or Outlet Loss**

$$h_{co} = f_{co} V^2/2g$$

Usually,  $f_{co}$  is regarded as 1.0

Table 3.5 Loss Coefficient for Sluice Valves

(a) Sluice Valve (in case of D =610mm and 762mm)									
S/D =	0.05	0.1	0.2	0.3	0.4	0.5	0.6	0.7	0.8
a/A =	0.05	0.1	0.2	0.36	0.48	0.6	0.71	0.81	0.89
$f_g$ (D=610 mm)	235	100	28	11	5.6	3.2	1.7	0.95	-
$f_g$ (D=762mm)	333	111	23	9.4	5.2	3.1	1.9	1.13	0.6
S : Opening of Valve, D : Diameter, a : area of Open, A : area of full open									

Table 3.6 Loss Coefficient for Butterfly Valves

(b) Butterfly Valve (Full open $\theta = 0^\circ$ , complete close $\theta = 90^\circ$ )													
$\theta =$	5	10	15	20	25	30	35	40	45	50	60	70	90
a/A =	0.91	0.83	0.7	0.66	0.58	0.5	0.43	0.36	0.29	0.23	0.13	0.06	0
$f_g =$	0.24	0.52	0.9	1.54	2.51	3.91	6.22	10.8	18.7	32.6	118	751	$\infty$
a: Area of open      A: area of Full open $\theta =$ degrees of Closing													

**ii) Enlargement Losses**

$$h_e = f_e (V_1 - V_2)^2/2g$$

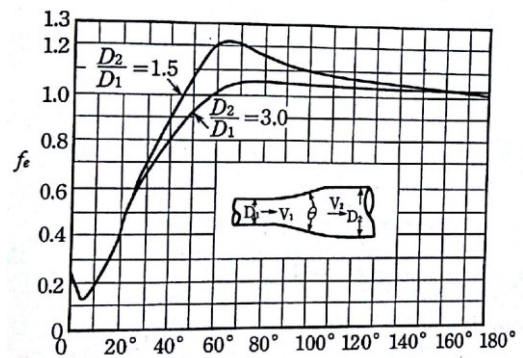

Figure 3.7 Enlargement loss,  $f_e$  (Experimental Values by Gibson)

**3.5.3 Loss of head caused by obstruction of Valves**

Loss of head,  $h_g$ , caused by obstructions such as gates or valves which produce a change in cross-sectional area in the pipe or in the direction of flow. The result is usually a sudden increase or decrease in velocity followed by a more gradual return to the original velocity.

$$h_g = f_g V^2/2g$$

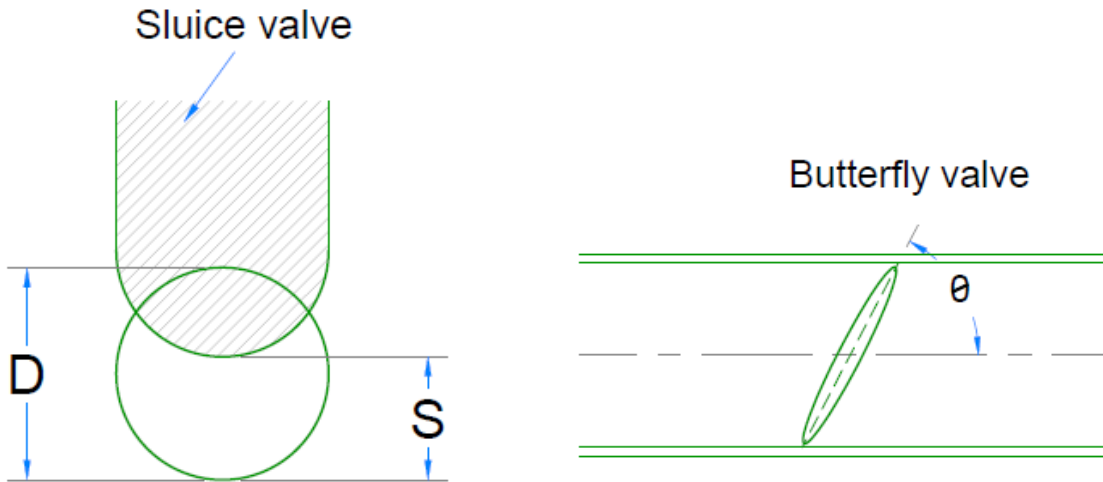

Figure 3.8 Valve Loss Coefficient  $f_v$ , Valve Openings

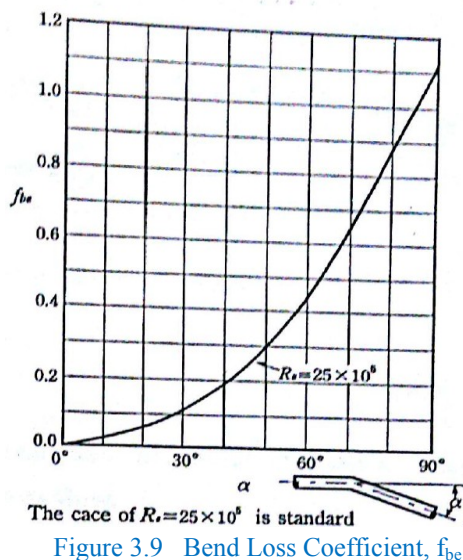

Figure 3.9 Bend Loss Coefficient,  $f_{be}$

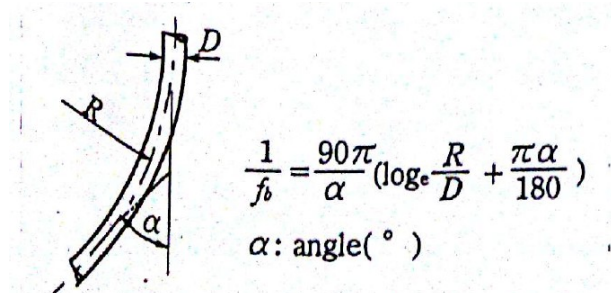

Figure 3.10 Curve Loss Coefficient,  $f_b$

**3.5.4 Loss of Head due to Bends or Curves in Pipe**

A loss of head,  $h_b$ , caused by bends or curves in pipes, in addition to the loss which occurs in an equal length of straight pipe. Such bends may be of any total deflection angle as well as any radius of curvature. Occasionally, as in a reducing elbow, the loss due to the bend is superimposed on a loss due to change in velocity.

- i. Losses due to bend  $h_{be} = f_{be} V^2/2g$
- ii. Losses due to curve  $h_b = f_b V^2/2g$

**3.5.5 Measuring devices**

Head Loss at measuring devices such as Orifice meter, Venturimeter will be dealt as in case of loss due to contraction or expansion. Loss due to pressure measuring devices such as piezometers, ultra-sonic discharge meters or electro-magnetic discharge meters is negligible.

**3.6 Total Minor Losses**

For preliminary estimation purpose, total minor losses may be taken as 10% of the major loss.

### 3.7 Total Loss of Head

$$\Delta H = h_f + h_c + h_e + h_g + h_b$$

The total loss of head,  $\Delta H$  designates all losses of head in a pipeline which there is steady and continuous flow.

## CHAPTER - 4

# DESIGN STANDARDS FOR PIPED IRRIGATION NETWORK

### 4.1 General

This chapter deals with the design standards of velocity, operating pressures, determination of Diameter of pipe, land acquisition, inspection path (if required) for Main and Branch lines etc.

### 4.2 Permissible Velocity

#### 4.2.1 Maximum velocity

The higher the velocity, the greater the risk of damage through surges and water hammer. This risk particularly applies to pipes subject to uncontrolled starting and stopping. Using larger pipe results in a smaller water velocity for a given flow rate, but smaller pipe is often preferred for cost reasons. It is suggested to carry out water hammer analysis under such situations where higher velocities are provided.

When the water is silt rich, design velocity of Piped Irrigation Network should not lower be than non-silting velocity. Non silting velocity should be determined by experiments. *The maximum velocity may be limited to 3.0 m/s.*

#### 4.2.2 Minimum velocity

Designers must specify pipe diameters and flow rates that allow for a minimum operational water velocity, especially for irrigation systems that utilize emitters with small apertures such as drip and micro sprinklers. This will ensure that any sediment or solids are flushed through the lines. *Minimum velocity should not be below 0.6 m/s.*

### 4.3 Permissible head

Minimum driving head at intake should be 1.2 m.

### 4.4 Exit Pressure at Irrigation Outlet for flow irrigation

*A minimum effective head (i.e. H.G.L. – G.L.) of 0.6 m in normal cases and can take a minimum value not less than 0.3 m in exceptional cases should be provided at the most favorable location of the Chak.* If micro is provided in part of the Major & Medium Irrigation Projects, water will be delivered into Diggy or Ponds from which it is pressurized with pumps to suit micro irrigation pressures given below.

To ensure equitable distribution, all outlets should have same residual head. In low lying areas if HG is more, it should be reduced by using lesser diameter pipes or valve.

### 4.5 Exit pressures at Irrigation Outlet for Micro Irrigation

Outlet pressure for micro irrigation systems with design working pressure between 0.2 MPa and 0.4 MPa shall be used.

### 4.6 Determination of pipe diameter

The diameter of the pipe can be preliminarily determined based on the design discharge and permissible velocity in a particular section.

### 4.7 Overburden for buried pipes

A minimum overburden of 1.2 m shall be provided for Main and Branch lines and 0.6m for distributaries and minors to avoid land acquisition problem.

#### 4.8 Land Acquisition

Pipeline layout should be parallel with ditch, trench and road, and avoid fill section segments and areas with possible landslide or flood. The land acquisition should be minimum to nil when laid parallel to existing communications lines. The Pipe network below the distributor off take should be entirely underground which results in Little or No loss of farm land.

#### 4.9 Inspection Path

Generally the existing facilities such as roads, farm roads and crossing shall be used for access for inspection. Only for main line, inspection path of 4 m wide shall be provided if desired.

#### 4.10 Cross drainage works

There are only two possibilities for crossing the streams or nallahs. They are as follows :

- If the Nallah is very wide compared to its bank heights, pipe can be crossed by siphoning of pipe under Nallah bed.
- In case of deep gorges, pipe can be carried over bank piers to cross the Nallah. At minor Nallah the pipe may be taken at the same grade with supports at the banks.

Enough Anchor Blocks and Anchorages shall be provided wherever necessary.

#### 4.11 Pump Stand

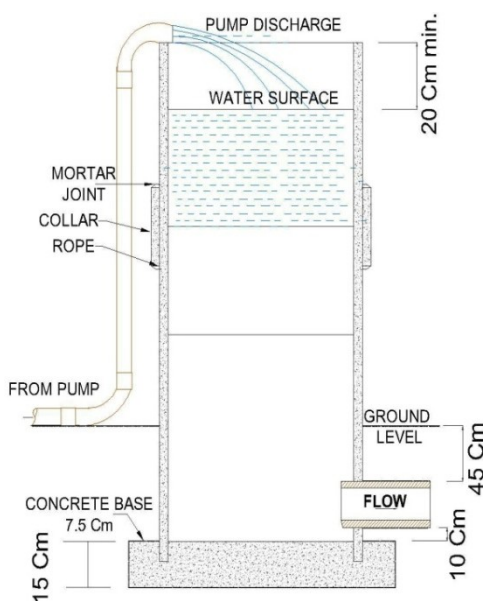

Figure 4.1 Pump Stand

A vertical pipe extending above the ground and connected to the underground pipeline system is known as stand. Pump stand are located at the inlet of an underground pipeline system (fig 4.1).

#### 4.12 Air vent

Air vents are provided to release the entrapped air from the system. The dia. of riser pipe should be minimum of 10% of the diameter of buried pipe and should extend a minimum of 60 cm above HGL. Provide at all points of change of direction of flow. Provide at every 500-1000 m on the straight line. For field irrigation pipes the spacing may be reduced to 150 m based on the requirement.

#### 4.13 Vacuum Relief Valves

Vacuum Relief valves shall be provided at all summits.

#### 4.14 Drain Valves

Drain Valves shall be provided at the lowest points near Nalla.

#### 4.15 Scour Valves

If the velocity in the pipes is less than 0.6 m/s, scour valves shall be provided as per the site conditions at deep nalla locations.

#### 4.16 Working Space and Trench size

- The minimum trench size at the base shall be 1.5 times the diameter of pipe for pipes diameter up to 1200 mm. However, the minimum space of 200 mm on either side of the pipe shall be ensured.
- A minimum space of 300 mm at the base on either side of pipe shall be provided for pipe diameter exceeding 1200mm.
- At the joints all-round space of 600 mm shall be provided for easy maneuver of equipments for jointing.
- Leveling course at bottom with 450 to 600 mm in case of black cotton soil shall be provided to avoid differential settlement or swelling. No cushion shall be provided for sandy or Murrum soils.



**4.17 Bedding for Pipes**

The bottom of the trench shall be properly trimmed to permit even bedding of the pipe-line. For pipes larger than 1200 mm diameter in earth and murum the curvature of the bottom of the trench should match the curvature of the pipe as far as possible, subtending an angle of about 120° at the centre of the pipe as shown in Fig. 1A. Where rock or boulders are encountered, the trench shall be trimmed to a depth of at least 100 mm below the level at which the bottom of the barrel of the pipe is to be laid and filled to a like depth with lean cement concrete or with non-compressible material like sand of adequate depth

to give the curved seating, as shown in Fig. 1B and Fig. 1C ( Fig.4.2).

**4.18 Maximum size of ICA for single point pumping for Micro Irrigation**

The Maximum size of ICA for single point pumping for Micro Irrigation should not exceed 2000 ha or 1.5 cumec.

**4.19 Size of silt to be removed**

Silt particle of size greater than 150 microns shall be removed to prevent clogging of nozzle of drip points in micro-irrigation.

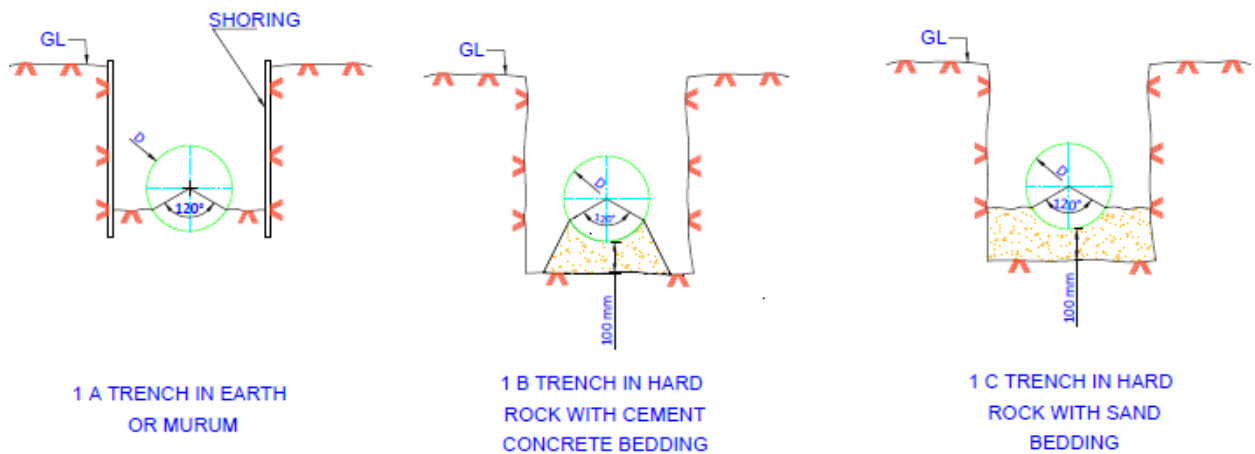

Figure 4.2 Trenching for Pipes



## CHAPTER - 5

# PIPE IRRIGATION NETWORK DESIGN

### 5.1 General

Once the source, water availability, proposed command area, location of outlets and discharge cut-off schedule have been finalized, the next step is the fixation of layout of conveyance network (i.e. pipes layout) and optimization of diameters within the available head loss.

### 5.2 Classification of Piped Irrigations Network (PIN)

#### 5.2.1 Based on driving force

- i. **Gravity Piped Irrigation Network:** The Piped Irrigation Network in which the driving force is completely provided by falling topographical levels, is called Gravity Piped Irrigation Network.
- ii. **Pumped Piped Irrigation Network:** The Piped Irrigation Network in which the gravitational force is supplemented by external energy such as pumps is called Pumped Piped Irrigation Network.

#### 5.2.2 Based on distribution network

- i. **Tree Piped Irrigation Network:** In the Tree Piped Irrigation Network, each outlet gets its supply from one and only one route.
- ii. **Loop Piped Irrigation Network:** In the Loop Piped Irrigation Network, each outlet gets its supply from more than one route.

#### 5.2.3 Based on Operating pressure

- i. **Low Pressure Piped Irrigation Network:** In this type of Piped Irrigation Network, the operating pressures will be in the range 0.1 MPa to 0.4 MPa.
- ii. **Medium Pressure Piped Irrigation Network:** The operating pressures are between 0.4 MPa to 1.0 MPa.
- iii. **High Pressure Piped Irrigation Network:** In this type of Piped Irrigation Network, the operating pressures will be minimum of 1.0 MPa.

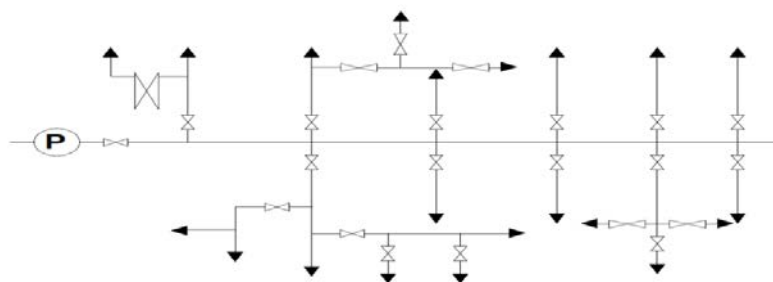

Figure 5.1 Tree Piped Irrigation Network

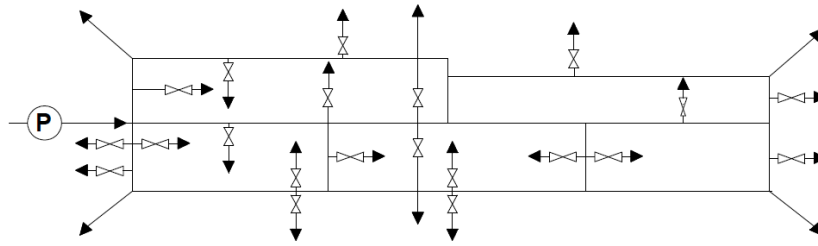

Figure 5.2 Looped Piped Irrigation Network

#### 5.2.4 Based on Pressure Control:

- i. **Open Piped Irrigation Network:** In this type of Piped Irrigation Network, the pressure is controlled by pressure regulating tanks/stand pipes open to atmosphere.
- ii. **Closed Piped Irrigation Network:** In this type of Piped Irrigation Network, the pressure is controlled by pressure regulating valves.
- iii. **Semi-Closed Piped Irrigation Network:** In a closed Piped Irrigation Network, if pressure in part of the system is controlled by regulating tanks and part by pressure regulating valves, then it is called a Semi Closed Piped Irrigation Network.

### 5.3 Economic Size of Pipe

Selection of an optimal pipe size and suitable material is an important endeavour in preparing the Detailed Project Report. Selection of pipe is done taking into account the life span, life cycle analysis, annual operational cost and other techno-economic considerations.

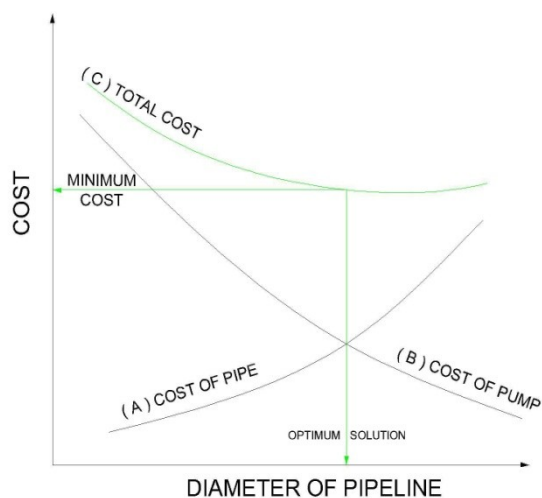

Figure 5.3 Optimization of Pump/Pipeline System

Where the pipe size is not limited or controlled by pressure variation or velocity requirements, pipe sizes corresponding to a frictional loss range of 0.4–1.5 m per 1000 m length of pipe will generally be economical. While arriving at the most economical pipe size, current cost of pipe, pipe life, hours of pumping, pipe friction and energy cost have to be considered.

Possible effects of water quality on pipe material and the deterioration of pipes with age has to be considered at design stage by the designer. Pipe deterioration often results in increased friction losses and the designer should prefer for low friction valued valves and fittings, where ever appropriate.

The cost of pipe (A) increases with diameter but the cost of pump (B) shows an inverse relationship with the latter (Fig 5.3). This is because larger sized pipe offers less resistance to flow than a smaller one and the efforts of a smaller pump will suffice. The total cost (C) obtained by adding both the cost of pipe and pump will be high at extremes and optimum at the turning point wherein the ‘best’ pump and pipe size is arrived at.

### 5.4 Life Cycle Cost Analysis

#### 5.4.1 Life Cycle Cost

Water is supplied through pipes over centuries. With various technologies invented over the period of time, various types of pipe materials are developed and are in use in different parts of the world. With so many years of practice, the authorities have experienced the direct and indirect cost implications that are necessary to be considered while design of piped irrigation systems. It is very essential that we shall account for life cycle cost of the pipe supply system while

arriving at the most suitable and economical pipe diameters and proper selection of pipe material.

Life Cycle Cost shall be expressed as

$$C_{LCC} = C_C + C_O + C_{RL} + C_M + C_R + C_D$$

Where,

- $C_{LCC}$  is Life Cycle Cost,
- $C_C$  is Construction Cost,
- $C_O$  is Operation Cost,
- $C_{RL}$  is Revenue loss due to leakages,
- $C_M$  is Maintenances and repairs cost,
- $C_R$  is Pipe replacement costs for short lived pipe material,
- $C_D$  is Disposal Cost.

#### 5.4.2 Rate of Interest and inflation

For irrigation project with a life of many years (*say 50 to 100 yrs*), consideration of inflation is inevitable. Hence calculation of present worth with appropriate values of inflation and rate of interest is necessary.

#### 5.4.3 Construction Cost

Construction cost ( $C_C$ ) includes the cost of pipe material and associated laying costs

$$C_C = C_P + C_L$$

Where,

- $C_P$  is the Cost of Pipe material
- $C_L$  is Cost of Laying

#### 5.4.4 Operation Cost

Operation costs ( $C_O$ ) are calculated considering the electric power usages that are required for pump operations over the project period.

#### 5.4.5 Revenue Loss due to Water Leakages

Loss of revenue due to leakages ( $C_{RL}$ ) should be considered in Life Cycle Cost Analysis. Appropriate Water tariff shall be considered for computation of the revenue losses due to water leakages.

#### 5.4.6 Maintenances and Repair costs

The Maintenance and Repair costs ( $C_M$ ) can be worked out on per meter basis as a fraction of

construction cost and then capitalized over the project period.

#### 5.4.7 Replacement costs

Consideration of replacement cost ( $C_R$ ) is essential for pipes having a shorter life in comparison with the project life.

#### 5.4.8 Disposal Cost

Disposal cost ( $C_D$ ) account for the total cost incurred in removal of pipeline, waste disposal and salvage value, in case the pipe material is recyclable.

#### 5.4.9 Present Worth Estimation with Escalation

**Capitalization of Annual Cost Expenditure:** The financial flow diagram which considers a flat rate of annual charges like leakage loss or maintenance cost is as given in Fig 5.3.:

The present worth in this case is calculated as

$$P = A \left[ \frac{(1 + i_r)^n - 1}{i_r(1 + i_r)^n} \right]$$

Where

- P = Present Worth
- A = Annual Cost
- $i_r$  = Rate of Interest
- n = no of years

Where

- $i_f$  = the rate of Inflation

The present worth, in case of inflation whose flow diagram is given in Fig 5.4, is calculated as

$$P_{inf} = \left[ \frac{(1 + w)^n - 1}{w(1 + w)^m} \right]$$

Where, w, is calculated as  $w = \frac{(1+i_f)}{(1+i_r)} - 1$

**Capitalization of replacement costs:** The replacement costs are worked out with respect to above formulation and individually present worth are calculated with respect to prevailing interest rate,  $i_r$ , as follows,

$$P_{n1} = \frac{C(1 + i_f)^{n1}}{(1 + i_r)^{n1}}$$

The financial flow diagram for replacements cost is as given in Fig 5.5

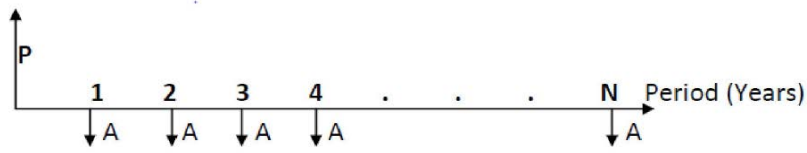

Figure 5.4 Flow diagram with flat rate of annual charges

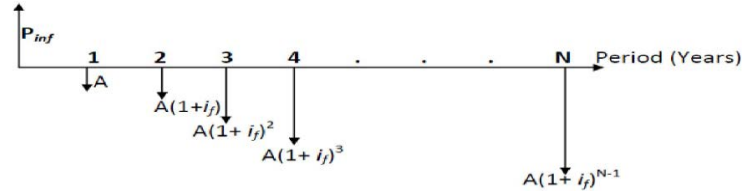

Figure 5.5 Flow diagram in case of inflation

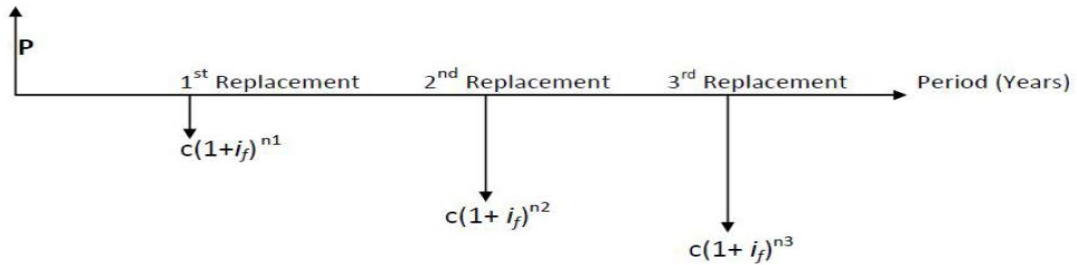

Figure 5.6 Flow diagram for replacement cost

Table 5.1 Illustration of computations for LCC Analysis based on assumed parameters

INPUT DATA :				
Sl. No	Description	Quantity	Units	Remarks
1	Project Life, N	50	years	
2	Rate Of Interest On Capital Investment, $I_r$	10%	per annum	
3	Rate Of Inflation For Replacement Cost, $I_f$	6%	per annum	
4	Diameter Of Pipe, D	150	mm	
5	Design Discharge, Q	0.0212	cumec	
6	Length Of Pipe, L	10	km	
7	Average Velocity, V	1.2	m/s	
8	Pipe Material, M1	Material-1		
9	Life Of Pipe Material (Or Replacement Interval)	15	years	Refer Cl. 5.5
10	Leakage Losses As A Percentage Of Quantity Supplied, $Q_l$	5%	per cum	
11	Repairs & Maintenance Cost As A Percentage Of Construction Cost	5%	per annum	
12	Unit Rate Of Power	3.5	Rs/Unit	
13	Salvage Value Of Pipe Material As A Percentage Of	10%		

Original Cost			
14	No Of Days The Pipe Runs In A Year Considering Two Crops	240	days
15	Water Charges, Rs (Assumed)	7	per cum
16	Combined Efficiency Of Pump - Motor Unit	75	%
<b>CALCULATIONS :</b>			
<b>a) Construction Cost (C<sub>C</sub>)</b>			
Construction Cost includes Cost of Pipe Material(C <sub>P</sub> ) at site and Cost of Laying(C <sub>L</sub> ) ie C <sub>C</sub> = C <sub>P</sub> + C <sub>L</sub> . These costs can be obtained from Standard Schedule of Rates for the material w.r.t. the locality. For the present case, for dia of 150mm of Material(M1), values are taken as follows :			
	Construction of Pipe material, C <sub>P</sub> (assumed)	= 481	Rs/RMT
	Construction of laying, C <sub>L</sub> (assumed)	= 264	Rs/RMT
	<b>Construction cost, C<sub>C</sub></b>	= <b>745</b>	<b>Rs/RMT</b>
<b>b) Operation Cost or Cost of Operation(C<sub>O</sub>)</b>			
The Cost of Operation for Gravity Schemes is NIL. In present case it is assumed that external energy equivalent to head loss has to be provided.			
	Modified Hazen-William Coefficient(C <sub>R</sub> ) from Table 3.5 for Material(M1)	= 1	
	From Modified Hazen William Formula(Clause 3.5), Head Loss (h)	=	$\left[ \frac{L \times (Q/C_R)^{1.81}}{994.62 \times D^{4.81}} \right]$
	Head loss, h = $\left[ \frac{10000 \times (0.0212/1)^{1.81}}{994.62 \times 0.15^{4.81}} \right]$	= 86.3	m
	Add 10% for Minor Losses, h	= 94.9	m
	Power Required for Pumping (kW), P	=	$\frac{Qgh}{e}$
	Annual Power Requirement, for 240 days working	= 26.32	kW
		= 151625	Units
	Cost of Operation @ Rs 3.5/unit	= 530687	Rs/annum
	Cost of Operation per RMT	= 53.07	Rs/RMT/annum
	Project Life, n	= 50	years
	$w = \left( \frac{1 + I_r}{1 + I_f} \right) - 1$	= 0.0377	
	1+w	= 1.0377	
	1+f	= 1.06	
	Capitalization Factor(CF)	= 21.08	
	Cost of operation including capitalisation factor	= 21.08 x 53.07	
	<b>i.e, Cost of Operation, C<sub>O</sub></b>	= <b>1118.54</b>	<b>Rs/RMT</b>
<b>c) Revenue Loss due to Leakage (C<sub>RL</sub>)</b>			
	Volume of water Supply @ 0.0212 cumec for 240 days, □	= 439603	Cum
	Loss of Water @ 5%	= 21980	Cum
	Revenue Loss by Leakages @ Rs 7/ Cum	= 1,53,861	Rs/annum

Capitalized of annual $C_{RL}$ over 50 Years	= 15.39	Rs/RMT/annum
Including Capitalization factor (21.08 * 15.39),		
<b>Revenue loss due to Leakage, <math>C_{RL}</math></b>	= <b>324.30</b>	<b>Rs/RMT</b>
<b>d) Repair and Maintenance Cost(<math>C_M</math>)</b>		
Annual R&M cost is assumed as 5% of Construction Cost( $C_C$ )	= 37.25	Rs/RMT/annum
Capitalized of annual $C_M$ over 50 Years(including capitalisation factor)	= 785.12	Rs/RMT
Revenue Loss by Leakages @ Rs 7/ Cum	= 1,53,861	Rs/annum
Capitalized of annual $C_{RL}$ over 50 Years	= 15.39	Rs/RMT/annum
Including Capitalization factor (21.08 * 15.39)		
<b>Repair and Maintenance Cost, <math>C_M</math></b>	= <b>324.30</b>	<b>Rs/RMT</b>
<b>e) Replacement Cost(<math>C_R</math>)</b>		
Assuming the material (M1) has a life period of 15 year. Different Pipe Material have different life period. It has to be replaced three times over the project period of 50 years i.e. First replacement at the end of 15th Year, 2nd replacement at the end of 30th year and the third replacement at the end of 45th year.		
As Laid Cost Rs/RMT from (a)	= 745	Rs/RMT
Replacement cost at the end of 15th Year( $C_{R1}$ )	= $CC[1 + I_f/100]^{15}$	
	= 1785	Rs/RMT
Replacement cost at the end of 30th Year ( $C_{R2}$ )	= $CC[1 + I_f/100]^{30}$	
	= 4279	Rs/RMT
Replacement cost at the end of 45th Year ( $C_{R3}$ )	= $CC[1 + I_f/100]^{45}$	
	= 10255	Rs/RMT
<b>Present worth of replacement cost, <math>C_R</math></b>		
$C_{R1}[1 + I_f/100]^{15} + C_{R2}[1 + I_f/100]^{30} + C_{R3}[1 + I_f/100]^{45}$	= <b>813</b>	<b>Rs/RMT</b>
<b>f) Disposal Cost(<math>C_D</math>)</b>		
<b>Disposal Cost is taken as 10% of Replacement Cost with Salvage, <math>C_D</math></b>		
	= <b>-81.33</b>	<b>Rs/RMT</b>
<b>f) Life Cycle Cost</b>		
Life cycle cost for the complete Pipe System, $C_{LCC}$	= $C_C + C_O + C_{RL} + C_M + C_R + C_D$	
	= 3704.95	Rs/RMT
	<b>i.e, Life Cycle Cost, <math>C_{LCC}</math> = Rs. 3,70,49,491.42</b>	

The above calculation is for computing the Life Cycle Cost for one particular pipe material and similar calculation shall be carried out for different pipe materials with appropriate input parameters. The final decision may be taken based on the Life Cycle Cost Analysis.

### 5.5 Pipe Materials

Pipelines are major investments in water supply projects and as such constitute a major part of the assets of water authorities. Pipes represent a large proportion of the capital invested in water supply

undertakings and therefore are of particular importance. Pipe materials shall have to be judiciously selected not only from the point of view of durability, life and overall cost but also their suitability in performing the required function throughout the design life of the pipe network.

#### 5.5.1 Selection of Pipe Materials

Selection of Pipe Material must be based on the following considerations.



- i. The initial carrying capacity of the pipe and its reduction with use, defined, for example, by the Modified Hazen Williams coefficient (C). Values of C vary for different conduit materials and their relative deterioration in service. They vary with size and shape to some extent.
- ii. The strength of the pipe as measured by its ability to resist internal pressure and external loads.
- iii. The life and durability of pipe as determined by the resistance of cast iron and steel pipe to corrosion; of concrete and A.C. pipe to erosion and disintegration and plastic pipe to cracking and disintegration. Normally, the design period of pipelines is considered as *50 years*.
- iv. The ease of transportation, handling and laying and jointing under different conditions of topography, geology and other prevailing local conditions.
- v. The safety, economy and availability of manufactured sizes of pipes and specials.
- vi. The availability of skilled personnel for construction of pipelines.
- vii. The ease of difficulty of operations and maintenance.
- viii. Nominal pressure of chosen pipe material should not be less than the sum of design working pressure and water hammer pressure.
- ix. Connection between pipe and pipes, fittings and accessories should be simple and reliable.
- x. Nominal pressure of fittings and accessories should not be less than that of pipe; dimension and deviation should meet sealing requirements.
- xi. When the sulphate concentration in soil exceeds 1%, concrete pipes and metal pipes should not be used

*pipes available in the market is exhaustive and due to space constraints, comparisons of typical pipe materials only has been given.*

The cost of pipe material and its durability or design life are the two major governing factors of selection of pipe material. The pipeline may have very long life but may also be relatively expensive in terms of capital recurring costs and, therefore, it is very necessary to carry out a detailed economic analysis before selecting pipe materials.

*Table 5.2 provides the comparison of various types of typical Pipe Materials. However, the list of*

Table 5.2 Comparison of various Pipe Materials

Specific Issue	MSP (Mild Steel Pipe) (IS 3589:2001)	DIP (Ductile Iron Pipe) (IS 8329:2000)	GRP (Glass Fibre Reinforced Plastic Pipe) (IS 12709:1994)	PVC Pipe (IS 4985-2000)	HDPE Pipe (IS 4984-1995)	RCC Pipe (IS 458-2003)	PCCP (Prestressed Concrete Cylinder Pipe) (IS 784-1985)	PSC (Prestressed Concrete non cylinder Pipe) (IS 784-1985)	BWSC (Bar Wrapped Steel Cylinder Pipe) (IS 15155-2002)
<b>Design Concept</b>	Flexible Structure	Semi Flexible Structure	Flexible Structure	Flexible Structure	Flexible Structure	Rigid Structure	Rigid Structure	Rigid Structure	Based on semi rigid pipe theory
<b>Bedding Requirement</b>	The bottom of the trench shall be properly trimmed to permit even bedding of the pipeline. For pipes larger than 1200 mm diameter in earth and murum the curvature of the bottom of the trench should match the curvature of the pipe as far as possible, subtending an angle of about 120° at the centre of the pipe. Where rock or boulders are encountered, the trench shall be trimmed to a	Where pipes are to be bedded directly on the bottom of the trench, it should be trimmed and levelled to permit even bedding of the pipeline and should be free from all extraneous matter which may damage the pipe or the pipe coating. Additional excavation should be made at the joints of the pipes so that the water main is supported along its entire length. Where excavation is through rocks or boulders, the pipeline should be bedded on concrete bedding or on at least 150 mm of fine grained material, or other means are used to protect the pipe and its coating. Material harmful to the pipeline should	The pipe should be uniformly and continuously supported through its whole length with firm stable bedding material. Pipe bedding material should be sand or gravel as per the requirements on the backfill material.  The bedding should be placed so as to give complete contact between the bottom of the trench and the pipe and should be compacted to provide a minimum compaction corresponding to 90% maximum dry density.  If the pipe is supported on grade elevation with use of timber or of tapered wedges, they must be removed and not left in place. They can usually be pulled out after the bedding has been compacted to	The trench bottom shall be constructed to provide a firm, stable and uniform support for the full length of the pipeline. There should be no sharp objects that may cause point loading. Any large rocks, hard pan, or stones larger than 20 mm should be removed to permit a minimum bedding thickness of 100-150 mm under the pipe. For pipes of diameters 100 mm or greater, bell holes in the bedding, under each socket joint, shall be	Polyethylene pipe requires no special bed preparation for laying the pipe underground, except that there shall be no sharp objects around the pipe. However, while laying in rocky areas suitable sand bedding should be provided around the pipe and compacted. <b>(Refer Cl. No. 6.3 of IS 7634 Part 2 : 2012)</b>	Types of bedding suggested as per IS 783  1) Type A Bedding – concrete cradle support to the pipe (continuous concrete cradle of monolithic cross section if unreinforced)  2) Type B Bedding – Sand or other granular material shaped to fit lower curved shape of the pipe.  3) Type C Bedding – Ordinary Type of Bedding with normal	Bedding requirements are minimal due to Rigid nature.  Types of bedding suggested as per IS 783  1) Type A Bedding – concrete cradle support to the pipe (continuous concrete cradle of monolithic cross section if unreinforced)  2) Type B Bedding – Sand or other granular material shaped to fit lower curved shape of the pipe.  3) Type C Bedding – Ordinary Type of Bedding with normal care  4) In rocky portion,	Bedding requirements are minimal due to rigid nature.  Types of bedding suggested as per IS 783  1) Type A Bedding – concrete cradle support to the pipe (continuous concrete cradle of monolithic cross section if unreinforced)  2) Type B Bedding – Sand or other granular material shaped to fit lower curved shape of the pipe.  3) Type C Bedding – Ordinary Type of Bedding	Bedding requirements are minimal due to semi rigid nature. Smaller diameter pipes upto 600 mm are rigid in nature.

	depth of at least 100 mm below the level at which the bottom of the pipe is to be laid and filled to a like depth with lean cement concrete or with non-compressible material like sand of adequate depth to give the curved seating. (Refer Cl. No. 4.2.1 of IS 5822 : 1994)	not be used.(Refer Cl. No. 4.2.5 and 4.2.6 of IS 12288: 1987)	the specified minimum compaction. The voids from which the timber has been removed must be properly filled and compacted. (Refer Cl. No. 7.1 of IS 13916:1994)	provided by removing some of the bedding material, to accommodate the larger diameter of the joint and to permit the joint to be made properly. Prepare the bedding by laying on soft soil and alternatively compacting and watering sparingly until an effective thickness of 100 to 150 mm is achieved. (Refer Cl. No. 6.2.3 & 6.2.7 of IS 7634 Part 3 : 2003)		care 4) In rocky portion, where excavation is through rock, the trench should be excavated 150 mm more and filled with fine granular material	where excavation is through rock, the trench should be excavated 150mm more and filled with fine granular material.	with normal care 4) In rocky portion, where excavation is through rock, the trench should be excavated 150mm more and filled with fine granular material.	
<b>Backfill Materials / Compaction Required</b>	Backfilling should closely follow the welding of joints of the pipe so that the protective coating should not be subsequently damaged. Material harmful to the pipeline shall	For the purpose of backfilling, the depth of the trench shall be considered as divided into the following three zones from the bottom of the trench to its top: Zone - A: From the bottom of the trench to the level of the centre line of the pipe,	Back filling should be placed in layers not exceeding a depth per layer which can be compacted to a minimum of 85% maximum dry density. Lift should normally not be greater than 30 cm in height and the height differential on each side of the pipe should be limited to this amount so as to	Excavated material should be deposited at a sufficient distance away from the trench to prevent damage to the pipeline through falling stones or debris.  The first side-	Only soft earth and gravel of good quality free from boulders, roots vegetable matter, etc, shall be used first. If sufficient quantity of suitable (sharp edge stone free) excavated earth is not available, the trench shall be filled by borrowed	For Type A,B and C , Bedding – selected fill material compacted in layers not exceeding 150 mm to a height of 300 mm above top of the pipe in case of earth foundation and 150 mm in case	For Type A,B and C ,Bedding – selected fill material compacted in layers not exceeding 150 mm to a height of 300 mm above top of the pipe in case of earth foundation and 150 mm in case of rock foundation. (Refer IS 783 :	Backfill compaction is minimally important due to rigid nature as the pipe does not rely upon side support.	Backfill compaction is minimally important due to semi rigid nature as the pipe does not rely upon side support.

<p>not be used for backfilling. Refilling shall be done in layers not exceeding 300 mm. Each layer shall be consolidated by watering and ramming, care being taken to prevent damage to the pipeline. The filling on the two sides of the pipeline should be carried out simultaneously.</p> <p>The spiders provided during assembly and welding shall be retained until the trench is refilled and consolidated. Where timbers are placed under the pipeline to aid alignment, these shall be</p>	<p>Zone - B: From the level of the centre line of the pipe to a level 300 mm, above the top of the pipe, and</p> <p>Zone - C: From a level 300 mm above the top of the pipe to the top of the trench. Back-fill material shall be free from cinders, ashes, slag, refuse, rubbish, vegetable or organic material, lumpy or frozen material, boulders, rocks or stone or other material, which in the opinion of the authority, is unsuitable or deleterious. However, material containing stones up to 200 mm as their greatest dimension may be used in Zone C, unless specified otherwise herein.</p> <p>The excavated material may be used for backfill in the following cases:</p> <p>In Zone C, in cases where settlement is unimportant and when shown on the</p>	<p>prevent lateral movement of the pipe.</p> <p>Most coarse grained soil are acceptable. This may comprise of gravel or sand. However, silty sand, clayey sand, silty and clayey gravel shall not be used unless proposed to be used in conjunction with gravel or clean sand.</p> <p>It is very important that the pipe zone backfill material dose not wash away or migrate into the native soil. Likewise, potential migration of the native soil into the pipe zone backfill must also be prevented.</p> <p>Heavy earth moving equipment used for backfilling should not be brought until the minimum cover over the pipe is 90 cm in the case of wide tracked bulldozers or 120 mm in the case of wheeled roaders or roller compactors.</p> <p>Vibratory methods are preferably for compaction.</p>	<p>fill or haunching layer should be placed by hand and compacted in layers under the lower quadrants of the pipe upto the spring level (half the vertical diameter) of the pipe. Compaction can be done by careful trampling with the feet or with tamping tools. Successive layers of backfill of 75 mm thickness may then be placed over and compacted to a height above the crown of not less than 150 mm. Light vibrating machinery may be used, but not directly above the pipe.</p> <p>On completion of the surround to the pipe, suitable</p>	<p>gravel or material up to 300 mm above top of the pipe.</p> <p>Care shall be taken during back filling for not to damage the pipe or joints. Filling has to be carried out simultaneously on the both sides of the pipes so that unequal pressure does not occur. Load on the buried pipeline shall not be permitted unless the trench has been filled to the height of at least 300 mm over the top of the pipe. Filling shall be done in layers of 150 mm, with the first layer watered and compacted by stamping or by mechanical means.</p> <p>The initial back fill up to 150 mm above the crown of the pipe should be compacted with screened excavated material free of sharp</p>	<p>of rock foundation. <b>(Refer IS 783 : 1985)</b></p>	<p><b>1985)</b></p>			
--	---	--	---	--	---	---------------------	--	--	--

	removed before backfilling. For further precautions and use of material in backfilling, reference should be made to IS 3114 :1994. <b>(Refer Cl. No. 8.2 of IS 5822 : 1994)</b>	drawings or specified, the back-fill shall be neatly rounded over the trench to a sufficient height to allow for settlement to the required level.  In any zone, when the type of back-fill material is not indicated or specified, provided that such material consists of loam, clay, sand, fine gravel or other materials which are suitable for backfilling in the opinion of the authority. <b>(Refer Cl. No. 4.11 of IS 12288 : 1987)</b>	Compaction within distances of 15 cm to 45 cm from the pipe is usually done with hand tampers. <b>(Refer Cl. No. 7.2 &amp; 7.3 of IS : 13916:1994)</b>	excavated material may be then replaced as backfill in 250 mm compacted layers upto the top of the trench. No heavy compaction equipment may be employed until there is at least 300 mm of fill above the crown of the pipe. <b>(Refer Cl. No. 6.2.4 &amp; 6.5 of IS 7634 Part 3 : 2003)</b>	stones or objects or with fine sand where no such material is available. Wherever road crossing with heavy traffic is likely to be encountered — a concrete pipe encasing is recommended. <b>(Refer Cl. No. 8.1.1 and 6.4.1 of IS 7634 Part 2 : 2012)</b>				
<b>External Corrosion Protection</b>	Spiral wall reinforcement cement mortar with seal coat paint or liquid epoxy or fusion bonded epoxy or tape coating. <b>(Refer Annex A-D, IS 3589: 2001)</b>	Metallic Zinc with finishing layer Bituminous Paint or synthetic resin compatible with the zinc coating. <b>(Refer Cl. No. 16.2, A-8 of Annex - A of IS 8329 : 2000)</b>	Not required	Not required	Not required	Not required	Portland cement mortar applied during manufacture	Portland cement mortar coating applied during manufacture.	Portland cement mortar coating applied during manufacture.
<b>Internal Lining</b>	Cement Mortar with seal coat paint or liquid	Portland cement mortar or Blast furnace slag cement mortar, or High	GRP pipe and fittings shall be composite laminate consisting of a	Not required	Not required	Not required	High-strength concrete core centrifugally placed.	High-strength concrete core centrifugally placed.	High-strength cement mortar lining centrifugally

	epoxy or fusion bonded epoxy. (Refer Annex A to D, of IS 3589 : 2001)	Alumina cement mortar or Cement mortar with seal coat, (Refer Cl. No. 16.3 of IS 8329 : 2000)	corrosion resistant inner liner.						placed.
<b>Properties</b>	Young's Modulus of Elasticity (E): 210,000 MPa (Table 6.7, Chapter 6 of CPHEEO manual), Tensile Strength 410 Mpa (Fe-410 Grade), Length: 4-7 m or 7-14 m (Refer Cl No. 5.1, 12.4.1 of IS 3589 : 2001) Elongation at Break – over 18%, Impact Resistance: 1.5, Structural strength (Crushing strength): 4000 Kg/cm <sup>2</sup> (Approx.) stiffness needed for longitudinal welded pipes.	Minimum Tensile Strength 420 Mpa (Minimum) Minimum Elongation at Break 7-10% Hardness is 230 HB (maximum) Pipe Length: 5.5 m or 6 m each pipe (Refer Cl No. 10.1.6 & 13.1 of IS 8329 : 2000). Young's Modulus of Elasticity (E): 170,000 MPa (Table 6.7, Chapter 6 of CPHEEO manual), Poisson's Ratio : 0.28 Impact Resistance: <0.713 Structural strength (Crushing strength): 5000 Kg/cm <sup>2</sup> (Approximate) Normal Backfill.	Length: 6 m, 9 m and 12 m (Refer Cl. No. 7.2 of IS 12709 : 1994) Tensile Strength: Composite Pipe, Impact Resistance: Brittle pipe at the point of impact Forms star crack which initiates crack propagation, Structural strength (Crushing strength): 250-300 Kg/cm <sup>2</sup> (Approx.) Compaction of Backfill essential	Length: 4 m, 5 m or 6m (Refer Cl. No. 7.1.4.1 of IS 4985 : 2000) Young's Modulus of Elasticity (E): 3,000 MPa (Table 6.7, Chapter 6 of CPHEEO manual), Tensile Strength: 600-800 kg/cm <sup>2</sup> (decreases with temp), Impact Resistance: Negligible, Structural strength (Crushing strength): 150-200 Kg/cm <sup>2</sup> (Approx.) Compaction of Backfill essential	Young's Modulus of Elasticity (E): 900 MPa (Table 6.7, Chapter 6 of CPHEEO manual), Length: 5-20 m (Refer Cl. No. 6.4 of IS 4984 : 1995), Tensile Strength: 265-280 kg/cm <sup>2</sup> (decreases with temp), Impact Resistance: Good, Structural strength (Crushing strength): 200-250 Kg/cm <sup>2</sup> (Approx.) Compaction of Backfill essential	Tensile Strength (Minimum): 2.5 MPa, Elongation at Break: 0% Pipe Length: 2.5 m each pipe (Refer Clause no. 5.5.2 & 8.1 of IS 458 : 2003) Young's Modulus of Elasticity (E): 31,000 MPa (Table 6.7, Chapter 6 of CPHEEO manual) Poisson's Ratio: 0.20 Impact Resistance: Negligible Structural strength (Crushing strength): 300 Kg/cm <sup>2</sup> (Approximate) Normal Backfill	Young's Modulus of Elasticity (E): 35,000 MPa (Table 6.7, Chapter 6 of CPHEEO manual), Length: up to and including 300 mm diameter – not more than 3 m, for above 300 mm dia – 2, 2.5, 4, 5 & 6 m (Refer Clause no. 5.2 of IS 784 : 2001), Tensile Strength: Composite Pipe, Impact Resistance: Negligible, Elongation at Break: 0% Structural strength (Crushing strength): 300 Kg/cm <sup>2</sup> (Approximate) Normal Backfill	High crushing and beam strengths, More resistance to majority of common chemicals, good abrasion resistance, Can be stored in the open for long periods, Simple to make flexible joints, able to withstand fluctuating internal pressures and surge conditions	Wider diameter range and higher working pressure, improved version of steel pipes, customised pipe design can be done with economical advantages, Highly corrosion resistance, Excellent and permanent hydraulic coefficient, C value above 140, No tuberculation, lap welded rigid joints, Easy to assemble to pipe joint, Highly durable

	Compaction of Backfill essential								
<b>Supplementa I External Protection</b>	Cathodic Protection.	Polyethylene Sleeve (Refer Cl. No. 16.2, Annex - D of IS 8329 : 2000)	Not required.	Not required.	Not required.	In aggressive, buried environments, coal tar epoxy paint is generally used	In aggressive, buried environments, coal tar epoxy paint is generally used	In aggressive, buried environments, coal tar epoxy paint is generally used	In aggressive, buried environments, coal tar epoxy paint is generally used
<b>Jointing</b>	Plain ends or beveled ends for butt welding unless otherwise agreed, beveled ends shall be beveled to an angle of 30 <sup>0</sup> (+5/-0) measured from a line drawn perpendicular to the axis of the pipe. The root face shall be 1.6±0.8 mm.  Joints with sleeves joint or swelled and plain ends for welding. (Refer Cl. No. 17.1, of IS 3589 : 2001)	Push-on Flexible Joint, Mechanical Flexible Joint, Restrained Joint and Flanged Joint. (Refer Cl. No. 3.9 to 3.14 of IS 8329 : 2000)	Unrestrained - Coupling or Socket or Spigot Gasket Joint Restrained - Coupling or Socket or Spigot Gasket Joint with supplemental restraining elements Butt Joint Socket and Spigot with laminated overlay Socket and Spigot with adhesive bonded Flanged Mechanical (Refer Cl. No. 8 of IS 12709 : 1994)	Solvent Cementing joint Elastomeric sealing ring joint (Refer Cl. No. 7.2 of IS 4985:2000)	a) Fusion welding: 1) Butt fusion welding; 2) Socket fusion welding; and 3) Electro fusion welding;  b) Insert type joints; c) Compression fittings/push fit joints; d) Flanged joints; and e) Spigot and socket joints (Refer Cl. No. 3.1.1 of IS 7634 Part 2:2012)	Socket & Spigot – roll on joints or confined gasket joint, flush jointed and collar jointed (Refer Cl. No. 6.3 of IS 458:2003)	Spigot and socket type with rubber ring or with steel joint rings embeddedat ends for site welding. In case of pipes for culverts, joints may be spigot and socket, roll on gasket joint, confined gasket joint or flush joint (Refer Cl. No. 11.1, Amendment 2 of IS 784:2001)	Easy to assemble , Reliable confined joint system made with gasket, Flexible joint	Steel socket and Spigot joints rings made of profile steel & formed to accurate dimensions beyond Elastic Limit, Sliding overlap welded rigid joints which ensure 100% water tightness, Option for confined rubber ring joints

<p><b>Handling</b></p>	<p>The pipes and specials shall be handled in such a manner as not to distort their circularity or cause any damage to their outcoating. Pipes shall not be thrown down from the trucks nor shall they be dragged or rolled along hard surfaces. Slings of canvas on equally non-abrasive material of suitable width or special attachment shaped to fit the pipe ends shall be used to lift and lowercoated pipes so as to eliminate the risk of damage to the coating. <b>(Refer Cl. No. 5.2.4 of IS 5822 : 1994)</b></p>	<p>Ductile iron pipes are less susceptible to cracking or breaking on impact but the precautions set out should be taken to prevent damage to the protective coating and brushing or damage of the jointing surfaces. <b>(Refer Cl. No. 7.1 of IS 12288 : 1987)</b></p>	<p>Steel cables or ropes shall not be used for lifting and transportation of pipes. Ropes shall not be pass through the section of pipes end to end. Straight continuous length of pipe may be lifted at one point. However, owing to its very smooth surface it is usually safer for the pipe to be lifted at two points.</p> <p>Pipes shall not be dropped to avoid impact or bump. If any time during handling or during installation, any damage such as gouge, crack or fracture occurs, the pipe shall be repaired if so permitted by the competent authority before installation. <b>(Refer Cl. No. 4.3.1, 4.3.2, 4.3.4 of IS 13916 : 1994)</b></p>	<p>As UPVC pipes are durable and light, they are more likly to be mishandled. Care should be taken to ensure that pipes are not damaged during handling, storage and transport. UPVC pipes should be handled keeping in mind that they are made of plastic and are also susceptible to damage if mishandled. They should not be thrown, dropped or dragged. <b>(Refer Cl. No. 4 &amp; 4.2.1 of IS 7634 Part 3 : 2003)</b></p>	<p>It is softer than metals, it is prone to damage by abrasion and by objects with a cutting edge. Such practices as dragging pipes over rough ground should therefore be avoided. If handling equipment is not used, techniques, which are not likely to damage the pipe are to be chosen. <b>(Refer Cl. No. 12.3 of IS 7634 Part 2 : 2012)</b></p>	<p>Concrete pipes have to be properly handled, bedded and back-filled, and back-fined, if they have to carry safely the full design loads. Even the highest quality of concrete pipes manufactured in accordance with the specifications may be destroyed by improper handling, bedding and back filling. <b>(Refer Cl. No. 0.3, Foreword of IS 783 : 1985)</b></p>	<p>Concrete pipes have to be properly handled, bedded and back-filled, to carry safely the full design loads. <b>(Refer Cl. No. 0.3, Foreword of IS 783 : 1985)</b></p>	<p>Concrete pipes have to be properly handled, bedded and back-filled, to carry safely the full design loads. <b>(Refer Cl. No. 0.3, Foreword of IS 783 : 1985)</b></p>	<p>Pipes are easy for handling and installation</p>
------------------------	---	---	--	---	--	---	---	---	---



<p><b>Transportation</b></p>	<p>Delivery of the pipes and specials and appurtenances shall be taken from the stockyard of the authority and transported to the site of laying and stacked along the route on timber skids. Padding shall be provided between coated pipes and timberskids to avoid damage to the coating. Suitable gaps in the pipes stacked should be left at intervals to permit access from one side to the other. <b>(Refer Cl. No. 5.2.2 of IS 5822 : 1994)</b></p>	<p>Pipes should be loaded in such a way that they are secured and that no movement should take place on the vehicle during transit. The pipes should be loaded on vehicles in pyramid or straight sided formation. In case of pyramid loading, the pipes in the bottom layer should be restrained by the use of broad wooden wedges secured to the vehicle being loaded. The pyramid is to be formed by resting pipes between the pairs of pieces in the preceding layer with the sockets in layers reversed. Straight sided loading may be used with supports along the sides of the vehicles. The use of straight sided loading is advantageous for utilizing full capacity of the vehicle. <b>(Refer Cl. No. 7.2 of IS 12288 : 1987)</b></p>	<p>All pipes section and fittings shall be supported on timber saddles spaced at 4 m centers with a maximum overhang of 2 m. Stock height should not generally exceed 2 m. Pipes shall be strapped to the vehicle over the support points using non-metallic pliable straps or ropes only.</p> <p>Pipes and fittings with diameter of less than 1 m may be stored directly on sandy soil, the ground should be flat and free from sharp projection stones/rocks bigger than 40 mm in diameter or other potentially damaging debris.</p> <p>Pipes with diameter greater than 1 m may be stored on their delivery cradles at a maximum distance of 6 m c/c. If the surface is not flat or sloping, then all the pipes shall be checked to prevent rolling. All rubber rings, gasket and other items shall be stored in a cold, dry and dark place to avoid damage of any kind. <b>(Refer Cl.</b></p>	<p>When transporting pipes, flat bed vehicles should be used. The bed should be free from nails and other projections. When practical, pipes should rest uniformly on the vehicle over the whole length. All support posts should be flat with no sharp edges. <b>(Refer Cl. No. 4.1 of IS 7634 Part 3 : 2003)</b></p>	<p>When transporting straight polyethylene pipes, use flat bedded vehicles. The bed shall be free from nails and other projections. The polyethylene pipes shall rest uniformly in the vehicle over their long length. All support posts shall be flat with no sharp edges. Polyethylene pipes shall not be transported with other metallic items in the same vehicle. <b>(Refer Cl. No. 12.4 of IS 7634 Part 2 : 2012)</b></p>	<p>Pipes should be loaded at the works for transportation, in such a way that they are secure and that no movement can take place on the vehicle during transit. The same care is needed if pipes are to be transferred from one vehicle to another.</p> <p>Pipes may be placed directly on the ground provided it is reasonably level and free from rocks and other projections. Stacking in tiers is permissible provided timber bearer are placed between succeeding tiers. If pipes are to be stacked more than two tiers high, reference should be made to manufacture for advice before exceeding the two tiers specified. <b>Cl. No. 15.1.1 and 15.1.3 of IS 783 : 1985)</b></p>	<p>Pipes should be loaded at the works for transportation, in such a way that they are secure and that no movement can take place on the vehicle during transit. The same care is needed if pipes are to be transferred from one vehicle to another.</p> <p>Pipes may be placed directly on the ground provided it is reasonably level and free from rocks and other projections. Stacking in tiers is permissible provided timber bearer are placed between succeeding tiers. If pipes are to be stacked more than two tiers high, reference should be made to manufacture for advice before exceeding the two tiers specified. <b>Cl. No. 15.1.1 and 15.1.3 of IS 783 : 1985)</b></p>		
------------------------------	---	---	--	--	---	---	---	--	--

			No. 4.1 and 4.2 of IS 13916 : 1994)			to manufacture for advice before exceeding the two tiers specified. Cl. No. 15.1.1 and 15.1.3 of IS 783 : 1985)			
<b>Risk against Flotation</b>	Pipes are heavier. Hence, floatation risk is nil.	Pipes are heavier. Hence, floatation risk is nil.	Cannot be used in water logged areas.	In case there is a chance of floatation because of likely flood, the pipe shall be encased with concrete weights as per the buoyancy calculations. (Refer Cl. No. 6.5 of IS 7634 Part 2 : 2012)	In case there is a chance of floatation because of likely flood, the pipe shall be encased with concrete weights as per the buoyancy calculations. (Refer Cl. No. 6.5 of IS 7634 Part 2 : 2012)	Pipes are heavier. Hence, floatation risk is nil.	Pipes are heavier. Hence, floatation risk is nil.	Pipes are heavier. Hence, floatation risk is nil.	Pipes are heavier. Hence, floatation risk is nil.
<b>Design Useful Service Life</b>					IS 4984-1995 <b>50 Years</b>				
	<u>ISO/FDIS 24516-1:2016(E) (annexure B) : 80-120 yrs</u>	<u>ISO/FDIS 24516-1:2016(E) (annexure B)</u> a) DI with PE, ZN or cement coating <b>90-120 yrs</b> b) DI without coating <b>40-80 yrs</b>		<u>ISO/FDIS 24516-1:2016(E) (annexure B) : 50-90 yrs</u>	<u>ISO/FDIS 24516-1:2016(E) (annexure B)</u> a) PE63/PE80- <b>40-70 yrs</b> b) PE80 Gen/PE100- <b>60-100 yrs</b>				

**IMPORTANT NOTE :**

The life of various pipe materials indicated above are taken from various sources like IS,ISO & NEERI and shows wide variation. While adopting these values for design of Piped Irrigation Network (PIN) including Life Cycle Analysis, cautions may be exercised based on the past performance, actual experience, manufacturer’s specifications etc..

<p><b>Limitation</b></p>	<p>Never to be used near electricity transmission cables.</p> <p>Never to be used below ground unless proper protection against corrosion from soil and soil water is ensured.</p> <p>Choice of spiral welded Vsor horizontal welded pipes shall be evaluated with respect to overburden. <b>(Refer MS-1, MS-2 &amp; MS-4 of Appendix A 3-10, Part A of CPHEEO Manual).</b></p>	<p>DI pipes are not to be used near buried electricity transmission high tension cables.</p> <p>Wherever used above ground supports at each pipe length shall be ensured without any subsidence.</p> <p>Pipes with external synthetic coatings not to be used in marine coastal environments to prevent leaching of constituent chemicals into the environment. <b>(Refer CIDI-1, CIDI-2 and CIDI-3 of Appendix A 3-10, Part A of CPHEEO Manual).</b></p>	<p>Not in area where future works may affect the pipes side support.</p> <p>Not in ground contaminated or possibly contaminated by certain chemicals in concentrations deleterious to the resin of the pipe.</p> <p>Do not use pipes/couplings with chips, cracks, crazing, layer delamination or exposed fibres or ends of pipes not sealed with resin.</p> <p>Do not use pipe and couplings, stored unprotected from sunlight for more than 9 months.</p> <p>Do not use in ground conditions having low stiffness, e.g. tidal zone.</p> <p>Not in location subjected to vehicular load and has insufficient cover.</p> <p>Not in areas subject to excavations by other service providers within 2m radial distance of pipeline.</p> <p>Not in ground subject to differential settlement of extreme movement.</p> <p>Not in ground offering</p>	<p>Not in location subjected to vehicular load and has insufficient cover.</p> <p>Not in areas subjected to third party interference, e.g. excavations within 2m of pipeline by other parties.</p> <p>Not in ground offering low side support strength to the pipe.</p> <p>Not in ground which allows migration of pipe embedment material into it.</p> <p>Not in ground contaminated with deleterious chemicals.</p> <p>Not suitable for above ground installation.</p> <p><b>(Refer SP-1 to SP-6 of Appendix A 3-10, Part A of CPHEEO</b></p>	<p>Not in location subjected to vehicular load and has insufficient cover.</p> <p>Not in areas subjected to third party interference, e.g. excavations within 2m of pipeline by other parties.</p> <p>Not in ground offering low side support strength to the pipe.</p> <p>Not in ground which allows migration of pipe embedment material into it.</p> <p>Not in ground contaminated with deleterious chemicals.</p> <p>Not suitable for above ground installation.</p> <p><b>(Refer SP-1 to SP-6 of Appendix A 3-10, Part A of CPHEEO Manual).</b></p>	<p>Not in aggressive soils / ground water or tidal zone</p> <p><b>(Refer RCC-2 of Appendix A 3-10, Part A of CPHEEO Manual).</b></p>	<p>In contaminated ground or possibly contaminated ground by certain chemicals in concentrations where it can affect the life of concrete , additional barrier coating of coal tar epoxy paint is to be provided and Sulphate resisting cement to be used for manufacturing pipes .</p>	<p>In contaminated ground or possibly contaminated ground by certain chemicals in concentrations where it can affect the life of concrete , additional barrier coating of coal tar epoxy paint is to be provided and Sulphate resisting cement to be used for manufacturing pipes .</p> <p>In Black Cotton Soil (Expansive Soil) care has to be taken for bedding and back filling.</p>	<p>In contaminated ground or possibly contaminated ground by certain chemicals in concentrations where it can affect the life of concrete , additional barrier coating of coal tar epoxy paint is to be provided and Sulphate resisting cement to be used for manufacturing pipes .</p>
--------------------------	---	---	--	---	--	--	---	---	---

			<p>low side support strength to the pipe. Do not use when control of construction practices is not adequate to ensure quality of embedment for flexible pipes. Not suitable for uncertainties in geotechnical analysis to determine if flexible pipe structurally suitable. Uplift precaution in locations where high groundwater table and empty pipe may be encountered.  <b>(Refer GRP-1 to GRP-12 of Appendix A 3-10, Part A of CPHEEO Manual).</b></p>	<p><b>Manual).</b></p>					
--	--	--	---	------------------------	--	--	--	--	--

Table 5.3 Various Pipe material &amp; Dia. Available

Sl. No.	Pipe IS No.	Usual Diameter (mm)	Class	Test Pressure at Works (kg/cm <sup>2</sup> )	Maximum Working Pressure at Field (kg/cm <sup>2</sup> )
1	DI pipe IS: 8329-2000	80, 100, 125, 150, 200, 250, 300, 350, 400, 450, 500, 600, 700, 750, 800, 900, 1000, 1100, 1200	K-7 K-8 K-9 K-10	12 – 32 18 – 40 25 – 50 25 – 50	17.5 – 40 20 – 96 36 – 96 40 – 96
2	Cast (Spun) Iron Pipes IS: 1536-2001	80 - 1050	LA A B	15 - 35 20 - 35 25 - 35	15 – 16 20 25
3	RCC Pipes IS:458-2003	90 – 2000	NP3 NP4	0.7	Non Pressure Pipes
4	Prestressed Concrete Non Cylinder Pipes RC pipes IS:784-2001	350 – 2500	Upto 20 Kg/cm <sup>2</sup> Factory Test Pressure (FTP)	1.5 times design pressure	Upto 12 Kg/cm <sup>2</sup> Working Pressure (WP)
5	Steel Pipes IS: 3589-2001	168.3 -2540	Fe330 Fe410 Fe450		
6	i. PVC Pipes IS: 4985-2000, ii. HDPE Pipes IS:4984-1995 iii. Spirally Wound Profiled PE/PP Pipes (IS code: 16098 part 2:2013)	50-630 50-2500 300-3000	PN 2.5/ 4/6/ /10 /12.5 PN 2.5/ 4/6/ /10 /12.5 PN 2.5 /4/6	should not be less than design pressure at 27°C for duration of 1 hr.(ISO 1167 Part-1)	3.6 X PN 0.25 MPa (2.5 kg/cm <sup>2</sup> ) 0.4 MPa (4.0 kg/cm <sup>2</sup> ) 0.6 MPa (6.0 kg/cm <sup>2</sup> ) 1.0 MPa (10.0 kg/cm <sup>2</sup> ) 1.25 MPa (12.5 kg/cm <sup>2</sup> ) 1.6 MPa (16.0 kg/cm <sup>2</sup> ) 2.5 4 6
7	GRP (Glass Fibre Reinforced Pipes) IS: 12709	200-2000	3 6 9 12 15	4.5 9 13.5 18 22.5	6 12 16 24 30
8	BWSC ( Bar Wrapped Steel Cylinder Pipes) IS 15155	250 - 1900	Upto 28 Kg/cm <sup>2</sup> Factory Test Pressure (FTP)	1.5 times design pressure	Upto 17 Kg/cm <sup>2</sup> Working Pressure (WP)
9	PCCP (Prestressed Concrete Cylinder Pipes) IS 784	350 - 2500	Upto 25 Kg/cm <sup>2</sup> Factory Test Pressure (FTP)	1.5 times design pressure	Upto 15 Kg/cm <sup>2</sup> Working Pressure (WP)

## 5.6 Structure and Layout of Piped Irrigation Networks

A Piped Irrigation Network/ Pressure pipe irrigation network system consists mainly of buried pipes and is therefore relatively free from topographic constraints. The aim of the network is to connect all the hydrants to the source by the most economic and hydraulically efficient layout. The source can be a pumping station on a river, a canal or well delivering water through an elevated reservoir or directly into the network.

Generally tree networks are adopted or considered since they cost less than looped networks. Loops are only introduced where it becomes necessary to reinforce existing networks or to guarantee the security of supply.

### 5.6.1 Layout of branching networks

#### *Principles*

On-demand distribution imposes no specific constraints upon the layout of the network: where the land-ownership structure is heterogeneous, the plan of the hydrants represents an irregular pattern of points, each of which is to be connected to the source of water.

A method of arriving at the optimal network layout involves the following three step iterative process:

- i. **Proximity Layout:** the source or the shortest connection of hydrants to source.
- ii. **120° Layout:** where the proximity layout is shortened by introducing junctions (nodes) other than the hydrants.
- iii. **Least Cost Layout:** where the cost is again reduced, this time by shortening the larger diameter pipes which convey the higher flows and lengthening the smaller ones.

The last step presupposes the knowledge of the pipe diameters.

### 5.6.2 Fields of application of pipe network optimization

#### a) Case of a dispersed land tenure pattern

A search for the optimal network layout can lead to substantial returns. An in depth study (ICID 1971)

on a network serving 1000 ha showed that there could be nine percent cost reduction in comparison to initial layout when optimized. This cost reduction was obtained essentially in the range of pipes having diameters of 400 mm or more.

In general it may be said that the field of application of network layout optimization mainly concerns the principal elements of the network (pipe diameters of 400 mm and upwards). Elsewhere land tenure and ease of maintenance (accessibility of junctions, etc.) generally outweigh considerations of reduction of pipe costs.

#### b) Case of a rectangular pattern of plots

In the case of schemes where the land tenure has been totally redistributed to form a regular check-work pattern of plots, the pipe network can follow the same general layout with the average plot representing the basic module or unit. The layout of the pipe network is designed so as to be integrated with the other utilities, such as the roads and the drainage system.

## 5.7 Optimization of the Layout of Branching Networks

The method commonly used (*FAO-Clement and Galland 1979*) involves three distinct stages:

- a) Proximity layout
- b) 120° layout
- c) Least-cost layout

### 5.7.1 Proximity layout:

The aim is to connect all hydrants to the source by the shortest path without introducing intermediate junctions here denominated as nodes. This may be done by using a suitable adaptation of *Kruskal's classic algorithm* from the theory of graphs.

If a straight line drawn between hydrants is called a Section and any closed circuit a loop, then the algorithm proposed here is the following:

Proceeding in successive steps a section is drawn at each step by selecting a new section of minimum length which does not form a loop with the sections already drawn. The procedure is

illustrated in *Figure 5.7 (a)* for a small network consisting of six hydrants only.

In the case of an extensive network, the application of this algorithm becomes impractical since the number of sections which have to be determined and compared increases as the square of the number of hydrants:  $(n^2 - n)/2$  for 'n' hydrants. For this reason it is usual to use the following adaptation of *Sollin's algorithm*.

Selecting any hydrant as starting point, a section is drawn to the nearest hydrant thus creating a 2-hydrant sub network.

This sub-network is transformed into a 3-hydrant sub-network by again drawing a section to the nearest hydrant. This in fact is an application of a simple law of proximity, by which a sub-network of  $n-1$  hydrants becomes a network of n hydrants by addition to the initial network. This procedure, which considerably reduces the number of sections which have to be compared at each step, is illustrated in *Figure 5.7(b)*.

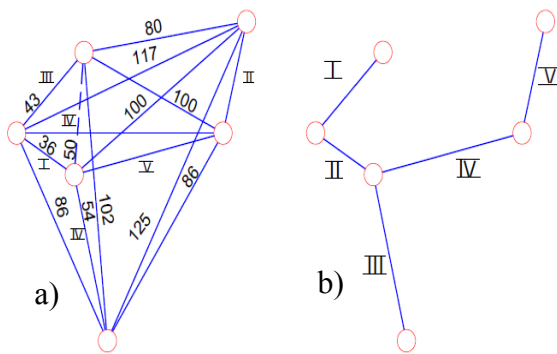

Figure 5.7 Proximity layout –(a) application of kruksal’s algorithm (b) application of Sollin's algorithm

**5.7.2 120° Layout**

By introducing nodes other than the hydrants themselves, the proximity network defined above can be shortened other than the hydrants.

Case of 3 Hydrants:

Consider a sub-network of three hydrants A, B, C linked in that order by the proximity layout (*Fig*

5.8). A node M is introduced whose position is such that the sum of the lengths MA + MB + MC is minimal.

For three hydrants, it follows therefore that the angle AMB BMC and CMA are each equal to 120°.

The optimal position of the node M can readily be determined by construction with the help of a piece of tracing paper on which are drawn three converging lines subtending angles of 120°. By displacing the tracing paper over the drawing on which the hydrants A, B, C have been disposed, the position of the three convergent lines is adjusted without difficulty and the position of the node determined,

A new node can only exist if the angle ABC is less than 120°. When the angle is greater than 120°, the initial layout ABC cannot be improved by introducing a node and it represents the shortest path. Conversely, it can be seen that the smaller is the angle ABC, the greater will be the benefit obtained by optimizing.

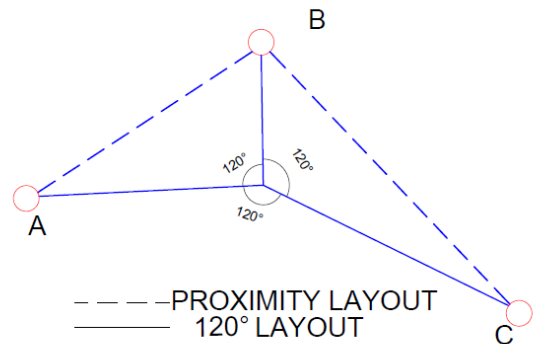

Figure 5.8 120° Layout - Case of 3 Hydrants

Case of 4 Hydrants:

The 120° rule is applied to the case of a four-hydrant network ABCD (*Fig. 5.9 & 5.10*).

The layout ABC can be shortened by introducing a node M<sub>1</sub>, such that links M<sub>1</sub>A, M<sub>1</sub>B and M<sub>1</sub>C are at 120° to each other. Similarly the layout M<sub>1</sub>CD is shortened by the introduction of a node M<sub>1</sub>' such that M<sub>1</sub>'M<sub>1</sub>, M<sub>1</sub>'C and M<sub>1</sub>'D subtend angles of 120'. The angle AM<sub>1</sub>M<sub>1</sub>' is smaller than 120° and the

node  $M_1$  is moved to  $M$ , by the  $120^\circ$  rule, involving a consequent adjustment of  $M_1'$  to  $M_2'$ .

The procedure is repeated with the result that  $M$  and  $M'$  converge until all adjacent links subtend angles of  $120^\circ$ .

In practice, the positions of  $M$  and  $M'$  can readily be determined manually with the assistance of two pieces of tracing paper on which lines converging at  $120^\circ$  have been drawn.

A different configuration of the four hydrants such as the one shown in *Figure 5.10*, can lead to a layout involving the creation of only one node since the angle  $ABM$  is greater than  $120^\circ$ .

#### Case of n Hydrants:

The above reasoning can be extended to an initial layout consisting of  $n$  hydrants. It can be shown that the resulting optimal layout has the following properties:

- ✓ the number of nodes is equal to or less than  $n-2$ ;
- ✓ there are not more than three concurrent sections at any node;
- ✓ the angles between sections are equal to  $120^\circ$  at nodes having three sections and greater than  $120^\circ$  when there are only two sections.

In practice it is impractical to deal manually with the construction of a network consisting of four or five hydrants, involving the introduction of two or three adjacent nodes, even with the help of tracing paper. Several geometric construction procedures have been devised to facilitate such layouts, but these are rather cumbersome and the problem can only be resolved satisfactorily with the assistance of a computer.

In actual fact it rarely happens that it is necessary to create more than two or three consecutive nodes. It should also be noted that the benefit to be gained by optimizing decreases as the number of adjacent links to be examined increases.

### 5.7.3 Least-cost layout

Although the layout which results from applying the  $120^\circ$  rule represents the shortest path connecting the hydrants, it is not the solution of least cost since no account is taken of pipe sizes. The total cost of the network can further be reduced by shortening the larger diameter pipes which convey higher flows whilst increasing the length of the smaller diameter pipes which convey smaller flows. This will result in a modification of the angles between sections at the nodes. The least-cost layout resembles the  $120^\circ$  layout but the angles joining the pipes are adjusted to take into account the cost of the pipes.

The step which leads from the  $120^\circ$  layout to the least-cost layout can only be taken once the pipe sizes have been optimized. But this condition induces to a loop. In fact, for calculating the pipe sizes of the network, the layout should be already known. A method for the simultaneous computation of optimal pipe size and layout has been developed for particular distribution systems with parallel branches (Ait Kadi, 1986). Two different approaches have been adopted: the linear programming formulation and a special purpose algorithm. Both these two approaches have been applied to a simple example and their reliability and usefulness was demonstrated. Unfortunately, at this time, no commercial software packages are available for applying such method to actual networks.

Going back to the three hydrant sub-network  $A, B, C$  in *Figure 5.8*.

If  $a, b$  and  $c$  are the unit price of the pipes connecting the node to the hydrants  $A, B$  and  $C$ . Then the angles of the pipes converging at the new node  $M'$ , can therefore be determined by constructing a triangle the length of whose sides are proportional to  $a, b$  and  $c$ . The position of  $M'$  can be adjusted as before with the help of tracing paper on which suitably orientated converging lines have been drawn as depicted in *figure 5.11*.

The least-cost layout resembles the  $120^\circ$  layout but the angles joining the pipes are adjusted to take into account the cost of the pipes.



It should be noted moreover that the step which leads from the  $120^\circ$  layout to the least-cost layout requires knowledge of the pipe sizes and it can therefore only be taken once the pipe sizes have been optimized.

The  $120^\circ$  layout is an improvement on the initial proximity layout and that the least-cost layout is a further refinement of the  $120^\circ$  layout. It is not certain however that the complete process produces the best result in all cases.

The optimum attained is relative to a given initial layout of which the proximity layout is only the shortest path variant. It could be that a more economic solution might be found by starting with a different intuit layout, differing from that which results from proximity considerations, but which takes into account hydraulic constraints.

In practice, by programming the methods described above for computer treatment, several

initial layouts of the network can be tested. The first of these should be the proximity layout. The others can be defined empirically by the designer, on the basis of the information available - elevation of the hydrants and distance from the source - which enables potentially problematic hydrants to be identified.

By a series of iterations it is possible to define a "good" solution, if not the theoretical optimum.

Example of layout of a small network designed to supply irrigation water to 240 ha (net) is shown on *Figures 5.12*. The successive design phases produced the following results as given in Table 5.4.

Estimates as given in Table 5.4 are based on the cost of engineering works only. They do not include the purchase of land, right-of-way or compensation for damage to crops which might occur during construction, all of which would increase the cost of the optimum network.

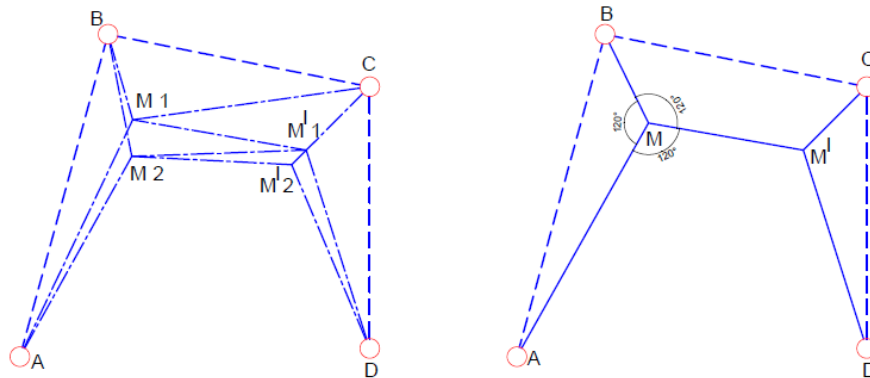

Figure 5.9  $120^\circ$  Layout – Case of 4 hydrants

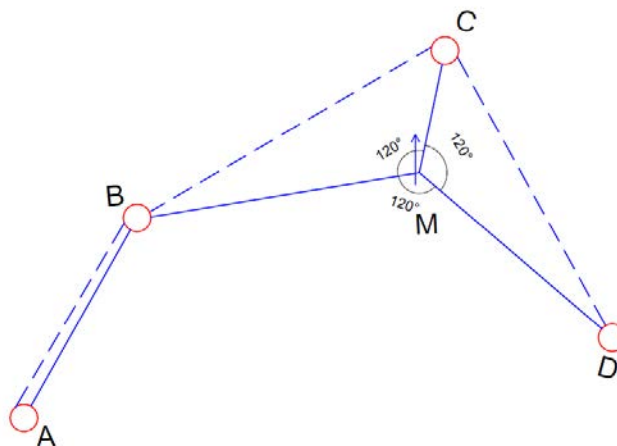
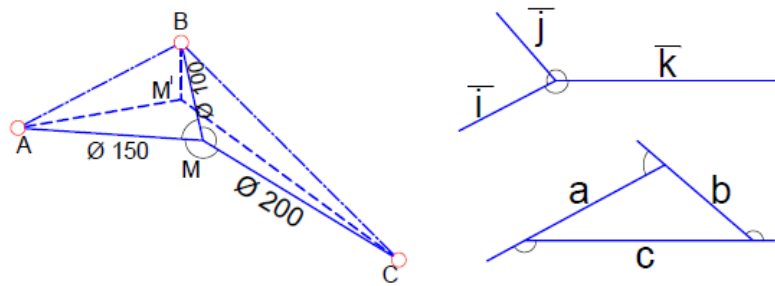

Figure 5.10  $120^\circ$  Layout – Case of 4 hydrants (different Configuration)



SECTION	DIAMETERS	UNIT PRICE
M B	100	200
M A	100	200
M C	200	400

- - - - - PROXIMITY LAYOUT  
 . . . . . 120° LAYOUT  
 ———— LEAST COST LAYOUT

Figure 5.11 Least Count Layout

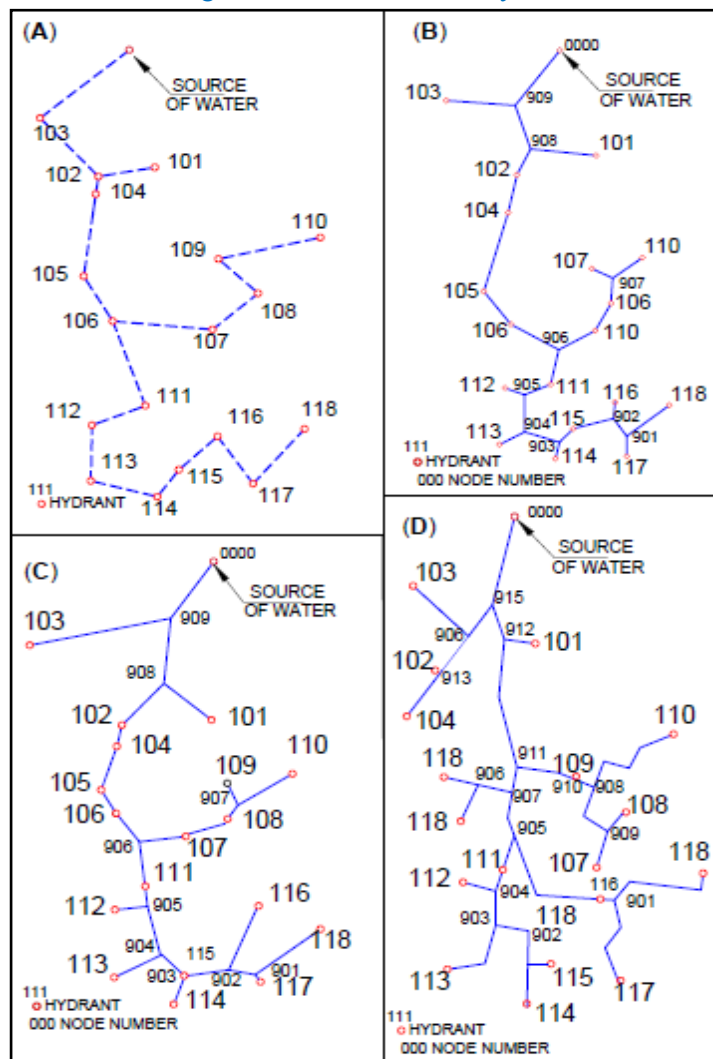

Figure 5.12 Piped Irrigation Network Optimisation

A) Proximity Layout B) 120° layout C) Least Cost Layout D) Layout best suited to field conditions

Table 5.4 Details of methods applied

Length (Rmt)	Cost (k\$)	Method	Figure No
105.9	-	Proximity Layout	5.12(A)
100	108.2	120° layout	5.12(B)
104.6	100	Least Cost Layout	5.12(C)
126.9	107.6	Empirical layout, connecting the same hydrants by following roads, tracks and plot boundaries	5.12(D)

### 5.7.4 Applicability of the layout optimization methods

There is no doubt that the 120° layout is an improvement on the initial proximity layout and that the least-cost layout is a further refinement of the 120° layout. It is not certain however that the complete process produces the best result in all cases.

Usually, “rules of thumb” are applied by designers in selecting the best suitable layout and, later, optimization algorithms are applied for computing the pipe sizes. The optimum attained is relative to a given initial layout of which the proximity layout is only the shortest path variant. It could be that a more economic solution is possible by starting with a different initial layout, differing from that which results from proximity considerations, but which takes into account hydraulic constraints.

In practice, by programming the methods described above for computer treatment, several initial layouts of the network can be tested. The first of these should be the proximity layout. The others can be defined empirically by the designer, on the basis of the information available (elevation of the hydrants and distance from the source) which enables potentially problematic hydrants to be identified. By a series of iterations it is possible to define a "good" solution, if not the theoretical

optimum. Furthermore, *it should be noted that the above estimates are based on the cost of engineering works only.* They do not include the purchase of land, right-of-way and/or compensation for damage to crops which might occur during construction, all of which would affect and increase the cost of the network and might induce to modify the optimal layout.

## 5.8 Piped Irrigation Network Design

### 5.8.1 Simple Piped Irrigation Network

In a Water Distribution Network (WDN), the sub-networks are represented by an equivalent pipe. The network is categorized as pipes in series or parallel as explained below:

**a) Pipes in series:** A network and a pipe are equivalent when both carry the same discharge for the same head-loss.

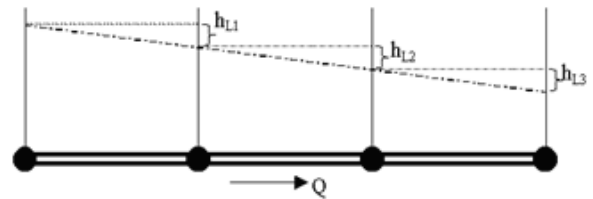

Figure 5.13 Pipes in Series

$$h_{L_e} = \sum_{i=1}^n h_{L_i}$$

$$K_e = \sum_{i=1}^n K_i$$

$$Q = Q_1 = Q_2 = \dots Q_n$$

**Pipes in parallel:** When pipes are connected in parallel, the head loss in each pipe between the junctions will be the same.

$$h_{L_1} = h_{L_2} = h_{L_3} = \dots$$

$$Q = Q_1 + Q_2$$

and

$$\left(\frac{h_L}{K_e}\right)^{1/n} = \left(\frac{h_L}{K_1}\right)^{1/n} + \left(\frac{h_L}{K_2}\right)^{1/n}$$

or

$$\left(\frac{1}{K_e}\right)^{1/n} = \left(\frac{1}{K_1}\right)^{1/n} + \left(\frac{1}{K_2}\right)^{1/n}$$

or

$$\frac{V_1}{V_2} = \sqrt{\frac{f_2 L_2 D_2}{f_1 L_1 D_1}}$$

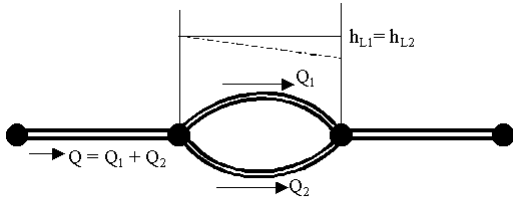

Figure 5.14 Pipes in Parallel

**5.8.2 Complex Piped Irrigation Network**

A Piped Irrigation Network, where large number of branching, loops and other in-line elements such as control valves, pressure relief valves etc are there is called Complex Piped Irrigation Network. In the design of WDN, the objective is minimization of network cost, which is the sum of costs of pipelines, in case of gravity fed networks. The constraints are:

- i. The sum of the lengths of pipes in each link is equal to the length of the line.
- ii. The algebraic sum of the head losses in a path from source to each demand node is not more than the permissible head loss in the path.
- iii. the algebraic sum of the head losses in each loop is zero; and
- iv. all pipe lengths are non-negative

$$\text{Minimize Cost} = \sum \sum C_j L_{ij}$$

Subject to

$$\sum L_{ij} = L_i$$

$$\sum \sum S_{ij} L_{ij} = H_j - H_n^{min}$$

for all paths from Source Node (S) to Demand Node (n)

$$\sum \sum S_{ij} L_{ij} = 0 \quad \text{for all loops}$$

$$L_{ij} \geq 0 \quad \text{for all } i \text{ and } j$$

The solution of the problem involves following steps:

- i. Hydraulic analysis of the WDN using any of the techniques like *Hardy Cross*, *Linear theory* or *Newton-Raphson*.
- ii. Finding the optimum solution using Linear Programming (LP) technique by taking the length of the pre-selected pipe diameters as the decision variables.

**a) Hardy-Cross Method**

This method was developed by Hardy-Cross (1936) and is frequently used to analyze the hydraulics of flow through a WDN. In the Hazen-Williams, Manning's or Darcy-Weisbach method,

the head loss  $h$  (m) in a pipe carrying discharge at  $Q$  ( $\text{m}^3/\text{s}$ ), is given by:

$$h = k Q^n$$

where  $k$  is a constant and  $n$  is an exponent. If the Hazen-Williams equation is used,  $n = 1.85$ .

In the absence of the knowledge of discharge  $Q$  flowing through a pipe, let the assumed discharge be  $Q_1$ . It can written as

$$Q = Q_1 + \Delta$$

where  $\Delta$  is the error in the assumed discharge. Substituting  $Q$  in  $h = k Q^n$  yields

$$k Q^n = k (Q_1 + \Delta)^n = k [Q_1^n + n Q_1^{n-1} \Delta + \dots]$$

If  $\Delta$  is small compared to  $Q$ , the higher-order terms can be neglected and this yields

$$k Q^n = k (Q_1 + \Delta)^n = k [Q_1^n + n Q_1^{n-1} \Delta]$$

For a pipe loop, the sum of head losses for all pipes must be zero. This yields

$$\sum k Q^n = 0$$

$$\text{or} \quad \sum k [Q_1^n + n Q_1^{n-1} \Delta] = 0$$

$$\Delta = - \frac{\sum k Q_1^n}{n \sum k Q_1^{n-1}} = - \frac{\sum h}{n(\sum h/Q)}$$

*Steps of The Hardy-Cross Method*

- i. Assume a distribution of flow in the network which should satisfy the Continuity Equation. *Ensure that at a junction, the sum of flows entering must be equal to the sum of flows leaving.*
- ii. Determine the head loss in each pipe. As per the conventions, Clockwise flows are given positive sign and anti-clockwise flows are given negative sign.
- iii. Compute head loss for each loop, i.e.,  $\sum k Q_1^n$  should be determined with due regard to sign.
- iv. Determine,  $\sum k n Q_1^{n-1}$  without regard to sign.
- v. Substitute these values in correction equation to determine correction.
- vi. Apply the correction and determine the revised flow in each pipeline.
- vii. Repeat steps i to vi till the correction term is negligible.
- viii. Estimate the pressure heads at various nodes using the head loss equation.

**b) Linear Theory Method**

Linear Theory Method (LTM) is used in solving a system of equations with unknown flow rates or

Q's values. The LTM has several distinct advantages over the Hardy Cross or Newton Raphson method. First, it does not require an initialization and secondly, it always converges in a relatively fewer iterations. However, its use in solving head oriented or collective loop oriented equations is not recommended.

Linear Theory transforms the non-linear loop equations into linear equations, approximating the head in each pipe by:

$$h_{Li} = [K_i Q_i(0)^{n-1}] Q_i = K'_i Q_i$$

Combining these artificial linear loop equations with  $J-1$  continuity equations ( $J$  is number of junctions), we get a system of ' $N$ ' linear equations that can be solved by linear algebra.

In applying the LTM, it is not necessary to supply the initial guess. Instead, for the first iteration, each  $K'_i$  is set equal to  $K_i$ , which implies all flow rates  $Q_i(0)$  are set equal to unity. Also, since the successive iterations tend to oscillate about the final solution, hence when two iterative solutions are obtained, then each flow rate used in computation can be the average flow rate from last two iterations. i.e.

$$Q_i = \{Q_i(n-1) + Q_i(n-2)\}/2$$

#### Steps in Linear Theorem

- i. Obtain ' $K$ ' and ' $n$ ' for Exponential Formula for a range of realistic flow rates. The ' $K$ ' and ' $n$ ' values may be obtained for any of the previously discussed equations such as Darcy Weisbach, Hazen William etc.
- ii. Form equivalent pipes for those pipes containing global valves and orifice meter etc.
- iii. Write  $J-1$  continuity equations, with due regard to sign of flow rates. As per convention, flow rates for pipes whose flows are assumed into the junction may be taken as positive and those out from junction may be taken as negative.
- iv. Linearize the head loss equations by forming a coefficient  $K'_i$  for each  $Q_i$  which equals the product of  $K_i$  and  $Q_i(0)^{n-1}$ .
- v. For the first iteration, assume each  $Q_i(0) = 1$ . Now, you get a set of linearized energy equations, which can be solved using Gaussian elimination, Gauss Jordan elimination or other appropriate methods.
- vi. Once the values of  $K'_i$ 's and  $Q_i$ 's, are obtained from the previous step, we can use these values to modify coefficients in the energy equation. Thus, the value of ' $K$ ' and ' $n$ ' in Exponential formula may be modified and so the value of  $K_i$ 's.
- vii. Repeat the procedure with modified energy equations and obtain the values of  $K'_i$ 's and  $Q_i$ 's for the second iteration.
- viii. Use average of the flow rates obtained from first and second iteration to define again the coefficients in energy equation for third iteration and Later from second and third iteration to define the coefficients in energy equation for fourth iteration.
- ix. Carry on these iterations till the last two iterations for  $Q_i$ 's and  $K_i$ 's are similar upto a desired accuracy.

## 5.9 Software Programmes

The following software programmes are available for the optimization of the network design:

- 1) EPANET
- 2) KYPIPE
- 3) PIPE FLOW EXPERT
- 4) VADISO
- 5) LOOP
- 6) HARDY
- 7) LINGO/LIGDO
- 8) WATER GEMS

## 5.10 Water Hammer

All irrigation distribution systems are susceptible to pressure surge or water hammer. Surges occur when the velocity of water within the system changes from a steady state condition to another.

The most severe surges usually occur on starting and stopping pumps or instantaneous opening and closing of a valve in a pipeline. It may be caused by nearly instantaneous or too rapid closing of a valve in the line, or by an equivalent stoppage of flow such as would take place with the sudden failure of electricity supply to a motor driven pump.

Pressure surges may be high and can result in significant damage to piping, pumps and other components of the irrigation system. Designers should be aware that water hammer effects are

always possible and must consider possible effects on the design loads for the system.

Water velocity contributes significantly to the effects of water hammer. Lower velocities limit the adverse effects of water hammer. A water hammer analysis (Hydraulic Transient Analysis of Piped Irrigation Network) may be necessary and mitigation measures specified to lessen the risk of damage. Such analysis is complex and specialized engineering services may be required to analyze the proposed mainline design.

#### 5.10.1 Control Measures

The internal design pressure for any section of a pipeline should not be less than the maximum operating pressure or the pipeline static pressure obtaining at the lowest portion of the pipeline considered including any allowance required for surge pressure.

The maximum surge pressure should be calculated and the following allowances made.

- i. If the sum of the maximum operating pressure or the maximum pipeline static pressure whichever is higher and the calculated surge pressure does not exceed 1.1 times the internal design pressure, no allowance for surge pressure is required,
- ii. If the sum exceeds 1.1 times the internal design pressure, then protective devices should be installed and
- iii. In no case the sum of the maximum operating pressure and the calculated surge pressure should exceed the field hydrostatic test pressure

Depending upon the layout of the network, the profile and the length of the pipeline, surging in pipelines can be counteracted in two fundamentally different ways

- i. By checking the formation of the initial reduced pressure wave itself by means of flywheels ( which lengthen the slowing down time of the pump ) and air vessels (which continue to feed water into the pipeline until the reflected pressure wave again reaches the pump) and
- ii. By neutralizing the reflected wave from the reservoir by installing special devices in the

pipelines, some of which are automatically controlled quick closing valves, automatically controlled by passes and pressure relief valves. To obtain greatest effectiveness, the relief valve or other form of suppressor should be located as close as possible to the source of disturbance.

Since the maximum water hammer pressure in meters is about 125 times the velocity of flow in m/s and the time of closure of gate valves varies inversely with the size of the main, water hammer is held within bounds in small pipelines by operating them at moderate velocities of 1 to 2 m/s. In large mains, the pressure is held down by changing velocities at sufficiently slow rate so that the relief valve returns to position of control before excessive pressures are reached. If this is not practicable, pressure relief or surge valves are used.

For mains larger than 1.75 m, which operate economically at relatively high velocities of 2 to 3 m/s and cannot be designed to withstand water hammer without prohibitive cost, the energy is dissipated slowly by employing surge tanks.

*Once the whole network Piped Irrigation Network is finalised, the whole system needs to be checked for water hammer condition.*

#### 5.11 Some examples of Pipe Network analysis

The pipe network can also be analyzed by using commonly used software, WHAMO (Water Hammer and Mass Oscillation) which is used for Hydraulic Transient analysis in Hydroelectric plants. This was developed by US Army Corps of Engineers.

It is important to note that major pipe networks need to be checked for any possible failure which can occur due to water hammer pressure fluctuations (pressure rise or fall) arising out of sudden closure or opening of some of the outlets by the farmer. *This type of hydraulic transient conditions can be easily analyzed in WHAMO.* Some simple network analysis has been done using WHAMO and the results are as below.

### 5.11.1 The pipe network with two reservoirs is shown below:

Nodes 1 & 8 are reservoirs with head 150 ft and 140ft respectively.

Water demand at nodes: At node 5 - 5cfs, at node 6 & 11 - 1cfs

All pipes are 8 inch dia. and 1000 ft. length. Darcy's friction factor 0.021. The head at various nodes and discharges through various pipe reaches have been determined using WHAMO software. The results are shown below:

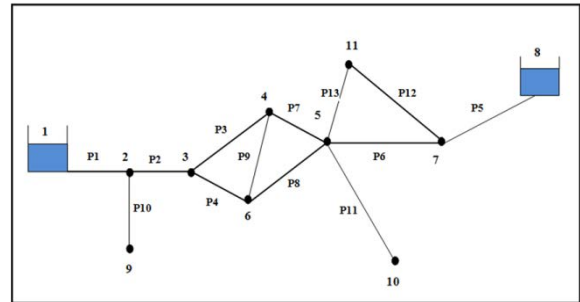

Figure 5.15 Network modelled in WHAMO

```

WATER HAMMER AND MASS OSCILLATION MODEL
-----
VERSION 3.0                CAMP DRESSER AND MCKEE, INC.                NOV., 1994
-----
PIN NETWORK EXAMPLE 2
-----
DATE : 4/30/17                TIME : 23:19:36
-----
    
```

SIMULATION SUMMARY  
\*\*\*\*\*

RUN OF 4/30/17 AT 23:19:36  
TITLED: PIN NETWORK EXAMPLE 2

NODE NUMBER	MAXIMUM ENERGY ELEV. (FEET)	TIME (SEC)	MINIMUM ENERGY ELEV. (FEET)	TIME (SEC)	MAXIMUM DISCHARGE (CFS)	TIME (SEC)	MINIMUM DISCHARGE (CFS)	TIME (SEC)
1	150.0	0.0	150.0	0.0	3.0	0.0	3.0	30.0
2	112.7	1.0	112.7	2.0	3.0	0.0	3.0	30.0
	112.7	1.0	112.7	2.0	0.0	0.6	0.0	1.5
	112.7	1.0	112.7	2.0	3.0	0.0	3.0	30.0
9	112.7	1.1	112.7	1.9	0.0	0.0	0.0	0.0
3	75.4	0.8	75.4	2.0	3.0	0.0	3.0	30.0
	75.4	0.8	75.4	2.0	1.5	0.1	1.5	35.0
	75.4	0.8	75.4	2.0	1.6	35.0	1.6	0.1
4	66.0	0.3	66.0	0.0	1.5	0.0	1.5	35.0
	66.0	0.3	66.0	0.0	1.1	35.0	1.1	0.0
	66.0	0.3	66.0	0.0	0.4	0.0	0.4	35.0
6	65.2	0.6	65.2	2.2	1.6	35.0	1.6	0.0
	65.2	0.6	65.2	2.2	1.0	0.0	1.0	0.0
	65.2	0.6	65.2	2.2	1.0	0.0	1.0	35.0
	65.2	0.6	65.2	2.2	0.4	0.0	0.4	35.0
13	65.2	0.6	65.2	2.2	1.0	0.0	1.0	0.0
5	61.2	0.0	61.2	2.6	1.0	0.0	1.0	35.0
	61.2	0.0	61.2	2.6	5.0	0.0	5.0	0.0
	61.2	0.0	61.2	2.6	0.0	3.6	0.0	0.3
	61.2	0.0	61.2	2.6	-1.0	35.0	-1.0	0.1
	61.2	0.0	61.2	2.6	-2.0	0.0	-2.0	35.0
	61.2	0.0	61.2	2.6	1.1	35.0	1.1	0.1
14	61.2	0.0	61.2	2.6	5.0	0.0	5.0	0.0
10	61.2	0.1	61.2	2.5	0.0	0.0	0.0	0.0
11	64.4	0.1	64.4	2.9	-1.0	35.0	-1.0	0.0
	64.4	0.1	64.4	2.9	-2.0	35.0	-2.0	0.0
	64.4	0.1	64.4	2.9	1.0	0.0	1.0	0.0
15	64.4	0.1	64.4	2.9	1.0	0.0	1.0	0.0
7	77.3	0.2	77.3	2.9	-2.0	0.1	-2.0	35.0
	77.3	0.2	77.3	2.9	-4.0	0.5	-4.0	29.0
	77.3	0.2	77.3	2.9	-2.0	35.0	-2.0	0.0
12	140.0	0.0	140.0	0.0	-4.0	0.5	-4.0	29.0

Figure 5.16 Output of WHAMO simulations



5.11.2 The pipe network with two loops is shown below:

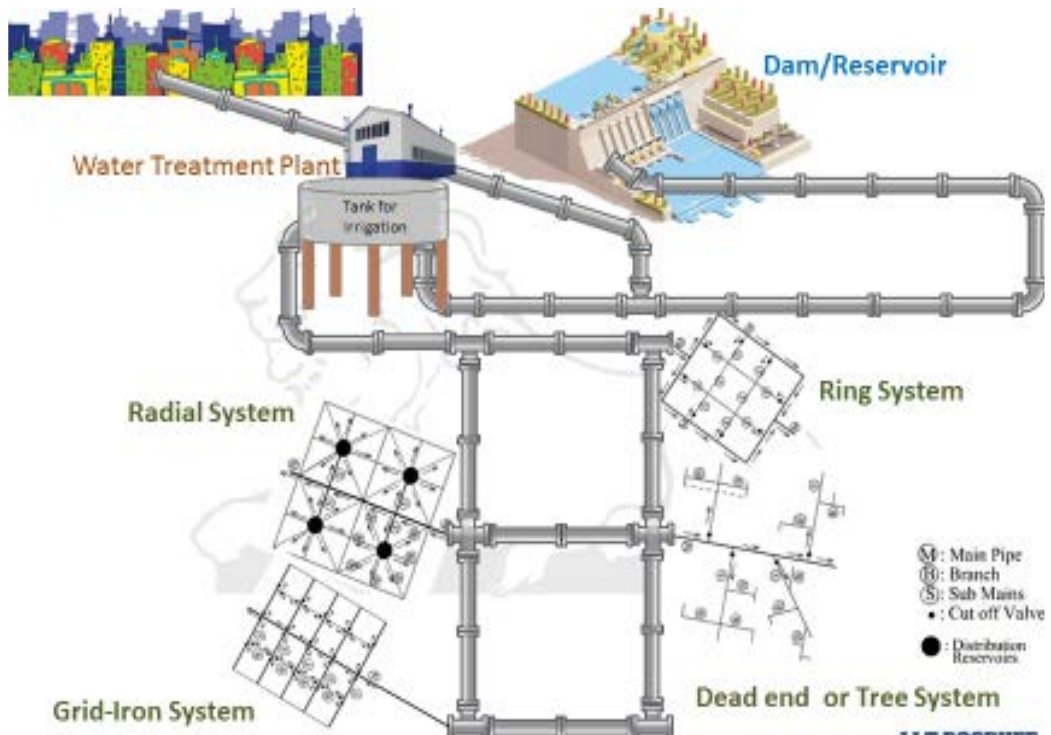

Figure 5.17 Pipe network with two loops

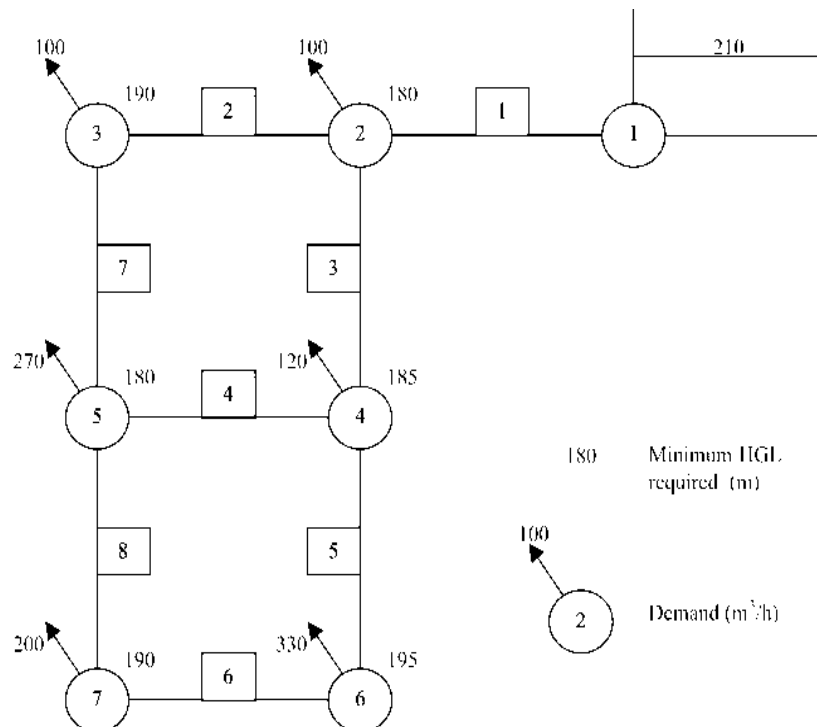

Figure 5.18 Schematic diagram of the model of the pipe network with two loops

There are 8 links of 1000m each. Hazen William friction factor C=130 for all pipes. The above pipe

network with two loops have been analysed in WHAMO and the results are shown below:

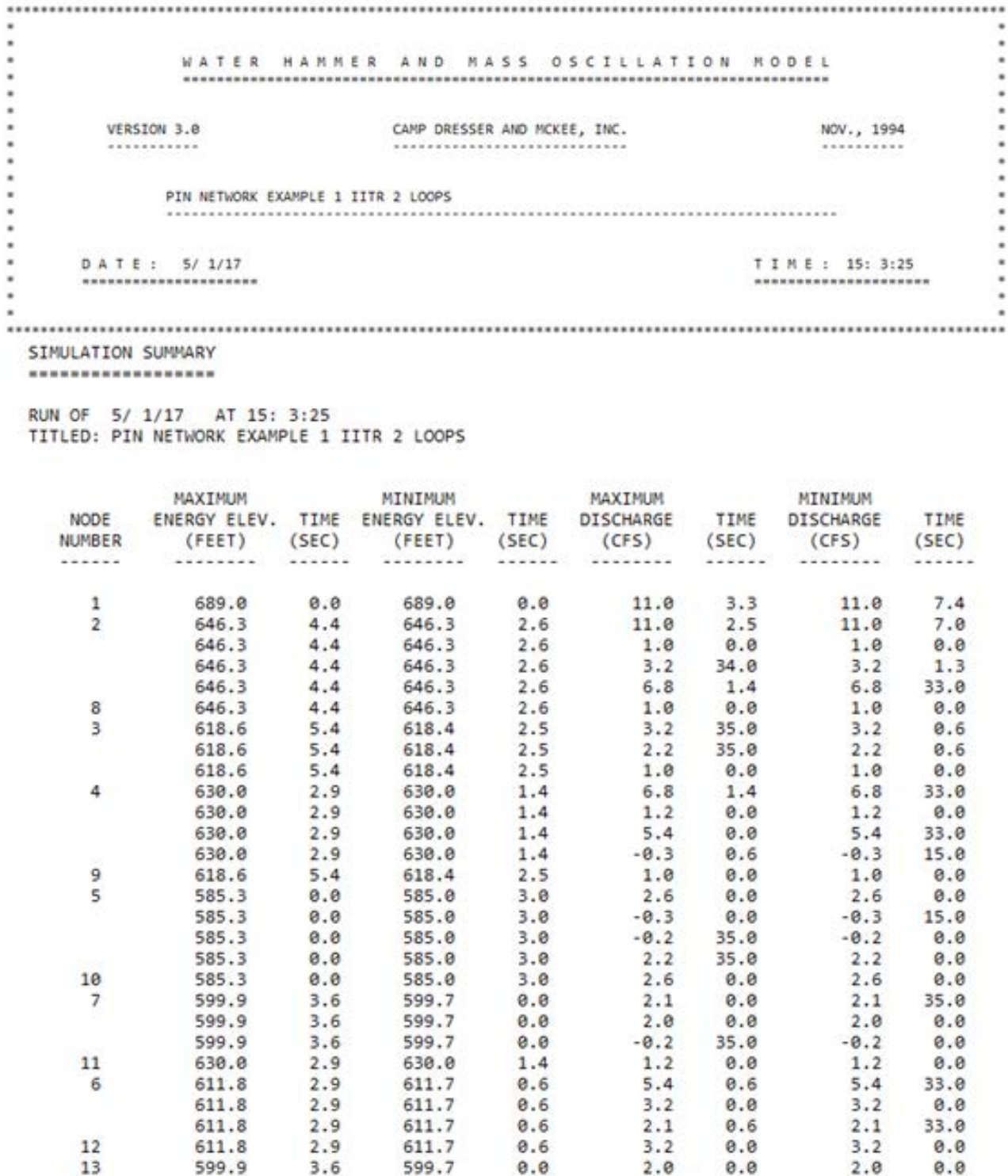

Figure 5.19 Output of WHAMO simulations

## 5.12 Structural Design of Buried Pipelines

Pipe materials are generally considered to be rigid or flexible. A flexible pipe is one that will deflect at least 2 percent without structural distress. Metallic and thermoplastic pipes are considered flexible whose design procedure is summarised as below.

### 5.12.1 Design of Metallic Pipes

#### 1. Determination of design pressure

Since piped irrigation comes under pressurised liquid flows, pipeline containing flowing liquid is periodically subjected two modes of hydrostatic stress: sustained stress from Working Pressure (internal pressure) and transient stress from sudden water velocity changes. The pipe shall be designed to handle both. The working pressures at critical locations (points of slope variation, change in dimensions etc.) in the layout needs to be checked and the higher value has to be adopted for design purpose. Design pressure,  $D_p$  shall be maximum of

- i. Working pressure+surge pressure(if any);
- ii. 1.5 x working pressure;

Surge pressure may be determined by finite element method using any of the reputed water hammer software, some of the softwares are listed below:

- i. Hyrtran
- ii. Hammer (Bentley)
- iii. WHAMO

#### 2. Determination of wall thickness :

Wall thickness to be used for the pipe ( $t_f$ ) shall be maximum of :

- i. Wall thickness required to resist the design pressure shall be calculated as per the following hoop stress formula:

$$t = \frac{D_p \cdot OD}{(2 \cdot DF \cdot W_e \cdot T_s + D_p)}$$

Where,

- $D_p$  = design pressure in  $\text{kg/cm}^2$ ;  
 DF = design factor based on factor of safety (0.6 for working pressure and 0.9 for test pressure inclusive of surge pressure);

$W_e$  = welding efficiency (1.0 – ductile iron pipes, 0.9 – steel pipes);

$T_s$  = specified minimum yield stress in  $\text{kg/cm}^2$ ;

$t$  = calculated wall thickness in cm;

- ii. Nominal thickness as per the relevant standard (refer the standards like IS 3589/2001 for steel pipes, IS 8329/2000 for ductile iron pipes etc as per requirement)
- iii. Notwithstanding the thickness obtained as specified above and regardless of pressure, a minimum thickness of liner shall be provided to resist the distortion during fabrication and erection. A minimum thickness (cm) of  $\frac{D+50}{400}$  is recommended where D is the nominal diameter in cm

#### 3. Check for deflection

Pipe is subjected to external loads i.e. soil pressure and live load pressure, when laid below ground. Under this pressure, the pipe will deflect due to the external loads, which will be resisted by the pipe stiffness and soil stiffness. The deflection of the pipe calculated should be within the limits.

##### 3.1 Estimation of total external loads ( $q$ ) on the pipe

- (a) External load due to soil,  $q_s$

$$q_s = \gamma_s \cdot H$$

Where

$\gamma_s$  = unit weight of soil,  $\text{kg/cm}^3$ ;

$H$  = height of ground surface above crown of pipe (depth of cover), cm;

- (b) Live load,  $q_l$

In order to calculate the live load, in terms of pressure at pipe crown, we first need to calculate the wheel load,  $W_l$  :

**Case 1** : When  $(OD - t_{nom}) < (2.67H)$ ,  $H \leq 61$  cm

$$W_l = \left[ \frac{P_l \cdot I_f \cdot (OD - t_{nom})^2}{2.67H^3} \right] \times \left[ \frac{2.67 \cdot H}{(OD - t_{nom})} - 0.5 \right]$$

$$q_l = \frac{W_l}{OD}$$

**Case 2** : When  $(OD - t_{nom}) \geq (2.67H)$ ,  $H \leq 61$  cm

$$W_l = \frac{1.33P_l \cdot I_f}{H}$$

$$q_l = \frac{W_l}{OD}$$

Case 3 : When  $H \geq 61 \text{ cm}$

$$q_l = \frac{P_l}{(1.75H)^2}$$

Where,

- $P_l$  = Wheel load at surface in kg;
- $I_f$  = impact factor (Table 5.4);
- $OD$  = outside diameter of pipe in cm;
- $t_{nom}$  = nominal wall thickness of pipe in cm;
- $H$  = depth of cover in cm;
- $q_l$  = vertical pressure at pipe crown due to live load,  $\text{kg}/\text{cm}^2$ ;

(c) Total external load,  $q = q_s + q_l$

Table 5.5 Values of Impact factor

Depth of Cover	Impact Factor, $I_f$
<30cm	1.3
>30cm and <61cm	1.2
>61cm and <91cm	1.1
>91cm	1

### 3.2 Estimation of deflection

Deflection of the pipe is estimated as below

$$\text{Deflection} = \frac{\text{External Load Pressure}}{\text{Pipe Stiffness} + \text{Soil Stiffness}}$$

Or

$$\Delta_x = \left[ \frac{K_x \cdot q}{8.S + 0.061E'} \right] \cdot 100$$

Where,

- $\Delta_x$  = ring deflection in pipe in percentage of external diameter (%);
- $K_x$  = deflection coefficient depending upon bedding reaction angle (Table 5.5);
- $q$  = vertical pressure at pipe crown due to all external loads, in  $\text{kg}/\text{cm}^2$ ;
- $S$  = diametral stiffness of pipe in  $\text{kg}/\text{cm}^2 = \frac{E.I}{(D_m)^3}$
- $E$  = modulus of elasticity of pipe wall material in  $\text{kg}/\text{cm}^2$

$I$  = moment of inertia of pipe wall in  $\text{cm}^3 = \frac{(t_{nom}^3)}{12}$ ;

$D_m$  = mean diameter of pipe =  $(OD - t_{nom})$  in cm;

$t_{nom}$  = nominal wall thickness of pipe in cm;

$E'$  = modulus of soil reaction,  $\text{kg}/\text{cm}^2$ ;

$q$  = is the vertical pressure at pipe crown due to all external loads,  $\text{kg}/\text{cm}^2$ ;

Now,  $q = q_s + q_l$

$$q_s = \gamma_s \cdot H$$

where

$\gamma_s$  = unit weight of soil,  $\text{kg}/\text{cm}^3$ ;

$H$  = height of ground surface above crown of pipe ( depth of cover), cm;

Table 5.6 Values of deflection coefficient

Bedding reaction angle	Deflection coefficient, $K_x$
$30^0$	0.108
$45^0$	0.105
$60^0$	0.102
$90^0$	0.096
$150^0$	0.085

After, we have calculated  $q_s$ ,  $q_l$  and  $q$ , we can calculate the deflection,  $\Delta_x$  in %;

This deflection should not be more than :

For bare steel pipe/ ductile pipe = 5 %;

For epoxy lined steel and ductile pipe = 5 %;

For cement mortar lined steel and ductile pipe = 2 %;

In case, the calculated value of  $\Delta_x$  is more than the allowable limit, we need to increase the wall thickness of pipe or class of pipe, as applicable to bring down the deflection within the limits. Table 5.6 gives the range of deflections for MS pipes for various burial depths.

In other words, the allowable depth of cover, H for a pipe can be calculated depending upon the pipe stiffness, soil stiffness, external loads and the allowable ring deflection in pipe based on inside lining. Once pipe of a material and size is chosen

calculations shown above may be applied to calculate the allowable depth of soil cover, H over the pipe.

**Table 5.7 MS Pipe Deflection for Specified Burial Depth**

DN (mm)	MS Pipe Thickness (mm)	Soil Depth (m)	Design Modulus of Soil Reaction E'					Deflection, %				
			Soil Type					Soil Type				
			Fine Grained Soil with medium to high plasticity	Fine Grained, Soil with medium to no plasticity, less than 25% coarse grained particles	Fine Grained, Soil with medium to no plasticity, more than 25% coarse grained particles	Coarse Grained Soil	Crushed rock	Fine Grained, Soil with medium to high plasticity	Fine Grained, Soil with medium to no plasticity, less than 25% coarse grained particles	Fine Grained, Soil with medium to no plasticity, more than 25% coarse grained particles	Coarse Grained Soil	Crushed rock
<b>As per WRD - MP</b>												
<b>300</b>	4	1.5	100	200	400	1000	3000	1.6%	1.5%	1.2%	0.8%	0.4%
<b>350</b>	4	1.5	100	200	400	1000	3000	2.7%	2.3%	1.8%	1.1%	0.5%
<b>400</b>	4	1.5	100	200	400	1000	3000	4.1%	3.3%	2.4%	1.3%	0.5%
<b>450</b>	4	1.5	100	200	400	1000	3000	5.8%	4.5%	3.0%	1.6%	0.6%
<b>500</b>	4	1.5	100	200	400	1000	3000	7.8%	5.7%	3.7%	1.8%	0.7%
<b>600</b>	4	1.5	100	200	400	1000	3000	12.2%	8.1%	4.9%	2.2%	0.8%
<b>700</b>	6	1.5	100	200	400	1000	3000	9.0%	6.7%	4.5%	2.3%	0.9%
<b>800</b>	6	1.5	100	200	400	1000	3000	12.9%	9.1%	5.7%	2.7%	1.0%
<b>900</b>	6	1.5	100	200	400	1000	3000	17.3%	11.5%	6.8%	3.1%	1.1%
<b>1000</b>	6	1.5	100	200	400	1000	3000	21.9%	13.8%	7.9%	3.5%	1.2%

**4. Check for Buckling**

Steel pipe embedded in soil may buckle because of excessive loads and deformations. The total permanent pressure must be less than the allowable buckling pressure

Allowable buckling pressure :

$$q_{ab} = \left(\frac{1}{FS}\right) * \left[32R_w \cdot B' \cdot E' \cdot \frac{E \cdot I_{pw}}{(OD)^3}\right]^{1/2}$$

Where,

- $q_{ab}$  = allowable buckling pressure, in kg/cm<sup>2</sup>;
- $FS$  = design factor of safety ( 2.5 for H/OD > 2; 3.0 for H/OD < 2)
- $R_w$  = water buoyancy factor  $(1 - 0.33 \cdot (\frac{H_w}{H}))$

$H$  = height of ground surface above top of pipe in cm;

$H_w$  = height of water above top of pipe in cm;

$B'$  = empirical coefficient of elastic support;

$$= \frac{1}{1 + 4e^{(-0.0021 \cdot H)}}$$

$E'$  = modulus of soil reaction, kg/cm<sup>2</sup>;

$E$  = modulus of elasticity of steel, kg/cm<sup>2</sup>;

$I_{pw}$  = transverse moment of inertia, cm<sup>4</sup>/cm =  $\frac{(t_{nom})^3}{12}$

$OD$  = outside diameter of pipe in cm;

The permanent pressure consisting of soil pressure, hydrostatic pressure and vacuum pressure, if any

should be lower than the allowable buckling pressure of pipe.

*If the adopted thickness is insufficient as per buckling or deflection requirements, redesign on an iterative manner till the requirement is met.*

**5.12.2 Design of Thermoplastic Pipes (Plastic or PE pipes)**

**1. Determination of design pressure (D<sub>p</sub>)**

Design pressure shall be determined as per the clause 1 of 5.12.1 explained above.

**2. Determination of pressure rating of pipes (PC)**

The pressure rating (PR) (also referred as pressure class (PC) in some reference) is used in various consensus standards from ASTM, AWWA, CSA and others to denote the pipe’s capacity for safely resisting sustained pressure, and typically is inclusive of the capacity to resist momentary pressure that increases from pressure surges such as from sudden changes in water flow velocity. PC is the estimated maximum pressure that the medium in the pipe can exert continuously with a high degree of certainty that failure of the pipe will not occur. PC is defined for a chosen pipe material of certain specifications and these details are provided by the manufacturers.

From the available pressures classes of plastic / PE pipes, a suitable class shall be selected in such a way that  $PC > D_p$ ;

**NOTE:**

*The non metallic pipe selection can be made based on the pressure rating and manufacturer specifications. However, if necessary, the following checks may be carried out to ensure the structural stability depending upon the site and loading conditions.*

**1. Check for wall crushing**

Total external pressure on pipe,  $q = q_s + q_l + q_v$

Where,

$q$  = total pressure on pipe, in

- $q_s$  = pressure due to weight of soil, in  $\text{kg/cm}^2$ ;  
=  $\gamma_s \cdot H$
- $H$  = depth of soil; in cm
- $\gamma_s$  = unit weight of soil, in  $\text{kg/cm}^2$ ;
- $q_l$  = pressure on pipe due to wheel load, in  $\text{kg/cm}^2$ ;
- $q_v$  = internal vacuum pressure, in  $\text{kg/cm}^2$  (Pipe is subjected to an effective external pressure because of an internal vacuum pressure as a result of sudden valve closure, shutoff from a pump, or drainage from high points within the system often create a vacuum in the pipelines)

Thrust in pipe wall,  $T_{pw} = \frac{q \cdot OD}{2}$

The required cross – sectional area will be

$$A_{pw} = \frac{T_{pw}}{\sigma}$$

The area of a solid-wall pipe per unit length or thickness may be computed as

$$t = \frac{(OD - ID)}{2} = A_{pw}$$

where

- $A_{pw}$  = required wall area, in  $\text{cm}^2/\text{cm}$ ;
- $T_{pw}$  = thrust in pipe wall, in  $\text{kg/cm}$ ;
- $\sigma$  = allowable long term compressive stress, in  $\text{kg/cm}^2$ ;
- $OD$  = outside diameter of pipe in cm;
- $ID$  = inside diameter of pipe in cm;

The average area (thickness) of pipe wall for corrugated and profile wall pipe should be obtained from the manufacturer.

**2. Check for deflection**

Deflection of the pipe has to be checked due to external loads, which shall be within the allowable limits. :

$$\Delta_x = \left[ \frac{K_x \cdot q}{S' + 0.061E'} \right] \cdot 100$$

Where,

- $\Delta_x$  = deflection of pipe in %;
- $K_x$  = deflection coefficient based on

bedding reaction angle, as defined in section 5.12.1

$q$  = is the vertical pressure at pipe crown due to all external loads, =  $\text{kg}/\text{cm}^2$ ;  
 $q'_s + q_l + q_v$

$q'_s$  = pressure on pipe from soil in  $\text{kg}/\text{cm}^2 = D_l \cdot \gamma_s \cdot H$

$D_l$  = deflection lag factor (1.0 to 1.5);

$\gamma_s$  = unit weight of soil,  $\text{kg}/\text{cm}^3$ ;

$H$  = height of ground surface above crown of pipe (depth of cover), cm;

$q_l$  = pressure on pipe from live load in  $\text{kg}/\text{cm}^2$ , as defined above

$q_v$  = pressure on pipe from vacuum pressure in  $\text{kg}/\text{cm}^2$ ;

$S'$  = pipe stiffness in  $\text{kg}/\text{cm}^2$ , =  $\frac{2.E}{3.(SDR-1)^3}$ ;

$E$  = modulus of elasticity of pipe material, in  $\text{kg}/\text{cm}^2$

$SDR$  = standard dimension ratio =  $\frac{OD}{t_{min}}$ ;

$E'$  = modulus of soil reaction,  $\text{kg}/\text{cm}^2$

The allowable deflection in the plastic pipes is limited to **7.5 %**. Therefore the calculated  $\Delta_x$ (%), shall be below 7.5.

### 3. Check for wall buckling

Plastic pipes, embedded in soil may buckle because of excessive loads and deformations.

The allowable buckling pressure can be calculated as below :

$$q_{ab} = \left(\frac{1}{FS}\right) * \left[32R_w \cdot B' \cdot E' \cdot \frac{E_{long} \cdot I_{pw}}{(OD)^3}\right]^{1/2}$$

Where,

$q_{ab}$  = allowable buckling pressure, in  $\text{kg}/\text{cm}^2$ ;

$FS$  = design factor of safety (2.5 for  $H/OD > 2$ ; 3.0 for  $H/OD < 2$ )

$R_w$  = water buoyancy factor =  $(1 - 0.33 \cdot (\frac{H_w}{H}))$

$H$  = height of ground surface above top of pipe in cm;

$H_w$  = height of water above top of pipe in cm;

$B'$  = empirical coefficient of elastic support =  $\frac{0.0043[H^2 + (OD \cdot H)]}{0.0016[2 \cdot H + OD]^2}$

$E'$  = modulus of soil reaction,  $\text{kg}/\text{cm}^2$ ;

$E_{long}$  = modulus of elasticity of pipe material, long term modulus of soil reaction (long term modulus of elasticity is recommended if the pipe is subject to the pressure in normal operations. If pipe is subject to pressure for short time periods and infrequently the use of short term modulus of elasticity is acceptable),  $\text{kg}/\text{cm}^2$ ;

$I_{pw}$  = transverse moment of inertia,  $\text{cm}^4/\text{cm} = \frac{(t_{nom})^3}{12}$

$OD$  = outside diameter of pipe in cm;

Allowable buckling pressure shall be reduced in case of plastic pipes by a factor called reduction factor,  $C$  given by

$$C = \left[\frac{(1 - \Delta_x)^3}{(1 + \Delta_x)^2}\right]$$

Where,

$\Delta_x$  = percent deflection, in %;

$C$  = reduction factor;

The permanent pressure consisting of soil pressure, hydrostatic pressure and vacuum pressure, if any should be lower than the allowable buckling pressure of pipe.

*If the adopted thickness is insufficient as per buckling or deflection requirements, redesign on an iterative manner till the requirement is met.*





## CHAPTER - 6

# INTAKE AND DESILTING ARRANGEMENTS

### 6.1 General

Intake is a device or structure placed in a surface water source to permit the withdrawal of water from the source. They are used to draw water from canals, lakes, reservoirs or rivers in which there is wide fluctuation in water level or when it is proposed to draw water at most desirable depth.

An irrigation intake is provided to allow water into a open channel or tunnel or closed conduit under controlled conditions. The intake design shall be such as to:

a) give minimum hydraulic losses,

- b) provide smooth entry into the water conveyer system, and
- c) Prevent/minimize ice, floating trash and coarse sediment entering the tunnel, channel or pipe.

#### 6.1.1 Types of Intakes

- a) Wet Intakes
- b) Dry Intakes
- c) Submerged Intakes
- d) Moveable and floating Intakes

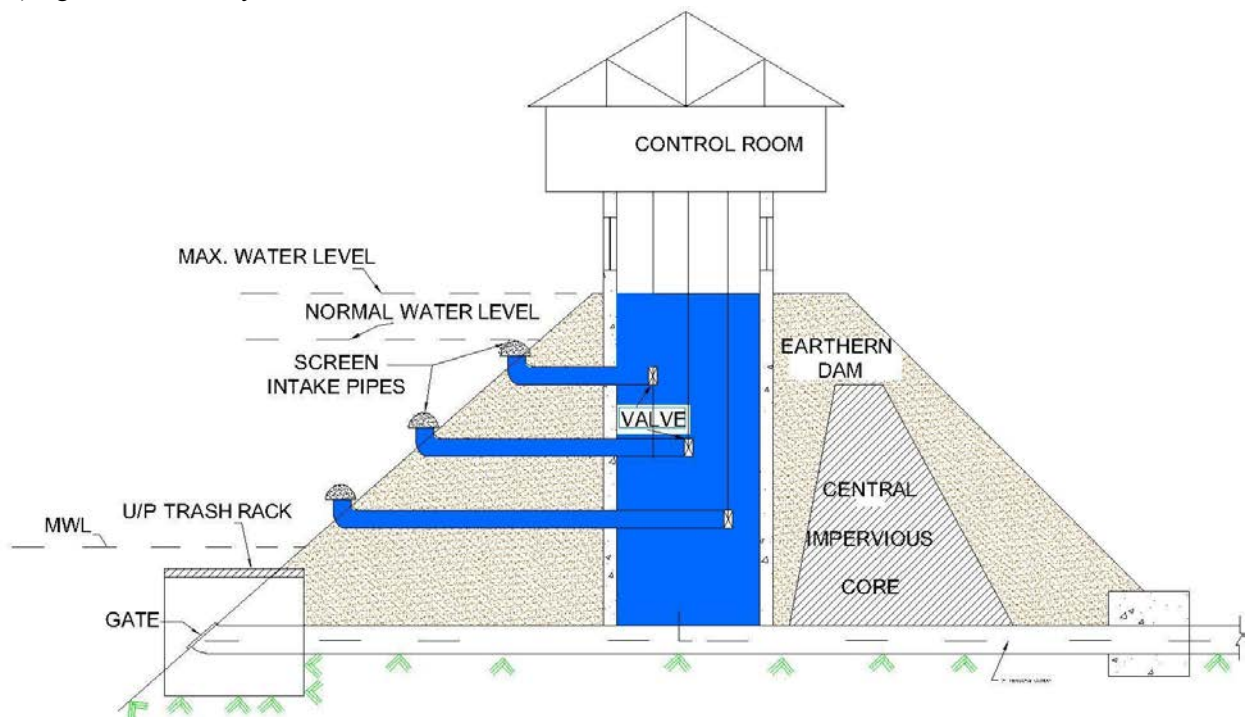

Figure 6.1 Valve tower situated within an earthen dam

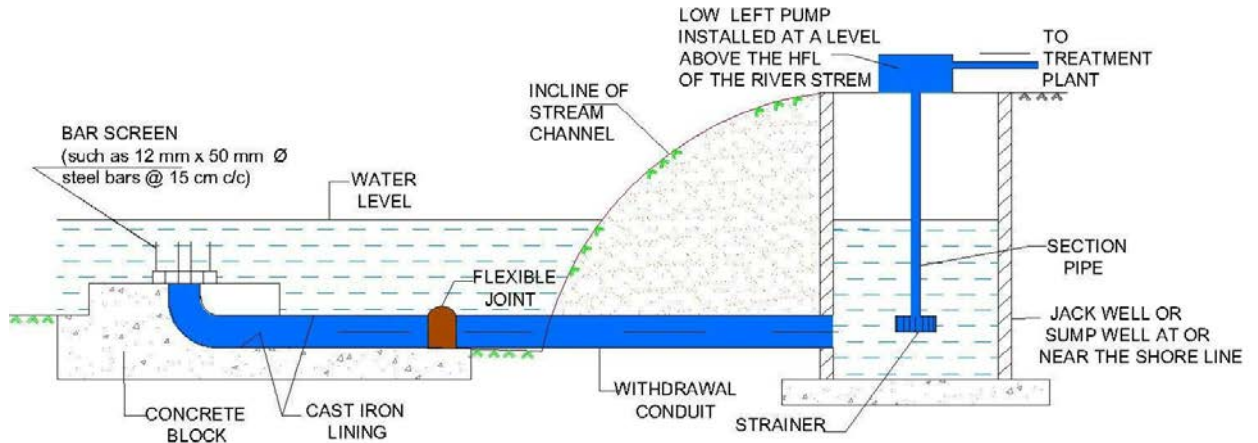

Figure 6.2 Simple Concrete block-Submerged Intake

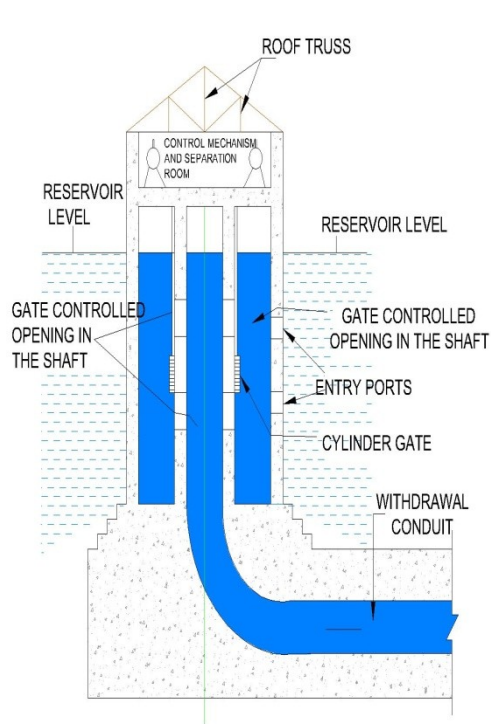

Figure 6.3 Wet Intake tower standing in the river or reservoir

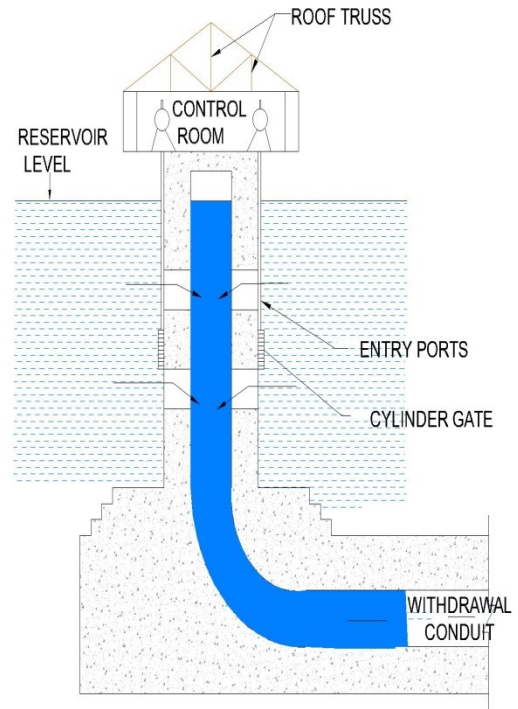

Figure 6.4 Dry Intake tower standing in the river or reservoir

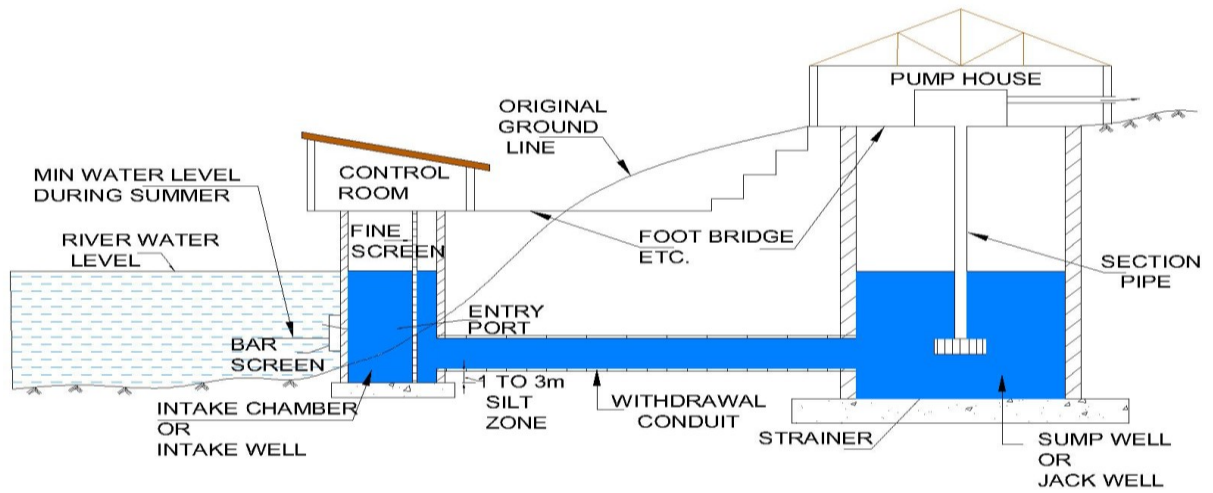

Figure 6.5 Section of a typical twin well type of river intake

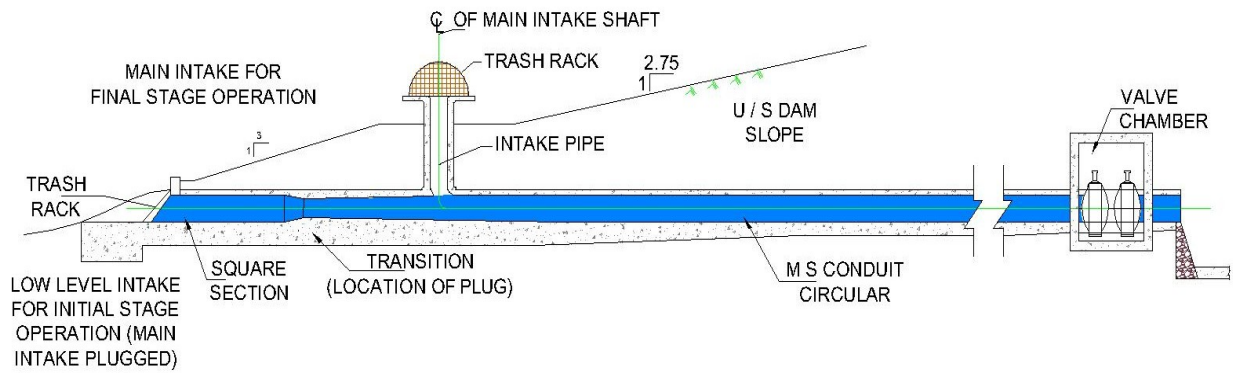

Figure 6.6 Typical Installation in an Earth dam-sloping Intake (Ref: IS: 11570- 1985)

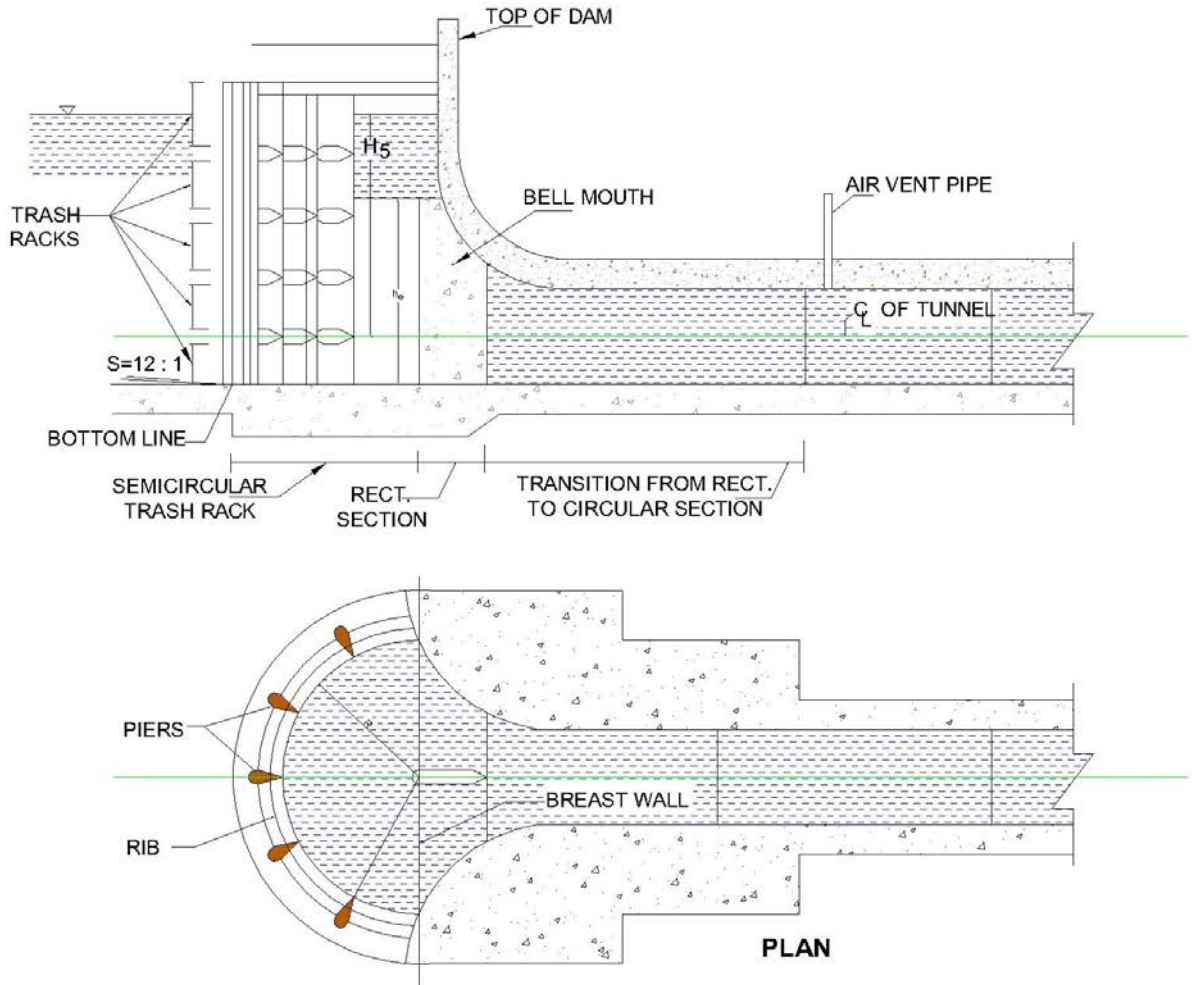

Figure 6.7 Approach Geometry- Semicircular Type Intake Structure (Ref: IS: 11570- 1985)

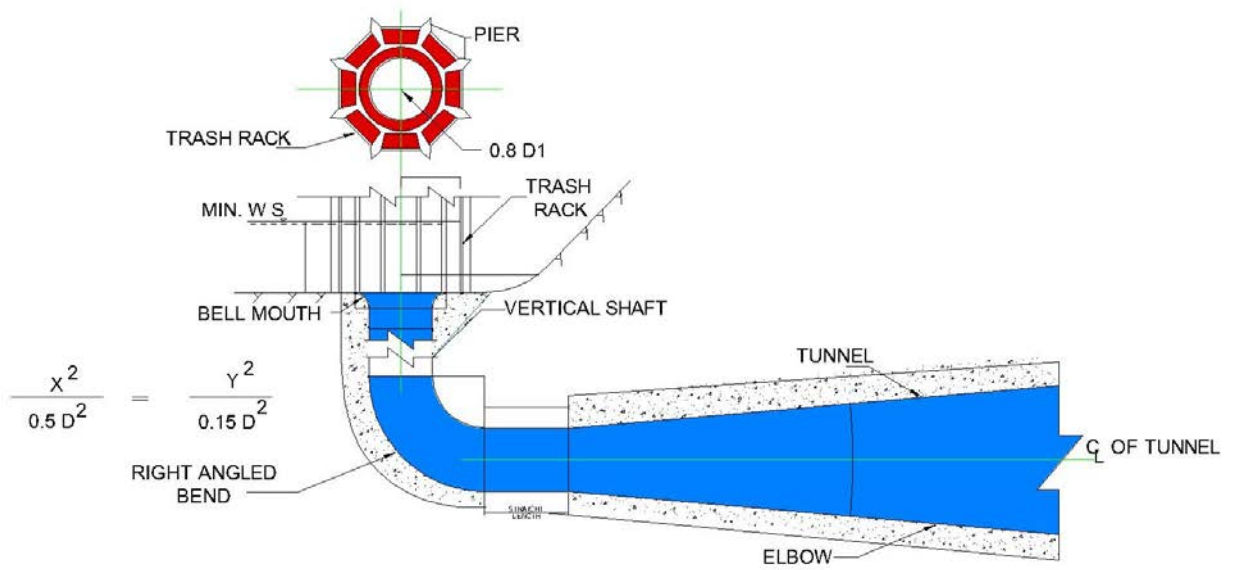

Figure 6.8 Typical Installation in an Earth dam-Tower Type Intake (Ref: IS: 11570- 1985)

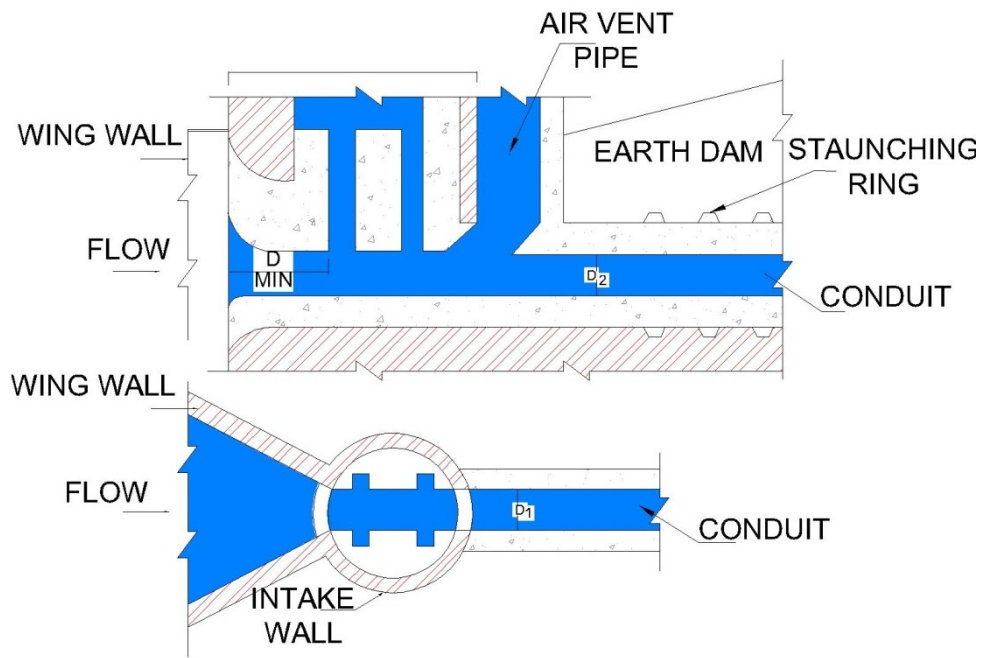

Figure 6.9 Typical Installation in an Earth dam-Tower Type Intake (Type II) (Ref: IS: 11570- 1985)

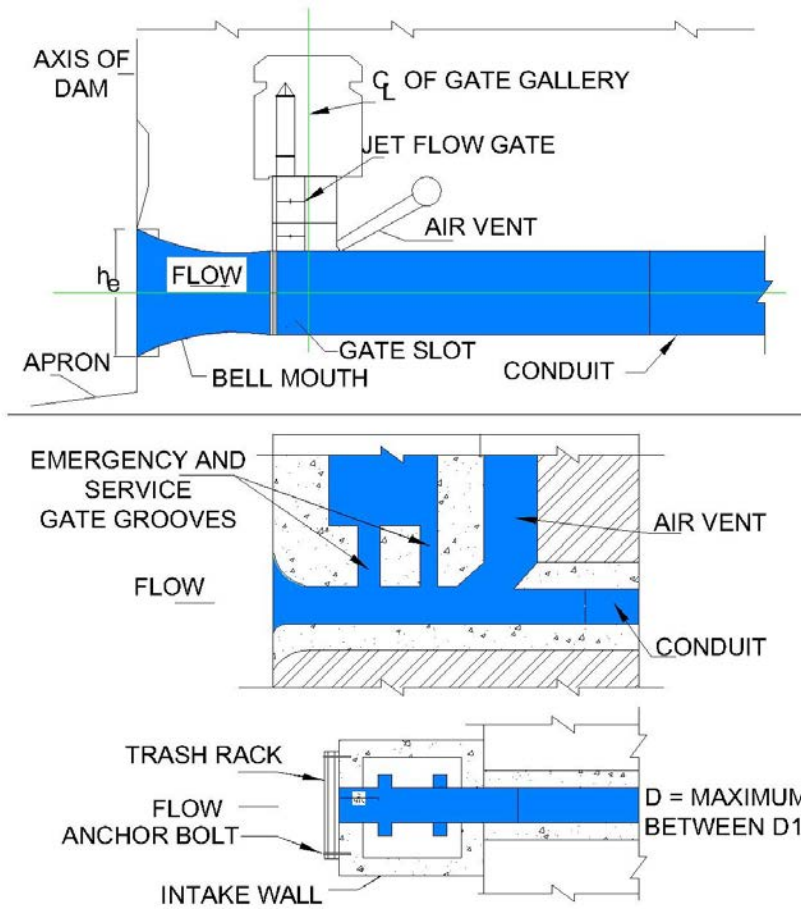

Figure 6.10 Typical Installation in a Concrete/Masonry dams (Ref: IS: 11570- 1985)

### 6.1.2 Intake in concrete or masonry dams

In the case of concrete or masonry dams irrigation intake structure can be located either at the toe when operating head is low or in the body of the dam itself when operating head is medium or high. Typical layouts are shown in Fig.6.6 & 6.7

### 6.1.3 Layout of Intake Structure

Main components of an irrigation intake structure are listed below:

- a) Trash rack and supporting structures;
- b) Anti-vortex devices;
- c) Bell-mouth entrance with transition and rectangular to circular opening; and
- d) Gate slot enclosures with air vents.

For design of intake structure, IS: 11570-1985 shall be followed.

### 6.1.4 Location

As per IS: 11570-1985, the following factors shall be considered while determining the appropriate location of Intake:

- a) The location where the best quality of water(at least suitable for irrigation purposes) is available
- b) Absence of currents that will threaten the safety of the intake
- c) Absence of ice floats etc.
- d) Formation of shoal and bars should be avoided
- e) Navigation channels should be avoided as far as possible
- f) Fetch of wind and other conditions affecting the waves
- g) Ice Storms
- h) Floods
- i) Availability of power and its reliability
- j) Accessibility
- k) Distance from pumping station
- l) Possibilities of damage by moving objects and hazards.

## 6.2 Desilting Arrangements

### 6.2.1 Necessity of desilting

Although sediment containing water is good for crops, it may affect the distribution system by

clogging. Depending upon the sediment concentration in the water, the necessity of desilting basin needs to be studied in detail.

The water which is directly diverted from the river system contains sediments. This sediments may block or reduce the capacity of the distribution system thereby it affects the efficiency of the whole system. However, the sediment water may be desirable for crops but it may affect the whole system. Hence, it has to be removed to some extent considering its impact on the whole system. The source of supply of water helps in finding the requirement of desilting chambers as detailed below :

- a) If the water is drawn from reservoir/Lake then the desilting arrangement may not be required as the reservoir/lake act as a desilting basin.
- b) In addition, in case of canals, the silt ejector/silt excluder shall be provided at the canal intake, hence the desilting chamber may not be required in Piped Irrigation Network if the water is drawn from main canal.
- c) However, if the water is directly drawn from the river then the requirement of desilting chamber /settling basins should be assessed in detail.

### 6.2.2 Tube Settlers

Conventional systems like settling basins are quite effective to reduce the sediment content in the whole system. Moreover, conventional system with tube settler are having more efficiency in the controlling the sediment rate. Hence, the tube settlers have been discussed in detail. Settling efficiency of a basin is primarily dependent upon surface area and is independent of depth. Attempts have been made to use this concept to achieve better efficiency and economy in space as well as cost. Wide shallow trays inserted within conventional basins with a view to increase the surface area have not met with success. However, very small diameter tubes having a large wetted perimeter relative to wetted area providing laminar flow conditions and low surface loading rate have shown good promise. Such tube settling devices provide excellent clarification with detention time of equal to or less than 10 minutes.



Figure 6.11 Water is drawn from Canal Intake through Syphonic action in Balh Valley Medium Irrigation Project in HP

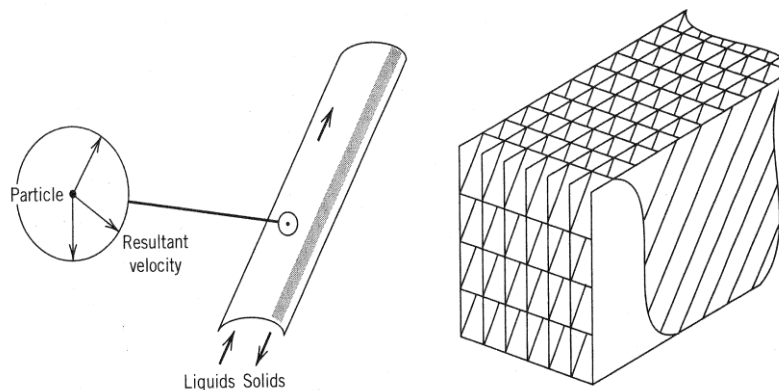

Figure 6.12 Tube Settler

### PRINCIPLE OF TUBE SETTLERS

*Tube settlers or inclined plate settlers are examples of high rate settlers. Here what we are doing is we are providing excess surface so that the surface overflow rate will be decreased. We have sedimentation tank like this say some 3.5 meters depth so if you provide many plates parallelly in the settling zone so what will happen is the effective surface area will be increasing because many surfaces are available for the settling or many planes are available for settling. So, effectively what will happen is it will be considerably reducing the surface overflow rate or in other words it will be increasing the efficiency of the tank. That is the principle of these tube settlers.*

Tube configurations can be horizontal or steeply inclined. In inclined tubes (about 60 degree) continuous gravity drainage of the settleable material can be achieved. At angle greater than 40

degree the units lose efficiency rapidly whereas with angles less than 60 degree, sludge will not slide down the floors. Under such situations, hosing down the sediments may have to be resorted to. With horizontal tubes (normally inclined at 5 degree) auxiliary scouring of settled solids is necessary. While tube-settlers have been used for improving the performance of existing basins, they have also been successfully used in a number of installations as a sole settling unit. It has been found that if one fifth of the outlet end of a basin is covered with tube or plate settlers, the effective surface loading on the tank is nearly halved or the flow through the basin can be nearly doubled without impairment of effluent quality.

Here the design is based upon the surface overflow rate so here we are providing many tube or inclined plates at an angle of 45 to 60 degree above the horizontal. Why we are providing this 45 to 60 degree angle is because the particles will

be settling on the plates or the tubes so if you provide an angle 45 to 60 degree then whatever the particle that is settled on the tubes or the plates will be sliding back to the system with the self weight so cleaning will be very easy.

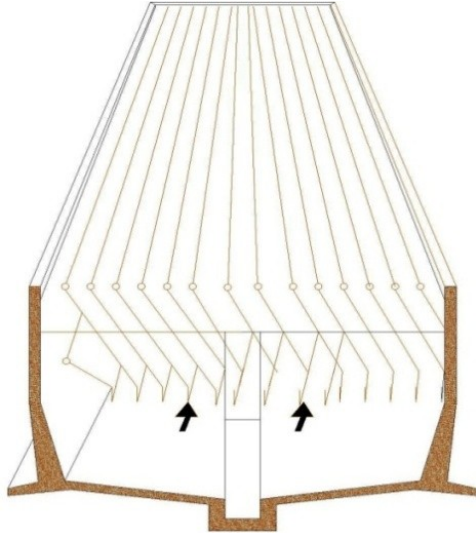

Figure 6.13 Lamella clarifier

The tubes may be square, circular, hexagonal, diamond shaped, triangular, and rectangular or chevron shaped. A widely used material for their construction is thin plastic sheet (1.5mm) black in color, though plastic and asbestos cement pipes have also been used. There are number of proprietary devices such as Lamella clarifier. *This tube settler system has been proposed in the Medium Irrigation Project in Hamirpur district in Himachal Pradesh.*

**6.2.3 Analysis of Tube Settlers**

The performance of the tube settles is normally evaluated by parameter, S, defined as

$$S = \frac{V_s}{V_o} (\sin \theta + L \cos \theta)$$

Where,

- $V_s$  = Settling velocity of the particle in vertically downward direction (L/T)
- $V_o$  = Velocity of flow along the tube settler
- $\theta$  = Angle of inclination of tube settlers, degrees.

- L = Relative length of settler = I/d dimensionless
- I, d = Length and diameter (width) of the tube settlers, (L)

If the value S equals or exceeds a critical value, S for any particle, it is completely removed in the tube settlers under ideal conditions. For laminar flow regime in tube settlers, the value of S have been determined as 4/3, 11/8 and 1 for circular, square and parallel plates type of tube settlers assuring uniform flow. It is found that the performance of tube settlers is improved significantly with L values of up to 20 and insignificantly beyond 20. Therefore, it is desirable to design tube settlers, beyond 40 degree, results in deterioration in their performance. Essentially horizontal tube settlers perform better than steeply inclined tube settlers. It is opined that from relative economics point of view, the order of preference for tube settlers is parallel plates followed by circular tubes and square conduits.

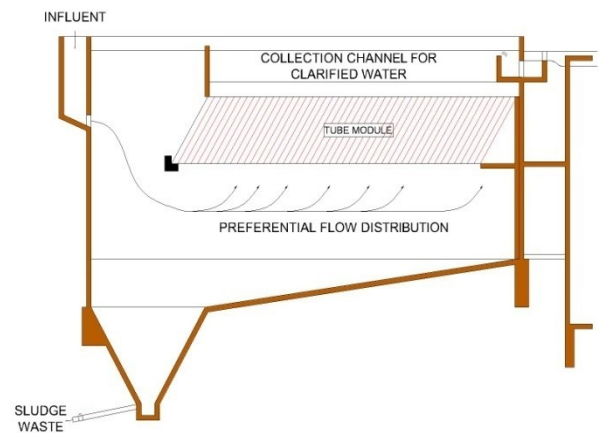

Figure 6.14 Flow distribution from a conventional inlet in a tube settler

It is recommended to increase the dimensionless L of tube settlers by an additional amount L' to account for transition zone near inlet to change to fully developed laminar flow

$$L' = 0.058 \frac{v_o d}{\vartheta}$$

Where  $\vartheta$  is the kinematic viscosity of water



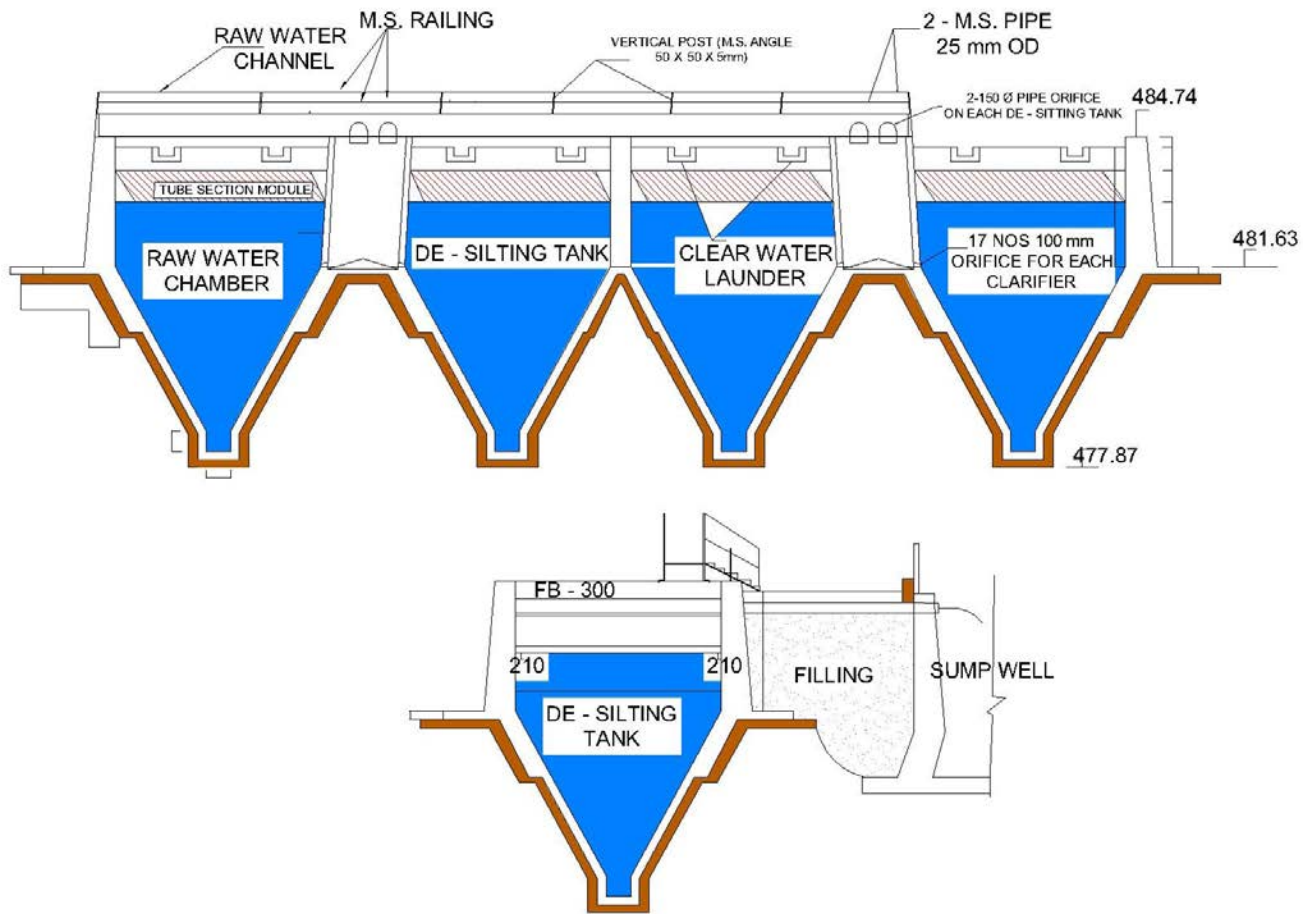

Figure 6.15 Tube settler type desilting arrangement in Nadaun Medium Irrigation Project, HP.



Figure 6.16 Aerial View of Tube settler type desilting arrangement provided in **Balh Valley Medium Irrigation Project, HP**

### 6.3 Diggy

It is manmade structure which is constructed at the each outlet to provide a source of water to micro irrigation. The capacity of Diggy is

normally adopted to store water upto 4 hours of water supply. The water shall be supplied from diggy to outlet.

Table 6.1 Design of Tube Settlers

The following example illustrates the design for tube settlers

**Problem Statement :** Design tube settler module of square cross section with following data

Average output required from tube settler	= 250 m <sup>3</sup> /hr
Loss of water in desludging	= 2% of output required
Average design flow = (250 × 100)/(100 – 2)	= 255.1 m <sup>3</sup> /hr
Cross section of square tubes	= 50 mm x 50 mm
Length of tubes	= 1m
Angle of inclination of tubes	= 60°

**Design Steps:**

Estimation of effective length of tube

Compute relative length of settler, $L_R$	= $\frac{1000}{50} = 20$
Effective relative length of tube, L	= $L_R - 0.058N_R$
	= $L_R - 0.058 \times V_o d / \vartheta$
	= $20 - (0.058 \times V_o \times 0.05) / 1.01 \times 10^{-6} \times 86400$
	= $20 - 0.033V_o$

Where  $V_o$  is flow through velocity for tube settler in m/d

Determine Flow Velocity through Tubes:

$$S = V_{sc} / V_o \times (\sin \theta + L \cos \theta)$$

$$11/8 = 120 / V_o \times (\sin 60 + (20 - 0.033V_o) \cos \theta)$$

$$V_o = 388.65 \text{ m/d}$$

Compute Total Tube Entrance Area and No. of Tubes:

Tube entrance area, $Q/A$	= $255.1 \times 24 / 388.65 = 15.75 \text{ m}^2$
No .of tubes required	= $15.75 / (0.05 \times 0.05) = 6300$
Provide 6400 square tubes of 0.05m × 0.05 m with 80 tubes along the length of the square module and 80 tubes along the width of the module	
Length of the tube module	= No. of tubes × (inside dimension of square tubes + 2× thickness of tubes)
	= $80 \times (0.050 + 2 \times 0.005) \text{ m}$
	= 4.24 m
Height of tube module for 1m length of square tubes inclined at an angle of 60°	
= $1 \sin 60^\circ = 0.866 \text{ m}$ say 0.87m	
Therefore overall dimension of tube module	= 4.24m × 4.24m × 0.87m
Size of individual square tubes	= 0.05m × 0.05m
Thickness of individual square tubes	= 1.5mm



## CHAPTER - 7

# DESIGN OF PUMPS

### 7.1 General

Pumps are devices used to transfer water from a point to another with pressure to overcome the resistance along its path. It is important to understand the different types of pumps, their applications, design differences and procedures used to operate and maintain them.

In case of pressurized irrigation system, pumping machinery serves purposes as below:

- a) To transport water from low to high elevated area for distribution purposes.
- b) To attain the uniform pressure in the distribution network.

While deciding the type of pump for the specific requirement, *it is necessary to analysis different type of pumps and their suitability to meet the requirement.*

### 7.2 Types of Pumps

The type of pump may be decided based on the available sources of energy like solar energy, electrical power, diesel energy etc. *In areas where abundant solar energy is available, then solar powered pumps may be preferred.*

### 7.3 Consideration in Pump Selection

#### 7.3.1 Total Dynamic Head

In order to accurately predict the performance of a pump in a specific application, the total head losses must be considered. These losses include, but are not limited to:

- a) Total static head;
- b) Losses due to pipe size, length, and material;
- c) Losses due to pipe appurtenances.

Accurately predicting the discharge and pressure for a given pump in a specific application requires

tedious calculations as well as patient trial and error.

#### 7.3.2 Friction Losses in Conduits

When water moves through a closed conduit, the flow creates heat due to friction of the two surfaces (water against conduit). A steel pipe will produce more friction than will any plastic pipe. Friction increases with the increased length of pipe or hose, and also with a decreased diameter of pipe or hose. Increased friction slows down the water, effectively decreasing the discharge capacity and actual discharge of a given pipe.

#### 7.3.3 Suction Head

Atmospheric pressure at sea level limits the suction head of centrifugal pumps to 10.3 m. However, this head would only be obtained if a perfect vacuum could be created in the pump. In reality, the suction head of centrifugal pumps is limited to about 7.9 m. Pump performance (capacity or pressure) is highest when the pump is operated close to the water's surface.

Increasing the suction head will decrease the discharge head and consequently the discharge capacity of the pump. *Very importantly, suction head should be kept to the smallest value possible to reduce the likelihood of cavitation.* Cavitation can also occur if the suction pipe is restricted. A suction hose with a smaller diameter than the suction port, should not be used as cavitation can quickly damage a pump.

#### 7.3.4 Discharge Head

As the pump discharge head increases in height, the pump capacity decreases and the available pressure at the end of discharge pipe also decreases. At maximum head, the capacity of a

pump drops to zero and no pressure is available at the end of the discharge line. *The pump performance curve shows the relationship between discharge capacity and total head.*

**7.3.5 Pipe Restrictions**

When water hits any restriction (valve or a reducer), only a partial amount of the flowing water is be allowed to pass through. Restrictions increase the friction and decrease the discharge capacity at the end of the pipe. *The following conditions may be helpful in the selection of pumps*

- a) *If the pumping water level (PWL) is less than 6 meters, use a centrifugal pump (maximum suction lift = 6 m).*
- b) *If the pumping water level is from 6-20 m, use jet pumps or a submersible.*
- c) *If the PWL is greater than 20 m, use a submersible or a vertical line shaft turbine pump.*

**7.4 Terminology and Definitions**

- a) **Total Dynamic Head (TDH)** –is the sum of static head, pipe friction and velocity head at the point of discharge.
- b) **Static Head** – difference in elevation between suction level and discharge level. Refer to *Figure 7.1.*
- c) **Pipe Friction** – Head loss due to friction of the water as it moves along the pipes, fittings, elbows, valves and suction entrance.

- d) **Velocity Head** – Changes in kinetic energy of water from source to discharge point. Velocity head is calculated as the square of the velocity divided by twice the acceleration of gravity.

$$H_v = \frac{v^2}{2g}$$

Where,

- $H_v$  = Velocity head in metres
- $v$  = Velocity of water ,m/s
- $g$  = 9.8 m/s<sup>2</sup>

- e) **Water Horsepower (Output Horsepower)** – is the energy transferred by a pump to the water.

$$WHP = Q \times TDH / 75$$

Where,

- Q = Pump Discharge, LPS
- TDH = Total Dynamic Head,m

- f) **Brake Horsepower (BHP or Input Horsepower)** – is the energy transferred to the prime mover of a pump. The BHP will always be larger than the WHP due to losses caused by friction, impeller slippages, etc. BHP is expressed as:

$$BHP = \frac{Q \times TDH}{75 \times e} = \frac{WHP}{e}$$

Where:

- Q = Pump Discharge, LPS
- TDH = Total Dynamic head, m
- e = pump efficiency

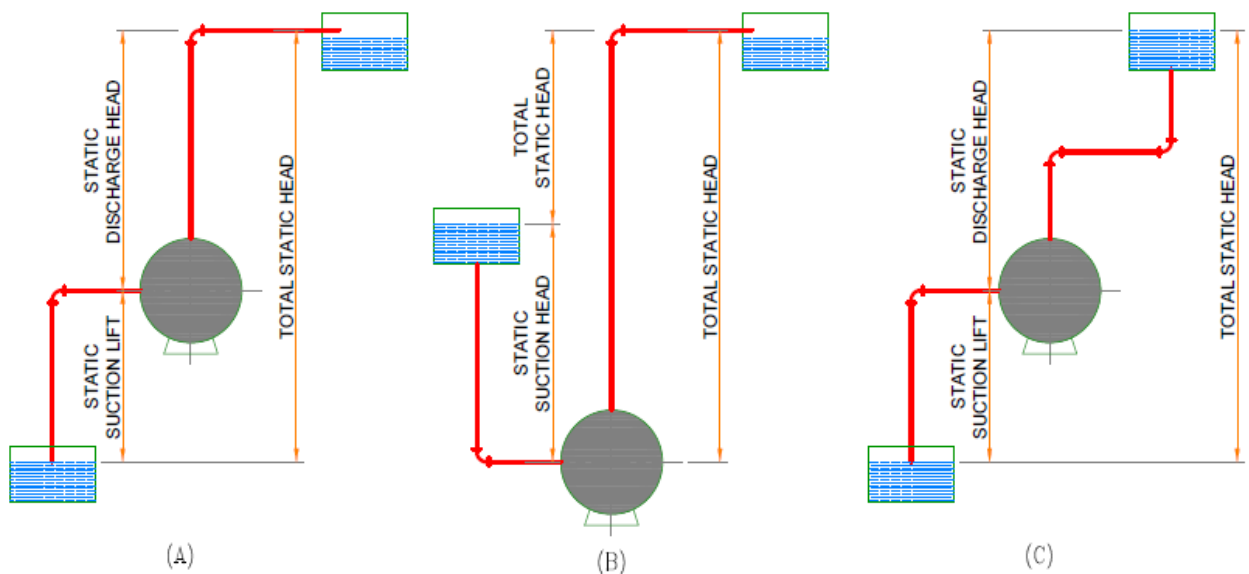

Figure 7.1 Head terms used in Pumping

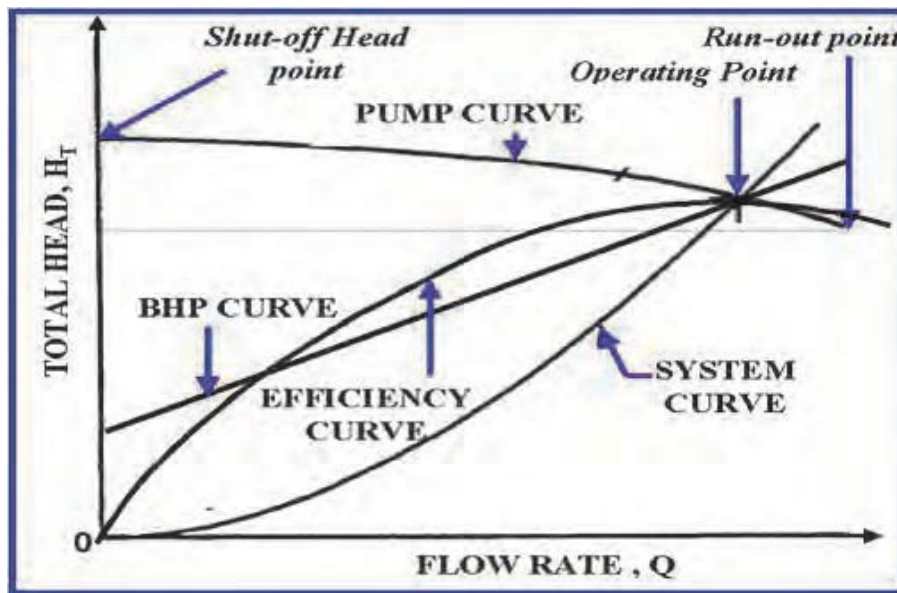

Figure 7.2 Typical Pump performance curve

#### 7.4.1 Sump design & Pump intake (IS 15310-2003)

Standard design of sump mainly depends upon rated

Flow per pump to be handled for irrigation. This will in turn govern the type and number of pumps required.

The following aspects shall be considered for a good

Sump design:

- Even flow distribution;
- Ideal flow condition in each pump bay with respect to swirl and vortex formation and prevention of pre-rotation;
- Independent pump operation;
- Use of screens in pump bays for arresting all trash and floating material; and
- Provision of gates to isolate pump bay for maintenance etc.

For satisfactory pump operation the flow into suction

pipe intake has to be evenly distributed across the area and this can be achieved by proper design of sump components. Sharp corners, abrupt turns and non symmetry should be avoided.

While designing the sump, prevention of eddies and

Vortices in the channel and pump bays-and the condition of the flow approaching inlet of bell are important.

For more details on sump design specifications and Pump Intake, refer *IS code 15310-2003*.

#### 7.4.2 Pump Performance Curve

The characteristic curve of a pump describes the factors that affect its performance. They are usually expressed graphically with rate of discharge  $Q$  as abscissa and the other factors plotted as ordinates such as the head and the net positive suction head (NPSH). Typical pump performance curve is shown in Figure 7.2. The diagram shows that as the pump discharge increases, the power required to drive the pump increases. However the pump efficiency behaves both proportionately and inversely with the capacity of the pump much like a parabolic curve. The pump efficiency increases as the capacity is increased up to a certain point. The efficiency then decreases from that point even as the capacity continues to increase. Manufacturers should supply the pump curve specifying the pump's performance and recommended operating range. Do not operate outside the recommended range as this may damage the pump.

The performance curves reflect standard testing. Pump manufacturers typically calculate performance curves using a pressure gauge and a

flow meter connected to the discharge port. For any anticipated total head, the discharge capacity can be determined. Pump performance curves are available for each pump model.

The Best Efficiency Point is the point at which effects of head (pressure) and flow converge to produce the greatest amount of output for the least amount of energy.

### 7.5 Dimensioning of Pump House

- a) Sufficient space should be available in the pump house to locate the pump, motor, valves, piping's, control panels and cable trays in a rational manner with easy access and with sufficient space around each equipment for maintenance and repairs. The minimum space between two adjoining pumps or motors should be 0.6m for small and medium units and 1m for large units.
- b) Space for the control panels should be planned as per the Indian Electricity (I.E.) Rules as follows :
  - i. A clear space of not less than 915 mm in width shall be provided in front of the switch board. In case of large panels, a draw out space for circuit breakers may exceed 915 mm. In such cases the recommendations of the manufacturers should be followed.
  - ii. If there are any attachments or bare connections at the back of the switch board, the space, if any behind the switch board shall be either less than 230 mm or more than 750 mm in width measured from the farthest part of any attachment or conductor.
  - iii. If the switch board exceeds 760 mm in width, there shall be a passage way from either end of switch-board clear to a height of 1830 mm.

- c) A service bay should be provided in the station with such space that the largest equipment can be accommodated there for overhauling and repair.
- d) A ramp or a loading and unloading bay should be provided. In large installations the floors should be planned so that all piping's and valves can be laid on the lower floor and the upper floor should permit free movement.
- e) Head room and material handling tackle.
- f) In the case of vertical pumps with hollow shaft motors, the clearance should be clear to lift the motor off the face of the coupling and also to carry the motor to the service bay without interference from any other apparatus. The clearance should also be adequate to dismantle and lift the largest column assembly.
- g) In the case of horizontal pumps (or vertical pumps with solid shaft motors) the head room should permit transport of the motor above the other apparatus with adequate clearance.
- h) The mounting level of the lifting tackle should be decided considering the above needs and the need of the head room for maintenance and repair of lifting tackle itself.
- i) The traverse of the lifting tackle should cover all bays and all apparatus.
- j) The rated capacity of the lifting tackle should be adequate for the maximum weight to be handled at any time.

### 7.6 Power Supply Arrangements

For small capacity pumps up to 15HP existing power supply lines for irrigation shall be used. For higher capacity pumps, separate power supply lines are required. The cost of separate power lines shall be included in the cost estimate.

*Solar Pumping may be used where the solar energy is abundantly available.*



## CHAPTER - 8

# OPERATION AND MAINTENANCE

### 8.1 General

Objective of proper operation and maintenance of Piped Irrigation Network is to provide irrigation water as per designed quality and quantity, with adequate pressure at convenient location and time, at competitive cost, on a sustainable basis.

Operation refers to timely and daily operation of the components of pipe irrigation network such as pumping system (pumps/motors /VFD), rising mains/ gravity mains, distribution system, balancing reservoirs/distribution chamber etc.

Maintenance is defined as the act of keeping the structures, plants, machinery, equipment, other facilities and ancillary requirements like access roads, buildings etc. in an optimum working order. Maintenance includes replacements, correction of defects, preventive /routine maintenance and also breakdown maintenance. In a pipe distribution system, maintenance of the conduits, gates, valves, metering devices, etc are very important.

A properly operated and maintained irrigation pipeline system is an asset. Piped Irrigation Network system is designed and installed as a permanent solution to irrigation delivery system deficiencies. The estimated life span of the installation can be assured and usually increased by carrying out the recommendations given on following pages. For this an O & M Plan is to be developed for a project.

Following checklist is provided to assist in developing a good operation and maintenance plan.

### 8.2 Operation Check list for Pumps

Before turning on the pump, following shall be done;

- i. Check that all pre-season maintenance is complete.
- ii. Before starting, read and record flow meter totals.
- iii. Inspect all drains to be sure that drain valves are closed.
- iv. Inspect all mainline, lateral, and turnout valves. Open the operational turnout. The first and last risers on each line, as well as any riser that is at a high point in the line, should be cracked open to allow air to be released from the system.
- v. Open all manual air release valves.
- vi. Inspect all air-vac valves to see that the airway is open (stem pushed down) and the float ball and seat are in place and undamaged.
- vii. Visually inspect all pressure relief valves to be sure that they are free to operate and have not been adjusted to a higher or lower pressure setting.
- viii. Before turning on the pump, the valve at the pump should be closed to the point that it is not more than 1/4 open.
- ix. After the pipeline is filled, slowly open the valve to full open. If the flow must be throttled during operation, consideration should be given to making changes in the system. Throttled valve wastes energy.

### 8.3 Check list for Operation during the irrigation season

- i. Whenever possible, open the new turnout before closing the old one. Always close valves slowly to prevent water hammer.

- ii. Inspect the pipeline inlet daily or more often if necessary. Remove trash or debris. Observe flow conditions in the canal and make adjustments necessary to keep the pipeline inlet submerged.
- iii. Check pressures regularly. A change means there is probably an operational or maintenance problem.
- iv. Inspect flow meters at least monthly for proper operation.
- v. Check pump and valves for noisy operation. Noise is an indication that cavitation may be occurring. Cavitation can greatly reduce the life of the pump and valves.
- vi. Check that air-vacuum valves are seated and not discharging water.

## 8.4 Maintenance Check List

### 8.4.1 Pre-season Maintenance

- i. Check pumps impellers for wear. Repair if necessary.
- ii. Re-pack bushings if necessary and lubricate pump.
- iii. Install the suction pipe on a centrifugal pump. Make sure it is well supported and has no air leaks. A vacuum gauge installed in the suction line is a good way to monitor suction problems.
- iv. Make sure a pressure gauge is installed at the outlet and is operable. A good fluid filled pressure gauge is a good monitoring tool.
- v. Check power panel, wiring and pump enclosure to make sure mouse nests, bird nests, and other such problems are resolved.
- vi. Inlet screens should be cleaned and trash removed from the structure. Repair screens as necessary.
- vii. Check headgates and valves for proper operation. Grease gate stems.
- viii. Check structures and pipeline for damage and repair as needed.

### 8.4.2 Winterizing system:

- i. Drain and pull the suction line on centrifugal pumps.
- ii. Drain the pump and protect it from the elements. If the pump is in need of

maintenance, now is a good time to get it done.

- iii. If sediment build up in the line is a problem, flush the pipeline.
- iv. Close and lock the inlet structure gates and crack open all turnouts located at high points in the line and all low lying turnouts.
- v. In case of frost condition, open all drains and allow the pipe to drain. Pump out all low spots in the pipeline.
- vi. Remove flow meters and service if necessary, then store in a dry place.
- vii. Remove pressure gauges or other accessories that may have water in them and store or fill with anti-freeze.
- viii. Close all gates, valves and other openings where small animals or water could enter the pipeline.
- ix. Leave drain valves, drain plugs and in line valves open during the winter in frost condition.

## 8.5 Choking of Pipes by excess silt

Minimum velocities as prescribed shall be maintained for flushing of the pipes. During the first irrigation, scour valves should be let open to scour out any foreign material deposited.

### 8.5.1 Repairs

Repairs of joint leakages and valve leakages should be attended promptly to avoid wastages. 10% of the fitting should be kept in spare for repair.

### 8.5.2 Right of approach to the field

The government or authorised agency has the right of entry at any time with prior notice. During the repairs if standing crop is there, crop compensation shall be provided to the farmers.

## 8.6 Maintenance of Pumps

Usually maintenance instructions are available from manufacturers, pump users associations and other technical organizations. For most engine or electric motor driven pumps, checks and inspections are for noise, vibration, leakage, temperatures of bearings and windings, fuel/power consumption, capacity and output (water discharge and dynamic head), ventilation screens etc.

Special care should be taken to protect engines from moisture that can accumulate inside the machines and cause serious damage.

### **8.7 Maintenance of Valves**

All kinds of valves should be anchored properly so as to minimize the turning movement imparted to the pipe by operation.



## CHAPTER - 9

# FIELD AUTOMATION AND CONTROL

### 9.1 General

Supervisory control and data acquisition (SCADA) is a system of software and hardware elements that allow to monitor, gather, and process real-time data, control processes locally or at remote locations, directly interact with devices such as sensors, valves, pumps, motors, and more through human-machine interface (HMI) software and record events into a log file. Schematic diagram of SCADA is given in Figure 9.1.

### 9.2 Need for SCADA

Understanding the underlying process with true animation makes it easy to understand. It can communicate to any of protocols available in market since SCADA is not dedicated to any one type of application or industry. Distance as such doesn't hamper SCADA operation. Hence we can monitor processes at places which are inaccessible. SCADA is not 100% the controller. It is a software which is linked with controllers and hence to PLC/PID/DCS systems which in turn are connected to field instruments.

### 9.3 Features of SCADA

Following are the features of SCADA systems:

- i. **Dynamic representation:** Explains about the representation of various symbols of field instruments which are present in tool library which can be utilized in SCADA applications. SCADA is not dedicated to any specific industry hence its library large and can accommodate requirements of any industry.
- ii. **Database connectivity:** Represents various symbols of field instruments which are present in tool library of SCADA. It doesn't have its own database like Microsoft etc. However, its storage depends on databases available in

market and they are well linked to VB, Excel, SQL SAP etc.

- iii. **Device connectivity:** As mentioned before, SCADA is never the 100% controller. Therefore, it can't run the process on its own. It needs to be connected to the any of PLC or DCS specific to the requirement. Hence, PLC or DCS available in the market should be connected to the SCADA by using the specific driver software.
- iv. **Alarms:** Alarms are implemented by indicating lamps or hooters in field and SCADA represents it with format. In the field area alarms are generated for warnings or to monitor the process. The format consists of Date, Time, Status, Priorities and many such elements which can be used for generation of reports.
- v. **Trends:** Also called as XY plotters or data loggers, Trends represent values in wave format and is one of the important features of SCADA. It plots value with reference to time. Trend can be subdivided into real time historical trends i.e present and past values of the process can be stored and records can be maintained for the same.
- vi. **Scripts:** These are combinations of logical operators which are written in the form of statement. It is used to run the applications made or simulate before final execution. Various types of scripts make project execution simpler for programmer.
- vii. **Security:** Every application has to be secured from unauthorized users by different security levels. In SCADA this security can be given as a whole as well as individually.
- viii. **Recipe management:** Being one of the finest features of SCADA, recipe management can

maintain recipes of different process and implement it on the process. All the recipes are stored in a single server and it can be fetched by any client server from any area to run the process.

- ix. **Networking:** It explains that we can share SCADA applications on LAN or internet and hence exchange of data is possible. Many networking protocols are supported by SCADA software. SCADA can be put on networking with other peripherals and processors with various networking topologies.

## 9.4 Cost

Cost of SCADA is mainly decided by two factors as given below :

- i. **Tagnames & Tagtypes:** Every symbol used in software has to have a specified name. Logical name given to any symbol is said to be tag name. Tag types define the symbol category. It may be discrete & analog.
- ii. **Packages:** They are in the form of DRN (Development, Runtime & Networking) & RN (Run and Networking).

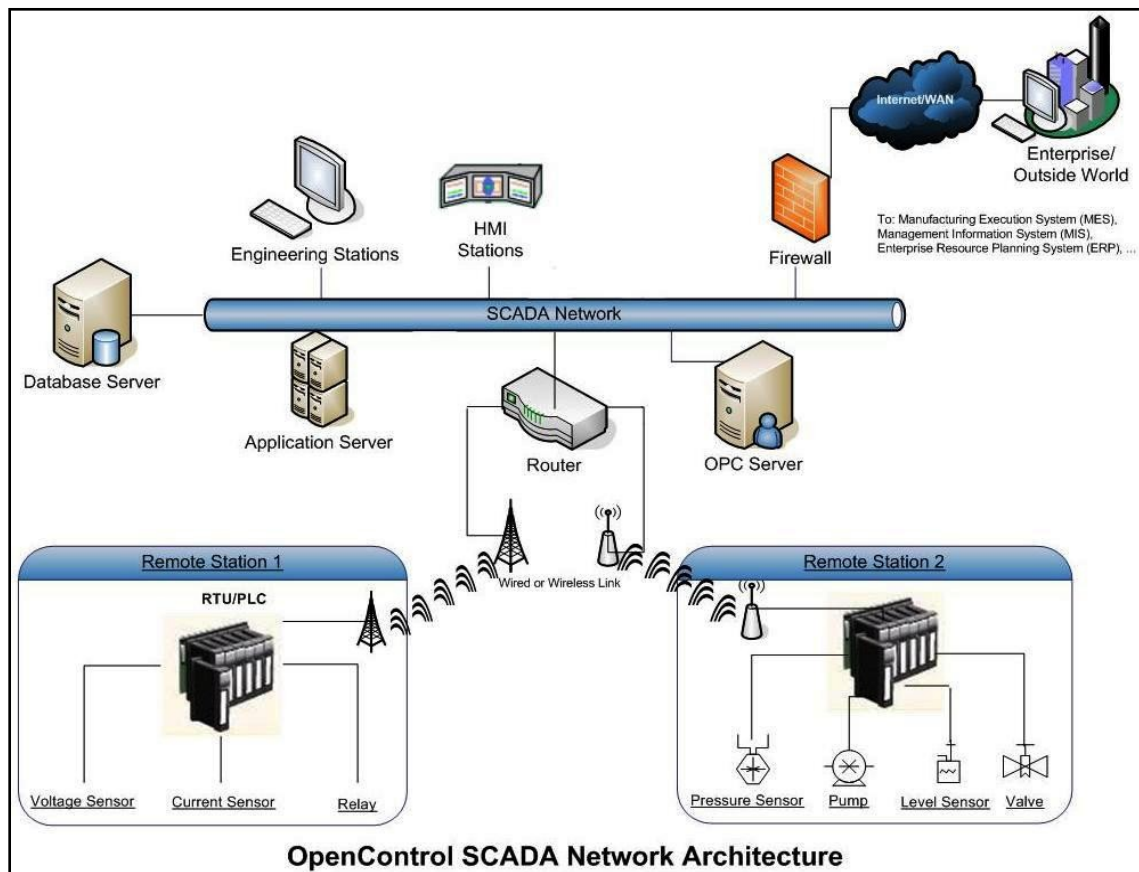

Figure 9.1 Open Control SCADA Network Architecture

## CHAPTER - 10

# PIPED IRRIGATION NETWORK EXAMPLE

### 10.1 General

The design example given in this chapter compares both options of Canal and PIN and their relative costs. For the purpose of demonstration, canal network of Kholra distributor of Pratapur Branch on Left Main Canal has been taken from the DPR of Kanhar Project, Jharkhand. In the analysis of slopes, it is found that the distributor has flat longitudinal slope. The minors have steep slope favourable for gravity Piped Irrigation Network. The source for canal is Lawadoni Dam on Kanhar River and source for present Piped Irrigation Network is Kholra distributor. In this example the first Minor, namely Arangi Minor has been tried for Piped Irrigation Network vis a vis canal.

### 10.2 Network Layout

Canal network and relative position of Arangi Minor (in inset) have been shown in the Figure 10.1. The minor has a total area of 204 acres with a design off take discharge of 1.95 cusec.

### 10.3 Chak boundaries, Outlet Location

Contour map of Arangi Minor with 0.5m contour interval (major contours are only depicted) is shown in Figure 10.2. Location of five Chak outlets, boundary and net GCA of each chak have been marked out. The south boundary of command of minor is the Railway line and north boundary is village OOC.

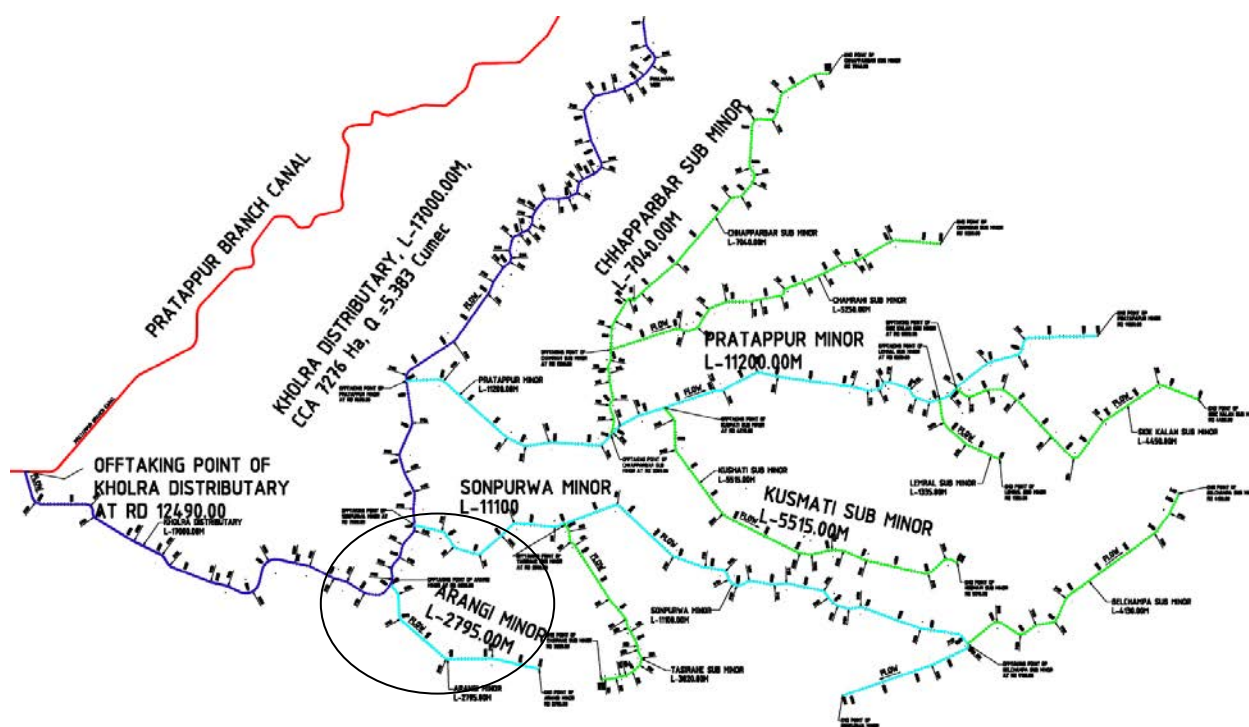

Figure 10.1 Canal Network of Kholra Distributary and Location of Arangi Minor

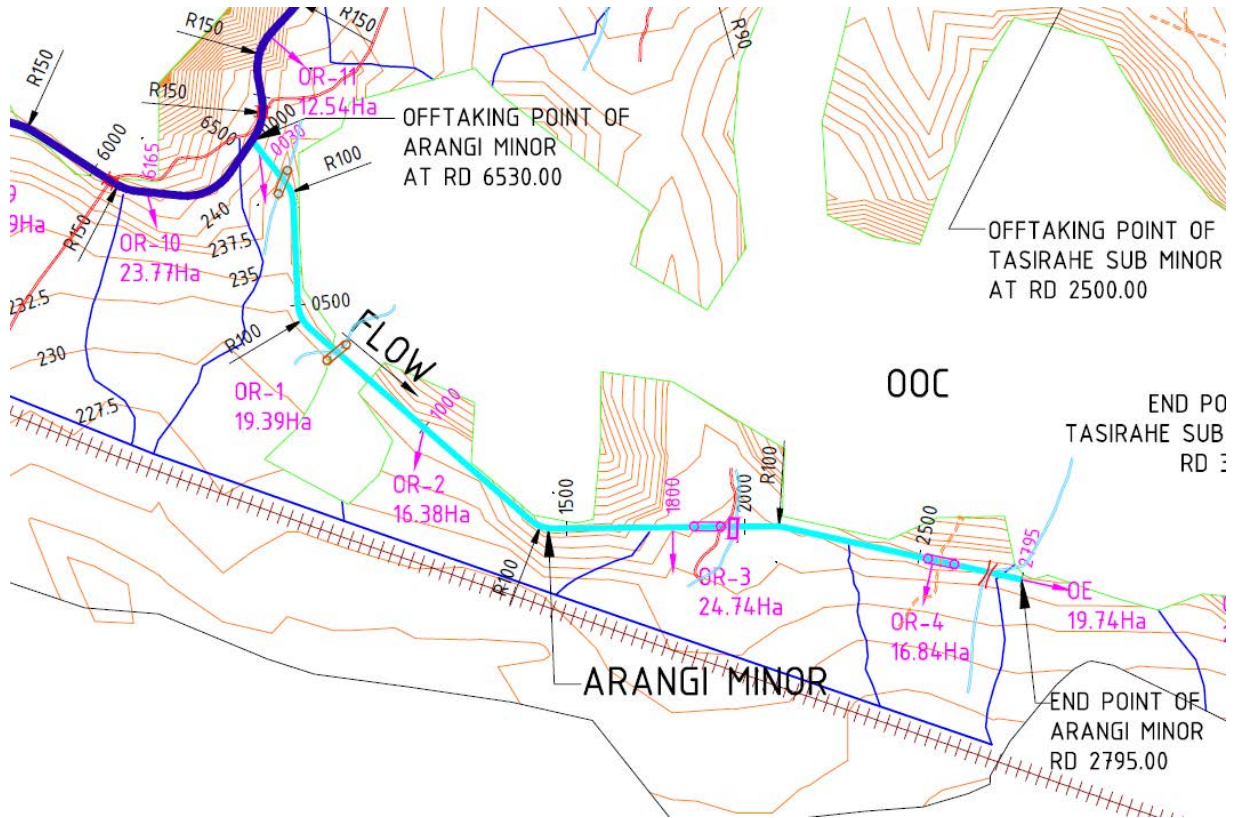

Figure 10.2 Contour Map, Chak Boundaries and outlet area



Figure 10.3 Alignment of Arangi Minor with RD and curves



### 10.4 Capacity Statement

The capacity statement of minor is worked out with authorised duty of 1500 ha/cumec. This may be cross checked with crop water requirement for more scientific assessment. The off taking discharge at the head of the minor has been arrived as 0.055 cumec or 1.95 cusec with a CCA of 82.53 ha or 204 acres. Head discharge for canal option with 90% conveyance is 0.061 cumec.

### 10.5 Canal Option

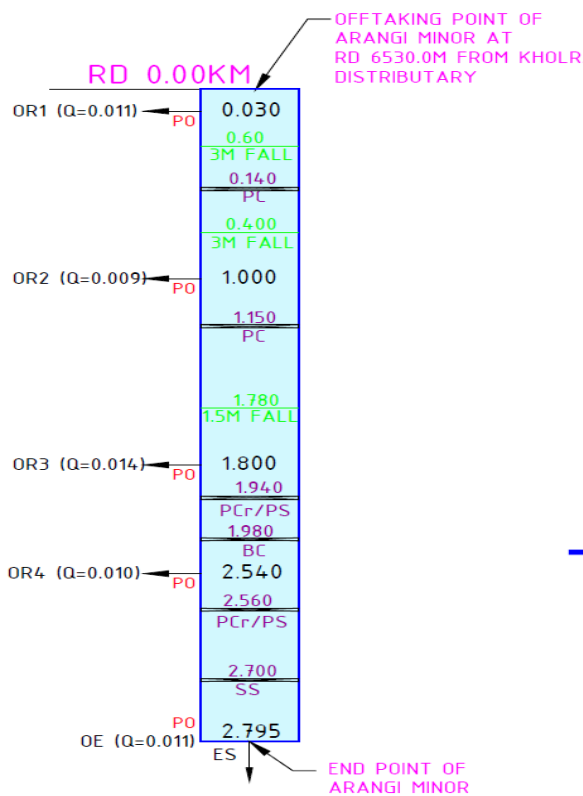

Figure 10.4 Tree diagram of Arangi Minor

The layout for canal option is shown in Figure 10.3. The canal has three falls namely i) at RD 60 of 3 m fall, ii) RD 400 m of 3 m fall and iii) RD 1780 m of 1.5m fall. The bed at off take point is 241.671 m and the end of canal at RD 2795m is 233.096 m. Total bed fall of the canal is 8.575 m out of which 7.5m is provided by three number falls and remaining 1.075m is provided by total longitudinal fall. The longitudinal slope works out to be 1 in 2600. The FSL of parent canal is El.244.81m. Therefore, total static head available is  $(244.81-241.671) + 8.575 = 11.714m$ . In

addition to the falls, the canal has two pipe culverts, two pipe crossings, one stream siphon and one box culvert. Total of 9 canal structures are present in the layout.

#### 10.5.1 Land Acquisition for Minor Canal

The design canal width with service road is shown in Figure 10.5. Average right of way required for the canal is 18 m. Total land required is  $15 \times 2795/10000 = 4.2$  ha. The L-section of the Canal is given in Figure 10.6.

### 10.6 Pipe Option

Considering pipe option, gravity head of 11.714m is available. With a Hazen William Coefficient of 130 for HDPE pipes and a trial velocity of 1 m/s, the head losses and residual head at outlets have been worked as given in Table 10.2. L-Section for pipe option is given in Figure 10.6. Above mentioned calculations by analytical method have been checked by a computer analysis and the results of head loss and residual head are found to be matching. The actual velocities with provided diameter of pipe have also been worked out as shown in the computer screen shots given by Figure 10.7.

#### 10.7 Cost Comparison - Canal Vs Pipe

Comparison of cases of canal and pipe are illustrated in Table 10.1. It shows the cost involved in both cases and also gives an indication of the amount of water saved by on using the option of pipe.

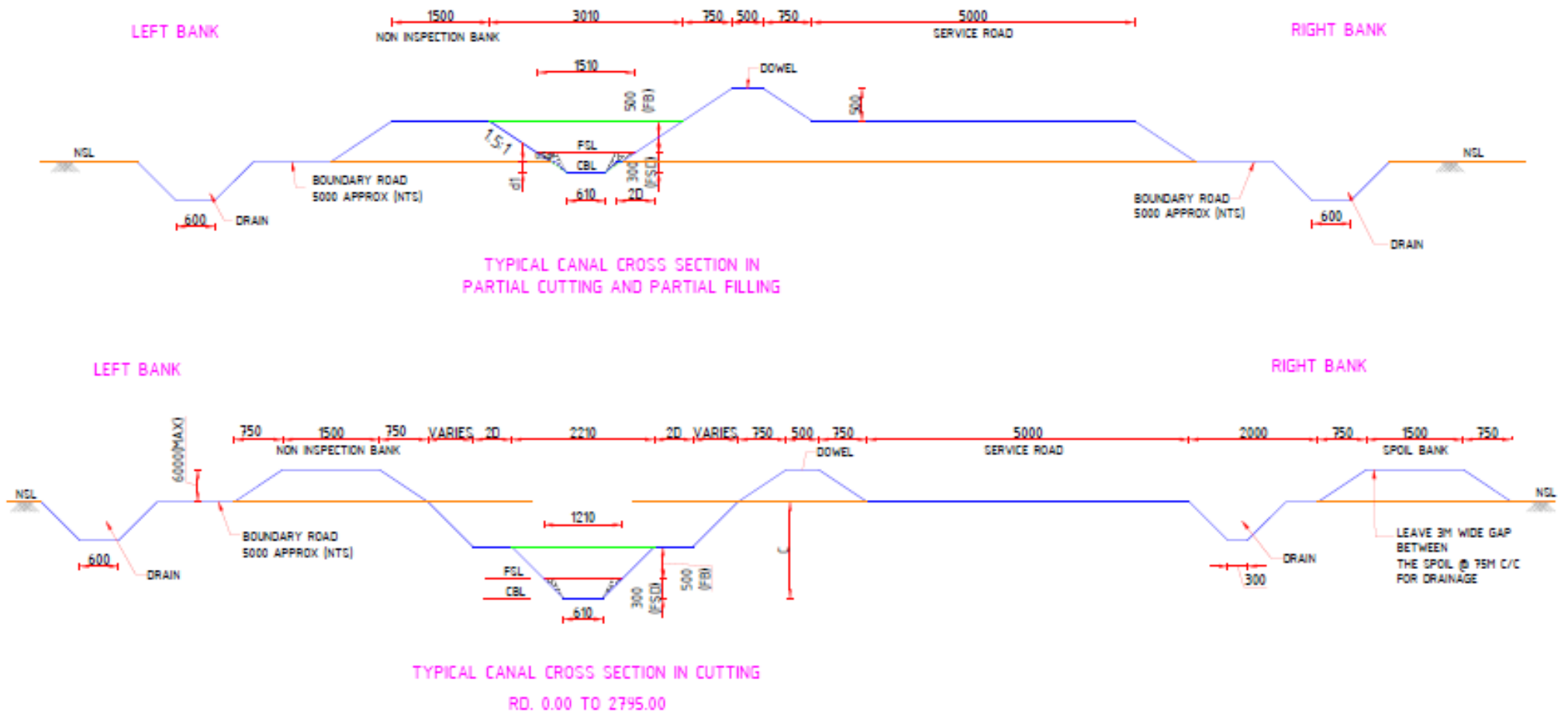
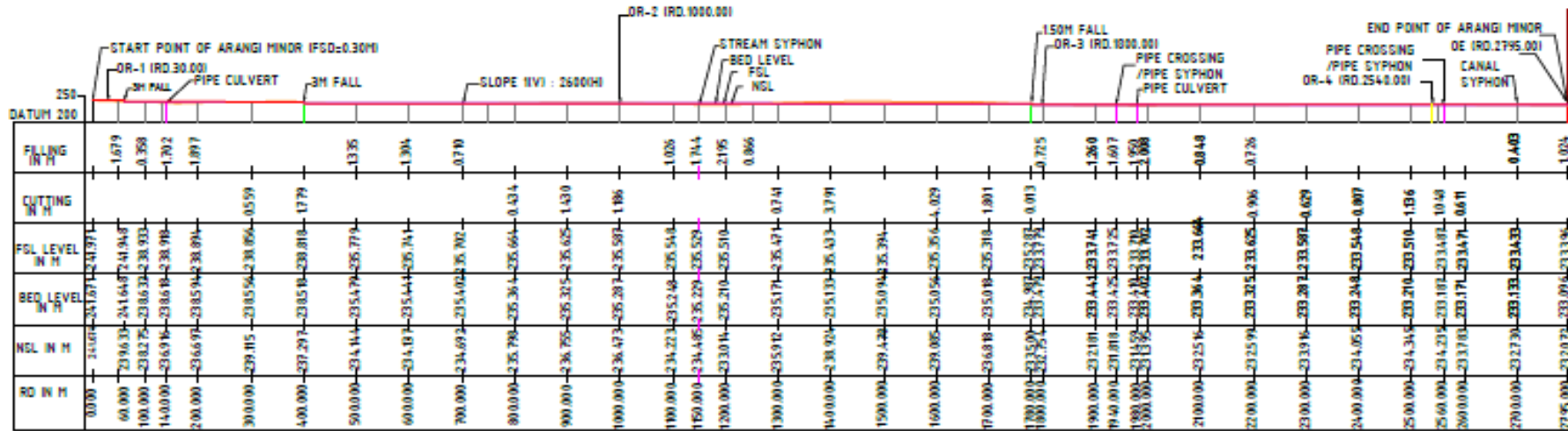

Figure 10.5 Canal Cross-sections



L-SECTION OF ARANGI MINOR (OFFTAKE AT RD 6530.00 FROM KHOLRA DISTRIBUTARY CANAL)

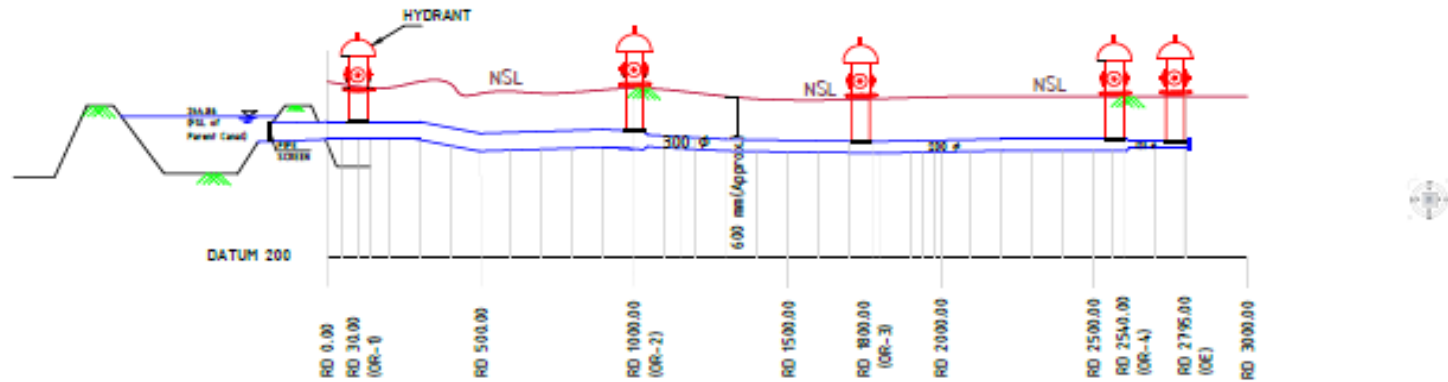

Figure 10.6 Canal L-Section of Arangi Minor Line

Table 10.1 Cost Comparison – Canal vs Pipe

<b>Cost for Canal Option (Unit cost as per DPR)</b>		
Land Acquisition @Rs16 la per Ha	= 4.2x16	= Rs 67.2 la
Cost of canal structures @ 1.5 la for each	= 1.5X10	= Rs 15 la
Lining of canal with 75 mm thick	= 2X75/1000X2795X5000	= Rs 20 la
Earth work excavation & bank formation including kucha road inspection	= Rs15 la	
<b>Total cost of canal</b>		<b>= Rs 117.2 la</b>
<b>Cost for UGPL Option</b>		
i. Cost of Material (HDPE 4kg/cm <sup>2</sup> grade) including supply and delivery		
300 mm dia Rs 1995/RMT X 1000	= Rs 19,95,000	
200 mm dia Rs 783/RMT X1540	= Rs 12,05,820	
125mm dia Rs 314/RMT X 255	= Rs 70,650	
<b>Total Cost of Laying</b>	<b>= Rs 32,71,470</b>	
ii. Cost of Earth work Excavation and Laying of pipe line		
Laying and jointing of HDPE pipes in readymade trench by butt fusion welding as per IS:7634 – part-II/1975 as amended from time to time to the alignment and gradient and testing the pipeline to the required pressure.		
300 mm dia Rs 183/RMT X 1000	= Rs 1,83,000	
200 mm dia Rs 91/RMT X1540	= Rs 1,40,140	
125mm dia Rs 67/RMT X 255	= Rs 17,085	
<b>Total Cost of Laying</b>	<b>= Rs 3,40,225</b>	
iii. Total cost for UGPL is 32.72 +3.4 = Rs 36.12 Lakh		
Ratio of canal to Pipe =117.2/36.12 = 3.24 times canal is costlier than pipe. Major portion of the canal cost is due to Land acquisition and CD structures. For pipe it is the cost of material only. If PVC pipe of 4kg/cm <sup>2</sup> grade are used the cost of UGPL reduces further.		
Water saved by UGPL is 61-55 = 6LPS.		

Table 10.2 Details of off taking pipes

Sl.No.	Reach	1	2	3	4	5	Total
1.	Name of the Off taking Outlet	OR-1	OR-2	OR-3	OR-4	OE	
2.	Off taking RD (m)	30	1000	1800	2540	2795	
3.	GCA	19.39	16.38	24.74	16.84	19.74	<b>97.09</b>
4.	CCA = 85% of GCA (ha)	16.48	13.92	21.03	14.31	16.78	<b>82.53</b>
5.	Discharge Required with duty of 1500 ha/cumec	0.011	0.009	0.014	0.010	0.011	<b>0.055</b>
6.	Cumulative Discharge	0.055	0.044	0.035	0.021	0.011	
7.	Incremental length	30	970	800	740	255	
8.	Assumed	1	1	1	1	1	
9.	Pipe dia required (mm)	265	237	210	162	119	
10.	Provide dia of ID	300	300	200	200	125	
11.	Head Loss	0.06	1.39	5.31	1.89	2.05	<b>10.70</b>
12.	Cummulative Head Loss	0.06	1.45	6.76	8.65	10.70	
13.	GL at Outlet	241.67	236.47	232.75	234.24	232.07	
14.	HGL	244.80	243.41	238.10	236.21	234.16	
15.	Net Head available	3.12	6.94	5.35	1.98	2.09	

### 10.8 Computer Analysis

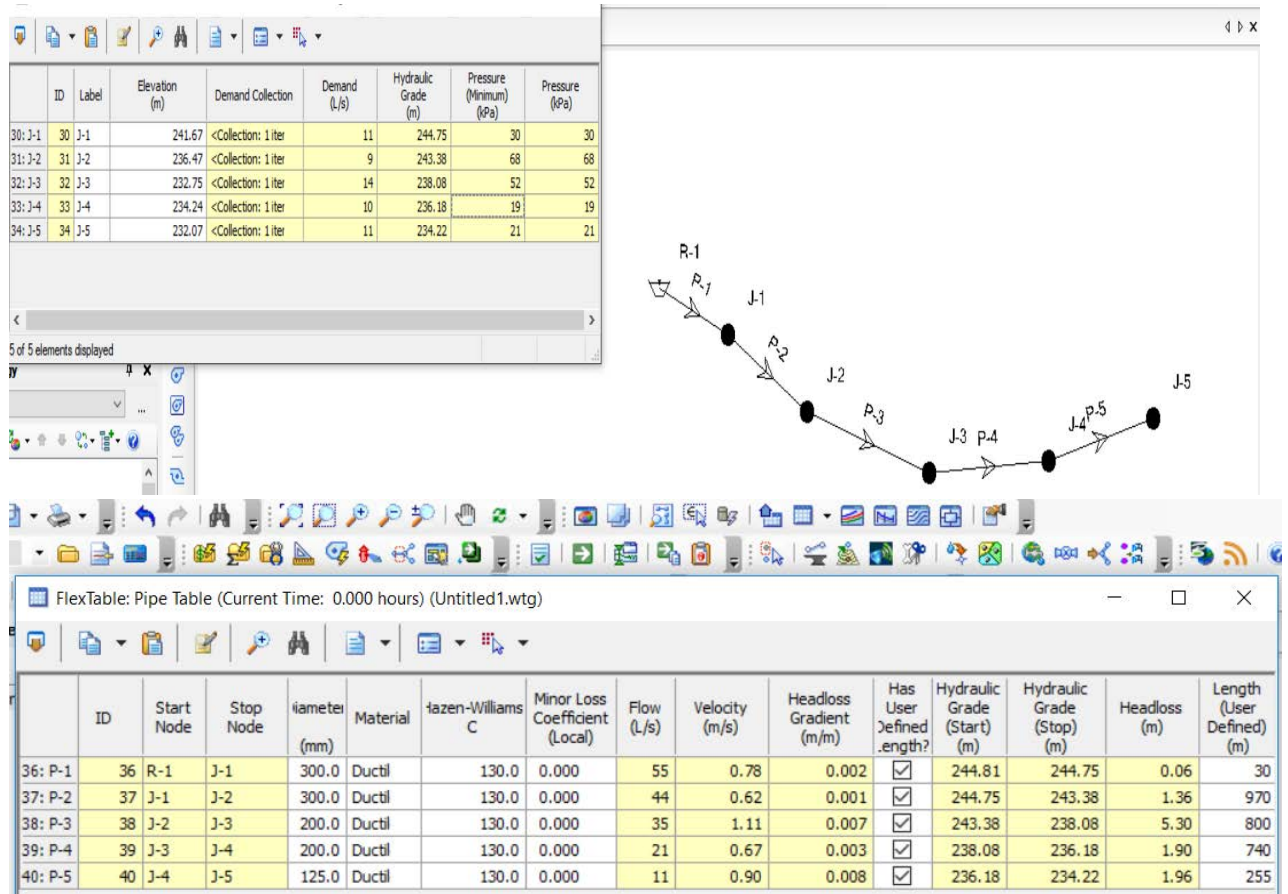

Figure 10.7 Computer Analyses for Arangi Line (UGPL)

**DISCLAIMER:**

*In this Appendix, the case studies of various Irrigation projects with piped Irrigation network in the country and international experiences presented in the workshop on Pipe Irrigation Network held in New Delhi in March 2017 have been given. The information presented is for illustrative purpose only. The views/recommendations/comments expressed in the presentations are solely of the Project Authorities/Authors, and these shall not be considered as part of Guidelines.*

**LIST OF PRESENTATIONS MADE IN THE PIPE IRRIGATION NETWORK (PIN) WORKSHOP**

1. STATUS OF PRESSURISED IRRIGATION PROJECTS (DELIVERING WATER UP TO 1 HA.) IN MP
2. COMPARISON OF PERFORMANCE BETWEEN OPEN CHANNEL AND PIPELINE, GUJARAT
3. SANCHORE PROJECT RAJASTHAN
4. PROJECTS EXECUTED BY PRIVATE AGENCIES IN INDIA
5. RAMTHAL PROJECT , KARNATAKA
6. PROJECTS IN MAHARASHTRA
7. MEGA LIFT IRRIGATION PROJECTS, CLUSTER NOS. - XII, SUNDERGARD AND JHARSUGUDA, ODISHA
8. MOHANPURA MAJOR PROJECT, RAJGARH, MADHYA PRADESH
9. SARDAR SARVORAR (NARMADA PROJECT)
10. SOLAR POWERED COMMUNITY MICRO-IRRIGATION PROJECT, HOSHIARPUR, PUNJAB
11. TIKTOLI DISTRIBUTARY PIPE IRRIGATION PROJECT BY GRAVITY FLOW, GWALIOR, MADHYA PRADESH
12. INTERNATIONAL SCENARIO

**1. STATUS OF PRESSURISED IRRIGATION PROJECTS (DELIVERING WATER UP TO 1 HA.) IN MP**

Sl. No	Name of Projects	Main parameters of the Schemes				Cost/Ha (Rs lakhs) UNIT- II
		CCA (ha)	Power (MW)	Cost (Cr) Unit-II	District	
1	Sajali medium Project	9990	1.3	590.00	Damoh	1.69
2	Pancham Nagar	9940	0			
3	Gopalpura	15060	0			
4	Judi	8500	0.00	140.00	Damoh	1.65
5	Chhita Khudri	9600	1.20	147.00	Dindori	1.53
6	Hiran	8125	1.00	147.00	Dindori	1.81
7	Baghrajji	2600	0.43	29.20	Dindori	1.12
8	Kharmer	9980	1.97	144.00	Dindori	1.44
9	Dindori	9920	3.10	176.00	Dindori	1.77
10	Bansujara	75000	3.50	896.00	Tikamgarh	1.19
11	Jamunia	10300	2.80	156.00	Chhindwara	1.51
12	Parasdoh	9990	3.00	140.00	Baitul	1.40
13	Chanderi	20000	10.80	334.00	Ashoknagar	1.67
14	Garoth	21400	5.30	352.00	Mandsaur	1.64
15	Thanwar Extension	7000	3.00	112.00	Mandla	1.60
16	Tawa Extension	28413	8.00	386.00	H'bad/Harda	1.36
17	Kotha Barrage	20000	9.00	320.00	Vidisha	1.60
18	Barkheda	9990	0.00	177.00	Dhar	1.77
19	Karam	9900	0.00	148.50	Dhar	1.50
20	Naigarhi	50000	15.00	883.00	Rewa	1.77
21	Ramnagar	20000	10.50	388.00	Satna	1.94
22	Kaith	5135	0.00	90.00	Sagar	1.75
23	Kadan	9990	1.40	180.00	Sagar	1.80
24	Tem	9990	0.00	160.00	Vidisha	1.60
25	Kundaliya	125000	55.00	2000.00	Rajgarh	1.60
26	Mohanpura	125000	47.00	1710.00	Rajgarh	1.37
27	Lower Orr	90000	15.00	1600.00	Shivpuri/ Datia	1.78
28	Gandhi Sagar, Suwasra	40000	16.30	800.00	Mandsour	2.00
29	Bhawasa	4030	0.00	75.00	Khandwa	1.86
30	Dargad	1950	0.00	24.00	Dindori	1.23
31	Kundiya	C.E. Projects	9440	0.00	165.00	Dhar
32	Uri	C.E. NT	5000	1.60	86.00	Dhar
33	Aulliya	C.E. NT	5700	1.30	92.00	Khandwa
34	Bham	C.E. NT	6100	1.80	105.80	Khandwa
35	Karanjiya	C.E. Seoni	9100	3.30	164.52	Dindori
	<b>Total</b>		<b>812143</b>	<b>223</b>	<b>12918</b>	<b>MP</b>

## 2. COMPARISON OF PERFORMANCE BETWEEN OPEN CHANNEL AND PIPELINE, GUJARAT

Name Of Project	Planned Cca In Ha			Actual Irrigation In Ha		% Actual Irrigation	
	Total	Open Channel	Pipe Line	Open Channel	Pipe Line	Open Channel	Pipe Line
Ukai	59523	46722	9551	22450	2838	48	29
Karjan	45000	25000	20000	11000	1996	44	10
Watrak	18341	917	17341	600	2051	44	12
Mazam	4717	235	4482	99	700	42	16
Guhai	7111	0	7111	0	3756	-	53

## 3. SANCHORE PROJECT RAJASTHAN

The CCA has been increased from 1.35 lac hectare to 2.46 lac hectare i.e. 78% increased. No. Of villages benefited for irrigation increased from 89 to 233. Drinking water facility in 1541 villages and 3 towns has been provided, which was not proposed earlier. Increase in food production has been assessed 534 cr. to 2200 cr. i.e. 1666 cr. (312%) based on year 2015-16.

### Comparison of Cost between Piped Irrigation Network & Open Canal Networks

Analysis of rates for piped irrigation network for CCA of 100 ha		
(A)	Civil work	Rs. In lacs
	Cost of Diggie	6.18
	Cost of Sump	1.70
	Cost of Pump House & Boundary Wall	7.08
	Total of Civil Work	14.96
(B)	Mechanical work	
	Cost of 2 Nos. of Motor driven horizontal centrifugal pumping sets of discharge 12 LPS to 16 LPS including suction pipes, vacuum pumps, all valve, foot valve, foot valve strainer with required pipes and fittings such as flanges, bends, tees, reducers, enlargers, tail piece etc. and delivery pipes and its accessories, electric control panel of 16 SWG(CRCA), Aluminum PVC insulated PVC sheathed armoured cable including earthing two pits and providing and installaton of hydro cyclone filter	3.00
(C)	Supplying, laying, jointing, testing and commissioning of designing and planning of Buried HDPE pipe network	Rs0.13538/Ha or Rs13.538/100Ha
	Cost of 100 Ha. of CCA	RS 31.498 lac
(D)	Erection of 11 KV S/C line on 33 KV insulation for 1 km.	Rs 4.95 lacs
(E)	Security Deposit for electrification	Rs 0.55 lacs
	Total	Rs 36.998 lacs



Rate per Hac	Rs 36998/Ha
Assuming a chak of 100 ha.	Rs.3699800.00



Typical Drawing of Pump Room , Sump Well & Diggi

#### Open canal Vs UGPL(Under Ground Pipeline) Cost comparison

<b>Salient Features Of Khari-Paldi Minor-Ii</b>			
1.	Name of Branch Canal	Vejpur Branch Canal	Vejpur Branch Canal
2.	Name of Canal	8 Subminors Of Khari-Paldi Minor-Ii Of Abasan Sub Disty Of Abasan Disty	8 Subminors Of Khari-Paldi Minor-Ii Of Abasan Sub Disty Of Abasan Disty
3.	Region No.	12	12
4.	Off taking chainage Of Minor	996 m	996 m
5.	FSL of Distributary/Minor	46.248 m /46.098 m	46.248 m /46.098 m
6.	GCA in Ha	426.16	426.16
7.	CCA in Ha	336.29	336.29
8.	Discharge in Cumecs	0.195	0.195
9.	B.D.C. for Minor/Sub Minor	0.00058	0.00058
10.	Design factor for Minor /Sub Minor	1	1
11.	Type of Material for UGPL	UPVC	UPVC
12.	Type of well	RCC Circular well	RCC Circular well
13.	Length of Minor and Branch Minor(OPEN CANAL)	2917 m	2917 m
14.	Length of Sub Minor(UGPL)	12053 m	12053 m
<b>Details Of Subminors Under Gravity Flow</b>			
1.	CCA under Gravity flow in ha	49.5828	286.708
2.	Length of subminors under Gravity flow in m	1528	10053
3.	Total cost of subminors under Gravity flow in Rs.	2380591	17866385
4.	Cost per ha of subminors under Gravity flow	48012	62316

	in Rs.		
--	--------	--	--

#### 4. PROJECTS EXECUTED BY PRIVATE AGENCIES IN INDIA

Location	MRP Tirunelveli (T.N.)	AMRP Nalgonda (Telangana)	SSNNL/ GWRDC Different Districts (Gujarat)		LIMIP Pulivendula (A.P.)	Purna C. Bhaga (MS)	Balh Valley Sundernagar (HP)	KNNL Shigaon (KS)	IGNP Bikaner (Raj.)
Area to be / Irrigated (Ac)	988	533	617	455	14,820	29600	5,817	24,453	37,050
Beneficiaries	600	180	200	216	5,000	10544	7,500	8,154	3,000
Water Source	M.I. Tank	Canal (AMRP)	Canal (SSNN L)	Community Tubewells	Canal (PBC)	Canal (Purna)	Canal (BBMB)	River (Varada)	Canal (IGNP)
Cost Per Acre (In Rs.) *	40,486	9,750	43,450	14,500	31,000	7,080	1,11,700	68,700	5,950
Duration (Mnth)	6	12	9	6	4	26	36	26	12
Handed Over	2008	2009	2010	2011	2011	2011	2012	2012	2012
Maintenanc e Contract (Yrs.)	1	2	1	1	3	2	5	2	2
System Type	Pressurised Drip / Sprinkler		Pressurised Drip		Pres. Drip / Sprinkler	Gravity Pipe	Pres. & Gvty. Sprinkler	Pressurised Drip / Sprinkler	

Location	NCP Sanchole, (Raj.)	Ramthal Hungund (Kar.)	Cane Agro Sangli (MS)	Kandi Integrated Kandi (Punjab)	Nadaun Hamirpur (HP)
Area to be / Irrigated (Ac)	3,38,400	30,381	2,009	1,642	7,360

<b>Beneficiaries</b>	40,000	7,382	1,255	1,200	3,000
<b>Water Source</b>	Canal (Narmada)	Canal	Tank	Canal	Beas River
<b>Cost Per Acre (In Rs.) *</b>	8,190	1,27,000	1,36,706	2,49,270	1,32,500
<b>Duration (Mnth)</b>	21	24	12	12	24
<b>Handed Over</b>	In Progress	In Progress	In Progress	In Progress	In Progress
<b>Maintenance Contract (Yrs.)</b>	3	2	1	7	5
<b>System Type</b>	Pressurised Drip / Sprinkler	Pressurised Drip	Pressurised Drip	Solar Powered Drip	Pressurised Sprinkler

## 5. RAMTHAL PROJECT, KARNATAKA

With an area of 11,700 Ha is a mega Community Drip Irrigation Project launched by KBJNL in Northern Karnataka.

- The uniqueness of this first of its kind, *worlds largest Community Drip Irrigation Project*
- Mega Community Drip Irrigation Project 24000 Ha
- Total beneficiaries in package I of project = 6700 farmers
- Total infrastructure cost is borne by Govt.
- Project execution time is only 18 months including monsoon
- System operation is through wireless automation
- O&M of the system for first 5 years
- Formation of WUA & marketing linkages
- Irrigation is only for partial command area – 80% during kharif season & 50% during rabi season

## 6. PROJECTS IN MAHARASHTRA

- Gunjawani Project** : Dam Head Available 42 m, Head utilized for pressurized PDS, Storage 108 Mm<sup>3</sup>, ICA 21400 ha, Chak Size 2.5 Ha, Residual Head 20 m, Totally PDS including Main line, Distribution network upto drip point Compatible with drip, Water will be seen either at Dam or drip point at root zone.

### Gunjawani Irrigation Project and Narayanpur LIS

		<b>Old</b>	<b>New</b>
<b>1</b>	Project Area in Ha	21400	21400
<b>2</b>	Chak Size	100 - 200	24 to 3
<b>3</b>	Local pond at Chak	Yes	No
<b>4</b>	Pipe Size mm	2700	2600
<b>5</b>	Total Quantity of Pipe Distribution Network From Dam to Chak Km	111	1015
<b>6</b>	Equitable Distribution of Water & Pressure the OMS	No	Yes

7	Water Meters @ 24Ha Chak	No	Yes
8	Central Control and Monitoring by HSCADA	No	Yes
9	Auto Filters Primary and Secondary for Micro Irrigation	No	Yes
10	Residual Pressure at 24Ha Chak m Ready for Micro Irrigation	2	20
11	Remote ON/OFF at 3Ha Sub-Chak	No	Yes
12	Wireless Energy less Communication System by Radio / GPRS	No	Yes
13	Vandalism Alerts	No	Yes
14	Pipe Leakage Alerts	No	Yes
15	SMS Alerts to Farmers	No	Yes
16	Officials can access through Internet on their computers/SmartPhones	No	Yes
17	Reports and Data Log available on Computer	No	Yes
18	Total Cost of the Project in Lakhs	98100	66645.34
19	Cost / Ha in Lakhs	4.58	3.11
20	Savings		31454.66



Head Regulator of Bhose Gravity Main

## 2. Bhose Distribution Network

Salient Features	
<b>Water Source</b>	Khanerajuri M.I. Tank (Dongarwadi L.I.Scheme)
<b>Type Of Pipe :</b>	P.S.C. Pipes
<b>Pipe Dia.:</b>	1700 To 350 Mm
<b>Pressure:</b>	4 TO 8 Kg/Cm <sup>2</sup>
<b>Design Disch. :</b>	2.165 Cumec
<b>Cost Of Work:</b>	117 Crore
<b>Work Period:</b>	30 Months

<b>Year Of Commencement:</b>	2014-15
<b>No. Of Villages :</b>	18
<b>Total Command</b>	4581 Ha
<b>Chak Size</b>	18 To 33 Ha
<b>Total Outlets :</b>	152
<b>Cost Per Ha</b>	2.55 akh

Pipe distribution network- kavathemahankal section of Bhoose Distribution Nt

Name Of Pipeline	Main Gr. Line		Distr. Network		Total	
	Length (Km)	Irri. Area (Ha)	Length (Km)	Irri. Area (Ha)	Length (Km)	Irri. Area (Ha)
<b>Bhoose Gr. Line</b>	19.80	394	63.15	4187	82.95	4581
<b>Banewadi L.I. Scheme</b>		0	23.21	1100	23.21	1100
<b>Ori. Gavan L.I.Sceme</b>		0	13.60	645	13.6	645
<b>Extended Gavan L.I.Sceme</b>		0	39.61	1999	39.61	1999
<b>Bedag Canal Dy-1 &amp; Dy-2</b>		0	34.51	1864	34.51	1864
<b>Kalambi Br Canal Km 37 To 42</b>		0	42.54	3336	42.54	3336
<b>Total</b>	19.80	394	216.60	13131	236.40	13525

**Bhoose pipe distribution network : benefits**

- For canal expected land acquisition – 242 ha. Cost – rs. 48.80 cr.
- Actual land acquired for pipe distribution network – 33 ha. Cost rs. 6.60 cr.
- Saving due to pipe distribution network rs. 42.20 cr.
- The scheme is completed in time due to elimination of land acquisition bottleneck.
- Increase in velocity of flow resulted saving of 10 hrs in time to reach end of canal in each rotation.
- 30 % reduction in conveyance losses resulting in 1.68 mcum saving of water per rotation that is about Rs. 8 lakh with present water charges.
- Less evaporation losses.
- Saving in yearly maintenance & repairs expenditure of canal.
- Less staff for irrigation management.
- Saving due to prevention of water theft.
- No damage to system components by miscreants such as breaking etc.
- Easy water management & effective collection of water charges.

**Cost Analysis :**

Sr. No.	Description	Total Area (Ha)	Cost Lakhs	Cost per Ha in lakhs
---------	-------------	-----------------	------------	----------------------

1	Total Area of Bhoze Gravity Main	4581	11715.92	2.55
2	Malgaon Distributory	765	1151.02	1.50
3	Kalambi Distributory	518	831.59	1.60
4	Sub-Main 7	978	1633.37	1.67
5	Direct Minors < 200 Ha	1892	2448.37	1.29

- Recommended for consideration = 1.00 to 1.5 Lakhs / Ha
- No.of water user society formed ...14
- Energy and other charages....Rs.8000/ acre
- Around 1300 ha irrigated out of which 700 ha Drip for horticulture

#### Details of Pipe Distribution Network :

Sr. No	Main Canal /Branch Canal	Discharge cum/sec	Pipe Dia in mm	Type of Pipe	Length in km	Gradient of Pipeline	Velocity m/sec.	Total ICA Ha	Total Cost Rs Lakh	Cost / Ha
<b>Bhoze Gravity Main</b>										
<b>A</b>	Main Canal /Branch Canal									
<b>1</b>	Bhoze Gravity Main	2.17 to 0.05	1700 to 350	P.S.C.	19.80	1 in 1328	1.07 to 0.52	4581	5651.57	1.23
<b>B</b>	Distributory & Minors									
<b>a</b>	Malgaon Main	0.72 to 0.03	1000 to 350	P.S.C.	5.17	1 in 250	1.001 to 0.312	765	616.14	0.81
	Sub Mains on Malgaon Main	0.135 to 0.055	450 to 350	P.S.C.	6.18	1 in 141 to 1 in 75	0.936 to 0.312	396	534.88	1.35
<b>b</b>	Kalambi Main	0.52 to 0.03	900 to 350	P.S.C.	5.26	1 in 133	0.916 to 0.312	518	548.62	1.06
	Sub Mains on Kalambi Main	0.08 to 0.03	350	P.S.C.	3.93	1 in 169 to 1 in 115	0.832 to 0.312	179	282.97	1.58
<b>c</b>	Sub Main-7	0.865 to 0.03	1100 to 350	P.S.C.	7.05	1 in 181	0.962 to 0.312	978	999.08	1.02
	Sub Mains on Sub Main-7	0.270 to 0.03	600 to 350	P.S.C.	8.45	1 in 339 to 1 in 47	0.955 to 0.312	430	634.29	1.48
<b>C</b>	Minors									
	Direct Sub Mains (Total - 14 No.)	0.240 to 0.03	600 to 350	P.S.C.	27.08	1 in 130 to 1 in 35	1.196 to 0.312	1892	2448.37	1.29

### 3. Tajnapur Lift Irrigation Scheme-Stage-II, Maharashtra (Tal:- Shevgaon Dist. :- Ahamadnagar Distribution System)

- Scheme is Designed based on , on-demand system, as per Clements theory.
- Chak Size of 8 ha is Designed. Total 6960 ha area will be irrigated through 873 outlets.
- Distribution system is divided in to Nine Zones.
- Out of total 873 Outlets , maximum 374 Outlets will be in operation@ a time. Discharge for each Outlet 8.30 Lps.
- Secondary Pumping for Drip irrigation (For 8 Zones out of 9 Zones).
- Discharge for Chak – 8.30 LPS
- Water to every 8 Ha. Chak Area
- Division of Chak in to 12 to 16 sections.
- Main pipe Dia. And Sub Main Pipe dia,100 mm and 90 mm resp. In PVC
- Dripper capacity, 4 litre per hour.
- Distance between Dripper is 0.60m.
- Filter System to every Chak (Sand Filter and
- Screen Filter) Capacity 40 Cum/hr.
- Fertigation Capacity -30 Cum/hr.



### 7. MEGA LIFT IRRIGATION PROJECTS, CLUSTER NOS. - XII, SUNDERGARD AND JHARSUGUDA, ODISHA

Execution of 16 nos. of Lift Irrigation Schemes with intake points in Ibb, Sapei and Basundhara river having Command area between 500Ha. to 2000 Ha. in Cluster No. XII in the district of Sundergarh and Jharsuguda including its distribution network, up to 4 Ha Chak having total planned Culturable Command Area of 21,300 Ha. on “EPC –Turn Key” basis including power system connectivity and Operation & Maintenance of complete commissioned schemes for five years

**Details of works covered in the Scope of Work for each LI Scheme under the cluster is as below:**

1. Intake works in the river with RCC pipe up to the Pump house including all river protection works.
2. Constructing Pump House with Panel Room & Operating rooms.
3. Approach roads to Pump House.
4. Ductile Iron Pipeline for Transmission of Water up to delivery chamber (optional), Surge Control Devices / Water Hammer Control Devices, other appurtenances.

5. Delivery chamber (optional) and the Irrigation Distribution Network through Ductile Iron (from 300 mm diameter to 1200 mm diameter) and HDPE pipes (below 300 mm diameter).
6. O & M for Civil, Mechanical & Electrical Works for 5 years

Location	Sundergarh and Jharsuguda Districts, Odisha
Area Irrigated, ha	21,300
Total Water Requirement(MCM)	20.3 cumec
Area irrigated(in ha) per MCM	21,300 ha (Total CCA)
Water Source	Ibb, Sapei and Basundhara River
Project Cost	594.99 Crore
Cost per ha	Rs. 2.79 Lakh
Operational cost per acre	Not known
Date of commencement	NIT No. 4877 (Bid identification no. 2 ML/2016-17) dtd. 15-07-16
Period for Completion	30 months
Maintenance Contract	5 Years
System Type	Mega Lift Irrigation
Status	Under Execution

#### 8. MOHANPURA MAJOR PROJECT, RAJGARH, MADHYA PRADESH

Supplying of water from Left bank Rising main system and delivering at farmer's field through the various junctions/off takes from left bank rising mains by pressurized pipeline system for micro irrigation and in the Culturable command area of 87000 hectare out of gross command area 135250 hectare (the entire compact and contiguous possible arable area should be fully covered and any arable area found in excess should be dropped at the tail end) indicated in the index map for Left Bank Micro Irrigation system under Mohanpura Project. It includes all activities starting from survey, investigation, designing, procurement, construction, laying, installing, energizing, etc of pumping system ,rising and gravity mains , main line, branch lines, distribution network ,controlling and regulation system etc for supply of water for irrigation under pressure.

Location	Rajgarh District, Madhya Pradesh (latitude & Longitude of any off take point)
Latitude	76 deg / 46 min / 37sec E
Longitude	23 deg / 57 min / 54 sec N
Area Irrigated, ha	87,000
Total Water requirement(MCM)	0.35 lt /sec /Ha
Area irrigated(in ha) per MCM	87,000 Ha (Total CCA)
Project Cost	976.97 Crore
Cost per ha	Rs. 1.12 Lakh
Date of start	NIT no.7578 dated 06.02.2017
Bid Submission date	16.05.2017
Period from Completion	36 months
System Type	Pressurized Pipeline for Micro Irrigation
Status	Under Execution

*Note : All pipes of 300 mm dia and above – Ductile Iron / Mild Steel  
Pipes less than 300 mm dia - Ductile Iron / Mild Steel / HDPE*



## 9. SARDAR SARVORAR (NARMADA PROJECT)

- 75% Draught Prone area is covered under Narmada command
- Out of allocated water share of 9.0 MAF, 7.94 MAF for Irrigation (88.23%), 0.86 MAF (9.55%) for Domestic and 0.2 MAF (2.22%) for Industrial use.
- The Project is Supplying Drinking water to 9490 villages and 173 urban centers.

Failure due to :

- Micro level Land fragmentation
- Drainage issues
- Obstruction in Transportation path

### **Milestone achievement in the history of irrigation.**

- Total 6.17 lakh hectare area in 1 ½ Years is covered under UGPL Subminor by June 2016.
- Against, total 20.80 Lakh Hectare area have been covered by Subminor/field channel etc. in 11th Five Years Plan. (website of MoWR,RD& GR)

### **Issue Faced And Policy Decesion Taken To Achieve The Milestone -Main Recommendations Made By Expert Group (2010)**

- Conventional open channel should be adopted for Sub-Minors except for the topographical constraints (UGPL).
- SSNNL should acquire land for Sub-Minors by paying compensation.
- SSNNL should adopt the Micro Irrigation System [MIS] at the Subchak level.
- PPP model should be adopted for MIS
- Pilot Project in area like Rajasthan can be done for study
- Report of the Expert Group for Strategy for the Accelerated Development of SardarSarovar Project Command Area, May 2010
- Chairman : Shri B. N. Navalawala, Adviser (WR) to Hon'ble Chief Minister
- Report of the Expert Group for Strategy for the Accelerated Development of SardarSarovar Project Command Area, May 2010



Connecting the Last Mile through Underground Pipelines

#### **Milestone achievement in the history of irrigation.**

- Total 6.17 lakh hectare area in 1 ½ Years is covered under UGPL Subminor by June 2016.
- Against, total 20.80 Lakh Hectare area have been covered by Subminor/field channel etc. in 11th Five Years Plan. (website of MoWR,RD& GR)

#### **Issue Faced And Policy Decesion Taken To Achieve The Milestone -Main Recommendations Made By Expert Group (2010)**

- Conventional open channel should be adopted for Sub-Minors except for the topographical constraints (UGPL).
- SSNNL should acquire land for Sub-Minors by paying compensation.
- SSNNL should adopt the Micro Irrigation System [MIS] at the Subchak level.
- PPP model should be adopted for MIS
- Pilot Project in area like Rajasthan can be done for study
- Report of the Expert Group for Strategy for the Accelerated Development of SardarSarovar Project Command Area, May 2010
- Chairman : Shri B. N. Navalawala, Adviser (WR) to Hon'ble Chief Minister
- Report of the Expert Group for Strategy for the Accelerated Development of SardarSarovar Project Command Area, May 2010

#### **Major Challenge for Speedy completion of Sub-Minors**

#### Pre-Policy Scenario 2012

- Sub-Minors of 38,000 km / 13.7 lac ha to be executed
- 19,000 ha land to be acquired for Sub-Minors – without any compensation as per extant Policy
- 3 lac farmers will be affected against 86,000 beneficiary farmers by fragmentation of farmland upto Minors
- Availability of borrow areas / contractors / laborers for canal construction ?
- Implementation period of about 6 - 7 years
- Poor response for participation by beneficiaries Pilo
- Flood Prone Delta Region of Sabarmati River–UGPL Distributaries/Minors/Sub-Minors of Dholka Branch Canal for about 30,000 Ha area is partially completed.
- Draught Prone Region Near Tharad for about 5000 Ha Area is completed.

#### Results of Pilot Projects is found satisfactory

- Consultation with Beneficiary Farmers after finalizing Chak and Sub-chak(>2,80,000 so far)
- Fixing the UGPL Alignment and locations of Turnouts
- Preparation of Drawings
- Preparation of Estimates
- Technical Sanction to the Estimates
- Collecting 2.5% contribution from the Beneficiary Farmers
- Issuance of Letter of Intent (LOI)
- Issuance of Work Order
- Tri-partite Agreement (Farmers, Agency & SSNNL)
- Payment of 5% Security Deposit by the Agency

#### Conclusion (Pumping at off-take point)

- Higher velocity is obtained.
  - Lower diameter of pipe is needed.
  - Depth of Cutting (Excavation) and pipe length is reduced.
  - Chances of Silting in underground pipe is Less.
  - Only one pump set is required instead of multi pump sets.
  - Saving in cultivable land at every turnout point.
  - Construction of well at turnout points is avoided.
  - Less maintains in long run of project.
  - Cost of construction of sub-minor can be reduced in between Rs 10000 to 17000 per hectare.
- a) To plan Chaks(40-60ha)/Sub-Chaks(5-8ha) suitable to Rotational Water Distribution Schedule (RWS).
  - b) Alignment of UGPL Sub minor is selected, crossing the contour to avail sufficient head to overcome frictional losses in pipe flow.
  - c) Turnout outlet is kept on highest point of subchak command as to serve the command area effectively.
  - d) As far as possible Length of Subminor is kept minimum without compromising the efficiency of UGPL network system

### Under Ground Pipe Line (UGPL) – Pilot Project



### Under Ground Pipe Line (UGPL) - Implementation



#### Input

- Sub chak name and its chainage.
- CCA of chak.
- Available FSL of Parent Canal.
- Ground Level at Turnout of Sub chak command.

#### Output

- Design Discharge of the Sub minor.
- Head loss due to friction in pipeline (Using Modified Hazen-William formula).
- Available FSL and Required FSL at Turnout point.
- Flow Condition of subminor i.e.Gravity Flow or Lift flow.
- Height of Well

**Diameter of pipeline was selected considering the following points:**

- a) Velocity was kept between 0.5-1.5 m/s.
- b) Height of well not to exceed 5.00 mt
- c) To ensure priority for Gravity flow condition with minimum diameter
- d) In Lift condition minimum diameter is ensured with in the allowed height of well (about 5.00mt) and maximum velocity.
- e) L-Section of Sub-Minor is generated at 30 m intervals.

**10. SOLAR POWER COMMUNITY MICRO-IRRIGATION PROJECT, HOSHIARPUR, PUNJAB**

- i. Largest Solar Powered lift-cum-micro irrigation project in the world.
- ii. Total cost of Rs. 40.94 Crores.
- iii. Gross area 734 hectare, out of which cultivable area is 664 ha for which assured irrigation will be provided using micro irrigation systems.
- iv. Will benefit 1200 farming families in 14 villages.
- v. Project divided into 5 sub-schemes, which have been further divided into 18 zones of about 35-40 ha area each.
- vi. Total 15.7 cusecs water to be lifted from Kandi Canal at three different locations.
- vii. 3798 solar panels generating 1.1 MW are powering 46 solar pumps of 15 to 23 hp capacity
- viii. Irrigation to be provided through micro irrigation system only
- ix. Each section will have an automatic valve, connected to a centralized controller to control the supply period to the farmers.
- x. 9 village ponds in command area to be used as storage tanks.
- xi. The system designed to run for 8-10 hours a day. However, during summer when water requirement is more, the day length is also more.
- xii. Distribution system consists of 7.3 kms long underground HDPE pipes with diameter varying from 450 mm to 180mm
- xiii. 60 kms PVC line to be laid down for distribution of water to individual sections having an area of 2-2.5 ha each.

- xiv. No power bill for the farmers, project to be operated and maintained by Department of Soil and Water Conservation, Punjab in association with the executing entity i.e. Jain Irrigation Systems Limited for seven years.
- xv. The beneficiaries farmers have been organized into a Water User Association (WUA) which can even have an arrangement with the PSPCL to purchase power during low demand periods.

#### 11. TIKTOLI DISTRIBUTARY PIPE IRRIGATION PROJECT BY GRAVITY FLOW, GWALIOR, MADHYA PRADESH

- i. Location: Hastinapur Village, Morar Tehsil, Gwalior District (MP)
- ii. Cultural Command Area of 3170 hectares
- iii. Benefited Villages: 40 Nos
- iv. Proposed Crops: Wheat, Gram & Mustard
- v. Head Discharge: 1.427 Cumec
- vi. Supply of water for irrigation upto 1 ha Chalk under gravity pressure
- vii. Source: Harsi High Level Canal (with discharge capacity of 10.94 cumec and FSD 1.75m)
- viii. Minimum dia of carrier pipe 1100 mm
- ix. Pipe material ; PCCP/Spirally Wound PE/PP Pipes (Generally Conforming to IS-16098 Part-2)
- x. Minimum residual head of 1.5m for 1 ha Chalk with duty 0.45 ltr/sec/ha. Discharge at 1 Hac Chalk head should be 10 times the specified duty.
- xi. Construction of underground pipe line and distribution network for micro-irrigation upto 1ha Chalk by gravity flow including inline structures, Scouring Sluices and other Miscellaneous works with On/Off Valves at every 2.5Ha Chak.
- xii. Estimated Cost Rs 3947.21 Lacs

## 12. INTERNATIONAL SCENARIO

### CHINA

China Could save 30 % of water delivered, 2-4% land, 25% labour input as compared to open canal system. *8.91 Mha under Piped irrigation ( 22% of total saved irrigation area), amounting to 15% of total irrigation area.*

#### Design standards:

- a) First Stage: Working pressure maintained at <0.2 MPa, Applicable for low pressure pipe irrigation schemes with ground water as source.
- b) Second Stage: Working pressure maintained at <0.4 MPa, Applicable for low pressure pipe irrigation schemes. (Applied to well irrigation schemes, pumping irrigation schemes & gravity irrigation schemes in mountainous regions for command area < 80 Ha).
- c) Third Stage: Working pressure maintained at <1.0 MPa & Outlet pressure at most unfavorable pt. not to exceed 0.02 MPa. Applicable for new expanded and rebuilt pipe irrigation projects.

#### Choice of pipe material:

- a) If pipe internal dia < 400 MM (PE(Polyethylene pipes) to be used.
- b) If pipe internal dia > 400 MM (Concrete Pipes, PRC, GRP (Glass fibre reinforced plastic), DIP (Ductile Iron Pipes) to be used.
- c) Nominal pressure of chosen pipe material should not be less than the sum of design working pressure and water hammer pressure.
- d) When the sulphate concentration in soil exceeds 1%, concrete pipes and metal pipes should not be used.

#### Technical Parameters Followed:

- a) Probability of irrigation water requirement should not be lower than 75%.
- b) Design value of pipe network water efficiency should not be lower than 0.95.
- c) Design value of water efficiency at farm level should not be lower than 0.90, for rice irrigation, not lower than 0.95.

### AUSTRALIA

## GOULBURN-MURRAY WATER (GMW) IRRIGATION PROJECT OVERVIEW

- a) Operational Area – GMID = 11,000km<sup>2</sup>
- b) GMW Connections is the largest irrigation modernisation project in Australia.
- c) \$2 billion investment to create a more efficient automated water delivery network and deliver improved customer service levels
- d) upgrading and automating backbone channels and meters
- e) reducing the size of the channel network
- f) reconnecting properties to the upgraded backbone channel system through individual and shared connections
- g) funded by the Commonwealth and Victorian Governments most significant upgrade to the region's irrigation infrastructure in 100 years.
- h) When complete, average annual water savings of 429GL will be achieved and irrigation water use efficiency will be increased from about 70 per cent to 85 per cent.
- i) investigating and delivering special environmental projects
- j) reducing the increase in GMW infrastructure to minimize whole of life costs and customer prices
- k) boosting regional economies





## **PART-II**

### **OUTLET TO FIELD**

*This Part covers the Portion below the Outlet to Field / Micro Irrigation i.e. below Minor Pipeline up To Micro Irrigation System in the Field*



## CHAPTER-11

# OUTLET TO FIELD

### 11.1 General

The purpose of providing piped network is to provide timely and adequate supply of water to each holding by avoiding seepage and leakages through open channels.

In comparison to canal network/flow irrigated areas, piped network systems clubbed with Drip or Sprinkler irrigation systems depending upon the type of crop offer following advantages:

- a) Higher crop productivity
- b) Higher water use efficiency
- c) Reliable water supply
- d) Uniformity of water application:
- e) No land acquisition
- f) No land levelling required
- g) Faster implementation time

### 11.2 Formulation of Guidelines for Pressurised Piped Network

Govt. of India is now giving emphasis on implementation of pressurized piped irrigation system in all canal commands. For appraisal of

irrigation projects with piped irrigation (drip & sprinkler systems), guidelines are required. The guidelines for the pressurised piped network below minor- i.e. outlet onwards, sump pump and pressure points for different chak sizes have been described below.

### 11.3 Major Components:

- a) Water storage tank
- b) Pumping unit
- c) Filtration unit
- d) HDPE pipe network
- e) Hydrant/Outlet assembly
- f) Sprinkler irrigation system

The sequence of the above components are depicted in the picture shown below ( *Figure-11.1*).

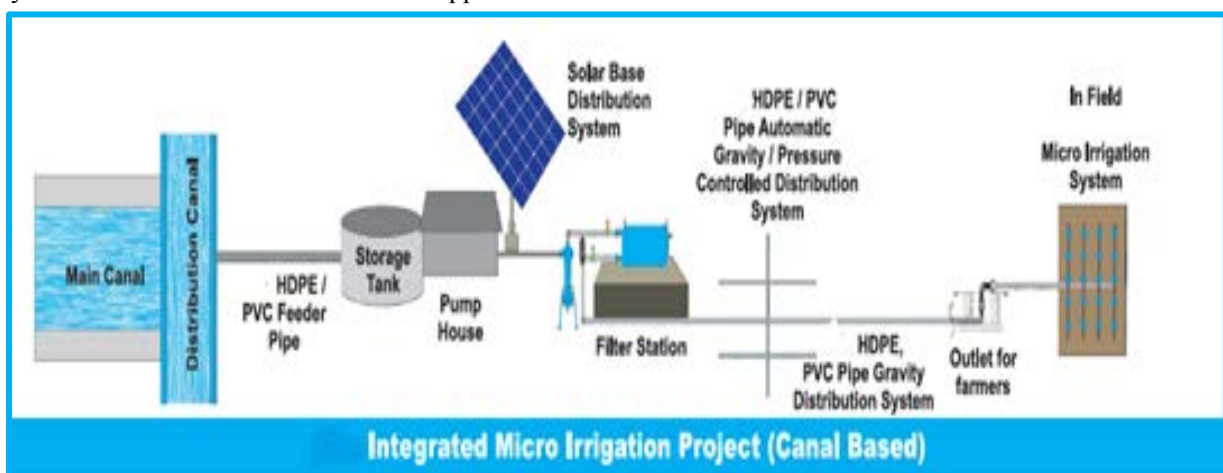

Figure 11.1 Systematic layout of the components

### 11.4 Water storage tank

Water from outlet will be delivered into storage like sump/pond to regulate the supply of water in the field through drip or sprinkler system. Ideally, large storage should be created near the outlet(s) so as to provide higher flexibility in operation. However, the land is precious resource and sump size needs to be optimised. One open tank on the surface or an overhead tank depending upon the topography and economic considerations may be provided nearby Minor outlet. Presently, canals and branches are designed for a 14 days rotation (irrigation interval may vary) including a 12 day running and a 2 day closure. The objective of the storage tank is to provide the storage and good flow condition to the pump. Depth of underground tank may be approximately 2m and plastic mulching may be provided to avoid any seepage. *However, the possibility for construction of the overhead tank should also be explored.* A typical picture of storage tank is shown in *Figure-11.2*.



Figure 11.2 Water storage tank

### 11.5 Pumping unit

Pumping unit is essential for supplying the water under pressure to the system and to maintain residual pressure at each node/nozzle/dripper. Sometimes, special electrical lines need to be provided to supply electricity to pumping units along the canal. An alternate could be a Solar

Pumping System to lift the stored water from tank through pipelines.

In case of solar pumping system, per day irrigation time may be approximately 8 to 10 Hrs. The advantages of solar pumping are given below :

- Solar energy is available in abundance.
- Works independent of grid availability
- No running costs.
- Good quality and reliability
- Easy to install
- Low maintenance
- Environment friendly, free from noise and pollution.
- Suitable for low yielding bore wells

A typical picture of pumping unit with solar system is shown in *Figure-11.3*.



Figure 11.3 Pumping unit with solar system

### 11.6 Filtration unit

It helps infiltration of water for micro irrigation to prevent clogging due to physical and biological impurities present in the water source. There are many types of filters like Sand filter, Disc filter etc. Type of filter should be selected keeping in view the water quality and type of sediments. Specifications should confirm to relevant BIS codes (Annex-III). A typical picture of filtration unit is shown in *Figure-11.4*.



Figure 11.4 Filtration unit

### 11.7 Piped line distribution network

HDPE (High Density Polyethylene) or some other material pipeline for water conveyance from water storage tank up to hydrant / outlet may be used which should be buried at least 3 feet below the surface.

The BIS code for HDPE pipes is IS4984:1995. However, pipe material may be adopted depending upon topography, available hydraulic head and the cost involved as per the provisions given in relevant BIS codes. A typical picture of Piped line distribution network is shown in Figure-11.5.



Figure 11.5 Piped line distribution network

### 11.8 Hydrant/Outlet assembly

Hydrant / Outlet assembly should be provided at field level for irrigation. The minimum required pressure (2.5 to 3 kg/cm<sup>2</sup>) should be maintained on each Hydrant/Outlet to operate both types of micro irrigation systems (Sprinkler/Drip). A typical picture of Hydrant / Outlet assembly is shown in Figure-11.6.



Figure 11.6 Typical picture of Hydrant / Outlet assembly

### 11.9 Estimation of horse power of pumping unit

After finalization of dimensions of main, sub-mains and laterals, the pump capacity may be decided as per the procedure explained below.

Total pressure head drop in meters due to friction ( $H_f$ ) = Friction head loss of main + Friction head loss of sub-mains + friction head loss of laterals.

The frictional head loss may be calculated by Hazen William's formula given as under:

$$H_f = \frac{10.67Q^{1.85}L}{C^{1.85}d^{4.87}}$$

Where,

$h_f$  = Head loss in metre (water) over the length of pipe

$L$  = Length of pipe in metre

$Q$  = Volumetric flow rate in m<sup>3</sup>/s

$C$  = Pipe roughness coefficient

Rabi (Drip Irrigation)		Kharif (Sprinkler Irrigation)	
Crop	Area (ha)	Crop	Area(ha)
Wheat	2500	Paddy	2000
Pulses	1000	Maize	1700
Vegetables	500	Groundnut	550
Barley	500	Vegetables	750
Mustard	500		
<b>Total</b>	<b>5000</b>	<b>Total</b>	<b>5000</b>

$d$  = Inside diameter (m)

Table- 11.1 Cropping pattern for Rabi & Kharif

Operating pressure head required at the dripper =  $H_e$  in meters.

Total static head (The algebraic sum of static suction head and static discharge head) =  $H_s$  in meters

Total Pumping Head ( $H$ ) =  $H_f + H_e + H_s$

Discharge of main =  $d_m$  litres / sec

Efficiency\* (overall) = (50% in the case of electric pump, 40% in the case of diesel pump)

Capacity of the pump (in Horsepower)  

$$= \frac{H \times d_m}{75 \times e}$$

(\*Efficiency may vary depending upon the type and make of the pump)

### 11.10 Model Computations for 5000 Ha Command Area

For design of the system, following steps are to be followed:-

#### 11.11 Estimation of Peak Crop Water Requirement

Penman-Monteith equation should be used for computing evapotranspiration. However, Modified Penman method may be used where extensive data is not available. CROPWAT, a decision support tool developed by the Land and Water

Development Division of FAO may be used for the calculation of crop water requirements based on soil, climate and crop.

Model computations for 5000 ha areas have been carried out to design the water tank and pumping capacity. Following cropping patterns shown in the table-1 have been adopted to compute the peak water requirements in Rabi and Kharif season.

Field application efficiency has been adopted as 90% in case of drip and 75% in case of sprinkler irrigation. The total water requirement has been computed and details are enclosed as **Annex-I (for Rabi season with drip irrigation) and Annex-II (for Kharif season with sprinkler irrigation)**. The peak water requirement works out as 5.56cumec.

#### 11.12 Size of Storage Tank

Therefore, the micro irrigation system shall be designed for the maximum requirement of 5.56 cumec during the Kharif season.

Water required for one day =  $5.56 \times 24 \times 3600 = 4,80,384$  cum say 4,80,000 cum

A tank of 4,80,000m<sup>3</sup> capacity can be provided.

Keeping the depth of the tank as 2.0 m, the size works out as 600m X 400 m. There may be multiple storage tanks depending upon the availability of land and site conditions.

#### 11.13 Capacity of Pump

If the average working hour of pump set is taken as 8 hours per day (may vary depending upon power availability) so that uninterrupted irrigation may continue for 8 hours even in areas where power shut - offs are frequent, the discharge required would be as below:

Pumping rate =  $5.56 \times 24 / 8 = 16.68$  cumec or say 16680 litre per sec (lps)

S. No.	Total static head	In (m)
1	Depth of water in the tank	2
2	Outlet level above ground level	3
3	Friction loss in pipes, bends, foot valves etc. (Depending upon the type of pipes, dia etc.)	2 (assumed)
4	Friction loss in fertigation and filtration	2
5	Minimum operating head required	30 m (For sprinkler 2.5 kg/cm <sup>2</sup> to 3 kg/cm <sup>2</sup> )
	<b>Total</b>	<b>39 m</b>

Table-11.2 Parameters to compute capacity of pump

The HP of pumpset required is based upon design discharge and total operating head. The total head is the sum of total static head and friction losses in the system as shown below in the table-2.

Capacity of the pump (in Horsepower)=

$$\frac{16680 \times 39}{75 \times 0.5} = 17347 \text{ say } 17350 \text{ HP}$$

#### 11.14 Micro-Irrigation system

These systems are basically tailor made and their design depend on area to be irrigated, type of crop, crop spacing etc. In this regard, the detailed operational guidelines have already been evolved by National Mission for Micro Irrigation (NMMI) under Ministry of agriculture, Govt. of India during year 2010.

All the spare parts must confirm to the relevant BIS codes (**Annex-III**).

## APPENDIX

Annex-I

## Crop Water requirements for Rabi season (Drip Irrigation)

Month	days	Wheat		Pulses		Vegetables		Barley		Mustard		Total	
		Area (In ha)	Water need (cumec)	Area (In ha)	Water need (cumec)	Area (In ha)	Water need (cumec)	Area (In ha)	Water need (cumec)	Area (In ha)	Water need (cumec)	Area (In ha)	Water need (cumec)
1	2	3	4	5	6	7	8	9	10	11	12	13	14
Oct-I	1 to 10		0		0		0	0	0	0	0	0	0
Oct-II	11 to 20		0		0		0	0	0	0	0	0	0
Oct-III	21 to 31		0		0		0	0	0	0	0	0	0
Nov-I	1 to 10	2500	0.12		0	500	0	500	0	500	0	4000	0.12
Nov-II	11 to 20	2500	0.57	1000	0	500	0	500	0	500	0	5000	0.57
Nov-III	21 to 30	2500	0.85	1000	0	500	0	500	0	500	0	5000	0.85
Dec-I	1 to 10	2500	1.05	1000	0	500	0	500	0	500	0	5000	1.05
Dec-II	11 to 20	2500	1.10	1000	0	500	0.17	500	0	500	0.11	5000	1.37
Dec-III	21 to 31	2500	1.19	1000	0	500	0.21	500	0	500	0.17	5000	1.56
Jan-I	1 to 10	2500	1.05	1000	0.12	500	0.19	500	0	500	0.19	5000	1.54
Jan-II	11 to	2500	1.02	1000	0.14	500	0.19	500	0	500	0.21	5000	1.55



	20												
Jan-III	21 to 31	2500	0.96	1000	0.00	500	0.22	500	0	500	0.25	5000	1.42
Feb-I	1 to 10	2500	0.56	1000	0.20	500	0.20	500	0.13	500	0.24	5000	1.32
Feb-II	11 to 20	2500	0.15	1000	0.33	500	0.05	500	0.22	500	0.25	5000	0.99
Feb-III	21 to 28	2500	0	1000	0.38	500	0	500	0.22	500	0.21	5000	0.80
Mar-I	1 to 10	2500	0	1000	0.63	500	0	500	0.31	500	0.21	5000	1.15
Mar-II	11 to 20	2500	0	1000	0.69	500	0	500	0.35	500	0.13	5000	1.16
Mar-III	21 to 31	2500	0	1000	0.83	500	0	500	0.41	500	0	5000	1.24
Apr-I	1 to 10	2500	0	1000	0.82	500	0	500	0.41	500	0	5000	1.22
Apr-II	11 to 20	2500	0	1000	0.70	500	0	500	0.37	500	0	5000	1.06
Apr-III	21 to 30	2500	0	1000	0.29	500	0	500	0.21	500	0	5000	0.49
May-I	1 to 10	2500	0	1000	0	500	0	500	0.05		0	4500	0.05
												<b>Max</b>	<b>1.56</b>

## Crop Water requirements for Kharif season (Sprinkler Irrigation)

Annex-II

Month	days	Paddy		Maize		Groundnut		Vegetables		Total	
		Area (In ha)	Water need (cumec)	Area (In ha)	Water need (cumec)	Area (In ha)	Water need (cumec)	Area (In ha)	Water need (cumec)	Area (In ha)	Water need (cumec)
1	2	3	4	7	8	9	10	11	12	13	14
May-III	21 to 31	2000	4.41	1700	0	550	0	750	0	5000	4.41
Jun-I	1 to 10	2000	5.56	1700	0	550	0	750	0	5000	5.56
Jun-II	11 to 20	2000	0.52	1700	0.081	550	0.04	750	0.09	5000	0.72
Jun-III	21 to 30	2000	0.36	1700	0	550	0	750	0	5000	0.36
Jul-I	1 to 10	2000	0.23	1700	0	550	0	750	0	5000	0.23
Jul-II	11 to 20	2000	0.05	1700	0	550	0	750	0	5000	0.05
Jul-III	21 to 31	2000	0.34	1700	0	550	0	750	0	5000	0.34
Aug-I	1 to 10	2000	0.15	1700	0	550	0	750	0	5000	0.15
Aug-II	11 to 20	2000	0.36	1700	0.14	550	0	750	0	5000	0.50
Aug-III	21 to 31	2000	0.03	1700	0.39	550	0.11	750	0.035	5000	0.56
Sep-I	1 to 10	2000	0.00	1700	0.03	550	0	750	0	5000	0.03
Sep-II	11 to 20	2000	0.09	1700	0	550	0	750	0	5000	0.09
Sep-III	21 to 30	2000	0.00	1700	0.07	550	0.05	750	0.17	5000	0.30
Oct-I	1 to 10	2000	0.00	1700	0	550	0.07	750	0	5000	0.07
Oct-II	11 to 20	2000	0.00	1700		550	0.12	750	0	5000	0.12
Oct-III	21 to 31	2000		1700		550	0.05	750	0	5000	0.05
										<b>Max</b>	<b>5.56 cumec</b>

**Annex-III**

The various BIS codes for different components of the system are tabulated as under-

<b>S.No</b>	<b>Component description</b>	<b>BIS code</b>
1	Polyethylene pipe for irrigation-Laterals with amendments number 5	<b>IS 127886:1989(reaffirmed 1998)</b>
2	Emitters	<b>IS 13487 : 1992</b>
3	Emitting pipes system	<b>IS 13488 : 2008</b>
4	Strainer type filters	<b>IS 13488 : 2008</b>
5	Irrigation equipment rotating sprinkler Part II, Test IS 12232 (Part II) Method for uniformity of distribution (1 <sup>st</sup> revision)(amendment 1)(including rain gun)	<b>IS 12232 (Part II) 1995</b>
6	Polyethylene micro tubes for drip system	<b>IS 14482:1997</b>
7	Fertiliser and chemicals injection system Part venture injector	<b>IS 14483(Part 1)</b>
8	Micro Sprayers	<b>IS 14605: 1998</b>
9	Media Filters	<b>IS 14606: 1998</b>
10	Hydro Cyclone separators	<b>IS 14743: 1999</b>
11	PVC pipes for water supply	<b>IS 4985 – 1999</b>
12	Irrigation equipment sprinkler pipes specifications IS 14151 (Part I)1999 Part I Polyethylene pipes	<b>IS 14151 (Part I) 1999</b>
13	Irrigation equipment sprinkler pipes specifications Part II quick couples Polyethylene pipes	<b>IS 14151 (Part II) 1999</b>
14	Quality of Irrigation water	<b>IS 11624 : 1986</b>
15	HDPE Pipes	<b>IS 4984 : 1995</b>
16	Moulded PVC Fittings	<b>IS 7834 : 1987</b>
17	GI and MS Fittings	<b>IS 1879 : 1987</b>
18	GM Valves	<b>IS 778 : 1984</b>
19	CI Non Return Valves	<b>IS 778 : 1984</b>
20	Fabricated PVC Fittings	<b>IS 10124 : 1988</b>
21	GI Pipes	<b>IS 1879 : 1987</b>
22	Sluice Valves	<b>IS 780: 1984</b>
23	PE Fabricated Fittings	<b>IS 8360: 1977</b>
24	PE Moulded Fittings	<b>IS 808: 2003</b>
25	PVC Foot Valves and NRV	<b>IS 10805: 1986</b>
26	Irrigation equipment rotating sprinkler Part I, Design and Operational requirements (1st revision)	<b>IS 12232 (Part I) 1996</b>
27	Design, Installation and Field evaluation of MIS	<b>IS 10799: 1999</b>
28	Prevention and treatment of blockages problems in drip irrigation systems	<b>IS 14791: 2000</b>

**No. 23/101/2016-PA(N)/ 822 -37**  
**Government of India**  
**Central Water Commission**  
**Project Appraisal (N) Directorate**

Email: panorth@nic.in  
 Phone: 011-26108026

Room No. 407(S), Sewa Bhavan  
 R. K. Puram, New Delhi-110066  
 26.04.2016

**Office Memorandum**

**Sub.: Constitution of Committee for Preparation of Guidelines for pressurised piped network in irrigation system-regd**

A Committee is being constituted to prepare guidelines for introduction of pressurised piped network instead of open canal network with micro irrigation in the project planning wherever feasible clearly bringing out the pros & cons. The preparation of guidelines is a multidisciplinary task which requires feedback from different States as well as agencies generally involved in this work area. As it is a recent concept, therefore no readymade guidelines/BIS standards are available in India. Keeping in view the importance of matter as well as participation of stakeholders, a Committee is constituted under the Chairmanship of Member, WP&P, CWC as per following detail.

**Composition:**

1.	Member WP&P, CWC	Chairman
2.	Chief Engineer, Design (N&W), CWC	Member
3.	Director, IARI, Min of Agri. & Far. Welfare, Govt. of India	Member
4.	Representative, Bureau of Indian Standards, Min. of Consumer affairs, Food & Public Distribution, Govt. of India	Member
5.	Representative, WRD, KNNL, Govt. of Karnataka	Member
6.	Representative, WRD, Govt. of Maharashtra	Member
7.	Representative, WRD, Govt. of Telangana	Member
8.	Representative, WRD, Govt. of Madhya Pradesh	Member
9.	Representative, WRD, Govt. of Rajasthan	Member
10.	Representative, SSNNL, Govt. of Gujarat	Member
11.	Representative, Jain Irrigation System Ltd.	Member
12.	Chief Engineer, PAO, CWC	Member Secretary

**Terms of Reference:**

- (i) Preparation of guidelines for introduction of pressurised piped network in the irrigation distribution system
- (ii) The Guidelines shall include detail guidelines covering chapters on all relevant aspects i.e. Feasibility aspects, design specifications for all components i.e. pump, pump house, line and sublines, sump well, pipe design criteria, power requirement, techno-economic criteria, limitations etc.
- (iii) This will also covers linkages with micro irrigation (sprinklers & drip), on farm development components etc.
- (iv) Committee will submit report within 4 months

The composition of Committee is not limited to above members only, and can co-opt any expert, if it is required. This issues with the approval of competent authority.

To,

1. Director, IARI, Deptt of Agricultural Research & Education, Min. of Agri. & Far. Welfare, Govt. of India, Hill Side Road, Pusa Campus, New Delhi, Delhi 110012
2. Director, Water Resources Division, Min. of Consumer affairs, Food & Public Distribution, Govt. of India, Manak Bhawan, Bureau of Indian Standards, 9 Bahadur Shah Jafar Marg, N Delhi-110002, with a request to nominate suitable officer not below the rank of Joint Secretary for this proposed Committee
3. Managing Director, Karnataka Neeravari Nigam Ltd., Govt. of Karnataka, Coffee Board House, Ambedkar Veedhi Road, Bengaluru with a request to nominate suitable officer not below the rank of Joint Secretary for this proposed Committee
4. Principal Secretary, Water Resources Department, Govt. of Maharashtra, Mantralaya, Mumbai-32 with a request to nominate suitable officer not below the rank of Joint Secretary for this proposed Committee
5. Principal Secretary, Water Resources Department, Govt. of Telangana, Irrigation & CAD Department, Government of Telangana, B-Block, 5<sup>th</sup> Floor, Telangana Secretariat, Hyderabad-500022 with a request to nominate suitable officer not below the rank of Joint Secretary for this proposed Committee
6. Principal Secretary, Water Resources Department, Govt. of Madhya Pradesh, Secretariat, Bhopal with a request to nominate suitable officer not below the rank of Joint Secretary for this proposed Committee
7. Principal Secretary, Water Resources Department, Govt. of Rajasthan, Secretariat, Jaipur with a request to nominate suitable officer not below the rank of Joint Secretary for this proposed Committee
8. Chairman cum Managing Director, SSNNL, Govt. of Gujarat, First Floor, Block No.12, New Sachivalaya Complex, Gandhinagar-382010 with a request to nominate suitable officer not below the rank of Joint Secretary for this proposed Committee
9. Representative, Jain Irrigation System Ltd.

Copy for kind information to:

1. Sr PPS to Secretary, MoWR, RD&GR, New Delhi.
2. PPS to Special Secretary, MoWR, RD&GR, New Delhi.
3. PPS to Chairman, CWC, New Delhi
4. PPS to Member WP&P, CWC, New Delhi
5. Commissioner (SP), MoWR, RD&GR, SS Bhawan, Rafi Marg, New Delhi
6. Chief Engineer, PAO, CWC, New Delhi
7. Chief Engineer, Design (N&W), CWC, New Delhi

## COMPOSITION OF THE COMMITTEE

### CHAIRMAN

1. Sh. S.Masood Husain, Member (WP&P), Central Water Commission.

### MEMBERS

2. Sh. T.K. Sivarajan, Chief Engineer, Design (N&W), CWC.
3. Sh.Navin Kumar, Chief Engineer, IMO, CWC.
4. Chief Engineer, PAO, CWC – Member Secretary of the Committee
5. Dr. Manoj Khanna, Principal Scientist, WTC, IARI, New Delhi.
6. Sh. Pawan, Bureau of Indian Standards(BIS), New Delhi.
7. Sh. R. Cheluvvaraju, Chief Engineer, WRD, KNNL, Govt. of Karnataka.
8. Sh. V. M. Kulkurni, (Representative, WRD, Govt. of Maharashtra).
9. Representative, WRD, Govt. of Madhya Pradesh.
10. Representative, WRD, Govt. of Telangana.
11. Sh. Vinod Shah, WRD, Govt. of Rajasthan.
12. Sh. K.B. Parmar, Chief Engineer, SSNNL, Govt. of Gujarat.
13. Sh. Somnath Jadhav, Sr. Vice President, (Representative, Jain Irrigation System Ltd.)

### SPECIAL INVITEES:

1. Mr.Surinder Makhija, Jain Irrigation, New Delhi.
2. Mr.B.K.Labh,V.P, Jain Irrigation, New Delhi.
3. Mr.Hemant Dhumal, Superintending Engineer, Pune,(WRD Maharashtra)
4. Mr.Sabarna Roy, Electrosteel Castings Limited, Kolkata.
5. Mr.Sudipto Lahiri, Electrosteel Castings Limited, Kolkata.
6. Mr.Rajan Patil, Jindal SAW Limited, Maharashtra.
7. Mr.Maneesh Kumar, Jindal SAW Limited, Maharashtra.

---

## REFERENCES

- i) *IS 11639 (Part 1) : 1986 - Structural Design of Penstocks*
- ii) *IS 5822 :1994 - Code of Practice for Laying of Electrically Welded Steel Pipes for Water Supply*
- iii) *IS 10698(Part 2):2013 Structured-Wall Plastic Piping Systems.*
- iv) *Part 636 Structural Engineering – National Engineering Handbook issued by US Department of Agriculture (Chapter 52 – Structural Design of Flexible Conduits)*
- v) *ISO 10803 : 2011*
- vi) *TR4 : Plastic Pipe Institute*
- vii) *Manual on water supply and treatment by central public health and environmental engineering organization (CPHEEO) under Ministry of Urban Development*
- viii) *Book on Water supply engineering by S.K. Garg.*
- ix) *Rural Irrigation System design standards code of practice of Australia*
- x) *IS 11750-1985 Criteria for Hydraulic Design Of Irrigation Intake Structures*
- xi) *Pipe Distribution System for Irrigation Manual by INCID (1998)*
- xii) *FAO Irrigation and Drainage Paper 44 “Design and Optimization of Irrigation Distribution Networks”,1988*
- xiii) *FAO Irrigation and Drainage Paper 59 “Performance Analysis of On-demand Pressurized Irrigation Systems”,2000*
- xiv) *PIN Workshop (held in March 2017 at CWC) presentation material*





## **CONTACT INFORMATION**

**CHIEF ENGINEER,  
DESIGNS(N&W) UNIT  
CENTRAL WATER COMMISSION  
SEWA BHAWAN, RK PURAM  
NEW DELHI-110 066  
Ph:011-26100806**

**CHIEF ENGINEER,  
IRRIGATION MANAGEMENT ORGANISATION  
CENTRAL WATER COMMISSION  
SEWA BHAWAN, RK PURAM  
NEW DELHI-110 066  
Ph:011-26195519**

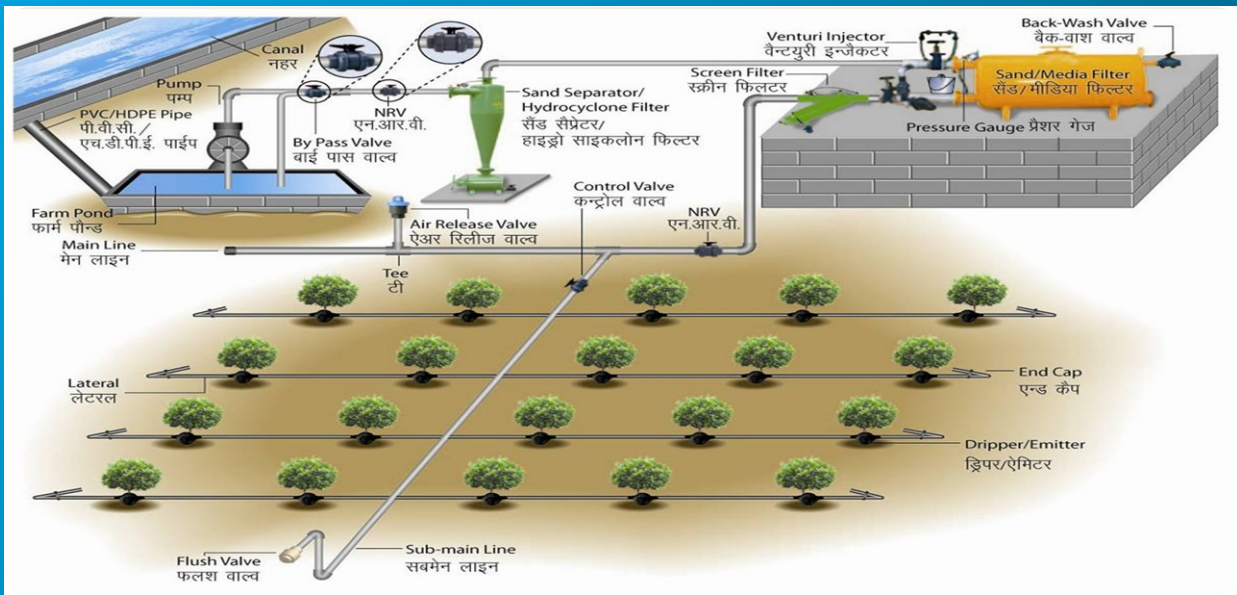
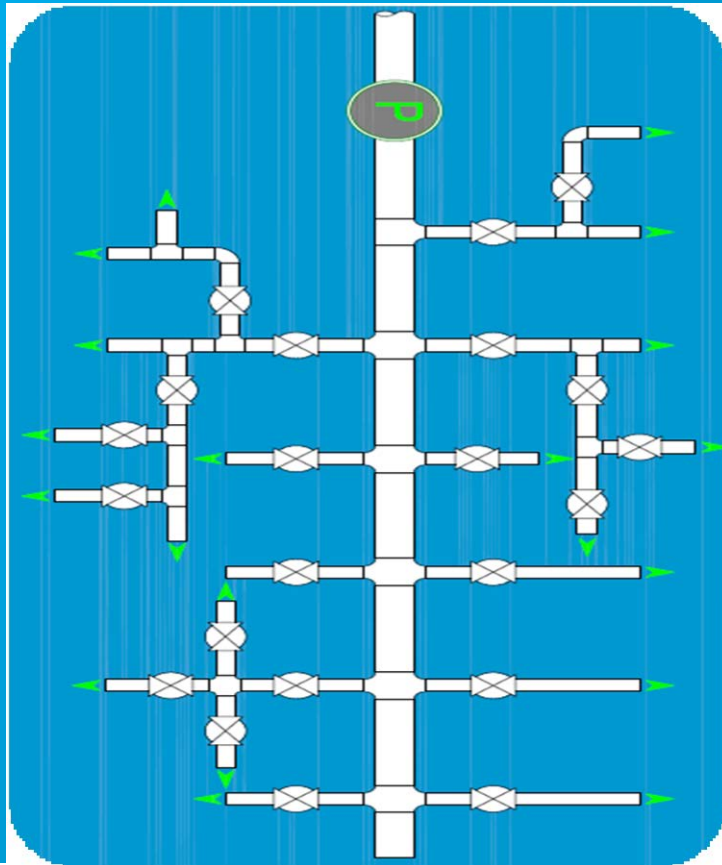

CENTRAL WATER COMMISSION  
 MINSITRY OF WATER RESOURCES, RIVER DEVELOPMENT & GANGA REJUVENATION  
 GOVERNMENT OF INDIA  
 NEW DELHI