

AT MICROFICHE
REFERENCE
LIBRARY

A project of Volunteers in Asia

Earth for Homes

Published by:

Office of International Affairs
US Department of Housing and Urban Development
Washington, DC 20410 USA

Available only in microfiche; free to serious
groups in developing countries.

Available from:

Office of International Affairs
US Department of Housing and Urban Development
Washington, DC 20410 USA

Reproduction of this microfiche document in any
form is subject to the same restrictions as those
of the original document.



Earth for homes —

Prepared for the **AGENCY FOR INTERNATIONAL DEVELOPMENT**
By the **U.S. DEPARTMENT OF HOUSING AND URBAN DEVELOPMENT**
Office of International Affairs, Washington, D.C. 20410

March 1955

Earth for homes

Prepared by

Department of Housing and Urban Development
Office of International Affairs
Washington, D. C. 20410

for the use of
United States A.I.D. Missions

Third Printing
Revised September 1956
Reprinted May 1969
Reprinted June 1970
Reprinted October 1974

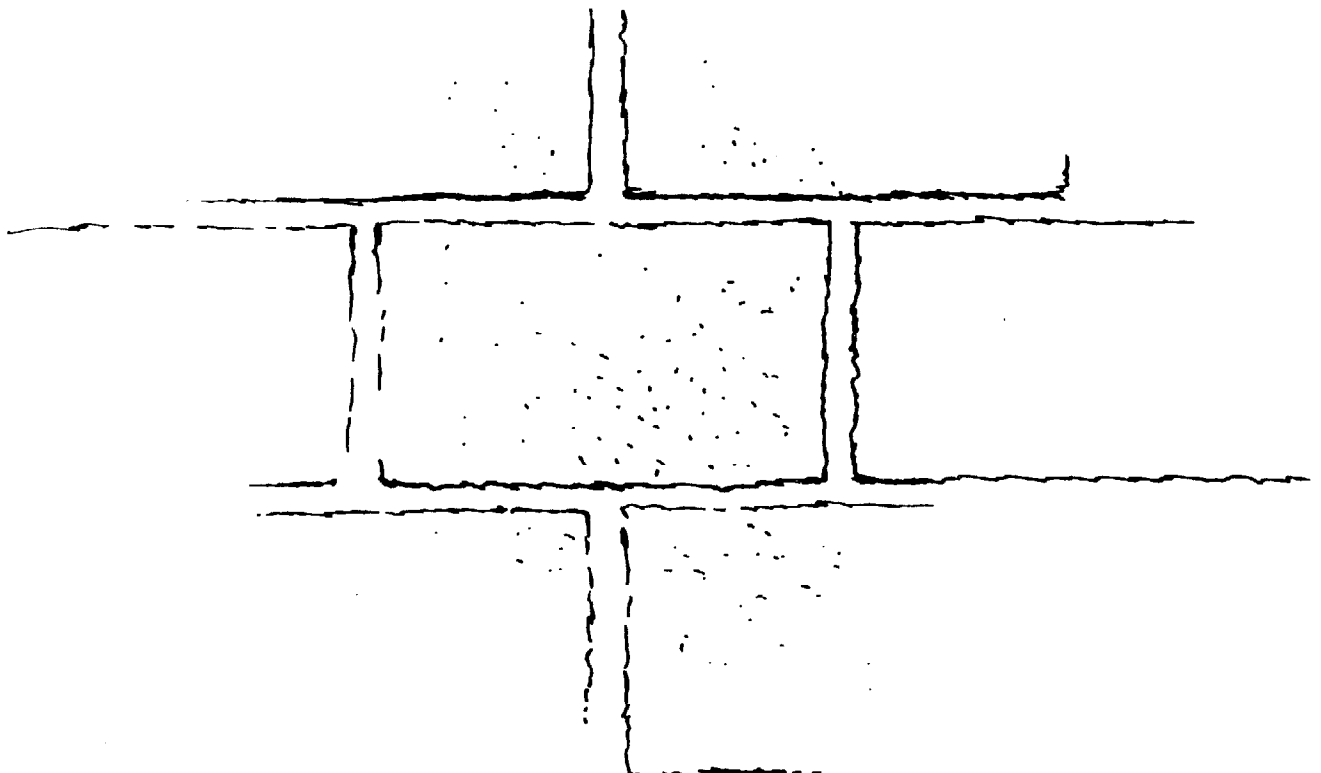

CONTENTS

	Page
List of Illustrations	iii
Foreword.....	iv
Acknowledgments	v
Introduction.....	vi
 Chapters	
I. Early Uses of Earth.....	1
II. Soils	
General	3
Simple Tests	4
III. Methods of Earth Wall Construction	
General	7
Determination of Some Properties of Earth for Construction.....	8
Compression	8
Modulus of Rupture.....	8
Absorption	9
Erosion	9
Wattle and Daub	9
Cob.....	10
Poured Adobe or Mud Concrete.....	11
Adobe Brick.....	11
Soil Rating Chart for Adobe Brick	13
Earth Nogging and Cajon.....	18
Rammed Earth.....	19
Pressure Compacted Machine Made Blocks.....	24
IV. Stabilization of Earth by Admixtures.....	29
General	29
Simple Tests for Weather Resistance.....	31
Stabilization of Adobe.....	31
Stabilization of Rammed Earth and Pressure Compacted Blocks	35
Stabilization of Cob Constructions	37
V. Earth Floors	
Soil-Cement Floors	39
The Oil-Surfaced Floor	40
VI. Earth Roofs	
Adobe or Mud Roofs.....	42
Mud Brick Roofs	43
Elliptical Rammed Earth Roof	43
Experimental Domed Roof of Stabilized Cob Construction.....	43

CONTENTS--Continued

	Page
VII. Wall Finishes	
Introduction.....	44
Heavy Rain Test.....	45
Cement and Lime Stucco.....	45
Dagga-Mud Plaster.....	47
Mud Paint.....	48
Wall Paints.....	48
Interior Finishes.....	49
Pozzolana.....	50
A Test of Paint Finishes.....	50
VIII. The Design of Earth Walls	
Common Properties of Earth.....	51
Design Considerations.....	52
General Design Practices.....	52
In Earthquake Areas.....	54
Appendix A.--Glossary.....	55
Appendix B.--Bibliography of Earth Construction.....	59

LIST OF ILLUSTRATIONS

	Page
FIGURE I. A Simple Machine for Making Dependable Tests on the Site.....	8
FIGURE II. How Wattle Is Constructed in Greece	10
FIGURE III. A Residence of Stabilized Adobe Brick in North America	12
FIGURE IV. The Wide Joints of this Adobe House (in Litharia, Greece) are Typical of Adobe Construction.....	16
FIGURE V. Adobe Brick Used as Nogging	18
FIGURE VI. A Three Bedroom Rammed Earth Home in Southern Rhodesia	19
FIGURE VII. Corner and Straight Wall Forms for Rammed Earth.....	22
FIGURE VIII. Forms for Rammed Earth as Used in Southern Rhodesia	23
FIGURE IX. House Construction in Taiwan Using Pressure Compacted Earth Blocks Made in Hand Operated Machine.....	25
FIGURE X. 700 Soil Cement Blocks per Day Were Made in a Hand Operated Machine at Ho Hsiang, Taiwan.....	36
FIGURE XI. Plating an Earth Block with a Weather Resistant Soil-Cement Mixture	37

FOREWORD

As one means of providing technical backstopping services to housing technicians abroad, the Office of International Affairs of the Department of Housing and Urban Development under the terms of an agreement with the Agency for International Development, prepares and releases ideas, methods, and techniques which have been reported by those on overseas assignment or elsewhere. This is done in the form of an Ideas and Methods Exchange Series of which this current issue, "Earth for Homes," is the twenty-second release.

"Earth for Homes" represents an assembly and summary of available information and is released solely upon that basis. It does not reflect conclusions of the Staff although limited experiences in that field have been of value during the task of assembling and summarizing the material.



Senior Housing and
Urban Development Advisor
Agency for International Development

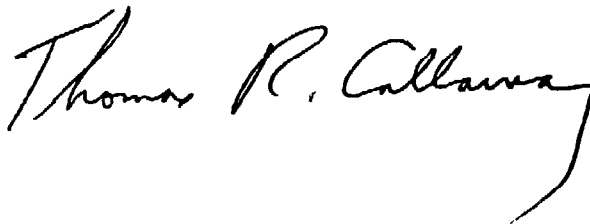

Director
Division of Technology & Documentation
Office of International Affairs
Department of Housing & Urban Development

ACKNOWLEDGMENTS

This Ideas and Methods Exchange was originally prepared in the office of the Division of International Affairs under the direction of B. Douglas Stone, Acting Assistant to the Administrator, by George A. Speer, International Housing Construction Advisor. It is an assembly and summary of information from various sources, mainly those listed in the bibliography.

Grateful acknowledgement is made to those who prepared the references from which much of the material has been borrowed and to manufacturers of materials and equipment who have supplied specialized information.

Photographs and drawings reproduced herein are by the courtesy of the Ministry of Housing and Reconstruction, Athens, Greece; the American Bitumuls & Asphalt Company, San Francisco, U.S.A.; and the United States Department of Agriculture; the Agency for International Development; and the Department of Housing and Urban Development, Washington, D. C.

INTRODUCTION

Because of war, preparation for war, great migrations, and many other reasons, the world-wide housing situation has worsened in the last forty years. Meanwhile, prevailing aspirations for better homes have intensified. Demand for higher standards for the house and its surroundings have not only intensified but actually have spread to many areas where inadequate housing was heretofore philosophically accepted, both by those who lived in the insanitary shacks and those who attempted, often unsuccessfully, to develop a productive capacity in the ill-housed.

For both political and economic reasons great interest has developed in improving shelter for the ill-housed--the great majority of the people of the world. All too often a quick look at the hard cold facts has indicated to those responsible that significant progress in housing improvement under prevailing methods was impossible. Even slight improvement was prohibitive in the cost, both from the standpoint of materials and labor. In many instances it seemed that better housing must wait for economic development. And the kind of economic development which appeared to be practical and logical seemed to be waiting for improved morale and vigor, which in turn would reflect itself in increased productive capacity and in political stability of the despondent, frustrated, ill-housed majorities.

At the time when the situation seemed the darkest, rays of light began to glow here and there in various parts of the world. Sincere thinkers were simultaneously, almost spontaneously, combining two age-old principles and adding to them new techniques. The combination often makes it possible to effect widespread improvement in shelter, within available resources and to do it now. The principles to which we refer are the use of earth as a building material and the aided self-help method of house construction. The new techniques result from extended research into the use of earth for road construction and make possible better earth construction than has heretofore been generally possible.

The introduction of earth as a home building material into areas where it has never been used before and its reintroduction and improvement where it had fallen in ill-repute and disuse, has resulted in a revival of earth home construction, as evidenced by its widespread use, for instance in Australia where over 9000 earth wall houses were recorded as far back as 1933; in India where 4000 permanent earth homes for displaced persons were built in the year 1947; in the southwestern portions of the United States of America where stabilized adobe is popular; and in the recent emergency programs in Korea and Taiwan, among others.

The revival has received added impetus through common sense use of aided self-help, whereby the heretofore unused time of the ill-housed--the greatest resource of all--bolstered by aid in the form of technical know-how, minor loans, provision of small amounts of heretofore unobtainable materials, and the like, make it possible for man to build much better shelter for himself than he ever could produce unaided--all within available resources.

Thus, in many instances and under many combinations of circumstances those who could never hope to pay to have adequate shelter built for them by others may now produce it for themselves. It is because of these facts that this paper, "Earth for Homes," has been prepared. It is directed to those who wish to become informed on the uses of earth and to perhaps investigate its possibilities under conditions with which they are intimately concerned.

This paper is not highly technical. It contents itself merely to refer to highly scientific phases of soil mechanics and only attempts to present field experiences and information which have developed as a result of the scientific background, or trial and error experiments which often have confirmed the findings of the scientists. It includes among its recital of the experience of others, a number of simple tests and criteria which have been reported to bear out, with more or less accuracy, the complex investigations in the soil laboratories. It concerns itself only with housing construction and does not dwell on the use of soil for walks, drives, and roads.

A glossary of terms used in earth construction is included in Appendix A for the information of those who have not had the opportunity or the time to previously become informed.

A partial bibliography is included in Appendix B for the use of those who wish to acquire further information on earth in house construction.

CHAPTER I

EARLY USES OF EARTH

Man emerged from caves because he had developed tools to provide other shelter for himself. The first form probably was a hole dug in the ground roofed with branches and skins or sod. Later he built frames of poles above the ground, plastered with mud (sometimes called daub). Stones set in mud were used as a wall building material in the early days of man. Sod was used to form walls.

With advances in shelter construction came crude "cob" in which mud of a fairly stiff mixture was applied by hand in clumps in consecutive layers to make a wall. Rammed earth, pisé de terre (a mixture of sandy clay soil and water, of slightly moist consistency, compacted between rigid forms) and adobe (soil mixed with water to a plastic consistency, often with a mechanical binder of straw or twigs, and poured between forms or moulded into bricks) were later but still early developments.

Adobe, in the form of sun-dried bricks, was well known in Egypt and Syria at an early date. The children of Israel made mud brick for the Egyptians at the time of Moses. At Chan-Chan, Peru, there is an elaborate structure of earth believed by some archeologists to be of an age comparable to that of the biblical civilization excavated in Mesopotamia. It is thought that the earliest houses at Sialk, an oasis in Iran, were built of a crude form of cob before 4000 B.C. The writings of Pliny state that the watch towers of rammed earth constructed by Hannibal were in use 250 years after completion. Unverified reports indicate that gigantic pyramids near Sian Fu, the ancient capital of China, said to be over six thousand years old, were built of alternating layers of earth and lime.

Earth, of course, has continued in use since those early days to present time. This is evidenced by the rondavels of Africa, in adobe and daub and various other forms in undeveloped areas in many parts of the world, the sun-dried brick of the Middle East, adobe in the Mediterranean area, and the Americas, among others. The Palace of Governors, still standing, was erected of adobe brick in Santa Fe, New Mexico, United States of America, in 1609.

Variations of the usual methods of earth construction were, from time to time, introduced under many names, including among others, Tubali, Teroni, Nogging, Tapia, and Terracrete.*

However, to an extent not justified in the light of present-day knowledge, earth was gradually superseded by the use of material of greater durability in some of the more highly developed parts of the world because earth, although adequate from the point of view of strength with reasonable limits, was found to be generally unsatisfactory from the viewpoint of durability.

*See glossary of terms used in earth construction on page 55.

Thus earth, one of the cheapest methods for building normally within the reach of the poorest person, has often been neglected because of its apparent exorbitant demands for maintenance and its structural instability in the presence of water. This condition has developed in spite of the fact that, as evidenced by the early constructions still standing, these undesirable factors need not always be the case. The problem therefore has been to find what made some earths and some methods of construction stable and others generally unsatisfactory.

This is where the application of the principles of soil mechanics, mainly to find ways to build better roads, have resulted in new ways to make soil construction more durable and have explained more clearly why some examples of the past have demonstrated extremely long life. And what is more, it has been found that even the new techniques which place emphasis upon careful soil selection, compaction, the addition of admixtures or a combination of any or all of these to increase resistance to water, impact, and erosion, need not be beyond the capabilities and ultimate needs of the average low-income people.

Desirable earth construction, then, still seems to be one of the simplest forms possible and an extremely low cost one under many conditions. It is well suited to aided self-help housing since it offers no obstacle to good architecture and a man and his friends or family can easily build during periods of leisure and unemployment. True, they may not work economically from the standpoint of production, or they may not do a "finished" job, yet they may construct what is a comfortable, well-designed home with the least possible outlay of money.

Before discussing in some detail the various methods of building in earth and the use of admixtures for stabilization which, after all, are both dependent upon the available earth, it will be well to briefly discuss the various soils and their properties.

CHAPTER II

SOILS

General

Soil in most cases consists of disintegrated rock with an admixture of organic matter and soluble salts.

Lateritic soils which have weathered from rocks in moist, warm climates often do not shrink or swell much upon wetting. They have high stabilizing qualities which are apparently connected in some way with their iron compounds and colloids. When dried out they do not readily absorb water, they consequently remain sticking tightly together for years on end--a desirable characteristic for earth construction.

Soils weathered in temperate climates are often high in silica compounds and low in iron and aluminum. They swell and shrink appreciably and have low inherent stability. They are sticky when wet and dusty when dry. However, through proper use they too are generally suitable for earth construction.

Soils are usually graded into divisions according to the size of the soil particles. Although an international soil classification exists and is generally accepted in agricultural science, the engineering system has been widely accepted in earth construction. The various classifications include coarse sand and fine gravel, fine sand, silt and clay. Often sand and fine gravel are simply called sand. The silt and clay in a soil are, under the engineering system, those portions of the soil which are .05 millimeters and below in diameter. However, in many areas soil portions passing a 200 No. U. S. Sieve (.074 mm.) are considered silt and clay--those retained, sand and gravel. Clay is that part of the fines which is .005 mm. and below in size. Colloidal clay, which is quite important in soil mechanics, is the very fine clay, .002 mm. and below in diameter.

In general, soils containing less than 20 percent clay are classed as sand and gravel, loamy sands, sandy loams, and loams, depending on the clay content. Soils containing from 20 to 30 percent clay are called clay loams and those over 30 percent clay are classed as clays.

Although the nature of the soil at the site of proposed construction may well govern the type of earth construction to be used, i.e., rammed earth, adobe, etc., it is often possible to mix two readily available soils to provide the optimum soil texture for any or all of the various methods.

In this connection it might be well to point out that, in any one area, it is often found that earth near the top of hills or ridges may contain a comparative excess of clay while those in the bottomlands often contain too much sand. If so, suitable earths may be found somewhere up the slopes. Also, the clay content of soils may vary at different depths below the surface. This variation is not marked or consistent.

In any event, to use earth most successfully, one must know all that he can reasonably learn about the available soils. Basic things to remember are that very fine clays, colloidal in character, readily take up moisture and cause trouble, warping and cracking because of their instability. Sand reduces shrinkage but excessive amounts (depending upon the method of construction to be used) prevent proper bonding. Too much silt produces a wall which erodes readily. Clay is the bonding agent which bonds the coarser granular minerals together into a durable wall.

While the clay content of soil can easily be determined by mechanical analysis, and we will later discuss "short cut" tests to approximate this, the nature of the clay can only be found by scientific method beyond the scope of field test and ordinary soil mechanic laboratories. Such properties as hardness and angularity of the coarse fractions and chemical combinations of the finer fractions are often not, for practical purposes, explored. This explains why soils do not always behave as they "should." Tightly cemented calcareous soils do not exhibit the same characteristics as would be indicated by their texture and character. Therefore, while physical tests which measure a soil's behavior are invaluable in selecting soils which should perform satisfactorily, they are not infallible and must be supplemented by empirical ones of weathering, wear, and tear.

Standard methods of surveying and sampling soils, preparing soil samples, mechanical analysis of soils, determination of materials finer than No. 200 U. S. Sieve, tests for liquid limits, plasticity, shrinkage, moisture density relations, and specific gravity, and methods of determining the optimum content of cement and bituminous mixtures in soils stabilized by these materials are among other tests, discussed in detail in various publications, including ASTM Standards.* They are precise investigations and, although of extreme importance, have no place in a paper of this kind except by reference.

Simple Tests

In preliminary investigations, knowledge of a few simple tests will be invaluable for the prospector. For instance, the composition of a soil may be roughly gauged by visual examination and the feel; the texture being determined by the combination of gravel, sand, silt, and clay. When dry and rubbed between the fingers the sand particles are gritty to the touch, the silt and fine particles adhere closely to the skin and have a silky touch. With little experience one learns to roughly gauge the composition as possibly satisfactory for further investigation for his purposes or as worthless, at least without admixture.

Going a little further a simple test can be made to approximate the amount of sand and gravel in a soil as follows: Put an average sample in a flat pan and dry it in an oven for about three hours. A wash basin will serve very well. Next pulverize the soil quite well. Leave pebbles and stones in the sample. Fill a quart measure with the dry soil tapping the measure to settle the soil. Place the soil in a wash basin or other flat container and cover it with water. It is important that the container

*Published by the American Society for Testing Materials, 1916 Race Street, Philadelphia 3, Pennsylvania, U. S. A.

be completely free of grease. Stir well and pour off dirty water slowly. Repeat the operation until the silt and clay are gone and the water remains clear. What is left in the pan is sand and gravel, some of it possibly quite fine. Dry the sand and gravel and measure it in a $\frac{1}{2}$ pint measuring cup. If there is a full cup there is approximately 30 percent by weight. If more than three cupfuls, the soil probably contains more than 85 percent sand and gravel and may be unsuitable even for rammed earth or compaction in a pressure machine, without admixture of another soil.

As the quantity of clay increases in a soil its plasticity increases and the degree of plasticity may be determined by standard laboratory tests. Most soils suitable for rammed earth have a plasticity index, as determined by the tests, of not more than 15.

In India, a quick method to get a rough idea of the plasticity index of a number of soils has been used quite successfully after the operator gains experience. It could be quite effective in making early determinations of the possible suitability of soils. The apparatus consists of a tube about six inches long and one inch in diameter. A cap is placed on one end of the tube with two or three holes in it $\frac{1}{8}$ " in diameter. A tightly fitted piston is placed in the other end with a short handle. It is operated on the basis that a sample of soil, at field moisture equivalent, placed in the tube and compressed with the plunger will extrude through the holes. Soils with a plasticity index of less than seven usually do not form threads of clay. From seven to 11 threads are formed but their surfaces are rough. Above 11 the filaments formed have a polished appearance. It is not possible to distinguish these from the threads of soils with a higher plasticity index.

Approximations of the amounts of alkali and soluble salts, if any, present in soil are sometimes necessary as will be later seen. Simple field tests are as follows:

- (a) Soluble salts--Pour a small amount of hydrochloric acid on the soil and the effervescent action and voids left will indicate some amount of carbonates in the soil.
- (b) Alkali--Fill a small open-mouth glass container about half full of soil and add pure water to bury contents to about $\frac{2}{3}$ full. To this add a small amount of 1% Phenolphthalein. A purple coloration of the water will indicate alkali in the soil.

These few approximations, together with other simple tests later discussed in connection with the various earth construction methods, will enable a prospector to determine whether or not even preliminary laboratory investigations are advisable. However, before going to the trouble of running laboratory tests, the prospector must determine if enough of the soils which seem satisfactory are available to complete the proposed constructions. In this connection remember that for adobe the excavations must be about 1- $\frac{1}{4}$ times the volume of the walls minus the openings. For rammed earth and pressure compacted blocks it is probably more depending upon the soil and the amount of compaction.

Of course, the soil must be readily available. Too often samples are taken from points which later are found to be too far from the building site. To make 1000 adobe brick of average size almost 15 tons of earth are involved.

It is recommended, at any time that earth is to be used in large volume at any particular site, that standard laboratory tests be made of the soil prior to determining how it should be used and what amounts of stabilizing agents, if any, shall be included. This may seem to involve complicated testing procedure but comparatively little testing is done since, when a group of buildings is built in one place, one set of tests is all that is necessary if all of the soil used is of the same type.

In professional tests, the soil is analyzed for materials which would be detrimental, and it is tested for sand, silt, clay and colloids, and general physical characteristics. Based on this information, a determination is made as to what method of earth construction will be used (adobe, rammed earth, etc., all as discussed in detail later in this paper) and test samples are made up. These samples are then tested for their (a) compressive and flexural strengths, (b) length changes due to variations in temperature and moisture content comparable to extreme weathering conditions, (c) resistance to natural weathering, and (d) heat conductivity values and resistances to wet-dry and freeze-thaw tests. Recommended moisture content for placing is, of course, determined at this time, as is the advisability of using stabilizing agents to increase the resistance of the earth to moisture.

At this point, it might be well to discuss the various methods by which earth is formed into walls before becoming involved in design which is based in a measure upon the method in which the earth is to be used.

CHAPTER III

METHODS OF EARTH WALL CONSTRUCTION

General

Soils which are suitable for building by one method may not be suitable for another. For instance, in the cob method and in poured adobe, shrinkage may cause too much wall cracking, while the same soil may be satisfactory for use in the adobe brick method since the building unit is shrunk before building in. In the rammed earth or compacted block methods consolidation reduces shrinkage which must be eliminated to the greatest possible extent. Soils unsuitable for most techniques may be used in the wattle and daub (brushwork) method because the timber reinforcement supports the earth.

The years of trial and error in building in earth have seen cob, wattle and daub, and poured adobe falling into disuse in many areas where the soil texture permitted the use of the more satisfactory bricks, rammed earth, and the newer methods of machine compacted earth blocks. Because of that fact, the little used methods of cob, daub, and poured adobe will only be discussed briefly in this paper although the principles of soil stabilization may soon make them of more interest. Emphasis will be upon the presently satisfactory methods and how these may be made more satisfactory, if necessary, by the use of admixtures for additional stability. Soil stabilization will be the subject of a chapter by itself and will follow the description of the various construction methods outlined in the pages which follow.

All of the methods of building in earth have one characteristic in common--the earth is mixed with water to a greater or lesser extent before being placed or formed. During these discussions of the various methods, simple field tests to determine the proper moisture content, by feel of the soil or its behaviour when handled, will be outlined. These, in general, are based upon experience and often suffice as practical field controls.

Until experience is gained, it is well to use some sort of a more precise method which will enable one to check upon the free moisture content of a soil during the construction process and, thus, to approximate the moisture content recommended by the technicians. One such test is outlined below.

Take several soil samples (to avoid possibility of error) weighing approximately 500 grams. Weigh them carefully, dry them to constant weight, then reweigh. The percent of moisture is then determined by dividing the loss of weight by the net weight of the wet sample.

Regardless of the method of construction, any type of water may be used for earth construction provided it does not contain excessive amounts of organic material or mineral salts.

Determination of Some Properties of Earth for Construction

Although a designer will want precise information on the earth he is to incorporate into a building, prepared by a responsible laboratory using recognized testing procedures, the following information is included here as an indication of ways in which an inexperienced operator may obtain approximate information on the compressive strength, modulus of rupture, and absorption of samples he has prepared as a result of preliminary investigations.

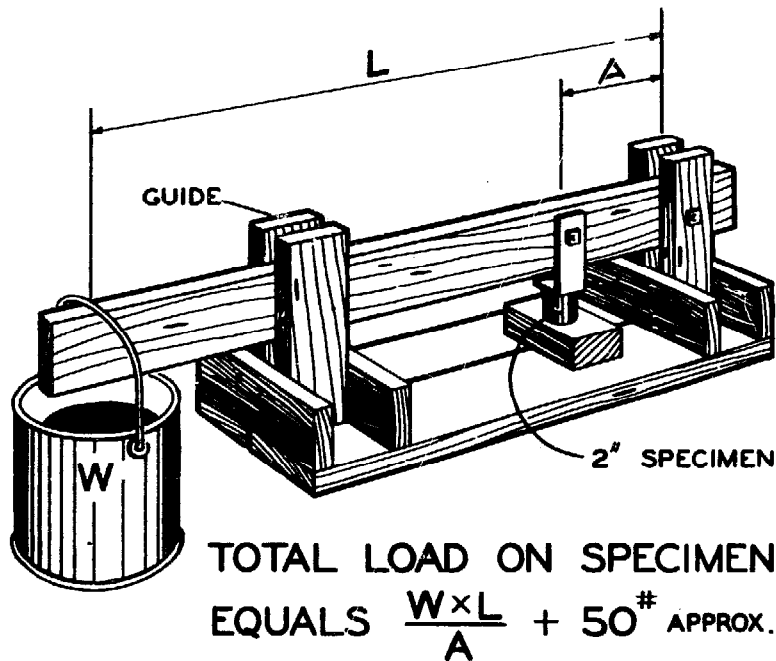

Figure 1. A Simple Machine for Making Dependable Compression Tests on the Site. Length "L" should be determined by trial as it will depend upon the strength of the materials and the weight necessary to produce failure.

to a pail at the end of a wooden lever). To insure that bearing faces are parallel, cap with plaster of paris or neat cement mortar. If cylinders of this size and shape* crush under less than 300 pounds total loading, deficiency in strength is indicated.

Modulus of Rupture

Large sized specimens, thoroughly cured and free from cracks, are laid over knife edge or pipe supports 10 inches apart. A concentrated load is then applied

*Compressive strengths obtained by testing cylinders of "mixes" are helpful for checking the comparative quality of specimens, because the size, in all cases, is uniform and can be tested with relatively simple equipment. In this connection typical full size adobe bricks of highest quality might average 500 pounds per square inch in compression while bricks half that size, identical otherwise, might test only slightly half over that amount.

Compression

The specimens may be given a rough check for strength at this time by making several 2" diameter cylinders of the soil mixture which offers the best possibilities. Form them in sections of pipe, 2" high. After initial drying place the specimens in an oven and dry at about 150°F. to a constant weight. The cylinders may be then tested for compressive strength in a regular compression test machine, if available, or with any simple lever device by which known loadings can be applied at a uniform rate (for instance by slowly adding water or lead shot

through a knife edge or pipe, midway between the support, at a rate of .05 inch, or 500 pounds, per minute and the load necessary to rupture each brick is recorded. Sponge rubber mats, or similar yielding material, should be placed between the knife edges or pipes and the bricks to insure even bearing surfaces. The modulus of rupture is calculated by the following formula:

$$R = \frac{15 \times L}{bd^2}$$

- R - Modulus of rupture in pounds per square inch
- 15 - Factor
- L - Load in pounds centrally applied over a 10 inch span
- b - Width in inches
- d - Thickness in inches

Modulus of rupture (average of three full sized specimens) may be expected to average not less than 40 pounds per square inch with a tolerance to 10 pounds less for one brick in a series of three.

Absorption

Four-inch cubes, cut from representative bricks or blocks, or samples similar to those used to make the compression tests are dried to a constant weight. After cooling to room temperature, the specimens are placed on a constantly water-saturated porous surface. After seven days the gain in weight of absorbed water is determined for each specimen and expressed as percentage of dry weight.

Erosion

A spray test, which has become more or less a standard, uses a standard pressure gauge and a four-inch diameter shower head fitted to a water outlet. A cured specimen is placed seven inches from and parallel to the face of the shower head. The water is directed horizontally against the vertical face of the test specimen for two hours, at a pressure of 20 pounds per square inch. Test results are indicative only and slight erosion and pitting of stabilized earth should not be interpreted unfavorably.

In the pages that follow typical methods of using earth in walls are briefly discussed without mention of such refinements as stabilization, wall finishes, or design requirements, which are all the subject of other chapters of this text.

Wattle and Daub

In the wattle and daub method of earth construction a framework of posts and poles is built up unto which is woven or fastened reeds or rods to form a base for mud plastering. The plaster, at the proper consistency for easy working, is applied to both sides of the framework. Shrinkage cracks in the thin wall are common. A somewhat similar construction consists of a double wall of poles and withes filled

with mud. Almost constant maintenance is to be expected with these types of construction, although the admixture of a stabilizing agent offers possibility of improvement.

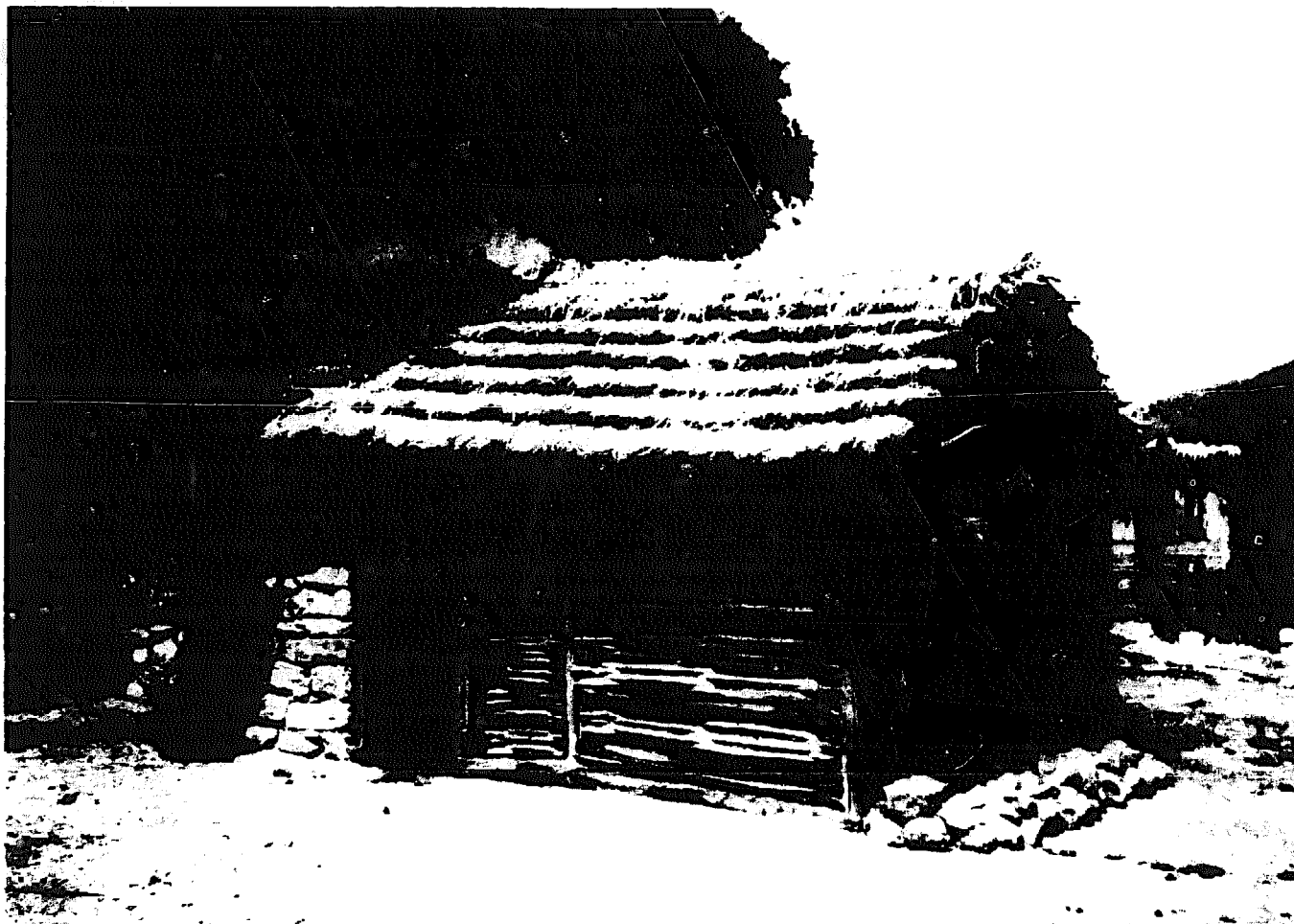

Figure II, How Wattle Is Constructed in Greece for Wattle and Daub Residential Construction.

Cob

In cob construction, as it is used in West Africa, the soil is prepared by mixing with other soils if necessary, by adding water, and by treading with the bare feet. After a curing period in a pile to insure uniform moisture content and, possibly, bacteria action, the pile is broken down and retrodden immediately prior to use. Balls of the material about the size of footballs are then formed and manually pounded into a solid mass to make a course on the wall. Each course, 12 to 18 inches high, is left to dry for from one to three days before the new course is laid. Faces are pared off with a stick or trowel and worked smooth.

As the height of the courses increases the workman sits astride the wall and balls of earth are thrown up to him. Thus no scaffolding is required.

As the walls dry shrinkage occurs usually over the entire external and internal surfaces of the wall. When shrinkage is complete a mud plaster is spread over both surfaces. This coat must be renewed periodically.

Poured Adobe or Mud Concrete

One method of forming such walls is to handle the mud much as monolithic portland cement concrete is used in common practice. Water is added to the soil, and the mass is thoroughly mixed to a mushy consistency. Straw may be added. The mixture is then shoveled or poured into the wall forms. The water content must be adjusted to give the most workable mass; too dry a mixture will prove difficult to work into place in the forms, while too wet a mixture will shrink more in drying and will take longer to dry out thoroughly. The walls are usually poured in courses although full height forms are sometimes built and the entire wall poured as rapidly as possible.

Since water must be added in amounts which will give workability for placing, it is essential that the earth be of a type which reaches this state with a minimum amount of water. Even then, with many soils, an excessive amount of shrinkage during drying makes this type of construction unsuitable.

If weather conditions are unfavorable, poured adobe walls must be protected from the weather during construction if they are to be satisfactory.

Adobe Brick

Adobe brick have enjoyed wide spread use in South and Central America, the southwestern portion of North America, southern Europe, Africa, and the Middle East. Sizes of the brick vary from the comparatively large building block used, for instance, in North America to the small sun dried mud brick of Egypt and the Middle East. However, regardless of the size of the building unit, it seems to be common practice to call them all brick--adobe or mud brick.

Adobe construction has been used largely in areas of low rainfall but its use need not be so restricted if the buildings are constructed properly. This is especially true since techniques in the use of admixtures have been developed which increase the resistance of the earth to the effects of moisture. Stabilization of adobe will be discussed later. It is necessary that, even if a stabilizing admixture is used, a dry period prevail during which the brick can be moulded as they are easily damaged by rain after they are moulded and before it is possible to stack and protect them.

Adobe brick are moulded from clay in a "plastic" state, often with a moisture content as high as 30 percent. This is because enough water must be added so that the clay can be pressed into forms, as we shall see later. Although authorities in the manufacture of and use of adobe brick apparently find it difficult to outline



Figure III. A Residence of Stabilized Adobe Brick in North America.

specific recommendations as to the optimum percentages of sand, silt, and clay, soils containing as high as 70 percent clay are considered by some to be satisfactory. If so, this makes adobe construction possible in areas where, for instance, rammed earth would not be practical.

Adobe is not limited to the use of high clay content soils and it may be found desirable to add sand to certain types of clays, if sand is available, to produce a better product. In the United States of America sand is now being added to most of the adobe soils.

To obtain a rough idea as to whether a soil is suitable for adobe, mould a ball about two inches in diameter from a sample taken below the grass roots. If the ball dries in a slow oven without cracking and is not easily crushed it may prove suitable. If not, a simple test may be used to determine if the admixture of sand would increase the quality of the product. Make six full sized samples (as cracking tendencies are

not always disclosed by small specimens) using the techniques, as later discussed, for full scale construction.

If the soil is heavy clay, mix the first brick of the straight soil. Mix the second, 3 parts of soil and 1 part sand; the third, $2\frac{1}{2}$ parts soil and $1\frac{1}{2}$ parts sand; the fourth, 2 parts soil and 2 parts sand; the fifth $1\frac{1}{2}$ parts soil and $2\frac{1}{2}$ parts sand; and the sixth, 1 part soil and 3 parts sand.

If the original soil contains high proportion of sand, fewer trial blends are necessary. Also fewer trial specimens might be needed if sand is added to a soil until the mud will just barely slip off a hoe leaving traces of dirt on it. Usually adobe bricks are considered satisfactory from the standpoint of cracking if not more than three cracks exist in any one brick, none of them more than $1/8$ " wide and none of them clear through the brick. Some authorities would limit the length of the allowable cracks to 3 inches.

A method to rate the above test specimens, made from the various mixtures of clay and sand, or to rate specimens made from the various soils available locally, is to use the following soil rating chart.

SOIL RATING CHART FOR ADOBE BRICK

(Mark Squares which describe the characteristics of each sample)		Soil Sample		
		1	2	3
<u>Mixing</u>	A. Soil mixes easily	x	—	—
	B. Mixing difficult but possible. Lumps in soil must be soaked or soil has a tendency to be sticky	—	x	x
	C. Impossible to mix economically	—	—	—
<u>Cracking</u>	A. No samples crack	—	—	—
	B. One or two samples	—	—	—
	C. All samples crack	—	—	—
<u>Weathering</u>	A. Wetting and drying of the bricks expose coarse aggregate but little evidence of washing	—	—	—
	B. Evidence of washing but no serious evidence of surface cracking or flaking of the bricks	—	—	—
	C. Bricks crumble, large surface cracks appear	—	—	—

SOIL RATING CHART FOR ADOBE BRICK--Continued

(Mark Squares which describe the characteristics of each sample)		Soil Sample		
		<u>1</u>	<u>2</u>	<u>3</u>
<u>Strength</u>	A. Corners of bricks and surfaces firm. Bricks difficult to break. (A hammer is needed to break off corners)	_____	_____	_____
	B. Bricks slightly crumbly on corners but firm enough to handle	_____	_____	_____
	C. Bricks crumble, break easily, and cannot be handled or stacked.	_____	_____	_____

Examples: Soil samples No. 1, 2, and 3 rated for mixing. No. 1 (Rated "A") mixes easily. Nos. 2 and 3 are more difficult to mix (Rated "B").

A soil with excellent possibilities will rate "A" in each classification of the test. A soil which rates "B" in all classifications might make passable bricks for light structures, but the bricks would probably need a protective covering. A soil cannot be used to make bricks if it rates "C" in any one of the divisions.

Simple tests such as outlined above are indicative and might be considered satisfactory for the construction of a small one story structure, at least one for test purposes. However, as has been said before, if a project is seriously considered, test reports by a responsible testing laboratory should be demanded. Our limited experience has indicated the presence of competent laboratories widely dispersed in most countries of the world. Even the most underdeveloped countries usually have a competent soil technician somewhere available who can arrange to conduct reliable tests upon short notice.

Once having determined that suitable soil is available it is a simple process to manufacture adobe brick. Adobe produced by the American Indians in the southwest portions of the United States is made in a manner which might be especially suitable for aided self-help shelter improvements in many parts of the world, as follows:

Either on or near the site a crater-like mound of earth is made. Then, after pouring water into it, it is puddled to a plastic consistency, often by tramping barefooted through the mass and by hoeing to ensure thorough mixture. Then a 1-1/2- or 2-inch thick layer of straw or chopped hay, in short lengths, is spread over the top and the entire mass kneaded to distribute this binder. To prevent the straw from settling to the bottom it should not be added until the mixture has been well puddled. Although some authorities do not agree that a vegetable binder should be added, it is interesting to note that in parts of Africa and also in Trinidad adobe is used under the name Tapia, using a grass binder having a strong durable fiber (*Sporobolus indicus*), cut into 3- or 4-inch lengths and mixed with the clay. Often the cut grass is left mixed with a slurry of clay for a considerable period before mixing with the soil. This is done to permit the non-fibrous materials in the grass to decompose.

Investigations into the extent of decomposition of fibres in adobe was carried on in the United States of America. Bricks one hundred years old were found to contain dried grasses in such perfect condition that the species could be identified.

A relatively level convenient site over which straw or sand is strewn (to prevent blocks or bricks from sticking to the ground) is selected for the molding floor. The prepared mud is conveyed from the "puddle" and placed in wooden forms. After tamping by hand, using care to fill all corners, the top surface is leveled and then the form, holding from two to four bricks, is lifted, washed of any loose mud, and is ready for the next batch. Slight tapping loosens the bricks if the mould does not lift easily.

Within a few days the bricks are ready for curing which consists of standing them on edge. Later they are piled to finish several weeks of curing and, if necessary, are protected from rain. Bricks should not be made when weather is unsuitable for drying. If freezing conditions are likely, they should be covered for protection.

Brick sizes vary; generally they are from 4 to 5 inches thick by 8, 10, and 12 inches wide, and 16, 18, and 20 inches long, depending upon the thickness of the wall. Average crushing strength is about 300 pounds per square inch.

Only dry, well seasoned bricks should be used at from 2.5 to 4 percent moisture content. They are laid with 1/2-inch to 1-inch joints using an adobe mortar identical to the bricks but with the straw and gravel omitted. This is done not only for convenience but mainly because they both possess the same coefficient of expansion. The adobe walls should be allowed to cure for over a protracted period before applying any protective covering material if such is necessary (as later discussed). Sufficient time must be provided so that settlement of the wall, often as much as 1 inch to every 10 feet of height, has taken place.

Should reinforced concrete be used as lintels, tie beams, etc., the Indians take unusual care to prevent moisture from the concrete reaching the mud walls since it is believed that adverse chemical reactions may take place. Layers of heavy waterproof building paper are placed over the top course of adobe brick directly under the concrete.

Adobe brick are laid in the wall in much the same manner as burned brick, care being taken to break joints and to build up strong, well bonded corners. A crew of three men should place between 300 and 350 brick in the average wall in eight hours.

Although much can be said for using the same mud for mortar as is used in the block, because of similarity in expansion and contraction, some authorities recommend the use of ordinary lime or cement mortars. Although they cost more, they set faster and, of course, the mortar is stronger. Sometimes limited amounts of portland cement is added to a mud mortar.

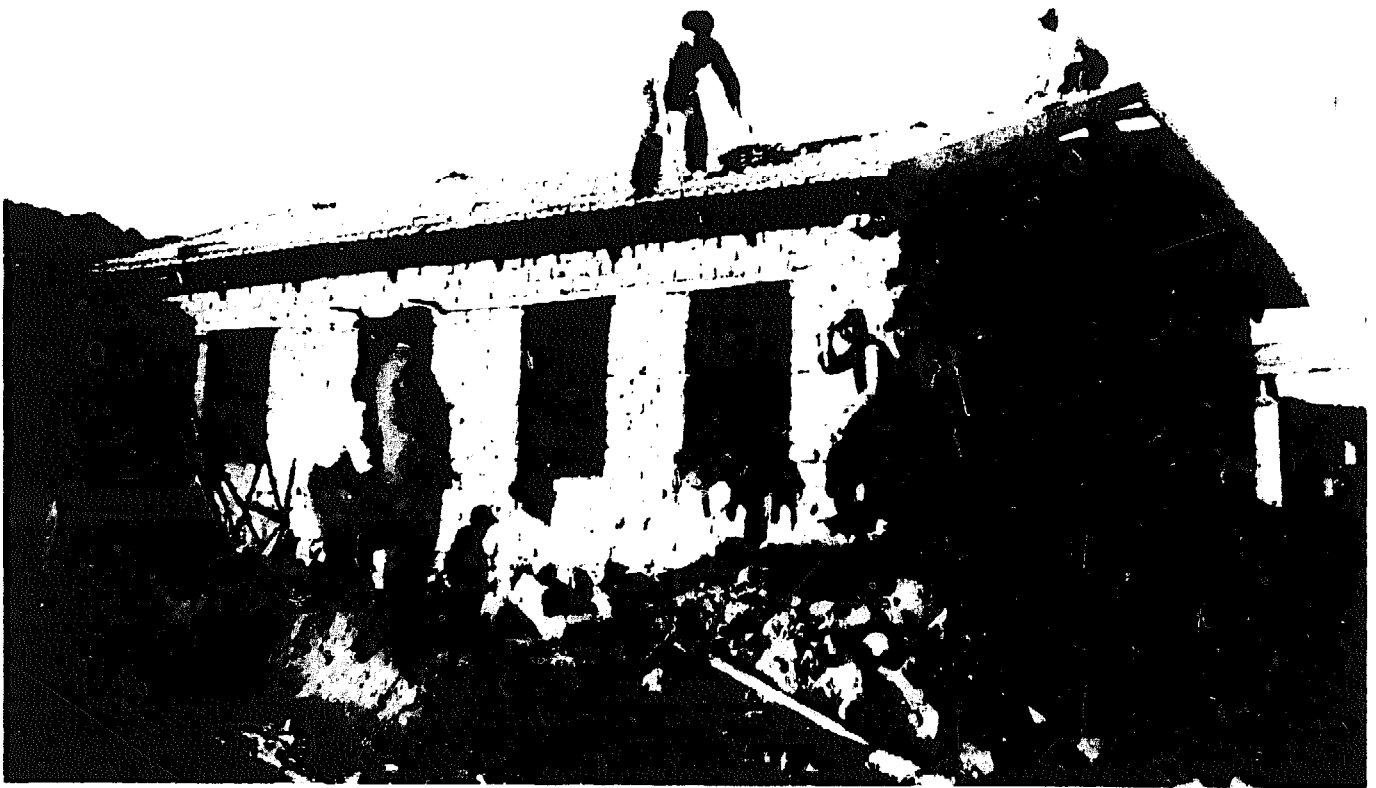

Figure IV. The Wide Joints of this Adobe House in Litharia, Greece, are typical of Adobe Construction.

To determine the amount of mortar required for a wall multiply $1/7$ of the wall area in square feet by the wall thickness in feet, then divide by 27. The result is in cubic yards of mortar with some allowances for wastage.

In attempts to increase production of adobe brick over what is possible by the method of forming the brick as outlined above, some authorities recommend a large rectangular wooden frame one brick deep. The dimensions of its sides are in multiples of the breadth and length of the brick. It is filled with packed adobe earth and levelled off. Then the brick sizes are cut into the mass of earth with a knife drawn along a straight edge.

Mechanical methods have also been introduced into the making of adobe brick. Mixers are used such as pug mills or dough or plaster mixers. Concrete mixers are generally not considered satisfactory. Smoother surfaces on the brick and rapid cleaning are made possible by the use of all metal forms or metal lined wooden forms.

In large scale mechanized plants earth is often moved by scraper or bulldozer to a conveyor belt which carries it to large mixers where water and any stabilizing agent considered necessary are added. The proper mixing process is one where control to insure a quality product is maintained.

From the mixer the soil is dumped into a hopper on a movable forming unit which is driven over a smooth area where the brick are to be cast. The forming unit often lays paper on the ground, casts a series of fifteen, twenty or more brick and moves over them laying paper on them to control early drying. Often 1,200 or more brick are cast per hour by these methods.

Also regular burned brick manufacturing plants have, with minor modifications, been used for making ordinary sized sun dried mud brick, stabilized with asphalt. It is believed that this method may be used for unstabilized bricks just as satisfactorily. After mixing, a ribbon of earth is forced through a die, wire cut in the same manner as brick for burning would be cut, and then dried in curing ovens under controlled temperatures.

The age old method of making sun dried mud brick typified by the Egyptian processes may also be useful if desired. In this method, since smaller units than the so called adobe brick are made, modifications, especially in the forming processes, are possible and practical.

One brick maker, a boy to handle the mould and place the brick on the ground, plus one woman to carry prepared earth to the brick maker, can produce eight brick per minute; and this despite the fact that the bricks must be carefully placed on a relatively smooth surface to dry since unusual roughness would prevent reasonably thin mortar joints.

Earth is moulded by forcibly throwing by hand a slight excess of mud into the mould cavity. The excess is removed from the top surface of the mould with either a straightedge or simply by scraping the material off by hand. The moulds used often produce a brick with a volume of about 1.8 liters, the dimensions of which when dry are 6 cm thick by 12 cm wide by 25 cm long. Usually a brick mould is constructed so that two bricks are moulded at one time, and sometimes two brick-makers are employed, each one filling only one cavity. In most cases, however, the brickmaker fills both cavities of the mould and can complete a cycle in about 15 seconds. With two expert brickmakers on a mould it is possible to reduce this time to about 5 seconds.

Two types of brick are commonly moulded in Egypt, corresponding to what are known in North America as water-struck brick and sand-struck brick. For the water-struck brick, the mould is open on both faces and it is completely wetted with water in a suitable container before the mould is filled with mud. The sides of the moulds are frequently scraped to assure a good clean surface. In making the brick, the mould is laid on a board upon which has been spread some sand. The brickmaker then forcibly throws the mud into the mould cavity and removes any excess by either his hand or a straightedge. As soon as the smoothing operation has taken place, a boy or helper removes the board, takes it to the brick yard, places it on the ground, removes the mould, and leaves the wet mud on the ground in the form of a brick.

For the sand-struck bricks, the molds are very similar except that one face (or the bottom) is closed. In this case, the moulds are wetted with water and then sand is shaken over the surfaces of the mould so that the brick can be removed easily. These moulds have four holes for each brick cavity situated near the corners of the brick on the face in contact with the mould. The purpose of the holes is to act as vents so the wet mud brick may be removed from the mould. Sand-struck bricks are more easily dried than water-struck bricks and are commonly used in large-scale manufacture. The country brickmaker in the village ordinarily makes a water struck brick and may use only a single-cavity mould.

For more precise information concerning adobe the reader is referred to publications listed in the bibliography which is part of this publication.

Earth Nogging and Cajon

In these types of construction, which are somewhat similar, a clay soil mix of proper consistency, either in monolithic form or moulded into bricks, is used in the form of wall panels supported by a structural wall frame. Methods of mixing and

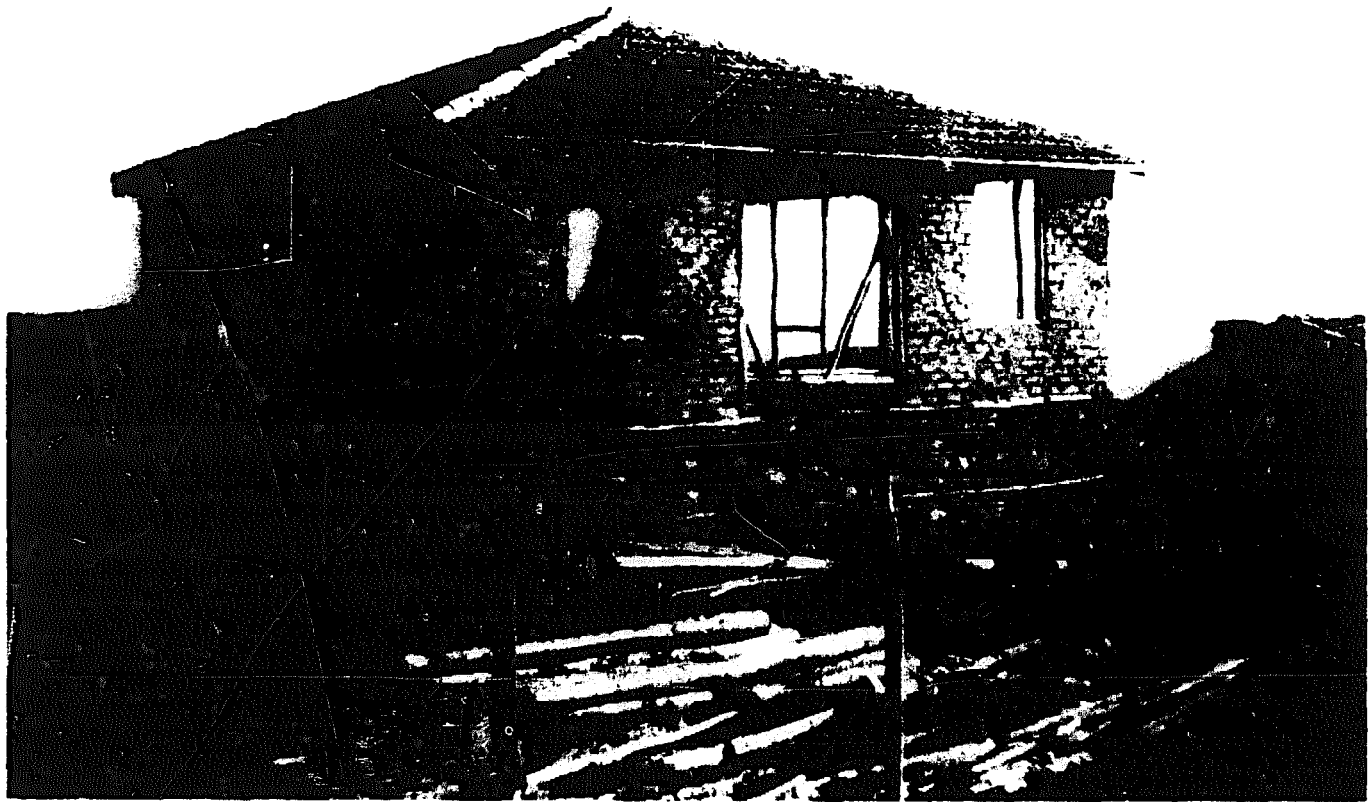

Figure V. Adobe Brick used as Nogging.

placing follow the same general rules which apply to adobe either poured or formed into building units. In earth noggling and Cajon construction the earth serves as a filler between the framing members, as insulation, and as a base for stucco or plaster.

Rammed Earth (Pisé de Terre)

Rammed earth walls are made by tamping moist earth into forms. The walls are rammed directly upon the foundations and in sections. The forms are similar to those used for concrete except they must be stronger.

One distinct advantage of rammed earth construction claimed by its proponents is that the earth used to make the walls requires less handling than is required by any other form of earth construction. Many believe that this advantage more than offsets the disadvantage of the heavy and relatively complex form which must be periodically moved and carefully levelled as the work progresses. In this connection, it will be recalled that in adobe brick construction about 15 tons of earth are needed to make 1000 average sized adobe brick as used in the southwestern parts of North America.

Rammed earth walls made of the most favorable soils show some signs of weathering initially but become very resistant after two or three years. The best walls may become slightly roughened by driving rains. Walls from medium grade soils may crumble somewhat during the first three years time.

Thus it will be seen that rammed earth walls, unless made from the most favorable soils will need some protection from the elements except in moderate climates. This need not eliminate the method of construction from consideration however as will be later seen. Certain wall finishes have sometimes been successfully used for protection. Roof overhangs and water resistant foundations often suffice. Admixtures of sand, lime, or cement to medium quality soil will often produce excellent walls.

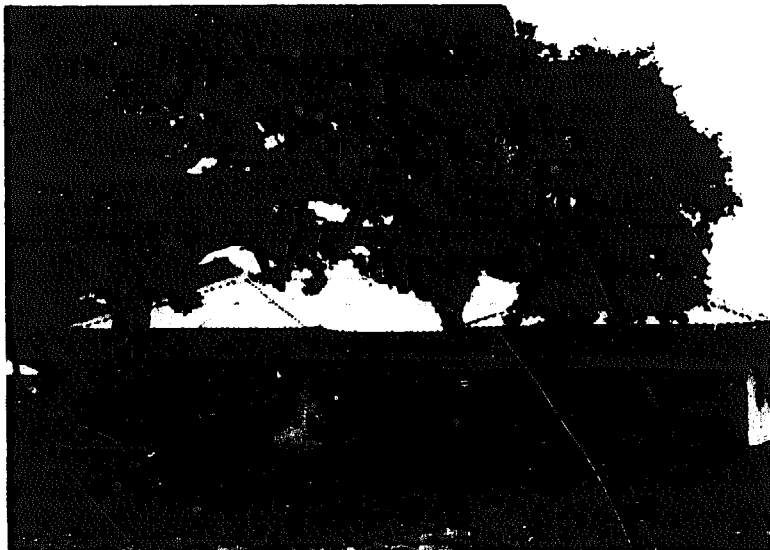

Figure VI. A Three Bedroom Rammed Earth House in Southern Rhodesia

As in the case of adobe, modern methods of using rammed earth require (a) preliminary study of the constituent elements of the soil, (b) proper proportioning, if necessary, (c) determination of the water content, (d) nature and amount of stabilizer, if any, and (e) conditions of compaction--steps necessary to obtain mixes with low shrinkage and absorption, or capillarity, proper compressive strength, maximum resistance to water and erosion, and minimum volume change.

The optimum moisture content for rammed earth varies roughly in inverse proportion to the amount of sand in the soil. Often a sandy soil containing only seven or eight percent moisture would be satisfactory while a clay soil would require from 16 to 18 percent of moisture to bring it up to optimum for ramming.

In the case of any particular soil, the amount of shrinkage varies with the amount of moisture, provided enough moisture is present to bond the soil particles well. Soils compacted at a moisture content of less than the shrinkage limit should have little or no shrinkage cracks in the structure.

It is possible in time to determine the correct moisture content of any soil by the feel of it when compressed in the hand. A simple procedure outlined here will produce a bit of earth with roughly twelve percent moisture content--an average. Sift a sample of earth into a pan and dry it in an oven. Place 8 pounds of the dried earth in a flower pot or similar container having a hole in the bottom. Place the pot in a pan containing one pound of water. The earth, through capillary attraction, will absorb all of the water. The soil thus uniformly moistened will contain about 12 percent of moisture by weight and be of average consistency for ramming.

The Lyons architect, Jean Rondelet (1743-1829), is said to have stated that earth for pise^o was deemed to have the proper moisture content when "a handful of it, when thrown back on the heap, will retain the shape given to it by pressing it lightly in the hand."

It has also been said that at the point of maximum density (optimum water content) a ball of material rolled in the hand will just moisten it without the surface of the ball becoming shiny.

In selecting soils it is well to remember that the amount of moisture in the soil when it is rammed has a decided effect upon strength in compression. When too dry, many soils lose strength markedly and in most cases soils that are too wet show low strength. Soil that is too dry can be corrected by sprinkling the pile with water and turning it carefully on the mixing board. If left overnight, the moisture distributes quite evenly.

In adding moisture it will save time if batches are kept of a constant size and a measured amount of water is added each time.

It is not necessary to screen soil that is to be rammed unless foreign objects such as tree roots are in it or unless the soil contains hard dry clods. Stones as large as hens eggs do no damage if there are not too many of them. Aggregates up to 1/4 inch in size and in quantities up to 45 percent increase compressive strength. Those larger, although desirable in reasonable quantities, will decrease the strength if reaching a proportion of 35 percent.

The most satisfactory soil for rammed earth construction usually seems to be one with a considerable amount of sand and gravel in it, ranging from 40 percent to 75 percent, with the latter the more satisfactory. Many agricultural soils will be

found with from 30 to 50 percent of sand and gravel. Sand can be added to soils slightly deficient with little trouble, through mixing on a mixing board.

It is probable that, in general, soils containing 30 percent and more of sand decrease in strength in inverse ratio. Of course, too little sand causes excessive cracking and checking of the rammed earth. However, strength usually is of secondary importance and sand in soil does make walls durable. This is of first importance.

Instances have been found where soils having a low sand content showed high weather resistance. Investigations into this seeming discrepancy indicate that as soils show an increase in colloids, the walls show a decrease in quality. Thus, even soils comparatively low in sand content but containing less than 40 percent colloids are favorable. Walls having a colloidal content of 30 percent or less are usually exceptionally good walls and might stand for years without protective coverings. This matter of the colloidal content may partly explain why some soils perform in a manner different from what might be expected. For instance, in India it has been found, as might be expected, that the best soils will have from 50 to 80 percent sand by volume--optimum sand content being 75 percent. However, certain soils containing only 20 percent sand have also been found to be reasonably satisfactory.

For a rough idea as to whether any particular soil might be suitable one might note, for instance, if the sides of an excavation remain firm, rather than easily sluff down. If so, it may very well be suitable for further investigation. The same would be true if the soil in a footpath remains hard in wet weather, if a clod of dry soil is difficult to crush between the fingers.

A simple test gives a good idea of the suitability of soil (or a mixture of soils) for use in rammed earth construction. Place a bottomless tub or pail in a hole dug in the ground surrounded by well tamped earth. The soil to be tested should then be rammed in the tub in layers 3 or 4 inches thick. When the tub is full strike off the top approximately level, invert it and allow it to dry overnight so that the earth will shrink enough so that the container may be removed. Cover the top of the sample to protect it from direct rain and observe it at intervals. If on continued exposure to air it continues to gain in density and compactness and does not crack or crumble it often will be reasonably satisfactory.

Again, a soil with a plasticity index of between 2 and 15 probably will be suitable for rammed earth. A quick test to approximate the degree of plasticity was discussed in Chapter II.

Forms for rammed earth construction should be made of heavy material since the outward thrust caused by ramming is tremendous.

At least two sections of forms are necessary so that corners may be built monolithically. Often only two sections will suffice, especially if the length of one of the forms does not exceed the least dimension on the inside of the building.

Boards for the sides of the large "standard" type of form are not less than 1-1/2 inches thick. Removable vertical struts not less than 4 by 4 inches in cross

section for a form 3 feet high are used if placed not more than 30 inches on center. The forms are held together by through bolts, top and bottom, which pass through the wall, the side boards, and the top and bottom of the vertical struts. Usually one end of the bolt is contained by an ordinary nut while on the other end (on the outside of the wall) is a wing nut, used in the interest of speed. Special arrangements of short nuts on cleats applied to the faces of the forms give stability at the corners. A slightly lighter form which has been reported to have given satisfactory service is shown in the drawings making up Figure VII.

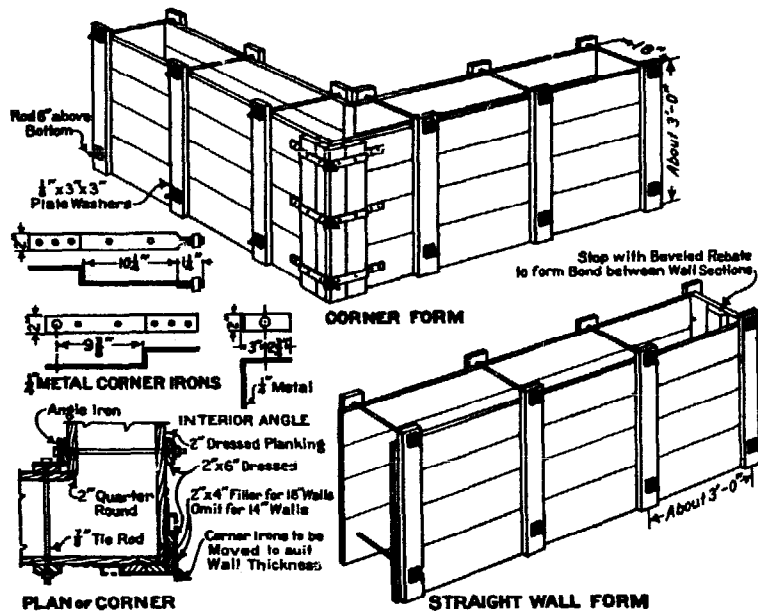

Figure VII. Corner and Straight Wall Forms for Rammed Earth.

In a slight adaptation of this type of form vertical cantilever type clamps, tightened only at the top, hold the two sides from spreading. At each end a roller is placed between the two sides of the form, at the bottom at one end and at the top at the other. When in use the bottom roller rests on the completed section of the wall in the course below and the top roller on the just completed section in the course then being rammed. After a section is rammed the form is loosened and rolled forward to its new position. It has been said that considerable time in resetting forms is

saved by using this principle, especially when long straight walls are involved.

In still another attempt to facilitate construction small light forms have been developed, which can be handled with comparative ease. In these cases two separate forms are usually used, one for the straight runs of wall and the other for the corners. One typical form, for a straight run of wall, six feet long and eighteen inches high was designed with plywood side pieces 3/4" thick. Framing members 2" x 4" were placed vertically about three feet apart with 2" x 4" stiffeners the full length of the form at the top and bottom and 5/8" diameter tie rods eighteen inches on center. Its weight is about 140 pounds. Small metal forms have also been developed.

Wooden forms are often oiled immediately upon completion with linseed oil and before each use with old crankcase oil to prevent the dirt from sticking.

To secure a plumb straight wall the forms must be levelled each time they are set up. Bevelled inserts placed in the corners eliminate sharp external corners which might break from impact during use. Door and window frames are often made the thickness of the wall and placed in proper position in the forms before ramming. Otherwise temporary casings are placed and later removed.

If difficulty in withdrawing the bolts is experienced, when the forms are stripped, place a little dry sand around and over the bolt before placing the soil for ramming. After the bolts are removed the holes are patched, as are any imperfections in the wall, by filling them with very dry portland cement mortar. A small "V" shaped trough and a wooden tamping rod make this task easier. If large patches are necessary a neat mortar is applied over nails driven into the wall to provide bond.

After much experience some authorities have found that a quite satisfactory rammer is one with a cast iron or steel head cubical in shape about three inches in dimension each way. The shaft often is formed of a one-inch iron pipe about 5'-6" long. The tamper should weigh from 13 to 18 pounds. For other size faces it is well to use a tamper with an average weight of from one and one-half to two pounds per square inch of surface. Wooden tampers tipped with metal, with wooden handles are just as satisfactory if the weights approximate those outlined above. Pointed tampers have not, in the main, been found as satisfactory as those with flat faces.

In building the wall only a few inches of loose dirt are placed in the form. If it does not ram until perfectly hard, giving off a ringing sound as the tamper strikes it, the moisture content is not quite right--probably too wet.

In ramming, the earth in the corners and close to the sides of the form should be rammed first. Layer after layer is rammed until the form is full. After the form is moved to a new position above a previously rammed section, the top of the lower course should be roughened, brushed clean, and slightly moistened.

The intensity of the tamping stroke is quite important since the compressive strength, and probably the general durability of the wall, varies with the intensity of tamping. For practical purposes, using a tamper weighing 18 pounds, with a nine square inch face, proper intensity may be attained by raising the tamper about 12 inches above the soil with all force possible exerted in the downward stroke.



Figure VIII. Forms for Rammed Earth as used in Southern Rhodesia. Note that the window frame is the full thickness of the wall; also that "expanders" are placed inside the frame to prevent bowing from pressure during ramming.

In placing rammed earth with a crew of four men, one can mix the dirt on a mixing board to insure a uniform water content and place it in the forms and three can tamp. In one such experience each man tamped about two cubic feet of wall in an hour. In another recorded experience a three man crew, with one mixing and placing the dirt and two tamping and all working together to move the forms, placed an average of about 54 square feet of 18 inch wall (in the first story of a structure) in one day. If labor is expensive and mechanization is desired, the compressed air tamper appears to be the most logical tool. Forms for use with the pneumatic tamper should not be over two feet high.

Construction work can be carried on in any reasonable weather if the soil is kept dry. In cold periods, if the soil is not frozen and the temperature does not fall too much below freezing, little damage may be expected. However, it is advisable to avoid freezing weather when possible. Care of the soil is of great importance.

In building gables it is often not considered advisable to ram the wall on the slant of the roof. Rather the gable ends are rammed in horizontal sections leaving a notched effect, to be filled in later.

Often rammed earth blocks, made in the same manner and of the same soil as the walls, are used to build gable ends. Blocks often are convenient, too, to build interior partitions. One mortar found to be satisfactory for such rammed earth blocks consists of "dagga" with a mixture of portland cement--that is, for an average soil, two measures of plaster sand, one measure of sandy clay, and one third measure of portland cement. Lime has also been used.

For detailed information on the use of rammed earth in building the reader is referred to publications listed in the bibliography.

Pressure Compacted Machine Made Blocks

A method has been developed to use power driven or hand operated machines to compact earth into blocks, with or without a stabilizing admixture. The method shows extreme promise and has been used extensively in Africa, as well as in many other parts of the world.

Even with small, portable, hand operated machines pressures of from 1000 to 1500 pounds per square inch are placed upon the earth in forming. The blocks are usually true to size, have sharp arrises, and are extremely dense. A variety of dies are usually provided so that the block may be made in different sizes and shapes and may be made for laying in the conventional manner or, if desired, made with "V" joints so that they are built directly into the wall without mortar.

With the most satisfactory soils the blocks show good weather resisting properties without the admixture of stabilizing ingredients. Usually, however, a small percentage of cement or lime is added to insure a wall, or at least the portion in contact with the ground, which will successfully perform in the presence of moisture under almost any conditions. Compressive strengths up to 1400 pounds per square

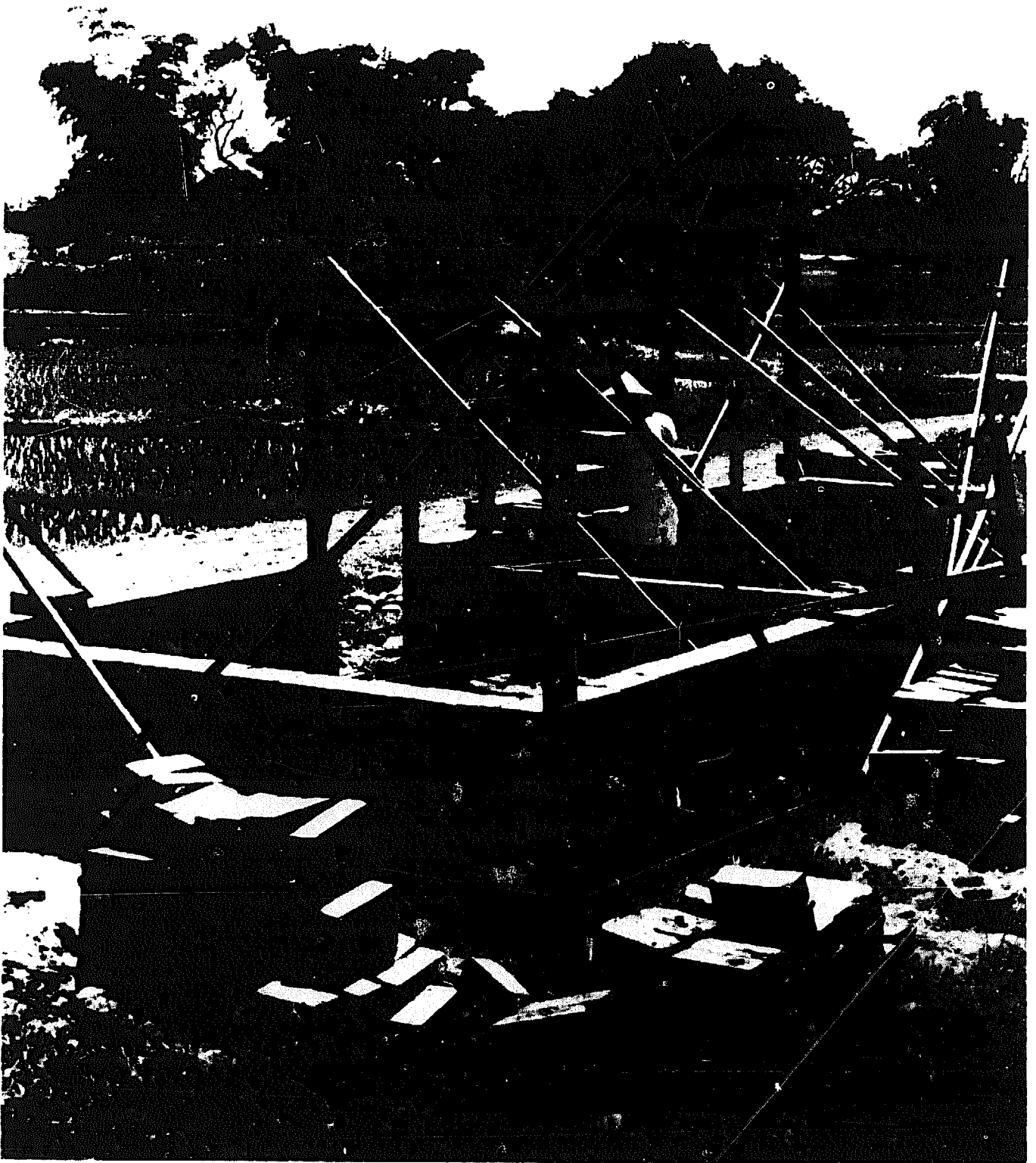

Figure IX. House Construction in Taiwan Using Pressure Compacted Earth Blocks Made in a Hand Operated Machine.

inch have been recorded, when stabilizing admixtures have been used. Thus, under certain conditions the massive walls common to adobe or rammed earth may no longer be required. Portland cement admixtures of from two to ten percent or more by volume have been reported. In at least one instance high grade plasterer's lime in the ratio of one part to ten of soil produced results comparable to portland cement.

Labor requirements are optional, but it takes a minimum of four men to produce a maximum output of bricks or blocks in the hand operated machines. One mixes the soil, two operate the machine, and one carries and stacks the units for drying.

Manufacturers claim that any soil containing the correct proportions of sand and not less than 18 percent of clay is suitable for use in the machines, if stabilized. Lateritic type soils of Africa and, no doubt, many other soils throughout the world may be used effectively without stabilizing admixtures. It is extremely probable that soils to any degree suitable for rammed earth would show reasonably similar properties when pressure compacted in machines (large gravel and stone are removed from the earth). However, since the size of units made in the machines is limited and thus a practical limit is placed upon wall thicknesses, stabilizing admixtures probably will be used to even a greater extent in pressure compacted blocks than will be deemed necessary in adobe or rammed earth.

Equipment needed to produce pressure compacted blocks in a small scale operation includes:

- a. Pick, shovels and wheelbarrow.
- b. Two screens, one of 5/16" mesh; the other a 1/8" mesh.
- c. Measuring box which one man can handle, often of one cubic foot capacity. This is necessary only if cement or lime is to be added to the soil.
- d. Measuring box which will hold the right amount for making one block.
- e. Wooden trays or palettes, large enough to hold several stacks of blocks. These can be made from rough timber. The platform may consist of 1" boards nailed to 2" x 2" s which extend as handles beyond the boards. There should be enough of these to store over night one day's production.
- f. One pressure machine.

The following description of making blocks in Burma may be considered typical of a small operation using a hand powered machine. In this case cement was added to the soil. Except for obvious omissions the process would be the same if no admixture were intended. It should be noted that the blocks which were used were those formed with a "V" projection on one side and end and a "V" groove on the others (with special blocks for corners) so that, theoretically, the wall could be laid up without mortar. In reading the description it will become apparent that some difficulties in laying "dry" walls were encountered. This, no doubt, was the result of local conditions since such difficulties have not always been experienced elsewhere.

"Controlled tests in the laboratory were made to determine what moisture content and what cement content would make the best blocks. Sample blocks were made containing from 1% to 20% moisture content and from 1% to 10% cement content. It was found that blocks with 11% to 13% of moisture, containing 5% cement were 'stable.' To determine 'stability,' the blocks were subjected to the '24 hour test,' that is, they were subjected to 12 hours of water spray at night and to 12 hours of sun during the day. After a long period of time there was little deterioration. The 4% blocks deteriorated after about 30 days.

"Soil mixed with 12% moisture is just damp enough to pack well when pressed in the hand. There was very little variance in strength between the samples containing 11%, 12%, or 13%, hence it was felt that a slight variance would not materially affect the strength of the blocks. What applied to the soil in Burma might not be applicable to the soil elsewhere.

"Our people learned to tell the correct amount of moisture by feeling the soil and by compacting a handful in the hand. Our workers in the laboratory and also the villagers quickly learned this.

"Soil is dug in the quarry and is broken up as much as possible in the digging. It is carried to the mixing area and put through the two screens. If the soil is dry it is advisable to add water from a sprinkling can or from a spray nozzle periodically as the soil comes through the second screen. Water should be added after about every inch of screenings. Adding water as the screening progresses permits a better distribution of the moisture, which should permeate every particle of soil. This must be thoroughly mixed in order to distribute evenly the moisture.

"After the second screening the soil was left in the pile overnight to permit thorough moisture distribution. Then the cement was added in measured amounts. For one mixture we used 27 boxes of one cubic foot each for each one bag of cement. In the other instance the amount of cement was doubled. After careful mixing the soil was again screened through the smaller screen and the blocks were made. Obviously cement should not be mixed with the soil until just before the blocks are to be made.

"The digging, the screening and the mixing are dusty and hard and tedious jobs. The actual making of the blocks is simple. If a team is working together, the various jobs should be rotated.

"Two men are required to operate the machine in order to obtain the leverage for proper compaction. While one removes a block from the machine and places it on the palette the other fills the measuring box and pours the mixture into the well of the machine. One great disadvantage of the machine is that the well is not large enough to hold all of the loose soils which is required for a block unless it is packed with the hands, which of course slows up production considerably. One answer to this is to make 3" thick blocks instead of 4" blocks. A small bag of cement dusted over the inside of the well before each block is made will prevent sticking to the sides of the well. Without exerting themselves a team of six men can average about

400 blocks per eight hour day. For the house which we designed 2900 blocks are required. Therefore for a six man team, just over one week of work would be required to make enough blocks for one house.

"When freshly made, blocks may be placed one on top of the other without damage. We have placed on a level surface, as many as ten freshly made blocks one on top of the other without damage to any of them.

"In order to avoid evaporation of moisture before the setting of the cement it is preferable to place blocks in the shade for the first 24 hours after making them. It takes about 30 days to cure them completely but they may be placed in the walls of a building 3 or 4 days after making without apparent damage to them.

"Blocks cure unevenly. Also sometimes small particles of soil adhere to the surfaces. For both of these reasons an earth block wall cannot be laid evenly (without mortar). However, a stabilized earth mortar course every fourth course stabilizes the wall very well and improves the wall tremendously.

"Laying a mortar course with stabilized earth mortar is a very slow process. It required 8 times as long to lay a mortar course as one without mortar. Until the men learn how to use the mortar the result is quite messy.

"The vertical tongue (V shaped projection on the end of the block) must point one direction only, that is either clockwise or counterclockwise, all the way around the building, with each course reversed. Each course of blocks in any length of wall consisted entirely of stretchers with a single header at one end.

"The 4" blocks we used tested about 300 pounds per square inch. They will take nails. Door jambs and window frames may be nailed directly to the blocks. Nails should not be near the edge of the block but as much in the center as possible.

"Our blocks chip very easily. They cannot stand the rough treatment of ordinary building blocks or bricks. Hence any surface which is likely to be receiving much wear should be protected. This applies to thresholds, window sills, and even to protruding corners in the house. A cement wash applied to an earth block wall has a strong stabilizing effect. With a cement wash a wall is quite difficult to chip, it makes a very smooth finish, and effectively keeps out the moisture. It may be applied with a rag or with a brush.

"Blocks may be cut with an ordinary saw if one is not particular what happens to the cutting edge. They will not take direct pounding. For that reason the floor joists could not be 'keyed' into the walls but extra piers were required."

CHAPTER IV

STABILIZATION OF EARTH BY ADMIXTURES

General

In the preceding chapters we have seen how earth, used for building houses, may be processed and assembled into walls. So far, except for brief references to the use of certain admixtures, we have discussed soil held together for building purposes by its clay acting as a binder or cementing agent, with its sand content as an important constituent in reducing volume changes. The addition of vegetable fibers has been mentioned. We also have seen how compaction, as in the case of rammed earth and pressure compacted machine made blocks, imparts increased weather resisting qualities.

However, the information so far included in this paper has not told the whole story. All too often the villager with few resources and few tools in attempting to build with earth has found the result unsatisfactory. All too often his house has required constant attention, especially during the rainy seasons. Replacements have been frequent. When he becomes ill or too old to maintain it properly it has often become a source of danger to himself and his family. The same problems he faced resulted in the comparative abandonment of earth as a building material in more highly developed societies.

These conditions need not always exist. Earth can be further stabilized to more or less degree depending upon the soil involved. And, of course, application of this knowledge has been responsible in part of the revival of the use of earth.

Before discussing stabilizing agents it might be well to review some of the characteristics of the soil to afford a better basis upon which to evaluate stabilizing agents.

The stability of earth in its natural state is due to the presence of silt and clay, including the colloidal fractions, which bind the sand and granular minerals together. The silt and clay particles are of excessive fineness, and each particle is surrounded by a minute film of water whose thickness determines the binding power of the earth. Sand is inert and the particles do not absorb moisture so that when quantities of additional water are applied to an earth, the films of moisture surrounding the clay particles become thicker, thereby causing expansion and lubrication of the material, increasing its plasticity. Repeated wetting and drying causes gradual disintegration at the surface, or at that part which is most intimately in contact with the water.

With the development of techniques of stabilization it has been found that it is possible to give permanent water-resistant stabilization to walls of proper composition by adding certain materials to the natural earth from which they are built. This process is popularly known as soil stabilization. Thus it can be that soil stabilization is any process by which soil is made hard, water resistant to a greater degree than before stabilization and reasonably free from volume changes. Although

stabilization in some cases gives earth an increase in compressive strength it is well to remember that stabilization of earth is considered mainly a means to increase its resistance to weathering. Design criteria used for untreated earth walls usually apply unless responsible tests indicate otherwise.

Stabilizing agents which have commonly been used with more or less success include cement, lime, road oil, and emulsified asphalts. Less commonly used but with more or less promise are resin emulsions, soaps, stearates, water glass, and other silicas. Aniline--Furfural treated with "Plasmofelt" has received attention. With few exceptions the high costs of these materials preclude their use without further research. Calcium acrylate and chrome-lignin show promise, and limited experiments indicate that costs in some areas are roughly comparable with cement and asphalt. It is believed possible that these processes may be effective where other measures are not. Continuing research to explore the possibilities may pay big dividends. Powdered bentonite, or colloidal clay, which increases in volume very rapidly when wet may offer promise as a means to hinder moisture penetration as portions near the surface of the earth wall swell. Lignin, briefly mentioned above, which is the cellulose cementing material from wood fibers secured as a by-product in the paper industry, apparently serves as a colloidal barrier to moisture in a manner similar to bentonite. It also seems to cement the grains of the soil.

Vinsol resin, a by-product from the distillation of turpentine, in a sodium hydroxide solution shows some promise both alone and when used with Portland cement.

However, it may be safe to say in general that when using the more common and better known stabilizing agents, soils which have more than 50 percent of their component particles passing through the 200 mesh sieve (those being roughly more than 50 percent silt and clay) fall outside the realm of presently recommended practices for stabilization. Actually, what this probably means is that such soils do not possess an internal skeleton of sand and larger sized particles touching or interlocking with each other. It may be that liquid limits and plasticity indices are excessive in such soils when they do not respond to attempt at stabilization. Research has indicated that stabilization of even these soils may be possible but, if so, it will only be on the basis of a thorough understanding of the physico--chemical character of the internal surface of the soil.

We have said that many examples of structures of earth built long periods ago show exceptional weather resisting properties, and so do certain soils used under current practices. Thus, when considering soil stabilization, the first question which comes to mind is--must our soil be stabilized and if so, how and how much--a reasonable question which cannot be answered with investigation. The character of the soil governs as does climatic conditions at the point of use. Although soil technicians can and should predict performance and recommend treatment, the fool proof method is to make samples and conduct tests. Standard tests have been developed and are well known to soil technicians.

Simple Tests for Weather Resistance

For the prospector and those making preliminary investigations, simple tests to determine resistance to the presence of moisture have been developed which serve as practical indications of what might be necessary under local conditions.

One empirical test, used in Africa, is to make several samples, with varying proportions of stabilizer. After curing, subject the samples to alternating immersions in water by night and exposure to sun by day and observe results. If any of the blocks fall to pieces, crack, swell, burst, flake, or show other defects, then the proportion is defective--or the soil unsuitable. Further trials will give the answer. Unstabilized samples might be also included in the test. Those of local unstabilized soil often do not survive the first immersion, unless they are exceptional.

In still another instance, after proper curing, samples were subjected to twelve cycles of wetting, drying, and abrading. Each cycle consisted of soaking for five hours, drying for 42 hours, and lightly brushing the surface of each sample with a wire brush several times. The loss in weight is plotted against strength of the stabilizer. The different soil combinations and varying percentages of stabilizers were related to performance.

In India, samples were subjected to wetting and drying. One cycle consisted of immersion in water at room temperature for five hours and heating to 71°C for 42 hours and cooling one hour. Between each cycle loose material was brushed from the samples. After twelve such cycles samples were considered satisfactory if loss in weight did not exceed one percent.

In Egypt, sun dried mud bricks, stabilized and unstabilized, were tested as follows:

"One drop of water fell every second for 18 hours from a height of 1.0 meter on the samples. The stabilized bricks showed a tiny trace due to the effect of the drops (3 millimeters in diameter by 2 millimeters in depth) while the unstabilized brick failed, showing a hole through the total thickness of the bricks ranging from 4 centimeters to 5½ centimeters in diameter."

A quick test method consists of making small discs of earth together with varying amounts of the stabilizer, 2 inches in diameter and ½" thick. After drying they are submerged in cold water for six hours. The mix containing the least amount of stabilizer which does not soften or discolor the water may be considered the most satisfactory.

A spray test which has become more or less of a standard uses a 4" diameter shower head, directing water against the face of a sample. This test is discussed in more detail in the introductory statements at the beginning of Chapter III.

Stabilization of Adobe

Stabilization of adobe is generally accomplished by mixing oil, asphalt, Portland cement or lime with the soil as stabilizing admixtures. Of these emulsified asphalt

and oil have been the most widely used, probably because adobe is formed in the plastic state with a relatively high moisture content and the emulsion can be easily mixed with the puddled soils.

A soil for asphalt stabilized adobe bricks must be free from alkali salts and, of course, must have those other characteristics necessary to make good adobe. Soil, or water, which contains more than .2% of any salt wholly or partially soluble in water should be discarded--it usually causes the bricks to crumble. This crumbling may not appear in the relatively short periods allowed to test samples.

When using an emulsified stabilizer, during the drying period, the globules of the stabilizer in the emulsion become "absorbed" as films upon the clay particles of the soil. When fully dried, the material is water repellent and its natural strength of bond is preserved against water from rains or capillary moisture from the ground. The emulsion rarely has an unpleasant effect upon the appearance of the walls and, if the colloidal ratio is proper, the emulsion somewhat increases compressive strength.

Asphalt waterproofing agents applied in suspension of liquid consistency at normal temperatures are as follows:

- a. Rapid Curing Type (asphalt cement plus a highly volatile distillate); grades RC-1, RC-2, RC-3.
- b. Medium Curing Type (asphalt cement plus medium volatile distillate); grades MC-2 and MC-3.
- c. Slow Setting Type "Emulsified Asphalt" (asphalt cement plus water plus emulsifying agent). "Emulsified Asphalt" is applied to adobe construction under a process patented in the United States of America by the American Bitumuls and Asphalt Company.

The quantity of asphalt emulsion depends primarily upon the amount of fine silt and clay contained in the soil. It can usually be determined only by experiment. For purposes of rough estimating the following table has been suggested to approximate the amount of Slow Setting type (emulsified in water) which will be needed:

Soil: Bituminous Proportions

Soil (Basic Types)	Bitumen (Slow Setting) Emulsion Percentage of the Soil Fines, by Weight
--------------------	--

Sandy Loams, 4 to 6%; Clay Loams 7 to 12%; Heavy Clays 13 to 20%.

Thus based on a proportion of 15 percent of commercial density of mixing emulsion to the fines in the soil, by weight, a soil with 70 percent sand and 30 percent fines would require 30 times 15 one-hundredths or four and one-half pounds, equivalent to about one-half gallon of emulsion, for each 100 pounds of soil. Fifteen percent probably would be high for this particular soil.

These rules when used for preparing samples or making quick estimates are helpful but it must be remembered that the amount of stabilizer required will, in general, increase not only with the amount of clay in the soil but also with the colloidal content. It should be recognized that the water affinity of the fines in various soils may vary and, also, that the nature of the stabilizer is a variable.

The Rapid Curing Types of asphalt cement with a volatile distillate have been used with success in stabilizing adobe. RC-1 and RC-2 are both considered suitable although RC-2 has a higher viscosity and the solvent evaporates a little slower in cool weather. Recent experiments in Egypt disclosed little difficulty in dispersing the emulsions in properly tempered soils from which the small sun dried mud brick were made. Experiments to use the Medium Curing Types under job conditions may prove satisfactory and of value.

Bunker C oil, which is normally used as a fuel oil, has also been successfully used as a stabilizing admixture in adobe. Experiments with Diatol, a proprietary product made in Egypt containing a mixture of diatomaceous earth, water and Mazout (similar to Bunker C oil) are promising.

Although this discussion of the stabilization of adobe has been confined almost entirely to the use of emulsified asphalt and other oily substances, cement and lime have been used and merit further research and widespread dissemination of the results. Reportedly, portland cement has been used with adobe soils containing 50 percent or less of silt and clay, often with satisfactory results when mixed as a plastic mixture. Suitable cement contents, by volume, are said to range about 4 percentage points above those used with soil-cement compacted at optimum moisture content to maximum density, as is the case in rammed and pressure compacted blocks.

Stabilized adobe is mixed in the same manner that plain adobe is made. The stabilizer, with whatever additional water is needed to achieve proper plasticity, may be mixed by puddling with the feet or with a hoe. A positive mixing action is an absolute necessity. Because of this fact, if quantity is desired, a mechanical mixer is desirable. As in the case of unstabilized adobe, dough mixers discarded from baking use are suitable and paddle mixers designed for preparing mortar are excellent. In larger operations, pug mills and continuous mixers are often used and, of course, if the size of the operation makes it practical, it is possible to produce asphalt stabilized bricks on a commercial scale using a complete brick making plant, with minor modifications. Wet pan roller type mixers are especially efficient with oils. Whatever type of mixer is used there must be uniformity of mixture and complete dispersion of the stabilizing agent and water under careful control.

Stabilized bricks should be moulded without delay after the admixture is mixed with the soil. Even properly made stabilized bricks may be damaged by rain the first day or two after they are moulded until they have dried sufficiently so that the stabilizer (especially in the case of asphalt) will not "wash out." Bricks should be cured for about thirty days (or until they have a constant weight) before being laid in the wall. Because of the quick setting and hardening properties of portland cement

even in wet weather, a small amount of cement is often added with asphalt stabilizer in damp weather, a distinct advantage in making and curing.

Plastic soil-cement mixtures when used in block form should be placed in forms at the proper consistency established by test and puddled or vibrated until it is a certainty that air voids are filled. Puddling or vibrating should be discontinued before excess water rises to the tops of the forms. Blocks should be damp cured before air curing.

The quality of stabilized adobe bricks is often checked against the following criteria determined by recognized testing methods:

General. Finished bricks shall be reasonably true to size with parallel sides and free from excessive cracks and other defects.

Moisture Content of brick when dried ready for use shall be not more than 4 percent.

Shrinkage Cracks shall be not more than 1/8 inch in width and 3 inches in length, and there shall be not more than three cracks per brick.

Compression Strength shall average 300 pounds or more, under recognized test methods, per square inch with tolerance to 250 pounds for one brick in a test series of five.

Absorption shall average less than 2½ percent of dry weight in 7 days.

Erosion. Bricks should not be appreciably pitted or eroded in two hours under a fine spray of water of 20 pounds pressure.

Modulus of Rupture shall average not less than from 40 to 50 pounds per square inch with tolerance to 30 pounds for one brick in a test series of five.

In laying up stabilized adobe building units a mortar which is the same mix as the bricks has been recommended for use, if coarse materials--(those not passing an 1/8 inch screen) are rejected. A mortar also found satisfactory by some is made using one sack of portland cement, 2½ or 3 cubic feet of sand, 1½ gallons of a good water-proofing admixture for mason's mortar and enough water for proper mortar consistency.

Lime mortar is not recommended for use in laying up asphalt or oil stabilized bricks. Well cured bricks should not be adversely affected but it is best not to take a chance. However, a cement-lime mortar has been successfully used. It may be prepared by mixing one volume of cement and one volume of hydrated lime (or one volume of quicklime putty) with approximately six volumes of sand, adding sufficient clean water, to produce the desired consistency.

If quicklime is used it must be slaked first. Different kinds of quicklime vary in the way they behave with water. If this is not identified in the manufacturer's directions a simple procedure may be followed to determine how to slake the particular lime available. Place a small quantity in an empty bucket, add water to just cover the quicklime, and observe how long it takes to begin slaking. If slaking begins in less than five minutes the quicklime is called "quick slaking;" from five to 30 minutes, "slow slaking." With "quick slaking" quicklime, the lime should always be added to the water by having all the water in the mortar box and adding the lime. For "slow

slaking" lime the water should be added by having all the quicklime in the box, the water being added slowly to expedite the slaking action.

Stabilization of Rammed Earth and Pressure Compacted Blocks

In the previous discussions of rammed earth building techniques it has been seen that sand and gravel as an admixture often may produce a stable weather resistant wall from a soil otherwise not too suitable. Authorities have said that, in soils typical of the United States of America, probably not more than 10 percent would rate as high quality without an admixture of sand and gravel.

However, under conditions which are severe an additional degree of stabilization to increase weather resistance is often desirable. Much time and effort has been expended in exploring this field. Tests using asphalt emulsions indicate increased weather resistance. However, it is difficult to use since the oil must be added to the soil when puddled or very wet, therefore necessitating subsequent drying out and grinding up before it can be rammed, or pressure compacted by machine into blocks. Some believe that this delay before final forming nullifies, at least in part, the stabilizing properties of the emulsion.

Although mixing lime with soil for building purposes goes back to ancient times the use of portland cement with soil has been contrary to generally accepted ideas about the use of cement. However, cement and lime are especially adaptable for stabilization of rammed earth and pressure compacted blocks, as has been briefly mentioned elsewhere in the paper and discussed in some detail in Chapter III in connection with an experience in Burma in the use of block compacted by machine under pressure.

These methods capitalize upon soils with a high sand content since the grain surface per unit of volume is reduced as the proportion of coarser material increases. Slightly larger percentages of lime are usually needed than are required for cement. The methods of introducing either admixture are similar and limited tests have indicated favorable results with lime and cement mixed in the ratio of 1/3 cement and 2/3 lime.

When portland cement is used as the stabilizing agent the combination is called soil-cement. The soil, cement, and water may be mixed in a single operation, if a pug mill or revolving paddle type mixer is available. Otherwise the preparation and mixing of the soil is similar to the hand methods described earlier for plain rammed earth. However, if earth is to be stabilized with either cement or lime by these methods, the stabilizer should only be added to an amount of soil which can finally be used within one hour--not longer.

In mixing, accuracy and good control are important. One interesting development, to insure correct proportions of soil and cement, even with extremely unskilled labor, accents the use of gauge boxes. One huge bottomless gauge box containing as much as one half cubic yard may be set on the ground, filled, top struck off level, and then lifted leaving a measured pile of soil on the mixing area. A small gauge box,



Figure X. 700 Soil-Cement Blocks per Day Were Made in a Hand Operated Machine at Ho Hsiang, Taiwan.

with a bottom may be used to add the proper proportions of cement or lime to the large pile of soil--after the soil has been spread out into a thin layer. Mix soil and cement until it is of an even color before adding water.

Optimum water content should be determined by the same general methods as discussed in the use of plain rammed earth without stabilization. The percentages of

cement or lime added to the soil for proper stabilization vary, as would be expected, with the texture of the soil. At Bogota, Colombia, a study was carried out by the Colombian government to evaluate the factors involved in using soil-cement for building simple structures in rammed earth and hand compacted earth blocks. Most of the soil samples with admixtures as low as 2 to 5 percent of cement by weight were found to be erosion resistant and maintained a 28-day compressive strength in the range of 200 to 400 pounds per square inch.

Although cement and lime appear to be the most practical admixtures to increase the stability of soil for use in rammed earth and pressure compacted blocks, where conditions require stability in excess of that provided by the soil itself (with or without the addition of sand) other agents have been investigated. These include, in addition to those previously mentioned: soft coal cinders, which had somewhat the effect of sand and after initial erosion presented a roughened surface which might be a key for a plaster coat; common salt, which results in a damp, crumbly, unsuitable wall; and tannic acid which has no effect favorable or otherwise.

Vinsol resin in a solution of three percent sodium hydroxide offers possibilities. It has been used in proportions of one-half percent to three percent dry soil weight. In proportions of one-half to two and one-half percent together with portland cement, properties of weather resistance and repellancy together with high strength were encouraging.

In both rammed earth and pressure compacted blocks, successful experiments have been made in "plating" the surfaces exposed to the weather by the introduction of soil-cement in the ratio of about 1:5 into the form in a thin layer before compaction. While this takes considerably more time when used with rammed earth it affects production of pressure compacted blocks little since a thin divider is placed in the form and easily withdrawn before pressure is applied. Although some difficulty has been experienced with plating, the plating layer usually appears to bond with the wall or block without difficulty and has often been found to be practical and successful.

Stabilization of Cob Constructions

In addition to being a suitable stabilizing admixture for rammed earth and compacted blocks, experiments in Africa with soil-cement improved the weather resist-



Figure XI. Plating an Earth Block with a Weather Resistant Soil-Cement Mixture to Provide a Cast-in-Place Impervious Facing. The divider is removed before the soil is compacted in the hand operated machine.

ance of cob. Also, shrinkage, which is the bane of those who build with cob, was found to be concentrated in a few large cracks rather than in a number of small ones common in unstabilized cob walls. Proportions of cement varied from 5 to 10 percent by volume. Experiments should continue. Also, it would be reasonable to assume that experiments in introducing oily substances to soil for cob construction would produce somewhat similar results as have been experienced in adobe construction.

CHAPTER V

EARTH FLOORS

Experiments on earth stabilized floors for light use indicate soil stabilized with cement or oil can be used for reasonably dust-proof, sanitary floors in low-cost housing, especially in underdeveloped areas.

Soil-Cement Floors

Soil meeting the tests for soil-cement discussed under stabilization of rammed earth above may be used for soil cement floors. Experiments have indicated that the sand-clay ratio should be about 75 percent sand and gravel and 25 percent silt and clay.

The proper moisture in the soil mixture should be the same as the optimum for making rammed earth walls in order that it will pack firm and hard. Methods of mixing soil, cement, and water are also similar. Keep soil moist before use. Soil that is too wet can be spread out and turned for drying.

To build soil-cement floors, the same general techniques are used as in building concrete floors. The sub-base, well compacted, is provided in the usual form. Many authorities believe that the floor itself should be of a minimum thickness of at least 3 inches, composed of two layers; one, called the finished base course would be a minimum of 1-3/4 inches thick when compacted. It could be of the soil mixture without the cement stabilizer. In the loose form, it would normally be about 3 1/4 inches deep before compaction. Metal tampers are normally used for compacting purposes. A popular unit has a head 6 inches square with a wooden handle and weighs from 20 to 25 pounds. A rammer made for use in walls could also be used successfully. A refinement is to use two rammers, one 10 inches square weighing 15 to 20 pounds for going over loose material the first time and for smoothing and finishing the surface, and a small rammer 4 inches square weighing 12 to 17 pounds for packing the material a little harder than the larger rammers. Usually the material is rammed twice with the smaller rammer and finished with the large one. Pneumatic rammers could, of course, be used but considerable experience might be necessary to obtain proper compaction.

The finished top course is of soil-cement. Cement is added to the soil mixture in the proper proportion determined as for rammed earth walls. In some cases, one part of cement to nine parts of soil has been found to be satisfactory. No pebbles larger than 1/4 inch are used in the finished top course since the larger stones have a tendency to "pop out," leaving holes to hasten disintegration. In fact, there is no reason for larger stones in the lower course. They merely are allowed to remain to avoid the need for unnecessary screening. The top course is laid in loose form about 3 inches thick so that, when compacted, it is 1 1/2 inches thick, making a total thickness of floor of about 3 1/4 inches.

As in normal concrete floor construction, the floor is usually built in sections using form boards or strips. These forms must be secured to solid stakes since

considerable pressure is exerted against the forms during ramming. Templates and straight edges are used to place the loose material and to check its compacted thickness.

If the soil mixture consists of subsoil plus additional sand and gravel, the mixing may be done on mixing boards or upon a section of the floor which has already been laid and cured for at least a week. The soil and sand for finished base course could be mixed in a concrete mixer if mixing is necessary, but the finished top course containing the cement should be mixed by hand, according to many authorities.

After the cement is added to the soil and the whole is mixed, it may be necessary to add more water to the mixture to obtain the proper consistency. If too dry, a poor floor will result. When cement comes in contact with the earth, it soon starts to "set up." Thus, only small batches can be mixed at one time. If the forms are spaced into floor sections about 6 feet wide, a batch of about 70 shovels works well since only batches that can be rammed in place within an hour should be mixed at one time. This will make a course about 6 x 6 feet in area. Always, when stopping work for the day, use a cross form so that the entire last batch may be rammed. The new work then starts at a joint.

The surface of the bottom course should be moistened thoroughly just before spreading the top course. Water should not stand on the surface.

After the floor is finished, it should be allowed to cure. It should be kept moist for from two to three days to a week's time, according to local conditions. Straw or newspapers retard the drying out process.

The Oil-Surfaced Floor

The oil surfaced floor is laid in the same manner as the soil-cement floor up to the finished top course. In fact, the finished base course and the thickness of placing it and the finished top course are the same in both cases. Requirements for the soil are the same. The only difference lies in the finished top course which consists of soil and asphalt instead of soil-cement.

The same type of oil may be used for all operations in building the floor. One good product is cut-back asphalt-cold mix, substantially the same as type RC-2 (rapid curing) road oil. RC-1, a lighter oil, has also been successfully used. Cut-back asphalts contain volatile oils that evaporate readily.

Before placing the finished top course, a primer coat is brushed over the surface of the finished base course at the ratio of about six quarts of the oil to one hundred square feet of surface. It is sprinkled on and brushed out evenly with an ordinary scrub brush placed on a long handle.

The loose soil mixture is then placed in the finished top course in the same manner as used in soil-cement work. Again, no pebbles larger than 1/4 inch should be in this mixture which is sprinkled after spreading with a filling oil coat of the

same cut-back asphalt. This is sprinkled on the loose fill. For estimating purposes, it may be assumed that it is sprinkled at the rate of 33 quarts per one hundred square feet of surface. Since the oil is sticky, it often is advisable to spread the oil with a sprinkler which can be discarded after use. Large tin cans with holes in the bottom made with a 6d box nail are suitable for use in warm temperatures. Sprinkling should be from a plank above the loose fill and should be done evenly. Then the surface is covered for curing. Do not attempt to ram before curing. During the curing period, a rubbery covering is forming on the loose soil which must not be broken since patching is extremely difficult. After it has been allowed to dry for about 24 hours, or until the operator can stand on it and follow the rammer, give it the first light ramming. If properly dried the soil will not stick to the rammer head. It is then rammed sharply twice more and then once again rammed lightly to a smooth surface. If two sizes of rammer are used, the second and third ramming should be with the small-headed, heavy rammer and the last ramming should be lightly done with the large rammer to finish the floor smoothly.

A seal coat of the same oil is then applied at about the rate of 5 quarts to 100 square feet. It should be sprinkled on and brushed out to even coverage with a scrub brush. After drying, the floor is ready for use. Final drying may be accelerated by lightly sifting fine sand over the seal coat.

Although oil in the proper proportions as determined by tests must be used, it is reasonable to assume that, as an average, 11 gallons of oil will make 100 square feet of floor.

If cut-back asphalt oil is not available, heavier road oils may be used. If the weather is not very warm, it will be necessary to heat them before using. Oil heavier than (medium curing) MC-3 probably will be hard to handle even in very warm weather. If heavier oils are used, more time must be allowed for drying.

Emulsified asphalt similar to that discussed in stabilization of adobe walls could probably be used in the stabilization of floors, although recorded experiences have not come to light. Of course, experimentation would be necessary to determine the best way to mix the emulsion with the soil at a dry enough consistency for ramming.

Other Stabilizers

Almost any stabilizer used for road construction could produce reasonably dust proof earth floors. Lime was popular in ancient times.

CHAPTER VI

EARTH ROOFS

Earth has been used as a building material for roofs since the early days of man. Often earth roofs have been satisfactory on the basis of reasonable standards. No doubt the application of the knowledge gained in stabilizing earth for walls, if applied to roof construction, can and will result in roofs of earth which should be of longer life and reduced maintenance than has heretofore been generally possible. This point should be kept in mind as the following paragraphs are read and, if considered advisable, experiments should be conducted to attempt to so improve roofs of earth, using soils available locally.

Adobe or Mud Roofs

In what may be considered typical techniques, Indians of the southwest portion of the United States of America construct earth roofs by placing poles as rafters or joists, pitched for drainage, resting on wood blocks or continuous reinforced concrete beams which in turn rest on the earth walls. These poles (vigas) support wood ceiling boards generally placed at right angles to them upon which a 3-inch layer of dry earth or volcanic dust is placed as insulation. A good grade of building paper is usually placed over the boards to prevent the dirt insulation from sifting through. The dirt is rolled or tamped until it is sufficiently solid to walk on. Over this a protective layer of saturated felt is placed carefully flashed against low parapets which are used with this type of construction in the Southwest.

The poles (vigas) serving as rafters are carefully wrapped for the full thickness of the walls with tarred or oiled oakum and set in a bed of asphalt mastic or other caulking compound. After any shrinkage of the earth wall has taken place additional caulking compound is forced into the exposed opening around the poles.

For economy wood "latillas" or poles $1\frac{1}{2}$ or 2 inches in diameter, either full round or split, are laid in herringbone pattern across the vigas in place of the boards as discussed above. A layer of mud mortar often replaces the top layer of saturated felt.

In Cape Coast, Africa, earth-built houses with mud roofs over 100 years old, kept in good repair, have been reported. Mud roofs are still common since a stable micaceous clay provides excellent material. Here flat roofs are made by laying rough poles 4 to 6 inches in diameter cut from bush at intervals of about 15 inches as joists with their ends intersecting the walls. As in the case in North America, smaller sticks are then placed tightly together over the joists to form a platform. A mixture of lateric clay and sand to which a very small quantity of slaked lime has been added is then prepared and laid over the platform. The mixture is rammed into position and its surface screeded off in such a manner that substantial falls are obtained to the rain water outlets. The thickness of the lime-earth mixture therefore varies from 18 inches or more to 8 inches.

Mud Brick Roofs

In 1934 a village of thirty brickhouses was built, together with a mosque, schools and public baths in Bahtim, Egypt, with roofs of wood, covered with sun-dried brick and plastered with mud as is the custom in that area. Eighteen years later, these houses were reported to be in good condition.

Of perhaps more interest is a second set of twenty houses built in 1936 with both walls and roofs of sun-dried brick. These houses have an area of 125 square meters each with two rooms in the front and a large court and stable in the back. The most noteworthy thing about this development is that eight of these units have dome roofs of sun-dried brick, there being sixteen domes in all. The only protection for the brick is a layer of mud plaster. The roofs were replastered in 1951, but on the whole, upkeep has been small. These domes have remained in excellent condition. The fact that they withstood the heavy rains of the winters without showing signs of failure speaks well for domes in the Delta even when built of ordinary sun-dried brick.

At the village of Gournna, also in Egypt, similar houses were recently built of earth using sun-dried mud brick in both the walls and domed roofs. Mechanics skilled in brick dome construction were able, in a short time, to teach local bricklayers to build domes of sun-dried brick without forms or centering. About 60 houses are involved.

Elliptical Rammed Earth Roof

An experimental building, still giving good service after three years, was erected in India in the form of a rammed earth semi-elliptical house containing two rooms and porch. Compaction was done between wooden planks supported on a semi-elliptical collapsible iron frame. No stabilizer was used in the soil. A mud plaster containing 5% cement was applied one-half inch thick to the exterior surface.

Experimental Domed Roof of Stabilized Cob Construction

An experimental domed roof of stabilized cob was built in Africa in 1944. The roof was a success during its short life, which ended when the walls of the building shifted and cracked the dome. A room 12 feet square with stabilized earth walls 12 inches thick was built by the cob method up to plate level. A wooden platform was then erected level with the plates, and sand heaped upon it to form the inner shape of the dome. Stabilized earth in the proportion of five parts of earth to one part of cement was then placed by the cob method over the sand, with a minimum thickness of five inches at the crown. After three weeks, a hole was cut in the platform and the sand run out. The platform was then taken down.

The roof remained in a safe and satisfactory condition for a month, during which time rain fell on several occasions but failed to penetrate. After a month had elapsed the walls of the dwelling began to crack and in opening out caused the dome to crack. It was then taken down, the walls repaired, and a conventional roof erected in its place.

CHAPTER VII

WALL FINISHES

Introduction

Walls of earth, to be of most value, must successfully resist moisture to which they are subjected. This resistance may come from the nature of the earth itself, from stabilization, from applied protective wall coverings, and from the actual design of the structure so as to give protection by means of resistive foundations, damp proofing courses in the walls, overhangs, verandahs, etc. This chapter will be devoted entirely to applied protective wall coverings.

Although authorities differ in expressing their opinions as to the need for protective wall coverings in different areas and when using different methods for building in earth, this difference of opinion is easily understandable when one considers the variables involved in the earth itself and in the techniques applied to its use.

In general, it may be said that plain rammed earth made of the most suitable soils, properly placed, may be expected to withstand erosion quite successfully in moderate climates if placed on proper foundations and protected at the top. Rammed earth of medium soils, if properly stabilized, may be expected to show very satisfactory characteristics.

Plain adobe walls in dry climates, with reasonable roof overhang protection often remain in excellent condition unless subjected to flooding. What erosion occurs often may be readily repaired. However, a protective surface coating for natural adobe is generally considered necessary in other than dry climates. Normally, properly stabilized adobe does not need an exterior protective covering.

Pressure compacted, machine made, earth blocks may be expected to perform similarly to rammed earth as it is used with or without stabilizing agents. In what may be considered a typical example, well made, unprotected, machine compacted, stabilized earth blocks in Africa have withstood the effects of weather for considerable periods of time and give promise of many more years of life before repair or protection will be necessary.

However, with any particular type of soil used with any of the methods which are adaptable to earth construction, so many variables are involved that tests, similar to those mentioned previously, should be made to determine whether or not a wall made from a particular soil by a particular method needs protective covering. In this connection remember that, in addition to the general reduction of the structural properties of earth which can come about through contact with moisture, wall leakages through joints in certain types of construction sometimes occur. All of these factors will determine whether or not protective wall finishes are indicated. One other factor, sometimes important, must not be lost sight of--protection of the wall against normal wear and tear. At times, too, wall finishes are applied purely for aesthetic reasons.

Heavy Rain Test

In many areas the permeability of a wall is one of the most important factors. It seems, as a general rule, that the lower the water absorption of the material at the time of laying, the lower the permeability of the wall, other things being equal. Tests have been developed to ascertain the amount of resistance to moisture penetration of earth walls. One, a heavy rain test, as described in BMS 7*, was performed as outlined below:

The specimen wall formed one side of a pressure chamber where air pressure of 10 pounds per square foot above atmospheric was maintained. Water from a perforated tube was sprayed on the exposed face at a rate of 40 gallons per hour for one day. Observations were for time of appearance of moisture (dampness) and of visible water on back of specimen wall; maximum rate of leakage through wall (moisture collected by flashing for collection and measurement of rate of flow); and extent of damp area on back at end of one day. Ratings:

- Good: No visible water on back in one day. Less than 50 percent of wall damp in one day; no leaks through wall.
- Fair: Visible water on back in more than three hours and less than one day. Rate of leakage less than one liter per hour.
- Poor: Visible water on back in three hours or less. Rate of leakage less than five liters per hour.

Very Poor: Rate of leakage greater than five liters per hour.

Coverings of a protective nature while having many records of durability are, in the main, considered by experienced operators as short lived, subject to considerable repair and, in general, to be avoided if possible. On the other hand, the experiences of others would indicate that protective coverings can be quite satisfactory when properly designed. All agree, however, that finishes must not be placed on a wall until it has completely "dried out." Many believe that when failures do occur they often result from moisture penetration through the finish and consequent softening of the wall with a failure of the bond.

The following discussions of the various types may be helpful. They range from the use of cement and lime stuccos through oil paints and mud plasters to washes.

Cement and Lime Stucco

Probably cement and lime stucco should be used only with a mechanical bond--at least under most conditions. Many believe that the use of a coating of strong material (cement and lime) over a weaker material (earth) is fundamentally unsound, as differences in expansion and contraction are said to cause cracking, leakage,

*National Bureau of Standards, United States Department of Commerce, Washington 25, D. C.

breaking of the bond and ultimate failure. In any event, it may be said that such stuccos are usually applied over some form of mechanical bond. One method, applicable to most ways in which earth is used as a wall material, is to provide bond by making several 3/4" deep depressions in each brick, if adobe, or about 8 inches apart, if monolithic, on the exposed face by striking with a hammer. Into these depressions zinc coated nails are driven downward at an angle and galvanized steel wire mesh is then attached covering the entire wall surface.

Another practice of applying wire mesh suitable only for adobe or cob is that of using a 6-foot length of 1-inch mesh, light gauge woven wire, laid at intervals (every sixth course if adobe brick construction) over the wall as it is being built. The ends are allowed to hang down on both sides where they are stapled with 2-inch staples to the wall faces for interior plaster and exterior stucco bases. For example, in a 12-inch wall with 4-inch thick brick and a 1/2-inch mortar joint the wire would overlap the wire below by 2 or 3 inches on both sides of the wall.

For economy the wire netting is at times omitted and reliance is placed entirely on nails and depressions for bond. Under these circumstances the nails are spaced as discussed above and the heads are driven flush with the exterior face of the wall. In a slight variation, the wall surface is swept down and sprayed with water and the scratch coat is applied by dashing it on. Following immediately, nails are driven through this fresh stucco into the wall. The wall is then allowed to stand for three days to three weeks and the second coat of stucco is applied. A third or finish coat can be used, if desired, or this second coat can be sand finished with a carpet float. No attempt should be made to apply extra thick coats of stucco. Ordinary thickness is better as the expansion forces will be less. After stuccoing in any weather the walls are kept damp by spraying or covering with wet bagging to facilitate curing and reduce tendency to crack.

Cement stucco in the southwestern part of the United States is often prepared of one part of cement to three parts of sand by volume with the addition of about ten pounds of hydrated lime to each bag of cement used. Lime stucco as used in the same area consists of one part of lime putty to three parts of sand by volume.

Statements from a 1926 report on the conditions of rammed earth buildings built between 1820 and 1854 near Sumter, South Carolina, USA, concerning the state of the stucco on a church built in 1850, are quoted below:

"The stucco is of lime mortar rough cast, coated with coarse sand and varying in thickness from 1/8 inch to 3/4 inch. The original color of this finish was a dull red, but later the stucco was whitewashed. The whitewash was covered recently with a cream colored commercial waterproofing preparation.

"All evidence points to the fact that cracks in the stucco are an indication of cracks or other defects in the wall underneath for where there are no wall cracks the stucco is solid and apparently as good as the day it was placed, even though only of lime mortar No stucco has fallen without an evidence of there first having been a crack."

The 4000 rammed earth houses previously mentioned, which were built in India as a portion of an emergency housing program, were protected with a portland cement stucco which, after four years, was reported as completely satisfactory. The stucco was composed of a 1:15 cement sand mixture applied over a cement wash of 1:3 cement water mixture. Results of experiments without the cement wash as an undercoating bond were not satisfactory; with the undercoating, when one-half inch thick stucco was placed between two sample blocks, the adhesive strength was determined to be a minimum of 12 pounds per square inch.

Dagga-Mud Plaster

Dagga is a mud plaster that has been used over earth walls for many centuries in many parts of the world, under many names. In dry climates or when well protected from driving rains and sharp mechanical injury natural dagga plaster will last indefinitely. Often striking colors may be secured from various colored clays.

One form used in the southwestern portion of the United States of America, which has given satisfaction contains enough fine sand so that the plaster will dry without checking. The sand and clay are screened through a No. 12 sieve (an ordinary fly screen). The actual volume of clay to sand is approximately three parts of sand to one of clay. Since almost any clay contains sand in considerable quantities the proper mixture often is approximated by mixing two measures of sand to one of average sandy clay subsoils.

If the proportion of sand in the clay is not known, trial mixtures can be made and applied to the wall upon which they are to be used. If they do not check in from two to four days and the bond is good it is probable that they will be satisfactory, with the limitations mentioned above.

Because of these limitations, efforts have been made to improve dagga so as to take advantage of one of its most desirable characteristics--its similarity to the material in the wall itself. Two methods for improvement have been satisfactory in many instances. In the first, dagga plaster is stabilized by adding asphalt emulsion. In the other, portland cement (or sometimes lime) is added. Oil might also perform satisfactorily as an admixture.

In adding asphalt emulsion it has been found that quantities ranging from one-half to one gallon of emulsion per 100 pounds of dry soil usually suffice when mixed with the mixing water. The proper proportions can be determined by mixing trial batches and testing them for cracking, adhesion, and weathering qualities in the same manner as discussed for walls. In India, a plaster of this type withstood the following test:

A spray of water under a head of twelve feet played on the specimens continuously for six days after which they were subjected to alternate wetting and drying (wetting at night and drying during the day) for 50 days. No moisture penetration into the surface was observed. No reduction in the original adhesion resulted.

When portland cement is used with dagga reasonable satisfaction is often experienced with cement-soil ratios not exceeding 10 percent by volume. Actually the mix should be as weak as practical. In Africa, a soil which has inherent stabilizing properties is used with sand and very low lime and cement content. It is called "Dutch Plaster." Lime is used in proportions never exceeding one to eight by volume. If the lime is a poor quality a small percentage of cement is added, not often exceeding one third of the volume of lime.

Although stabilized dagga plasters are sometimes applied with mechanical bonds as discussed above under stucco, they are often applied directly to the wall, usually in two thin coats. The wall is dampened before the first coat is applied and the dagga is kept moist during the early curing period.

Mud Paint

Especially in using adobe, it is sometimes desired to treat the walls in some manner to "improve" their appearance, even though additional protection is not necessary. One such simple treatment consists of applying a light coat of very fluid soil, the same as used to make the wall, using a wet cloth or burlap. This smooths the wall and removes protruding mortar from the joints, leaving all bricks neatly outlined.

Wall Paints

Although painting has not been considered satisfactory for durable finishes on earth walls this method of providing at least temporary protection or improved appearance has widespread use.

Natural (unstabilized) walls may be treated with waterproofing materials such as boiled linseed oil or tung oil. Sodium silicate may be applied. Paraffin dissolved in benzine and sprayed at a temperature of 70°F has been used. Commercial grades of masonry waterproofing have been applied.

A cheap whitewash finish may be made by adding 5 pounds of casein glue to 2 gallons of boiling water and dissolving 3 lbs. of trisodium phosphate with 3 gallons of water. Then both are mixed together and, to this mixture, is added a lime paste made of 50 lbs. of hydrated lime in 8 gallons of water stirring the whole mixture thoroughly. Just before using, add 3 pints of formaldehyde dissolved in 3 gallons of water. The whitewash can be colored to any tint by the addition of dry pigment. Apply only to shady side of wall by spraying--or work on cloudy days. In dry weather spray wall with water to allow mixture to cure slowly.

Portland cement washes have been used on earth walls. In this method loose particles are brushed from the surface and the wall is primed with a brush coat of white portland cement mixed with water, one sack of cement to six gallons of water. The coating is kept damp for five or six days until fully set and then painted with any good oil base paint or a second coat of cement wash, tinted as desired. One would expect that, except for color, natural portland cement would be as effective an ingredient as the white cement mentioned above.

Surfaces of rammed earth walls in Southern Rhodesia are successfully sprayed with a bitumastic emulsion and, when tacky, are "harled" with clean sharp sand thrown against the wall. The sand, then, provides a surface for a cement wash.

A method of using oil paints on asphalt stabilized earth which has been recommended by some authorities is to apply one coat of asphalt base aluminum paint to the clean dry surfaces. The asphalt base is compatible with the emulsion in the wall. The aluminum flakes in the paint lie flat and overlap thus preventing leeching through of the asphalt in the wall. The surface presented by the aluminum paint is believed to be suitable for oil painted finish.

Regardless of the kind of painted wall finishes under consideration it is well to remember that the final finish is a property of both the character of the wall and the character of the finish. Because of the variables involved probably the only sure test of a painted finish is the test of time. Accelerated laboratory tests may help. A simple field test which gives some sort of a relative approximation is to prepare samples with and without the proposed painted finishes and to then immerse them in water. The length of time that the specimens resist the water being the criterion.

Painted finishes which are difficult to apply, thus often resulting in "pin holes" in the finish, do not perform well.

A common plant which grows wild and in abundance in many tropical countries called *Euphorbia lactea*, a form of rubber plant, will provide a hard elastic white film on earth walls which is said to give considerable protection from tropical storms. Cuttings from the plant chopped up in a container exude a sticky liquid which is dashed on the walls. Often it is mixed with lime before using.

A form of cactus of the *Optuntia* family or Agave leaves are similarly used in South Africa. Caution should be exercised in using the materials since they are reported to be toxic.

Interior Finishes

Coverings on the interior sides of earth walls are not as critical as the protective covers often necessary on the outside wall faces. In addition to whitewash, which usually needs annual touching up, finishes range from cold water paints, oil paints, through common commercial plaster. Often, of course, no finish is considered necessary. On rammed earth walls painted finishes may be applied directly to the wall, or if desired, over dagga plaster applied as discussed elsewhere in the paper and as used frequently on adobe walls. Dagga plaster is often left exposed without other finish especially when the color of soil used in making the plaster results in an attractive appearing final product. In this case, waterproof glue is often used to reduce the amount of dusting on many types of interior walls. It may be made of six parts of cottage cheese and one part of quicklime with sufficient water to make it flow smoothly. It is transparent and thus retains the color of the earth.

Pozzolana

A pozzolana may be defined as a material which, though not cementitious of itself, contains silicious constituents which will combine with lime at ordinary temperatures to form cementing products related to those in portland cement.

Pozzolana has been found to be especially satisfactory for providing a finish to flat and vaulted masonry type roofs.

Pozzolana is suitable as a mortar and as a stucco rendering. In earth construction pozzolanas may be valuable because they do not develop the higher ultimate strengths of, for instance, portland cement.

A Test of Paint Finishes

In a recent study of surface painted finishes for bitumen stabilized walls, outlined in Ideas and Methods Exchange No. 14, March 1954,* experiences reported in Colonial Building Notes found, generally, that: brush applied surface finishes such as lime wash, exterior type "distempers," bituminous emulsions, polyvinyl acetate emulsions (flat finishes), and styrene emulsions in general showed high permeability to water (with bituminous emulsions variable) and in general high resistance to bleeding of bitumen (the exceptions were distempers and alkyd emulsions). Porous finishes tested were cement paints and colorless waterproofers. Both showed high permeability to water and cement paints showed high resistance to bleeding. Oil paints had a low water permeability factor and poor resistance to bleeding. Bitumen and tar paints had low permeability and, of course, resisted bleeding.

*Housing and Home Finance Agency, Washington 25, D. C., U.S.A.

CHAPTER VIII

THE DESIGN OF EARTH HOMES

One of the greatest advantages of earth in construction is the fact that the wide range of methods by which it may be used permits almost any soil to fall within one of the many categories as a building material. This very fact, of course, becomes, in a sense, a disadvantage to the designer. He must treat the wide range of resulting products almost as though they were separate and distinct building materials rather than one material--earth.

Common Properties of Earth

Thus, only a few basic properties are common to all or most types of earth construction. For instance, it is known, from test made by the National Bureau of Standards, United States of America, Department of Commerce,* that the thermal conductivities of natural adobe, asphalt stabilized adobe, and monolithic rammed earth walls are in the range expected for sand and gravel concrete. It might also be expected that blocks compacted by pressure in machines would show similar characteristics.

Although weights vary according to soil texture and compaction, typical samples of adobe (natural and stabilized) and rammed earth may be expected to range from 140 down to 100 pounds per cubic foot.

Some commonly accepted strength requirements for natural earth construction are in the range of 300 pounds per square inch in compression and 50 pounds per square inch in tension or shear. Although these factors vary with soil types and may be effected by stabilization, they are obviously lower than the usual for concrete.

For the structural design of walls of earth, recommendations range from a "factor of safety" of 6 to one of 10, thus permitting an extremely low or zero stress in tension or shear. Therefore it often becomes necessary to provide comparatively thick walls or introduce reinforcement. Many authorities recommend that walls of unstabilized earth be limited to one story and suggest a wall thickness of one-eighth to one-tenth of the wall height, under average circumstances, unless otherwise substantiated by responsible tests. In this connection it should be noted that, among other instances, heavy two story adobe construction is used in the southwestern part of the United States of America, and that comparatively thin walls of machine made, pressure compacted blocks have been quite extensively used in many areas.

It is well for the designer to remember, other things being equal, that rammed earth in monolithic form or earth compacted into blocks under pressure appear to be less dependent upon good drying weather during the curing period than, for instance, adobe.

*BMS-78

Earth is at its best, costwise, as a building material in areas of inexpensive labor and high costs of other building materials, since the materials for earth construction cost little or nothing. It would appear that the labor requirement per cubic foot of wall is something in the neighborhood of: for poured adobe about 1/4 man hour; for hand tamped rammed earth 3/8 man hour; for adobe brick 1/2 man hour; and for hand operated machine made pressure compacted blocks about 1/2 man hour.

Design Considerations

When the designer gets down to cases he will decide whether to use rammed earth, pressure compacted blocks, adobe, or cob as a construction material and whether or not a protective covering will be necessary, or the kind and amount of stabilizer, if any, that is to be used. In order to best make these decisions he will use information from simple field tests and laboratory investigations and his knowledge of local desires, customs, building practices, costs, and climatic conditions.

In a dry or semi-arid area he may determine, for instance, that the use of natural adobe would be most practical. If climatic conditions made it advisable and the economy permitted it, the addition of a stabilizing admixture to the soil might result in the best solution. Perhaps rammed earth or compacted blocks with or without a protective finish or a stabilizing agent would be the best answer in an area where proper drying periods for adobe brick were uncertain. If earth had previously been used in a particular manner he might decide to continue that method and meet the standards he had set through the introduction of better techniques. Thus it is possible that improved cob, poured adobe, or wattle and daub might offer the only hope for immediate shelter improvement. In any instance earth might be introduced to make practical floors or roofs.

Once a decision is made he will, on the basis of technical information available to him, prepare specifications outlining the manner in which the earth is to be used and the quality controlled. Structurally, he will be interested mainly in compressive strength, modulus of rupture, absorption, moisture content, and resistance to erosion, as reported by a responsible testing laboratory using recognized testing methods or-- in those rare cases where he decides to "go on his own"--as determined by short cut field tests, as previously outlined for making early investigations. In either case he must be fully aware of the limitations as well as the advantages of earth as a building material.

General Design Practices

Of course, earth construction should be located on well drained sites, free from flooding. Impervious masonry is desirable to a height above the finish grade which will prevent possible erosion from the "splash" of rain water and reduce capillarity. In certain instances stabilized earth has shown such qualities under test as to be suitable for this purpose with, perhaps, unstabilized earth above. In any event a damp proof course of suitable material should be placed in the wall below the finished floor line to prevent capillarity above. In the absence of typical damp proofing

material, slate or other dense local material may be built into the wall for the purpose. If a protective wall finish is to be placed on the surface of the walls it is considered advisable to project the impervious masonry so as to "take" the finish covering. A substantial foundation and footing, designed for the unit compressive soil bearing capacity, is essential.

In monolithic earth construction it appears that the amount of shrinkage varies with the amount of moisture in soil when it was placed. In any event vertical shrinkage cracks often seem to appear at fairly regular intervals along monolithic walls. In this case, vertical construction joints can be so placed in the walls as to take care of the cracks. Although it has not been adopted as regular practice, some authorities so design that any wall spans over eight feet in length are broken by a joint which would control the cracking, if any, to a regular pattern. It is well to bevel or round the external angles of the walls to reduce the possibility of injury to the sharp corners by impact.

Vertical shrinkage resembling settlement occurs in most types of earth construction at the rate of about one inch per 10 feet of height of wall. In rammed earth this is a result of curing of the wall while in adobe block it probably results from drying out of the mortar. To allow for this, door and window frames are often so set as to leave a clearance between the top of the frame and the lintel or plate above the opening so that the structure may later settle down on the tops of the frames.

One method used in bolting roof plates to the top of well bonded earth walls is to drill holes in the top of the wall, place bolts in them head down with the necessary length protruding, and grout them in. A layer of cement mortar over the top of the wall, which may be placed at this time, is often recommended as an additional precaution against moisture penetration. In one story construction it is desirable not to continue the earth wall over the tops of the openings if the design can be so arranged as to avoid it.

Even under the most favorable conditions, accepted practices place a maximum length of one story wall at 25 feet between masonry cross walls unless buttresses are provided. It also seems customary to limit openings in any length of wall to 35 percent of the length of wall and to establish a minimum of three feet of wall between openings or between opening and corner. Lintels, if any, usually bear at least nine lineal inches on each end of wall. Wall chases are often limited to allow a minimum of a 10-inch thick section of wall exclusive of the cut.

One possible exception to any generalization as to construction standards is the wall, built up of comparatively small units, laid dry without mortar, often of small, special shaped machine made compacted earth blocks, and sometimes only nine inches thick. Special care must be observed in a wall of this nature to avoid eccentric loading and to limit wall lengths and slenderness ratios in an appropriate manner.

Some design practices appear to have been quite widely adopted for houses of earth. In dry and semi-arid regions parapet walls are introduced. If so, they

should be carefully flashed, tops protected, and care should be taken to direct such water as does fall on the roofs well out from the wall. In less arid areas unstabilized earths are often given protection from weathering by extending the roof a considerable distance from the wall, while in rainy areas, many authorities insure that the design gives complete protection from the rains at all seasons.

In Earthquake Areas

Since earth wall construction has lower unit structural strength than many standard construction materials, where earthquake resistance is a deciding factor other materials might well be employed. However, in the opinion of some authorities well bonded earth will withstand seismic loads of moderate intensity if properly incorporated into a building of low, compact, and regular plan. In this case well bonded bearing walls should have a slenderness ratio not greater than 8. The foundations should be monolithic and a substantial continuous reinforced concrete bond beam should be placed on top of the wall bonded to all wall plates. Lightweight ceilings and roofs should be used, with the trusses or rafters and joists tied together and so placed on the plate as to avoid eccentric wall loading. Ceilings (and roofs) should be anchored to both side and end walls and constructed to serve as diaphragms to resist distortion.

APPENDIX A

GLOSSARY

ADOBE:

Any kind of clay soil which, when mixed with water to a plastic consistency (sometimes with a mechanical binder), can be made into a part of a structure. A structure made of such clay.

AZARAS:

Split palm trunks used as earth mix reinforcement in the construction of floors and flat or domed roofs in the arid zones of West Africa. Azaras are approximately 8 feet long.

BAUGE:

A mixture consisting of clay soil and straw, used for building earth walls between forms. (French)

CAJON:

A type of earth wall construction in which a clay soil mix of appropriate consistency is used in the form of wall panels supported by a structural wall frame. (Spanish)

COB:

Walls built of a fairly stiff mixture of clay soil, water, and small quantities of straw or other suitable mechanical binders. The mix is applied in consecutive layers without the use of shuttering, the wall faces being pared down as the work proceeds. Cob walls have also been built of a mixture of crushed chalk and water.

DAGGA:

A mixture of clay and sand used as a mortar in laying up earth blocks and as a plaster to protect the walls. Often stabilizing admixtures are added.

DAUB:

A rough coating of clay mortar applied by hand or trowel to both sides of a supporting framework of lathing or brushwork to form thin walls.

DUTCH PLASTER:

A dagga plaster, used in Africa, made of soil possessing inherent stabilizing properties mixed with sand, often with a very low lime and/or cement content.

LATERITIC SOILS (LATERITES):

Aeolian clay soils formed under tropical climatic conditions by the weathering of igneous rocks, usually of basic composition. They consist chiefly of hydroxides of iron and aluminum.

LATERIZATION:

The process of weathering whereby rocks are converted into laterites.

LIQUID LIMIT:

That moisture content in percent of dry soil weight at which the soil changes from a plastic to a liquid state.

MAXIMUM DENSITY:

See Optimum Moisture Content.

MOISTURE-DENSITY RELATIONSHIP:

Used to determine the percent of moisture in a soil at which the maximum density can be obtained for a given compaction effort.

MONOLITHIC ADOBE:

This term is often used to indicate cob. At other times it refers to Poured Adobe.

MUD CONCRETE:

See Poured Adobe.

MUD WALLING:

See Cajon and Nogging.

NOGGING

Rough earth, brick, or concrete masonry used to fill in the open spaces of a structural frame.

OPTIMUM MOISTURE CONTENT (MAXIMUM DENSITY):

Under a constant force of compaction the density of a soil-cement mixture varies as the moisture content of the mixture varies. If the moisture contents are plotted against corresponding dry densities the points will usually form a parabolic curve, the peak of which will indicate optimum moisture content and maximum density.

OSIERS:

A form of wattle made of willow branches and dry wood rods which are woven into a basket-like frame to receive a plaster of plastic earth.

PISÉ-de-TERRE:

The French term for rammed earth.

PLASTIC CONSISTENCY:

That moisture content at which a mixture will begin to "flow together" in mixing.

PLASTIC LIMIT:

That moisture content in percent of dry soil weight at which the soil changes from a solid to a plastic state.

PLASTICITY INDEX:

The numerical difference in the moisture content of the plastic and liquid limits.

PLATING:

A technique combining stabilized earth with common rammed earth by placing a thin cement-stabilized soil mix against the outward side of the formwork (forming the exterior wall face), the remainder being compacted with an ordinary unstabilized soil mix. Plating techniques may also be used in the manufacture of earth blocks.

POURED ADOBE:

A mixture of clay, soil, and water, of a fairly moist consistency enabling it to be cast between formwork and then left to dry. The process of casting may either be carried out in one operation to full wall height, or in successive operations by means of "climbing" formwork. Rocks are often embedded in the earth.

POZZOLANA:

A mixture which, though not cementitious in itself, will combine with lime to form cementing products.

PRESSURE COMPACTED MACHINE MADE BLOCKS:

Earth formed into building units by pressure, in hand operated or power driven presses, which are capable of exerting high pressures, applied by means of levers and linkages. Pressures of 1000 to 1500 pounds per square inch are not uncommon in forming the blocks.

PRESSURE STABILIZED:

Earth which has been stabilized by pressure.

RAMMED EARTH:

A mixture of sandy clay soil and water, of a slightly moist consistency enabling it to be compacted between shuttering for monolithic walls or in moulds for making individual blocks. Ramming may be carried out by either hand or machine.

SHRINKAGE LIMIT:

That moisture content expressed in percent of dry soil weight below which a change in moisture content causes no change in volume of the soil mass.

SOD HOUSES (Soddys):

Houses with walls and perhaps roof constructed of close matted sod cut into blocks. Usually laid in the wall with grassy side down. Used extensively in early days of the development of the Great Plains area of the United States of America.

SOIL-CEMENT (Lime) MIXTURE:

A mixture of soil and cement or soil and lime to produce a building material which will develop the desired properties after proper curing.

STABILIZED EARTH:

A mixture of sandy clay soils, water, and a limited quantity of certain stabilizing agents added to increase the strength, hardness, and moisture resistance of the material for structural purposes. Commonly used stabilizers include sand, lime, portland cement, and bituminous emulsions. Stabilized earth is used for both shuttered wall and block or brick wall construction, apart from its wide application to road construction work.

STABILIZER (Stabilizing Agent or Admixture):

Materials which, when mixed with immediately available earth, increase the weather resistant qualities of the product. Compressive strength may or may not be effected.

STANDARD CONSISTENCY:

A mixture which contains the optimum moisture content. (A soil-cement mixture at standard consistency will feel damp in the hands and will form a cast when squeezed that will stick together when handled.)

STANDARD STABILIZER CONTENT:

The stabilizer content is usually referred to as a percentage by volume of the compacted or puddled specimen.

SWISH:

A term applied in the Gold Coast more often than not to laterite.

SHWISHCRETE:

Swish (laterite) mixed with cement for use in construction.

TAPIA:

A form of adobe used in parts of Africa and Trinidad using a strong fibrous grass, often Sporobolus indicus, cut into short lengths, as a mechanical binder.

TERONI:

A form of construction similar to adobe brick and "soddys" in its application in which a sod block is cut in its natural bed in marsh lands and, after sun curing, is laid up in a wall, (A church built of Teroni in Albuquerque, New Mexico, in 1621 is still standing in good condition).

TERRACRETE:

An earth mixture containing portland cement as a stabilizer.

TORCHIS:

A mixture consisting of claysoil and cow hair, used for building daub walls.
(French)

TUBALI:

A West African term for hand-made, pear-shaped "bricks" made from a mix consisting of clay soil, water, and short pieces of fresh or dried grass. Tubalis are laid with their wide base downward in a bed of mortar, three, four or more abreast. Consecutive courses are placed with their bases interlocking between the pointed tops of the lower course. Tubali walls are built with a taper.

VIGAS:

Poles used as rafters for earth roof construction.

WATTLE:

A twig or flexible rod. A frame made of such rods.

WATTLE AND DAUB:

A woven frame of wattle which is smeared or daubed with plastic earth, the operation being continued until all construction cracks are filled.

APPENDIX B
BIBLIOGRAPHY ON EARTH CONSTRUCTION *

- "Adhesion of Plaster, Stucco, and Mortar to Various Structural Backings." Bulletin No. 68, Engineering Experiment Station, Virginia Polytechnic Institute, Blacksburg, Va.
- "Adobe." George W. Ramirez, Alhambra, Calif., 1946. 40 pp.
- "Adobe Architecture--Its Design and Construction." W. E. Groben. U. S. Forest Service, Department of Agriculture, Washington 25, D. C., Pub. M-5123, 1941.
- "Adobe as a Building Material for the Plains." Colorado Agricultural Experimental Station, Fort Collins, Colo., Bulletin 174, 1910.
- "Adobe as a Construction Material in Texas." E. L. Harrington. Texas Engineering Experiment Station, College Station, Texas, Bulletin No. 90. 1945.
- "Adobe as a Historical Source." Agricultural History, Chicago, Ill., July, 1931.
- "Adobe Brick Construction." Morris M. Sparks. U. S. Office of Technical Services, Washington 25, D. C., December, 1951. 13 pp. Bibliography on pp. 9-13. (PB105844).
- "Adobe Brick Stabilized with Asphalt." Construction Methods, New York, pp. 98-100, April, 1948.
- "Adobe Brick Stabilized with Asphalt." Engineering News Record, New York, pp. 132-133, January 22, 1948.
- "Adobe Construction." J. D. Long. University of California, Berkeley, Calif., Bulletin 472, Revised 1946. Available free from Agricultural Extension Service, College of Agriculture, University of California, Berkeley, Calif.
- "Adobe Construction." Harold C. Schwalen. Agricultural Engineering, St. Joseph, Mich., pp. 387-389, September, 1936.
- "Adobe-Construction Branch Libraries--Kern County Free Library, Bakersfield, California." D. Knief. Library Journal, New York, pp. 100-101, February 1, 1939. Illus.
- "Adobe Has Its Place, Too." C. A. Popkin. Nation's Schools, Chicago, Ill., pp. 33 and 39-40, September, 1944.
- "Adobe House." John W. Byers, Architect and Engineer, San Francisco, Calif., pp. 12-25, October, 1946.
- "Adobe House." A. H. Verrill. Country Life, Vernon, B. C., pp. 71-72, October, 1927. Illus.
- "Adobe House Around a Patio in Los Altos, California--P. L. Bernhard Home." American Home, New York, p. 28, August, 1940. Illus.
- "Adobe House Electrical." E. E. Whitehorne. House Beautiful, New York, pp. 60-62, January, 1922. Illus., plans.
- "Adobe or Sun-Dried Brick for Farm Buildings." Farmers' Bulletin No. 1720, U. S. Department of Agriculture, Washington 25, D. C., 1934.
- "Adobe Renaissance." R. F. Welch. Christian Science Monitor Magazine, Boston, Mass., p. 4, July 24, 1948.
- "The Adobe Sweetpotato Storage House in Arizona." F. J. Crider and D. W. Albert. University of Arizona, Tucson, Ariz. Available from Arizona Agricultural Experimental station, Tucson, Arizona.
- "Aided Self-Help in Housing Improvement." Ideas and Methods Exchange No. 18, International Housing Activities Staff, U. S. Housing and Home Finance Agency, Washington 25, D. C. Revised January, 1955.

- "Ancient Adobe Restored--Winter Home of S. C. Hamilton, Santa Fe." L. L. Cassidy. Sunset, Menlo Park, Calif. pp. 54-55, September 1928. Illus.
- "Application of Soil Cement to Low-Cost House and Farm Construction." (No. SCB-13). Available from Portland Cement Association, 33 Grand Avenue, Chicago, Ill. (Free in United States and Canada).
- "The Application of Soil Stabilization to Low-Cost Housing." Chas. Biggs and Humbert Causing. Princeton, N. J., 133 pp. (MStthesis in Engineering, Princeton University). Bibliography, pp. 129-133.
- "Arizona Adobe House with the Old Mesa Spirit--Home of B. J. O. Norfeldt, Santa Fe." Arts & Decoration, New York, p. 72, July, 1927.
- "Arts and Uses of Adobe." T. Conner. House Beautiful. New York, pp. 78-79, January, 1922. Illus.
- "Artist Turned Architect--Millard Sheets Creates Modern Rammed Earth Home at Claremont, California." M. H. Rector. American Home, New York, pp. 38-39, June 1944. Illus.
- "Asphalt Stabilized Adobe Block Used with Post and Girder Frame." Southwest Builder and contractor, Los Angeles, Calif., pp. 18-19, September 22, 1950.
- "Attractive Pise Dwelling." Queensland Agricultural Journal, Brisbane, Australia, August 1937.
- "Basic Principles of Soil-Cement Mixtures." Frank T. Sheets and Miles D. Catton. Engineering News Record, New York, June 23, 1938.
- "Bibliography." Special Issue. Housing and Town and Country Planning Bulletin No. 4, United Nations, New York, pp. 5-67, October 1950. (See "Rammed Earth." Special Issue--this bibliography).
- "Bitudobe Block Construction." American Bituminous Company, Baltimore, Maryland.
- "Bituminous Adobe Bricks." Melhem T. Samaha, Bourge-Hammond, Beirut, Lebanon. (Unpublished manuscript).
- "Build Your Own Adobe." Paul and Doris Aller. Stanford University Press, Stanford California 1946. 110 pp.
- "Building with Mud." Rural New Yorker, New York, p. 167, February 8, 1930.
- "Building with Mud, Rammed Earth or Pise de Terre." Blair Action Burrows. Toronto, Canada, Ontario Department of Lands and Forests, n. d. 46 pp.
- "Built by Hand with Bitudobe." James R. Brugger. American Home, New York, pp. 148-150, April 1950.
- "Built of Mud." A. H. Verrill. Scientific American, New York, pp. 110-111, August 1930. Illus.
- "Castles of Mud." S. MacDowell. Sunset, Menlo Park, Calif., p. 23, February 1926. Illus.
- "A Cheap Coating of Unstabilized Earth Walls." Ideas and Methods Exchange No. 2, Item J, International Housing Activities Staff, U. S. Housing and Home Finance Agency, Washington 25, D. C., December 8, 1952.
- "A Cheap Hard Floor of Earth Stabilized with Portland Cement." Ideas and Methods Exchange No. 1, International Housing Activities Staff, U. S. Housing and Home Finance Agency, Washington 25, D. C., November 1952.
- "Clay Soil Unfavorable for Rammed Earth Walls." Ralph L. Patty. Brookings, South Dakota, Department of Agricultural Engineering, Agricultural Experiment Station South Dakota State College March 1936. 23 pp. (Agricultural Experiment Station Bulletin 298).

- "Cohesion in Colloidal Soils." F. Hardy. Journal of Agricultural Science, Cambridge, England, pp. 430-433, No. 4, 1925.
- "A Comparison of the Hydrometer Method and the Pipette Method for Making Mechanical Analyses of Soils with New Direction." George J. Buoyoucos, Journal of the American Society of Agronomy, Washington, D. C., pp. 747-751, 1930.
- "La Construction en Beton de Terre." Bureau Central d'Etudes pour les Equipements d'Outre-Mer, Service de l'Habitat, Paris 1952. 66 pp.
- "Cottage Building in Cob, Chalk and Clay." Clough Williams-Ellis, New York, Charles Scribner's Sons, 1920.
- "Demonstration of Stabilized Mud Brick in Egyptian Village Housing." Arthur D. Little, Inc. U. S. Department of State, Washington 25, D. C., September 1953.
- "Design and Construction in the Tropics." G. Anthony Atkinson. Housing and Town and Country Planning, Bulletin No. 6, United Nations, New York, pp. 7-22, January 1952.
- "Determining Colloids in Soil for Rammed Earth Construction." Agricultural Engineering, St. Joseph, Mich., July 1935.
- "Development of Earth Building Blocks." John Edward Kirkham. Engineering Experiment Station. Oklahoma A & M College, Stillwater, Oklahoma, Publication No. 46, October 1940.
- "Dirt Cheap Houses." R. L. Holman. Colliers, New York, p. 45, February 3, 1945. Illus.
- "Dream in Adobe." California Citograph, Los Angeles, Calif., July 1945.
- "Earth Blocks by Puddling," American Home, New York, July 1947.
- "Earth Brick Construction," Elbert Hubbell, Education Division, Office of Indian Affairs, U. S. Department of the Interior. Printed at Chilocco Agricultural School, Chilocco, Oklahoma, 1943. 50¢
- "Earth Manual--A Manual on the Use of Earth Materials for Foundation and Construction Purposes." U. S. Bureau of Reclamation, Denver, Colo., 1951. 332 pp.
- "Earth Wall Construction." Part I Choice of Soil and Methods of Construction, No. SB13, no date.
 Part II Rammed Earth, No. SB18, June 1951.
 Part III Adobe Blocks (Puddled Earth) No. SB20, no date.
 Part IV Stabilized Earth, No. SB22, March 1952.
- All 4 are "Notes on the Science of Building" published by the Commonwealth Experimental Building Station, Department of Works and Housing, Chatswood, N.S.W., Australia, P. O. Box 30.
- "Earth Wall Construction: Pise or Rammed Earth, Adobe or Puddled Earth, Stabilized Earth." G. F. Middleton. Sydney, Commonwealth Experimental Building Station, 1952. 46 pp. (Australia Commonwealth Experimental Building Station Bulletin No. 5). Supersedes Duplicated document No. 28. References on pp. 45-46.
- "The Economical Builder--A Treatise on Tapia and Pise Walls." E. Gilman, Washington, D. C., 1939.
- "Effect of Soil Texture upon the physical Characteristics of Adobe Bricks." Harold C. Schwalen, University of Arizona, Tucson, Arizona. Technical Bulletin 58, 1935. Available free from the Arizona Agricultural Experiment Station, Tucson, Arizona.

- "El Paso, Texas--Patio Type Adobe Dwelling in Desert Sand." Design by Frank Lloyd Wright. Architectural Forum, New York, p. 97, January 1948.
- "Experimental Cottages." W. R. Jaggard. H. M. Stationery Office, London, England, 1921.
- "Experimental Features on Public Housing Projects." Frank J. Duane. U. S. Federal Public Housing Authority, Washington 25, D. C., 1945. 22 pp.
- "Experimental Results with Rammed Earth Construction." Agricultural Engineering, St. Joseph, Mich., November 1934.
- "Experiments in Rammed Earth Construction." U. S. Department of Agriculture, Farm Security Administration. (Succeeded by the Farmers Home Administration), Washington 25, D. C., November 1938. Reprinted June 1942. 8 pp. (FSA Pub. 59).
- "Experimental Soil-Cement Stabilization at Sheboygan, Michigan." Reprint Series No. 12, 1938, Department of Engineering Research, University of Michigan, Ann Arbor, Michigan. 32 pp. 50¢
- "Extracts--1944 Book of ASTM Standards." American Society for Testing Materials, Philadelphia, Pa.
- "A Fundamental Approach to the Stabilization of Cohesive Soils." H. F. Winterkorn. Proceedings of Highway Research Board, Washington, D. C., 1948. pp. 415-422.
- "Fundamental Similarities between Electro-Osmotic and Thermo-Osmotic Phenomena." H. F. Winterkorn. Proceedings of the 27th Annual Meeting of the Highway Research Board, Washington, D. C., December 1947. pp. 443-455.
- "Granddaddy of the Old Dude Ranch." E. Roorbach. Arts and Decoration, New York, pp. 28-30, June 1937. Illus.
- "Gumption Story No. 6--This \$1,020 Home Took 'Git Up and Get'." American Home, New York, May 1941.
- "Hard Surfaced Floors for Farm Buildings." Bulletin 393, J. L. Wiersma. Department of Agriculture Engineering, South Dakota Agricultural Experiment Station, Brookings, South Dakota, May 1949.
- "He Built His House on Weekends." House Beautiful, New York, March 1946.
- "Hearths of Santa Fe." R. L. Barket. House and Garden, New York, p. 86, February 1927.
- "Heavy Rain Test." In "Water Permeability of Masonry Walls," BMS 7, National Bureau of Standards, U. S. Department of Commerce, Washington 25, D. C., 1938. p. 12.
- "Historic Hacienda Grande, San Diego." C. Emery. Sunset, Menlo Park, Calif., pp. 50-51, September 1926. Illus.
- "Home Integrated with Creative Arts and Crafts--C and P Bolsius Home, Tucson, Arizona." B. M. Wadsworth. School Arts, Worcester, Mass., pp. 229-232, March 1944.
- "Homes Built of Rammed Earth." Compressed Air Magazine, Phillipsburg, N. J., March 1927.
- "Homes of Earth." Jacob L. Crane. United Nations, New York, 1951 (?), 12 pp. Issued for 1950 West Indian Conference.
- "House Adobe Built." Travel, New York, June 1945.
- "House of Earth in New Mexico." F. Glidden. American Home, New York, p. 32, November 1937. Illus.
- "House That Ben Built in Mesilla Park, New Mexico." L. C. Rutz. American Home New York, pp. 95-96, May 1940. Illus.

- "Houses Built of Earth, Birmingham, Alabama." *Architectural Record*, New York, October 1936.
- "Houses Built of Rammed Earth." *Literary Digest*, New York, p. 21, April 24, 1920. Illus.
- "Houses Dirt Cheap--Rammed Earth Building." S. Robinson. *Rotarian*, Chicago, Ill., pp. 24-27, August 1939. Illus.
- "Houses of Earth." Robert C. Cook. *New Republic*, New York, pp. 328-330, September 6, 1943.
- "Houses of Earth." A. B. Lee, Box 171, Washington, D. C., 1937. 44 pp.
- "Houses of Mud." J. W. Porter. *Scientific American*, New York, p. 233, April 1924. Illus.
- "Houses of Rammed Earth Construction." U. S. Department of Agriculture, Resettlement Administration, Washington, D. C., n. d., 4 pp. (Out of Print).
- "Housing Bulletin No. 2 of the Albert Farwell Bemis Foundation, MIT, Cambridge, Mass.", including:
1. Solidification of Soil by Means of Chemicals. Supervisor, Prof. T. William Lambe.
 2. Stabilization of Soils with Calcium Acrylate. Reprint from *Journal of the Boston Society of Civil Engineers*, Vol. 38, No. 2, April 1951.
 3. The Stabilization of Soils by In-Situ Polymerization. Presented before the American Society of Civil Engineers in New York, October 26, 1951.
- "Housing in Pise de Terre." Report by the National Building and Housing Board to the Secretary, Office of the High Commissioner for Southern Rhodesia, Salisbury, Southern Rhodesia.
- "How Germans Build Mud Houses." *Popular Science*, New York, p. 93, November 1947.
- "How the World is Housed." A. G. Carpenter. New York, American Book Company, 1930.
- "How to Build a California Adobe." Mark R. Harrington. Los Angeles, W. Ritchie Press, 1948. 57 pp. References on pp. 56-57.
- "How to Build Adobe and Concrete Block Houses." George C. Follis and Louis E. Dobson. Culver City, California, Murray & Gee, 1948. 32 pp.
- "How to Build Your Home of Earth." John Edward Kirkham. Engineering Experiment Station Publication No. 54, Stillwater, Oklahoma, 1943.
- "How to Build Your Own Home of Earth." Oklahoma Engineering Experiment Station, Stillwater, Oklahoma, Publication No. 64, 1946.
- "How to Sling Mud Constructively." H. R. Chapin. *Better Homes and Gardens*, Des Moines, Iowa, pp. 14-15, January 1941. Illus. plans.
- "The Hydrometer as a New and Rapid Method for Determining the Colloidal Content of Soils." George John Bouyoucos. *Soil Science*, Baltimore, Md., p. 319, April 1927.
- "The Hydrometer as a New Method for the Mechanical Analysis of Soils." George John Bouyoucos. *Soil Science*, Baltimore, Md., p. 343, May 1927.
- "I Wanted an Adobe House." V. Fincke. *Arts and Decoration*, New York, pp. 26-28, October 1937. Illus.
- "Importance of Volume Relationships in Soil Stabilization." H. F. Winterkorn and A. N. Dutta Choudbury. *Proceedings of the 29th Annual Meeting of the Highway Research Board*, Washington, D. C., December 1949, pp. 553-560.
- "Improve Physical Properties of Clays by Controlling pH Values." H. G. Scherecht. *Brick & Clay Record*, Chicago, Ill., pp. 18-21, March, 1938.

- "Investigation of Soils and Building Techniques for Rammed Earth Construction." Edsel J. Burkhart, Texas Engineering Experiment Station, College Station, Texas, Research Report No. 6, 1949.
- "Investigation of the Unconfined Compressive Strength of Soil-Cement Mixtures." U. S. Waterways Experiment Station, Vicksburg, Miss., Technical Memorandum No. 187-1, February 1942.
- "Laboratory Experiments with Lime-Soil Mixtures." A. Morgan Johnson. Proceedings of the 28th Annual Meeting of the Highway Research Board, Washington, D. C., December 1948.
- "Lime as an Admixture for Bases and Subgrades." K. B. Woods. Presented at the 31st Annual Convention of the National Lime Association, Washington, D. C., May 1949.
- "Low Cost Houses." India, Building Research Unit. Roorkee, U. P., September 1949. 44 pp. (B.R.U. Bulletin No. 1).
- "Making Mechanical Analyses of Soils in Fifteen Minutes." George John Bouyoucos. Soil Science, Baltimore, Md., p. 473, June 1928.
- "Mansions from Mud." Popular Mechanics, Chicago, Ill., p. 107, November 1947. Illus.
- "Machine for Making Stabilized Earth or Sand-Cement Bricks." Ideas and Methods Exchange No. 10, Item F, International Housing Activities Staff, U. S. Housing and Home Finance Agency, Washington 25, D. C., July 1953.
- "Mansions of Mud." J. L. Von Blon. Scientific American, New York. p. 218, February 28, 1920. Illus.
- "A Method of Soil Section and Job Control for Rammed Earth Construction." A thesis by Alva E. Koch, Civil Engineering Department, Texas Agricultural and Mechanical College, College Station, Texas.
- "Minimum Property Requirements for Properties of One or Two Living Units." U. S. Federal Housing Administration. Phoenix, Arizona Insuring Office, Section 406-I; Los Angeles, California Insuring Office, Section 406-I; Albuquerque, New Mexico Insuring Office, Section 406-I; Houston and San Antonio, Texas Insuring Offices, Section 406-0.
- "Modern Pioneers in Arizona." American Home, New York, October 1945.
- "Modernizing the Adobe." M. Brownfield. Sunset, Menlo Park, Calif., pp. 68-70, October 1920. Illus.
- "More Mud Houses." K. J. Ellington. Scientific American, New York, pp. 174-175, March 1925. Illus.
- "Mrs. Ingleby's Adobe." A. L. Murray. Sunset, Menlo Park, Calif., pp. 64-66, November 1922.
- "Mud House Comes Back--New Weatherproofing Process Revives Ancient Building Art." Popular Science, New York, p. 30, June 1937. Illus.
- "Mud House Won a National Prize." M. O. Williams. Sunset, Menlo Park, Calif., pp. 50-51, October 1928. Illus.
- "Mud Mansions--Detroit Co-op Builds Rammed Earth Homes." Business Week, New York, pp. 63-64, December 12, 1942. Illus.
- "A Mud Ranch House Designed by a California Engineer." R. M. Gray. Agricultural Engineering, St. Joseph, Mich., p. 276, 1926.
- "New Hard Surfaced Floors for the Farm Poultry House." R. L. Patty and L. F. Larsen, Circular No. 42, 1943. The Department of Agricultural Engineering, South Dakota Agricultural Experiment Station, Brookings, South Dakota.

- "New Methods, Old Type of Houses for Future, Rammed Earth Houses." Science News-Letter, Washington, D. C., p. 252, April 19, 1947.
- "New Slant on Solidifying Mud." Chemical Engineering, New York, January 1952.
- "New Use for Mud." Purdue Agriculturalist, Lafayette, Ind., March 1941.
- "New Way to Make Low-Cost Drives, Walks, Terraces, Barbeques--Stabilized Soil." Hans F. Winterkorn. The Countryman's Guide. The Country Bookstore, Noroton, Connecticut.
- "No Garrets for these Artists--Cinco Pintores Colony, New Mexico." L. L. Cassidy. Sunset, Menlo Park, Calif., pp. 64-65, November 1925. Illus.
- "Nouvelles Recherches en Matière de Stabilization des Sols." H. F. Winterkorn. Annales de l'Institut Technique du Batiment et des Travaux Publics, Paris, pp. 933-942, September 1952.
- "Old Adobe Comes Into Its Own--Finely Restored House in Monterey, California." P. Ackerman. House Beautiful, New York, pp. 565-567, December 1924. Illus.
- "Out of the Good Earth Will Come Our Dream House--Rammed Earth Houses." American Home, New York, pp. 24-26, September 1943. Illus.
- "Paints and Plasters for Rammed Earth Walls." Ralph L. Patty, Department of Agricultural Engineering, South Dakota Agricultural Experiment Station, Brookings, South Dakota, Bulletin No. 336, 1940. (Out of Print).
- "The Physical Properties of Adobe Used as a Building Material." Thomas T. Eyre, University of New Mexico, Albuquerque, New Mexico, Engineering Bulletin 263, 1935. 25¢
- "Physico-Chemical Testing of Soils and Application of the Results in Practice." H. F. Winterkorn. Reprint from Proceedings of the 20th Annual Meeting of the Highway Research Board, December 1940, pp. 798-806; Washington, D. C.
- "Pise Construction." Journal of Jamaica Agricultural Society, Kingston, Jamaica, May 1941.
- "Pise Construction of Farm Buildings." Queensland Agricultural Journal, Brisbane, Australia, July 1931.
- "Pise de Terre." Agriculture and Livestock in India, Calcutta, India, July 1939.
- "Pise de Terre." Rhodesia Agricultural Journal, Salisbury, September 1925.
- "Pneumatic Tamping in Rammed Earth Wall." Agricultural Engineering, St. Joseph, Mich., August 1929.
- "Pressed Clay for Building Construction." H. E. Glenn. Clemson, S. C., Clemson Agricultural College of South Carolina, Engineering Experiment Station, October 1951, 23 pp. (Engineering Experiment Station, Bulletin No. 5).
- "The Properties of Compacted Soil and Soil Cement Mixtures for Use in Building." T. L. Webb., T. F. Cilliers, and N. Stutterheim. National Building Research Institute, South African Council on Scientific and Industrial Research, Pretoria 1950, Series DR2.
- "Protective Coverings for Rammed Earth Walls." Agricultural Engineering, St. Joseph, Mich., March 1933.
- "Puddled Earth and Rammed Earth Walls." Agricultural Engineering, St. Joseph, Mich., August 1939.
- "Puyé in New Mexico." Geoffrey Grigson. The Listener, London, pp. 297-398, August 21, 1952.
- "A Qualitative Comparison of Rammed Earth and Sun-Dried Brick." Richard H. Clough. Albuquerque, N. M., University of New Mexico Press, 1950, 73 pp. (New Mexico University Publications in Engineering No. 4). \$1.00.

- "Rammed Earth, One of Man's Oldest Building Materials." Architectural Forum, New York, pp. 147-149, December 1946. Illus., plans.
- "Rammed Earth." Special Issue. Housing and Town and Country Planning Bulletin No. 4, United Nations, New York, pp. 5-67, October 1950. Articles: Rammed Earth Technique in France, by a. Marini; Rammed Earth Technique in the United States, by L. W. Neubauer; Rammed Earth Technique in West Africa, by A. E. S. Alcock; Training Course for Building Rammed Earth Houses in Nyasaland, by P. Williams. Glossary. Bibliography.
- "Rammed Earth Building Construction." H. E. Glen, South Carolina Agricultural Experiment Station, Clemson, S. C., Bulletin 3, 1943.
- "Rammed Earth Building Improved in Australia." American Builder, Chicago, Ill., pp. 182, 184, 186, 188, 190, May 1950.
- "Rammed Earth Construction." Rockwell King Du Moulin. Consumers Research, Inc., Washington, New Jersey, 1939.
- "Rammed Earth Construction." Thomas Hibben, U. S. National Youth Administration. Technical Information Circular No. 16, Supplemental No. 1, 1940. (Out of print--available in larger libraries.)
- "Rammed Earth Construction--Supplementary Information." Consumers Research, Inc., Washington, New Jersey, 1940.
- "Rammed Earth for Farm Building Walls." Agricultural Engineering, St. Joseph, Mich., January 1934.
- "The Rammed Earth House." Anthony F. Merrill. Harper & Brothers, New York, 1947. 230 pp.
- "Rammed Earth Houses." Louis J. Horn. Capper's Farmer, Topeka, Kan., November 1951.
- "Rammed Earth Lowers House Cost." G. H. Dacy, Popular Mechanics, Chicago, Ill., pp. 838-840, November 1924. Illus.
- "Rammed Earth Technique in France (Marini); Rammed Earth Technique in the United States (Neubauer); and Rammed Earth Technique in West Africa (Alcock)." Bulletin No. 4, Housing and Town and Country Planning, United Nations, October 1950.
- "Rammed Earth Walls for Buildings." Farmers' Bulletin No. 1500. U. S. Department of Agriculture, Washington 25, D. C., 1937. (Sup't. of Documents, Government Printing Office, Washington 25, D. C.) (Out of Print).
- "Rammed Earth Walls for Farm Buildings." Ralph L. Patty and L. W. Minium, Bulletin 227, 1933. (Rev. 1938, 1945, and 1947). The Department of Agricultural Engineering, South Dakota Agricultural Experiment Station, Brookings, South Dakota.
- "Rammed Earth Walls in House Construction, Experiences in Indonesia." Ideas and Methods Exchange No. 15, Item J, International Housing Activities Staff, U. S. Housing and Home Finance Agency, Washington 25, D. C., May 1954.
- "Rammed Soil for Building." Science News-Letter, Washington, D. C., p. 86, August 6, 1949.
- "Rapid Preparation of Soil Samples." Bob M. Gallaway. Excavating Engineer, South Milwaukee, Wisc., pp. 25-29, May 1952.
- "Recommended Minimum Requirements for Masonry Wall Construction." Bureau of Standards, U. S. Department of Commerce, Washington 25, D. C., BH 6, 1924.
- "The Relationship of Colloids in Soils to its Favorable Use in Pise or Rammed Earth Walls." Ralph L. Patty. Department of Agricultural Engineering, Agricultural Experimental Station, South Dakota State College, Brookings, South Dakota, Bulletin 298, March 1936. 24 pp.

- "Report from Morocco." G. E. Kidder Smith. Architectural Forum, New York, pp. 64, 68, 72, June 1950.
- "Report on Conditions of Rammed Earth Buildings Built 1820-1854, Sumpter, South Carolina." T. A. H. Miller, U. S. Department of Agriculture, Bureau of Agricultural Engineering, Washington 25, D. C., 1926.
- "Report of Committee on Lime--Soil Stabilization." American Road Builders' Association, Washington, D. C., Technical Bulletin No. 147, 1948.
- "Report of the Construction of Some Sample Rammed Earth Building Blocks which is the First Phase of a Continuing Experiment." Hindustani Talimi Sangh. Sponsored by the Ministry of Education of the Government of Bihar, India.
- "Report on Egyptian Village Housing, Building Materials and Methods of Construction." Arthur D. Little, Inc., Cambridge, Mass., April 1952.
- "Resinous Water Repellents for Soils." Technical Memorandum No. 217-1, May 1946. U. S. Waterways Experiment Station, Vicksburg, Mississippi.
- "Restored Adobe in Santa Barbara." M. D. Kern. American Home, New York, pp. 32-34, March 1936. Illus.
- "Restoring Our Devastated Regions." C. F. Ansley. Survey, New York, pp. 222-223, November 15, 1926.
- "Romance of the Adobe." A. L. Murray. Overland, San Francisco, Calif., new series, p. 349, August 1924. Illus.
- "Santa Barbara Adobes." Clarence C. Cullimore, with approval of Santa Barbara Historical Society; Santa Barbara, California, Santa Barbara Book Pub. Co., 1948. 225 pp.
- "Short-Cut Soil-Cement Testing Procedures for Sandy Soil." Soil-Cement Bureau, 1953. Available from Portland Cement Association, 33 Grand Avenue, Chicago, Ill.
- "A Six-Room House \$2,800 Complete." G. W. Pierce, Jr. The Technical Press, Swampscott, Massachusetts. \$2.00
- "The Sod House." Louise W. Mears. Journal of Geography, Chicago, Ill., pp. 385-389, June 1916.
- "Soil Admixtures for Earth Walls." Agricultural Engineering, St. Joseph, Mich., September 1942.
- "Soil Bituminous Roads." Current Road Problems No. 12, Highway Research Board National Research Council, Washington 25, D. C., September 1946.
- "Soil Cement Construction." J. H. Forbes. The Builder, London, pp. 359-360, September 14, 1951.
- "Soil Cement for House Construction." Ralph Stone. Civil Engineering, New York, pp. 1005-1007, December 1952.
- "Soil Cement for Low-Cost House and Farm Building Construction in Rural Areas." Portland Cement Association, Chicago, Ill., Rev, 1946.
- "Soil Cement Mixtures." A laboratory handbook containing directions of a technical nature for testing soil-cement mixtures for road paving. The same procedures are useful for testing soils for buildings. Portland Cement Association, Chicago, Illinois.
- "Soil Engineering at Princeton University." G. P. Tschebotarioff and H. F. Winterkorn. Reprint from Proceedings of the Second International Conference on Soil Mechanics and Foundation Engineering, Rotterdam, 1948. Vol. VI, pp. 230-232.

- "Soil Stabilization in Tropical Areas for Mass Construction of Cheap Permanent Housing." Ideas and Methods Exchange No. 9, Item J, International Housing Activities Staff, U. S. Housing and Home Finance Agency, Washington 25, D. C., May 1953.
- "Soil Stabilization--Symposium at Institution of Highway Engineers." The Surveyor and Municipal and County Engineer, London, England, pp. 789-792, December 8, 1951.
- "Soil Stabilization with Emulsified Asphalt." C. L. McKesson. Highway Research Board Proceedings, 15th Annual Meeting, 1935. Washington, D. C.
- "Soil Survey Manual." Charles E. Kellogg. U. S. Department of Agriculture, Miscellaneous Publication 274, Washington, D. C., 1938. 136 pp.
- "Soil Tests for Stabilized Soil Construction." Ideas and Methods Exchange No. 11, Item G, International Housing Activities Staff, U. S. Housing and Home Finance Agency, Washington 25, D. C., September 1953.
- "Solid Ground for Progress." Chemical Week, New York, May 10, 1952.
- "Specifications for Rammed Earth Construction." Agricultural Engineering, St. Joseph, Mich., November 1936.
- "Stabilized Earth Walls--Construction." Colonial Building Notes No. 8, United Kingdom Building Research Station, Watford, Herts, England, August 1952. 12 pp.
- "Stabilization of Soils by In-Situ Polymerization." T. William Lambe. Reprint of a paper presented before the American Society of Civil Engineers in New York, October 26, 1951.
- "Stabilization of Soils with Calcium Acrylate." T. William Lambe. Reprint from Journal of the Boston Society of Civil Engineers, Boston, Mass., April 1951.
- "Stabilize with Chemicals?" Chemical Engineering, New York, August 1952.
- "Stabilized Soil Blocks--Manufactured in Tropical Countries." British Constructional Engineer, London, England, August 1951.
- "Statement on Condition of Rammed Earth Houses." U. S. Department of Agriculture, Farmers' Home Administration, Washington 25, D. C., 1940.
- "A Story from the Southwest." Rural New Yorker, New York, p. 260, April 9, 1938.
- "Structural Heat-Transfer and Water Permeability Properties of Five Earth-Wall Constructions." H. L. Whittenmore, Ambrose H. Stang, Elbert Hubbell and Richard Dill, National Bureau of Standards, U. S. Department of Commerce, Washington 25, D. C., BMS Series No. 78, 1941. (Sup't. of Documents, Government Printing Office, Washington 25, D. C.) 20¢
- "The Suitability of Stabilized Soil for Building Construction." Edwin L. Hansen. Bulletin 333, Engineering Experiment Station, University of Illinois, Urbana, Ill. 45¢
- "Surface Finishes of Stabilized Earth Walls." Ideas and Methods Exchange No. 14, Item G, International Housing Activities Staff, U. S. Housing and Home Finance Agency, Washington 25, D. C., March 1954.
- "Swishcrete." Notes on stabilized cement-earth building on the Gold Coast. A. E. S. Alcock. Colonial Building Notes No. 16, Building Research Station, Watford, Herts, England, September 1953.
- "Tapia Brick Buildings." Ideas and Methods Exchange No. 2, Item I, International Housing Activities Staff, U. S. Housing and Home Finance Agency, Washington 25, D. C., December 8, 1952.
- "Tentative Method of Freezing and Thawing Test of Compacted Soil-Cement Mixtures." ASTM Designation D560-40T, 1940. American Society for Testing Materials, Philadelphia, Pa.

- "Tentative Method of Test for Moisture-Density Relations of Soil-Cement Mixtures." ASTM Designation D558-40T, 1940. American Society for Testing Materials, Philadelphia, Pa.
- "Tentative Method of Wetting and Drying Test of Compacted Soil-Cement Mixtures." ASTM Designation D559-40T, 1940. American Society for Testing Materials, Philadelphia, Pa.
- "Terracrete, Building with Rammed Earth-Cement." Obtainable only from the author, Mr. Francis MacDonald, Salinas, California, for \$1.00.
- "They Build with Dirt." E. A. Mumert. Country Gentlemen, Philadelphia, Pa., p. 27, September 1941.
- "Twenty-Nine Palms." M. V. Trigg. Atlantic Monthly, Boston, Mass., pp. 65-69, March 1945; pp. 65-66, April 1945.
- "The Use of Adobe in Construction." American Builder, Chicago, Ill., pp. 169-171, April 1951.
- "The Use of Earth as a Building Material." F. C. Fenton. Engineering Experiment Station, Kansas State College, Manhattan, Kans., Bulletin 41, 1941. Free.
- "Utilizing Earth as a Quantity Construction Material." Louis J. Horn. Texas Engineering Experiment Station News, College Station, Texas, pp. 3-7, March 1952.
- "Waterproofing Cohesive Soil by Resinous Treatment." H. F. Winterkorn, R. G. Fehrman and G. W. McAlphin. Reprinted from Soil Science Society of America Proceedings, Morgantown, W. Va., 1945. pp 458-460.
- "Waterproofing of Adobe." A. R. Legault, Colorado Agricultural Experiment Station, Ft. Collins, Colorado, Bulletin No. 5, 1943. Free.
- "Waterproofing of Adobe Tested to Extend Its Use Into the Rainy Areas of the State." Adrian R. Legault. Civil Engineering Section, Colorado Agricultural Experiment Station, Fort Collins, Colo. Reprint from Colorado Farm Bulletin, July-September 1943.
- "We'll Build it of Rammed Earth." Mat Kauten and Marie Kauten. Woman's Home Companion, New York, pp. 62-63, February 1949. Illus., plans.
- "Why I Built an Adobe Cottage." Charlotte P. Larkin. Kawakawa, Bay of Islands, N. Z., Northland Gazette, 1947. 51 pp.
- "Why Not Build Your Garden Walls of Earth?" R. L. Patty. American Home, New York, p. 12, August 1938. Illus.
- "Why Not Dirt Houses." E. Kirmser. American Mercury, New York, pp. 86-90, July 1947.
- "Why Not Rammed Earth?" Rotarian, Chicago, Ill., August 1946.
- "You Build Your Next House of Molasses." Michael Day. Popular Mechanics, Chicago, Ill., p. 110, September 1951.
- "Your Dream House Gets Down to Earth." M. D. Nelson and M. Kauten. American Home, New York, pp. 36-40, July 1944. Illus., plans.

BIBLIOGRAPHIES

- “Bibliography on Rammed Earth Construction.” U. S. Public Housing Administration, Washington 25, D. C., April 1952. 2 pp.
- “Bibliography on Soil Stabilization.” (Library Bibliography No. 76/JBB), Department of Scientific and Industrial Research, Road Research Laboratory, Harmondsworth West Dragton, Middlesex, England, October 1952.
- “List of References on Earth Construction.” H. H. Barrows. In President's Conference on Home Building and Home Ownership. Vol. II, Housing Objectives and Programs, Washington, D. C., 1932. pp. 96-99.
- “Rammed Earth Construction: Selected Bibliography.” Housing and Town and Country Planning Bulletin No. 4, United Nations, New York, pp. 60-67, October 1950.
- “Sources of Information on Earth Construction.” U. S. Department of Agriculture, Bureau of Plant Industry, Soils, and Agricultural Engineering, Division of Farm Buildings and Rural Housing, Washington 25, D. C., Revised July 1952. 4 pp.

NOTE: The Department of Housing and Urban Development does not have, either for distribution or sale, copies of the preceding identified publications, other than its own. They should be consulted at a technical library or public library or they may be ordered directly from their respective publishers, if given. This is a partial bibliography only and the inclusion of particular references is not to be interpreted as an indication that they are the best of their kind. No discrimination is intended by the inclusion or omission of particular items and no preference can be expressed or implied. Suggestions for additions to the preceding list will be welcomed.