

# MANUFACTURING YOGURT AND FERMENTED MILKS



*EDITOR*

**Ramesh C. Chandan**

*ASSOCIATE  
EDITORS*

Charles H. White

Arun Kilara

Y.H. Hui



**Blackwell  
Publishing**

# **Manufacturing Yogurt and Fermented Milks**

# **Manufacturing Yogurt and Fermented Milks**

## **Editor**

Ramesh C. Chandan

## **Associate Editors**

Charles H. White

Arun Kilara

Y. H. Hui



**Blackwell**  
Publishing

**Ramesh C. Chandan, Ph.D.**, is a consultant in dairy science and technology with special expertise in the manufacture of yogurt and fermented milks. He has more than 40 years experience with various food companies, including Unilever, Land OLakes and General Mills. He served on the faculty of the Department of Food Science and Human Nutrition, Michigan State University, East Lansing from 1976–82.

**Charles H. White, Ph.D.**, is professor and former Head of the Department of Food Science, Nutrition and Health Promotion at Mississippi State University.

**Arun Kilara, Ph.D.**, is a food industry consultant specializing in dairy foods, ingredient functionality, product development, and training. He has served on the faculty of Penn State University for more than 20 years.

**Y.H. Hui, Ph.D.**, is a food industry consultant and has served as the author, editor, or editor-in-chief of numerous books in food science, technology, engineering, and law.

© 2006 Blackwell Publishing  
All rights reserved

Blackwell Publishing Professional  
2121 State Avenue, Ames, Iowa 50014, USA

Orders: 1-800-862-6657  
Office: 1-515-292-0140  
Fax: 1-515-292-3348  
Web site: [www.blackwellprofessional.com](http://www.blackwellprofessional.com)

Blackwell Publishing Ltd  
9600 Garsington Road, Oxford OX4 2DQ, UK

Tel.: +44 (0)1865 776868

Blackwell Publishing Asia  
550 Swanston Street, Carlton, Victoria 3053, Australia  
Tel.: +61 (0)3 8359 1011

Authorization to photocopy items for internal or personal use, or the internal or personal use of specific clients, is granted by Blackwell Publishing, provided that the base fee of \$.10 per copy is paid directly to the Copyright Clearance Center, 222 Rosewood Drive, Danvers, MA 01923. For those organizations that have been granted a photocopy license by CCC, a separate system of payments has been arranged. The fee codes for users of the Transactional Reporting Service are ISBN-13: 978-0-8138-2304-1; ISBN-10: 0-8138-2304-8/2006 \$.10.

First edition, 2006

Library of Congress Cataloging-in-Publication Data

Manufacturing yogurt and fermented milks /  
editor, Ramesh C. Chandan ; associate editors,  
Charles H. White, Arun Kilara, Y. H. Hui.—1st ed.  
p. cm.

Includes bibliographical references and index.

ISBN-13: 978-0-8138-2304-1 (alk. paper)

ISBN-10: 0-8138-2304-8 (alk. paper)

1. Yogurt. 2. Fermented milk. 3. Dairy  
processing. 4. Food industry and trade.  
I. Chandan, Ramesh C.

SF275.Y6M36 2006  
637'.1476—dc22

2005017248

The last digit is the print number: 9 8 7 6 5 4 3 2 1

# Contents

*Contributors*, vii

*Preface*, ix

## **Part I Basic Background**

1. History and Consumption Trends, 3  
*Ramesh C. Chandan*
2. Milk Composition, Physical and Processing Characteristics, 17  
*Ramesh C. Chandan*
3. Regulatory Requirements for Milk Production, Transportation, and Processing, 41  
*Cary P. Frye*
4. Regulations for Product Standards and Labeling, 57  
*Cary P. Frye*
5. Basic Dairy Processing Principles, 73  
*Arun Kilara*
6. Starter Cultures for Yogurt and Fermented Milks, 89  
*Ebenezer R. Vedamuthu*
7. Laboratory Analysis of Fermented Milks, 117  
*Robert T. Marshall*
8. Fermented Dairy Packaging Materials, 129  
*Aaron L. Brody*

## **Part II Manufacture of Yogurt**

9. Yogurt: Fruit Preparations and Flavoring Materials, 151  
*Kevin R. O'Rell and Ramesh C. Chandan*
10. Milk and Milk-Based Dairy Ingredients, 167  
*Isabelle Sodini and Phillip S. Tong*
11. Ingredients for Yogurt Manufacture, 179  
*Ramesh C. Chandan and Kevin R. O'Rell*
12. Principles of Yogurt Processing, 195  
*Ramesh C. Chandan and Kevin R. O'Rell*
13. Manufacture of Various Types of Yogurt, 211  
*Ramesh C. Chandan and Kevin R. O'Rell*
14. Plant Cleaning and Sanitizing, 237  
*Dennis Bogart*

15. Yogurt Plant: Quality Assurance, 247  
*Ramesh C. Chandan and Kevin R. O'Rell*
16. Sensory Analysis of Yogurt, 265  
*Yonca Karagül-Yüceer and MaryAnne Drake*

### **Part III Manufacture of Fermented Milks**

17. Cultured Buttermilk, 279  
*Charles H. White*
18. Cultured/Sour Cream, 285  
*Bill Born*
19. Other Fermented and Culture-Containing Milks, 295  
*Ebenezer R. Vedamuthu*

### **Part IV Health Benefits**

20. Functional Foods and Disease Prevention, 311  
*Ramesh C. Chandan and Nagendra P. Shah*
21. Health Benefits of Yogurt and Fermented Milks, 327  
*Nagendra P. Shah*
22. Probiotics and Fermented Milks, 341  
*Nagendra P. Shah*

*Index, 355*

# Contributors

Dennis Bogart (Chapter 14)  
Randolph Associates Inc.  
3820 3rd Avenue South, Suite 100  
Birmingham, AL 35222 USA  
Phone: 205-595-6455  
Fax: 205-595-6450  
E-mail: dennis\_bogart@yahoo.com

Bill Born (Chapter 18)  
Dairy Consultant (Retired from Dean  
Foods Company)  
7254, South Main  
Rockford, IL 61102 USA  
Phone: 815-965-2505  
Fax: 815-968-9280  
E-mail: blbor@aol.com

Aaron L. Brody, Ph.D. (Chapter 8)  
President & CEO  
Packaging/Brody, Inc.  
PO Box 956187  
Duluth, GA 30095-9504 USA  
Phone: 770-613-0991  
Fax: 770-613-0992  
E-mail: aaronbrody@aol.com

Ramesh C. Chandan, Ph.D.  
(Editor, Chapters 1, 2, 9, 11–13, 15, 20)  
Consultant  
1364, 126th Avenue, NW  
Coon Rapids, MN 55448-4004 USA  
Phone: 763-862-4768  
Fax: 763-862-4768  
E-mail: Chandanrc@aol.com

MaryAnne Drake, Ph.D. (Chapter 16)  
Department of Food Science  
North Carolina State University  
PO Box 7624  
Raleigh, NC 27695 USA  
Phone: 919-513-4598  
Fax: 919-513-0014  
E-mail: mdrake@unity.ncsu.edu  
P: (919) 515-4598; F: (919) 515-7124

Cary P. Frye (Chapters 3, 4)  
Vice President Regulatory Affairs  
International Dairy Foods Association  
1250 H Street, N.W., Suite 900  
Washington, DC 20005 USA  
Phone: 202-737-4332  
Fax: 202-331-7820  
E-mail: cfrye@idfa.org

Y. H. Hui, Ph.D (Associate Editor)  
Senior Scientist  
Science Technology System  
P.O. Box 1374  
West Sacramento, CA 95691, USA  
Phone: 916-372-2655  
Fax: 916-372-2690  
E-mail: yhhui@aol.com

Arun Kilara, Ph.D. (Associate Editor, Chapter 5)  
Principal  
Arun Kilara Worldwide  
(An affiliate of Stratecon International Consultants)  
516 Copperline Drive  
Chapel Hill, NC 27516  
Phone: 919-968-9322  
Home: 919-370-9684  
Cell: 603-491-5045  
www.akilara.com  
www.stratecon-intl.com  
E-mail: kilara@ix.netcom.com

Robert T. Marshall, Ph.D. (Chapter 7)  
Professor Emeritus  
Department of Food Science  
University of Missouri  
122 Eckles Hall  
Columbia, MO 65211 USA  
Phone: 573-882-7355  
Fax: 573-882-0596  
E-mail: Marshallr@missouri.edu

Kevin R. O'Rell (Chapters 9, 11–13, 15)  
Vice President, R&D/QA  
Horizon Organic  
6311, Horizon Lane  
Longmont, CO 80503 USA  
Phone 303-530-2711, ext 175  
Fax: 303-516-7252  
Cell: 303-579-4507  
E-mail: Kevin.OREll@whitewave.com

Nagendra P. Shah, Ph.D. (Chapters 20–22)  
Professor of Food Science and Technology  
School of Molecular Sciences  
Victoria University  
PO Box 14428  
Melbourne City Mail Centre  
Victoria 8001, Australia  
Phone: 61 3 9919 8289  
Fax: 61 3 9919 8284  
E-mail: Nagendrashah@vu.edu.au

Isabelle Sodini, Ph.D. (Chapter 10)  
Portocork America  
560, Technology Way  
Napa, CA 94558-6722, USA  
Phone: 707-258-3930  
Fax: 707-258-3935  
E-mail: isodini@mac.com

Phillip S. Tong, Ph.D. (Chapter 10)  
Director, Dairy Products Technology Center  
California Polytechnic State University  
San Luis Obispo., CA 93407 USA  
Phone: 805-756-6102  
Fax: 805-756-2998  
E-mail: ptong@calpoly.edu

Ebenezer R. Vedamuthu, Ph.D. (Chapters 6, 19)  
332 NE Carmen Place  
Corvallis, OR 97330 USA  
Phone: 541-745-5206  
E-mail: cheesetec@yahoo.com

Charles H. White, Ph.D.  
(Associate Editor, Chapter 17)  
Mississippi State University  
Department of Food Science, Nutrition and  
Health Promotion  
PO Box 9805  
Mississippi State, MS 39762-9805 USA  
Phone: (662)325-2473  
Fax: (662)325-8728  
E-mail: chwhite@ra.msstate.edu

Yonca Karagül-Yüceer, Ph.D. (Chapter 16)  
Assistant Professor  
Çanakkale Onsekiz Mart University  
Department of Food Engineering  
Terzioğlu Campus  
17020 Canakkale, Turkey  
E-mail: yoncayuceer@comu.edu.tr  
Tel: +90 (0) 286 218 00 18, Ext. 1729  
Fax: +90 (0) 286 218 05 41



# Preface

Fermented dairy products other than cheeses have been consumed around the world for thousands of years. Nevertheless, their industrial production is relatively a new innovation. Yogurt has emerged as an outstanding new product of recent times. It has occupied a very significant position of consumer acceptance and growth in North America and throughout the world. In the United States, yogurt, buttermilk, sour cream, and probiotic drinks have become a multi-billion-dollar industry. The yogurt market continues to grow on an annual basis.

The literature on yogurt and fermented milks is vast and diverse. It encompasses the basic and fundamental aspects as well as the applied and practical facets of the industry. This book is intended to disseminate the applied and practical aspects. Some basic science is included only to facilitate understanding of the practice of manufacturing yogurt and fermented milks. Overall, our objective is not to provide fundamental information. Instead, attempts have been made to deal with the application of the science of yogurt and fermented milks to their manufacture and emphasize the practices in vogue in the industry.

As mentioned above, this book is dedicated to the manufacture of yogurt and fermented milks. In view of the multidisciplinary nature and continued fast developments in the technology and packaging of fermented milks including yogurt, the book has multiple authors. The authors drawn from the industry and academia are acknowledged as experts in their respective fields. Many authors have utilized their lifelong experience in the product development, quality assurance, and manufacture of yogurt and fermented milks in their contributed chapters. Their contribution to the writing of the book makes this book unique and first of its kind in the literature. From comprehension

and readability standpoint, an effort has been made to make the book reader-friendly.

The book is organized into twenty-two chapters and divided into four parts. Part I covers the basic background with eight chapters. The objective is to prepare the reader for the manufacturing of yogurt and fermented milks by providing relevant information on product trends, regulatory aspects, dairy processing technologies, packaging techniques, starter cultures use, and laboratory analysis.

Part II is devoted to the manufacture of yogurt. This part also consists of eight chapters. It includes raw materials, namely dairy and dairy-based ingredients, fruits and flavors, stabilizers, sweeteners (nutritive and high intensity), principles of yogurt processing, types of yogurt products on the market and their manufacturing techniques, quality control procedures, sensory evaluation of yogurt, and plant cleaning and sanitizing programs. The formulation, regulatory aspects, labeling, processing equipment, and packaging operations of various products have been included.

Part III contains three chapters detailing the manufacturing technology of cultured buttermilk, sour cream, and miscellaneous fermented milks popular throughout the major regions of the world. It also includes culture-containing milks that are not cultured and retain the sensory characteristics of milk but concomitantly provide beneficial probiotic cultures to the consumer.

Part IV deals with the overall health benefits of yogurt and fermented milks. This topic has assumed much interest in view of consumer perception of health promotion attributed to functional foods like yogurt and fermented milks. This part brings to the reader a brief review of our understanding of both perceived and real benefits. A concise account of the scientific and clinical evidence associated with the

benefits of consuming yogurt and milks containing probiotic cultures, prebiotics, and synbiotics has been reviewed. This is a timely subject because new products with health claims are increasingly appearing in the market. We feel that this is the direction for future growth of the industry engaged in yogurt and fermented milks manufacture.

This book is the culmination of efforts to provide a systematic and relatively simplified version of the information available on significant aspects of manufacturing yogurt and fermented milks. It is intended as a textbook to be used by upper undergraduate university students of dairy and food science to learn theory and practice of technology associated with the manufacture of yogurt and fermented milks. Graduate students should find the book useful as a reference book to obtain information on applied science and technology of yogurt and fermented milks. The industrial bias of the book should appeal to the practitioners of food science and technology in the food industry. In this case, it would provide a ready reference

material for plant operators, personnel performing functions in quality control/assurance, and research and development. The book should also be helpful for food industry personnel engaged in taking purchasing decisions. Since the book conveys collated practical information on yogurt and fermented milks in entirety, it should be useful as a textbook to the instructors and participants of the industry-oriented short courses on cultured dairy products.

We acknowledge the worldwide contribution of all the scientists, technologists, and engineers who have established modern principles for the manufacture of yogurt and fermented milks to provide the consumer with a truly functional family of foods that furnish vital dairy nutrients as well as unique, wholesome, and healthy products.

Ramesh C. Chandan, Minneapolis, MN  
Charles H. White, Mississippi State, MS  
Arun Kilara, Chapel Hill, NC  
Y. H. Hui, Sacramento, CA

# **Part I**

# **Basic Background**

# 1

# History and Consumption Trends

*Ramesh C. Chandan*

- Overview of the World Dairy Industry
- Milk Production in the United States
- Production of Dairy Foods in the United States
- Fermented/Cultured Dairy Products
- Occurrence and Consumption of
  - Fermented Milks in Various Regions
    - Milk of Various Species
    - Cultures for Production of Fermented Milks
    - Forms of Fermented Milks
- Major Commercial Fermented Milks
- Fermented Milks of Scandinavia
- Fermented Milks of Russia and East Europe
- Fermented Milks of Middle East
- Fermented Milks of South Asia
- References
- Bibliography

## OVERVIEW OF THE WORLD DAIRY INDUSTRY

The world production of cow's milk in the year 2003 was 398 million metric tons (see Table 1.1). The documented number of cows was 125,490 thousand heads. Individual cow milk yield varies widely in the world. Japan was the most efficient milk producer with a yield of 8.71 t/cow, followed by the United States with a yield of 8.50 t/cow.

## MILK PRODUCTION IN THE UNITED STATES

During the last decades, the trend indicates decrease in dairy cow population (Table 1.2). Currently, nearly nine million cows produce 77.25 million metric tons (170,312 million pounds) of milk (USDA, 2004). As indicated in Table 1.2, there is a steady increase in milk production per cow. Approximately 20% of the

world's milk is produced in the United States. The American dairy farmer has been able to achieve the current milk output by applying scientific and management advancements in milk production. On the dairy farm, selection of dairy cows, their breeding, and judicious use of balanced feed rations have been instrumental in increasing milk output per cow. In the year 2003, milk production per cow increased to 8,507 kg (18,749 lb). As a result of continuous efficiencies in milk production at the farm, milk production per cow has doubled in the last 30 years.

## PRODUCTION OF DAIRY FOODS IN THE UNITED STATES

Modern milking and milk-handling equipment, including automated milking systems, have improved the speed of cleaning, sanitizing, cooling, and delivering good quality raw milk to processing plants. The United States has the distinction of being the largest processor of milk and dairy products in the world. Advanced processing and packaging technologies ensure efficient delivery and shelf life of high-quality milk products, including yogurt and fermented milks. Currently, there are 800 dairy processing plants in the United States, where milk is transformed into more than 300 varieties and styles of cheese, 100 flavors of ice cream and frozen yogurt, and 75 flavors of several types of refrigerated yogurt. Dairy plants also produce an array of flavored and white milks ranging from fat-free to full fat, butter, sweetened condensed milk, evaporated milk, dry milk, lactose, and whey products, as well as cultured products such as sour cream and dips, buttermilk, yogurt, and yogurt drinks. More recently, the industry has introduced packaging and marketing innovations to compete

**Table 1.1.** Milk Production in the World in 2003

Country	Milk Cows (1000 head)	Milk Yield/Cow-(t)	Total Milk Produced (1000 t)
Canada	1,065	7.30	7,778
Mexico	6,800	1.00	9,784
United States	9,084	8.50	77,253
Argentina	2,000	3.98	7,950
Brazil	15,300	1.49	22,860
Peru	630	1.95	1,226
European Union	24,690	5.35	132,044
Romania	1,684	3.21	5,400
Russia	11,700	2.82	33,000
Ukraine	4,715	2.84	13,400
India	36,500	1.00	36,500
China	4,466	3.91	17,463
Japan	964	8.71	8,400
Australia	2,050	5.19	10,636
New Zealand	3,842	3.73	14,346
Total selected countries	125,490	–	398,040

Source: USDA, Service, FAS/CMP/DLP December, 2004.

<http://www.fas.usda.gov/dlp/circular2004/64-12Dairy/cowprod.pdf>

aggressively for consumer food dollar share. Table 1.3 lists the products manufactured and their volumes during 1997–2002.

Dairy farmers and dairy processors alike abide by strict state and federal sanitary standards. Grade A Pasteurized Milk Ordinance (PMO) regulations are the recommendations of the Public Health Service of the Food and Drug Administration of United States Department of Health and Human Services (DHHS, 1999). The PMO is meant for voluntary adoption, but its importance in ensuring the quality and safety of milk supply in the country is recognized by the dairy industry as well as by the state regulatory

and sanitation officials. The PMO is a constantly evolving set of regulations to accommodate advancements and developments in science and technology related to milk production, processing, packaging, and distribution. From time to time, modifications in the regulations are adopted following an agreement among the representatives of government, industry (milk producers, processors, equipment manufacturers, and suppliers), and academic and research institutions. To conform to the PMO, dairy farms and dairy plants are visited regularly by representatives of government regulatory agencies, who conduct quality assurance and safety inspections at the farms

**Table 1.2.** Milk Production in the United States

Year	Milk Cows (1000 head)	Production/Cow (lb)	Total Milk Production (million pounds)
1994	9,494	16,179	153,602
1995	9,466	16,405	155,292
1996	9,372	16,433	154,006
1997	9,252	16,871	156,091
1998	9,154	17,189	157,348
1999	9,156	17,772	162,716
2000	9,206	18,201	167,559
2001	9,114	18,159	165,497
2002	9,139	18,608	170,063
2003	9,084	18,749	170,312

Source: <http://usda.mannlib.cornell.edu/reorts/nassr/dairy/pmp-bb/2004/mkpr0204.txt>.

**Table 1.3.** Production of Dairy Products in the United States During 1997–2002

Product	Production Volume (millions of pounds)					
	1997	1998	1999	2000	2001	2002
Butter	1,151	1,168	1,277	1,251	1,236	1,237
Natural cheese	7,330	7,492	7,941	8,258	8,260	8,599
Processed cheese, foods and spreads	2,210	2,278	2,425	2,288	2,207	2,155
Frozen desserts <sup>a</sup>	1,569	1,624	1,623	1,068	1,571	1,576
Ice creams <sup>a</sup>						
Regular	914	935	972	980	981	989
Low fat	387	407	381	373	407	362
Nonfat	41	43	40	31	21	–
Cottage cheese						
Creamed	360	367	361	371	372	372
Low fat	347	361	359	364	371	370
Curd	458	466	465	461	454	–
Plain						
Whole milk	18,413	18,147	18,467	18,448	18,007	17,960
Reduced and low fat milk	23,709	23,449	23,571	23,649	23,630	23,610
Nonfat milk	9,139	9,203	8,985	8,435	8,225	8,030
Flavored milk and drinks	2,830	3,044	3,216	3,336	3,526	4,040
Half and half	883	895	960	1,008	1,146	1,140
Light cream	119	134	168	168	–	–
Heavy cream	504	515	555	743	797	720
Eggnog	102	102	109	93	105	127
Refrigerated yogurt	1,574	1,639	1,717	1,837	2,003	2,135
Frozen yogurt*	92	97	91	94	71	73
Sour cream and dips	794	817	841	914	990	1,031
Buttermilk	691	676	668	622	592	576

<sup>a</sup> Millions of gallons.

Source: IDFA, 2003.

and processing plants. These inspectors confirm herd health, oversee veterinary practices, monitor sanitation of the facilities and milking equipment, and verify that the milk is being rapidly cooled and properly stored until delivered to processing facilities. They also ensure that the processing of milk is in accordance with the state and federal food laws. In some instances, the state standards differ and may be even more stringent than the federal standards. The state and in some cases local communities have jurisdiction for standards for milk in their own market.

The PMO defines Grade A specifications and standards for milk and milk products to facilitate movement of milk across state lines. Market milk, cream, yogurt, cultured buttermilk, and sour cream are governed by the Grade A standards. Reciprocity rights maintain that milk conforming to the PMO sanitary standards in one state would not require further

inspections for acceptance by another state (see Chapter 3 for a detailed discussion on this topic).

The industry has consolidated and continued to make large investments in new, state-of-the-art dairy manufacturing facilities. During the past decade, such developments have enabled a 45% reduction in the number of manufacturing facilities while the total milk output has increased by 4–5% annually. Continued investment will mean still lower processing costs and higher milk output.

## FERMENTED/CULTURED DAIRY PRODUCTS

Fermented dairy foods have constituted a vital part of human diet in many regions of the world since times immemorial. They have been consumed ever since humans domesticated animals. Evidence showing

the use of fermented milks has been found in archeological research associated with the Sumerians and Babylonians of Mesopotamia, the Pharoos of north-east Africa, and Indo-Aryans of the Indian subcontinent (Chandan, 1982, 2002; Tamime and Robinson, 1999). Ancient Indian scriptures, the *Vedas*, dating back some 5,000 years, mention *dadhi* (modern *dahi*) and buttermilk. Also, the ancient Ayurvedic system of medicine cites fermented milk (*dadhi*) for its health-giving and disease-fighting properties (Aneja et al., 2002).

Historically, products derived from fermentation of milk of various domesticated animals resulted in conservation of valuable nutrients, which otherwise would deteriorate rapidly under high ambient temperatures prevailing in South Asia and Middle East. Thus, the process permitted consumption of milk constituents for a period of time significantly longer than possible for milk itself. Concomitantly, conversion of milk to fermented milks resulted in the generation of distinctive viscous consistency, smooth texture, and unmistakable flavor. Furthermore, fermentation provided food safety, portability, and novelty for the consumer. Accordingly, fermented dairy foods evolved into the cultural and dietary ethos of the people residing in the regions of the world where they owe their origin.

Milk is a normal habitat of a number of lactic acid bacteria, which cause spontaneous souring of milk held at bacterial growth temperatures for appropriate length of time. Depending on the type of lactic acid bacteria gaining entry from the environmental sources (air, utensils, milking equipment, milkers, cows, feed, etc.), the sour milk attains characteristic flavor and texture.

Approximately 400 diverse products derived from fermentation of milk are consumed around the world. Fermentation conserves the vital nutrients of the milk. Simultaneously, it modifies certain milk constituents enhancing their nutritional status and furnishes to the consumer live and active cultures in significant numbers, which provide distinct health benefits beyond conventional nutrition. Fermented milk products may be termed as “functional foods.” They represent a significant and critical sector of the human diet. These products fit into the cultural and religious traditions and dietary pattern of many populations. In addition to the main ingredient, milk, other food ingredients are also used in the fermented milks to innovate a range of nutritional profiles, flavors, textures, and mouth feel, thereby offering an array of choices for the consumer. Fermented foods and their

derivatives may constitute a staple meal, or may be consumed as an accompaniment to the meal. They may be also used as a snack, drink, dessert, condiment, or spread as well as an ingredient of cooked dishes.

Diversity of fermented milks may be ascribed to a number of factors: (a) Use of milk obtained from various domesticated animals, (b) application of diverse micro flora, (c) addition of sugar, condiments, grains, fruits, etc., to create a variety of flavors and textures, and (d) application of additional preservation methods, e.g., freezing, concentrating, and drying.

## OCCURRENCE AND CONSUMPTION OF FERMENTED MILKS IN VARIOUS REGIONS

There is a diversity of fermented milks in the various regions of the world (see Table 1.4). As shown in Table 1.5, the 1998 annual per capita consumption of various fermented fluid milks in various countries has been reported to range from 0.2 to 45 kg.

This variety of fermented milks in the world may be ascribed to various factors.

### MILK OF VARIOUS SPECIES

Milk of various domesticated animals differs in composition and produces fermented milk with a characteristic texture and flavor (Table 1.6). The milk of various mammals exhibits significant differences in total solid, fat, mineral, and protein content. The viscosity and texture characteristics of yogurt are primarily related to its moisture content and protein level. Apart from quantitative levels, protein fractions and their ratios play a significant role in gel formation and strength. Milk proteins, further, consist of caseins and whey proteins, which have distinct functional properties. Caseins, in turn consist of  $\alpha_1$ -,  $\beta$ -, and  $\kappa$ -caseins. The ratio of casein fractions and the ratio of caseins to whey proteins differ widely in the milks of various milch animals. Furthermore, pretreatment of milk of different species, prior to fermentation, produces varying magnitudes of protein denaturation. These factors have a profound effect on the rheological characteristics of fermented milks, leading to bodies and textures ranging from drinkable fluid to firm curd. Fermentation of the milk of buffalo, sheep, and yak produces a well-defined custard-like body and firm curd, while the milk of other animals tends to generate a soft gel consistency.

Cow's milk is used for the production of fermented milks, including yogurt, in a majority of the countries

**Table 1.4.** Major Fermented Dairy Foods Consumed in the Different Regions of the World

Product Name	Major Country/Region
Acidophilus milk	United States, Russia
Ayran/eyran/jugurt	Turkey
Busa	Turkestan
Chal	Turkmenistan
Cieddu	Italy
Cultured buttermilk	United States
Dahi/dudhee/dahee	Indian subcontinent
Donskaya/varenetes/kurugna/ryzhenka/guslyanka	Russia
Dough/abdoogh/mast	Afghanistan, Iran
Ergo	Ethiopia
Filmjolk/fillbunke/fillbunk/surmelk/taettemjolk/tettemelk	Sweden, Norway, Scandinavia
Gioddu	Sardinia
Gruzovina	Yugoslavia
Iogurte	Brazil, Portugal
Jugurt/eyran/ayran	Turkey
Katyk	Transcaucasia
Kefir, Koumiss/Kumys	Russia, Central Asia
Kissel maleka/naja/yaourt/urgotnic	Balkans
Kurunga	Western Asia
Leben/labani/labani rayeb	Lebanon, Syria, Jordan
Mazun/matzoos/matsun/matsoni/madzoos	Armenia
Mezzoradu	Sicily
Pitkapiima	Finland
Roba/rob	Iraq
Shosim/sho/thara	Nepal
Shrikhand	India
Skyr	Iceland
Tarag	Mongolia
Tarho/taho	Hungary
Viili	Finland
Yakult	Japan
Yiaourti	Greece
Ymer	Denmark
Zabady/zabade	Egypt, Sudan

Adapted from Chandan, 2002; Tamime and Robinson, 1999.

around the world. In the Indian subcontinent, buffalo milk and blends of buffalo and cow milk are used widely for *dahi* preparation, using mixed mesophilic cultures (Aneja et al., 2002). In certain countries, buffalo milk is the base for making yogurt, using thermophilic cultures. Sheep, goat, or camel milk is the starting material of choice for fermented milks in several Middle Eastern countries.

### CULTURES FOR PRODUCTION OF FERMENTED MILKS

Various microorganisms characterize the diversity of fermented milks around the world. In general, lactic

fermentation by bacteria transforms milk into the majority of products. A combination of lactic starters and yeasts are used for some products and in a few cases lactic fermentation combined with molds make up the flora (Table 1.7).

### FORMS OF FERMENTED MILKS

Fermented milks may be mixed with water to make a refreshing beverage. Salt, sugar, spices, or fruits may be added to enhance the taste. Liquid yogurt is a prime example. Spoonable yogurt has significant commercial importance all over the world. It is available in cups and tubes. To enhance its health appeal, the



**Table 1.5.** Consumption of Fermented Milks in Certain Countries in 1998

Country	Per Capita (kg)
Netherlands	45.0
Finland	38.8
Sweden	30.0
Denmark	27.3
France	26.9
Iceland	25.3
Germany	25.0
Israel	24.8
Norway	19.3
Bulgaria	15.6
Austria	14.7
Spain	14.5
Czech Republic	10.0
Portugal	9.8 <sup>a</sup>
Hungary	9.4
Poland	7.4
Slovakia	7.4
U.S.A.	7.4 <sup>b</sup>
Australia	6.4
Argentina	6.0
Canada	3.6
Ukraine	3.4
South Africa	3.1
China	0.2

<sup>a</sup> In 1997.<sup>b</sup> In 2003.

Source: IDF, 1999, with permission.

trend now is to deliver prebiotics as well as probiotic organisms through conventional yogurt. In many countries, probiotic yogurt and fermented milks are available. They are made with defined cultures that have been scientifically documented to display certain health benefits.

Yogurt/buttermilk may be concentrated through a process that removes whey by straining through cloth or by mechanical centrifugation to generate a cheese-like product. The concentrate may be mixed with herbs, fruit, sugar, or flavorings to yield *shrikhand* in India, *Quarg/tvorog/topfen/tahokwarg* in central Europe, and *fromage frais* in France. Similarly, cream cheese and *Neufchatel* cheese are obtained from sour cream and buttermilk.

To enhance the shelf life, fermented milks and yogurt may be sun-dried or spray-dried to get a powder form. *Leben zeer* of Egypt and *than/tan* of Armenia are examples of concentrated yogurt without whey removal. In Lebanon, the concentrated yogurt is salted, compressed into balls, sun-dried, and preserved in oil. Another way to preserve yogurt is the process of smoking and dipping in oil. *Labneh anbaris* and *shanklish* are partially dried yogurt products preserved in oil. Spices are added to *shanklish* and the balls made from this are kept in oil. In Iran, Iraq, Lebanon, Syria, and Turkey, concentrated yogurt is mixed with wheat products and sun-dried to get *kishk*. Frozen yogurt is available in the United States and Canada as well as in several other countries.

## MAJOR COMMERCIAL FERMENTED MILKS

*Yogurt* represents a very significant dairy product around the world in recent times. It is a semisolid fermented product made from a heat-treated standardized milk mix by the activity of a symbiotic blend of *Streptococcus thermophilus* and *Lactobacillus delbrueckii* subsp. *bulgaricus*. In certain countries, the nomenclature yogurt is restricted to the product made exclusively from the two cultures, whereas in other countries it is possible to label the product yogurt

**Table 1.6.** Proximate Composition of Milk of Mammals Used for Fermented Milks

	Total Solids (%)	Fat (%)	Total Protein (%)	Casein (%)	Whey Protein (%)	Lactose (%)	Ash (%)
Cow	12.2	3.4	3.4	2.8	0.6	4.7	0.7
Cow, zebu	13.8	4.6	3.3	2.6	0.7	4.4	0.7
Buffalo	16.3	6.7	4.5	3.6	0.9	4.5	0.8
Goat	13.2	4.5	2.9	2.5	0.4	4.1	0.8
Sheep	19.3	7.3	5.5	4.6	0.9	4.8	1.0
Camel	13.6	4.5	3.6	2.7	0.9	5.0	0.7
Mare	11.2	1.9	2.5	1.3	1.2	6.2	0.5
Donkey	8.5	0.6	1.4	0.7	0.7	6.1	0.4
Yak	17.3	6.5	5.8	—	—	4.6	0.9

Adapted from Chandan and Shahani, 1993; Chandan, 2002.

**Table 1.7. Starter Cultures Used in the Manufacture of Commercial Fermented Milks**

Product	Primary Microorganism(s)	Secondary/Optional Microorganism(s)	Incubation Temperature and Time	Major Function of Culture
Yogurt	<i>Lb. delbrueckii</i> subsp. <i>bulgaricus</i> , <i>Strept. thermophilus</i>	<i>Lb. acidophilus</i> , <i>Bifidobacterium longum</i> , <i>Bifidobacterium bifidum</i> , <i>Bifidobacterium infantis</i> , <i>Lb. casei</i> , <i>Lb. lactis</i> , <i>Lb. rhamnosus</i> , <i>Lb. helveticus</i> , <i>Lb. reuteri</i>	43–45°C for 2.5 hours	Acidity, texture, aroma, flavor, probiotic
Cultured butter milk and sour cream	<i>Lc. lactis</i> subsp. <i>lactis</i> , <i>Lc. lactis</i> subsp. <i>cremoris</i> , <i>Lc. lactis</i> subsp. <i>lactis</i> var. <i>diacetylactis</i>	<i>Leuc. lactis</i> , <i>Leuc. mesenteroides</i> subsp. <i>cremoris</i>	22°C for 12–14 hours	Acidity, flavor, aroma
Probiotic Fermented milks	<i>S. thermophilus</i> , <i>Lb. acidophilus</i> , <i>Lb. reuteri</i> , <i>Lb. rhamnosus</i> GG, <i>Lb. johnsoni</i> , <i>Lb. casei</i> , <i>Bifidobacterium longum</i> , <i>Bifidobacterium bifidus</i>	<i>Lc. lactis</i> subsp. <i>lactis</i> , <i>Lc. lactis</i> subsp. <i>cremoris</i>	22–37°C/37–40°C for 8–14 hours	Acidity, flavor, probiotic
Kefir	<i>Lc. lactis</i> subsp. <i>lactis</i> , <i>Lc. lactis</i> subsp. <i>cremoris</i> ., <i>Lb. delbrueckii</i> subsp. <i>bulgaricus</i> , <i>Lb. delbrueckii</i> subsp. <i>lactis</i> , <i>Lb. casei</i> , <i>Lb. helveticus</i> , <i>Lb. brevis</i> , <i>Lb. kefir</i> , <i>Leuc. mesenteroides</i> , <i>Leuconostoc dextranicum</i>	<b>Yeasts:</b> <i>Kluyveromyces marxianus</i> subsp. <i>marxianus</i> , <i>Torulaspota delbrueckii</i> , <i>Saccharomyces cerevisiae</i> , <i>Candida kefir</i> <b>Acetic acid bacteria:</b> <i>Acetobacter aceti</i>	15–22°C for 24–36 hours	Acidity, aroma, flavor, gas (CO <sub>2</sub> ), alcohol, probiotic
Koumiss	<i>Lb. delbrueckii</i> subsp. <i>bulgaricus</i> , <i>Lb. kefir</i> , <i>Lb. lactis</i> <b>Yeasts:</b> <i>Saccharomyces lactis</i> , <i>Saccharomyces carilaginosus</i> , <i>Mycoderma</i> spp.	<b>Acetic acid bacteria:</b> <i>Acetobacter aceti</i>	20–25°C for 12–24 hours	Acidity, alcohol, flavor, gas (CO <sub>2</sub> )

Adapted from Chandan and Shahani, 1995; Hassan and Frank, 2001; Tamime and Robinson, 2002.

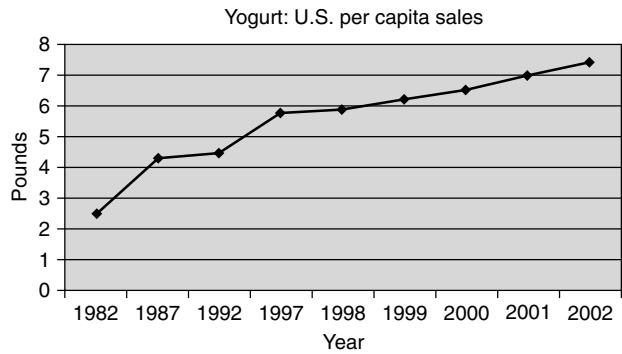

**Figure 1.1.** Trends in the per capita sales of yogurt in the United States.

made with yogurt cultures and adjunct probiotic cultures. The more common adjunct cultures are *Lactobacillus acidophilus*, *Bifidobacterium* spp., *Lactobacillus reuteri*, *Lactobacillus casei*, and *Lactobacillus rhamnosus GG*, *Lactobacillus gasseri*, and *Lactobacillus johnsonii LA1* (Chandan, 1999).

Yogurt is produced from the milk of cow, buffalo, goat, sheep, yak, and other mammals. In industrial production of yogurt, cow's milk is the predominant starting material. To get a custard-like consistency, cow's milk is generally fortified with nonfat dry milk, milk protein concentrate, or condensed skim milk. Varieties of yogurt available include plain, fruit flavored, whipped, drinking type, smoked, dried, strained, and frozen. Details of yogurt technology are given in various texts (Chandan and Shahani, 1993; Chandan, 1997; Tamime and Robinson, 1999; Mistry, 2001; Robinson et al., 2002). This subject is detailed in chapters 9–16 in this book.

The popularity of yogurt has increased due to its perceived health benefits. Health-promoting attributes of consuming yogurt containing live and active cultures are well documented (Chandan, 1989; Chandan and Shahani, 1993; Fernandes et al., 1992). The current trend of using prebiotics and probiotic cultures in the manufacture of fermented milks and yogurt products is supported by clinical trials (Chandan, 1999; Ouwehand et al., 1999; Hirahara, 2002; Salminen and Ouwehand, 2003). The beneficial effects documented in the numerous studies and reviews include prevention of cancer, reduction in diarrhea associated with travel, antibiotic therapy, and rotavirus, improvement of gastrointestinal health, enhancement of immunity of the host, amelioration of lactose intolerance symptoms, protection

from infections caused by food-borne microorganisms, control of vaginitis, and vaccine adjuvant effects.

Following world trends in increased consumption of fermented milks, the per capita sales of yogurt in the United States has also shown enormous growth. The past two decades has witnessed a dramatic rise in per capita yogurt consumption from nearly 2.5 to 7.4 lbs (Fig. 1.1). The increase in yogurt consumption may be attributed to yogurt's perceived natural and healthy image along with providing to the consumer convenience, taste, and wholesomeness attributes.

In the year 2003, yogurt sales in the United States exceeded \$2.7 billion. The total sales volume was 2,387 million pounds. From 1995 to 2002, as a snack and lunchtime meal, yogurt consumption grew by 60%. As a breakfast food, yogurt consumption increased by 75% during the same period.

It is interesting to note that the sale of cultured buttermilk is on the decline (Fig. 1.2), while the sales of yogurt and sour cream and dips are registering a significant growth. Buttermilk sales declined from 1,039 million pounds in 1987 to 592 million pounds in 2002. Yogurt drinks, on the other hand, are exhibiting significant growth. Sour cream and dips sales have grown from 694 million pounds in 1987 to 1,031 million pounds in 2002. The recent popularity of Mexican cuisine has, in part, enhanced the consumption of sour cream.

The rise in yogurt consumption is also related to the choices available in the marketplace. Besides the varieties of flavors, diversification in yogurt market includes variety of textures, packaging innovations to fulfill consumer expectations of health food trends, convenience, portability plus a magnitude of eating

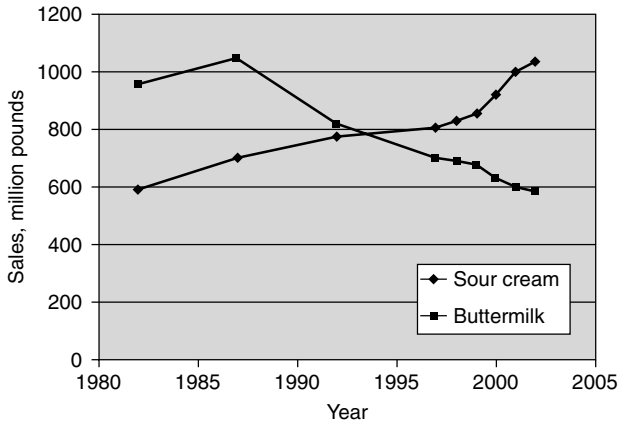
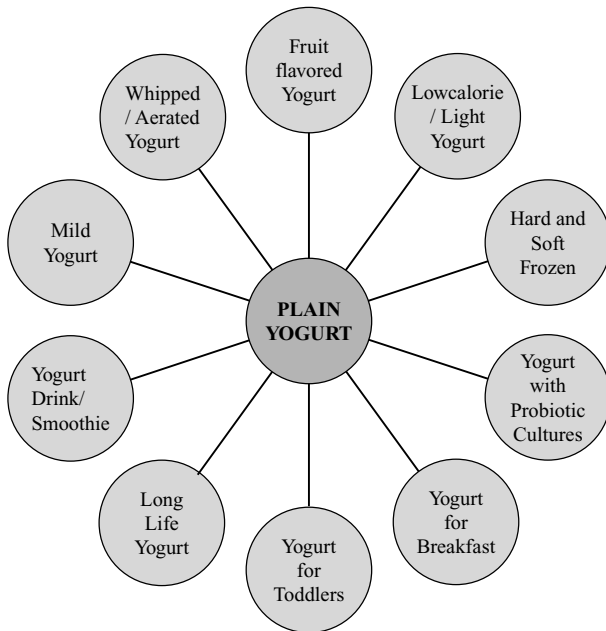

**Figure 1.2.** Trends in the total sales of buttermilk and sour cream and dips in the United States.

occasions. Figure 1.3 illustrates segmentation and various forms of yogurt available in the U.S. market.

*Cultured buttermilk* is an important fermented milk of the United States. It is obtained from pasteurized skim or part skim milk cultured with lactococci and aroma-producing bacteria leuconostoc.

Generally, milk is standardized to 9–10% milk solids-not-fat and <0.5% fat and heat-treated at 85°C for 30 minutes or at 88–91°C for 2.5–5 minutes. After homogenization at 137 kPa (2,000 psi), it is inoculated with lactic starter and ripened for 14–16 hours at 22°C. When the pH reaches 4.5,



**Figure 1.3.** Segmentation of yogurt market.

the coagulum is broken and blended with 0.18% salt and butter flakes while cooling to 4°C. The product is bottled in paper/plastic containers.

Buttermilk is primarily consumed as a beverage. In addition, it is used in cooking, especially bakery items (see Chapter 17 for a detailed discussion on cultured buttermilk).

*Sour/cultured cream* is a significant fermented milk product in North America. It is manufactured by culturing pasteurized cream with lactococci and aroma-producing bacteria, *leuconostoc* (Table 1.7). It has a butter-like aroma and flavor. Cream is standardized to 18% fat, 9% milk solids-not-fat, and 0.3% stabilizer to get stable acid gel. The blend is heat-treated at 72°C for 20 minutes and homogenized at 172 kPa (2,500 psi) at 72°C, single stage, two times. It is cooled to 22°C, inoculated with 2–5% of the starter, and cultured for 16–18 hours at 22°C or until pH drops to 4.7. It is packaged in cartons and cooled to 4°C so that it develops thick consistency. Individual serving cups and packages are also available. In this case, fermentation is carried out by filling seeded base, followed by packaging and cooling.

*Crème fraîche* is popular in France and other European countries. This product resembles sour cream, except that it contains up to 50% fat as compared to 18% fat in sour cream and has a higher pH of 6.2–6.3.

Cultured cream is used as a topping on vegetables, salads, fish, meats, and fruits and as an accompaniment to Mexican meals. It is also used as a dip, as a filling in cakes, in soups, and in cookery items. Chapter 18 contains a detailed discussion on sour/cultured cream.

*Culture-containing milks* are seeded but are unfermented milks delivering significant doses of probiotic microorganisms. In this case, the growth of the culture is intentionally avoided to preserve the fresh taste of milk. Accordingly, the product is stored at refrigeration temperatures at all times. In the past, acidophilus milk was marketed by fermenting sterilized milk with *Lb. acidophilus*. The inoculated base was incubated at 37°C for 24 hours. The plain product developed titratable acidity of 1–2%. Consequently, it had a very harsh acidic flavor. Its popularity declined rapidly as sweetened yogurt with fruit flavors began to dominate the market. However, *Lb. acidophilus* does have a strong consumer appeal. Most of the yogurts now sold in the United States contain *Lb. acidophilus*, which is either added after culturing with yogurt culture or is cocultured with yogurt culture.

Sweet acidophilus milk is an acceptable substitute for acidophilus milk of the past era. The product is made from pasteurized and chilled low-fat milk to which a concentrate of *Lb. acidophilus* culture has been incorporated to deliver a minimum of one million organisms per milliliter. It is sold in refrigerated form and has a shelf life of 2–3 weeks. For more details see Chapter 19. More recently, additional probiotic organisms have been included to enhance healthy connotation of the product. Among the additional cultures are Bifidobacteria, *Lb. delbrueckii* subsp. *bulgaricus*, *S. thermophilus*, and *Lb. casei*. Additional details are given in chapters 20, 21 and 22.

## FERMENTED MILKS OF SCANDINAVIA

As shown in Table 1.6, the Scandinavians have a high per capita consumption of fermented milks. The fermented milks of Scandinavia are distinctive in flavor and texture. They are generally characterized by a rosy and viscous body, and include *viili*, *ymer*, *skyr*, *langfil*, *keldermilk*, and several local products.

*viili*, a fermented milk of Finland, is sold plain as well as fruit-flavored. Its fat content ranges from 2% to 12%. Milk standardized to required fat level is heat-treated at 82–83°C and held at this temperature for 20–25 minutes. Homogenization is avoided. It is then cooled to 20°C and inoculated with 4% starter consisting of diacetyl producing *Lactococcus lactis* subsp. *lactis*, *Leuconostoc mesenteroides* subsp. *cremoris*, and a fungus *Geotrichum candidum*. Following packaging in individual cups, the product is incubated at 20°C for 24 hours, which results in acid development (0.9% titratable acidity) and cream layer on the top. The cream layer traps the fungus giving a typical musty odor to the product (Mistry, 2001). The fermentation process also elaborates mucopolysaccharides imparting ropiness and viscosity to the product.

*Ymer* is a Danish product with characteristic high protein (5–6%) and pleasant acidic flavor with buttery aroma. Protein enrichment is achieved by ultrafiltration technology prior to fermentation. Alternatively, the traditional process involves removal of whey by draining curd after fermentation or by inducing separation of whey by first heating the curd followed by removing the whey. The standardized milk base is heated to 90–95°C for 3 minutes and cooled to 20°C. It is then inoculated with mesophilic culture consisting of a blend of *Lc. lactis* subsp. *lactis* biovar. *diacetylactis* and *Leuc. mesenteroides* subsp. *cremoris*.

After incubation at 20°C for 18–24 hours, the product is cooled and packaged.

*Skyr* is another Scandinavian product. In Iceland, this product is obtained by fermenting skim milk with yogurt culture and a lactose-fermenting yeast. A small amount of rennet may be used to develop heavier body. The milk base is cultured at 40°C until a pH of 4.6 is achieved in 4–6 hours. It is then allowed to cool to 18–20°C and held for additional 18 hours for further acidification to pH 4.0. Following pasteurization, the mass is centrifuged using a clarifier-type separator at 35–40°C to concentrate the solids and achieve a protein level of around 13%. *Skyr* has typical flavor compounds consisting of lactic acid, acetic acid, diacetyl, acetaldehyde, and ethanol.

## FERMENTED MILKS OF RUSSIA AND EAST EUROPE

*Kefir* is relatively the most popular of fermented milks in Russia, Eastern Europe, and certain Asian countries. In addition to lactic fermentation, this product employs yeast fermentation as well. Thus, a perceptible yeast aroma and alcohol content characterize these products. Also, a fizz is noticed due to the production of carbon dioxide as a result of yeast growth. *Kefir* preparation involves natural fermentation of cow's milk with *kefir* grains. *Kefir* grains are a curd-like material, which are filtered-off after each use and reused for inoculation of the next batch. *Kefir* grains contain polysaccharides and milk residue embedded with bacteria *Lb. kefir*, *Lb. kefirgranum*, and species of leuconostocs, lactococci, and lactobacilli. Along with bacteria, the grains contain yeasts including *Saccharomyces kefir*, *Candida kefir*, and *Torula* species. Milk is heated to 85°C for 30 minutes, cooled to 22°C, and incubated with *kefir* grains for 12–16 hours to obtain traditional *kefir*. Typical flavor compounds in *kefir* are lactic acid, acetaldehyde, diacetyl, ethanol, and acetone.

In the United States, *kefir* is appearing in some markets. It varies from traditional *kefir* in that it is fermented with a blend of species of lactococci and lactobacilli. Some yeast is used to give only traces of alcohol. The commercial product is blended with sugar and fruit juices/flavors.

*Koumiss* is obtained from mare's milk or cow's milk, using a more defined culture containing *Lb. delbrueckii* subsp. *bulgaricus*, *Lb. acidophilus*, and torula yeasts. This therapeutic product has perceived health benefits and is recommended for all

consumers, especially those with gastrointestinal problems, allergy, and hypertension and ischemic heart diseases (Mistry, 2001). Since mare's milk has only 2% protein, no curdling is seen in the product. It contains 1–1.8% lactic acid, 1–2.5% ethanol, and enough carbon dioxide to give a frothy appearance to the product (more detailed discussion on this topic is given in Chapter 19).

## FERMENTED MILKS OF MIDDLE EAST

Fermented milks and their products have been historically associated with the Middle East.

*Laban rayeb* is prepared at home by pouring raw whole milk in clay pots and allowing the fat to rise at room temperature. The top cream layer is removed and partially skimmed milk is allowed to undergo spontaneous fermentation. Some variations of the product exist. One of these is *laban khad*, which is fermented in a goat pelt. The other is *laban zeer*, which is distinctly fermented in earthenware pots. The organisms responsible for fermentation are thermophilic lactobacilli in summer season and mesophilic lactococci in winter season (Mistry, 2001).

*Kishk* is obtained from *laban zeer*. Wheat grains are soaked, boiled, sun-dried, and ground to powder form. The blend of wheat and *laban zeer* is allowed to ferment further for another 24 hours and portioned into small lumps and sun-dried. The dried *kishk* has 8% moisture and 1.85% lactic acid. After proper packaging, its shelf life is of the order of several years. *Kishk* may contain spices.

*Labneh* is prepared by concentrating fermented milk, after fermentation process is completed. Milk is fermented with yogurt culture and then concentrated using Quarg separator. This product contains 7–10% fat.

*Zabady* is an Egyptian product obtained by fermenting milk that has been concentrated by boiling and then fermented with yogurt culture. Further concentration of milk solids is achieved by heating it and separating the whey.

## FERMENTED MILKS OF SOUTH ASIA

The fermented milks discussed below and the products derived from these are of commercial importance in India, Pakistan, and Bangladesh (Aneja et al., 2002; Mathur, 2002).

*Dahi*, also called curd, is a semisolid product obtained from pasteurized or boiled buffalo or a mixture of cow and buffalo milk by souring natural, or otherwise, by a harmless lactic acid or other bacterial culture. *Dahi* may contain cane sugar. It should have at minimum the same percentage of fat and solids-not-fat as the milk from which it is prepared (Aneja et al., 2002).

To prepare good quality of *dahi*, right type of culture is essential. A mixed culture containing *Lc. lactis* subsp. *lactis*, *Lc. lactis* subsp. *diacetylactis*, or *Leuc.* species, *Lc. lactis* subsp. *cremoris* in the ratio of 1:1:1 may be used. In addition, *S. thermophilus* may be a component of *dahi* culture or a culture composed of *Lc. lactis* subsp. *lactis* and *Lc. lactis* subsp. *diacetylactis* may be employed.

Mild *dahi* is made from mesophilic lactococci. *Leuconostocs* may be adjunct organisms for added buttery aroma and flavor. Sour *dahi* contains additional cultures belonging to thermophilic group, which are generally employed in the manufacture of yogurt. These thermophilic organisms grow rapidly at 37–45°C, producing *dahi* in less than 4 hours.

*Mishti doi* is a fermented milk product, having cream to light brown color, firm consistency, smooth texture, and pleasant aroma. It contains 2–9% fat, 10–14% solids-not-fat, and 17–19% sugar. The most common sweetener used is cane sugar. In some special varieties of *mishti doi* fresh palm jaggery is used as a sweetener. Typically, a mix comprising 71.26% milk (3% fat, 9% solids-not-fat), 5.32% cream (35% fat), 5.42% nonfat dry milk, and 18% crystalline sugar is blended. Caramel (0.1%) may be added as a flavor. This mix is heat-treated at 85–90°C for 15 min and homogenized. The heating process develops light brown color in the mix. The mixture is cooled to 42°C. The starter is added at 1% level. Following dispersion of the starter, *mishti doi* mix is dispensed into sanitized cups and lids are heat-sealed to make the packaging airtight as well as to prevent leakage of the mix. The sealed cups are then incubated at 42 ± 1°C for about 6–8 hours until the acidity develops to 0.7–0.8%. The product is moved to a cold room (4°C) with minimum disturbance because at this stage the product has a weak body and unstable top layer. Excessive shaking may result in undesirable cracks on the top layer or in the curd mass. *Mishti doi* is used as a dessert and snack in India and Bangladesh.

*Shrikhand* is a *dahi*-based product. The cultured milk or *dahi* is separated from whey to get *chakka*, which is blended with sugar, color, flavor, and spices to reach a desired level of composition and consistency. The final product contains 8.5% fat, 10%

protein, 42% sugar, and 60% total solids. The acidity of the product is usually between 1.10% and 1.20%, expressed as lactic acid. Skim milk (9% solids-not-fat, 0.05% fat) is heated to 90°C for 10 seconds in a High-Temperature Short-Time pasteurizer, cooled to 30°C, and inoculated with 0.25–0.50% *dahi* culture. After 8 hours of incubation period or titratable acidity of 0.8%, the curd is ready for further processing. *Chakka* is prepared by separating the whey from *dahi* employing a basket centrifuge or a desludging centrifuge. *Shrikhand* is prepared by adding sugar at the rate of 80% of the amount of *chakka* and mixed in a planetary mixer. Predetermined amount of plastic cream (80% fat) is added along with sugar and flavorings/spices to *chakka* to obtain at least 8.5% fat in the finished product. *Shrikhand* is used primarily as a snack and dessert.

*Lassi* is a refreshing beverage derived from *dahi*. It is a popular drink of India, especially North India. Significant advancements have been made toward the industrial production of *lassi* through application of ultra high temperature (UHT) technology (Aneja et al., 2002). Standardized milk (9–10% solids-not-fat and 0.5–1.0% milk fat) is heated to 85°C for 30 minutes or at 91°C for 2.5–5 minutes, cooled to 25°C, and cultured with *dahi* starter. It is then fermented at 25°C to lower the pH to 4.5. The set curd is broken with the help of a stirrer and at the same time 30% sugar solution is added to get 8–12% sugar concentration in the blend. In some variations, fruit flavor may be incorporated. *Lassi* is then homogenized at 13.7 kPa (2000 psi) and UHT processed at 135–145°C for 1–5 seconds and packaged aseptically employing standard equipment. See Chapter 13 for details on *Lassi*.

Chapter 19 in this book contains a detailed discussion on various fermented milks available in the world.

## REFERENCES

- Aneja RP, Mathur BN, Chandan RC, Banerjee AK. 2002. Technology of Indian Milk Products. Dairy India Yearbook, New Delhi, India, pp. 158–182.
- Chandan RC. 1982. Fermented dairy products. In: G. Reed (Ed), Prescott and Dunn's Industrial Microbiology, 4th ed. AVI Publ, Westport, CT, pp. 113–184.
- Chandan RC (Ed). 1989. Yogurt: Nutritional and Health Properties. National Yogurt Association, McLean, VA.
- Chandan RC. 1997. Dairy-Based Ingredients. Eagan Press, St. Paul, MN.

- Chandan RC. 1999. Enhancing market value of milk by adding cultures. *J. Dairy Sci.* 82:2245–2256.
- Chandan RC. 2002. Benefits of live fermented milks: Present diversity of products. In: *Proceedings of International Dairy Congress, Paris, France.* [Available in CD-ROM.]
- Chandan RC, Shahani KM. 1993. Yogurt. In: YH Hui (Ed), *Dairy Science and Technology Handbook*, Vol. 2. VCH Publ, New York, pp. 1–56.
- Chandan RC, Shahani KM. 1995. Other fermented dairy products. In: G Reed, TW Nagodawithana (Eds), *Biotechnology*, Vol. 9, 2nd ed. VCH Publ, Weinheim, Germany, pp. 386–418.
- Fernandes CF, Chandan RC, Shahani KM. 1992. Fermented dairy products and health. In: BJB Wood (Ed), *The Lactic Acid Bacteria*, Vol. 1. Elsevier, New York, pp. 279–339.
- Hassan A, Frank JF. 2001. Starter cultures and their use. In: EH Marth, JL Steele (Eds), *Applied Microbiology*, 2nd ed. Marcel Dekker, New York, pp. 151–205.
- Hirahara T. 2002. Trend and evolution of fermented milk. In: *Proceedings of International Dairy Congress, Paris, France.* [Available in CD-ROM.]
- International Dairy Federation (IDF). 1999. *World Dairy Situation*. Bulletin 339. IDF, Brussels, Belgium.
- International Dairy Foods Association (IDFA). 2003. *Dairy Facts*. IDFA, Washington, DC.
- Mathur BN. 2002. Using microflora in traditional milk products processing. In: *Proceedings of International Dairy Congress, Paris, France.* [Available in CD-ROM.]
- Mistry VV. 2001. Fermented milks and cream. In: EH Marth, JL Steele (Eds), *Applied Dairy Microbiology*, 2nd ed. Marcel Dekker, New York, pp. 301–325.
- Ouwehand AC, Kirjavainen PV, Srotrt C, Salminen S. 1999. Probiotics: Mechanisms and established effects. *Int. Dairy J.* 9:43–52.
- Robinson RK, Tamime AY, Wszolek M. 2002. Microbiology of fermented milks. In: RK Robinson (Ed), *Dairy Microbiology Handbook*. John Wiley, New York, pp. 367–430.
- Salminen S, Ouwehand AC. 2003. Probiotics, applications in dairy products. In: *Encyclopedia of Dairy Sciences*, Vol. 4. Academic Press, London, pp. 2315–2322.
- Tamime AY, Robinson RK. 1999. *Yogurt Science and Technology*, 2nd ed. Woodhead Publ, Cambridge, England, and CRC Press, Boca Raton, FL.
- U.S. Department of Health and Human Services (DHHS). 1999. *Grade "A" Pasteurized Milk Ordinance, 1999 revision*. Publication No. 229. U.S. Department of Public Health, U.S. DHHS, Food and Drug Administration, Washington, DC.

## BIBLIOGRAPHY

- International Dairy Federation. 2003. *Yogurt: Enumeration of Characteristic Organisms—Colony Count Technique at 37°C*. IDF Standard No. 117/ISO 7889 Standard IDF, Brussels, Belgium.
- Tamime AY. 2002. Microbiology of starter cultures. In: RK Robinson (Ed), *Dairy Microbiology Handbook*. Wiley-Interscience, pp. 261–366.
- U.S. Department of Agriculture (USDA). 2003. *National Agricultural Statistics Service. Dairy and Poultry Statistics*. USDA, Washington, DC, Ch 8.



# 2

## Milk Composition, Physical and Processing Characteristics\*

*Ramesh C. Chandan*

- Introduction
- Definition of Milk
- Milk Composition
  - Factors Affecting Composition of Milk
- Physical Structure
- Constituents of Milk
  - Major Constituents
  - Milk Fat Globule
  - Proteins
  - Milk Enzymes
  - Functional Attributes of Major Milk Proteins
  - Lactose
  - Minerals
  - Vitamins and Some Other Minor Constituents
- Physical Characteristics of Milk
  - Optical Properties
  - Flavor
  - Acidity and pH
  - Buffering Capacity
  - Electrochemical Properties
  - Thermal Properties
  - Density and Specific Gravity
  - Viscosity
  - Surface Activity
  - Curd Tension
  - Colligative Properties
- References
- Bibliography

the neonate. Following parturition, milk is the secretion of normally functioning mammary gland of the females of all mammals. The yield and composition of milk vary among various species to entirely meet postnatal growth requirements of the offspring. Milk, therefore, contains all the chemicals in the form of six major nutrients, viz., water, fat, proteins, carbohydrates, minerals, and vitamins that are ideal for nourishment. Milk and milk products are used as components of many food products around the world.

Milk is an integral part of fermented milks, including yogurt, and considered by many as an ideal vehicle to deliver beneficial cultures as well as probiotics and ingredients known to stimulate activity of the beneficial cultures and the microflora of the human gastrointestinal tract. The conversion of milk into fermented milks augments the nutritional value of inherent milk constituents. Additionally, the fermentation process generates metabolic and cellular compounds that have positive physiological benefits for the consumer.

This chapter provides basic information relative to milk composition that is relevant to the processing of yogurt and fermented milks. For detailed discussions, the reader is referred to Wong et al., 1988; Jensen, 1995; Swaisgood, 1996; Fox and McSweeney, 1998; and Walstra et al., 1999.

### INTRODUCTION

From a physiological standpoint, milk is a unique biological secretion of the mammary gland endowed by nature to fulfill the entire nutritional needs of

### DEFINITION OF MILK

Chemically speaking, milk is a complex fluid in which more than 100,000 separate molecules and

---

\*The information in this chapter has been derived from *Handbook of Fermented Foods*, published by Science Technology Systems, West Sacramento, CA, ©2004. Used with permission.

chemical entities have been found, the levels of which vary with the species. In terms of physical chemistry, milk is an opaque, white heterogeneous fluid in which various constituents are held in multidispersed phases of emulsion, colloidal suspension, or solution.

Worldwide, milk from cows, water buffaloes, goats, sheep, camel, mare, and other mammals is used for human consumption. However, cow's milk entails by far the most important commercial significance.

According to the Food and Drug Administration (FDA) of the United States, milk refers to cow's milk. Milk from other species must be labeled to indicate the species. For instance, milk from goats must be called goat's milk. Milk is the whole, clean lacteal secretion of one or more healthy cows properly fed and kept, excluding that obtained within 15 days before calving and 3–5 days after. This would exclude colostrum, the milk secreted immediately after giving birth. The definition of Grade A milk as per FDA standards of identity is "the lacteal secretion practically free of colostrum, obtained by complete milking of one or more healthy cows, which contains not less than 8.25% milk solids not fat and not less than 3.25% milk fat."

## MILK COMPOSITION

The chemical makeup of milk and its physicochemical behavior provide scientific basis for the basic processing of milk and the manufacture of products. The composition of milk is generally described in terms of its commercially important constituents, milk fat and nonfat solids or milk solids not fat (MSNF). The MSNF consists of protein, lactose, and minerals. These solids are also referred to as "serum solids." The term "total solids" refers to the serum solids plus the milk fat. The major constituents of milk are given in Table 2.1.

The ash content is not quite equivalent to the salt level in milk. In the determination of mineral content, some salts like chlorides and organic salts are volatilized or destroyed as a result of high temperature exposure during routine mineral analysis by the ash method. The data given in Table 2.1 refer to all major breeds of cows in North America. Milk

from Jersey and Guernsey breeds would be closer to a higher fat and protein range.

## FACTORS AFFECTING COMPOSITION OF MILK

Apart from the differences due to the breed, certain additional factors also influence the gross composition of milk: (a) individuality of animal, (b) stages of milking, (c) intervals of milking, (d) completeness of milking, (e) frequency of milking, (f) irregularity of milking, (g) portion of milking, (h) different quarters of udder, (i) lactation period, (j) yield of milk, (k) season, (l) feed, (m) nutritional level, (n) environmental temperature, (o) health status, (p) age, (q) weather, (r) oestrus or heat, (s) gestation period, (t) exercise, (u) excitement, and (v) administration of drugs and hormones. In general, these variables tend to average out in commercial pooled milk used by dairy processors, but they do display an interesting seasonal pattern. The seasonal variations in protein and mineral content have an important impact on viscosity and gel structure of yogurt and fermented products. During late spring and early summer months, milk in some areas of the United States registers low protein and calcium content resulting in poor viscosity in finished yogurt. During these months of low-protein milk, it is necessary to compensate by raising the solids-not-fat (SNF) content of yogurt mix by 0.25–0.50%. However, because of the current widespread use of stabilizers (modified starch and gelatin) in yogurt mix, the seasonal variations in protein content do not impact viscosity and texture to the extent it does in natural yogurt in which no stabilizers are used.

## PHYSICAL STRUCTURE

Various interactive forces between the chemical constituents of milk determine the technological behavior of milk. Milk has well-defined physical equilibria between various constituents that exist mainly in three forms, viz., emulsion, colloidal solution, and true solution. Milk lipids are present as an "oil-in-water" type of emulsion in the form of microscopic

**Table 2.1.** Composition of Bovine Milk

	Water	Fat	Protein	Lactose	Ash
Average, %	86.6	4.1	3.6	5.0	0.7
Range, average %	84.5–87.7	3.4–5.1	3.3–3.9	4.9–5.0	0.68–0.74

Source: Adapted from Swaisgood, 1996.

**Table 2.2.** Physical State and Particle Size Distribution in Milk

Compartment	Size, Diameter (nm)	Type of Particles
Emulsion	2,000–6,000	Fat globules
Colloidal dispersion	50–300	Casein–calcium phosphate
	4–6	Whey proteins
True solution	0.5	Lactose, salts, and other substances

globules varying from 0.1 to 22  $\mu\text{m}$  in diameter. The colloidal phase contains casein micelles, calcium phosphates, and globular proteins. Whey proteins are in colloidal solution and the casein is in colloidal suspension. Lactose, vitamins, acids, enzymes, and some inorganic salts are present as true solutions. Table 2.2 gives the relative sizes of these particles in milk.

Certain factors tend to influence the physical equilibrium of milk that exists between colloidal dispersion and salts. These factors are (a) addition of polyvalent ionizable salts, (b) concentration of serum solids, (c) changes in pH, (d) heat treatment (which may alter the surface charges or unfold proteins), and (e) addition of alcohols (which reduces bound water associated with the colloidal constituents). All these factors tend to destabilize colloidal systems and thus influence the technological behavior of milk during product manufacture. In the production of cultured milks, as the fermentation proceeds, the colloidal calcium phosphate gets progressively converted to ionic form as the pH drops from 6.6 in milk to less than 4.6 in yogurt and fermented milks. Casein and the interacted whey proteins coagulate at the isoelectric point at pH 4.6, forming a gelled structure.

Certain terms related to milk structure need clear understanding. Milk plasma is the fluid portion of milk minus fat globules, being almost similar to skim milk.

Milk serum is milk plasma minus milk fat and casein micelles. Removal of casein micelles from skim milk by clotting with rennet yields the liquid called whey. It is different from milk serum because it contains some polypeptides cleaved from casein by rennet.

## CONSTITUENTS OF MILK

### MAJOR CONSTITUENTS

#### Water

Water is the medium in which all the other components of milk (total solids) are dissolved or

suspended. Water content varies from 85.4% to 87.7% in different species of cows (Table 2.1). A small percentage of the water in milk is hydrated to the lactose and salts and some is bound with the proteins.

#### Fat

Milk fat, though quite bland in taste, imparts richness/smoothness to fat-containing dairy products. Milk fat in freshly secreted milk occurs as microscopic globular emulsion of liquid fat in aqueous phase of milk plasma. Fat content of milk varies from 3.4% to 5.1%, depending on the breed of the cow. Most of the milk used for yogurt production typically contains an average of 3.5–3.6% fat. Variability of milk fat also depends upon the individuality of animal, stage of lactation, feed, environmental factors, and stage of milking. The composition of milk fat is given in Table 2.3.

The milk fat of cows consists chiefly of triglycerides of fatty acids, which make up 95–96% of milk fat. The remaining milk fat is composed of diglycerides, monoglycerides, free fatty acids, phospholipids, and cholesterol, as shown in Table 2.3.

**Table 2.3.** Composition of Bovine Milk Fat/Lipids

Lipid Fraction	g/l in Milk	Weight %
Triacylglycerols/ triglycerides	30.7	95.80
Diacylglycerols/ diglycerides	0.72	2.30
Monoacylglycerols/ monglycerides	0.03	0.08
Free fatty acids	0.09	0.28
Phospholipids	0.36	1.11
Cholesterol	0.15	0.46
Cholesterol esters	0.006	0.02
<i>Total</i>	<i>32.056</i>	<i>100.05</i>

**Table 2.4.** Fatty Acid Profile of Milk Fat

Fatty Acids	Common Name	Weight %
C <sub>4:0</sub>	Butyric	3.8
C <sub>6:0</sub>	Caproic	2.4
C <sub>8:0</sub>	Caprylic	1.4
C <sub>10:0</sub>	Capric	3.5
C <sub>12:0</sub>	Lauric	4.6
C <sub>14:0</sub>	Myristic	12.8
C <sub>14:1</sub>	Myristoleic	1.6
C <sub>15:0</sub>	—	1.1
C <sub>16:0</sub> (branched)	—	0.30
C <sub>16:0</sub>	Palmitic	43.7
C <sub>16:1</sub>	Palmitoleic	2.6
C <sub>17:0</sub>	—	0.34
C <sub>18:0</sub> (branched)	—	0.35
C <sub>18:0</sub>	Stearic	11.3
C <sub>18:1</sub>	Oleic	27.42
C <sub>18:2</sub>	Linoleic	1.5
C <sub>18:3</sub>	Linolenic	0.59

The functional properties of milk fat are attributed to its fatty acid makeup. More than 400 distinct fatty acids have been detected in milk. Typical milk fat consists of 62% saturated, 29% monounsaturated, and 4% polyunsaturated fatty acids. It contains 7–8% short-chain fatty acids (C<sub>4</sub>–C<sub>8</sub>), which is a unique characteristic of milk fat. The major fatty acids of milk fat are given in Table 2.4.

Milk fat functions as a concentrated source of energy as well as a source of fat-soluble vitamins A, D, E, and K and essential fatty acids, linoleic acids, and arachidonic acids. The essential fatty acids are not synthesized by the human body. They must be supplied by the diet. Arachidonic acid with four double bonds is present in traces. Its precursor is linoleic acid. Omega-3-linoleic acid and its products, eicosapentaenoic acid (EPA) and docosahexaenoic acid (DHA), are also present in trace, but significant, amounts. The positional location of individual fatty acids in the triglycerides is not random. In fact, the *syn-1* and *syn-2* positions on the glycerol molecule are mainly occupied by myristic (C<sub>14:0</sub>), palmitic (C<sub>16:0</sub>), stearic (C<sub>18:0</sub>), or oleic acids (C<sub>18:1</sub>). The *syn-3* positions contain butanoic (C<sub>4:0</sub>), hexanoic (C<sub>6:0</sub>), or oleic (C<sub>18:1</sub>) acids.

Saturated fatty acids are solid at ambient temperature, while unsaturated fatty acids are liquid. Their ratio in milk fat has a profound effect on the hardness and spreadability of butter at low temperatures. The balance between C<sub>4</sub> and C<sub>18</sub> fatty acids keeps milk fat liquid at body temperature (Otter, 2003). The origin

of fatty acids is either blood plasma lipids or they are synthesized in the mammary gland. There is a correlation between the fatty acid composition of feed lipids and butter hardness. A seasonal effect is seen as well. A softer butter is observed when the cow is on summer pasture or when the ration includes oils liquid at ambient temperature.

## Cholesterol

The cholesterol content of milk is significantly affected by the species, breed, feed, stage of lactation, and season of the year. Cholesterol content is generally lowest in the beginning of lactation period and progressively rises throughout the lactation period, being highest toward the end of the lactation. The cholesterol content of colostrum is relatively high (570–1950 mg per 100 g fat) for the first milking after parturition and progressively declines to normal levels during subsequent milking.

In general, typical cholesterol content of whole milk (3.25% fat) is 10.4 mg/100 ml or 24.4 mg per serving of 8 fl. oz. It corresponds to 3–4 mg/g fat. Fat reduction in dairy products is accompanied by cholesterol reduction. By separating fat from milk, an 80% reduction in cholesterol content can be achieved in skim milk. Thus, nonfat milk/skim milk shows residual cholesterol level of 4.9 mg/8 oz serving. Yogurt and fermented milks, therefore, contain cholesterol content depending on the milk fat and SNF content of the product.

## Phospholipids

A number of factors influence the unique phospholipid content of milk. The total phospholipid content of cow's milk is approximately 36 mg/100 ml.

## MILK FAT GLOBULE

Milk fat occurs in milk as an emulsion of fat particles suspended in aqueous phase. The spherical particles are called fat globules (Fig. 2.1).

The average size of fat globules in raw cow milk varies from 3.4 to 4.5 μm, depending on the breed of the cow. Jersey milk fat globules tend to have larger diameters than Holstein milk fat globules. Milk lipid globules fall into three overlapping size distributions. These are shown in Table 2.5.

The use of a separator in dairy plants permits fractionation of whole milk into skim/low-fat milk and cream. Fat globules are lighter (less dense) than the

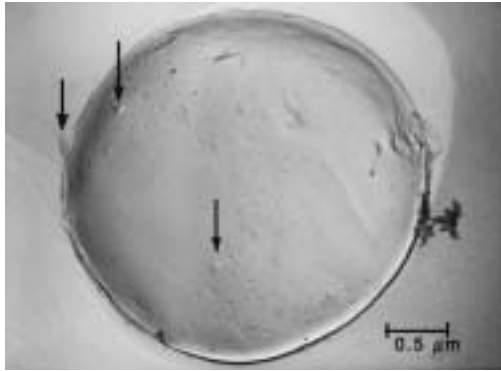

**Figure 2.1.** Electron micrograph of freeze-etched fat globule of Jersey cow milk. Note the surface is smooth as well as uneven, and some particle-like material protrudes out on the surface as depicted by arrows. From: Henson et al., with permission.

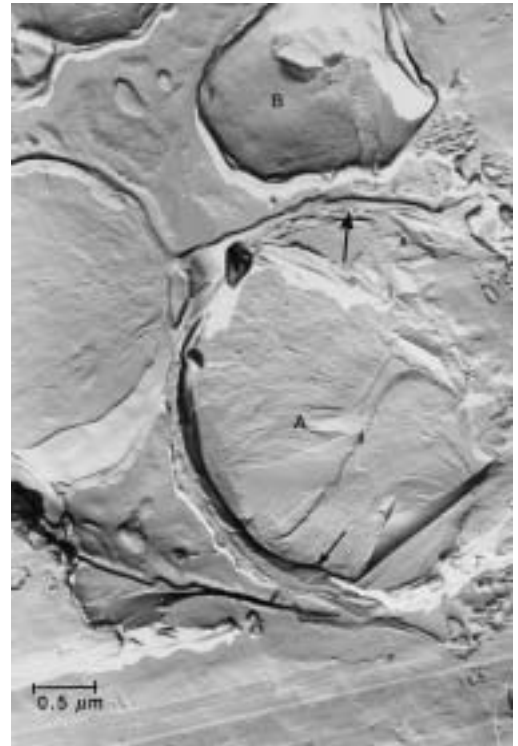

**Figure 2.2.** Electron micrograph of freeze-etched fat globule membrane isolated from the globules of Jersey cow milk. Note the membrane as depicted by arrows. From: Henson et al., with permission.

surrounding water phase and rise to the surface when milk is left undisturbed, as per Stoke's law.

$$V = \frac{2r^2(\text{density of serum} - \text{density of fat}) \times g}{\text{Viscosity of milk} \times 9} \quad (2.1)$$

where  $V$  is velocity of rise of fat globules,  $g$  is the gravitational force, and  $r$  is the radius of the fat globule. From the equation, it follows that  $V$  is directly proportional to  $g$ . If  $g$  is increased by centrifugal force, fat globules can be separated in a relatively short time. Also,  $g$  is inversely proportional to the viscosity of milk, which decreases as the temperature goes up, converting the fat into liquid state. Accordingly,  $V$  is increased. Thus, separation is more efficient at warmer temperatures. Skim milk should contain 0.05% fat or less, if the separator is functioning properly.

Processed milk products, namely homogenized milk, ultra-high temperature (UHT) milk, ice cream, yogurt, light cream, half and half, evaporated milk, and condensed milk, which have undergone homogenization have diameters of their globules of the order

of 0.3–0.7  $\mu\text{m}$ . The fat globules of unhomogenized products like whipping cream show an average diameter of 4.0  $\mu\text{m}$ . Skim milk has smaller fat globules left over as a result of separator action and their diameter is around 1.3  $\mu\text{m}$ . Cream layer is observed in products with relatively large fat globules, while the homogenized dairy products show virtually no cream layer during the shelf life of such products.

The fat globules are stabilized by a very thin membrane, closely resembling plasma membrane, only 5–10 nm thick (Fig. 2.2).

**Table 2.5.** Size Distribution of Milk Lipid Globules

Class	Diameter ( $\mu\text{m}$ )	Proportion of the Total Globule Population (%)	Fraction of Total Milk Lipid (%)
Small	Below 2	70–90	<5
Intermediate	3–5	10–30	90
Large	8–10	0.01	1–4

**Table 2.6.** Proximate Composition of Bovine Milk Fat Globule Membrane

Component	% (w/w) of Total Membrane
Protein	41
Phospholipids	27
Neutral glycerides	14
Water	13
Cerebrosides	3
Cholesterol	2

Source: Adapted from Fox and McSweeney, 1998.

The fat globule membrane consists of proteins, lipids, lipoproteins, phospholipids, cerebrosides, nucleic acids, enzymes, trace elements, and bound water, details of which are given in Table 2.6.

The membrane is important in keeping the fat from separating as free oil when it is subjected to physical abrasion during handling/processing of milk. It also protects milk lipids against the action of enzymes, notably lipase, in development of rancidity. Certain enzymes such as alkaline phosphatase and xanthine oxidase as well as certain important minerals such as iron and copper are preferentially attached to the fat globule membrane. The membrane contains 5–25% of the total copper and 30–60% of the total iron content of milk. Other elements associated with membrane are cobalt, calcium, sodium, potassium, magnesium, manganese, molybdenum, and zinc. Molybdenum is associated with the enzyme xanthine oxidase. Activity of nearly all the enzymes of milk has been detected in the membrane.

The proteins of membrane are unique and are not found in skim milk phase. Because of damage of the globule or as a result of homogenization, the membrane proteins contain skim milk proteins (casein and whey proteins). A hydrophobic protein, butyrophilin, has been isolated from the membrane, which shows extraordinary affinity for association with lipids.

The lipid fraction of the membrane constitutes about 1% of the total milk lipids. It contains phospholipids and neutral lipids in the ratio of 2:1. The phospholipids are phosphatidyl choline (34% of total lipid phosphorus), phosphatidyl ethanolamine (28%), sphingomyelin (22%), phosphatidyl inositol (10%), and phosphatidyl serine (6%) (Fox and McSweeney, 1998). The major fatty acid content of phospholipids is 5% C<sub>14:0</sub>, 25% C<sub>16:0</sub>, 14% C<sub>18:0</sub>, 25% C<sub>18:1</sub>, 9% C<sub>18:2</sub>, 3% C<sub>22:0</sub>, and 3% C<sub>24:0</sub>. Accordingly, the unsaturated content of the membrane lipids is different from the rest of the milk lipids in terms of their high unsaturated fatty acid level. Thus, they are more susceptible to oxidative deterioration.

The neutral lipids of the membrane consist of approximately 83–88% triglycerides, 5–14% diglycerides, and 1–5% free fatty acids. The fatty acids contained therein are largely long chain. In order of their preponderance, they are palmitic, stearic, myristic, oleic, and lauric acids.

The sterols, Vitamin A, carotenoids, and squalene are largely located in the fat core of the globule.

## PROTEINS

Milk contains hundreds of proteins and most of them occur in trace amounts. The major proteins of milk are broadly classified as caseins and whey proteins. Caseins are defined as the proteins that are insolubilized and precipitate at or above 20% when the pH of milk is lowered to 4.6. The soluble fraction at pH 4.6 is termed as whey proteins. In addition, milk contains degradation products produced by plasmin, an inherent proteolytic enzyme. Thus,  $\gamma$ -casein and proteose peptones owe their origin to the proteolysis of  $\beta$ -casein. Also, proteins derived from milk fat globule membrane are present. The membrane proteins are spilled into the milk system following mechanical disruption of the fat globule, such as churning and homogenization processing. Milk also contains numerous enzymes and biologically active proteins. Nonprotein nitrogen compounds like urea, uric acid, creatine, creatinine, orotic acid, and hippuric acid are also found.

Casein, the principal milk protein, makes up 80% of the total, while whey proteins make up the remaining 20%. These fractions have been shown to be heterogeneous, consisting of several proteins (Table 2.7).

## Caseins

Typical of milk proteins, caseins display distinctive structure, charge, physical and biological properties, as well as a nutritional role. The interaction of various caseins and calcium phosphate contributes to the formation of large colloidal complex particles called casein micelles. The whitish color of milk is ascribed to the light scattering effect of colloidal micelles. The micelles are rough-surfaced spherical particles varying in size from 50 to 500 nm. Electron microscopic picture analysis has shown that the micelles are composed of smaller particles or submicelles of 20 nm diameter or less. Hydrophobic interactions with calcium phosphate and submicelles seem to be involved in the formation of micelles. Micelle composition consists of 63% moisture and the dry matter consists

**Table 2.7.** Concentration of Various Proteins and Polypeptides in Milk

Protein/Polypeptide	Concentration in Milk (g/100 ml)
<i>Caseins</i>	2.4–2.8
$\alpha_{S1}$ -Casein	1.2–1.5
$\alpha_{S2}$ -Casein	0.3–0.4
$\beta$ -Casein	0.9–1.1
$\kappa$ -Casein	0.3–0.4
<i>Casein fragments</i>	0.2–0.35
$\gamma$ -Casein	0.1–0.2
<i>Whey proteins</i>	0.5–0.7
$\beta$ -Lactoglobulins	0.2–0.4
$\alpha$ -Lactalbumins	0.1–0.17
Serum albumins	0.02–0.04
Immunoglobulins	0.05–0.18
Protease peptone	0.06–0.17
Milk Fat Globule	
Membrane Protein	0.04
Enzymes	–

of 92–94% protein and 6–8% colloidal calcium phosphate. Other associated salts are magnesium and citrate. Micelles have a porous structure with large voluminosity (approximately 4 ml/g of casein). They are considerably hydrated, showing 3.7 g water/g casein.

Caseins are further divided into  $\alpha_{S1}$ -,  $\alpha_{S2}$ -,  $\beta$ -, and  $\kappa$ -fractions (Table 2.7), which along with whey proteins,  $\beta$ -lactoglobulin, and  $\alpha$ -lactalbumin are gene-derived proteins synthesized in the mammary gland. All these proteins are heterogeneous and exhibit genetic polymorphs. There are two to eight genetic variants differing from each other in 1–14 amino acids. The variants may have impact on the protein concentration and processing properties of milk. The  $\gamma$ -fraction is derived from the breakdown of  $\beta$ -casein by the native proteolytic enzymes of milk.

The caseins are phosphorylated proteins, containing 1–13 phosphoserine residues.  $\kappa$ -Casein exists in as many as nine glycosylated forms. It contains two cysteine molecules per molecule. As a result of

disulfide bond formation, it can exist as polymers of two to eight units. Similarly,  $\alpha_{S2}$ -casein also contains two cysteines and exists in a dimeric form. The composition and size of various caseins are shown in Table 2.8.

Casein micelles contain  $\alpha_{S1}$ -,  $\alpha_{S2}$ -,  $\beta$ -, and  $\kappa$ -casein in the ratio of 3:1:3:1. Most of the fractions  $\alpha_{S1}$ -,  $\alpha_{S2}$ -, and  $\beta$ -casein are located in the interior of micelles, with  $\kappa$ -casein predominantly wrapped around the surface of the micelle. Casein fractions in the interior of micelle are sensitive to calcium and become insoluble in the presence of calcium. However,  $\kappa$ -casein is not sensitive to calcium and thereby keeps the micelles containing calcium-sensitive caseins intact and suspended in aqueous phase.  $\kappa$ -Casein is a protein with hydrophilic carbohydrate moiety (sialic acid) that extends into aqueous phase. This arrangement further lends stability to the micelle. Casein micelles are stable under most heating, homogenization, and other dairy processing conditions.

Caseins possess certain distinctive amino acid makeup that impacts their processing and functional properties. They are rich in apolar and hydrophobic amino acids, namely valine, leucine, isoleucine, phenylalanine, tyrosine, and proline. The apolar amino acids normally are insoluble in water, but their nature is balanced by phosphate groups so that caseins exhibit some solubility. Methionine and cysteine, the sulfur-containing amino acids, are relatively low in caseins. This fact impacts their nutritional deficiency. On the other hand, the essential amino acid lysine content is high. In human diet, the high lysine content is helpful in complementing and balancing the low-lysine plant proteins. The  $\epsilon$ -amino group of lysine present in caseins interacts with the aldehyde group of lactose at elevated temperature, leading to the formation of brown pigments (Maillard reaction). This also explains browning of heat-sterilized milk and nonfat dry milk during extended storage.

The high proline content results in low  $\alpha$ -helix and  $\beta$ -sheet in their secondary structure, giving them

**Table 2.8.** Composition and Some Characteristics of Caseins

Casein	Approx. % of Total Casein	No. of Amino Acid Residues	Phosphate Groups	Approx. Mol. Wt. (Da)	Isoelectric pH
$\alpha_{S1}$ -Casein	38	199	8	23,164	4.1
$\alpha_{S2}$ -Casein	10	207	10–13	25,388	4.1
$\beta$ -Casein	35	209	5	23,983	4.5–5.3
$\kappa$ -Casein	13	169	1	19,038	4.1–4.5

Source: Adapted from Spreer, 1998; Fox, 2003; Otter, 2003.

ability for more proteolytic degradation and enhanced digestion (Otter, 2003).

Caseins possess limited secondary and tertiary structures. Accordingly, their molecular conformation is fairly flexible, and open. The polar and apolar amino acids in the primary structure of caseins contribute to hydrophilic and hydrophobic regions. This confers surface activity and contributes to emulsifying and foam-forming characteristics of caseins.

Caseins are very heat-stable under normal protein levels, environmental pH, and ionic concentrations. Moderate heat has little or no effect on casein molecules since they exist naturally in an open and extended state. However, heating of milk at elevated temperature for an appreciable length of time could result in hydrolytic cleavage of peptide and phosphate bond, which affects the stability of the complex, contributing to coagulation of milk.

Coagulation of milk is primarily a manifestation of micellar casein precipitation. This temperature-dependent phenomenon is critical in the manufacture of yogurt and fermented milks as well as in cheese making. The precipitation/coagulation mechanism consists of the following types:

**Isoelectric Precipitation.** Factors such as the pH strongly influence the electrostatic interactions in casein. Casein becomes insoluble and precipitates out when the milk is acidified and the pH is reduced to 4.6 at or above 20°C. At low temperature (4°C), no visible precipitation is observed. As the temperature is raised, coagulation is observed at or above 20°C. The proteins remaining in solution are whey proteins. The destabilization of micellar casein by added acid or by lactic acid produced during fermentation by lactic acid bacteria starts at pH 4.9 when colloidal calcium phosphate becomes soluble and changes to ionic form. As the pH reaches 4.6, calcium phosphate is cleaved in entirety from the micelle. At the same time, the isoelectric point of casein is reached and the micelle has no longer any charge to keep it suspended by repelling forces. The result is aggregation of casein micelles leading to dense coagulum. This type of coagulation is relevant in all fermented dairy products including cottage cheese and cream cheese. Many textural attributes are controlled by the temperature, quiescent conditions, pH, and rate of acidification of milk.

**Rennet Coagulation.** In the production of most cheese varieties, the mechanism of coagulation is

not acid-based but is caused by enzymatic attack by acid proteinase, chymosin contained in rennet. This coagulation occurs at normal pH of milk. The specific cleavage of  $\kappa$ -casein molecule occurs at amino acid 105 (phenyl alanine) and 106 (methionine) to form *para*- $\kappa$ -casein and a macropeptide called glycomacropeptide (GMP). The GMP contains carbohydrate residues. Being hydrophilic, it is soluble and ends up in the whey fraction. Since the micelles are stabilized by calcium-insensitive  $\kappa$ -casein, their hydrolysis by chymosin results in the exposure of calcium-sensitive  $\alpha_S$ -casein and  $\beta$ -casein to serum calcium; the overall effect is coagulum formation by aggregation of the micelles. Further hydrophobic interactions result in the expulsion of moisture from the coagulated micelles, causing syneresis and curd shrinkage. This coagulum is the basis of cheese curd formation. *para*- $\kappa$ -Casein is further degraded during cheese ripening to produce numerous flavor compounds and textural components.

**Polyvalent Ion Precipitation.** Because of its disordered molecular structure, casein fractions also precipitate out in the presence of di- and polyvalent ions of various salts.

**Alcohol Precipitation.** Casein micelles become unstable at 40% alcohol concentration at normal milk pH. At lower pH, the stability becomes even less and lower alcohol levels can precipitate milk. Dehydration of casein micelles appears to be the major cause of this type of precipitation.

**Heat Coagulation.** Severe and extensive heating of milk can cleave the calcium phosphate complexes with casein micelle, resulting in destabilization, aggregation, and precipitation. Casein can withstand normal heating processes in dairy plants; interactions do occur with the whey proteins.

Among the minor caseins of milk,  $\gamma$ -casein is the C-terminal fragment of  $\beta$ -casein, a product of attack by natural proteolytic enzyme plasmin. The N-terminal residue is the proteose-peptone fraction. These hydrolytic products of  $\beta$ -casein occur at a range of 3–10% of the total casein content of milk. The stage of lactation and the health status of the cow affect their concentration.

Peptides derived from caseins are biologically active and display significant extra nutritional attributes for maintaining normalcy of physiological functions in human subjects.



**Table 2.9.** Composition and Some Characteristics of Whey Proteins

Whey Protein	Approx. % of Total Whey Protein	No. of Amino acid Residues	Approx. Mol. Wt. (Da)	Isoelectric pH
$\beta$ -Lactoglobulin	7–12	162	18,277	5.2
$\alpha$ -Lactalbumin	2–5	123	14,175	5.1
Bovine serum albumin	0.7–1.3	582	69,000	4.8
Immunoglobulins	1.9–3.3	–	150,000–1,000,000	4.6–6.0
Proteose peptone	2–6	–	4,000–40,000	3.7

Source: Adapted from Spreer, 1998; Fox, 2003; Otter, 2003.

### Whey/Serum Proteins

Whey proteins consist of  $\beta$ -lactoglobulin and  $\alpha$ -lactalbumin, bovine serum albumin, immunoglobulins (mainly IgG1, IgG2, and IgM), lactoferrin, proteose-peptone, and a number of diverse enzymes. Table 2.9 shows some characteristics of whey proteins.

Compared to caseins, whey proteins have a relatively more ordered globular structure, which contains disulfide linkages. Accordingly, unlike caseins, they are soluble and not vulnerable to precipitation under acidic conditions or by polyvalent ions. Like other globular proteins, they are very heat-labile and can be denatured at 90°C, resulting in gel formation.  $\beta$ -Lactoglobulin complexes with  $\kappa$ -casein in milk when subjected to rigorous heat treatment. All the whey proteins are superior in biological value as compared to caseins and compare with the quality of egg albumins. Major differences in the behavior of caseins and whey proteins are summarized in Table 2.10.

**$\beta$ -Lactoglobulin.** This major whey protein of milk displays the presence of four genetic variants. Besides the two genetic variants namely A and B, variants C and D have also been reported.  $\beta$ -Lactoglobulin is rich in sulfur amino acids,

containing five cysteine residues. It exists as a dimer linked by 1–3 disulfide bonds. It is a fairly heat-labile protein. Heat treatment of 60°C results in partial denaturation. Differential scanning calorimetry results show a peak maximum of denaturation at 80°C and formation of reactive sulfhydryl groups that can interact with  $\kappa$ -casein and/or  $\alpha$ -lactalbumin by disulfide linkages. Further heating liberates hydrogen sulfide, which is associated with “cooked” flavor.  $\beta$ -Lactoglobulin stimulates lipolysis and generation of rancidity. It also acts as a carrier of vitamin A. The large numbers of lysine residues can result in lactosylation and accompanying changes in physical properties of the protein.

**$\alpha$ -Lactalbumin.**  $\alpha$ -Lactalbumin is the major protein of human milk, but in cow milk it is second in preponderance to  $\beta$ -lactoglobulin. Three genetic variants are reported, but Western cow contains variant B only. This protein is rich in tryptophan and sulfur amino acids cysteine and methionine. There are four disulfides in the molecule and it exists as a monomer.  $\alpha$ -Lactalbumin has 54 amino acid linkages identical to the enzyme lysozyme. It is a glycoprotein as well as a metalloprotein. One mole of calcium is bound to each protein molecule, which confers heat stability on  $\alpha$ -lactalbumin. This protein

**Table 2.10.** Major Differences in Physical and Chemical Properties of Casein and Whey Protein

Casein	Whey Protein
Strong hydrophobic regions	Both hydrophobic and hydrophilic regions
Phosphate residues	No phosphate residues
Little cysteine content	Both cysteine and cystine content
Random coil structure	Globular structure and helical structure
Very heat-stable	Heat-denatured and precipitates
Precipitates at pH 4.6	Soluble at pH 4.6
Precipitates with di- and polyvalent ions	Relatively resistant to the ions

Source: Adapted from Chandan, 1997.

has been shown to possess a physiological role in the synthesis of lactose in the mammary gland. It is a component of lactose synthetase along with uridine diphosphate-galactosyl transferase, catalyzing the transfer of galactose to glucose to form lactose.

**Immunoglobulins.** There are five major classes of immunoglobulins, viz., IgA, IgD, IgE, IgG, and IgM. Their concentration is very high (100g/l) in first two to three milkings after calf birth, but falls to 0.6–1 g/l soon after. Immunoglobulins are antibodies synthesized in response to stimulation by specific antigens. These offer nonspecific humoral response to Gram-negative enteric and aerobic bacteria. Accordingly, they provide passive immune protection to the newly born calf. The basic structure of all immunoglobulins is similar, which is composed of two identical light chains (23,000 Da) and two identical heavy chains (53,000 Da). The four chains are joined together by disulfide bonds. The complete molecule has a molecular weight of about 180,000 Da. The antigenic sites are located at the NH<sub>2</sub>-terminal of the respective chain. Of the five immunoglobulin classes, IgG is the predominant fraction of milk, comprising about 90% of the total colostral immunoglobulins. Relatively smaller concentrations of IgM and IgA are also present in progressively decreasing amounts.

**Bovine Serum Albumin.** As the name indicates, this protein originated from blood and during synthesis in the udder spills into milk. It is a large molecule with binding ability for fatty acids and metals.

**Lactoferrin/Lactotransferrin.** This is a glycoprotein that displays a strong tendency to bind ionic iron because of the presence of two metal binding sites. The average lactoferrin content of 0.32 mg/ml has been found for cow milk. The molecular weight of lactoferrin varies between 73,700 and 74,000 Da. Lactoferrin displays a very strong chelating tendency for ionic iron and forms a salmon red color pigment. Lactoferrin is a single peptide chain, with two lobes, each of which is capable of binding iron. Iron-free form of lactoferrin is known as apolactotransferrin, which is colorless in appearance. Lactoferrin displays a strong inhibitory effect toward Gram-negative enteropathogenic bacteria by virtue of its ability to bind free ionic iron, which is essentially required for the growth of enteropathogenic microorganisms. Apart from the antibacterial effect in the gut of calf, a nutritional role in iron metabolism has also been ascribed to lactoferrin.

## Biologically Active Proteins and Peptides

A number of proteins and peptides derived from milk proteins have physiological activity. They are (1) immunoglobulins, lactoperoxidase, lactoferrin, and folate-binding protein; (2) insulin-like growth factors (IGF-1 and IGF-2), mammary-derived growth factors (MDGF-I and MDGF-II), transforming growth factors (TGF<sub>α1</sub>, TGF<sub>α2</sub>, TGF<sub>β</sub>), fibroblast growth factors, platelet-derived growth factors, bombesin, and bifidus factors; (3) peptides derived from milk proteins, such as glycomacropptides from κ-casein, phosphopeptides from caseins, caseinomorphins, immunomodulating peptides, platelet-modifying peptides, angiotensin-converting enzyme (ACE) inhibitor that lowers blood pressure, calmodulin-binding peptides, and bactericidal peptides from lactotransferrin (Otter, 2003).

## MILK ENZYMES

Milk is a repository of a variety of enzymes. Over 60 indigenous enzymes have been reported in cow milk. They are associated either with milk fat globule membrane (xanthine oxidase, sulfhydryl oxidase, and γ-glutamyltransferase) or with skim milk serum (catalase, superoxide dismutase) or with micelles of casein (plasmin and lipoprotein lipase). The partition and distribution of these enzymes is affected by the processing and storage conditions of milk. Other enzymes present are lactate dehydrogenase, malate dehydrogenase, lactoperoxidase, galactosyl transferase, alkaline phosphatase, phosphoprotein phosphatase, ribonuclease, lysozyme, fructose biphosphate aldolase, and glucose phosphate isomerase. The enzymes in milk come either from the cow's udder (original enzymes) or from bacteria (bacterial enzymes). Several of the enzymes in milk are utilized for quality testing and control. Some of the enzymes, which are important from the processing point of view, are described below:

### Alkaline Phosphatase

This enzyme has assumed significance because of the association with the temperature at which it is inactivated and the temperature employed for pasteurization of milk. The basis of pasteurization is that the spore-forming pathogens, which may be present in milk, are completely destroyed by heat treatment designated in the pasteurization process. In turn, alkaline phosphatase activity is also destroyed by the

pasteurization heat treatment. Thus, efficiently pasteurized milk should be safe from pathogens, and concomitantly, should not display any alkaline phosphatase activity. Contamination of pasteurized milk with raw milk can also be detected by positive phosphatase activity in milk. Alkaline phosphatase is distributed through milk. Its concentration is higher in the cream fraction. The optimum pH for the action of alkaline phosphatase on *p*-nitrophenylphosphate is 9.5. The  $K_m$  value for this substrate is  $6.6 \times 10^{-4}$  M for skim milk enzymes, whereas for the cream alkaline phosphatase the corresponding value is  $3.6 \times 10^{-4}$  M. For details of the test, see Chapter 7.

### Lipoprotein Lipase

This enzyme brings about hydrolytic cleavage of glycerides, liberating free fatty acids and glycerol. The volatile short-chain free fatty acids generate undesirable rancid flavor in milk. Thus, the activity of this enzyme can result in rancid flavor defects in dairy products. Lipase is activated by homogenization of fat globule membrane in raw milk. Similarly, lipase can degrade milk fat and develop off-flavor in a short storage period, if raw milk accidentally gets mixed with homogenized milk. The optimum pH for the enzymatic activity ranges from 8.4 to 9.0, while optimum temperature for enzymatic activity is 37°C. Sodium chloride and magnesium chloride have a stimulatory effect on these enzymes whereas calcium chloride and manganese chloride have an inhibitory effect. Residual activity of lipase remaining in processed milk or milk products tends to reduce their shelf life.

### Protease/Plasmin

This enzyme is responsible for the hydrolytic degradation of proteins. The optimum activity is observed at a temperature of 37°C and a pH of 8.0. Nearly 82% of proteolytic activity is lost when milk is pasteurized. Native proteases of milk are more heat-labile compared to the microbial proteases, which tend to survive even UHT processing treatment. Residual proteolytic activity in processed milk and milk products leads to decrease in shelf life.

### Lactoperoxidase

This enzyme catalyzes oxidation of substrate in the presence of an oxygen donor such as hydrogen peroxide. It displays optimum activity at pH of 6.0 and

is stable over a wide pH range of 5.0–10.0. This enzyme has gained significance in view of its supportive role for the preservation of raw milk by employing the lactoperoxidase (LP) system under ambient conditions.

### Lysozyme

This is a relatively small, single peptide chain protein. The variant found in bovine milk has 129–130 amino acid residues, with molecular weight of 14,000Da. The lysozyme cleaves the glycosidic linkage between *N*-acetylmuramic acid and *N*-acetylglucosamine of the bacterial cell wall. Gram-positive bacteria are generally more susceptible because they have a simpler cell wall providing greater accessibility of the substrate compared to the Gram-negative bacteria. Cow milk contains about 13 µg/100 ml of lysozyme. More recently, emphasis has been focused on the antibacterial role of lysozyme as a natural defense in milk. During mastitis, lysozyme levels in milk tend to increase considerably, being in the range of 100–200 µg/100 ml. It has also been suggested that lysozyme may have an indirect effect on the defense systems as an immunomodulator through the stimulation of the breakdown products of the peptidoglycan on the immunosystem.

## FUNCTIONAL ATTRIBUTES OF MAJOR MILK PROTEINS

Milk proteins are used in various foods to impart desirable effects. Table 2.11 shows such characteristics of milk proteins that are helpful in their use as functional ingredients.

### LACTOSE

The major carbohydrate of milk, lactose monohydrate, ranges from 4.8% to 5.2%. Lactose content of milk is relatively constant. In colostrum and mastitic milk, its concentration is significantly lower. It constitutes 52% of MSNF, nonfat dry milk, and 34% whey protein concentrate, and 70% of whey solids. It is a disaccharide of one residue each of D-glucose and D-galactose. Structurally, lactose is 4-*O*-β-D-galactopyranosyl-D-glucopyranose. Fresh milk contains small amounts of glucose (100 mg/100 ml), galactose (100 mg/100 ml), and oligosaccharides (10mg/100 ml). It is a reducing sugar and extensive heating of milk results in Maillard reaction between lactose and proteins, creating brown pigments and a brownish color of milk.

**Table 2.11.** Functional Properties of Milk Proteins

Functionality	Casein or Caseinates	Whey Proteins
Water binding	Very high, minimum at pH 4.6	Water-binding capacity increases with denaturation of the protein
Solubility	Insoluble at pH 4.6	Soluble at all pH levels. If denatured, insoluble at pH 5
Viscosity	High at or above pH 4.6	Low for native protein. Higher, if denatured
Gelation	No thermal gelation except in the presence of $\text{Ca}^{+2}$ Micelles gel with rennin	Heat gelation at 70°C (158°F) or higher and influenced by pH and salts
Emulsification	Excellent at neutral and basic pH	Good except at pH 4–5, if heat-denatured
Foaming	Good overrun. $\kappa$ -Casein best followed by $\beta$ - and $\alpha_{S1}$ -caseins. Poor foam stability	Good foam/overrun. $\beta$ -Lactoglobulin better than $\alpha$ -lactalbumin
Flavor binding	Good	Retention varies with degree of denaturation

Source: Adapted from Fox, 2003; Chandan, 1997.

In isolated form, lactose exists in either of the two crystalline forms,  $\alpha$ -hydrate and anhydrous- $\beta$ , or as amorphous “glass” mixture of  $\alpha$ - and  $\beta$ -lactose. In solution both the forms exist in equilibrium with a ratio of ( $\alpha$  to  $\beta$ ) 1.68 at 20°C. Lactose has an asymmetric carbon and therefore displays optical activity. Lactose anomers rotate plane-polarized light and their concentration can be assayed by polarimetric measurements. The  $\alpha$ -lactose anomer is more dextrorotatory than the  $\beta$ -lactose anomer. If lactose crystallizes from a solution like milk or whey below 93.5°C,  $\alpha$ -lactose is usually formed, while above 93.5°C,  $\beta$ -lactose is usually formed. During crystallization, the  $\beta$ -form mutarotates to  $\alpha$ -lactose. Crystals of  $\alpha$ -lactose monohydrate are shaped like a tomahawk and other shapes arise as a result of cocrystallization on the face of lactose crystals. The rate of crystallization, size, and shape of lactose crystals depend on the degree of supersaturation of lactose solution and the inhibitor ( $\beta$ -form) level.

The  $\alpha$ -form is less soluble (70 g/l at 15°C) than the  $\beta$ -form. Crystallization of lactose when milk is concentrated is of importance in regard to the texture. An equilibrium mixture of  $\alpha$ - and  $\beta$ -lactose, formed by mutarotation, exhibits a solubility of about 155 g/l at 10°C and 119 g/l of water at 0°C. The relatively poor solubility at low temperatures (4°C or below) contributes to sandy texture in high milk solids ice cream, processed cheese products, and condensed milk products. As a general rule, a concentration of lactose exceeding 13 g/100 ml water in a dairy product tends to promote crystallization of  $\alpha$ -lactose monohydrate and accompanying sandy texture defect. In the manufacture of nonhygroscopic dry milk and whey, lactose

crystallization plays an important role. In rapid drying conditions, lactose glass (amorphous lactose) is formed. This form of lactose is very hygroscopic and causes caking in dried products containing moisture levels of 8% or more. Under such conditions, the conversion of lactose glass to  $\alpha$ -lactose monohydrate crystals is responsible for binding powder particles together as a “cake.”

In sweetening power, lactose is only 16–33% as sweet as sucrose. This makes lactose uniquely suitable for certain food applications. Toppings, icing, and various types of fillings are examples of use where its inclusion in the formulations can improve the quality. The pharmaceutical industry has used lactose for many years for tablet or pill formation. Being a reducing sugar, it reacts with proteins to form a highly flavored golden brown substance, commonly found on the crust of baked foods. Lactose contributes significantly to the flavor, texture, appearance, shelf life, and toasting qualities of baked foods.

A compound formed from lactose in heated milk products is lactulose. It stimulates the growth of *Bifidobacterium bifidum* and is thus beneficial in establishing useful microflora in the gut.

The role of lactose in yogurt and fermented milks is extremely important because the culture nutritionally requires it as a substrate for growth. It is a source of carbon and after fermentation about 30% of the lactose content is converted to lactic acid. Lactose is easily hydrolyzed by  $\beta$ -D-galactosidase or lactase enzyme of the culture to glucose and galactose. Glucose is readily metabolized by the Embden–Meyerhof–Parnas pathway, while galactose tends to accumulate. One molecule of lactose gives one molecule of

galactose and two molecules of lactic acid. Energy is generated in this reaction. The acid production lowers the pH enough so that the fermented food is safe from most pathogens. The shelf life of fermented milks is significantly increased because many spoilage organisms cannot grow at their low pH.

Digestion of lactose presents a problem in some individuals. These individuals lack the enzyme  $\beta$ -D-galactosidase in their gastrointestinal tract. Consequently, dietary lactose is not hydrolyzed and it reaches the colon intact where it is metabolized by colonic bacteria forming gases like methane and hydrogen. It leads to discomfort caused by bloating and diarrhea. This lactose malabsorption is alleviated by yogurt containing live cultures, because the culture furnishes the lactose-hydrolyzing enzyme and normal digestion pattern is restored.

### MINERALS

Average normal milk is considered to contain 0.70% ash and this amount represents a salt content of about

0.90%. The percentage of salt and ash in milk varies with the breed, feed, season, and stage of lactation and disease. The white residue after incineration of a given weight of milk is used as a measure of the mineral content of milk. Ash content is not identical to milk mineral level because of decomposition and volatilization of certain minerals as a result of heat. The ash contains substances derived from both the organic and inorganic compounds in the milk. The  $\text{CO}_2$  of the carbonates is formed mostly from the organic components; the  $\text{SO}_3$  of the sulfates is considered to be a decomposition product of the proteins. Part of the  $\text{P}_2\text{O}_5$  arises from the casein, since this protein contains phosphorus equivalent to about 1.62%  $\text{P}_2\text{O}_5$ . Citric acid is completely lost. Chloride is partly lost (45–50%) by the high temperature employed for ashing. This loss can be minimized by keeping the temperature below  $600^\circ\text{C}$ . The mineral content of milk is shown in Table 2.12.

Mineral makeup of milk is crucial to the stability of the physicochemical equilibrium in milk. The minerals of milk exist in colloidal and soluble form.

**Table 2.12.** Typical Mineral Content of Cow's Milk

	Mean (mg/100 ml)	Range (mg/100 ml)
<i>Major Mineral</i>		
Calcium, total	121	114–130
Calcium, ionic	8	6–16
Citrate	181	171–198
Chloride	100	90–110
Magnesium	12	9–14
Phosphorus, inorganic	65	53–72
Potassium	144	116–176
Sodium	58	35–90
	Mean ( $\mu\text{g}/100$ g of milk)	Range ( $\mu\text{g}/100\text{g}$ of milk)
<i>Trace Elements</i>		
Boron	27	–
Chromium	1	0.8–1.3
Cobalt	0.1	0.05–0.13
Copper	20	10–60
Fluoride	12	3–22
Iodine	26	–
Iron	45	30–60
Manganese	3	2–5
Molybdenum	7	2–12
Nickel	2.5	0–5
Selenium	12	5–67
Silicon	260	75–700
Zinc	390	200–600

Source: Adapted from Swaisgood, 1996; Fox, 2003.

**Table 2.13.** Partition of Major Minerals in Colloidal and Solution Phases

Major Mineral	Percent of Total Mineral as	
	Colloidal	Dissolved
Calcium	67	33
Magnesium	36	64
Sodium	4	96
Potassium	6	94
Phosphate	55	45
Citrate	6	94
Chloride	0	100
Sulfate	0	100

Table 2.13 shows approximate phase compositions of the minerals.

They are present in a complex equilibrium consisting of colloidal state and soluble state. The soluble state exists in both ionic and nonionic form, and their ratio is influenced by the pH of milk. Their concentration is less than 1% in milk but the technological behavior of milk is affected a great deal by them. For instance, the following characteristics are influenced:

- Heat stability and alcohol coagulation of raw milk.
- Preparation, quality, and storage stability of products like concentrated/condensed, evaporated milk products.
- Clumping of fat globules upon homogenization of cream.
- The calcium content of milk influences the firmness of curd during cheese making and the viscosity of fermented milks. From a nutritional standpoint, milk is an excellent source of calcium and phosphorus. Their ratio in milk is optimal for bone formation and bone health.

Sodium, potassium, and chloride are almost completely (95–96%) present in true solution and in ionic form and therefore diffuse freely across the membrane during ultrafiltration and electro dialysis of milk and whey. Calcium and magnesium, phosphate and citrate are partly in solution and partly in colloidal suspension, depending on the pH of milk. Approximately 20–30% of diffusible Ca and Mg exist as free ions and the remainder as salts of citrate and phosphate. As the pH of milk drops in manufacturing yogurt and fermented milks, the colloidal form is converted progressively to the ionic form. At pH 4.4 most of the minerals are in ionic, soluble, and diffusible form.

## VITAMINS AND SOME OTHER MINOR CONSTITUENTS

The concentrations of fat-soluble vitamins A, D, E, and K, water-soluble vitamins B and C, and minor constituents of milk are given in Table 2.14.

Milk contains both fat-soluble (A, D, E, and K) and several water-soluble vitamins. In the production of low-fat and skim milk, the fat-soluble vitamins get concentrated in the cream fraction. Whole milk is a good source of vitamin A but the separation process leads to low vitamin A content in low-fat and skim milk. The FDA regulations require fortification of low-fat and skim milk to restore and to make the vi-

**Table 2.14.** Vitamins and Some Minor Components of Milk

	Per 100 g of milk
<i>Vitamins</i>	
A	40 µg RE
D	4 IU
E	100 µg
K	5 µg
B <sub>1</sub>	45 µg
B <sub>2</sub>	175 µg
Niacin	90 µg
B <sub>6</sub>	50 µg
Pantothenic acid	350 µg
Biotin	3.5 µg
Folic acid	5.5 µg
B <sub>12</sub>	0.45 µg
C	2 mg
<i>Nonprotein Nitrogen (NPN) Compounds</i>	
Total NPN	23–31 mg
Urea N	8–13 mg
Creatine N	0.6–2 mg
Uric acid N	0.5–0.8 mg
Orotic acid N	1.2 mg
Peptides N	3.2 mg
Ammonia N	4–5 mg
Choline	4–28 mg
Carnitine	1–1.7 mg
<i>N</i> -Acetyl neuraminic acid	12–27 mg
<i>Miscellaneous Compounds</i>	
Nucleic acids and nucleotides	56 mg
Phosphoric esters	30 mg
Ethanol	0.3 mg
Lactic acid	3.5–10 mg
Citric acid	175 mg
Acetic acid	0.3–5 mg
Formic acid	1–8.5 mg

Source: Adapted from Goff and Hill, 1992.

tamin A content of low-fat and skim milk equivalent to that of whole milk. The regulations require 2,000 IU of vitamin A per quart of milk. The objective is to insure essentially the same dietary vitamin A contribution of all fluid milk beverages. Natural vitamin A activity in milk is due to retinol and the pigment  $\beta$ -carotene. Their levels as well as those of vitamin D and E vary in milk according to the season and feed profile. Vitamin D is important in bone health and vitamin E is an antioxidant. Vitamin K is present in milk but its dietary nutritional role is minor.

Milk is an important source of dietary B vitamins. They are stable to various heating and processing conditions milk is normally subjected to. Riboflavin is vulnerable to light (wavelength  $<610$  nm), generating a sunlight flavor defect in milk. Ascorbic acid (vitamin C) content of milk is very low and not significant. Also, it is inactivated by heat processing.

As shown in Table 2.14, some nonprotein nitrogen compounds and several miscellaneous compounds are also detected in milk.

## PHYSICAL CHARACTERISTICS OF MILK

The reader is referred to excellent reviews on the subject by McCarthy (2003), Goff and Hill (1993), and Fox and McSweeney (1998).

### OPTICAL PROPERTIES

#### Color

The color and appearance of milk has significance because the consumers perceive it as a parameter of quality. The opaque, white or turbid color of milk is due to the scattering of light by the dispersed phase of fat globules, casein micelles, and the colloidal calcium phosphate. The intensity of color is directly proportional to the size and number of these particles. The smaller particles scatter light of shorter wavelength. The creamy color of whole milk is due to its  $\beta$ -carotene content. Some breeds (for example, Guernsey cows) have more of this pigment and their color is yellowish/golden. In cases of goat milk and water buffalo milk, the pigment content is very low.  $\beta$ -Carotene is a precursor of vitamin A and in the milks of goats and water buffaloes, it is inherently converted to vitamin A. Accordingly, their milk has white color as opposed to the creamy color of cow's milk.

Extended heating imparts a slightly brown color to milk as a result of Maillard's reaction between lactose and proteins.

Homogenization increases the number and total volume of fat globules. This results in whiter color of homogenized products than their unhomogenized counterparts. Lack of fat globules and the presence of water-soluble pigment riboflavin produces a bluish green tint in skim milk. In the absence of fat globules, light scattering is primarily by casein micelles, which scatter more blue (short wavelengths of light) than red. The color thus becomes distinctly green in whey after removal of casein particles from skim milk. The yellow color of cow milk fat in butter and cream is due to the presence of the fat-soluble pigments carotene and xanthophyll.

#### Refractivity

The refraction of light by a solution is a function of the molecular concentration of the solute in the solution. Each solute maintains its own refractivity, and the refractive index of a mixture is that of the total of the refractive indices of the substances plus that of the solvent. The components of milk contributing to its refractive index in descending order of importance are water, proteins, lactose, and minor constituents. Specific refractive increments (in ml/g) in water at wavelength 589.3 nm and temperature 20°C for casein complex, whey proteins, lactose, and other dissolved substances are 0.207, 0.187, 0.140, and 0.170, respectively. The fat globules do not contribute to the refractive index of milk because refraction occurs at the interface of plasma and air.

Refractive index of a substance varies with the wavelength of the light and the temperature at which the measurement was taken. It is generally measured at 20°C with D line of sodium spectrum (wavelength 589.3 nm) and represented as  $n^{20}_D$ . The value of  $n^{20}_D$  of cow milk generally falls in the range of 1.3440–1.3485. Refractive indices of human and goat milks have slightly higher values. The refractive index of milk fat ranges from 1.4537 to 1.4552 at 40°C and is used for verification of its authenticity.

#### FLAVOR

Taste and aroma are critical to the assessment of milk. Flavor is a critical criterion of quality for the consumer. It is a sensory property in which odor and taste interact. The sweet taste of lactose is balanced against the salty taste of chloride, and both are somewhat moderated by proteins. This balance is maintained over a fairly wide range of milk composition even when the chloride ion level varies from 0.06% to 0.12%. Saltiness can be detected by sensory tests in

**Table 2.15.** Off-Flavors in Milk Caused by Absorption from the Feed and Environment

Off-Flavor	Description	Possible Cause
Feed	Aromatic, onion, garlic	Cows fed 0.5–3 hours before milking
Cow	Chemical after-taste, cow's breath odor	Cows with ketosis/acetone
Barn	Unclean, reminiscent of barn, silage	Poor ventilation, buildup of aromatic silage/barn odors

samples containing 0.12% or more of chloride ions and becomes marked in samples containing 0.15%. Some workers attribute the characteristic rich flavor of dairy products to the lactones, methylketones, certain aldehydes, dimethyl sulfide, and certain short-chain fatty acids.

Although milk has a clean, pleasantly sweet flavor, it is quite bland, and therefore, any off-flavors are readily discernible. Off-flavors result when the balance of flavor compounds is altered because of the microbiological activity or processing treatments, or chemical or biochemical reactions. The fat globules have a large surface area and tend to adsorb aromatic odors (for example, onion and garlic) readily.

Some off-flavors in milk are shown in Tables 2.15–2.18.

## ACIDITY AND pH

Freshly drawn milk shows a certain acidity as determined by titration with an alkali (sodium hydroxide) in the presence of an indicator phenolphthalein (equivalent to pH 8.3). This acidity, also called titratable acidity, as determined by titration, is known as “natural” or “apparent” acidity. It is caused by the presence of casein, acid-phosphates, citrates, etc., in milk. The natural acidity of individual milk varies considerably depending on species, breed, individuality, stage of lactation, physiological condition of the udder, etc., but the natural acidity of fresh, herd/pooled milk is much more uniform. The higher the SNF content in milk, the higher the natural acidity

and *vice versa*. The titratable acidity of individual cow milk varies from 0.12% to 0.18%, but in commercial pooled milk the range is only 0.14–0.16%. “Developed” or “real” acidity is due to lactic acid, formed as a result of bacterial action on lactose in milk. Hence, the titratable acidity of stored milk is equal to the sum of natural acidity and developed acidity. The titratable acidity is usually expressed as a “percentage of lactic acid.” The higher the serum solids, the higher is the titratable acidity. But the pH remains relatively the same. The titratable acidity (or pH measurement) is a critical parameter in yogurt and fermented milk production. It determines the end point of the fermentation process. Measuring the pH is preferable because unlike titratable acidity, it does not vary with the total MSNF in yogurt mix.

The pH of normal, fresh, sweet milk usually varies between 6.6 and 6.8. Higher pH values for fresh milk indicate udder infection (mastitis) and lower values indicate bacterial action. Skimming and dilution with water raise the pH of milk while sterilization usually lowers it.

## BUFFERING CAPACITY

The pH is a measure of acidity or inverse of the logarithm of the hydrogen ion concentration in milk. The relationship of hydrogen ion concentration and pH is shown by the following equation. A weak acid (HA) dissociates as follows:

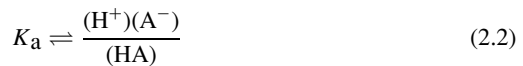
**Table 2.16.** Milk Off-Flavors of Microbiological Origin

Off-Flavor	Description	Possible Cause
Malty	Grape nut-like, caramelized burnt	Unsanitary equipment, insufficient cooling and storage at >10°C
Bitter/unclean Fruity/fermented	Musty, spoiled, stale, dirty, bitter Odor resembling fruits like apple/pineapple	Exposure to warm temperature, dirty utensils, weeds Old milk, too long storage of raw milk
Sour	Tingling acidic taste	Growth of lactic and other organisms



**Table 2.17.** Off-Flavors in Milk of Biochemical Origin

Off-Flavor	Description	Possible Cause
Rancid	Bitter, soapy, foul odor, unclean	Homogenized raw milk stored too long, mixture of pasteurized and raw milk, raw milk agitated vigorously
Oxidized/light-induced	Medicinal chemical taste, reminiscent of burnt feather or tallow	Milk in transparent plastic/glass bottles exposed to sunlight or UV light in refrigerated cases

Here,  $K_a$  is dissociation constant,  $(H^+)$  is hydrogen ion concentration, and  $(A^-)$  is the concentration of the anion and  $(HA)$  is the concentration of the acid HA.

$$pH = \log \frac{1}{(H^+)} = pK_a + \log \frac{(A^-)}{(HA)} \quad (2.3)$$

Here  $pK_a$  equals  $-\log_{10} K_a$ . When the pH equals  $pK_a$ , the weak acid is 50% dissociated and the buffering capacity is maximum. Proteins contain many basic and acid groups in their molecule. Generally, their maximum buffering capacity is at their isoelectric point. For milk, maximum buffering capacity is around pH 5.1.

Milk displays innate ability to resist the changes in the pH or exhibits buffering capacity (dB/dpH). This is mainly due to the presence of amino acid residues of caseins and whey proteins, and colloidal salts (calcium phosphate complex, citrates, etc.). Caseins display maximum buffering capacity at their isoelectric pH of 4.6 and phosphates at around pH 7.0. Whey proteins show maximum buffering capacity at pH 4–5. The buffer index of milk is defined as the amount of acid or alkali (mol/l) required in changing the pH of 1 liter of milk by one unit. Buffering capacity has some significance in the survival of live cultures in the stomach where high acid conditions are deleterious to the survival of yogurt cultures. Since pH of yogurt is close to its isoelectric point, the milk proteins of yogurt exercise maximum buffering capacity. Accordingly, the impact of acidic conditions on the

culture cells is somewhat moderated for better survival rates in the stomach.

## ELECTROCHEMICAL PROPERTIES

### Oxidation Reduction Potential

The oxidation–reduction ( $E_h$ ) potential of milk is expressed in volts. It is measured relative to the potential of the standard hydrogen electrode, which is assigned 0 V at pH 0.  $E_h$  is due to the presence of several soluble constituents capable of yielding or accepting electrons. In milk,  $E_h$  is controlled by factors such as dissolved oxygen, ascorbic acid, riboflavin, cystine–cysteine transformation, and pH value. Fresh cow milk displays values of +0.2 to +0.3 V at 30°C. It is due largely to dissolved oxygen, ascorbic acid, and riboflavin. Bacterial growth reduces the oxygen tension. Methylene blue reduction test, used for assessing the microbial quality of milk, is based on this phenomenon. The ascorbic acid oxidation in stored milk leads to the formation of singlet oxygen, which in turn is involved in lipid oxidative deterioration. Riboflavin in milk exposed to light near 450 nm assists in photooxidation of methionine residues of whey proteins to produce methional, the principal cause of sunlight flavor defect. Heating of milk increases the reducing capacity of milk and heating above 70°C also causes noticeable decrease in the  $E_h$  because of the liberation of  $-SH$  groups from whey proteins. The increase in the reducing capacity of yogurt mix

**Table 2.18.** Off-Flavors Arising from Processing Conditions

Off-Flavor	Description	Possible Cause
Cooked	Sulfur-like odor, caramelized, scorched	Too high pasteurization temperature and holding time too long, Excessive heat treatment
Foreign	Non-milk-like odor/flavor	Contamination with sanitizers, cleaning compounds
Flat	Watery	Too low milk solids, watered milk

after heat treatment is significant in promoting the growth of yogurt bacteria, which are microaerophilic in nature.

### Electrical Conductivity

Current passes through milk by virtue of the activity of its ionic mineral constituents, of which chloride ions carry 60–68% of the current. There is, therefore, a close correlation between the electrical conductivity of milk and its chloride content. The specific electrical conductivity of milk at 25°C ranges between  $0.004 \Omega^{-1} \text{ cm}^{-1}$  and  $0.0055 \Omega^{-1} \text{ cm}^{-1}$ , corresponding to that of approximately 0.25% NaCl solution (w/w). Higher values usually represent mastitic infections. Sodium, potassium, and chloride ions are the major contributors to electrical conductance of milk. Whey and permeate from ultrafiltration have higher conductivity than skim milk. The presence of fat tends to decrease the specific conductance. Conductivity of milk may be used to detect added neutralizers.

The development of acidity by bacterial action during fermentation of milk increases its conductance because of conversion of calcium and magnesium to ionic forms. Thus, measuring their electrical conductance can follow the progress of fermentation during manufacture of yogurt and other fermented dairy products. Electrical conductance can also be used to follow demineralization of whey, leading to loss of ionic minerals during the manufacture of whey protein concentrates. Electrical conductance is directly proportional to temperature. Conductance of milk increases by about  $0.0001 \Omega^{-1} \text{ cm}^{-1} \text{ C}^{-1}$ .

## THERMAL PROPERTIES

### Thermal Expansion

When warmed the volume of milk increases which affects the design considerations for storage and flow rates through processing treatments. The coefficient of thermal expansion of fresh milk (4% fat, 8.95% SNF) is approximately  $0.335 \text{ cm}^3/\text{kg}/^\circ\text{C}$  at a temperature range of 5–40°C. (Goff and Hill, 1993).

### Heat Capacity

Heat capacity of milk and milk products, a function of total solids of the sample, decreases with their increasing contents. Heat capacity expressed in SI units

equates to  $1/4186 \text{ cal/g}/^\circ\text{C}$  in cgs units. Heat capacity increases linearly with increase in temperature in skim milk from 3906 J/kg/K at 50°C to 4218 J/kg/K at 140°C, according to the following equation (Goff and Hill, 1993):

$$\text{Heat capacity} = 2.814 \times \text{temperature in } ^\circ\text{C} + 3824$$

The heat capacity of milk and cream depends strongly upon fat content. Milk fat has a heat capacity of 2177 J/kg/K. The heat of fusion is 8.37 J/g. The heat capacity of milk in the range of 50–140°C can be estimated according to the equation

$$\text{Heat capacity of milk} = 2.976 \times \text{temperature } ^\circ\text{C} + 3692$$

### Specific Heat

Specific heat is the ratio between the amount of heat necessary to raise a given weight of a substance to a specified temperature and the amount of heat necessary to raise an equal weight of water to the same temperature. It is nearly identical to the heat capacity figure as the heat capacity of water ( $1 \text{ cal/g}/^\circ\text{C}$  or 4186 J/kg/K) is fairly constant over the range of 0–100°C. It is important in processing for determining the amount of heat or refrigeration necessary to change the temperature of milk. Fat content influences the specific heat of the product.

Specific heat of skim milk and whole milk is approximately 4.052 and 3.931 kJ/kg/k, respectively at 80°C. The value for non fat dry milk ranges from 1.172–1.340 kJ/kg/k at 18–30°C while for milk fat it is 2.177 kJ/kg/k.

### Thermal Conductivity

Thermal conductivity determines how fast milk is cooled or heated. It is the rate of heat transfer by conduction in J/m/s/K. Thermal conductivity increases as temperature increases. It decreases as the concentration level increases, and for a given temperature and concentration, the higher the fat content, the lower the thermal conductivity. The thermal conductivity for milk at 20°C is 0.53 J/m/s/K, and 0.61 J/m/s/K at 80°C. There is a marked decrease in the thermal conductivity with increase in either fat or total solids.

### Effects of Heat

Dairy plants routinely use heat processes to make milk safe from pathogenic organisms and to extend

the shelf life of milk and milk products. The pasteurization and sterilization temperatures and holding times employed in such treatments have profound effects on milk proteins, enzymes, fat globule membrane, some vitamins, and physical state of minerals and other constituents. Caseins of milk are relatively stable to moderate heating regimes under conditions of normal pH and ionic balance. The serum proteins are globular proteins. They are more prone to denaturation to heat. At 60–65°C,  $\beta$ -lactoglobulin molecules begins to uncoil themselves and start interaction with  $\kappa$ -casein located in casein micelle forming disulfide linkages. The denaturation process is complete at 90–95°C when milk is held for 5 minutes. Under this heat treatment,  $\alpha$ -lactalbumin is relatively less vulnerable to heat, undergoing reversible denaturation. However, the immunoglobulins are fully denatured. In the manufacture of yogurt, this heating treatment is beneficial in increasing water-holding capacity and in reducing syneresis of the coagulum. Also, the resultant viscosity increase assists in optimizing the texture of yogurt. High heat treatment is deleterious to rennin curd formation, and should be avoided in cheese manufacture.

Normal pasteurization treatment causes “cream plug phenomenon” in which some fat globules break down to free fat that sticks to other fat globules giving rise to the plug. On homogenization, the plug is broken down. Exposure to higher temperatures (>135°C) results in partial aggregation of proteins of milk fat globule membrane and a more dense membrane that is less permeable.

Severe heat treatment above 100°C gives rise to brown pigments (melanoidin polymers) in milk. The Maillard reaction between the  $\epsilon$ -amino group of lysine residue of proteins and carbonyl group of lactose gives a brown color to milk. Such heat treatment also results in nutritional compromise. Cooked flavor results from the production of sulfhydryl groups arising from the breakdown of disulfide linkages.

### Heat Stability

In the manufacture of certain high heat-treated/concentrated milk products, heat stability of milk plays a significant role. A number of factors interact in a complex manner, which ultimately determines the heat coagulation of milk. On the basis of significant findings, the role of various interacting factors may be summarized as follows:

*Protein composition:* Various genetic variants of the casein fractions display variable heat stability. The heat coagulation of milk is related to the ratio between  $\kappa$ -casein and  $\beta$ -lactoglobulin. Higher heat coagulation temperature is observed at higher levels of  $\beta$ -lactoglobulin.

*Mineral balance:* The heat stability of milk is mainly determined by the makeup of proteins as well as the relative concentration of various salts present in colloidal and ionic states. The molar ratios between various cations and anions (both monovalent/polyvalent) strongly impact the physical equilibria of milk and the heat stability. Heat stability is maximum at the optimum salt equilibria defined by the relative concentration of  $\text{Ca}^{+2}$ ,  $\text{Mg}^{+2}$ , citrate<sup>-3</sup>, and phosphates<sup>-3</sup>.

The molar ratio between cations and anions mainly determines whether milk will be stable at certain temperature and pH employed for processing. When milk is heated, salts of calcium and magnesium display an inverse solubility curve manifested by progressive transition of calcium and manganese from the colloidal state to the ionic state. However, the solubility of the salts of sodium and potassium increases with the rise in processing temperature.

*pH:* The pH plays a critical role in determining the heat stability of milk. The pH effects both the molecular disassociation of casein components and the formation of aggregated protein complexes through protein–protein interactions. Further, pH strongly affects the salt equilibrium between the colloidal and ionic states of the minerals of milk. Maximum heat stability is observed between pH 6.6–6.8.

*Concentration of milk solids:* In general, the heat stability of milk decreases progressively as milk is concentrated to higher levels of total solids. This is accompanied by concomitant shift of salt from the ionic state to the colloidal state as well as drop in the pH values.

*Homogenization:* Although fat itself does not affect heat stability of milk, homogenization of milk brings about certain significant changes in the physical equilibria of milk. During homogenization of milk, the original fat globule is disrupted and surface area increases by many folds. Resurfacing of the newly formed fat globules takes place instantly, predominantly by the adsorption of micellar casein. A shift in the colloidal state because of the adsorption of caseins affects the equilibria between the colloidal and ionic states, which ultimately reduces the heat stability, although only marginally.

## DENSITY AND SPECIFIC GRAVITY

The density of milk (mass/volume) is the sum total of the densities of its constituents, their concentration, and state at a particular temperature. The density of milk is a useful parameter to convert volumetric measurements to gravimetric measurements and *vice versa*. Milk is purchased on weight basis and is sold in volumetric packages. Yogurt is sold in avoidupois/weight units, while fermented milks are packaged in volumetric units. Most of the dairy plants process milk and other products in gallons, a volumetric measure. Density is also useful in estimating degree of concentration during condensed milk manufacture by a simple hydrometer reading.

Milk density at 20°C ranges from 1.027 to 1.033 with an average of 1.030 g/cm<sup>-3</sup>. Accordingly, the weight of 1 liter of milk would range from 1.027 to 1.033 kg. The density of milk at 15.5°C can be estimated according to the following formula (Otter, 2003):

$$d_{15.5^{\circ}\text{C}} = \frac{100}{F/0.93 + \text{SNF}/1.608 + \text{Water } \%} \text{ g/cm}^{-3} \quad (2.4)$$

Here,  $d$  represents density,  $F = \% \text{ fat}$ ,  $\text{SNF} = \% \text{ solids-not-fat}$ , and  $\text{Water } \% = 100 - F - \text{SNF}$ .

The densities of some fluid milk products are given in Table 2.19.

The *specific gravity* of milk is the ratio of density of milk to that of water at a given temperature. Yogurt mix and other dairy mixes containing sugar and added milk solids exhibit higher densities and specific gravities than milk. For instance, the specific gravity of ice cream mix is in the range 1.0544–1.1232, while that of fresh whole milk lies in the range 1.030–1.035, with an average of 1.032. Milk fat, MSNF, skim milk, and evaporated whole milk, at 15.5°C, have specific gravity of 0.93, 1.614, 1.036,

and 1.066, respectively. The specific gravity of milk is influenced by the proportion of its constituents, each of which has a different specific gravity approximately, as follows: water, 1.000; fat, 0.930; protein, 1.346; lactose, 1.666; salts, 4.120; and SNF, 1.616. As the milk fat is the lightest constituent, the more there is of it, the lower the specific gravity will be and *vice versa*. Determination of the density of milk is carried out by first warming the milk to 40°C to allow melting of fat and then adjusting the temperature down to the desired working temperature.

The percentage of total solids or SNF in milk can be roughly estimated by the following formula:

$$\% \text{TS} = 0.25D + 1.22F + 0.72$$

$$\% \text{SNF} = 0.25D + 0.22F + 0.72$$

where  $D = 1000(d - 1)$  is the density of sample of milk at 20°C and  $F$  is the fat percentage of sample.

The empirical formulas given above lack the accuracy of laboratory analysis but in field conditions are useful as quick estimates.

## VISCOSITY

The viscosity of milk and cream creates the impression of “richness” to the consumer. From an organoleptic standpoint, viscosity contributes to mouth feel and flavor release. Fluidity is the inverse of viscosity. It has a bearing on fat separation/creaming, rate of heat transfer, and flow conditions during processing of milk. Assuming laminar flow with parallel stream lines, viscosity may be defined as the ratio of shearing stress (force per unit area) to shear rate (velocity difference divided by distance, in reciprocal seconds). In dairy industry, the common units are centipoise (cP) or (poise  $\times 10^{-2}$ ).

Viscosity of milk and dairy products depends on the temperature and on concentration and state of

**Table 2.19.** Density of Fluid Milk Products at Various Temperatures

Product	Density (kg/cm <sup>3</sup> ) at Various Temperatures			
	4.4°C	10°C	20°C	38.9°C
Raw milk, 4% fat	1.035	1.033	1.030	1.023
Homogenized milk, 3.6% fat	1.033	1.032	1.029	1.022
Skim milk, 8.9% SNF	1.036	1.035	1.033	1.0026
Half and half, 12.25% fat	1.027	1.025	1.020	1.010
Light cream, 20% fat	1.021	1.018	1.012	1.000
Whipping cream, 36.6% fat	1.008	1.005	0.994	0.978

Source: Adapted from Goff and Hill, 1993.

casein micelles and fat globules. Representative values at 20°C for various products are as follows: whole milk, 1.9 cP; skim milk, 1.5 cP; and whey, 1.2 cP. Viscosity of milk and cream increases with homogenization and the increase is proportional to the homogenization pressure. Increase in viscosity can be attributed to the fine state of fat globules and the formation of a coat of plasma proteins on them.

The casein micelles of milk contribute more to the viscosity of milk than does any other constituent. Viscosity varies not only with changes in physical nature of fat but also with the hydration of proteins. Alterations in the size of any dispersed constituents result in viscosity changes. The fat contributes less than caseins but more than whey proteins. When fat globules are greatly subdivided by homogenization, an increase in viscosity is observed. The viscosity of skim milk decreases on heating to 62°C after which it increases apparently because of changes in protein hydration. An increase in temperature causes a marked reduction in viscosity. For example at 20°C, milk is about half as viscous as at 0°C, and at 40°C, is approximately one third of the value at 0°C.

Viscosity is critical in the texture development of yogurt and cultured milks. It is a crucial attribute in defining mouth feel, flavor release, and refreshing quality of the product. It forms an important parameter in quality control programs of culture dairy plants. In yogurt, the viscosity is of the order of 15,000–25,000 cP.

## **SURFACE ACTIVITY**

Surface activity is involved in adsorption phenomena and the formation and stability of emulsions. It is relevant to creaming, fat globule membrane function, foaming, and emulsifier use in dairy products. Normal cow milk has an inherent surface activity. Its surface tension approximates 70% of that of water (72 dynes/cm). The surface tension of cow whole milk ranges from 50 to 52 dynes/cm, and for skim milk, 55–60 dynes/cm at 20°C. For cream it is approximately 46–47 dynes/cm. Casein, along with the proteolysis products protease–peptones, is largely responsible for the surface activity. Whey proteins make little contribution. Fat reduces surface tension by a physical effect. Lactose and most of the salts tend to raise it when they are present in true solution.

Surface tension decreases as milk temperature rises. Processing treatments such as heating, sterilization, homogenization, and shear tend to increase surface tension. However, homogenization of

imperfectly pasteurized milk or contamination of homogenized pasteurized milk with raw milk causes partial hydrolysis of milk fat, resulting in low surface tension, bitter flavor, and rancidity of milk.

## **Foaming**

Milk and milk products high in milk fat and/or milk proteins interact frequently with air and form foams. Sometimes the process is desirable as in whipping of cream and sometimes it has a nuisance value as in handling of skim milk. Fat globules and free fat make foam less stable. Heating of milk to such an extent that whey proteins are denatured yields more voluminous and more stable foam on heating. However, sterilization diminishes its foaming capacity. A concentrate of 30% total milk solids that has been vigorously homogenized forms very stable foam.

Foaming of milk is minimum at 30–35°C. At 60°C, the foam volume is independent of the fat content. Below 20°C and above 30°C, the foaming tendency appears to increase. Fat tends to stabilize the foam formed below 20°C, for instance, during churning for butter production. Skim milk produces slightly more stable foam above 30°C than does whole milk or light cream.

The formation of stable foam depends upon two main factors. First, the lowering of the surface tension allows the gathering and spreading of the surface-active components into thin films. Second, the films must be sufficiently elastic and stable to prevent the coalescence of the gas cells. Stable foam is thus formed when the surface tension of the liquid is not great enough to withdraw the film from between the gas cells and when the stabilizing agent has great internal viscosity.

Foaming properties affect handling of milk products and how dairy-based ingredients are used in other products. Foam formation and its stability constitute important factors in getting the necessary overrun and texture in frozen dairy desserts, including frozen yogurt and whipped yogurt. Many yogurt plants use antifoaming agents as processing aid to control foam formation during the preparation of yogurt mix. Foam control is also necessary from a proper pasteurization standpoint because organisms suspended in foam are resistant to common heat pasteurization time–temperature regime.

## **CURD TENSION**

This property is considered important in relation to the cheese making characteristics as well as the

digestibility of milk. The curd tension of milk is 28–54 g. Heat treatment of milk causes a reduction of curd tension, as does the homogenization treatment. Addition of some of the salts such as the sodium citrate and sodium hexametaphosphate tend to reduce the curd tension of milk.

## COLLIGATIVE PROPERTIES

### Osmotic Pressure

The number of molecules or particles, not the weight of solute, control osmotic pressure; thus 100 molecules of size 10 will have 10 times the osmotic pressure of 10 molecules of size 100. It follows that for a given weight, the smaller the molecules, the higher the osmotic pressure.

Milk is formed from blood, the two being separated by a permeable membrane; hence they have the same osmotic pressure. In other words, milk is isotonic with blood. The osmotic pressure of blood is remarkably constant although the composition, as far as pigment, protein, etc. are concerned, may vary. The osmotic pressure is basically a function of salt balance and lactose content of milk.

### Freezing Point

Pure water freezes at 0°C. Milk freezes at a temperature slightly lower than water because of the presence of soluble constituents such as lactose and soluble salts. The freezing point of milk depends on molar concentration of its soluble, low molecular weight compounds. Lactose, potassium, sodium, and chloride are the principal milk constituents responsible for 75–80% of the entire freezing point depression (FPD). Since it is a fairly constant property of milk, it is routinely used for detecting adulteration of incoming milk with water, using a cryoscope. Adulteration of milk with water lowers the molal concentration of lactose and salts, and thus increases the freezing point. Earlier work was done with the Hortvet cryoscope using a mercury-in-glass thermometer and results on freezing point were based on the Hortvet scale. More recent work with thermistor measuring devices has shown that the Celsius and Hortvet scales are not identical. The following relationship has been reported (Harding, 1995):

$$^{\circ}\text{C} = 0.96418^{\circ}\text{H} + 0.00085$$

$$^{\circ}\text{H} = 1.03711^{\circ}\text{C} - 0.00085$$

Accordingly,  $-0.540^{\circ}\text{H}$  is actually  $-0.521^{\circ}\text{C}$ . Most of the industry data is reported in  $^{\circ}\text{H}$ . Freezing point

is expressed in negative numbers whereas FPD is the positive version of freezing point. Accordingly, freezing point depression of  $0.540^{\circ}\text{H}$  is equivalent to freezing point of  $-0.540^{\circ}\text{H}$ . On adulteration with water, zero degree being the reference point, FPD decreases, while freezing point registers an increase. Milks from individual cows show a narrow range in their FPD ( $0.530$ – $0.525$ ), but pooled milk has average of  $0.543^{\circ}\text{H}$ . It is generally agreed that milk of FPD higher than  $0.535^{\circ}\text{H}$  may be presumed to be water-free. But readings between  $0.530^{\circ}\text{H}$  and  $0.534^{\circ}\text{H}$  warrant a letter to the suppliers for a check on their plant operation. When FPD readings are between  $0.525^{\circ}\text{H}$  and  $0.529^{\circ}\text{H}$ , there is a strong suspicion of added water to the milk. Any time, if the reading is  $0.525^{\circ}\text{H}$  or less, assumption of extraneous water in milk is justified.

We will now illustrate how the freezing point method detects the adulteration of milk with extraneous water. Let us assume milk with no added water freezes at  $-0.540^{\circ}\text{C}$ . When 10% water is added, its freezing point should be in the range of  $-0.478^{\circ}\text{C}$ . In general, the percentage of added water is calculated as follows:

$$\% \text{ added water} = \frac{0.540 - \text{FPD}}{0.540} \times (100 - \text{total milk solids}) \quad (2.5)$$

As little as 3% water added to milk can be detected by this method. Fermented milks show significant increase in FPD because of the conversion of lactose to lactic acid and the transformation of minerals to the ionic form. The freezing point of cream, skim milk, and whey are identical with that of the milk from which they are prepared. Therefore, the freezing point test does not detect the addition of skim milk or removal of fat from milk samples. Moreover, watered milk, which has soured, may pass the test because souring results in increase of the FPD as a result of an increase in the amount of soluble molecules. Hence, the freezing point should be determined in fresh samples (having no developed acidity) for greatest accuracy.

### Boiling Point

A solution boils at a higher temperature than does the pure solvent, according to the concentration of the dissolved substance. The milk constituents in true solution are mainly responsible for the elevation of the boiling point above  $100^{\circ}\text{C}$ . Elevation of the boiling point is based on the same principles as the depression

of freezing point. However, for detecting added water, the freezing point method is far superior on the grounds of accuracy and convenience. The boiling point of milk is 100.17°C.

## REFERENCES

- Fox PF, McSweeney PLH. 1998. Dairy Chemistry and Biochemistry. Blackie Academic and Professional, New York, p. 95.
- Goff HD, Hill AR. 1993. Chemistry and physics. In: YH Hui (Ed), Dairy Science and Technology Handbook, Vol. 1: Principles and Properties. VCH Publishers, New York, pp. 1–62.
- Harding F. 1995. Adulteration of milk. In: Milk Quality. Blackie Academic and Professional, New York, pp. 60–67.
- Henson AF, Holdsworth G, Chandan RC. 1971. Physico-chemical analysis of the bovine milk fat globule membrane. *J. Dairy Sci.*, 54:1752–1763.
- Jensen RG (Ed). 1995. Handbook of Milk Composition. Academic Press, New York.
- McCarthy, DJ. 2003. Milk: Physical and physics. Chemical properties. In: H. Roginski, JW Fuquay, PF Fox (Eds). *Encyclopedia of Dairy Sciences*. Academic Press, New York, pp. 1812–1821.

- Otter D. 2003. Milk: Physical and chemical properties. In: B Cabellero, LC Trugo, PM Finglas (Eds), *Encyclopedia of Food Sciences and Nutrition*, 2nd ed. Academic Press, New York, pp. 3957–3963.
- Swaigood HE. 1996. Characteristics of milk. In: O. Fennema (Ed), *Food Chemistry*. Marcel Dekker, New York, pp. 841–878.
- Walstra P, Geurts TJ, Noomen A, Jellema A, van Boekel MAJS. 1999. *Dairy Technology: Principles of Milk, Properties and Processes*. Marcel Dekker, New York.
- Wong NP, Jenness R, Keeney M, Marth EH (Eds). 1988. *Fundamentals of Dairy Chemistry*. Van Nostrand Reinhold, New York.

## BIBLIOGRAPHY

- Bylund G. 1995. *Dairy Processing Handbook*. Tetra Pak Processing System, Lund.
- Chandan R. 1997. *Dairy-Based Ingredients*. Eagan Press, St. Paul, MN, p. 5.
- Fox PF. 2003. The major constituents of milk. In: G Smit (Ed), *Dairy Processing. Improving Quality*. CRC Press, Boca Raton, FL, pp. 6–41.
- Spreer E. 1998. *Milk and Dairy Product Technology*. Marcel Dekker, New York, p. 21.

# 3

## Regulatory Requirements for Milk Production, Transportation, and Processing

*Cary P. Frye*

History of Milk Safety  
United States Public Health Grade “A” Milk Safety Program  
    Inspection of Milk Safety  
    Farm Requirements  
    Milk Transportation  
    Processing Plant  
    HACCP  
    Standards and Regulations  
Imports  
Equipments Standards  
    The 3-A Sanitary Standards Symbol  
Milk Pricing—U.S. Federal Milk Marketing Orders  
    Background of Federal Orders  
    Classified Pricing  
    Producer Prices  
    Milk Pricing for Fermented Milk Products  
Glossary  
References

### **HISTORY OF MILK SAFETY**

Milk, the primary ingredient used for yogurt and fermented milk products, is rich in nutrients but also has the properties to readily support microbial growth and potentially pathogenic organisms. Milk cows on the farm are exposed to many sources of potential contamination. Some of these may be the water, feed sources, exposure to manure, insects, contact with diseased animals in housing or corral areas, injuries to the udder, and poor milking practices.

Early studies implicate milk as the carrier for many communicable diseases to the consumer. Some of the most notable outbreaks were tuberculosis, brucellosis, salmonellosis, diphtheria, scarlet fever, septic sore throat, and dysenteries of the food infection type. Recent outbreaks of salmonellosis, listeriosis, yersinia, and campylobacter have been responsible

for milk-related human illness. *Coxiella burnetti* was also noted as one of the pathogens responsible for milk-borne outbreaks of Q fever and the imposition of more stringent pasteurization requirements (US-DHHS PMO, 2003).

The incidence of milk-borne illness in the United States has been sharply reduced. In 1938, milk-borne outbreaks constituted 25% of all disease outbreaks, because of infected foods and contaminated water. Recent information reveals that milk and fluid milk products continue to be associated with less than 1% of such reported outbreaks. Many groups have contributed to this commendable achievement, including public health and agricultural agencies, dairy and related industries, several interested professional groups, educational institutions, and the consuming public.

The responsibility for insuring the ready availability and safe supply of milk and milk products, including yogurt and fermented milks, is the cooperative effort of all engaged, including government regulators and the industry.

### **UNITED STATES PUBLIC HEALTH GRADE “A” MILK SAFETY PROGRAM**

The U.S. Public Health Service (USPHS) branch of FDA is a division of the Federal Health and Human Services under the Food and Drug Administration (FDA), which has broad authority of overseeing the health and safety of food. USPHS oversight began at the turn of the century with studies on the role that milk plays in the spread of diseases. The findings indicated that effective public health control of milk-borne disease requires the application of sanitation



measures throughout the production, handling, pasteurization, and distribution of milk and milk products. These studies were followed by research to identify and evaluate sanitary measures that might be used to control milk-borne disease, including studies that led to the improvement of the pasteurization process.

To assist states and municipalities in initiating and maintaining effective programs for the prevention of milk-borne disease, the USPHS developed a model regulation known as the *Standard Milk Ordinance* for voluntary adoption by State and Local Milk Control Agencies in 1924. An accompanying *Code* was published in 1927 to provide a uniform interpretation of this *Ordinance* and to establish administrative and technical details as to satisfactory compliance. This model milk regulation is still used today, though now titled the *Grade "A" Pasteurized Milk Ordinance* (Grade "A" PMO), 2003 Revision. This regulation incorporates the provisions governing the processing, packaging, and sale of Grade "A" milk and milk products, including yogurt, fermented milk products, whey, whey products, and condensed and dry milk products. The 25th revision of the Grade "A" PMO incorporates new knowledge into public health practices.

The USPHS alone did not produce the Grade "A" PMO. As with preceding editions, it was developed with the assistance of Milk Regulatory and Rating Agencies at every level of federal, state, and local governments. All segments of the dairy industry, including health and agriculture regulators, producers, milk plant operators, equipment manufacturers, associations, and educational and research institutions assisted in producing the Grade "A" PMO.

The Grade "A" PMO is the basic standard used in the voluntary Cooperative State-USPHS Program for the Conference of Interstate Milk Shipments, a program participated in by all 50 states, the District of Columbia, and the U.S. Trust Territories. The National Conference on Interstate Milk Shipments (NCIMS), in accordance with the "Memorandum of Understanding" with the FDA, recommends changes and modifications to the Grade "A" PMO at its biennial conferences.

The Grade "A" PMO is incorporated by reference in Federal specifications for procurement of milk and milk products. It is used as the sanitary regulation for milk and milk products served on interstate carriers and is recognized by the Public Health Agencies, the milk industry, and many others as the national standard for milk sanitation.

The USPHS has legal jurisdiction for the enforcement of milk sanitation standards, in the case of interstate commerce. It also serves in an advisory and simulative capacity and is designed primarily to assist state and local regulatory agencies.

## INSPECTION OF MILK SAFETY

State and local regulatory agencies are responsible for the enforcement of sanitation requirements on dairy farms, in milk hauling receiving and transfer stations, and in processing plants. The FDA's primary function under the Federal/State Milk Safety Cooperative Program is to provide technical assistance to the states in the implementation and enforcement of their regulations. This assistance is provided through district and regional milk specialists and the Center for Food Safety and Nutrition's (CFSAN) Milk Safety Team. The inspection program is carried out by the state regulatory agency under the requirements of the Cooperative Program of the National Conference on Interstate Milk Shipments (NCIMS). As a result, there is a greater degree of reciprocity between states on acceptance of inspections. The NCIMS *Procedures* document contains information for establishing milk sanitation standards, rating procedures, sampling procedures, laboratory evaluation, and sample collector procedures (USDHHS Procedures, 2003).

The *Procedures* requires that producer farms and processing facilities are inspected by the state regulatory agencies on a routine basis at a minimum of twice a year, with many state regulatory agencies inspecting on a four-per-year schedule. These farms and dairy plants are also inspected under the Interstate Milk Shipper (IMS) Program to determine the "rating" of all plants electing to participate in the IMS program. State or local ratings must be conducted by a certified USPHS representative. These ratings are conducted no less than once every 24 months (but no more than 15 days) and are based on compliance with the Grade "A" PMO requirements. The ratings provide an assessment of state and local sanitarians' activities regarding public health control and milk quality control. Rating inspections are expressed in terms of percentage compliance. For example, if the milk plant and dairy farms comply with all requirements of the Grade "A" PMO, the Sanitation Compliance Rating of the pasteurized milk supply would be 100%. However, if the plant of some of the dairy farms fails to satisfy one or more of these requirements, the Sanitation Compliance Rating would

be reduced in proportion to the amount of milk and milk products involved in the violation, and to the relative public health significance of the violated item(s).

Additionally, the USPHS is obligated to conduct periodic “check ratings” to assure validity and uniformity with each state’s ratings (USDHHS Methods, 2003).

## FARM REQUIREMENTS

The Grade “A” PMO sections on raw milk established the requirements and standards for milk production and farm conditions. These require that milking animals are disease-free and do not show signs of secretion of abnormal milk such as blood or mastitis. Milk from cows that have been treated with medications or antibiotics must be properly separated. The milking barn, stable, or parlor must be properly constructed with floors that are concrete or impervious so as to easily maintain cleanliness. Walls and ceilings should be smooth, painted, or finished, making it dust-tight in order to reduce the likelihood of dust and extraneous material from getting into the milk. There must be sufficient light during the day and night, as well as good air circulation to prevent condensation and excess odors.

Milking barns must be kept clean and the cow yard should be graded for proper drainage to prevent standing water or excess accumulation of organic waste. The milk house should be of sufficient size and provide proper cooling, handling, and storage of milk. It should include proper facilities to wash, sanitize, and store milk containers and utensils. Milk houses must have tight-fitting doors to the milking barn and water that is piped under pressure, with an adequate supply of hot water. The milk cooling must be monitored by accurate accessible temperature recording devices installed in the milk line, and milk must be cooled to below 7°C (45°F). The milk house must be kept clean to reduce the likelihood of contamination of the milk. Every dairy farm should have at least one conveniently located toilet. Water for the milk house must be from a supply properly located and protected to provide safe and sanitary water quality.

Milking equipment and utensils for handling and storage of milk on the farm must be made of smooth, nonabsorbent, corrosion-resistant, and nontoxic material and must be constructed in such a way so that they can be easily cleaned. Multiuse woven mate-

rial is not allowed for straining milk. Strainers, if used, must be of a perforated design or constructed to utilize a single-use strainer media such as paper or cloth. Details for plans of mechanically cleaned milk pipeline systems must be submitted to the state regulatory agency for written approval prior to installation.

Utensils and equipment used for milk handling, storage, or transportation must be cleaned after each use, sanitized before reusing, and stored to assure complete drainage and protection from contamination. Additionally, effective measures must be in place to prevent contamination by insects, rodents, and the chemicals used to control these pests.

Milking must be done in the milking barn, stable, or parlor. The cows’ flanks, udders, bellies, and tails must be free from visible dirt. Udders and teats should be cleaned and dried before milking. Teats should be treated with a sanitizing solution just prior to the time of milking and dried before milking. However, alternative udder preparation methods may be allowed once they are evaluated and approved by the FDA.

Milking house operations, equipment, and facilities should be conducted to prevent any contamination of milk, equipment, containers, or utensils. Vehicles used to transport the milk from the dairy farm to the milk plant, receiving station, or transfer station should be constructed in such a way so as to protect the milk from sunlight, freezing, and contamination. Cleaners and sanitizers used on the farm should be properly identified. Animal drugs must be properly labeled and segregated for their use on nonlactating animals. Unapproved drugs should not be used. Personal cleanliness of the farm employees is important, and therefore hand-washing facilities must be provided.

Furthermore, the dairy farm is responsible for assuring that the raw milk for pasteurization is cooled to 10°C (50°F) or less within 4 hours or less of the commencement of the first milking, and to 7°C (45°F) or less within 2 hours after the completion of milking provided that the blend temperature after the first milking and subsequent milking does not exceed 10°C (50°F).

## MILK TRANSPORTATION

The sanitary requirements for transportation of raw milk from the farms to the processing plant are also detailed in the Grade “A” PMO. These policies may be found under the sections on raw milk and

regulations pertaining to raw milk receiving stations and transfer stations.

Milk is collected and stored at the farms in a cooled bulk tank and then picked up daily or every other day by bulk milk transportation trucks. These trucks must be made of smooth, nonabsorbent, corrosion-resistant, nontoxic, material that can be easily cleaned, and constructed in a way to protect the milk from dust or airborne contamination.

The bulk milk hauler is often responsible for collecting official milk samples as well as transporting raw milk from a farm to a receiving station, transfer station, or a milk processing plant. The bulk milk hauler is required to have training and pass an examination with a score of 70% or greater related to sanitation, sampling, and weighing procedures, including proper use and cleaning of equipment, and record-keeping requirements. The bulk milk hauler is issued a permit upon successful completion of the examination. The state regulatory agency must observe the techniques of the bulk milk hauler at one or more farms every 24 months for the permit to remain valid.

Bulk milk tank trucks are also permitted and inspected by the state regulatory agency annually. If construction or repair defects are noted, the milk tank truck must be removed for service until repairs and sufficient cleaning are verified. The milk tank truck standards encompass the following areas: properly constructed equipment to hold milk at correct temperatures of 7°C (45°F) or less, adequate milk sampling equipment, and a tag affixed to the truck's outlet valve to verify washing and sanitizing records. When bulk milk haulers are responsible for obtaining and transporting milk samples for official laboratory analysis, they must complete records verifying the chain-of-custody for the samples.

Bulk raw milk from farms may be transported directly to the milk or yogurt processing plants or it may be held at a transfer station where it is pooled with other raw bulk milk loads. The transfer station unloads smaller bulk milk trucks into holding silos and then reloads the commingled raw milk into larger over-the-road tanker trucks for delivery to processing plants.

All vehicles and milk tank trucks containing milk or milk products should be legibly marked with the name and address of the milk plant or hauler in possession of the contents.

Milk tank trucks transporting raw, heat-treated, or pasteurized milk and milk products to a milk plant from another milk plant, receiving station, or transfer

station are required to be marked with the name and address of the milk plant or hauler and should be sealed. Additionally, a statement should be prepared for each shipment containing at least the following information:

- Shipper's name, address, and permit number.  
Each milk tank truck containing milk should include the IMS Bulk Tank Unit (BTU) identification number(s) or the IMS Listed Milk Plant Number (for farm groups listed with a milk plant) on the weight ticket or manifest
- Permit identification of hauler, if not an employee of the shipper
- Point of origin of shipment
- Tanker identification number
- Name of product
- Weight of product
- Temperature of product when loaded
- Date of shipment
- Name of supervising regulatory agency at the point of origin of shipment
- Whether the contents are raw or pasteurized, or in the case of cream, low-fat, or skim milk, whether it has been heat-treated
- Seal number on inlet, outlet, wash connections, and vents
- Grade of product

## PROCESSING PLANT

Manufacturing plants that process yogurt and fermented milk products are subject to the food safety requirements in the Grade "A" PMO section on Standards for Grade "A" pasteurized, ultra-pasteurized, and aseptically processed milk and milk products. These requirements dictate the construction of floors, walls, ceilings, doors, and windows as well as proper lighting and ventilation. Floors in all rooms of the processing facility where milk products are handled, processed, and sorted or in which milk containers, utensils, and equipment are washed must be constructed of concrete or other equally impervious and easily cleanable material. The floor must be properly sloped with trapped drains. Storage rooms for dry ingredients need not have drains and may have floors constructed of wood. Walls and ceilings should be smooth, light-colored, washable, and in good repair. Doors and windows should prevent access to insects and rodents and all openings to the outside must have solid doors or glazed windows. However, other methods of effectively protecting openings to the outer air

such as screening, fans, air curtains, and properly constructed flaps may be used provided the entrance of insects and rodents are prevented.

The processing plant must be designed so that separate rooms are provided for each of the following operations:

- The pasteurizing, processing, cooling, reconstitution, condensing, drying, and packaging of milk and milk products.
- Packaging of dry milk or milk products.
- The cleaning of milk cans, containers, bottles, cases, and dry milk or milk product containers.
- The fabrication of containers and closures for milk and milk products.
- Cleaning and sanitizing facilities for milk tank trucks in milk plants receiving milk or whey.
- Receiving cans of milk and milk products in milk plants receiving such cans.

Every milk processing plant should have toilet and hand-washing facilities with hot and cold running water, soap, and individual sanitary towels or approved hand-drying devices. The water supply must be adequate, safe, and of sanitary quality. The water supply may be approved as safe from the State Water Control Authority, or in the case of individual water systems (wells), comply with construction specifications and bacteriological standards.

The processing facility should be kept clean, neat, and free of evidence of insects and rodents in order to reduce the likelihood of contamination of the milk or milk products. All piping, floors, walls, ceilings, fans, shelves, tables, and nonproduct contact surfaces should be clean. Trash and solid waste must be kept in covered containers.

All sanitary piping, fittings, connections, multiuse containers, and equipment that come in contact with milk and milk products should be smooth, impervious, corrosion-resistant, nontoxic, and easily cleanable material that is approved for food contact surfaces. All sanitary piping, connections, and fittings must meet the following requirements:

- They must be made from either of the following:
  - a. Stainless steel of the AISI 300 series
  - b. Equally corrosion-resistant metal that is nontoxic and nonabsorbent
  - c. Heat-resistant glass
  - d. Plastic or rubber and rubber-like materials that are relatively inert and resistant to scratching, scoring, decomposition, crazing, chipping, and

distortion under normal use conditions; must be nontoxic, fat-resistant, relatively nonabsorbent, not impart flavor or odor to the milk or milk products, and maintain their original properties under repeated use conditions

- They must be designed to permit easy cleaning, maintained in good repair, free of breaks or corrosion, and must contain no dead ends of piping in which milk or milk products may collect.

Equipment, containers, and utensils should have joints that are flush and have a smooth finish. All openings to tanks, vats, and separators are protected by raised edges to prevent the entrance of surface drainage and thus condensation-diverting aprons should be provided. There must not be threaded fittings in milk contact areas. Strainers, if used, should be of a perforated design or constructed to utilize a single-use strainer media, such as cloth or paper. Woven material may be used only where it is impractical to use perforated strainers. However, woven strainers must be thoroughly mechanically cleaned.

All single-service containers, closures, gaskets, and other articles that contact milk must be nontoxic and should be manufactured, packaged, transported, and handled in a sanitary manner and may not be reused.

One of the most critical food safety procedures is proper cleaning and sanitation of containers and equipment that are used for processing, culturing, filling, packaging, and storage of milk and fermented milk products. All multiuse containers and utensils such as tanks, lines, vessels, pasteurizers, and filling equipment must be cleaned at least once a day. Storage tanks should be cleaned when emptied at least every 72 hours and records must be readily available to verify storage times. Cleaning frequencies beyond these requirements are allowed after review and acceptance of specific information by the state regulatory agency in consultation with FDA. Pipelines and equipment designed for mechanical cleaning (cleaning-in-place [CIP]) must meet specific requirements of being equipped with a temperature recording device that provides a continuous record of the time and temperature, cleaning solution velocity, and the presence, strength, or cleaning solution chemicals. For manual washing there must be a two-compartment wash-and-rinse vat. After cleaning, milk product containers, utensils, and equipment should be stored to assure complete drainage and protection from contamination.

Single-service caps, cap stock, containers, gaskets, and other articles for use in direct contact with milk and milk products must be stored in sanitary wrapping or cartons and kept in a clean, dry place until used. This category also includes the containers and lids used for yogurt and fermented milk packages.

Throughout the milk processing plant, ingredients in process product, packaging, and finished products must be protected from contamination. This includes discarding spilled, overflowed, or leaked milk and milk products. All poisonous or toxic materials should be properly labeled and stored in a separate area and used to preclude contamination. All product contact surfaces must be covered or otherwise protected to prevent the exposure to insect, dust, condensation, and other contamination. Many openings, including valves, piping attached to milk storage, milk tank trucks, pumps, and vats should be capped or properly protected. Air must be free of oil, rust, excessive moisture, extraneous materials, and odor when air pressure is used for agitation or the movement of milk. The use of steam in contact with milk requires it to be of culinary quality.

During processing, pipelines and equipment used to contain or conduct milk and milk products should be effectively separated from tanks or circuits containing cleaning and/or sanitizing solutions. This can be accomplished by physically disconnecting all connection points, by separation with two automatically controlled valves or by a single-bodied double seat valve, with a drainable opening between tanks and circuits containing cleaning and/or sanitizing solutions from pipelines and equipment used for milk or milk products. Additionally, there should be no physical connection between water, nondairy products, unpasteurized dairy product, with pasteurized milk and milk products.

Pasteurization is the only practical, commercial measure that, if properly applied to all milk, will destroy all milk-borne disease organisms. It has been demonstrated that the time–temperature combinations specified by this Grade “A” PMO, if applied to every particle of milk or milk products, will kill all milk-borne pathogens. Although pasteurization destroys the organisms, it does not destroy the toxins that may be formed in milk and milk products when certain staphylococci bacteria are present. Staph toxin can result from udder infections and when the milk or milk products are not properly refrigerated before pasteurization. Such toxins may cause severe illness. The temperature requirements for milk pasteurization are given in Tables 3.1 and 3.2.

**Table 3.1.** Pasteurization Temperature vs. Time

Temperature	Time
63°C (145°F) <sup>a</sup>	30 minutes
72°C (161°F) <sup>a</sup>	15 seconds
89°C (191°F)	1.0 second
90°C (194°F)	0.5 seconds
94°C (201°F)	0.1 seconds
96°C (204°F)	0.05 seconds
100°C (212°F)	0.01 seconds

<sup>a</sup>If the fat content of the milk product is 10% or more, or if it contains added sweeteners, or is concentrated (condensed), the specified temperature shall be increased by 3°C (5°F).

Detailed information about the design, installation, and operation of the milk pasteurizing equipment is also dictated by the Grade “A” PMO. The overseeing regulatory agency performs specific tests on the pasteurizer’s critical instruments and devices upon initial installation and at least once every 3 months, and then applies seals to specific equipment that regulate the temperature or flow rate. All temperature and flow rate pasteurization records are required to be preserved for a period of 3 years.

Maintaining milk at proper temperatures to avoid bacterial growth and spoilage is critical to product quality and safety. All raw milk and milk products should be maintained at 7°C (45°F) or less until processed. All pasteurized milk and milk products, except those to be cultured, should be cooled immediately prior to filling or packaging in an approved equipment, at a temperature of 7°C (45°F). This exemption for higher temperature during culturing has also been applied to fermentation that occurs in the final package, such as cup-set yogurt. All pasteurized milk and milk products should be stored at a temperature of 7°C (45°F) or less until further processed. To verify proper refrigeration, every refrigerated room or tank in which milk or milk products are stored should be equipped with an accurate indicating thermometer. On delivery vehicles, the temperature of milk and milk products should not exceed 7°C (45°F). However, aseptically processed milk and milk

**Table 3.2.** Eggnog Pasteurization Temperature vs. Time

Temperature	Time
69°C (155°F)	30 minutes
80°C (175°F)	25 seconds
83°C (180°F)	15 seconds

products to be packaged in hermetically sealed containers are exempt from these cooling requirements.

Filling, packaging, and capping of pasteurized milk products must be done at the place of pasteurization in a sanitary manner by approved mechanical equipment. The packaging equipment and supply lines must be equipped with covers to prevent contamination from reaching the inside of the filler bowl and drip deflectors must be designed to divert condensation away from open containers. Container in-feed conveyors to automatic bottling or packaging machines should have overhead shields to protect the bottles or packaging from contamination. Caps and closures must be applied in a manner where they cannot be removed without detection, help to provide assurance to the consumer that the milk and milk products have not been contaminated after packaging. All packaging must be handled in a sanitary manner.

Employees working in the milk processing plant must maintain a high degree of personal cleanliness. Hands must be thoroughly washed before commencing plant functions or resuming work after visiting the toilet, eating, or smoking. Employees must wear clean outer garments and adequate hair coverings. No persons affected with any disease capable of being transmitted to others through the contamination of food are not allowed to work at a milk plant in any capacity that brings them into direct contact with pasteurized milk or aseptically processed milk or milk product contact surfaces.

All vehicles used to transport pasteurized milk and milk products should be constructed and operated in such a way so that the milk and milk products are maintained at 7°C (45°F) or less and are protected from contamination. Milk tank cars, milk tank trucks, and portable shipping bins should not be used to transport or contain any substances that may be toxic or harmful to humans.

The surroundings of a milk plant should be kept neat and clean to prevent attracting rodents, flies, and other insects that may contaminate the milk or milk products. Insecticides and rodenticides must be approved for use in milk plants and used in accordance with label recommendations.

## **HACCP**

### **History of HACCP**

The use of the Hazard Analysis and Critical Control Point (HACCP) System is not new to the dairy industry. HACCP is a logical, simple, effective, and highly structured system of food safety control. The

HACCP System was introduced to the food industry as a spin-off of the space program during the 1960s. The National Aeronautics and Space Administration (NASA) used HACCP to provide assurance of the highest quality available for components of space vehicles. This program, to develop assurance of product reliability, was carried over into the development of foods for astronauts.

### **Background**

HACCP is a management tool that provides a structured and scientific approach to the control of identified hazards. HACCP is a logical basis for better decision making with respect to product safety. HACCP is internationally recognized as an effective means of controlling food safety hazards and is endorsed as such by the joint Food and Agriculture Organization (FAO) of the World Health Organization Codex Alimentarius Commission. The U.S. National Advisory Committee on Microbiological Criteria for Foods (NACMCF) has also endorsed it.

The HACCP concept enables those operating and regulating under an HACCP Plan to move to a preventive approach, whereby potential hazards are identified and controlled in the manufacturing environment, i.e., prevention of product failure. HACCP allows for a preventive systematic approach to food safety.

### **Voluntary Participation**

The NCIMS HACCP Program is a voluntary alternative to the traditional inspection system. Milk plants, receiving stations, or transfer stations can participate in the voluntary NCIMS HACCP Program only when the state regulatory agency responsible for the oversight of the facility agrees to participate with them in the program. Management responsible for both the state and dairy plants, receiving stations, or transfer stations must be willing to provide the resources needed to develop and implement a successful HACCP System. Both parties must provide written commitment to each other that the necessary resources to support participation in the NCIMS HACCP Program will be made available.

### **HACCP Principles**

Following are the seven HACCP principles to be included in an HACCP Plan:

- Conduct a hazard analysis
- Determine the critical control points

- Establish critical limits
- Establish monitoring procedures
- Establish corrective actions
- Establish verification procedures
- Establish record-keeping and documentation procedures

### Prerequisite Programs

Prior to the implementation of a HACCP Plan, there is a requirement for dairy plants, receiving stations, and transfer stations to develop, document, and implement written prerequisite programs (PPs). These provide the basic environment and operating conditions that are necessary for the production of safe, wholesome food. Many of the conditions and practices are specified in federal and state regulations and guidelines.

The seven principles of HACCP are also called the HACCP Plan. When combined with the PPs, they constitute an HACCP System. The NCIMS HACCP Program combines the HACCP System and other prescribed Grade “A” PMO criteria, such as drug residue testing and trace back, use of milk only from supplies that have been awarded a milk sanitation compliance rating of at least 90% or from an acceptable IMS HACCP listed source, and labeling requirements. When properly implemented, the HACCP Program will provide assurance of milk and milk product safety that is equivalent to that provided under the traditional inspection system.

## STANDARDS AND REGULATIONS

### Standards for Containers and Closures

Single-service containers and closures, such as plastic jugs, plastic-coated paperboard milk containers, plastic tubs, lids, and aluminum aerosol cans, are used by the dairy industry for packing milk and milk products. Industry-applied quality assurance controls for manufacturing and handling of the materials have made it possible for these products to reach the point of use in a sanitary condition free from toxic materials that may migrate into milk or milk products. Standards set forth in the Grade “A” PMO, Appendix J ensure the production of sanitary containers and closures for milk and milk products. The standards include the bacterial requirements, fabrication plant, equipment, processing, and packaging standards as well as materials, waxes, adhesives, sealants, and inks that can be used. Approval of certified single-service

containers and closures plants is published in the *Interstate Milk Shipper List* quarterly.

### Labeling

Labeling of bottles, containers, and packages containing milk or milk products such as yogurt and fermented milk are defined in applicable requirements of the Federal Food Drug and Cosmetic Act (FFDCA), the Nutrition Labeling and Education Act (NLEA) of 1990, and regulations developed there under the Federal Code of Regulations Title 21. More detailed information on FDA labeling regulations can be found in Chapter 4. However, in addition to federal requirements, the Grade “A” PMO requires additional labeling as follows:

All bottles, containers, and packages containing milk or milk products, except milk tank trucks, storage tanks, and cans of raw milk from individual dairy farms, should be conspicuously marked with the following:

1. The identity of the milk plant where the milk was pasteurized, ultra-pasteurized, aseptically processed, condensed, or dried. This may be accomplished by printing on the container the company name and its location (listing the city and state) or the unique identification number, which is the “IMS Listed Milk Plant Number,” assigned by the state to each plant.
2. The words “keep refrigerated after opening” in the case of aseptically processed milk and milk products.
3. The common name of the hooved mammal producing the milk should precede the name of the milk or milk product when the product is or is made from milk other than cow’s milk, for example, “Goat,” “Sheep,” “Water Buffalo,” or “Other Hooved Mammal” milk or milk products.
4. The words Grade “A” on the exterior surface. Acceptable locations should include the principal display panel, the secondary or informational panel, or the cap/cover. The term Grade “A” may not solely appear in the ingredient statement.
5. The word “reconstituted” or “recombined” if the product is made by milk subject to reconstitution, recombined milk, or milk ingredients.

All labeling terms must be truthful and not misleading as dictated by the FFDCA. Grade designations, such as Grade “AA” Pasteurized, Selected Grade “A” Pasteurized, Special Grade “A” Pasteurized, etc., give the consumer the impression

that such a grade is significantly safer than Grade “A.” Such an implication is false because the *Ordinance* requirements for Grade “A” pasteurized, ultra-pasteurized, or aseptically processed milk when properly enforced will ensure that this grade of milk will be as safe as milk can practically be made. Descriptive labeling terms must not be false and misleading and should not be used in conjunction with the Grade “A” designation or the name of the milk or milk product. If descriptive terms are used in conjunction with attributes of the product other than milk safety, i.e., “special select strawberries” for strawberry yogurt or “rich creamy texture,” these labeling terms should not be in a location immediately preceding or following the name of the food. Creating physical distance and employing graphic enhancements such as distinctive type styles, bursts, and other techniques generally are effective ways of distinguishing optional information from the required information (USDHHS PMO, 2003).

### Examination of Milk Products

In order to verify the quality and safety of the milk and milk products to the Grade “A” PMO, it is required that raw milk, commingled milk in the silos intended for processing, and finished products be sampled and tested by state regulatory agencies at a specific frequency. The products must meet chemical, bacteriological, and temperature standards, which are given in Table 3.3.

It is required that the state regulatory agency collect and test official samples of at least four times during any consecutive 6 months. However, many state regulatory agencies sample and test monthly. The samples must include each fat level and both plain and flavored products for finished milk and milk products. Therefore, if a plant produces plain low-fat yogurt, flavored low-fat yogurt, and flavored nonfat yogurt, all three products must be sampled. It is not necessary to sample each flavor monthly, but usually different flavors are chosen each time the product is sampled.

Testing of official samples must be done in laboratories that are certified under the Interstate Milk Shippers Program and by technicians that have been certified to perform the specific required tests. Requirements for laboratories are governed by the Evaluation of Milk Laboratories (EML). Sampling procedures and required laboratory tests must be in compliance with the most current edition of *Standard Methods for the Examination of Dairy Products* (SMEDP) of the American Public Health Association

and the most current edition of *Official Methods of Analysis of AOAC INTERNATIONAL* (OMA).

## IMPORTS

Traditional fermented milk such as yogurt, cultured butter milk, lactobacillus acidophilus milks, and even some of the newer fermented milk products such as drinkable yogurt are defined and regulated by the Grade “A” PMO. This regulatory system relies on a complex oversight and inspection of raw milk production, milk transportation, and processing described previously in this chapter.

The United States is a signatory of the World Trade Organization (WTO) agreement, which allows countries to establish measures to ensure safety of food within their countries. The measures, however, must be applied in a manner so that they do not arbitrarily discriminate between products from different countries or treat domestic products more favorably than imported products without justification. The determination of equivalence is made by the importing country based on whether the exporting country’s measures meet the level of protection deemed appropriate by the importing country as provided by its own measures.

The FDA and the NCIMS have identified and mutually accepted three options that are consistent with NCIMS Procedures and allow states to receive PMO defined Grade “A” products produced outside of the United States.

These options are as follows:

1. A dairy firm outside of the United States could contract with any current NCIMS member’s regulatory agency to provide the Grade “A” milk safety program in total. This would include the regulatory licensing, dairy farm and milk plant inspection, sampling, pasteurization equipment tests, laboratory certification, and rating/NCIMS listing certification. To use this option, the firm would be required to abide by all applicable NCIMS regulatory and rating requirements and the regulatory/rating agency would have to agree to treat the firm as if it were located within its jurisdiction for all purposes including inspection and enforcement. Ratings of the firm would be check-rated by the FDA.
2. The importing country may become a full member of the NCIMS subject to all NCIMS rules and enjoying all privileges of a U.S. state. This would require, among other things, that the milk regulatory



**Table 3.3. Chemical, Physical, Bacteriological, and Temperature Standards**

Grade “A” raw milk and milk products for pasteurization, ultra-pasteurization, or aseptic processing	Temperature.....	Cooled to 10°C (50°F) or less within 4 hours or less of the commencement of the first milking, and to 7°C (45°F) or less within 2 hours after the completion of milking, provided that the blend temperature after the first milking and subsequent milkings does not exceed 10°C (50°F).
	Bacterial limits.....	Individual producer milk not to exceed 100,000 per milliliter prior to commingling with other producer milk. Not to exceed 300,000 per milliliter as commingled milk prior to pasteurization.
	Drugs.....	No positive results on drug residue detection methods as referenced in Section 6—Laboratory Techniques.
	Somatic cell count <sup>a</sup> .....	Individual producer milk not to exceed 750,000 per milliliter.
Grade “A” pasteurized milk and milk products and bulk shipped heat-treated milk products	Temperature.....	Cooled to 7°C (45°F) or less and maintained thereat.
	Bacterial limits <sup>b</sup> . . . . .	20,000 per milliliter or grams. <sup>c</sup>
	Coliform <sup>d</sup> .....	Not to exceed 10 per milliliter. But in the case of bulk milk, transport tank shipments shall not exceed 100 per milliliter.
	Phosphatase <sup>e</sup> .....	Less than 350 milliunits/liter for fluid products and other milk products by the Fluorometer or Charm ALP or equivalent.
	Drugs <sup>b</sup> .....	No positive results on drug residue detection methods as referenced in Section 6—Laboratory Techniques that have been found to be acceptable for use with pasteurized and heat-treated milk and milk products.
Grade “A” pasteurized concentrated (condensed) milk and milk products	Temperature.....	Cooled to 7°C (45°F) or less and maintained thereat unless drying is commenced immediately after condensing.
	Coliform.....	Not to exceed 10 per gram. But in the case of bulk milk transport tank shipments shall not exceed 100 per milliliter.
Grade “A” aseptically processed milk and milk products	Temperature.....	None
	Bacterial limits.....	Refer to 21 CFR 113.3(e)(1) <sup>f</sup>
	Drugs <sup>b</sup> .....	No positive results on drug residue detection methods as referenced in Section 6—Laboratory Techniques that have been found to be acceptable for use with aseptically processed milk and milk products.

*(Continued)*

**Table 3.3. Continued**

Grade “A” nonfat dry milk		<i>No more than:</i>
	Butterfat.....	1.25%
	Moisture.....	4.00%
	Titratable acidity.....	0.15%
	Solubility index.....	1.25 ml
	Bacterial estimate.....	30,000 per gram
	Coliform.....	10 per gram
	Scorched particles disc B.....	15.0 per gram
Grade “A” whey for condensing	Temperature.....	Maintained at a temperature of 7°C (45°F) or less, or 63°C (145°F) or greater, except for acid-type whey with a titratable acidity of 0.40% or above, or a pH of 4.6 or below.
Grade “A” pasteurized condensed whey and whey products	Temperature.....	Cooled to 7°C (45°F) or less during crystallization, within 48 hours of condensing.
Grade “A” dry whey, Grade “A” dry whey products, Grade “A” dry buttermilk, and Grade “A” dry buttermilk products	Coliform limit.....	Not to exceed 10 per gram
	Coliform limit.....	Not to exceed 10 per gram

<sup>a</sup>Goat milk 1,000,000 per milliliter.

<sup>b</sup>Not applicable to acidified or cultured products.

<sup>c</sup>Results of the analysis of dairy products that are weighed in order to be analyzed will be reported in # per grams. (Refer to the current edition of the *SMEDP*.)

<sup>d</sup>Not applicable to bulk shipped heat-treated milk products.

<sup>e</sup>Not applicable to bulk shipped heat-treated milk products; UP products that have been thermally processed at or above 138°C (280°F) for at least 2 seconds to produce a product that has an extended shelf life (ESL) under refrigerated conditions; and condensed products.

<sup>f</sup>21 CFR 113.3(e) (1) contains the definition of “commercial sterility.”

Source: USDHHS PMO, 2003.

agencies of the importing countries adopt and enforce rules and regulations that are the same as those required in the United States and abide by all applicable NCIMS regulatory and rating requirements. Their ratings would be check-rated by FDA in the same way as state ratings. The FDA would certify their rating, sampling surveillance, and laboratory evaluation officers.

3. The FDA can evaluate the importing country’s system of assuring the safety of dairy products and compare the effect of that system with the effect of the U.S. system on the safety of dairy products produced domestically. The NCIMS has adopted a procedure to accept FDA findings of equivalence and to allow NCIMS member states to accept products produced within the scope of such a finding.

Additionally, Grade “A” milk products have restrictions in the use of imported dairy ingredients unless the foreign ingredient facility has meet the U.S. grade “A” requirements by using one of the three options listed above. As specified in the Grade “A” PMO, Grade “A” dairy products must use only Grade “A” dairy ingredients, except that small amounts of functional ingredients (total of all such ingredients should not exceed 5% by weight of the finished blend) that are not Grade “A” are allowed in Grade “A” when the finished ingredient is not available in Grade “A” form, i.e., sodium caseinate (USDHHS PMO, 2003).

## EQUIPMENTS STANDARDS

The specific requirements for milking equipment, milk transportation, storage, and processing are

explained in the Grade “A” PMO. To comply with the sanitary design and construction standards of the PMO, equipment manufactured in conformity with the 3-A Sanitary Standards must be evaluated by the state regulatory agency prior to installation. The 3-Sanitary Standards for dairy equipment are promulgated jointly by the Sanitary Standards Subcommittee of the Dairy Industry Committee, the Committee on Sanitary Procedure of the International Association for Food Protection (IAFP), and the FDA Milk Safety Branch.

### THE 3-A SANITARY STANDARDS SYMBOL

The 3-A Symbol was introduced in 1927 and is used to identify equipment that meets 3-A Sanitary Standards for design and fabrication. Use of the 3-A Symbol is governed by 3-A Sanitary Standards, Inc. (3-A SSI).

Once a 3-A Sanitary Standard has been developed and becomes effective, manufacturers may receive authorization from the 3-A Symbol Council to use the symbol. Voluntary use of the 3-A Symbol on dairy and food equipment serves three important purposes:

- Assures processors that equipment meets sanitary standards;
- Provides accepted criteria to equipment manufacturers for sanitary design; and
- Establishes guidelines for uniform evaluation and compliance by sanitarians.

3-A SSI formulates standards and practices for the sanitary design, fabrication, installation, and cleanability of dairy and food equipment or systems used to handle, process, and package consumable products where a high degree of sanitation is required. These standards and practices are developed through the cooperative efforts of industry experts. Its ultimate goal is to protect consumable products from contamination and to ensure that all product surfaces can be mechanically cleaned-in-place (CIP) or easily dismantled for manual cleaning.

3-A Accepted Practices cover a system, which is defined as a set of connected equipment and machinery that forms as a whole or works together. In addition to the criteria for equipment, a practice may also provide specifications for sanitary installation and legal controls.

3-A Sanitary Standards provide material specifications, design criteria, and other necessary information for equipment types to satisfy public health concerns. 3-A Standards are available for more than 70 equipment types, from fittings, centrifugal pumps, heat

exchangers, valves, membranes, CIP spray devices to silo tanks.

3-A criteria are universally accepted by equipment manufacturers, fabricators, users, and sanitarians. The 3-A Symbol, where authorized by 3-A SSI, is used by equipment manufacturers and fabricators to indicate conformance to 3-A Standards.

In order for dairy and food equipment manufacturers to use the 3-A Symbol, they must file an application with the 3-A Symbol Council office signifying that the equipment is compliant with all provisions of that standard. A statement of quality controls in place must be submitted along with drawings or pictures of the equipment. The Council may also request additional materials to ensure compliance on complex subassemblies. The Council reviews the application and, if all areas are in compliance under that specific 3-A Standard, the manufacturer is permitted to use the 3-A Symbol.

Equipment manufacturers are required to place the serial number of the 3-A Standard with which it complies adjacent with the 3-A Symbol on their equipment.

A listing of authorized holders of 3-A symbol certification can be found on the 3-A Sanitary Standards Web site (<http://www.3-a.org>). The listing is organized by standards for each type of equipment and provides the manufacturing company’s information and if relevant, the model number of the piece of equipment that has received authorization.

## MILK PRICING—U.S. FEDERAL MILK MARKETING ORDERS

### BACKGROUND OF FEDERAL ORDERS

The Federal Milk Marketing Orders system is a regulatory function administered by the United States Department of Agriculture (USDA). The Federal Orders have evolved significantly since their first legislative introduction in 1937. The objective of the Federal Orders is to stabilize markets by placing certain requirements on the pricing and handling of milk in the area it covers, and ultimately, assure that an adequate supply of wholesome milk is available and will continue to be available at a reasonable price to consumers. There are 10 regions in the United States that are regulated by a Federal Order (see Fig. 3.1). Regions that are not subject to a Federal Order have a state milk marketing order such as in California where the pricing system is akin to the Federal Orders, or they may be unregulated (USDA, 2004).

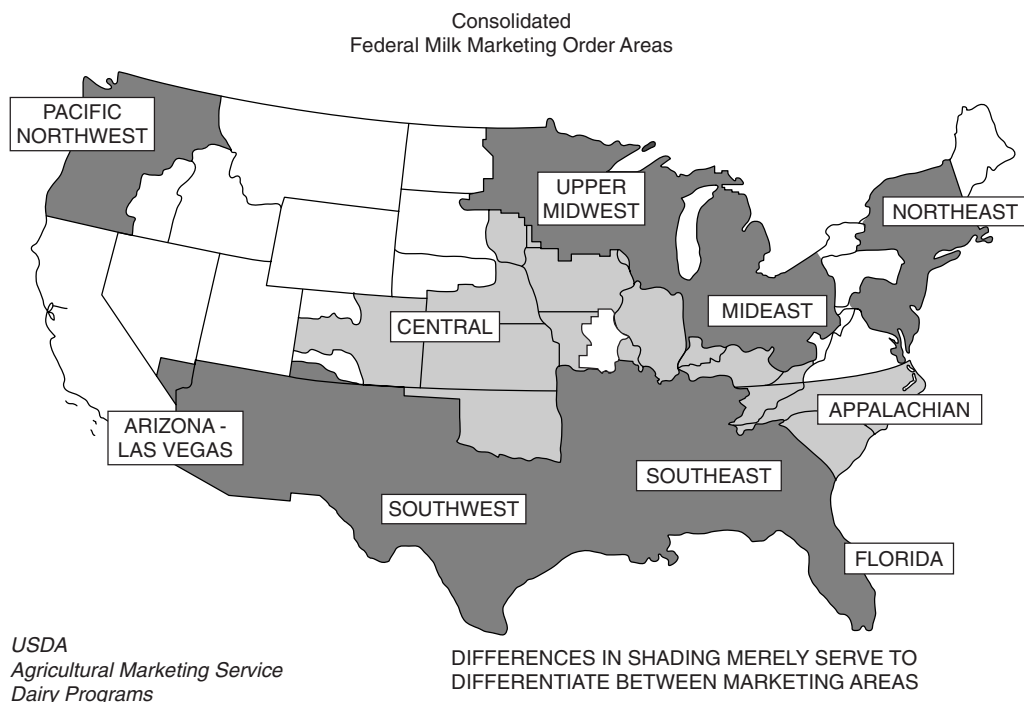

**Figure 3.1.** Consolidated Federal Milk Marketing Orders areas.

The Federal Milk Marketing Orders are concerned primarily with orderly marketing of raw Grade “A” milk from producer to processor. Classified pricing and pooling are the two key elements for the Federal Milk Orders which set minimum prices for more than 70% of the Grade “A” milk produced in the United States. A major function of the Federal Orders is computing minimum prices for raw Grade “A” milk that handlers must pay to dairy farmers. The Federal Milk Marketing Orders system has been developed to pool the proceeds of all qualified milk sales in order to ensure that all producers in an area receive a uniform price for their milk—regardless of how their milk was used.

### CLASSIFIED PRICING

The Federal Milk Marketing Orders program uses product price formulas to determine milk component values that are combined to calculate monthly class prices. The factors in the formulas are dairy product prices, which change monthly, and make allowances and product yields, which are set in the formulas. The dairy product prices are those collected by USDA

from weekly surveys of dairy product manufacturers that sell specific products on a bulk, wholesale basis (Jesse and Cropp, 2004).

Federal orders define the following four classes of milk, from highest to lowest value (under most circumstances):

1. Class I is milk used for beverage products. This includes “white” whole, low-fat, and skim milk in all container sizes, chocolate and other flavored milks, liquid buttermilk, and eggnog.
2. Class II is milk used for soft manufactured products like yogurt and cultured dairy products, sour cream, ice cream, and other frozen dairy desserts, cottage cheese, and creams.
3. Class III is milk used to manufacture cream cheese and hard cheeses.
4. Class IV is milk used to make butter and dry milk products—principally nonfat dry milk.

### PRODUCER PRICES

The Federal Orders requires milk handlers in a marketing area to pay dairy farmers (producers) no less

than certain minimum prices for fluid milk. The price for class II, III, and IV milk is the same under all Federal Orders. Class II prices are computed each month for each marketing area and are based on National Agricultural Statistics Service (NASS) released prices for milk used in manufactured products. The Federal Orders also require that a plant's usage value for milk be combined with other plants usage value (pooled) and each producer (or cooperative) be paid on the basis of a uniform/blend/average price. This blend price represents an average of the value of milk in all uses (fluid milk, cottage cheese, ice cream, cheese, butter, etc.).

With federal order pooling, producers receive a common price for their milk components regardless of how their milk is used. Total producer milk value under the order is the sum of the following elements:

- Total hundredweight milk × Producer Price Differential (at locations)
- Protein pounds × Protein Price

- Other Solids pounds × Other Solids Price
- Butterfat pounds × Butterfat Price
- Total hundredweight milk × Somatic Cell Adjustment

Expressed in terms of hundredweights of milk, producer prices will differ according to milk composition, milk quality, and the location of the receiving plant.

### MILK PRICING FOR FERMENTED MILK PRODUCTS

Milk pricing for fermented milk and milk products is dependent on whether the final product will be consumed as a beverage, on the level of fat, and on milk solids. Products similar to spoonable yogurt and sour cream are considered as class II under the Federal Milk Marketing Orders system. Drinkable fermented products, such as cultured buttermilk, acidophilus milk, kefir, and yogurt drinks that have 6.5%

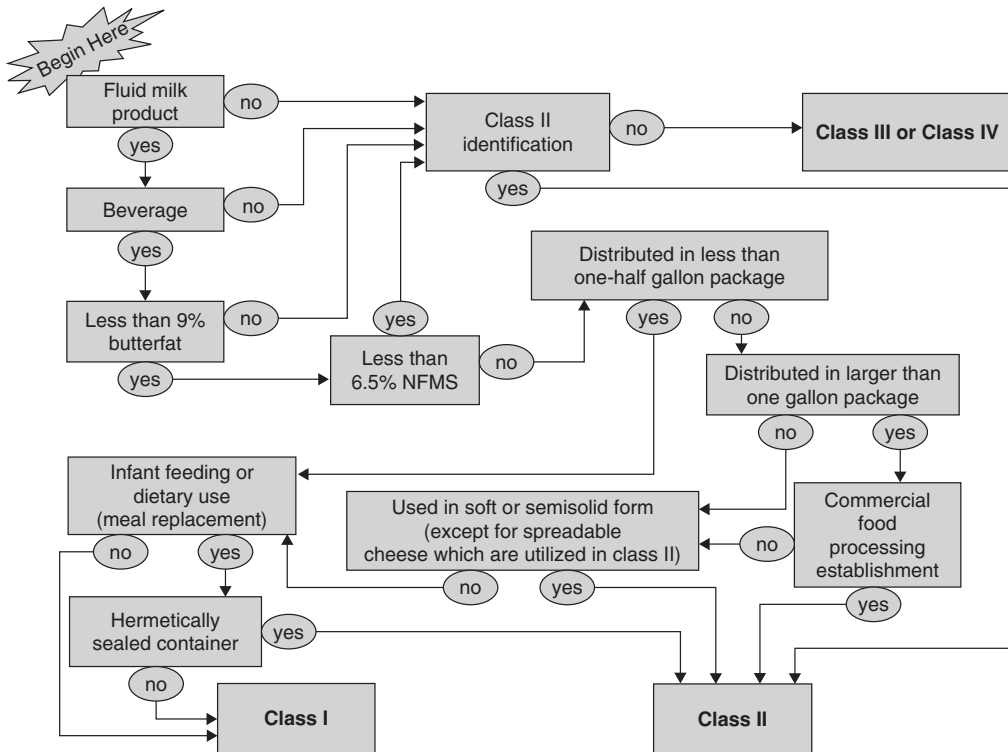

Figure 3.2. Flow diagram used to determine milk classification pricing for a product.

Source: IDFA Milk Procurement Workbook, 2005.

or greater milk solids nonfat and less than 9% milk fat will be priced as class I. The flow chart in Figure 3.2 can be used to determine whether a product will be considered as class I or class II.

## GLOSSARY

**AISI 300**—A quality specification for stainless steel from the American Iron and Steel Institute.

**BULK TANK UNIT**—A dairy farm or a group of dairy farms from which raw milk is collected.

**CIP (CLEANING-IN-PLACE)**—A method of cleaning lines and tanks without disassembly by purging water and cleaning chemicals.

**CLASSIFIED PRICING**—A system used to price raw milk sold for processing based on the intended use in a specific dairy product.

**COLIFORM**—A group of microorganisms found in the intestinal tract; their presence indicates contamination with fecal matter.

**FDA**—U.S. Food and Drug Administration.

**FFD&CA (FEDERAL FOOD DRUG AND COSMETIC ACT)**—An act of the U.S. Congress that specified the basis for food safety standards.

**GRADE “A” PMO (PASTEURIZED MILK ORDINANCE)**—Model milk regulations used for the inspection of milk production and processing facilities.

**HACCP (HAZARD ANALYSIS AND CRITICAL CONTROL POINTS)**—A system of steps for establishing a food safety program through identification and prevention of problems.

**IMS (INTERSTATE MILK SHIPPERS) LISTED**—A publication that provides a listing of farms and plants that have successfully passed a sanitary inspection.

**NCIMS**—National Conference on Interstate Milk Shipments.

**PASTEURIZATION**—A process of heating fluid milk products to render them safe for human consumption by destroying the disease-producing organisms (pathogens). The process inactivates approximately 95% of all microorganisms in milk.

**PHOSPHATE**—An enzyme that is deactivated in milk at normal pasteurization temperatures; its presence in

pasteurized milk indicates the milk has not been properly heated or was mixed with unpasteurized milk.

**SINGLE-SERVICE CONTAINERS**—A container used in the storage, handling, or packaging of milk or milk products intended for only one use.

**SNF**—Solids-not-fat portion of the milk.

**SOMATIC CELL COUNT**—A numeric count of the dead epithelial cell and leucocytes (white blood cells) that migrate into milk from the udder of a cow.

**UHT (ULTRA-HIGH TEMPERATURE)**—Heat treatment at a temperature of 135–150°C for a holding time of 4–15 seconds that sterilizes the product for aseptic packaging to permit storage at ambient temperatures.

**USDA**—United States Department of Agriculture.

## REFERENCES

- CFSAN (Center for Food Safety and Applied Nutrition). 2004. National Conference on Interstate Milk Shipments Model Documents—Milk Safety References [Online]. Available at <http://www.cfsan.fda.gov/~ear/p-nci.html>.
- Jesse E, Cropp R. 2004. Basic Milk Pricing Concepts for Dairy Farmers. University of Wisconsin—Extension, Cooperative Extension, Madison, WI.
- USDA (U.S. Department of Agriculture). 2004. Agriculture Marketing Services Dairy Programs. Federal Milk Marketing Orders [Online]. Available at <http://www.ams.usda.gov/dairy/orders.htm>.
- USDHHS PMO (U.S. Department of Health and Human Services). 2003. Grade “A” Pasteurized Milk Ordinance, 2003 Revision, Department of Public Health, USDHHS, Food and Drug Administration, Washington, DC.
- USDHHS Procedures. 2003. Procedures Governing the Cooperative State-Public Health Service/Food and Drug Administration Program of the National Conference on Interstate Milk Shipment, 2003 Revision, Department of Public Health, USDHHS, Food and Drug Administration, Washington, DC.
- USDHHS Methods. 2003. Methods of Making Sanitation Ratings of Milk Shippers, 2003 Revision, Department of Public Health, USDHHS, Food and Drug Administration, Washington, DC.

# 4

## Regulations for Product Standards and Labeling

*Cary P. Frye*

U.S. Code of Federal Regulations  
U.S. Product Standards of Identity  
    Fermented Milk and Milk Products  
    General Definitions  
    Stayed Provisions  
    Proposed Changes to U.S. Standards for Yogurt and  
        Fermented Milks  
    Food Additives and Packaging  
Labeling  
    General Requirements  
    Nomenclature  
    Flavor Labeling  
    Ingredient Declaration  
    Nutrition Facts Panel  
    Special Labeling Requirements  
Codex Standards and Definitions for Fermented Milk  
    Products  
Glossary  
References

### U.S. CODE OF FEDERAL REGULATIONS

The U.S. Code of Federal Regulations (CFR) published by the U.S. government is a set of comprehensive documents containing all Federal Regulations. Each branch of government is assigned a different numerical title. The regulations for Food and Drugs are published in Title 21. These publications are revised and issued yearly. The current version can also be found online. The Title 21 Code of Federal Regulations Parts 1—199 lays out FDA's regulations for current good manufacturing practices, food labeling, standards of identity, and approved food additives.

### U.S. PRODUCT STANDARDS OF IDENTITY

Food standards were established to promote fair competition among manufacturers and to eliminate consumer confusion. Currently there are 97 federal standards of identity for various dairy products out of a total of 262 standards for all foods including dairy. Many states have also promulgated standards of identity for dairy products. The Nutrition Labeling Education Act (NLEA) of 1990 established that where federal and state standards exist simultaneously, the federal standard preempts the state regulation. However, in the event if no federal standard exists for a specific dairy product and a state standard has been promulgated, the state standard is in effect. In terms of detailed presentation, this section only addresses federal standards of identity. For the most part, standards of identity dictate the processing procedure, composition, and allowed ingredients of the product and often cover public safety concerns and product labeling. All federal standards of identity for dairy products are referenced in Title 21 CFR, Parts 130–135. The Grade "A" Pasteurized Milk Ordinance (PMO), a model regulation for milk sanitation, adopts by reference the federal standards of identity. These standards of identity apply to products that are manufactured for sale in the United States including both domestically produced and imported products.

### FERMENTED MILK AND MILK PRODUCTS

The milk and cream standards are found in 21 CFR part 131, which include definitions of milk ingredients and specific requirements for fermented milk

products such as cultured milk, sour cream, and yogurts, which are listed below.

## GENERAL DEFINITIONS

In addition to the standards of identity listed below, the CFR also provides definitions of milk and cream as ingredients in fermented milk products:

*Milk.* Milk is the lacteal secretion, free from colostrum, obtained by milking one or more healthy cows. Milk fat and milk solids nonfat (MSNF) may be “adjusted” by removing the milk fat or adding cream, concentrated milk, dry whole milk, skim milk, concentrated skim milk, or nonfat dry milk. Compositionally, it must have a minimum of 8.25% MSNF and a minimum of 3.25% milk fat.

*Cream.* Cream means the liquid milk product high in fat separated from milk, which may have been adjusted by adding to it milk, concentrated milk, dry whole milk, skim milk, concentrated skim milk, or nonfat dry milk. Cream contains not less than 18% milk fat.

## Cultured Milk—21 CFR §131.112

### Description of Process

- Prepared by culturing with characterizing microbial organisms with one or more of the following: cream, milk, partially skimmed milk, and skim milk.
- Must be pasteurized or ultra-pasteurized prior to the addition of the microbial culture and may be homogenized.
- May contain other optional ingredients (listed later below).

### Composition

- Minimum of 3.25% of milk fat
- Minimum of 8.25% MSNF
- Minimum of 0.5% titratable acidity (expressed as lactic acid)
- 2000 IU of vitamin A/qt (optional)
- 400 IU of vitamin D/qt (optional)

### Other Ingredients

- Acidifying ingredients such as acetic acid, adipic acid, citric acid, fumaric acid, glucono-*delta*-lactone, hydrochloric acid, lactic acid, malic acid, phosphoric acid, succinic acid, or tartaric acid.

- Optional dairy ingredients include concentrated skim milk, nonfat dry milk, buttermilk, whey, lactose, lactalbumins, lactoglobulins, and whey (modified by partial or complete removal of lactose and/or minerals).

The provision in the standard of identity for cultured milk limiting the sources of optional dairy ingredients has been stayed, pending the outcome of a public hearing. Other milk-derived ingredients (e.g., caseinates) may be used to increase the nonfat solids content in cultured milk.

- Nutritive carbohydrate sweeteners such as beet or cane sugar (sucrose), inverted sugar (paste or syrup), brown sugar, refiner’s sugar, molasses (not blackstrap), high fructose corn syrup, fructose, fructose syrup, maltose, maltose syrup, dried maltose syrup, malt extract, dried malt extract, honey, maple sugar, dextrose anhydrous, dextrose monohydrate, glucose syrup, dried glucose syrup, lactose, cane syrup, maple syrup, and sorghum.
- Flavoring.
- Color additives may be added, except that those that impart butterfat or milk fat color may not be added directly to the fluid product so that it gives the appearance that the product contains more milk fat than it actually does.
- Stabilizers.
- Butterfat or milk fat in the form of granules or flakes (which may or may not contain color additives).
- Aroma and flavor producing microbial culture.
- Salt.
- Flavor precursors (citric acid 0.15% maximum of milk or equal the amount of sodium citrate).

**Nomenclature.** The name of the food is “cultured milk.”

### *Milk fat level*

- Milk fat percentage declaration is not required.

### *Process*

- If the dairy ingredients were homogenized, then the label may indicate “homogenized” (optional).

### *Sweetened*

- If sweetened with a nutritive carbohydrate sweetener without a characterizing flavor, then the label must indicate “sweetened.”



*Characterizing organisms*

- Name of the food may declare traditional or generic names of characterizing microbial organisms (optional) or ingredients, e.g., “kefir cultured milk,” “acidophilus cultured milk,” or when lactic acid producing organisms are used, “cultured buttermilk.”

*Flavoring*

- If characterizing flavors were added, then the name should indicate the common or usual name of the flavoring.

**Sour Cream (Cultured Sour Cream) 21 CFR §131.160****Description of Process**

- Produced from souring pasteurized cream with lactic acid producing bacteria.
- May contain other optional ingredients listed below.

**Composition**

- Minimum of 18% milk fat
- Minimum of 14.4% milk fat for bulky flavored sour creams
- Minimum of 0.5% titratable acidity

**Other Ingredients**

- Ingredients that improve texture, prevent syneresis, or extend shelf life of the sour cream.
- Flavor precursor—sodium citrate in a minimum quantity of 0.1% added prior to culturing.
- Rennet.
- Salt.
- Flavoring ingredients with or without coloring, fruit or fruit juice (may be from concentrate), or natural and artificial flavoring.

**Nomenclature.** The name of the food is “sour cream” or “cultured sour cream.”

*Flavoring*

- If characterizing flavors were added, then the name should indicate the common or usual name of the flavoring.

*Sweetened*

- If the sour cream was sweetened with a nutritive sweetener without the addition of characterizing flavorings, then the label must indicate “sweetened.”

**Yogurt (Includes Drinkable Yogurts) 21 CFR §131.200****Description of Process**

- Produced by culturing with the lactic acid-producing bacteria *Lactobacillus bulgaricus* and *Streptococcus thermophilus* (may contain other lactic acid-producing bacteria) one or more of the following: cream, milk, partially skimmed milk, skim milk, or reconstituted dairy ingredients.

The standard of identity for yogurt does not include the addition of reconstituted dairy ingredients as basic components in the manufacturing of yogurt. This exclusion has been stayed, pending the outcome of a public hearing, and therefore, reconstituted dairy ingredients could be used as a basic dairy component in yogurt.

- May be homogenized and must be pasteurized or ultra-pasteurized prior to the addition of bacteria culture.
- Flavoring ingredients may be added after pasteurization or ultra-pasteurization.
- The product may be heat-treated to destroy viable microorganisms to extend shelf life.
- May contain other optional ingredients (listed later below).

**Composition**

- The provision requiring the milk fat level to be a minimum of 3.25% before the addition of bulky flavorings has been stayed, pending the outcome of a public hearing.
- Minimum of 8.25% MSNF.
- 2000 IU vitamin A/qt (optional).
- 400 IU vitamin D/qt (optional).
- The product does not have to meet the titratable acidity requirement indicated in the standard (minimum of 0.9% titratable acidity). This provision was stayed, pending the outcome of a public hearing.

**Other Ingredients**

- Optional dairy ingredients include concentrated skim milk, nonfat dry milk, buttermilk, whey, lactose, lactalbumins, lactoglobulins, and whey (modified by partial or complete removal of lactose and/or minerals). The provision in the standard of identity for yogurt limiting the sources of optional dairy ingredients has been

stayed, pending the outcome of a public hearing. Other milk-derived ingredients (e.g., caseinates) may be used to increase the nonfat solids content in yogurt.

- Nutritive carbohydrate sweeteners such as beet or cane sugar (sucrose), inverted sugar (paste or syrup), brown sugar, refiner's sugar, molasses (not blackstrap), high fructose corn syrup, fructose, fructose syrup, maltose, maltose syrup, dried maltose syrup, malt extract, dried malt extract, honey, maple sugar, dextrose anhydrous, dextrose monohydrate, glucose syrup, dried glucose syrup, lactose, cane syrup, maple syrup, sorghum.
- Flavoring ingredients.
- Color additives.
- Stabilizers.
- Preservatives as functional ingredients were not provided for in the standard of identity for yogurt. This exclusion has been stayed, pending the outcome of a public hearing, and therefore, preservatives could be added to yogurt as a functional ingredient.

**Nomenclature.** The name of the food is “yogurt.” Alternate spelling of the food should not serve as the *name of the food* (e.g., “yogourt,” or “yoghurt”).

#### Process

- If the dairy ingredients were heat-treated after culturing, then the name of the food must be followed by the parenthetical phrase “(heat-treated after culturing).”
- If the dairy ingredients were homogenized, then the label may indicate “homogenized” (optional).

#### Vitamins

- If vitamins are added, then the following types of phrases are stated as appropriate: “vitamin A” or “vitamin A added,” “vitamin D” or “vitamin D added,” or “vitamin A and D” or “vitamin A and D added.”
- The word “vitamin” may be abbreviated “vit.”

#### Flavorings

- If the yogurt contains characterizing flavorings, then the common or usual name of the flavorings shall be indicated in the name.

#### Sweetened

- If the product is sweetened with a nutritive sweetener without any characterizing ingredients added, then the label must indicate “sweetened.”

### Low-Fat Yogurt (Includes Drinkable Low-Fat Yogurts) 21 CFR §131.203

Same as yogurt except for the following:

#### Composition

- Either  $\frac{1}{2}$ , 1,  $1\frac{1}{2}$ , or 2% milk fat (before the addition of bulky flavorings).

**Nomenclature.** The name of the food is “low-fat yogurt.” Alternate spelling of the food should not serve as the *name of the food* (e.g., “low-fat yogourt,” “low-fat yoghurt”).

#### Milk fat level

- The percentage of milk fat must be declared (not in decimal notation) as “ $\frac{1}{2}$ % milk fat,” “1% milk fat,” “ $1\frac{1}{2}$ % milk fat,” or “2% milk fat.”

### Nonfat Yogurt (Includes Drinkable Nonfat Yogurts) 21 CFR §131.206

Same as yogurt except for the following:

#### Composition

- Less than 0.5% milk fat (before the addition of bulky flavorings).

**Nomenclature.** The name of the food is “nonfat yogurt.” Alternate spelling of the food should not serve as the *name of the food* (e.g., “nonfat yogourt,” “nonfat yoghurt”).

## STAYED PROVISIONS

It should be noted that as part of FDA's administrative procedures for enacting and updating standards, any person who would be adversely affected by a change in a food standard may file objections specifying the provisions being objected to, providing the grounds and requesting a public evidentiary hearing. The mere filing of the objection prevents the action from being taken (the action is stayed) and the FDA must hold a public hearing.

Some requirements listed in the CFR have been stayed following the outcome of a public hearing. At the time of printing, FDA had not acted to proceed with such a public hearing. Therefore, the following provisions noted as being stayed are not in effect:

1. There is no restriction to those so named for the type of milk-derived ingredients that may be used

- to increase the nonfat solids content of cultured and acidified milks, eggnog, and yogurts.
2. Reconstituted dairy ingredients can be used as the basic ingredient in the manufacture of yogurts.
  3. Preservatives can be added to yogurts.
  4. There is no set minimum titratable acidity of 0.9%, expressed as lactic acid.
  5. The requirement that the 3.25% minimum milk fat level is eliminated after the addition of one or more of the optional sources of MNSF for yogurt.

### PROPOSED CHANGES TO U.S. STANDARDS FOR YOGURT AND FERMENTED MILKS

A citizen's petition was filed in 2000 with FDA by the National Yogurt Association (NYA) on behalf of its members, requesting that FDA modernize the standards of identity for yogurt to replace the existing yogurt standards and make conforming amendments to the existing cultured milk standard of identity. As required under FDA's procedural regulations, a citizen petition must include information regarding the action requested, statement of grounds, environmental impact, economic impact, and certification of all relevant information, both favorable and unfavorable. The regulations also require FDA to rule on each petition filed with the Agency.

NYA's petition provides the basis for the FDA to consider changes that would replace the currently existing fragmented standards for yogurt, low-fat yogurt, and nonfat yogurt as these standards contain numerous stayed provisions. The proposed standards would require that yogurt contain a minimum level of certain live and active bacterial cultures and allow for more flexibility to implement advances in food technology.

The specific details of the proposed changes are as follows:

- *Single Standard of Identity*: Incorporates full-fat, low-fat, nonfat standards in one standard of identity. It also suggests that a parallel "cultured/fermented milk" standard be created for similar products that do not meet the new yogurt standard.
- *Live and Active Characterizing Cultures*: Require that yogurt be characterized by certain levels of bacterial cultures of at least  $10^7$  CFU/g active cultures *Lactobacillus delbrueckii* subsp. *bulgaricus* and *Streptococcus thermophilus* at the time of manufacture.

- *Acidity*: Originally the petition proposed a minimum acidity for yogurt of pH 4.6 or lower rather than a titratable acidity. Later, this request was modified to maintain titratable acidity as the measure of lactic acid production and recommend a standard of 0.6% titratable acidity, which more closely reflects industry practice and consumer preference for less tart yogurt than the present 0.9% lactic acid.
- *Homogenization/Pasteurization*: Clarifies that the standard dairy ingredients must be pasteurized or ultra-pasteurized before culturing and that optional ingredients may be added after pasteurization and culturing.
- *Standard Dairy Ingredients*: Permits the use of reconstituted dairy ingredients as the basic dairy ingredients used to compose the minimum 8.25% nonfat milk solids. Restricts whey protein concentrate to be used as a dairy ingredient in levels up to 25% of all nonfat milk solids.
- *Optional Ingredients*: Permits any "milk-derived ingredients used for technical or functional purpose." Requires that dairy ingredients comprise at least 51% of the product's overall ingredients by weight. Clarifies that other bacterial cultures, in addition to the two characterizing cultures, are permitted. Also allows any safe and suitable nutritive carbohydrate sweeteners or nonnutritive sweeteners; flavoring ingredients; color additives; stabilizers and emulsifiers; preservatives, vitamins, and minerals; and safe and suitable ingredients added for nutritional or functional purposes.
- *Nomenclature*: Characterizes products containing more than 3.0 g of total fat per reference amount commonly consumed (RACC) as "yogurt." Products with at least 0.5 g, but not more than 3.0 g of total fat per RACC will be named as "low-fat yogurt" and if the food is less than 0.5 g of total fat per RACC it will be "nonfat yogurt." This change bases the identity of the product on the total fat quantity in the entire product rather than just the milk fat of the yogurt prior to addition of optional ingredients or flavorings.

At the time of writing, the FDA has not yet changed the standards of identity to incorporate these suggested modifications. Under the rule-making process, the FDA must consider public comment for interested stakeholders before promulgating new standards of identity. The first step in this process occurred in early 2004 when the FDA published an

Advance Notice of Proposed Rule Making seeking comments on the proposed NYA petition. The next step is for the FDA to consider the relevant comments and publish either a Proposed Rule allowing for additional comments or a Final Rule Making. However, under FDA Procedures the law requires a very burdensome process for issuance, amendment, or repeal of standards of identity if anyone objects to the proposal being considered. Since some interested parties have filed support of the yogurt modernization petition and others have objected to specific provisions, it is not known when proposed changes might be finalized.

### **FOOD ADDITIVES AND PACKAGING**

Ingredients and food compounds that are added to milk and fermented milk products must be safe and suitable for their intended function. The FDA reviews the safety of food and color additives before manufacturers and distributors can market them. To initiate this review, food additive firms are required to submit a petition or notification that includes appropriate test data to demonstrate the safety of the intended use of the substance. The agency also has a notification program for substances that are “generally recognized as safe” (GRAS).

Food packaging is regulated as a food-contact surface. The FDA defines a food-contact substance as “any substance intended for use as a component of materials used in manufacturing, packing, packaging, transporting, or holding food if such use is not intended to have a technical effect in such food.” Safety evaluations of food-contact surfaces are done by an FDA notification process to authorize new uses of food additives that are food-contact substances based on a detailed analysis of the compounds chemistry, toxicology, and environmental impact. An inventory of effective notifications for food-contact substances and additional information regarding the notification program are listed on FDA’s Web page <http://www.cfsan.fda.gov/~dms/opa-fcn.html>.

An informational database on approved food additives is maintained by the FDA. It contains administrative, chemical, and toxicological information on thousands of substances directly added to food, including substances regulated by the FDA as direct, “secondary” direct, color additives, GRAS, and prior-sanctioned substances. More than 3,000 total substances together comprise an inventory often referred to as “Everything” Added to Food in the United

States (EAFUS). This information can be found at <http://www.cfsan.fda.gov/~dms/eafus.html>.

### **LABELING**

The FDA sets forth general requirements for food labeling in the FDA Federal Food Drug and Cosmetic Act (FFD&C Act) and more detailed regulations in the CFR Title 21 parts 100. The basic premise is that food labels must be truthful and not misleading to consumers. The NLEA established most federal food labeling requirements as nationally uniform standards through federal preemption of state requirements. Under the preemptive authority of the NLEA, no state can directly or indirectly establish or continue to enforce any requirement that is not identical to a federal requirement issued under the following provisions of the FFD&C Act.

Any product introduced into interstate commerce is subject to FDA regulations. The U.S. Court has interpreted the scope of interstate commerce expansively for this purpose so as to apply federal regulation to virtually all products except those for which the product, including its ingredients and packaging materials, are produced, packaged, and sold within the given state. As a result, there are few “intrastate” products, but those that qualify are not subject to FDA regulation.

There are several types of state food labeling requirements that are not expressly preempted, and thus, may be enforced against food products in interstate commerce. These include warning labels, open date coding, unit price labeling, food grading, recyclable container deposit labeling, religious dietary labeling, and item price labeling.

While federal standards of identity preempt state standards, states may continue to establish and enforce standards of identity for products for which no federal standards of identity exist, for example, frozen yogurt or yogurt smoothies.

### **GENERAL REQUIREMENTS**

The food labeling regulations specify what information must appear on the package label, where information must be placed, the label format, and the size for mandatory labeling material such as nutrition information. The part of the package that the consumer is most likely to see during normal retail display is called the “principal display panel.” Information related to the product name including flavoring and

the net quantity expressed by weight or volume must appear in a food product's principal display panel. The "information panel" is typically located to the right of the principal display panel and must contain the full ingredient listing, name, and place of business of manufacturer, packer, or distributor, nutrition labeling of food, and, if applicable, specific requirements related to the use of nutrient content claims, food warnings, and statements of special dietary use.

In addition to the general labeling requirements of the federal regulations, the vast majority of states will mandate the inclusion of additional labeling as required by the Grade "A" PMO discussed in Chapter 3. The Grade "A" PMO's labeling requirements call for all bottles, containers, and packages containing milk and milk products to be conspicuously marked with the term "Grade A," identity of the plant where pasteurized, identification of processing if "ultra-pasteurized" or "aseptic," "reconstituted" or "recombined" if the product is made by reconstitution or recombination, and the terms "keep refrigerated after opening" in the case of aseptically processed milk and milk products.

## NOMENCLATURE

The name of the food or "statement of identity" may be established by regulation, or it may be dictated in the nomenclature section of the product's standard of identity. If the product does not fall under a federal standard or, as applicable, state standard of identity or does not have a common or usual name, then an appropriate descriptive name must be used that will easily be understood by consumers. The standards of identity for cultured milk and yogurt designate the name of the product. Descriptive names may only be used on a product that does not have a standard of identity, or a common or usual name. A descriptive name must be suggestive enough to reveal the basic composition of the product and alleviate any question regarding the product's identity. For example, a beverage product made of a blend of yogurt and juice should not solely use the name "smoothie" but include that it is "a blend of yogurt and juice." In addition, the form of the food must be stated if it is not visible through the packaging. For example, drinkable yogurt would not require a disclosure that the product is a liquid rather than a semisolid if it is packaged in a transparent container where the consumer can clearly see the viscosity or form of the food.

## FLAVOR LABELING

Milk and milk products including yogurt and other fermented milks are labeled with the name of the food and the flavoring if added. Flavorings are defined by the FDA as either natural or artificial. Artificial flavors are compounds that impart flavor which is NOT derived from a spice, fruit or fruit juice, vegetable or vegetable juice, yeast, herb, bark, bud, root, leaf, or plant material, meat, seafood, poultry, eggs, dairy products, and fermented products. Natural flavor or natural flavoring is derived from the compounds listed above in the form of an essential oil, oleoresin or extract, protein, hydrolysate, distillate that is used to impart flavor.

Flavor labeling is dictated by FDA food labeling regulation according to the general "6-Category" flavor labeling system. The 6-Category flavor labeling categories will be referred to as Category A through Category F (IDFA, 2004).

The first three categories (A, B, and C) apply when a flavor, including artificial flavor, is added to a food product in fluid form or "from the bottle" (e.g., vanilla extract, vanillin, coffee extract).

### Category A

When the primary characterizing flavor ingredient is solely natural, not artificial, and is derived from the product whose flavor it simulates, resembles, or reinforces, the name of the food is accompanied by the common or unusual name of the characterizing flavor (e.g., "Vanilla yogurt").

### Category B

When the food contains both natural flavor derived from the characterizing flavor source and other natural flavoring from a source that simulates, resembles, or reinforces the characterizing flavor, the name of the food is followed by the words "with other natural flavor" (e.g., "Coffee yogurt with other natural flavor").

### Category C

When natural flavor(s) used in the food is not derived from the ingredient whose flavor has been determined to be the characterizing flavor or if the food contains an artificial flavor that simulates, resembles, or reinforces the declared characterizing flavor, the name

of the food must be accompanied by the words “artificial” or “artificially flavored” (e.g., “Artificially flavored vanilla yogurt”).

The next two categories (D and E) apply to those products that consumers would commonly expect to contain the characterizing food ingredient(s) (e.g., strawberries, blueberries). In both of these categories, the characterizing food ingredient(s) is added to flavor the finished product at a level NOT sufficient to independently characterize the finished product.

### Category D

When the food contains an *insufficient* amount of the food ingredient to independently characterize the product, and it contains added natural flavor that is derived from the characterizing food ingredient, the food is labeled as a naturally flavored food. The flavor *may* be immediately preceded by the word “natural” and must be immediately followed by the word “flavored” (e.g., “Peach flavored yogurt” or “Natural peach flavored yogurt”).

### Category E

When the food contains an *insufficient* amount of the food ingredient to independently characterize the food and it contains other added natural flavors that are not derived from the characterizing flavor declared on the label, but that simulate, resemble, or reinforce the characterizing flavor, the flavor *may* be immediately preceded by the word “natural” and must be immediately followed by the words “with other natural flavors” (e.g., “Peach yogurt with other natural flavors” or “Natural peach yogurt with other natural flavors”).

Category F applies to products that contain sufficient amounts of characterizing food ingredients to flavor the finished product (e.g., peaches, cherries).

### Category F

If the food contains *sufficient* levels of the food ingredient to independently characterize the food and contains no added artificial flavors or natural flavors (“from the bottle”) that simulate, resemble, or reinforce the characterizing flavor, then the characterizing ingredient is the flavor of the food (e.g., “Strawberry yogurt”).

The name of the flavoring as described above must accompany the name of the food on the principal

display panel of the package or any panels where the product name occurs. A blend of three or more distinctive artificial flavors can be described as a collective name, i.e., “Artificially Flavored Tutti Fruity.” The name of the flavoring must be in a type size not less than 1/2 the height of the letter used in the name of the food and the flavor-modifying terms must not be less than 1/2 the height of the name of the characterizing flavor. Exemptions for category name declaration are made if the flavor name is part of a trademark such as Lemon Drop™.

## INGREDIENT DECLARATION

An ingredient statement is required on all food packages intended for retail sale that contain more than one ingredient. Except where exemptions are applicable, an individual ingredient must be declared in the ingredient statement by its common or usual name. In addition, specific regulations exist for colors, sweeteners, incidental additives, processing aids, and fat and/or oil ingredients. Special ingredient labeling situations include the following:

All *certified* colors must be included by name in the ingredient statement.

Any beverage product purporting to contain fruit or vegetable juice must declare the percent of juice present in the finished product.

Many standards of identity address ingredient labeling, in that they allow for ingredient groupings or provide a common or usual name for a particular ingredient. Some examples are listed in Table 4.1.

The ingredient listing must appear prominently and conspicuously on either the principal display panel or the information panel. The entire list of ingredients must appear in one place without other “intervening material” and, in general, must appear in letters not less than 1/16 of an inch in height.

Ingredients in multicomponent foods may be listed by either of the following two alternatives: grouping or dispersion. Although either method may be used, the grouping alternative may be more helpful to consumers in identifying the ingredients used in each component of the food.

The grouping alternative for ingredient declarations of multicomponent ingredients may be used by declaring the common or usual name of the ingredient followed by a parenthetical listing of all ingredients contained in each of the components in descending order of predominance by weight. For example, an ingredient statement for raspberry yogurt with

**Table 4.1.** Common or Usual Names for Typical Ingredients Used in Dairy Products

Ingredient	Common or Usual Name
Skim milk, concentrated skim milk, reconstituted skim milk, and nonfat dry milk (21 CFR §101.4 <i>Food; designation of ingredients</i> )	Skim milk or nonfat milk
Milk, concentrated milk, reconstituted milk, and dry whole milk (21 CFR §133.129 <i>Dry curd cottage cheese</i> ; 21 CFR §101.4 <i>Food; designation of ingredients</i> )	Milk
Bacteria cultures (21 CFR §131.160 <i>Sour cream</i> ; 21 CFR §131.162 <i>Acidified sour cream</i> ; 21 CFR §101.4 <i>Food; designation of ingredients</i> )	Cultured ___ (the blank is filled in with the name of the substrate)
Sweet cream buttermilk, concentrated sweet cream buttermilk, reconstituted sweet cream buttermilk, and dried sweet cream buttermilk (21 CFR §101.4 <i>Food; designation of ingredients</i> )	Buttermilk
Whey, concentrated whey, reconstituted whey, and dried whey (21 CFR §101.4 <i>Food; designation of ingredients</i> )	Whey
Cream, reconstituted cream, dried cream, and plastic cream (sometimes known as concentrated milk fat) (21 CFR §101.4 <i>Food; designation of ingredients</i> )	Cream
Butter oil and anhydrous butterfat (21 CFR §101.4 <i>Food; designation of ingredients</i> )	Butterfat
Milk-clotting enzymes (21 CFR §133.128 <i>Cottage cheese</i> ; 21 CFR §133.129 <i>Dry curd cottage cheese</i> )	Enzymes

Source: IDFA, 2004.

granola may state the following:

Ingredients: Yogurt (cultured milk, raspberries, sugar, gelatin, pectin, and natural flavors) and granola topping (rolled oats, puffed rice, corn syrup, brown sugar, raisins, and almonds).

The dispersion alternative for ingredient declarations of multicomponent ingredients may be used by incorporating into the ingredient statement (in descending order of predominance in the finished food) the common or usual name of every component of the multicomponent ingredient without listing the multicomponent ingredient itself.

For example, an ingredient statement for raspberry yogurt with granola may state the following:

Ingredients: Cultured milk, sugar, rolled oats, corn syrup, raspberries, puffed rice, brown sugar, raisins, almonds, gelatin, pectin, and natural flavors.

## NUTRITION FACTS PANEL

All food packages intended for retail sale must declare quantitative nutritional information expressed in terms of a “serving” of an individual food. A “serving,” or as it appears on the label, “Serving Size,” is based on the reference amount of food customarily

consumed per eating occasion by persons 4 years of age or older as expressed by a common household measure appropriate for the food.

FDA has established reference amounts for over 100 food product categories. The established reference amount is the benchmark for determining the serving size declared on the label and expressed as a common household measure (e.g., cups, tablespoons, teaspoons). The serving size is required to be expressed on the nutrition label in common household measure followed in parentheses by an equivalent metric quantity (fluid products in milliliters and all other foods in grams). For example, for acidophilus milk, “Serving Size 1 cup (240 ml).” For the most part, the common household unit for similar products will be the same, but because of the varying densities among products, the metric equivalent may not be identical.

Unless otherwise exempted, all nutrients and food component quantities must be declared on the basis of the serving size derived from the reference amount. FDA has established methods for converting the reference amount to the “serving size” for labeling purposes. The method employed is based on the type of container in use (i.e., multiserving vs. single-serving container) and the physical

characteristics of the product (discrete unit vs. nondiscrete fluid or bulk-type product).

For example, manufacturers producing frozen yogurt mix for retail sale must determine the amount of mix that will make (under normal conditions of preparation) 1/2 cup of the product. Since air (i.e., overrun) is incorporated into the product, less than 1/2 cup of mix will be required to produce 1/2 cup of finished product. The following reference amount categories have been established for milk and milk products:

Product Category	Reference Amount
Cheese used as an ingredient (e.g., dry cottage cheese)	55 g
Sour cream	30 g
Milk and cultured or acidified milk	240 ml
Yogurt	225 g
Dairy-based dips	2 tbsp
Dairy and nondairy whipped topping	2 tbsp
Juices, juice drinks, and juice milk blend drinks	240 ml
Shakes or shake substitutes (e.g., dairy shake mixes)	240 ml

Nutrition information is presented to consumers “in the context of a total daily diet,” which is mandated by regulations as a diet of 2,000 calories per day. From this theoretical 2,000 calorie per day diet, recommended intake levels or “daily values” (DV) of individual nutrients have been developed based on current dietary guidelines. As a result, information on individual nutrients is required to be expressed in most cases by a quantitative declaration (grams, milligrams, etc.) and a percentage of a DV for the nutrient.

Nutrient labeling information is referred to as the Nutrition Facts box. The explicit amount (quantitative declaration) and, as applicable, the percentage of the DV must be included in the Nutrition Facts box for each of the following nutrients and food components:

Total calories  
Calories from fat  
Total fat  
Saturated fat  
Trans fat  
Cholesterol

Sodium  
Total carbohydrate  
Dietary fiber  
Sugars  
Protein  
Vitamin A  
Vitamin C  
Calcium  
Iron

The following table gives a list of the Daily Reference Values (DRV) based on a 2,000-calorie diet.

Food Component	Daily Reference Values
Total fat	65 g
Saturated fat	20 g
Cholesterol	300 mg
Sodium	2,400 mg
Potassium	3,500 mg
Total carbohydrate	300 g
Dietary fiber	25 g
Protein	50 g

The percent DV is calculated by dividing the unrounded (actual amount) or rounded amount of the nutrient present in the food per serving by the established DRV and multiplying by 100, except that the DRV for protein must be calculated from the unrounded amount. The DV is expressed to the nearest whole percentage. The percentage of DV is mandated for total fat, saturated fat, cholesterol, sodium, total carbohydrates, and dietary fiber, and is voluntary for potassium and protein. There has been no DV set for trans fat and so a percentage of DV declaration should not be made.

Nutrient	RDI <sup>a</sup> Value
Vitamin A	5,000 IU
Vitamin C (ascorbic acid)	60 mg
Calcium	1,000 mg
Iron	18 mg
Vitamin D	400 IU

<sup>a</sup> Reference daily intake.

Depending on the size of the package, FDA allows different graphic formats for nutritional information. The most common is the Full Vertical format (see Fig. 4.1) used on all packages with greater than 40 in.<sup>2</sup> of available labeling space.



Full Vertical Format

<b>Nutrition Facts</b>	
Serving Size 1 cup (228g)	
Servings Per Container 2	
Amount Per Serving	
<b>Calories 260</b>	Calories from Fat 120
% Daily Value*	
<b>Total Fat 13g</b>	<b>20 %</b>
Saturated Fat 5g	<b>25%</b>
<i>Trans</i> Fat 2g	
<b>Cholesterol 30mg</b>	<b>10%</b>
<b>Sodium 660mg</b>	<b>28%</b>
<b>Total Carbohydrate 31g</b>	<b>10%</b>
Dietary Fiber 0g	<b>0%</b>
Sugars 5g	
<b>Protein 5g</b>	
Vitamin A 4%	• Vitamin C 2%
Calcium 15%	• Iron 4%
*Percent Daily Values are based on a 2,000 calorie diet.	
Your Daily Values may be higher or lower depending on your calorie needs.	
	Calories 2,000 2,500
Total Fat	Less than 65g 80g
Sat Fat	Less than 20g 25g
Cholesterol	Less than 300mg 300mg
Sodium	Less than 2,400mg 2,400mg
Total Carbohydrate	300g 375g
Dietary Fiber	25g 30g
Calories per gram:	
Fat 9	* Carbohydrate 4 * Protein 4

**Figure 4.1.** Full Vertical format for nutritional information used for packages with greater than 40 in.<sup>2</sup> of available labeling space.

Packages with less than 40 in.<sup>2</sup> of labeling space can use a smaller tabular format (see Fig. 4.2).

## SPECIAL LABELING REQUIREMENTS

Food labeling often has additional nonmandatory information used for marketing purposes. These are listed below:

### Real Seal

Dairy Management, Inc. has established a voluntary program to promote dairy products and to distinguish between authentic and simulated dairy products.

They have chosen the “REAL<sup>®</sup>” seal to indicate this distinction. Use of the “REAL<sup>®</sup>” seal must be in conjunction with the “REAL<sup>®</sup>” Seal Certified User Agreement. Information about the seal may be obtained at <http://www.dairyinfo.com>.

### Live and Active Cultures Seal

To help identify yogurt products that contain live and active cultures, the National Yogurt Association (NYA) has established a special *Live & Active Cultures* seal. The NYA is a national nonprofit trade organization whose purpose is to sponsor health and medical research for yogurt with live and active cultures and serve as an information source to the trade and the general public. The Live & Active Cultures seal, which appears on refrigerated and frozen yogurt containers, helps identify those products containing significant amounts of live and active cultures. The seal is a voluntary identification available to all manufacturers whose refrigerated yogurt contain at least 100 million cultures per gram at the time of manufacture, and whose frozen yogurt contains at least 10 million cultures per gram at the time of manufacture. Since the seal program is voluntary but not all yogurt products carry the seal. More information can be found at <http://www.aboutyogurt.com>.

### Kosher Symbols

Observance of the biblical kosher laws can be facilitated by kosher foods being certified by a rabbinical organization and labeled with an identifying symbol. The Jewish teachings written in the Jordon lists certain basic categories of food items that are not kosher. These include certain animals, fowl, and fish (such as pork and rabbit, eagle and owl, catfish and sturgeon) and any shellfish, insect, or reptile. In addition, kosher species of meat and fowl must be slaughtered in a prescribed manner and meat and dairy products may not be manufactured or consumed together. Kosher food labeling regulations are not preempted by the implementation of the NLEA and, therefore, state regulatory officials can enforce their own state regulations. Although FDA does not discuss the criteria by which these terms, “kosher” and “kosher style” may be used, they do indicate that these terms should be used only on products that meet the religious dietary requirements.

More information on kosher certification can be obtained by contacting the following organizations: the Union of Orthodox Jewish Congregations in New York at <http://www.oukosher.org> or the OK Kosher Certification at <http://www.okkosher.com>.

**Figure 4.2.** Tabular format for nutritional information used for packages with less than 40 in.<sup>2</sup> of available labeling space.

## Nutrition Facts

Serving Size 1/3 cup (56g)

Servings about 3

**Calories** 90

Fat cal. 20

\*Percent Daily Values (DV) are based on a 2,000 calorie diet

Tabular Format

Amount/serving	%DV*	Amount/serving	%DV*
<b>Total Fat</b> 2g	<b>3%</b>	<b>Total Carb.</b> 0g	<b>0%</b>
Sat. Fat 1g	5%	Fiber 0g	0%
<i>Trans</i> Fat 0.5g		Sugars 0g	
<b>Cholest.</b> 10mg	<b>3%</b>	<b>Protein</b> 17g	
<b>Sodium</b> 200mg	<b>8%</b>		
Vitamin A 0% = Vitamin C 0% = Calcium 0% = Iron 6%			

### Universal Product Bar Codes

The Uniform Code Council was originally created by the food industry in an effort to place a code and scanner-readable symbol on the package of containers sold through retail outlets using automatic checkout equipment. The primary purpose of the Universal Product Code (UPC) bar code system is to reduce retail store costs by providing an automatic computerized checkout system, to establish better inventory control and ordering systems, and to provide more valuable marketing information about products. A UPC manufacturer identification number for use in the bar code may be obtained by contacting the Uniform Code Council, Inc. in Dayton, OH, or Web site <http://www.uc-council.org>.

### Code Dating

Code dating, such as “sell by” or “best if used by” dating, is a requirement promulgated under the state regulations and laws and enforced by state regulatory officials. There are no federal regulations addressing code dating or “sell by” dating. Often a code date printed on the food label is used for tracking and identifying the food by the date of production, plant location, filling line, or production vat. This information may be used for inventory purposes, product rotation in storage, display, and, if necessary, retrieval from the market. Therefore, it is important that the code date or identifying information be legibly printed on each container and shipper.

### Food Warning Statements

FDA regulations require food warning statements to appear in the labeling of certain food products. For example, the regulations pertaining to the use of as-

partame in a food product require that the label state on either the principal display panel or the information panel the following: “Phenylketonurics: Contains Phenylalanine.”

## CODEX STANDARDS AND DEFINITIONS FOR FERMENTED MILK PRODUCTS

The Food and Agriculture Organization (FAO) and the World Health Organization (WHO) developed the Codex Alimentarius Commission—the body charged with developing a worldwide food code. All important aspects of food pertaining to the protection of consumer health and fair practices in the food trade have come under the Commission’s scrutiny, including international food standards, also known as Codex Standards. The Codex Web site lists more information on the Codex Alimentarius and official Codex Standards.

The *Codex Standard for Fermented Milk* (243-2003), recently updated in 2003, applies to all fermented milk including heat-treated fermented milks, concentrated fermented milks, and composite fermented milks (fermented milks with flavoring or other added nondairy ingredients) that are both directly consumed or used for further processing (see Table 4.2). The Codex fermented milk standard also provides that certain fermented milk must be characterized by specific starter cultures (Codex, 2004).

Concentrated fermented milk such as strained yogurt, Labneh, Ymer, and Ylette require that the protein be increased to 5.6%. Flavored fermented milk must contain not more than 50% (mass/mass) of nondairy ingredients, such as sweeteners, fruits, vegetables, juices, purees, cereals, nuts, spices, and other natural flavorings.

**Table 4.2.** Culture Characterization for Codex Standard for Fermented Milk

Yogurt	Symbiotic cultures of <i>Streptococcus thermophilus</i> and <i>Lactobacillus delbrueckii</i> subsp. <i>bulgaricus</i>
Alternate culture yogurt	Cultures of <i>Streptococcus thermophilus</i> and any <i>Lactobacillus</i> species
Acidophilus milk	<i>Lactobacillus acidophilus</i>
Kefir	Starter culture prepared from kefir grains, <i>Lactobacillus kefir</i> , species of the genera <i>Leuconostoc</i> , <i>Lactococcus</i> , and <i>Acetobacter</i> growing in a strong specific relationship. Kefir grains constitute both lactose fermenting yeasts ( <i>Kluyveromyces marxianus</i> ) and non-lactose-fermenting yeasts ( <i>Saccharomyces unisporus</i> , <i>Saccharomyces cerevisiae</i> , and <i>Saccharomyces exiguus</i> )
Kumys	<i>Lactobacillus delbrueckii</i> subsp. <i>bulgaricus</i> and <i>Kluyveromyces marxianus</i>

Note: Microorganisms other than those constituting the specific starter culture(s) specified above may be added.

Source: Codex Standard for Fermented Milk (243-2003).

Raw materials allowed in the Codex Standard for Fermented Milks are limited to milk and/or milk products obtained from milk and potable water used for reconstitution. Additional permitted ingredients include starter cultures and sodium chloride. Gelatin and starch are only allowed in heat-treated fermented milks, flavored fermented milks, and plain fermented milk if permitted by the regulations in the country of sale to the final consumer.

Composition requirements for various Codex Fermented Milks are listed in Table 4.3.

The microbial criteria apply to the fermented milk portion only for flavored fermented milks. Compliance to the microbial criteria is verified through analytical testing of the product through the end of the

shelf life on products that have been stored under normal conditions and temperatures.

Allowable food additives are specified in Table 4.4.

Labeling of the product is also specified by the Codex Standard for Fermented Milks. It allows for names to be replaced by designations such as Yogurt, Kefir, and Kuyums and provide for alternative spelling of the name to be appropriate in the country of retail sale. Additionally, the qualifying labeling terms “milk” or “tangy” can be used. If the fermented milk product is subject to heat treatment after culturing, it must be labeled as “Heat-Treated Fermented Milk”; unless the consumer would be misled by this name, the product shall be named as permitted by the regulations in the country of retail sale. Flavor

**Table 4.3.** Composition Requirements for Codex Standard for Fermented Milk

	Fermented Milk	Yoghurt, Alternate Culture Yoghurt, and Acidophilus Milk	Kefir	Kumys
Milk protein <sup>a</sup> (% m/m)	Min. 2.7%	Min. 2.7%	Min. 2.7%	
Milk fat (% m/m)	Less than 10%	Less than 15%	Less than 10%	Less than 10%
Titration acidity, expressed as % lactic acid (% m/m)	Min. 0.3%	Min. 0.6%	Min. 0.6%	Min. 0.7%
Ethanol (% vol./w)				Min. 0.5%
Sum of microorganisms constituting the starter culture defined in section 2.1 (cfu/g, in total)	Min. 10 <sup>7</sup>	Min. 10 <sup>7</sup>	Min. 10 <sup>7</sup>	Min. 10 <sup>7</sup>
Labeled micrororganisms <sup>b</sup> (cfu/g, total)	Min. 10 <sup>6</sup>	Min. 10 <sup>6</sup>		
Yeast (cfu/g)			Min. 10 <sup>4</sup>	Min. 10 <sup>4</sup>

<sup>a</sup> Protein content 6.38 multiplied by the total Kjeldahl nitrogen determined.

<sup>b</sup> Applies where a content claim is made in the labeling that refers to the presence of a specific microorganism (other than those specified in Table 4.2 for the product concerned) that has been added as a supplement to the specific starter culture. Source: Codex Standard for Fermented Milk (243-2003).

**Table 4.4.** Allowable Food Additives for Codex Standard for Fermented Milk

Additive Class	Fermented Milks		Fermented Milks Heat-Treated After Fermentation	
	Plain	Flavored	Plain	Flavored
Colors	—	X	—	X
Sweeteners	—	X	—	X
Emulsifiers	—	X	—	X
Flavor enhancers	—	X	—	X
Acids	—	X	X	X
Acidity regulators	—	X	X	X
Stabilizers	X <sup>1</sup>	X	X	X
Thickeners	X <sup>1</sup>	X	X	X
Preservatives	—	—	—	X
Packaging gases	—	X	X	X

*Note:* X = The use of additive belonging to the class is technologically justified. In the case of flavored products, the additive is technologically justified in the dairy portion; — = the use of additives belonging to the class is not technologically justified; and <sup>1</sup> = use is restricted to reconstitution and recombination and if permitted by national legislation in the country of sale to the final consumer.

*Source:* Codex Standard for Fermented Milk (243-2003).

designations and the term “sweetened,” if appropriate, shall also be included on the label. A declaration on milk fat content either in percentage or in grams per serving should be provided if the consumer would be misled by its omission.

## GLOSSARY

**ASEPTICALLY PROCESSED**—When used to describe a milk product, the product has been subjected to sufficient heat processing and packaged in a hermetically sealed container, to conform to the applicable requirements of the CFR and the Grade A PMO and to maintain the commercial sterility of the product under normal nonrefrigerated conditions.

**CERTIFIED COLORS**—Color additives manufactured from petroleum and coal sources listed in the CFR for use in foods, drugs, cosmetics, and medical devices.

**CFU/G (COLONY FORMING UNITS PER GRAM)**—An expression of measurement for determining the number of live microorganisms on a volume basis.

**CODEX ALIMENTARIUS COMMISSION**—An international body, created by FAO and WHO, to develop food standards, guidelines, and related texts such as codes of practice. The main purposes are protecting health of the consumers, ensuring fair trade practices in the food industry, and promoting

coordination of all food standards work undertaken by international governmental and nongovernmental organizations.

**COMMON OR USUAL NAME**—The name of a food that is not set by law or regulation, but either through common usage or through expert opinion (such as that of the FDA).

**DAILY REFERENCE VALUES (DRV)**—An amount set by the CFR as the recommended level of intake for certain nutrients (fat, saturated fat, cholesterol, total carbohydrate, fiber, sodium, potassium, and protein) based on a 2,000 calorie per day diet.

**FDA**—U.S. Food and Drug Administration.

**FFD&CA (FEDERAL FOOD DRUG AND COSMETIC ACT)**—An act of the U.S. Congress that specified the basis for food safety standards.

**GRADE “A” PMO (PASTEURIZED MILK ORDINANCE)**—Model milk regulations used for the inspection of milk production and processing facilities.

**HOMOGENIZATION**—The mechanical process of shearing milk fat globules via pressure to reduce the size of the fat globules and reduce the separation of the cream portion of the product.

**IDFA (INTERNATIONAL DAIRY FOOD ASSOCIATION)**—A trade association representing dairy processors that provides information and publications on dairy product regulations and standards.

**IU (INTERNATIONAL UNITS)**—A unit of measurement for certain vitamins (Vitamins A, D, and K) for labeling purposes.

**MSNF**—Milk solids nonfat portion of milk or milk products.

**PASTEURIZATION**—A process of heating fluid milk products to render them safe for human consumption by destroying the disease-producing organisms (pathogens). The process inactivates approximately 95% of all microorganisms in milk.

**TDI (REFERENCE DAILY INTAKE)**—A value set by the CFR as the recommended level of intake for vitamins and minerals essential for human nutrition for adults and children 4 or more years of age.

**REFERENCE AMOUNT (REFERENCE AMOUNT CUSTOMARILY CONSUMED)**—Values set by the CFR to reflect the amount of a particular food usually consumed per eating occasion by people 4 years of age or older, based on the major intended use of that food.

**TITRATABLE ACIDITY**—The measurement of the extent of growth of acid-producing bacteria by determining the lactic acid present in a food through reacting the lactic acid with a standard solution of alkali.

**UHT (ULTRA-HIGH TEMPERATURE)**—Heat treatment at a temperature of 135–150°C for a holding time of 4–15 seconds that sterilizes the product for aseptic packaging to permit storage at ambient temperatures.

## REFERENCES

- CFSAN (Center for Food Safety and Applied Nutrition). 2004. National Conference on Interstate Milk Shipments Model Documents—Milk Safety References [Online]. Available at <http://www.cfsan.fda.gov/~ear/p-nci.html>.
- CFSAN (Center for Food Safety and Applied Nutrition). 2004. Food Additive Inventory of Effective Notifications for Foods Contact Substances [Online]. Available at <http://www.cfsan.fda.gov/~dms/opa-fcn.html>.
- CFSAN (Center for Food Safety and Applied Nutrition). 2004. Everything Added to Food in the United States (EAFUS) [Online]. Available at <http://www.cfsan.fda.gov/~dms/eafus.html>.
- Code of Federal Regulations. 2004. Title 21 Food and Drugs [Online]. Available at <http://www.access.gpo.gov/cgi-bin/cfrassemble.cgi?title=200321>.
- Codex Alimentarius. 2004. Codex Standard for Fermented Milk (243-2003) [Online]. Available at [http://www.codexalimentarius.net/web/index\\_en.jsp](http://www.codexalimentarius.net/web/index_en.jsp).
- IDFA (International Dairy Foods Association). 2004. MIF Labeling Manual, 2004 Revision, MIF, Washington, DC.
- USDHHS (U.S. Department of Health and Human Services). 2003. Grade “A” Pasteurized Milk Ordinance, 2003 Revision, Department of Public Health, U.S. DHHS, Food and Drug Administration, Washington, DC.

## 5

# Basic Dairy Processing Principles

*Arun Kilara*

- Introduction
- Overview of Processing Equipment in a Dairy Plant
  - Fluid Transfer Operations
  - Heat Transfer Operations
  - Mixing Operations
  - Separation
  - Microbial Transformation
- From farm to Factory
- Storage of Raw Milk
- Centrifugal Operations
- Thermal Processing Systems
- Homogenization
- Membrane Technology
- Bibliography

## INTRODUCTION

Milk is a highly perishable biological fluid. The composition of milk and the factors that contribute to variability in the composition have been discussed in Chapter 2. Milk from many farms are collected in tankers two to three times a week and delivered to a processing facility. At this facility (also known as a dairy plant or factory) the milk is stored and processed further to make the appropriate products for which the dairy plant is designed for.

The safety of products is of major concern in dairy processing. Hence the regulations for the production and storage of milk at the farm, for the transportation from the farm to the factory, and for the holding and processing required on the factory premises have been promulgated, and these have been discussed in Chapter 3. Regulations also apply for standardized food products that have to meet compositional requirements as well as the use of approved ingredients and processes. These aspects have been discussed in Chapter 4. In addition, manufacturers of

products may have internal standards for insuring the quality of the products important to the consumer. Such attributes may include taste, texture, odor, flavor, mouthfeel, color, and keeping quality. These aspects are covered in detail in Chapters 1, 9, 14, and 15.

The processing steps may involve one or more operations in combination, and the most common operations involve pumping or transfer of fluids, heat transfer (cooling and heating), mixing of ingredients, separation (fat standardization), and microbial transformation of milk (acid gel formation). These aspects are discussed in the next section of this chapter.

## OVERVIEW OF PROCESSING EQUIPMENT IN A DAIRY PLANT

### FLUID TRANSFER OPERATIONS

Fluid transfer processes involve transferring milk from the receiving tankers to storage silos and then for further transfer to appropriate unit operations. These transfers are achieved by means of pumps. There are two main categories of these transfer agents used in the dairy industry called centrifugal and positive displacement pumps. Within each category there are different types of pumps.

The selection of the right type of pump for use in an operation is dependent upon a number of factors including flow rate, product to be handled by the pump, viscosity, density, temperature, and pressure in the system. Pumps should be installed as close to the tanks from which process liquids are being transferred with as few valves and bends in the line as feasible. Any devices to restrict flow should be placed at the exit or discharge side of the pump. Cavitation is a problem in pumping caused by too low a

pressure at the inlet end of a pump relative to the vapor pressure of the fluid being transferred. As cavitation progresses, pumping efficiencies decrease and eventually the pump ceases to transfer the fluid. The appropriate size of the pump required for the transfer depends upon flow rate and head, required motor power, and the net positive suction head. Engineers using charts and formulas easily calculate these parameters.

### Centrifugal Pumps

A motor drives an impeller that has vanes (Fig. 5.1). The motion is circular and the liquid being pumped enters to the center of the impeller that imparts a circular motion to the liquid. The liquid exits the pump at a higher pressure than the pressure at the inlet. Centrifugal pumps are useful for transferring liquids that are not very viscous. Because of the lower costs (when compared with positive displacement pumps), they are widely used in most applications in a dairy factory. These pumps are not suitable for high-viscosity liquids or those items requiring care in handling, for example fluids where structures should not be disturbed or ingredients whose identity is critical to product appeal. Flow control is achievable by three different means. The first is by throttling. This procedure is expensive but offers the greatest flexibility. The second means of achieving flow control is by changing the impeller diameter. This method is the most economical but the least flexible. A third means is to install an electronic speed controller, which is both economical and flexible.

### Positive Displacement Pumps

These pumps work on the principle of positive displacement in which in each rotation or reciprocating movement a finite amount of fluid is pumped regardless of the manometric head. The main types of positive displacement pumps have been called rotary and reciprocating pumps. These pumps are useful for higher viscosity fluids and at lower viscosities may exhibit some slip as the pressure increases. The net result is a reduction in volumetric flow on each stroke. Throttling by flow control valves at the discharge end of the pump should be avoided and these pumps have to be fitted with a pressure relief valve. Flow control in positive displacement pumps is achieved by controlling the speed of the motor or by adjusting the volume of reciprocating pumps. Positive displacement pumps must be placed as close to the feed tank as possible, and the diameters of the pipes should be large relative to those of centrifugal pumps. If pipe diameters are too small the pressure drop may be high enough to cause cavitation in the pump.

Positive lobe pumps generally have two rotors and on each rotor there are three lobes (Fig. 5.2). A vacuum is created when the lobes move causing the process fluid to be inspired into the cavities of the lobes. The process fluid is then moved along the outer walls of the pump toward the discharge end. The rotors are driven independently by a reducing gear motor. And the lobes do not touch each other or the walls of the pump casing. These pumps are used when the viscosity of the process fluid exceeds 300 cP, as is the choice for transferring cream and cultured products.

**Figure 5.1.** Centrifugal pump: (1) delivery line, (2) shaft seal, (3) suction line, (4) impeller, (5) pump casing, (6) back plate, (7) motor shaft, (8) motor, (9) stainless steel shroud and sound insulation. Reproduced with permission from Tetra Pak.

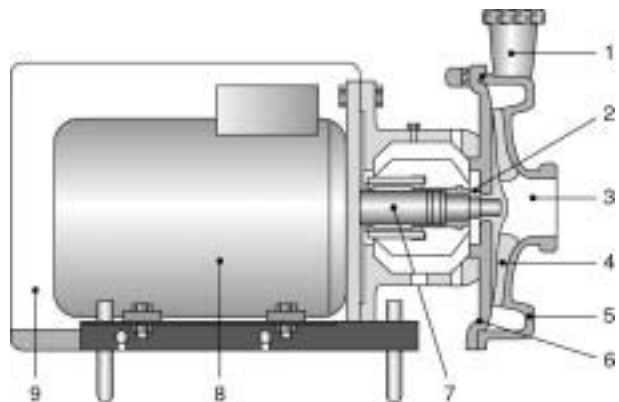



**Figure 5.2.** Lobe rotor principle. Reproduced with permission from Tetra Pak.

Eccentric screw, piston, and diaphragm pumps are also positive displacement pumps used for specialized purposes in dairy plants.

## HEAT TRANSFER OPERATIONS

Heating and cooling are two common operations in any dairy plant. Collectively these operations involve the transfer of heat from one medium to another. Transfer of heat can be routinely achieved through indirect contact of a hot medium against a cool medium. In the case of heating of dairy fluids, the hot medium is hot water. In the case of cooling, a cold medium removes heat from a dairy fluid. This cool medium may be incoming cold raw milk (as is the case of regeneration section of a pasteurizer) or chilled water. Boilers produce steam that is directly injected into the water and the result is hot water. Chilled water is produced by contacting water with a refrigerant (commonly ammonia in the United States). The apparatus in which heating or cooling takes place is generically called a heat exchanger.

Calculating the heat transfer area required for a particular operation is a complex process involving product flow rate, physical properties of the fluid being heated and the heating medium, temperature program necessary for the operation, allowed pressure drops, design of the heat exchanger, sanitary requirements, and necessary operational time. The product flow rate depends on the operating capacity of the dairy factory. Density, specific heat, and viscosity are

important parameters defining the physical properties of the fluids. Temperature program is dependent on the legal requirements and temperature differentials between the medium being heated and the heating medium. Temperature changes (often referred as  $\Delta t$ ) depend upon the inlet temperatures of the medium being heated and the heating medium. Design of the heat exchanger refers to the flow of the fluid being heated in relation to the flow of the heating medium. Such flows can be countercurrent (Fig. 5.3) or concurrent (Fig. 5.4), meaning the fluid being heated flows against the flow of the heating medium or in the same direction as the heating medium, respectively. Design also refers to the physical nature of the heating apparatus and can be done by using plate heat exchangers or tubular heat exchangers and in some cases scraped surface heat exchangers. The ability to effectively clean and sanitize food contact surfaces is vital in the food industry and therefore the design of a heat exchanger has to take this into consideration. The necessary operational time is the length of time for which the equipment can be operated without cleaning and is dependent on a number of factors. The operational time cannot be predicted and will vary from factory to factory.

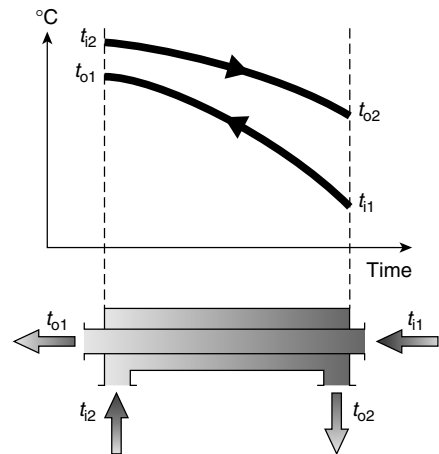

**Figure 5.3.** Temperature profile for a product in a countercurrent heat exchanger. Red Line/ fill is the heating medium and Blue line/ fill is the product flow.  $t_i$  is inlet temperature and  $t_o$  is outlet temperature. Subscripts 1 and 2 refer to product and heating medium, respectively. Reproduced with permission from Tetra Pak.



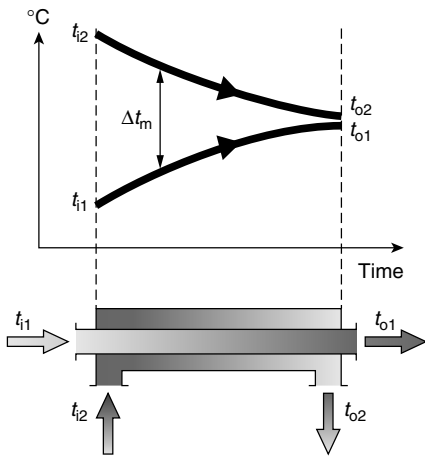

**Figure 5.4.** Heat transfer in a concurrent heat exchanger. Red line/fill indicates heating medium and blue line/fill indicates product.  $t_i$  is inlet temperature and  $t_o$  is outlet temperature. Subscripts 1 and 2 represent product and heating medium, respectively. Reproduced with permission from Tetra Pak.

Another aspect of cooling involves refrigeration. Refrigeration involves the removal of heat from a product and in this process the product cools down and the medium removing the heat warms up. In the

dairy industry, refrigeration is commonly achieved by chilled water or polyethylene glycol in some cases. The water is chilled by contacting it with a refrigerant such as ammonia or other fluorocarbon gases.

## MIXING OPERATIONS

In the manufacture of many dairy products, certain ingredients have to be mixed into milk. For example, in the manufacture of flavored milks, sweeteners, stabilizers, and flavorings are added to milk prior to processing. To fortify solids in certain types of yogurts, milk solids are added to milk prior to pasteurization. In other instances storage of raw milk in silos necessitates periodic agitation of the contents of the silo. In batch pasteurization, the milk is heated in a tank and the tank has an agitation system to insure uniform heat transfer. In all these instances mixing is required and is achieved by a number of means.

For the incorporation of solid ingredients into milk, batch and continuous processes are available. The simplest batch blending system is a funnel or hopper to feed the dry material to a closed-circuit circulation of the process fluid. A centrifugal pump is involved in circulation of the process fluid (Fig. 5.5).

The tank is filled with the process fluid and circulation is initiated. The centrifugal pump can be placed

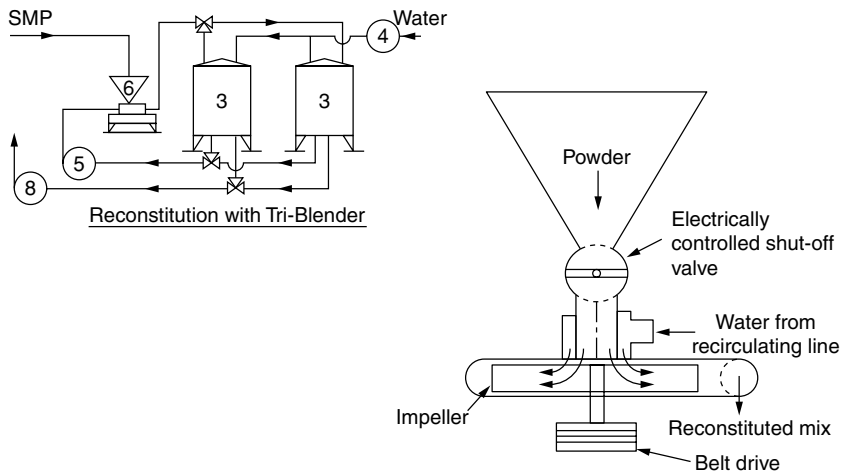

**Figure 5.5.** Mixing dry ingredients using a triblender.

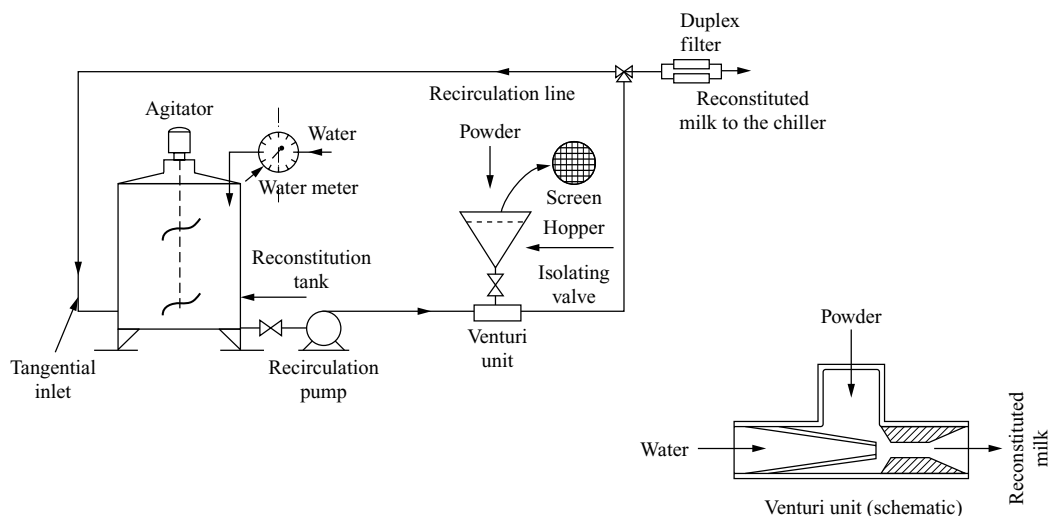

**Figure 5.6.** Reconstitution in a system with a venturi, with the dry ingredients being added at the discharge side of the pump.

at either the suction or the discharge side of the hopper. If the hopper is on the suction side of the pump rapid dispersal of powders are efficiently achieved as a result of the mixture of powder and fluid coming in contact with the impeller of the pump. The disadvantage is that frequent blockages may occur in the hopper. If the hopper is placed on the discharge end of the pump the problem of blockage is avoided. This configuration requires the presence of a venturi to facilitate the mixing of powder and the process fluid (Fig. 5.6).

Another type of batch mixing occurs in tanks and silos. The tanks are equipped with agitators. The agitator systems can be paddle, propeller, and scraped surface. The agitators can be positioned at the top or bottom, perpendicular or centrally mounted. Besides these factors, the speed of agitation, tank geometry, vortex creation, air incorporation, and shearing effects impact on the mixing efficiency.

In continuous mixing systems, also called in-line mixers, many types of devices are available. In blenders such as Tri-Blender and Breddo Likwifier, a high-speed blender, the powder and process liquid are contacted and sheared in the mixer. Another in-line mixer is Silverson. This mixer operates at high speeds and its action is somewhat similar to homogenization.

## SEPARATION

It is necessary to separate the fat from the milk. Principles used to separate fat from milk are also applied to remove fine extraneous material from milk and to reduce the bacterial content of milk. Separation of fat from milk is called cream separation, the removal of fine extraneous particles is termed clarification, and the reduction in microbial numbers is obtained through bacterofugation. All of these processes rely on centrifugal force to achieve their objective. The factors that affect the efficiencies of these processes are diameter of the particle ( $d$   $\mu\text{m}$ ), density of the particle ( $\rho_p$   $\text{kg}/\text{m}^3$ ), density of the continuous phase ( $\rho_1$   $\text{kg}/\text{m}^3$ ), viscosity of the continuous phase ( $\eta$   $\text{kg}/\text{ms}$ ), and the gravitational force ( $g = 9.81 \text{ ms}^{-2}$ ). For example a 3- $\mu\text{m}$  diameter fat globule will rise at a velocity of 0.6 mm/h. To speed up this process centrifugal force is applied and the sedimentation velocity is increased 6,500-fold. In order to achieve this separation under a centrifugal force field, a specially designed equipment called a cream separator is used.

Another centrifugal operation in the dairy industry is a variant of cream separation and is used to remove solid impurities from milk. This piece of equipment is called a clarifier. The principal difference between clarification and separation is in the design of the

disc stack in the centrifuge bowl and the number of outlets. In a clarifier the disc stack has no distribution holes and has only one outlet. In a separator the disc stack has distribution holes and there are two outlets, one each for cream and skim milk.

A third application of centrifugal force in dairy processing is bacto-fugation. This is a process in which centrifugal force is used to reduce the bacterial content of milk. Spore formers are effectively reduced by this process. It is more commonly used in treating milk for milk powder and cheese manufacture.

## MICROBIAL TRANSFORMATION

Among the methods of preserving milk are drying, condensing, and fermentation. Fermentation is the controlled acidification of milk and cream. By controlled acidification, it is meant that the type of microorganisms growing and the conditions for their growth are carefully monitored and stopped. The characteristics of the microorganisms used in fermenting milk and cream are discussed in greater detail in Chapter 6. Here the main concepts of this transformation are outlined. Lactic acid bacteria are the prime agents of fermentation. Morphologically these are rods and cocci. They stain Gram positive. The optimal temperatures for their growths are either in the mesophilic range (20–30°C) or thermophilic range (35–45°C). Lactic acid bacteria utilize lactose to produce lactic acid. The transport of lactose into the cells is facilitated by two enzyme systems; first the phosphoenol pyruvate dependent phosphotransferase system while the second mode of lactose transport into the cell is via an ATPase-dependent system. Lactic acid bacteria are also classified as homofermentative or heterofermentative. Production of lactic acid only from lactose, as is the case with most mesophilic lactic acid bacteria, leads to such bacteria being labeled homofermentative. One molecule of lactose results in four molecules of lactic acid. Heterofermentative lactic acid bacteria including *Leuconostocs* lack the enzymes called aldolases and cannot ferment lactose via the glycolytic pathway. This class of bacteria ferments one molecule of lactose to two molecules each of lactic acid, ethanol and carbon dioxide. Homofermentative lactic acid bacteria do not produce ethanol or carbon dioxide. Heterofermentative lactic acid bacteria do. Lactic acid production is not the only change taking place in milk during fermentation. Caseins are also being modified by proteolytic enzymes; others may produce polysaccharides, which

can alter the viscosity of the milk. Some lactic acid bacteria metabolize citric acid to produce aroma volatiles such as diacetyl.

Fermentation of milk is necessary for the manufacture of yogurt, buttermilk, kefir, and cheese, while the fermentation of cream is essential for the manufacture of sour cream, cream cheese and other types of cheese, and for the manufacture of cultured cream butter. Some of these aspects are discussed in greater detail in other chapters (Chapters 11, 12, 16, 17, and 18). With these basic operations understood, the next sections will describe the milk processing steps commonly employed.

## FROM FARM TO FACTORY

Milk production on the farm is done under strict guidelines that determine its grade (see Chapter 3). In 2002 the total milk production in the United States was 75.47 billion kilograms (170 billion pounds). Farms with 200–500 milch animals accounted for approximately 17.5% of the total milk produced. Farms with 50–100 cows and >2000 cows accounted for 17.4% and 15% of the total milk production, respectively. Also in 2002, 9.14 million cows were tended by 91,900 production units, which means an average of 99 cows per farm. The general trend in this area is toward less number of farms with larger herd sizes.

Farms use milking parlors of various designs and the milking interval is unequal. Cows are milked twice a day, with a small minority milking three times a day. The milk from each animal is weighed and then mixed with milk from other animals in the batch of cows being milked. Milk temperature immediately after milking is approximately at the body temperature of the cow (38°C/101°F). At this temperature many mesophilic microorganisms can grow and therefore to minimize microbial growth the warm milk is cooled rapidly. Cooling is commonly achieved by plate heat exchangers. Milk is thus collected in insulated tanks called farm bulk milk tanks. Milk from several days of milking is collected in this tank (Fig. 5.7).

As the number of cows in the herd grows and the number of dairy farms shrinks, milk collection occurs more frequently on the farm. For example, in an Arizona dairy farm milking 7,000 cows two times a day dispatches a tanker every 45 minutes to their dairy. Smaller farms may use ice bank building tanks. For achieving the best grade of milk (Grade A), milk has to be cooled to below 4°C (40°F) within time

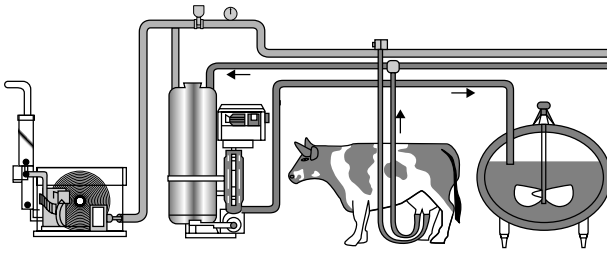

**Figure 5.7.** Milk from the cow is measured in-line and then sent to a bulk cooling tank. Reproduced with permission from Tetra Pak.

limits, e.g., 2 hours post-milking. For further details refer to Chapter 3.

At the time of collecting the milk, the tanker driver obtains a sample for milk from each farm. This sample is the basis for quality determination and for payment based on milk composition.

The tanker itself is made of sanitary stainless steel and is fitted with baffles to prevent milk from being vigorously shaken during transportation. Thus, churning of milk and the possibility of churning the cream into butter are avoided. At the back end of the tanker is a pump with a volumetric meter and an air-eliminating device. The tanker pulls up to the milk shed and the driver attaches a sanitary hose to the farm milk storage tank and pumps the milk from the storage tank to the milk transport tanker (Fig. 5.8).

When the farm bulk tank is empty the pump is turned off to prevent air from mixing with milk in

the tanker. Presence of air can cause foaming and churning of milk. When the tanker has collected milk from several farms and is full it arrives at the dairy factory.

### STORAGE OF RAW MILK

Upon arrival of the milk tanker at the dairy, it enters a covered special reception area. A technician from the quality assurance department checks the temperature of the milk and draws a representative sample. During this procedure, the technician also checks the odor of the milk and records if any off-odors are detected. The representative sample collected from each tanker is analyzed for sediments, antibiotic residues, somatic cell count, bacteria count, protein and fat content, and freezing point. Some dairies may also conduct a direct microscopic count of the bacteria present in



**Figure 5.8.** Collection of milk on the farm. The tanker is pumping milk from the farm bulk milk tank for transport to the dairy factory. Reproduced with permission from Tetra Pak.

milk. The normal bacteria count and Coliform count take 24–48 hours. The results of the remaining tests are available within 15–20 minutes. If all tests meet standards set by the dairy, the milk is then unloaded from the tanker.

The significance of the reception dock tests is as follows. Sediment tests point to the quality of milk production at the farm. Antibiotic tests indicate if milk from sick animals were commingled with milk from healthy cows. If such commingling occurs the entire tanker load of milk is rejected. Presence of antibiotics in milk poses a 2-fold danger. First, antibiotic-sensitive individuals can suffer from consuming tainted milk. Second, in the manufacture of cultured milk products, the presence of antibiotics may pose a barrier for acidity development by inhibiting the starter culture growth. Somatic cell counts are indicative of general animal health. If they are <500,000 per milliliter of milk the animal herd health is considered good. If however, the count exceeds 1,000,000 per milliliter it suggests the presence of mastitis in one or more animals in the herd. Mastitic cows are often treated with antibiotics and while receiving the treatment and for a period after the treatment the milk from such animals is generally discarded on the farm. Protein and fat contents are used to determine payments and to gain full accounting of raw materials received. This is important for material balance calculations and for determination of losses occurring during processing and packaging. Freezing point of milk is another important test to determine adulteration with water, whether accidental or intentional. Adulteration of milk is a prosecutable offence.

The most common procedure is to record the volume of milk delivered by a tanker. However, in some dairies the tanker may be weighed prior to emptying and after discharging its load. Volumetric measurements involve a volumetric flow meter fitted with an air eliminator. Presence of air can distort readings of the volume of milk. The milk passes through the air eliminator and a filter into the metering device prior to going to storage silos.

The tanker after discharging its load of milk is cleaned in the reception bay or in a special cleaning bay. The inside of the tanker is washed by a cleaning-in-place system, which rinses the tanker, cleans it with detergents, and rinses the detergent followed by sanitizing the tanker. While the inside of the tanker is being cleaned, the exterior is also often washed so that the tankers always look clean on the road. After cleaning and sanitizing, the tanker goes to its next round for milk collection.

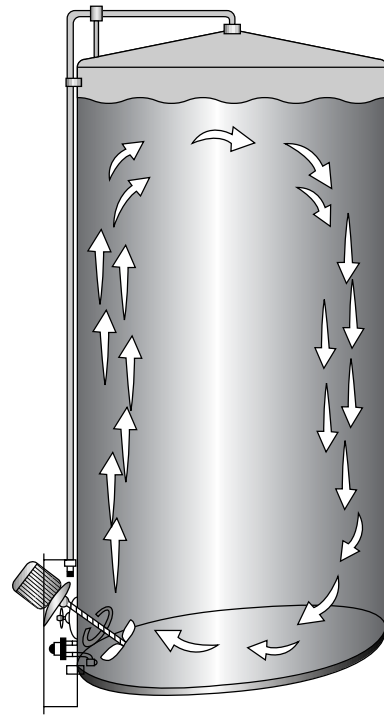

**Figure 5.9.** Schematic of a milk silo with a propeller agitator. Reproduced with permission from Tetra Pak.

The raw milk is stored in large vertical tanks known as silos (Fig. 5.9). These silos can have capacities of 25,000–150,000 liters (6,000–37,000 U.S. gallons). The silos are placed outside the dairy with an inside outlet bay. The silos have a double-wall construction with an outside welded sheet metal within which a stainless steel tank is contained. The silos have methods of agitating milk so as to prevent gravitational fat separation.

The agitation must be very smooth to avoid rupture of the milk fat globule membranes, which can cause lipolysis of milk fat. Lipolysis generates off-flavors and odors. The most common agitation system is to use a propeller agitator. In the tanks there are instruments that include a thermometer, level indicator, low level protector, overflow protector, and an empty tank indicator. Modern dairies have electronically transmitted data on temperature, levels of milk in the silos, and the protection devices. Redundant visual (nonelectronic) systems may also be employed in some dairies.

Milk storage silos are cleaned in place and visual inspections of the interior surfaces for any problems are also conducted periodically. Since silos are considered to be confined spaces, entry into a silo has to be strictly according to the standards recommended by the Occupational Safety and Health Administration of the U.S. Government.

The temperature of the milk in the silo has to be maintained at 4°C or below (<40°F). Even at these temperatures psychrotrophes can cause proteolysis and lipolysis if milk is stored for long periods of time. Therefore, it is recommended that the silos be emptied and cleaned and sanitized at regular intervals. The raw milk in the silo is further processed and the main elements in the processing are centrifugal operations, thermal treatment, homogenization, cooling, and packaging.

## CENTRIFUGAL OPERATIONS

Centrifugal operations deal with removing some or most of the fat, a step called standardization. One method of standardization is to completely remove all the fat as cream leaving skim milk, then the cream and skim milk can be recombined in desired ratios to obtain low, light, and whole milk with 1%, 2%, and 3.25% fat, respectively. More often this standardization is performed in a continuous manner.

The separation of cream from milk is achieved in a cream separator. Often the separator has the ability to remove sediments from milk as well as separate the cream from milk. Depending on the design of the separator/clarifier, the sediment collected can be manually or automatically removed. Typically milk can have 1 kg of sediment per 10,000 liters (1 lb/1,100 U.S. gallons). Automatic discharging separators/clarifiers are hermetically sealed and are cleanable in place. This is less cumbersome than opening up the bowl assembly and cleaning manually both the sediment and the disc stacks of a separator.

Control of fat content in the cream is possible by a paring disc in conjunction with a cream flow meter. A throttle valve at the cream discharge side controls the volume of cream leaving the separator. This is counterbalanced by controlling the pressure of the skim milk outlet and is dependent on the make of the separator and the throughput of the separator.

In paring disc separators the volume of cream discharged is controlled by a cream valve with a built-in flow meter (Fig. 5.10). The size of the valve aperture is controlled by a screw and the throttled flow passes through a graduated glass tube with an indicating

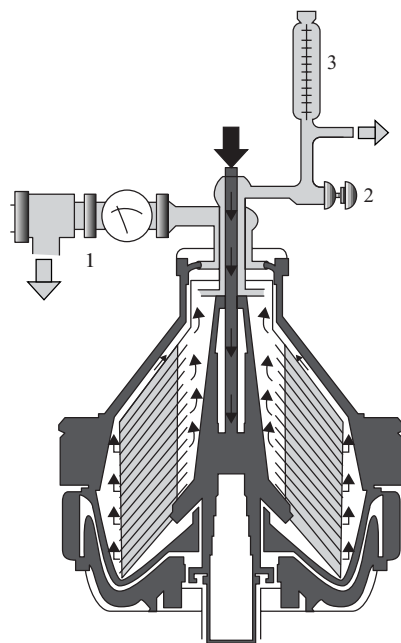

**Figure 5.10.** Paring disc separator with manual controls. (1) Skim milk outlet with regulator, (2) cream throttling valve, (3) cream flow meter. Reproduced with permission from Tetra Pak.

device. The art of balancing the cream flow and the skim milk pressure leads to obtaining the desired fat content in the cream.

In the more common hermetically sealed separators, milk is supplied to the bowl through the bowl spindle. It is accelerated to the same speed as the rotation of the bowl and continues through the distribution holes in the disc stack. The bowl of a hermetic separator is completely filled with milk during operation. There is no air in the center, hence the name hermetic separator. It is a part of the closed piping system of the dairy. The pressure generated by the external product pump is sufficient to overcome the resistance to flow through the separator to the discharge pump at the cream and skim milk outlets.

An automatic constant pressure unit in a hermetic separator is controlled by a diaphragm valve. The pressure on the valve is controlled by compressed air above the diaphragm (Fig. 5.11).

Direct in-line standardization of the fat content of milk is based on the principle of keeping the pressure

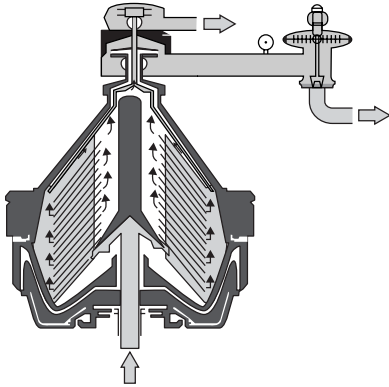

**Figure 5.11.** Hermetic separator bowl with an automatic pressure unit on the skim milk outlet. Reproduced with permission from Tetra Pak.

of the skim milk constant. This pressure has to be maintained regardless of flow fluctuations or pressure drop caused by the equipment after separation. This is done by a constant pressure valve at the skim milk discharge side of the separator. Precision standardization is also dependent upon fluctuations in fat content of the incoming milk, in throughput, and in preheating temperatures. Centrifugal operations may also be used in some countries for the manufacture of cultured dairy products. In yogurt manufacture, skim milk (with 0.05–0.1% fat content) or milk having different fat contents (1%, 3.25%, etc.) is often used and in the more indulgent types of yogurt, milk having higher fat contents up to 8% may be used. All these different fat contents are arrived through centrifugal operations involving standardization

on-line. A schematic of an in-line standardization unit is shown in Figure 5.12.

Separation temperature is also an important variable. Cold separation of milk (<4°C or 40°F) decreases the efficiency of fat recovery. Therefore, commonly, warm separation is used where the efficiency of fat removal is greater because the fat is in a fluid state at temperatures of around 50°C (122°F). Warming of the milk can take place during the regeneration phase of heat transfer (see below).

## THERMAL PROCESSING SYSTEMS

The standardized milk is thermally processed as required by law. This treatment renders the milk free from pathogens. The term pasteurization describes this process. Pasteurization can be a batch process or a continuous process. Batch processes are used by small processors and is not common in modern dairies. The batch process is called Long Time Low Temperature (LTLT) pasteurization. In this process, standardized milk is heated to 62.5°C (145°F) and held at that temperature for 30 minutes. The processing tanks used for such purposes should have certain characteristics defined in the Pasteurized Milk Ordinance (PMO). Homogenization takes place post-pasteurization, followed by cooling. Homogenization may also take place after the regeneration section and prior to entering the heating section. If the temperature of the milk is around 40°C (104°F), lipolysis can be enhanced by homogenization. Therefore, homogenization temperature has to be above 45°C (113°F). At this temperature milk lipase and many microbial lipases are rendered ineffective.

**Figure 5.12.** The complete process for in-line standardization of milk and cream. (1) Density transmitter, (2) flow transmitter, (3) control valve, (4) control panel, (5) constant pressure valve, (6) shut-off valve, and (7) check valve. Reproduced with permission from Tetra Pak.

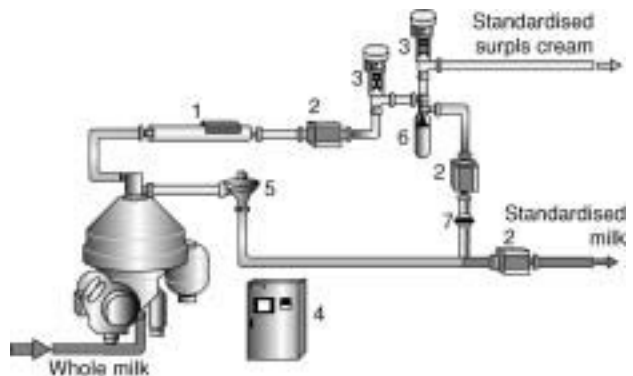

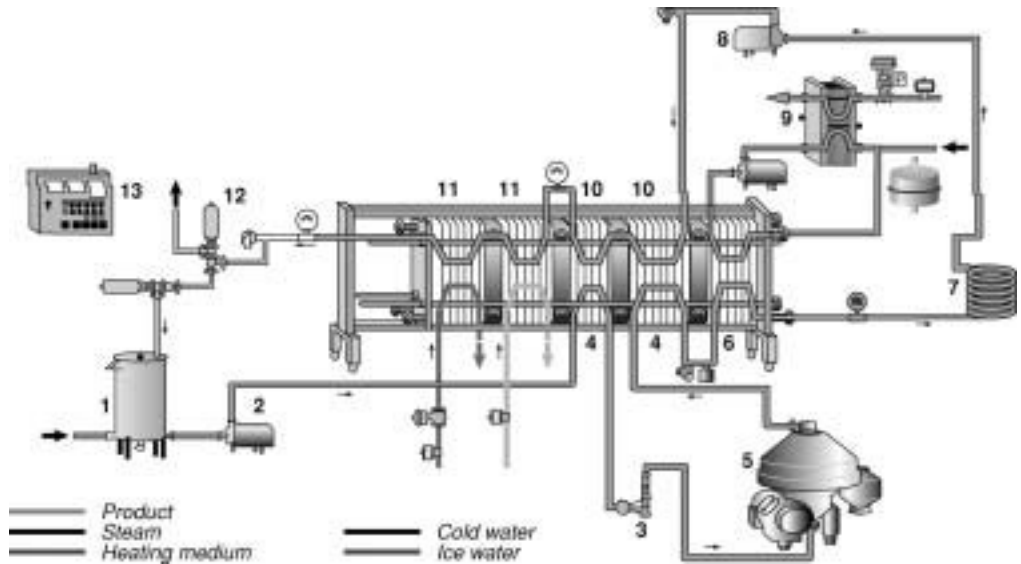

**Figure 5.13.** A complete pasteurizer plant. (1) Balance tank, (2) feed pump, (3) flow controller, (4) regenerative preheating sections, (5) centrifugal clarifier, (6) heating section, (7) booster pump, (8) holding tube, (9) hot water heating, (10) regenerative cooling sections, (11) cooling sections, (12) flow diversion valve, (13) control panel, A. temperature transmitter, B. pressure gauge. Reproduced with permission from Tetra Pak.

The continuous pasteurization process is termed High Temperature Short Time Pasteurization (HTST) and entails heating milk to 71.5°C (161°F) and holding the milk for a minimum time of 15 seconds prior to cooling and storage. Yogurt manufacture necessitates the holding of milk for longer periods of time in order to denature the whey proteins and thus improve the gel strength of yogurt. Therefore, in yogurt manufacture milk may be held at 71°C for 30 minutes or it may be heated to 90°C (194°F) and held for 10 minutes (see Chapters 11 and 12 for further details). The HTST process involves plate heat exchangers and the PMO has prescribed various controls and requirements for the equipment.

The effect of heat treatment on milk is to reduce the rate of deterioration due to microbial and enzymatic action. In addition, the milk may look whiter and appear more viscous, with appreciable flavor changes and a decrease in nutritive value. The effectiveness of pasteurization is estimated by assaying for an enzyme called phosphatase. In fresh properly pasteurized milk, no phosphatase activity is detected. Upon storage sometimes microbial phosphatases or the milk phosphatase itself can regain some of its activity. If the presence of phosphatase is detected in

stored pasteurized milk, further tests are often conducted to determine the cause of this positive test.

In the HTST pasteurization process (Fig. 5.13), cold milk enters a balance tank with a float valve. The purpose of the balance tank (also known as a constant level tank) is to maintain a constant level of milk in the plate heat exchanger as the pasteurizer should be filled at all times during operation to prevent the product from burning onto the plates. The balance tank may be fitted with an electronic sensor that transmits a signal to the flow diversion valve. If the level in the balance tank goes below a certain level and fresh milk is not coming in to raise the level, this electrode transmits a signal for the flow diversion valve to open and to return the milk in the system to the balance tank. The milk is replaced by water if circulation has continued for a certain predetermined time.

Milk is pumped from the balance tank to the plate heat exchanger. The pump is fitted with a flow controller to ensure that a constant flow is maintained at a predetermined value. This value is dependent on the characteristics of the pump and the heat exchanger capacity. The flow control device also guarantees a stable temperature and constant length of holding.



The flow control device may also be located after the first regeneration section.

Regenerative preheating is an energy-saving step in pasteurization. Cold untreated milk is heated by the outgoing pasteurized milk. Thus, cold milk is preheated and the hot milk is cooled simultaneously. The regeneration section is divided into two sections. After the cold milk is preheated in the first regeneration section, it is separated and homogenized and then the standardized, homogenized milk enters the second regeneration section where it is further heated by the hot pasteurized milk. Heating is accomplished by using hot water as the medium. The hot water, in turn, is produced by injecting culinary steam into the water. The steam is generated in boilers of the dairy factory.

After this regeneration section the milk enters the pasteurization section where it is heated to the required temperature. The heated milk exits the heating section and enters an external holding tube. The flow rate of hot milk determines the residence time in this holding tube. The flow rate in turn is controlled by the flow controller referred to earlier. After the transit through the holding tube the exiting milk temperature is measured and transmitted to a temperature controller and a recording chart.

A sensor at the exit of the holding tube transmits a signal to the temperature monitor. As soon as the temperature falls below a preset minimum value the monitor switches the flow diversion valve to "diverted flow." In diverted flow, the hot milk returns to the balance tank as it is not considered pasteurized. The reason for the fluctuation is determined and corrected and if the correct temperature is maintained at the exit point of milk from the holding tube, further flow is continued past the flow diversion valve. Often a booster pump may be added after the milk exits the holding tube. The hot pasteurized milk enters the regeneration section of the pasteurizer to heat the incoming raw milk.

In the regeneration section unpasteurized milk flows on one side of the plate and hot pasteurized milk flows on the other; if there are pinholes in the plates of the heat exchanger, unpasteurized milk can commingle with pasteurized milk. This violates the integrity of the pasteurized milk and the fluid is not considered pasteurized. To avoid such a problem, the pasteurized milk is always at a higher pressure than the raw milk. To measure the pressures a pressure differential meter is often installed on the control panel. If the pressure differential between raw and pasteurized milk drops below a preset value, a signal is sent

to the flow diversion valve to open. Therefore, two different causes for flow diversion are temperature falling below preset values and the pressure differential between raw and cold milk falling below a certain preset limit. The milk is not considered pasteurized if either of these events occurs. For milk to be designated as pasteurized, every drop of milk has to be heated to and held at the specified minimum temperature for a specified amount of time.

Pasteurized milk in the regeneration section is cooled giving off its heat to the cold incoming raw milk. This cools down the milk but not to the desired 4°C (40°F) or below. The final step in pasteurization is to cool the milk to below 4°C in the cooling section. Cooling is achieved by chilled water or cold glycol as the refrigerant. The water is chilled by a refrigeration system that commonly uses ammonia as the refrigerant. Other hydrocarbons may also act as refrigerants. Since the pasteurized milk transmits considerable heat to the cold raw milk, less refrigeration capacity is required to cool the milk to below 4°C.

In yogurt manufacture the cooling system may not be used. Once the pasteurized milk has been cooled to around 43–45°C it may be pumped to the fermentation tanks for further processing. It is obvious that reheating cold pasteurized milk to the incubating temperatures of 43–45°C will require a greater consumption of energy than avoiding this step in the first place.

## HOMOGENIZATION

Homogenization is a process of reducing the size of fat globules. Homogenization prevents creaming (separation of a fat enriched layer from the aqueous phase). Reduction in the globule size is achieved through a combination of turbulence and cavitation. The apparatus in which such particle size reduction occurs is called a homogenizer.

Cold milk cannot be homogenized efficiently because the milk fat still is solid. Therefore, homogenization occurs best at temperatures greater than 37°C (99°F). Another necessity for efficient homogenization is the presence of protein. A suggested minimum value of 0.2 g of casein per gram of fat is recommended.

Homogenizers are manufactured as single-stage and dual-stage machines. In single-stage homogenization the whole pressure drop is used over one device. It is used for products with low fat content and in products requiring a high viscosity (e.g., sour cream, coffee cream, whipping cream). Dual-stage

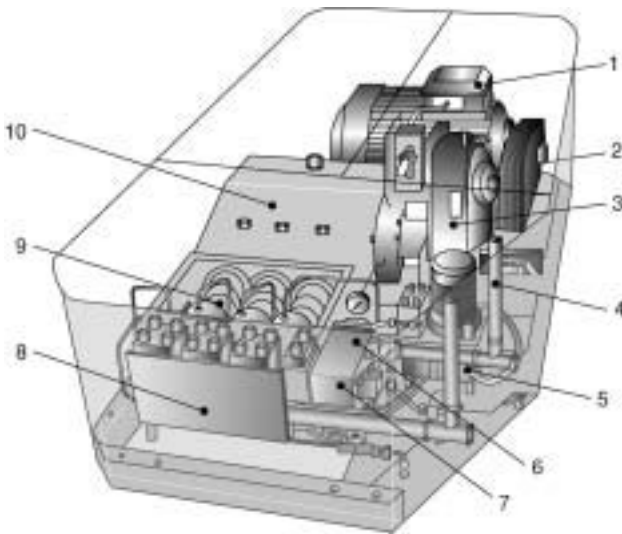

**Figure 5.14.** The homogenizer is a large high-pressure pump with a homogenizing device. (1) Main drive motor, (2) V-belt transmission, (3) gear box, (4) damper, (5) hydraulic pressure setting system, (6) homogenizing device, second stage, (7) homogenizing device, first stage, (8) solid stainless steel pump block, (9) pistons, (10) crank case. Reproduced with permission from Tetra Pak.

homogenizers are used in breaking down the fat globule in two stages. This is effective for products with high fat content, high solids content, or for products where low viscosity is desired (Fig. 5.14).

The effects of homogenization are smaller fat globule size (prevention of creaming), whiter and more appetizing color, reduced sensitivity to fat oxidation, and a fuller bodied flavor and mouthfeel. In cultured milk products a better stability is also achieved. Homogenizers are high-pressure machines in which reciprocating pistons create the pressure. Pressurized milk is passed through a narrow aperture. When the pressurized milk exits into atmospheric pressure cavitation is created, which results in large fat globules being reduced to smaller ones. The narrow aperture

is called the homogenizer valve. There are many designs for the homogenizer valve all of which have a similar effect on the fat globule (Fig. 5.15).

When a large fat globule is disintegrated to a number of small droplets, a tremendous increase in surface area of the fat occurs. Onto the surfaces of these newly created droplets casein adsorbs and stabilizes the droplet. If this step does not occur, the fat droplets could recombine to form a larger globule. The adsorption time has been estimated to be around  $0.25 \mu\text{s}$ , the encounter time between the protein and fat is estimated to be  $0.15 \mu\text{s}$ , and the deformation time is around  $0.3 \mu\text{s}$  for 4% fat milk being homogenized at 20 MPa. In this process, the average fat globule diameter of  $9 \mu\text{m}$  for 4% fat milk is reduced to

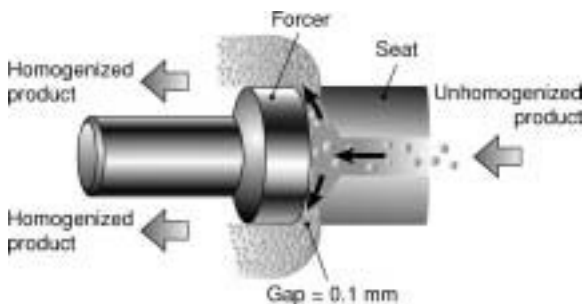

**Figure 5.15.** The milk is forced through a narrow gap, which results in the fat globules splitting into smaller sized droplets. Reproduced with permission from Tetra Pak.

1.6  $\mu\text{m}$ . The protein that is adsorbed onto the newly formed surfaces is casein. Approximately 75% of the surface area is covered with casein. Larger micelles are preferentially adsorbed over smaller ones. Protein adsorption is greatest on smaller globules. The surface concentration of protein has been measured at 10  $\text{mg}/\text{m}^2$ .

Single-stage homogenization uses only one stage to reduce the fat globule size. In dual-stage homogenization two stages for pressure reduction are used. First a low-pressure treatment is followed by a second higher pressure treatment. A two-stage homogenizer is useful with low-viscosity fluids.

## MEMBRANE TECHNOLOGY

Membrane technology is useful in selectively enriching certain components. Membrane technology

consists of four distinct processes. Reverse osmosis (RO) is useful in concentrating solids by removal of water. Nanofiltration (NF) can concentrate organic components by removal of monovalent ions like sodium and chloride thereby resulting in demineralization. Ultrafiltration (UF) is the process in which macromolecules are concentrated. The major macromolecules in milk are fat and proteins. The fourth membrane process is microfiltration (MF). This process removes bacteria and it can also separate macromolecules.

These techniques utilize cross flow membrane in which the feed solution is forced through the membrane under pressure (Fig. 5.16). The solution flows over the membrane and solids are retained (retentate) while the removed materials are present in the permeate.

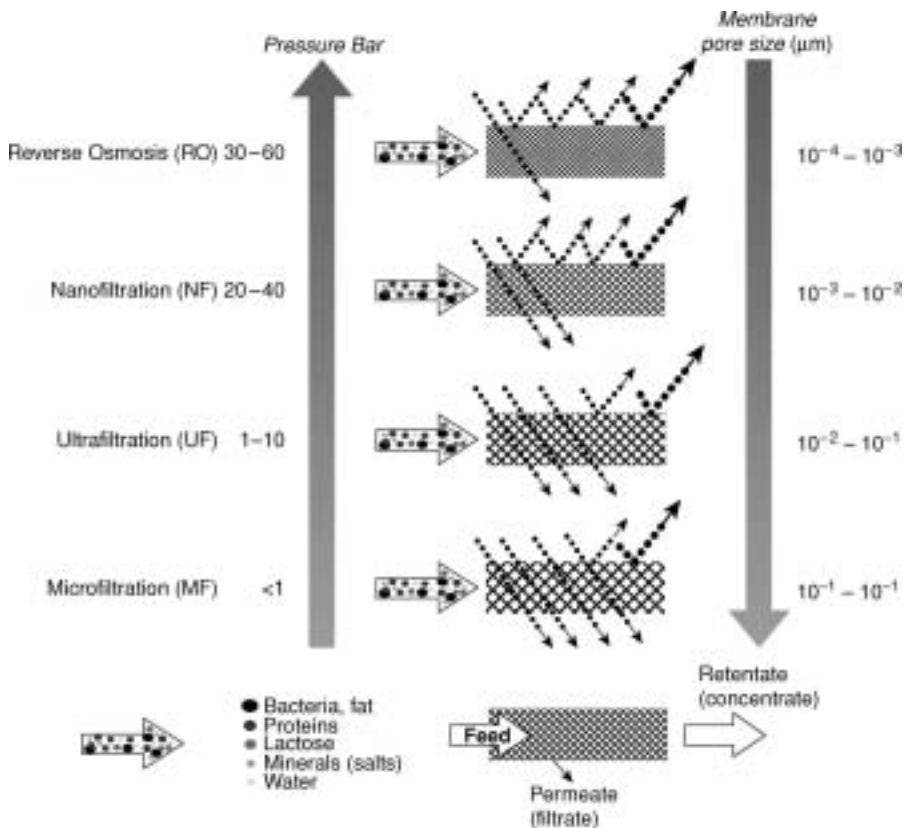

Figure 5.16. Different membrane processes and their characteristics. Reproduced with permission from Tetra Pak.

weight of the smallest molecule that cannot pass through the pores of the membranes.

The filter modules themselves are available in various geometries. Spiral wound is the most common but others available are plate and frame, tubular, and hollow fiber. Tubular filters can be made out of ceramics or polymers.

Membrane separation capacity depends on a number of factors. Foremost among them is membrane resistance, which is determined by membrane thickness, surface area, and the pore diameter. Next is transport resistance (also known as fouling effect). This effect occurs on the membrane surface as filtration proceeds. The formation of a layer of deposit leading eventually to membrane fouling is due to the flow of macromolecules at right angles to the direction of flow. A concentration gradient leads to diffusion in the opposite direction. Parallel to the membrane the macromolecules present in the layer close to the membrane move at varying velocities dependent on the axial flow rate. The concentration polarization is not uniformly distributed, especially when the pressure drop gives different transmembrane pressures along the membrane surface. The upstream end of the membrane clogs first and gradually spreads across the whole surface of the

membrane reducing capacity and making cleaning necessary.

Membrane operations can be batch or continuous. In dairy plants continuous processes are more desirable. Process temperatures are maintained at around 50°C to minimize microbial growth and to improve membrane flux.

The use of membrane processing in the cultured dairy products area is restricted to concentration of skim milk for fat-free yogurt manufacture. Some of the lactose and minerals are removed from skim milk thereby increasing the protein content. This process can concentrate skim milk with 9% solids to 12% solids. There is still enough lactose in the retentate to facilitate fermentation. A higher protein content in the concentrated milk results in a firmer acid gel in yogurt.

## BIBLIOGRAPHY

- Tetra Pak. 1995. Dairy Processing Handbook. Tetra Pak Processing Systems, Lund, Sweden.
- Walstra P, Geurts TJ, Noomen A, Jellema A, van Boekel MAJS. 1999. Dairy Technology—Principles of Milk, Properties and Processes. Marcel Dekker, New York.

# 6

## Starter Cultures for Yogurt and Fermented Milks

*Ebenezer R. Vedamuthu*

- Introduction
- Starter Functions
- Factors Affecting Starter Performance
  - Intrinsic Factors
  - Extrinsic Factors
  - Miscellaneous Factors
- Microorganisms Used in Starters for Cultured Dairy Products
  - Genus *Lactococcus*
  - Genus *Leuconostoc*
  - Genus *Streptococcus*
  - Genus *Lactobacillus*
  - Genus *Bifidobacterium*
- Starter Culture Production
  - Bulk Starter Production
  - Commercial Starter Culture Production
- Bibliography
  - Books
  - Chapters in Books
  - Review Articles and Research Papers

### INTRODUCTION

Starter culture is at the heart of cultured dairy product manufacture. With the exception of certain probiotic milks, the centerpiece of cultured dairy product manufacture is fermentation. Fermentation is a biological process. In the context of cultured dairy products, the agents of fermentation are microorganisms. Fermentation in the physiological sense is anaerobic respiration. In microbial metabolism, the oxidation of substrates involves a series of transfers of hydrogen via carriers (coenzymes) to a final acceptor. In aerobic respiration the final hydrogen acceptor is molecular oxygen. Depending on the electron (hydrogen) transfer system, the final transfer of the hydrogen to oxygen would result in the formation of water and molecular oxygen or hydrogen peroxide. Hydrogen

peroxide, a powerful oxidizing agent unless detoxified, would be detrimental to cell viability. In aerobic microorganisms, hydrogen peroxide is transformed into nontoxic components, water, and oxygen by the enzyme catalase. In fermentation, the final hydrogen acceptor is a truncated molecule of the substrate. To a large measure respiration involves the oxidation of carbohydrates, which yields energy in the form of high-energy chemical bonds, as well as short-chain carbon compounds needed for cellular synthesis. In the fermentation of sugars, the truncated intermediate, pyruvate, is the final hydrogen acceptor resulting in the formation of lactic acid. In certain other fermentations, acetaldehyde derived from pyruvate is the final hydrogen acceptor yielding ethyl alcohol as the final product. In mixed fermentations, both lactic acid and ethyl alcohol are formed. In terms of energy yield, fermentation yields only substrate-level phosphorylation, which is much less than complete aerobic respiration. Fermentative microorganisms generally do not possess catalase, and hence cannot tolerate aerobic conditions.

Cultured dairy product manufacture largely involves lactic acid fermentation. And, the microorganisms fomenting the change are lactic acid bacteria (LAB). In mixed lactic acid – alcohol fermentations, as in Kefir and Koumiss, in addition to LAB, yeasts are also associated. Yeasts are the agents of alcohol formation in these products. Certain LAB in cultured dairy products impart flavor attributes through the fermentation of citric acid or citrates.

Starter culture, or starter for short, consists of selected microorganism(s) deliberately added to milk or a dairy mix to bring about desired changes that result in the production of a specific cultured dairy product with the desired attributes. The term “starter”

in this context is entirely appropriate, because the starter *initiates and carries through* the necessary changes in the starting material to yield the cultured dairy product. The entire cultured dairy product manufacture is dependent upon the activity of the starter. It is very similar to the ignition switch (which activates the starter) in an automobile. Unless the starter is activated or operating in an automobile, the car will have no mobility and will be useless in getting one from point A to point B. That *somewhat* portrays the role of the starter culture in cultured dairy product manufacture. The parallel between the function of the starter in a car and that in the production of cultured dairy products relates only to the initiation of the process and does not adequately represent the full gamut of the roles the starter culture plays in cultured dairy product manufacture and quality. Starter cultures not only initiate, but also carry through every change to attain the desired body, texture, and flavor in the cultured dairy product. Furthermore, starters play a preservative function in suppressing spoilage flora, thus increasing shelf life. Another vital function relates to their protective role in retarding or inhibiting pathogenic flora, and the formation of enterotoxins in the finished culture dairy product. In short, starter culture determines the shelf life and the safety of cultured dairy products. In probiotic products, the added cultures impart health-promoting properties to the consumer.

Because of the aforementioned vital functions of starter cultures in fermented and nonfermented dairy products, the selection, propagation, and handling of starter cultures are of paramount importance in successful cultured dairy product manufacture and merchandizing. That holds true in the industrial production of starter cultures, which would entail an additional burden in using the most optimum harvesting and preservative techniques that would ensure optimum functionality of the starter during application.

As mentioned earlier, starter cultures are composed of living entities. Living organisms require proper environmental conditions to thrive and perform their functions. Environmental conditions comprise optimum temperature ranges, proper nutrition, and optimum pH range, absence of toxic substances or by-products, and careful handling procedures. Some of the manufacturing processes for cultured dairy products require sequential operations, which would involve manipulations that favor or retard the growth and biochemical activities of starter cultures. Some fermentations require the use of starters

composed of different microorganisms with different growth requirements. In such operations, associative action by components in the starter mixtures may be desired, and in other cases, the conditions need to be manipulated to curtail the growth and activity of one component, but favor the other or promote a balanced growth and activity of both components. All those events have to be carefully controlled to obtain consistently superior end products. Yogurt manufacture exemplifies a process where synergism between two different starter components is desired. In cultured buttermilk, conditions are manipulated to prevent dominance by acid-producing bacteria, so that the flavor-producing component(s) in the starter mixture can function, assuring a balanced growth and activity of both components.

Because of the complex interactions between microorganisms, and complex substrates in which the starter flora have to function, even a slight deviation from standard operating procedures could cause problems in the fermentation industry. The quality of materials being transformed through fermentation in some cases could be detrimental to starter functions. The physical and chemical properties (for example, the concentration of solids contributing to osmolarity, presence of toxic substances like antibiotics, residual sanitizers, or mastitic milk, etc.) or variability in the quality of the milk or dairy mix would result in malfunction of starter flora and poorer quality end products. Another complicating factor in cultured dairy product manufacture is the infection of starter bacteria by bacterial viruses or bacteriophages, or phages for short. Starters infected with phages are either killed or functionally crippled. Economic consequences of phage-related failures of dairy fermentations are manifold. Firstly, there could be complete failure of the desired fermentation(s). Secondly, slowing down of the process may disrupt daily schedules and result in erratic turnover of equipment, overtime wages, overall loss in the final quality of the products, undergrade products, and loss in value. Most importantly, there is likelihood of unchecked development of chance contaminants such as spoilage flora and pathogenic or toxigenic flora in the product.

Fermentation failures may be caused either by technological or microbiological factors or by a combination of the two. Troubleshooting in the fermentation industry thus requires good knowledge of both technological and microbiological facets involved in any specific fermentation. Using yogurt as an example, some of these aspects can be illustrated. Yogurt

today is a multifaceted product. In the United States yogurt is available as “plain yogurt,” which is the product obtained after fermentation without any additions. Within the “plain yogurt” category, in addition to the solid product, there is also liquid, drinkable plain yogurt. Another variation within this group is the solid or drinkable yogurt with probiotic cultures comprising one or more species or different strains of the same species. Subgroups in the plain yogurt variety are made up of products with different fat contents (fat-free, low fat, and full fat). Plain yogurt is, however, not very popular because of its acid taste, and shunned by most consumers. Most customers prefer the flavored and sweetened products. Within the flavored category, there are varieties with added flavor essences only, such as vanilla, chocolate, coffee, lemon, lime, orange, banana, etc; others with fruit pieces and fruit flavors/syrups exemplified by strawberry, raspberry, blueberry, apple, etc; and specialized flavors and combinations like nuts and cereals, pina colada, apple-cinnamon, etc. Then there are variations based upon how the fruit is distributed—fruit at the bottom/sundae style and the blended style in which the fruit is uniformly distributed. Within the flavored yogurts, there are the solid and drinkable types, as well as classes distinguished by different fat levels. Flavored yogurts are also available with added probiotic cultures. There are yogurt varieties targeted for youth and children, special dietary yogurts containing artificial sweeteners, and yogurts packaged in squeezable containers for people “on-the-go.”

All the foregoing yogurt products need to meet certain basic criteria in body, texture, color, flavor, fruit distribution, and resilience to handling through marketing channels. Various operations in the manufacture of the wide variety of yogurt products exert stresses on the starter organisms. For example, the addition of fairly high concentrations of sugar (sucrose or high fructose corn syrup or corn syrup) before culturing increases the osmotic pressure of the mix; the addition of fruit preparations preserved in sugar syrups after culturing also has the same effect. There are trade requirements that specify that yogurt should have a certain level of live starter organisms present throughout the prescribed shelf life of the product. Agitation of coagulated curd, pumping through pipelines, and other related processes introduce air into the product, which also cause stress conditions. Such stress conditions cause cell destruction or injury. These stresses affect the viability of yogurt starter bacteria as well as other probiotic strains added to the yogurt.

In terms of flavor, “mildness” both in terms of acidity and “greenness or acetaldehyde flavor” is highly desired by manufacturers. Mildness allows the manufacturers to use a wide assortment of single and complex flavors, for example, chocolate and coffee flavors. The selection of starter strains becomes critical in obtaining mildness. To obtain a smooth texture without whey separation, starters containing strains that produce exopolysaccharides (EPS) are necessary, but there is a fine line between the smoothness desired and the stringiness or “ropiness.” Here, too, starter selection and cultural conditions are critical. Use of EPS-producing strains also helps to give yogurt a heavy body that would hold in suspension fruit pieces within the yogurt matrix. Bleaching or fading of the natural hues of fruits and fruit juices is often encountered in fruit yogurts. The bleaching or fading of fruit pigments (anthocyanins) is caused by pH and oxidation/reduction changes introduced by starter bacteria. Starter selection, proper cultural conditions and choice of stabilizers, and fruit preparations are important in controlling the quality of the finished product. The need for viable starter bacteria in the product till the “open date” and the complexity introduced by the inclusion of probiotic strains add another dimension to the difficulties in yogurt fermentation and yogurt systems. The foregoing illustration using yogurt in a nutshell shows the importance of starter culture and the need for “holistic” analyses of both technological and microbiological aspects in successful fermentations.

## STARTER FUNCTIONS

The *primary* starter function is to generate lactic acid by the fermentation of the major sugar in milk or dairy mixes, lactose. The rate at which the acid development is desired depends upon the cultured dairy product, the turnover desired in the manufacturing plant, the starter flora used, the temperature of fermentation, the flavor generation needed in the cultured product (need for balanced growth of the mixed starter flora), and the body characteristics (in terms of EPS generation) desired in the cultured product. As acid accumulates during fermentation of sugar, the pH progressively decreases. When the pH drops to the isoelectric point of casein, the colloidal dispersion of casein micelles collapses, and the acid casein precipitates forming the curd. Thus, the acid generated from the fermentation of lactose not only imparts a pleasantly acid flavor to the cultured product, but also transforms the starting liquid milk or dairy

mix into a semisolid-to-solid curd. Within the solid casein matrix, the whey and other soluble components of milk and milk fat are entrapped. Unless the curd is unduly disrupted by rough handling or excessive pumping, the entrapped components are held fairly intact with the casein network. Excessive acid generation by starter organisms because of uncontrolled fermentation (failure to arrest fermentation by prompt and proper cooling at the desired acid level or improper temperature control during fermentation) will result in the shrinkage of the curd and the expulsion of whey and soluble components. Excessive acid concentration also imparts a harsh, acid flavor and masks the delicate dairy flavor notes like diacetyl desired in cultured buttermilk, sour cream, and a few other cultured dairy products.

The acid generated and the gradual lowering of the pH facilitate the transport of citrate present in milk or dairy mixes into the cells of “flavor bacteria” efficiently, resulting in the formation of the primary flavor compound, diacetyl. Transport of citrate into the cells of flavor bacteria is facilitated by an enzyme, citrate permease, which functions optimally below pH 6.0 (the initial pH of milk is around 6.6, and in dairy mixes, the pH may range from 6.3 to 6.4).

Another important function of lactic acid is its preservative effect. Undissociated lactic acid is inhibitory to many spoilage and pathogenic bacteria, and the lowered pH is an additional stabilizing factor. In most cultured dairy products, the maximum acidity attained ranges between 1.3% and 1.5%, expressed as lactic acid. To yield 1 lb of lactic acid, 1 lb of lactose is consumed. Milk contains around 4.8% lactose, and to yield 1.5% lactic acid, only about 30% of the total lactose content is consumed, leaving a large portion of the lactose intact at the end of fermentation.

The *secondary* functions of the starter culture in cultured dairy products include flavor generation, special body and texture production, and the elaboration of miscellaneous inhibitory metabolites that impart preservative effects. In cultured buttermilk, *dahi* (an Indian cultured milk), sour cream, and related products, the nutmeat-like “buttery” flavor is desirable. Diacetyl is the key compound that imparts the buttery flavor. Diacetyl is a diketone, derived by the fermentation of citrate present in milk and dairy mixes. Flavor bacteria included in starters for such products possess the enzymatic pathways to convert citrate to diacetyl and other closely related reduced derivatives of the diketone. The reduced forms of diacetyl do not possess the desired buttery notes prized in the aforesaid cultured dairy products. Flavor

bacteria consist of *selected, compatible* strains of *Leuconostoc* spp. and citrate-fermenting *Lactococcus lactis* subsp. *lactis*. Among the two, *Leuconostoc* spp. are preferred over citrate-fermenting *L. lactis* subsp. *lactis* organisms in cultured buttermilk and sour cream starters. The citrate-fermenting lactococci accumulate fairly high concentrations of acetaldehyde, which introduces unwanted harsh, “green, yogurt-like” flavors in cultured buttermilk and sour cream. Dairy *Leuconostoc* spp. on the other hand scavenge undesirable acetaldehyde, converting the aldehyde to ethanol, which provides a complementary flavor to the overall characteristic flavor bouquet of cultured buttermilk and sour cream. The relatively high alcohol dehydrogenase activity of dairy leuconostocs plays a vital part in the scavenging of acetaldehyde. To obtain a characteristic cultured buttermilk flavor, a balanced ratio of diacetyl to acetaldehyde is necessary. The desirable ratio of diacetyl to acetaldehyde falls between 3.2:1 and 4.4:1. In *dahi*, the presence of slightly higher concentrations of acetaldehyde is not considered a defect. The flavor bacteria are heterofermentative, and from lactose produce fairly high amounts (about 30%) of metabolic end products other than lactic acid. The non lactic acid metabolites include acetic acid, ethanol, and carbon dioxide. The fermentation of citrate in addition to diacetyl and its reduction products also yields carbon dioxide. Carbon dioxide plays a role in the flavor perception of cultured buttermilk, very similar to the effervescence or the “lift” imparted by carbonation in “soft drinks.”

In yogurt, on the other hand, acetaldehyde is a key component in furnishing the desirable “green apple” flavor. Although for typical plain yogurt a fairly high concentration of acetaldehyde is needed, the present trend as mentioned earlier is to select starter strains that produce low amounts of the aldehyde to give a mild-flavored yogurt, compatible for the addition of a wide variety of flavors.

In Kefir and Koumiss, ethyl alcohol and carbon dioxide provide essential flavor notes. The yeasts associated with the Kefir grains and the starters used for Koumiss generate the needed alcohol and carbon dioxide. In *dahi*, in certain areas, a slight “yeastiness” is preferred. Yeasts acquired through chance contamination and carried over by “back slopping” practice are attributable to the yeastiness in *dahi*. The starters used in *Villi* contain a mold, *Geotrichum candidum*, that forms a layer or mat on the surface of the product (aerobic growth). The mold metabolizes lactic acid, and induces a “layered mildness” to the product



and also imparts a “musty” aroma. The exact role of molds associated with certain Koumiss starters is still undefined.

Starters additionally impart special body and texture characteristics to certain cultured dairy products. In Viili and closely related Scandinavian cultured milks, a viscous and a ropy or stringy body and texture is caused by EPS-producing strains included in the starters. As described earlier, EPS-producing starter strains in yogurt starters provide the heavy body to hold fruit pieces in suspension. Lately, the use of EPS-producing starter strains is widespread in cultured buttermilk and sour cream production. With the ever-increasing price of milk solids, these strains provide cost-effective means to impart a heavy body to these products. The cost savings are realized either by reducing the amount of milk powder fortification or by complete elimination of fortification. During filling operations for cultured buttermilk, the EPS-induced texture in the finished product prevents foaming, and allows easy filling of bottles to the required level.

LAB used as starters produce other metabolites that are inhibitory to spoilage flora. These metabolites contribute to shelf-life extension of cultured dairy products. The secondary metabolites that are significant include hydrogen peroxide, which is inhibitory to spoilage bacteria such as *Pseudomonas* spp. Hydrogen peroxide in combination with the lactoperoxidase system of milk exerts suppressive effect on spoilage flora. Certain starter bacteria produce benzoic acid as a metabolite. Benzoic acid has a bacteriostatic and fungistatic effect. Starter LAB produce bacteriocins such as nisin, acidophilin, bulgaricin, and other uncharacterized inhibitory peptides. Nisin is active against spore-forming bacteria. Citrate-fermenting *L. lactis* subsp. *lactis* strains exert an inhibitory action against Gram-negative spoilage bacteria as well as pathogens. Some of the inhibitory peptides elaborated by that *Lactococcus* subspecies have recently been described.

## FACTORS AFFECTING STARTER PERFORMANCE

The factors influencing starter performance may be classified under two headings, namely *intrinsic* and *extrinsic*.

### INTRINSIC FACTORS

Among the intrinsic factors, the *genetic makeup* of the starter cells is vital in starter functions. Cellular

functions are a reflection of the genetic information encoded in the nuclear materials (DNA—chromosomal and extrachromosomal) contained within the cells. Metabolic functions of the cell are carried out via various catabolic and synthetic enzymatic pathways. Enzymes are biological catalysts that drive the catabolic and synthetic reactions. Enzymes are proteins made up of amino acids strung together in specific sequences, which are encoded in the DNA of the cells. The specific folding of the amino acid sequences, and the specific reactive sites thus formed, facilitates the reactivity of enzymes. The structure and the reactive site(s) of enzymes determine their specificity for substrates.

The genetic materials in the cell could be altered by mutations. Mutations (spontaneous or induced) in enzymatic pathways would profoundly affect cellular metabolism. Such mutations in carbohydrate utilization would affect acid production, a primary function of starters. Similarly, other functions could also be affected.

As mentioned earlier, the genetic material of the cell could be organized in the chromosome or in extrachromosomal elements. Plasmids, transposons, and introns represent some of the extrachromosomal elements found in starter bacteria. Nuclear material of bacteriophages (or phages) specific for starter bacteria sometimes exist as extrachromosomal entities within starter cells. Many of the vital starter functions are encoded on plasmid DNA. During cell division, extrachromosomal DNA replicate in synchrony with the chromosomal DNA. But, errors during replication occur more frequently in plasmids. And, failures in the transfer of plasmids to daughter cells are also more frequent. This phenomenon is often referred to as “plasmid loss.” Loss of plasmids in starter cells results in loss of specific starter functions. Loss of plasmids among *Lactococcus* spp. is quite prevalent. Repeated transfer of starter cultures, sudden thermal shocking during propagation, or exposure to overacidic environment increases the frequency of plasmid loss in lactococcal starters.

Lactose utilization (Lac<sup>+</sup>) is one of the plasmid-encoded traits in dairy lactococci. The loss of Lac-plasmid results in the inability of the strain to efficiently ferment lactose. Such a phenotype is designated as Lac<sup>-</sup>. Another important plasmid-encoded trait is the ability to break down protein(s). This trait is designated as Prt<sup>+</sup>. Proteolytic ability is closely linked with efficient lactose utilization. Milk contains only traces of free amino acids. To synthesize enzymes involved in lactose utilization, free amino

acids are needed. Breakdown of milk proteins would yield the necessary amino acids for synthesizing the needed enzymes for lactose fermentation. So the  $\text{Prt}^+$  phenotype is critical for lactose fermentation. In short, for efficient acid production in milk or dairy mixes,  $\text{Lac}^+/\text{Prt}^+$  phenotype is mandatory.

Another important functional trait that is plasmid-encoded is the transport of citrate into the cell. Citrate present in milk and dairy mixes is converted by citrate-utilizing lactococci to diacetyl, which is the key flavor component in cultured dairy products such as cultured buttermilk and sour cream. The citrate in the environment first has to be transported into the cells before it can be converted into diacetyl. Citrate transport is mediated by the enzyme citrate permease. Cells possessing active citrate permease, and hence capable of citrate conversion to flavor compounds, are designated  $\text{Cit}^+$ . The loss of  $\text{Cit}^+$ -plasmid renders the cell  $\text{Cit}^-$ , which is incapable of diacetyl production.

Some of the genes connected with EPS synthesis in dairy lactococci are plasmid-encoded. So EPS production is an unstable trait in those bacteria. Also, efficient EPS synthesis in LAB is favored at temperatures lower than optimum for growth. Loss of plasmids encoding some of the genetic information for EPS synthesis results in the inability to produce the viscosity and “ropiness” desired in specific cultured dairy products, where lactococcal starters are used. The entire genetic material that codes for EPS production in lactococci has been unraveled. And, genetic probes to identify EPS-producing lactococci have been described.

Among the dairy lactococci, the production of wide-spectrum bacteriocins known as lactacins is plasmid-encoded. The genes for another broad-spectrum bacteriocin, nisin, are encoded on a transposon, a highly mobile genetic element. The loss of such extrachromosomal elements throws up cells incapable of producing bacteriocins that inhibit spoilage (spore-forming bacteria) and pathogenic bacteria (clostridia and *Listeria monocytogenes*).

In certain LAB strains used in dairy starters (*Lactococcus* subsp. and *Streptococcus thermophilus*), mechanisms that provide resistance to destruction by phages are encoded on plasmids and on a transposon. The loss of those transient genetic elements makes those cells vulnerable to phages.

Other intrinsic factors that affect starter performance may be categorized under the heading *physiological condition or state* of the starter bacteria. The physiological state or condition of starter bacteria

depends upon how the culture was propagated, handled, and preserved. Many of the enzyme systems vital in acid and flavor production are *inducible*.

Enzyme induction is a control mechanism that operates at the genetic level. An inducible enzyme is expressed only when the specific substrate is present. Enzymes that cleave lactose among starter LAB ( $\beta$ -galactosidase and phospho- $\beta$ -galactose galactohydrolase) are inducible. Starter bacteria that have been propagated in the absence of lactose (using sugars like glucose) when added to milk have to undergo an adaptive lag for induction. In other words, the cells are not “primed up” to use lactose. Citrate permease involved in flavor production is inducible in both citrate-fermenting *Lactococcus lactis* subsp. *lactis* and *Leuconostoc cremoris*. The enzyme that cleaves citrate leading to diacetyl production is inducible in *Leuconostoc cremoris*. Thus, for efficient flavor generation, starter cultures need to be propagated with the inducer (citrate) in the propagation medium.

Lack of essential factors in propagation medium significantly affects cellular integrity of certain starter LAB. A good example is *Lactobacillus delbrueckii* subsp. *bulgaricus* (hereto referred to as *Lactobacillus bulgaricus* for convenience). Availability of  $\text{Ca}^{++}$  in the propagation medium affects the integrity of the cell walls of those bacteria; *Lb. bulgaricus* cultures propagated in media lacking free  $\text{Ca}^{++}$  display distorted cell morphology, and fragility to cell harvesting and preservative processes.

In commercial production of starter cultures, the starter strains are grown in a relatively clear medium or one that contains low, undissolved suspended solids. Dairy starter cultures that need to function in milk should preferably be grown in milk containing medium with lactose as the carbon source. Excessive use of protein hydrolysates should be avoided. Inclusion of milk as the nitrogen source and lactose as the carbon and energy source in the propagation medium exerts a “selective pressure” to obtain an active cell crop. The choice of the neutralizing agent during starter propagation is another factor in obtaining the best cell crop. The optimum neutralizer varies with different strains. Because of the convenience and amenability to electronically controlled addition, ammonia gas is generally preferred as the neutralizer of choice by commercial culture manufacturers.

At the end of propagation, the cells are harvested. Harvesting could be achieved either by centrifugal separation or by filtration using ultrafiltration equipment (ceramic filters that could be efficiently

sterilized are preferred). Harvested cell concentrates may then be frozen in cups or in bead-like, pelletized form. Suitable cryoprotectants are added before freezing. An alternative to freezing is freeze-drying or lyophilization. Proper selection of cryoprotectants is important to prevent cell injury, damage, or loss of viability. The method of freezing also affects cell viability and damage. Rapid rate of freezing is preferable. Use of liquid nitrogen or dry ice or dry ice-alcohol bath as cryogenic agents gives better cell integrity than freezing at  $-20^{\circ}\text{C}$  (in a mechanical freezer). Proper freeze-drying conditions have to be worked out for different starter organisms, and “programmed” into commercial freeze dryers. Generally, the rod-shaped LAB (*Lactobacillus* spp.) are more sensitive to the production processes than the spherical LAB (*Lactococcus* and *Streptococcus* spp.) used as starters. All the factors discussed in the foregoing paragraphs have significant influence on starter performance.

### EXTRINSIC FACTORS

Extrinsic factors come into play during application of starter cultures or in the preparation of starter cultures in the dairy plant. The same principles governing the “physiological condition” of the starter cells discussed for commercial production apply for the preparation of the starter in the dairy plant. Further, commercial cultures could be damaged by improper handling in the dairy plant. At receipt, frozen cultures should be carefully examined whether during transit any thawing had taken place. If partial or complete thawing had occurred, the cultures should be discarded. Till use frozen cultures need to be stored at  $-40^{\circ}\text{C}$ . An ice cream hardening room would also suffice. If the frozen cultures go through freeze-thaw cycles, the starter bacteria will be severely damaged. It is beneficial to store freeze-dried cultures in a freezer to keep the cells active.

Fast thawing of frozen cultures just before use in lightly chlorinated warm water at  $35^{\circ}\text{C}$  is advisable. Thawing frozen cultures in a refrigerator causes cell damage. Proper conditions for rehydration of lyophilized (temperature and rehydration menstrum) cultures assure maximum cell viability, and recovery of injured cells. The rehydration processes for different strains vary, and should be determined for each culture combination in consultation with the culture supplier. For optimal performance of starters, the sooner the culture is used after thawing or rehydration the better the results.

When bulk starters are made in the plant, proper temperature control, close monitoring of acidity, and prompt and efficient cooling of the starter at the end-point are critical in avoiding cell injury and assuring high performance in the product vat. All the above factors that are encountered in the dairy plant, the actual site of application, relate to the physiological condition of the starter bacteria (the innate properties of starter cells) at the time they are added to the product vat. In the strict sense of the term, they are not true extrinsic factors.

The extrinsic factors in the real sense of the term relate to external influences, as opposed to innate properties of starter cells. The external factors include presence of antibiotics in milk or dairy mix, presence of fairly high sanitizer residues, presence of high proportions of agglutinins (colostrum or early lactation milk), and infection with phage. Antibiotics are used in treating udder infections like mastitis. Sometimes because of improper adherence to regulatory mandates, antibiotic-tainted milk finds its way into pooled milk. *S. thermophilus* is extremely sensitive to antibiotics. Although not as sensitive as *S. thermophilus*, the dairy lactococci and starter lactobacilli are functionally impaired in the presence of antibiotics used for mastitis therapy. Excessive or improper use of sanitizers affects starter performance. Certain sanitizers like quaternary ammonium compounds are not dissipated easily, and could remain in active form in the vat milk. These residues would inhibit starters.

Agglutinins are antibodies produced by the defense mechanisms of cells in response to infections. Mastitic milk contains high titer of agglutinins. To protect young suckling calves against infection, the early mammary secretion called colostrum contains high titers of antibodies including agglutinins. Many starter lactococcal strains are susceptible to clumping (reduction of surface area) by agglutinins, and their acid-generating function is severely affected by the presence of these antibodies in the vat milk.

Phages constitute the most insidious agent affecting starter function. The consequences of phage infection of starter bacteria in dairy fermentations were discussed earlier. Phages in terms of host relationships are of two types, namely, virulent or lytic, which destroy host cells, and temperate or prophage or lysogenic, which normally exist in benign relationship within the host cell. Sometimes, the prophage could be “induced” (either spontaneously or by external agents like ultraviolet radiation or chemical agents) into the virulent form. Prophages may exist as an independent DNA element in the cytoplasm of the host

cell or attached to the host chromosome. Lysogenic phages could sometimes act as vectors for genetic exchange between closely related bacteria by a mechanism called "transduction." Such lysogenic phages are called "transducing phages." All these types of phages are found in starter LAB.

Phages are tadpole-shaped particles. They have a definite head, which in some cases are symmetrical (isometric) and in others elongated (prolate) isocohedral structures, attached to a tail. The DNA of the phage is enclosed within the head. The tail differs in length and is a hollow structure. The tail may be striated, and may be rigid or contractile. The tail may possess a tail plate, and spikes at its extremity. Lactococcal phages have rigid tails. The nuclear material of the phages infecting starter LAB is composed of DNA. The head and the tail of phages are made up of protein. Generally, phages have *host specificity*, but phages crossing species boundaries are known.

During the infective cycle, the phages attach to *specific receptor sites* of the host cells, and in the *presence* of  $\text{Ca}^{++}$  form an irreversible bond with the host cell creating a channel to the interior of the cell. The phage DNA is expelled by the contraction of the head, and the DNA travels through the channel in the tail and is delivered to the interior of the host cell. The host receptor sites in most cases are composed of carbohydrate entities, rhamnose being the most prevalent, and in one case the attachment (also called adsorption) is dependent upon a chromosomally encoded protein embedded in the cell membrane. Soon after the entry of the phage DNA, the host cell chromosome is degraded, and the host synthetic mechanisms are used in phage DNA replication followed by components making up the phage protein-coat. The assembly of the phage occurs in stages till the entire (mature) phage particle is completed. When a genetically determined number of phage particles are assembled, through the concerted action of two enzymes, *holin* and *lysine*, the host cell wall is breached, and the phage particles spill out to the surrounding environment. The genetically determined number of particles released from the host cell is called the *burst size*. The time lag between the entry of the phage DNA into the host cell and the release of mature phage particles from the host cells is called the *eclipse period*. Among dairy lactococci, the burst size is around 200 particles. As the cycle continues unabated, the phage numbers (or *titer*) increase exponentially with concomitant destruction of host cells. When the phage titer reaches to high levels, the level of lysin also increases considerably in the

environment. Lysin is a nonspecific enzyme that cleaves cell walls of closely related bacteria. High levels of lysin could destroy phage-unrelated component strains in starter mixtures by cell lysis. This phenomenon is often referred to as "lysis from without."

In dairy fermentations, a phage titer of  $1.0 \times 10^5$  per milliliter is considered detrimental to the process. Considerable research has been devoted to phages infecting dairy lactococci. The information on phages infecting yogurt starter bacteria has also been accumulating rapidly over the past decade. With the advent of modern molecular techniques, phages are classified on the basis of DNA homology. Currently, phages are divided into 10 species under families *Siphoviridae* and *Podoviridae*. Phages affecting lactococci used in cultured buttermilk and sour cream plants in the United States have been extensively surveyed. A large majority of phages isolated from product samples were grouped into 936 species. Other groups found in these samples belonged to c2 and P355 species. The prevalence of P355 species was sparse. Phage species P355 is a relatively new phage that has emerged in cultured dairy product plants, and is considered as a serious threat to dairy fermentations, because of its ability to rapidly evolve into new, resistant types by genetic exchange. Phages lacking lytic ability but possessing mechanisms to depolymerize EPS produced by lactococci have been isolated from cultured buttermilk and sour cream samples in the United States. A phage with similar activity, KSY 1, has been isolated from Viili in Finland. Phage KSY 1 falls under the family *Podoviridae*.

Phages affecting *S. thermophilus* possess isometric heads and long noncontractile tails. All those phages are grouped under the family *Siphoviridae*. The virulent phages fall into one DNA homology group. Lysogenic relationships among *S. thermophilus* are quite complex. Phages affecting *Lb. bulgaricus* and dairy leuconostocs have been isolated. The leuconostoc phages have isometric heads and noncontractile tails with distinct tail plates.

Phage control in dairy plants involves separation of the starter room from other manufacturing areas, having a separate crew for starter room duties, provision of air locks between the starter room and the rest of the plant, provision for separate locker rooms and uniforms for starter room workers, provision of footbaths containing sanitizers at the entrance to the starter room, restricting the movement of plant personnel from and to the starter room, maintenance of positive air pressure in the starter room, the use of

laminated air flow through microfilters (HEPA filters) in the starter room, preventing the dispersal of phage particles via air-circulating systems, and other means of physical containment necessary. Fogging the plant environs with 100 ppm chlorine at the end of operations is also recommended.

Another practical means of controlling phages is using phage inhibitory media (PIM) for propagating starter bacteria. PIM are carefully formulated nutrient media containing phosphates or other chelating agents like citrates. Phosphates and citrates chelate free  $\text{Ca}^{++}$  in the system, and thus prevent irreversible phage adsorption to sensitive cells. The yogurt starter bacteria and *Leuconostoc* spp. do not grow well in PIM containing high levels of phosphates. For these bacteria special formulations of PIM containing low levels of phosphates and other chelators like citrate and stimulants for cell growth are used. The lactococci are relatively more tolerant of levels of phosphate necessary to inhibit phage proliferation.

Culture rotation is another strategy used for phage control in dairy plants. In this plan, starter strains with unrelated phage specificities are used in rotation during production week, so that the chances of buildup of phage titer for any one set of strains in the dairy plant are avoided. This strategy works well when used in combination with other measures described earlier. Some workers have suggested rotating strains selected on the basis of sensitivity to differing phage species and elimination of starter strains that are affected by the rapidly evolving P335 phage species in the rotation scheme.

Over the past two decades, a new strategy has been introduced to confront phage-related problems. The scheme comprises several steps. First, the phages appearing in a dairy plant are monitored over a period of time against a bank of active starter strains, and a battery of strains resistant to the phages appearing in the plant is selected. Three to six of the resistant strains are supplied as *single units* to be combined to make up a mixed culture. A set of three such potential mixtures are kept in reserve. One mixture is introduced in the plant, and the cultured products made in the plant are monitored daily for the appearance of phages affecting any of the strains being used. If a phage is detected for any strain in the mixture, that strain is removed and a reserve strain is substituted. The strain that was pulled out is challenged against the infecting phage isolated from the cultured product, and spontaneous *insensitive mutants* that emerge are isolated from a special plating medium (fast-slow differential agar) and purified of any residual phage particles. The

insensitive mutant is introduced to make up the original mixture. The cycle is repeated as required. The success of the scheme depends on using *only limited number of carefully selected strains in production, and daily monitoring for phages*. The scheme has been successfully used in cultured dairy product plants in the United States and in Ireland. The insensitive strains thus selected are generally composed of cells with phage adsorption site mutations. The scheme has been successfully used with lactococci and *S. thermophilus*.

There are several innate phage-resistance mechanisms encoded in the genetic material of starter LAB. These mechanisms in dairy lactococci have been studied extensively. As mentioned earlier, many of these resistance mechanisms are encoded on plasmids. Developments in molecular biology have facilitated plasmid isolation, analysis, base sequence determinations, transfer of functional sequences between lactococcal strains, and functional expression of resistant traits in sensitive recipients. The known resistance mechanisms include modification of adsorption sites, restriction-modification, blocking of phage DNA penetration, and abortive infection mechanisms. In adsorption modification, the phage receptor sites are modified (by masking) such that phage is unable to attach to the cell. In restriction-modification system (R/M) the incoming phage DNA is degraded by "restriction enzymes," and made nonfunctional. To protect the host cell DNA from being chopped up by the restriction enzymes, "modifying enzymes" are produced, which render the host DNA invulnerable by methylation of the DNA sites. Modified methylated sites in the DNA are not recognized by the restriction enzymes. The restriction and modification components in the R/M system work in concert to confer phage resistance to the host. In the blockage of phage DNA penetration, a modification of or a defect in a cell membrane embedded protein called phage infection protein (PIP) that facilitates phage DNA penetration (PIP is encoded on a plasmid in some organisms and on the chromosome in some others) confers resistance to the host. In abortive infection mechanism, the phage DNA replication or phage assembly is disrupted and hence no release of mature particles occurs. In effect, the infecting phage is entrapped by the host cell. Plasmids conferring some of the phage-resistance mechanisms have been transferred to sensitive strains, making them resistant through conjugation and electrotransformation. Conjugation involves cell-to-cell contact and mobilization of DNA from a donor to a recipient.

Electrotransformation involves the introduction of plasmid DNA into recipient cells by facilitating the penetration of DNA via pores created in the recipient cells by short high-voltage electric pulse. Commercially viable and successful phage-resistant starter strains have been produced by using such techniques.

Similar phage-resistant systems have been found among other starter LAB. Plasmid conferring R/M-related phage resistance from a *Lactococcus* strain when introduced into a *S. thermophilus* strain was functional in conferring resistance to the heterologous recipient against phage lytic for that *S. thermophilus* strain. Recently *S. thermophilus* plasmids have revealed DNA sequences closely homologous to R/M sequences found in lactococci. This observation suggests that during the evolution of these closely related bacteria, there has been horizontal transfer of genetic material between these bacteria.

### MISCELLANEOUS FACTORS

There are a couple of other factors that affect culture performance, which could be considered under this heading. These factors in reality are intrinsic to starter organisms, but come into play only when the strains are combined for use in fermentations. One such factor is *compatibility*. The component strains in a mixed culture should be *compatible* with one another to function in concert. Some lactococcal strains produce bacteriocins called lactococcins that kill other lactococci, and are thus incompatible for use in mixtures. *Similar antagonistic activity occurs among other LAB too*. When such strains are used in mixtures consisting of phage-unrelated strains with the intent to ensure unmitigated progress of dairy fermentation (so that if phages for one or two strains are present in the dairy environment, the other phage-unrelated strains could function unimpaired), the strategy fails, because if a phage infecting the dominant or only surviving antagonistic strain is present in the system, there are no other surviving strains to carry out the function to completion. Another bacteriocin produced by certain strains of *Lactococcus lactis* subsp. *cremoris* called *diplococcin* specifically kills *L. lactis* subsp. *lactis* strains. Dominance among starter LAB because of other inherent factors (for example, metabolic efficiency, faster growth rate, etc.) is also known. So, careful selection and pairing or mixing of strains is important.

Another factor that affects culture performance relates directly to yogurt starters. Yogurt starters consist of *symbiotic mixture(s)* of *S. thermophilus* and

*Lb. bulgaricus*. Symbiosis is a cooperative relationship, where one organism stimulates or promotes the growth and activity of another. The functional efficiency is much greater when the symbiotic components operate together than when acting singly. There are strain differences in symbiotic compatibility. Strain selection and pairing for yogurt starters is thus directly related to culture performance.

## MICROORGANISMS USED IN STARTERS FOR CULTURED DAIRY PRODUCTS

Microorganisms used in starters for cultured dairy products are divided into two types based on the temperature ranges at which they operate well. LAB used in products that are incubated in the temperature range of 20–30°C are referred to as *mesophilic starter* bacteria, and those that are used in products that are fermented above 35°C are referred to as *thermophilic starter* bacteria. The latter term is scientifically erroneous, because thermophilic bacteria grow optimally above 50°C, and the organisms comprising thermophilic starters do *not* fit that definition. These organisms should be more *appropriately* labeled as *thermotolerant starters*.

In addition to the two types of starters discussed above, there are other groupings for starter cultures, which are used in Europe. Cultures composed exclusively of *L. lactis* subsp. *lactis* and *cremoris* are known as “O” type cultures; those that contain in addition to the acid-producing *lactis* and *cremoris* subspecies strain(s) of Cit<sup>+</sup> *L. lactis* subsp. *lactis* (flavor producer) are called “D” type cultures; cultures containing a combination of acid-producing *lactis* and *cremoris* subspecies and dairy *Leuconostoc* spp. are referred to as type “L” or “B” type cultures (referring to *Betococcus*, a former nomenclature for *Leuconostoc* bacteria); and, cultures containing *lactis* and *cremoris* subspecies plus Cit<sup>+</sup> *L. lactis* subsp. *lactis* and *Leuconostoc* spp. are known as “LD” or “BD” types. In Holland, a different appellation is used for mixed strain starters.

Those that are propagated under *aseptic conditions* in the laboratory or the dairy plant are labeled “L” type (letter L standing for “laboratory”). And, those in contrast propagated under *nonaseptic conditions* (i.e., without any precautions) to exclude phages in the environment in the dairy plant are called “P” type (letter P standing for “practice”). The P-type starters are used with good success under factory conditions, without phage-related failures. These cultures being

constantly exposed to phages prevalent in the factory environment serve to exert selective pressure to naturally develop phage-resistant derivatives of the strains present in the culture. There is a complex dynamic operating in that system between the starter strains and the “disturbing phages” and the evolution of resistant starter strains, which keeps the starter performing satisfactorily. The L-type cultures, on the other hand, are readily labile to phage-related failures.

Another category that has come into recognition recently is *artisanal* or natural starters. These starters are composed of a mixture of undefined starter bacteria, which have been carried according to the traditional practice of using a small portion of the previous batch of fermented products to seed a new batch. This is often referred to as “back slopping.” Artisanal starters are still used in small-scale, cottage, or farm operations in Europe. A similar system is found in small-scale production of dahi in South Asian countries.

Other arbitrary groupings of cultures are based upon the composition of starters. Starters that are carried in mixtures made of strains that have not been fully characterized with respect to acid-producing abilities, phage susceptibility, etc. are lumped under the grouping “undefined mixed-strain starters.” Starters made up of well-characterized strains (which could be maintained as either separate entities or as a mixture) are called “defined-strain mixed cultures.” The latter came into prominence with the development of phage-insensitive replacement strategy to overcome phage-related problems in dairy plants. Defined-strain mixed cultures have been used very successfully in New Zealand in large dairy plants.

Mesophilic starter bacteria consist of dairy *L. lactis* subspecies and dairy *Leuconostoc* spp. Citrate-fermenting *L. lactis* subsp. *lactis* is often referred to as *L. lactis* subsp. *lactis* biovar. *diacetylactis* in the literature. The other subspecies are *L. lactis* subsp. *cremoris* and *lactis*. The *Leuconostoc* bacteria generally used in dairy fermentations in association with lactococci are *Leuconostoc lactis* and *Leuconostoc mesenteroides* subsp. *cremoris*.

Thermotolerant starters used for dairy fermentations consist of *S. thermophilus* and *Lactobacillus* spp. Among the lactobacilli two subspecies of *Lactobacillus delbrueckii*, namely, *bulgaricus* and *lactis*, are most widely used for cultured milk products. *Lactobacillus acidophilus*, *Lactobacillus helveticus*, and *Lactobacillus casei* subsp. *casei* are other lactobacilli used in fermented dairy milks in association

with other specific microflora. Yogurt by definition is the fermented dairy product produced by culturing with a starter made up of *S. thermophilus* and *Lb. bulgaricus*, and should contain viable cells of both bacteria till the end of the shelf life of the product.

In Table 6.1, the microorganisms used as starters for some of the major cultured dairy products consumed in the West, Eastern Europe, and the Far East are listed under the column “Primary Microorganisms.”

In the production of dahi, the mesophilic lactococci, and in some instances leuconostocs, are used as starter flora. For detailed information on starter flora for many of the fermented products discussed in this book, the individual chapters should be consulted. Some of the physiological and biochemical characteristics of starter bacteria are summarized in Tables 6.2 and 6.3.

## GENUS *LACTOCOCCUS*

Genus *Lactococcus* is a relatively new taxonomic grouping. Five species were hived off the larger genus *Streptococcus* to make up genus *Lactococcus*. Only one species of genus *Lactococcus* (*L. lactis*) is used in dairy fermentations. Current taxonomic groupings rely on phenotypical, biochemical, and molecular characteristics of the organisms. The two subspecies of *L. lactis*, namely *lactis* and *cremoris*, with a biovariety of subspecies *lactis*, Cit<sup>+</sup> or *diacetylactis*, formerly were included in the *lactic* group of Sherman. The distinguishing characteristics of the organisms placed in various groups by Sherman are shown in Table 6.4.

Lancefield grouped the organisms included in the former large genus *Streptococcus* on the basis of serology of their cell-wall carbohydrates. The organisms within Sherman’s lactic group fell under Lancefield’s *group N*. When the dairy lactococci were classified within the genus *Streptococcus*, they went through several changes. At one time, *Lactococcus* subspecies, *lactis* and *cremoris*, had full species status within genus *Streptococcus* (*Streptococcus lactis* and *Streptococcus cremoris*). And so did the current Cit<sup>+</sup> biovariety (*Streptococcus diacetylactis*). Variations in the spelling for the Cit<sup>+</sup> biovariety also featured in taxonomic changes (*diactilactis* versus *diacetylactis*). Later in further changes within genus *Streptococcus*, the full species status for *lactis* and *cremoris* was modified to the subspecies level. The differentiating characteristics of the dairy lactococci are summarized in Table 6.5.

**Table 6.1.** Microorganisms Used in Starter Cultures for Cultured Dairy Products and Their Functions.

Product	Primary Microorganism(s)	Secondary/Optional Microorganism(s)	Incubation Temperature and Time	Major Function of Culture
Yogurt	<i>Lactobacillus delbrueckii</i> subsp. <i>bulgaricus</i> <i>Streptococcus sulvarius</i> subsp. <i>thermophilus</i>	<i>Lactobacillus acidophilus</i> <i>Bifidobacterim longum</i> / <i>bifidus/infantis</i> <i>Lactobacillus casei</i> / <i>lactis/jugurti</i> / <i>helveticus</i>	43–45°C/ 2.5 hours	Acidity, texture, aroma, flavor, probiotic
Cultured buttermilk and sour cream	<i>Lactococcus lactis</i> subsp. <i>lactis</i> <i>Lactococcus lactis</i> subsp. <i>cremoris</i> <i>Lactococcus lactis</i> subsp. <i>lactis</i> var. <i>diacetylactis</i>	<i>Leuconostoc lactis</i> <i>Leuconostoc mesenteroides</i> subsp. <i>cremoris</i>	22°C/ 12–14 hours	Acidity, flavor, aroma
Fermented milk	<i>Streptococcus sulvarius</i> subsp. <i>thermophilus</i> <i>Lactobacillus acidophilus</i> <i>Bifidobacterim longum</i> / <i>bifidus</i> <i>Lactobacillus acidophilus</i>	<i>Leuconostoc lactis</i> subsp. <i>lactis/cremoris</i>	23–37°C/ 8–14 hours	Acidity, flavor, probiotic
Acidophilus milk			37–40°C/ 16–18 hours	Acidity, probiotic
Bulgarian buttermilk	<i>Lactobacillus delbrueckii</i> subsp. <i>bulgaricus</i>		37–40°C/ 8–12 hours	Acidity, probiotic
Kefir	<i>Lactococcus lactis</i> subsp. <i>lactis/cremoris</i> <i>Lactobacillus delbrueckii</i> subsp. <i>bulgaricus</i> <i>Lactobacillus delbrueckii</i> subsp. <i>lactis</i> <i>Lactobacillus casei</i> / <i>helveticus/brevis/kefir</i> <i>Leuconostoc mesenteroides</i> / <i>dextranicum</i>		15–22°C/ 24–36 hours	Acidity, aroma, flavor, gas (CO <sub>2</sub> ), alcohol, probiotic
	Yeasts: <i>Kluyveromyces marxianus</i> subsp. <i>marxianus</i> <i>Torulaspoa delbrueckii</i> <i>Saccharomyces cerevisiae</i> <i>Candida kefir</i>			
	Acetic acid bacteria: <i>Acetobacter aceti</i>			
Koumiss	<i>Lactobacillus delbrueckii</i> subsp. <i>bulgaricus</i> <i>Lactobacillus kefir/lactis</i>		20–25°C/ 12–24 hours	Acidity, alcohol, flavor, gas (CO <sub>2</sub> )
	Yeasts: <i>Saccharomyces lactis</i> <i>Saccharomyces cartilaginosus</i> <i>Mycoderma</i> spp.			
	Acetic acid bacteria: <i>Acetobacter aceti</i>			
Yakult	<i>Lactobacillus casei</i>		30–37°C/ 16–18 hours	Acidity, probiotic

Source: Reproduced with permission from Chandan RC, Shahani KM. 1995. Other fermented dairy products. In: H-J Rhem, G Reed (Eds), Biotechnology, Vol. 9. Wiley-VCH, Hoboken, NJ, pp. 390–391.



**Table 6.2.** Characteristics of Mesophilic Starter Bacteria Used for Cultured Dairy Products

Characteristic	<i>Lactococcus lactis</i> subsp. <i>lactis</i>	<i>Lactococcus lactis</i> subsp. <i>cremoris</i>	<i>Lactococcus lactis</i> subsp. <i>diacetylactis</i>	<i>Leuconostoc mesenteroides</i> subsp. <i>cremoris</i>	<i>Leuconostoc mesenteroides</i> subsp. <i>dextranicum</i>
Cell shape and configuration	Cocci, pairs, short chains	Cocci, pairs, short/long chains	Cocci, pairs, short chains	Cocci, pairs, short/long chains	Cocci, pairs, chains
Catalase reaction	–	–	–	–	–
Growth temperature (°C)					
Optimum	28–31	22	28	20–25	20–25
Minimum	8–10	8–10	8–10	4–10	4–10
Maximum	40	37–39	40	37	37
Incubation temperature (°C)	21–30	22–30	22–28	22	22
Heat tolerance (60°C/30 minutes)	Y	Y	Y	–	–
Lactic acid isomers	L (+)	L (+)	L (+)	D (–)	D (–)
Lactic acid produced in milk (%)	0.8–1.0	0.8–1.0	0.8–1.0	0.1–0.3	0.1–0.3
Acetic acid production (%)	–	–	–	0.2–0.4	0.2–0.4
Gas (CO <sub>2</sub> ) production	–	–	+	Y	Y
Proteolytic activity	+	+	+	Y	Y
Lipolytic activity	Y	Y	Y	Y	Y
Citrate fermentation	–	–	+	+	+
Flavor/aroma compound	+	+	+	+	+
Mucopolysaccharide production	Y	Y	Y	No dextran	Dextran from sucrose
Hydrogen peroxide production	+	+	+	Y	Y
Alcohol production	Y	Y	Y	Y	Y
Salt tolerance (% max)	4–6.5	4.0	4–6.5	6.5	6.5

*Note:* + = Positive for the trait (number of symbols represent degree of expression); – = Negative for the trait; Y = Variable for the trait.

*Source:* Reproduced with permission from Chandan RC, Shahani KM. 1995. Other fermented dairy products. In: H-J Rhem, G Reed (Eds), *Biotechnology*, Vol. 9, Wiley-VCH, Hoboken, NJ, p. 396.

**Table 6.3.** Characteristics of Thermotolerant Starter Bacteria Used for Cultured Dairy Products

Characteristic	<i>Streptococcus thermophilus</i>	<i>Lactobacillus delbrueckii</i> subsp. <i>bulgaricus</i>	<i>Lactobacillus delbrueckii</i> subsp. <i>lactis</i>	<i>Lactobacillus acidophilus</i>	<i>Lactobacillus casei</i> subsp. <i>casei</i>
Cell shape and configuration	Spherical to ovoid, pairs to long chains	Rods with round ends, single, short chains, metachromatic granules	Rods with round ends, metachromatic granules	Rods with round ends, pairs, short chains, no metachromatic granules	Rods with square ends, short/long chains
Catalase reaction	–	–	–	–	–
Growth temperature (°C)					
Optimum	40–45	40–45	40–45	37	37
Minimum	20	22	22	20–22	15–20
Maximum	50	52	52	45–48	40–45
Incubation temperature (°C)	40–45	42	40–45	37	37
Heat tolerance (60°C/30 minutes)	++	+	+	–	–
Lactic acid isomers	L (+)	D (–)	D (–)	DL	L (+)
Lactic acid produced in milk (%)	0.7–0.8	1.5–4.0	1.5–3.0	0.3–2.0	1.2–1.5
Acetic acid production (%)	Trace	Trace	Trace	+	+
Gas (CO <sub>2</sub> ) production	–	–	–	–	–
Proteolytic activity	✓	+	+	✓	✓
Lipolytic activity	✓	✓	✓	✓	✓
Citrate fermentation	–	–	–	–	–
Flavor/aroma compound	++	++	+	+	✓
Mucopolysaccharide production	✓	++	–	–	✓
Hydrogen peroxide production	✓	+	+	–	+
Alcohol production	–	Trace	Trace	Trace	Trace
Salt tolerance (% max)	2.0	2.0	2.0	6.5	2.0

Note: + = Positive for the trait (number of symbols represent degree of expression); – = Negative for the trait; ✓ = Variable for the trait.

Source: Reproduced with permission from Chandan RC, Shahani KM. 1995. Other fermented dairy products. In: H-J Rhem, G Reed (Eds), Biotechnology, Vol. 9. Wiley-VCH, Hoboken, NJ, p. 397.

**Table 6.4.** Sherman's Grouping of Bacteria Comprising the Former Genus *Streptococcus*

Groups	Growth At		Hemolysis	Bacteria
	10°C	45°C		
Pyogenic	—	—	Beta	Pathogenic <i>Streptococci</i>
Varidans	—	+	Alpha	<i>S. bovis</i> , <i>S. equi</i> , <i>S. thermophilus</i>
Lactic	+	—	Gamma	Dairy <i>Streptococci</i>
Enterococcus	+	+	Alpha, Beta	Enteric <i>Streptococci</i>

Note: + = Positive for the trait (number of symbols represent degree of expression); — = Negative for the trait.

Recently, a new differentiating physiological characteristic between *lactis* and *cremoris* subspecies has been reported. Organisms belonging to *lactis* subspecies are capable of decarboxylating glutamate, while *cremoris* subspecies lack that property.

Lactococci are morphologically spherical cells. The cells, however, are not round but oblong. The cells occur in short chains, but most commonly as pairs. Single cells also could be found. Some strains, especially those susceptible to agglutinins found in milk, exhibit long chains. Lactococci are Gram-positive. They are microaerophilic, lack catalase, and are fermentative. *L. lactis* subspp. *lactis* and *cremoris* are homofermentative.

### Lactose Fermentation in Lactococci

The lactococci possess a unique, multicomponent transport system to ferry lactose into the cells, called the phosphoenolpyruvate–phosphotransferase system (PEP-PTS). In this system, phosphoenolpyruvate plays a crucial role in phosphorylating lactose at the sixth carbon of galactose moiety of the disaccharide. The lactose phosphate is cleaved into glucose and galactose-6-phosphate by the enzyme phosphogalactoside galactohydrolase (P- $\beta$ -gal). The phosphorylated galactose is suitably modified via the tagatose pathway to feed into the major pathway(s) of carbohydrate metabolism. There are a few unique lactococcal strains that transport lactose via

the  $\beta$ -galactoside permease. The lactose that is conveyed into the cell is split into glucose and galactose by the enzyme  $\beta$ -galactosidase ( $\beta$ -gal). Galactose is modified through the Leloir pathway for feeding into major pathway(s) of carbohydrate metabolism. Homofermentative lactococci metabolize carbohydrates through the hexose monophosphate pathway (HMP or EMP). Figure 6.1 depicts the homofermentative pathway for lactose metabolism among lactococci.

Under normal fermentative conditions, homolactic fermentation is dominant in lactococci. Low levels of enzymes operative in heterolactic fermentation, however, have been detected in lactococci. Under certain conditions, for example aeration, the eclipsed heterolactic pathway enzymes in lactococci are also expressed, giving rise to mixed end products.

### Citrate Metabolism in Lactococci

Citrate metabolism by Cit<sup>+</sup> lactococci plays a significant part in flavor generation in cultured dairy products. Some of the features of citrate utilization by starter bacteria were discussed earlier. Citrate is translocated into the cells by citrate permease, which is optimally active at slightly acidic conditions (<pH 6.0). Citrate metabolic pathway in mesophilic starter bacteria is shown in Figure 6.2.

Pyruvate plays a central role in carbon metabolism. As seen in Figures 6.1 and 6.2, metabolism of lactose

**Table 6.5.** Differentiating Characteristics for the Dairy Lactococci

Subspecies	Growth At		Arginine Hydrolysis	Citrate Utilization
	41°C	4% salt		
<i>lactis</i>	+	+	+	—
<i>lactis</i> biovar. <i>diacetylactis</i>	+	+	+/-	+
<i>cremoris</i>	—	—	—	—

Note: + = Positive for the trait (number of symbols represent degree of expression); — = Negative for the trait.

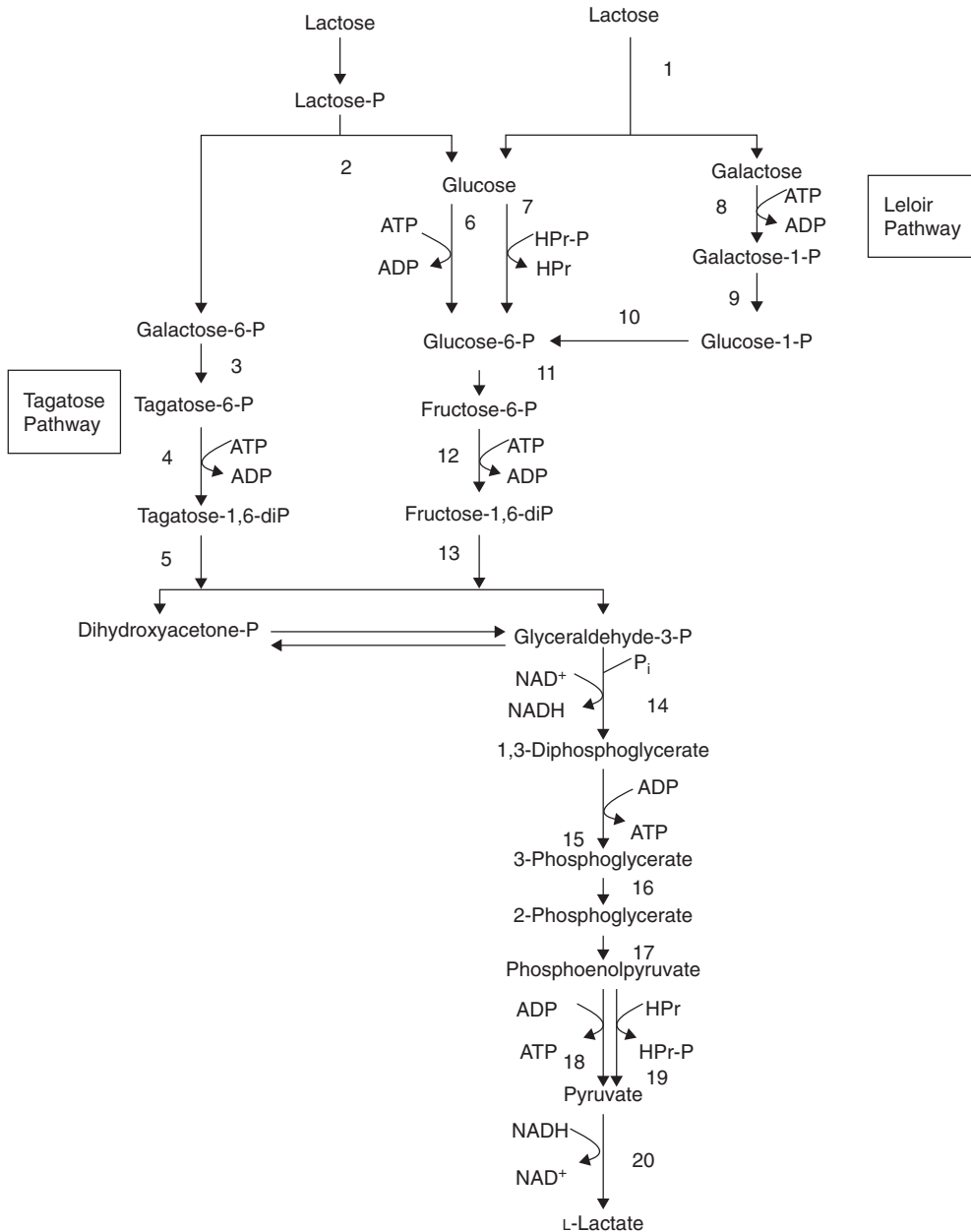

**Figure 6.1.** Embden-Meyerhoff -parnas pathway for lactose metabolism among homofermentative lactic acid bacteria. 1 =  $\beta$ -galactosidase, 2 = P- $\beta$ -galactosidase, 3 = galactose 6-phosphate isomerase, 4 = tagatose-6-phosphate kinase, 5 = tagatose-1,6-diphosphate aldolase, 6 = glucokinase, 7 = enzyme II, 8 = galactokinase, 9 = glucose:galactose-1-phosphate uridylyl transferase uridine diphosphate-glucose epimerase, 10 = phosphoglucomutase, 11 = phosphogucose isomerase, 12 = phosphofruktokinase, 13 = fructose-1,6-diphosphate aldolase, 14 = triose phosphate dehydrogenase, 15 = phosphoglycerokinase, 16 = phosphoglyceromutase, 17 = enolase, 18 = pyruvate kinase, 19 = enzyme I, 20 = lactate dehydrogenase. Adapted from Zourari et al., 1992; Cogan and Accolas, 1996; Hutkins, 2001; and Ray, 2004.

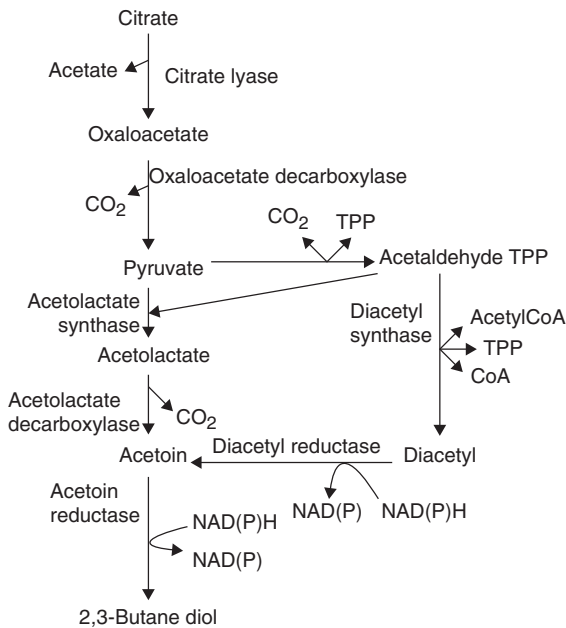

**Figure 6.2.** Pathway for citrate metabolism among starter lactic acid bacteria. Adapted from Hutkins, 2001, and Ray, 2004.

and citrate leads to the formation of pyruvate. Pyruvate derived from lactose is converted into lactic acid to keep the cycle sustained by regeneration of nicotinamide adenine diphosphate ( $\text{NAD}^+$ ). When the intracellular level of pyruvate increases with additional accretion from citrate, the cell has to find a way to detoxify excess pyruvate. Detoxification is achieved by converting pyruvate to neutral C-4 compounds such as diacetyl and its reduced forms. Citrate metabolism does not yield bond energy, but serves in keeping the cellular oxidative–reductive power in balance.

Diacetyl derived from citrate does not accumulate indefinitely. When the concentration of citrate falls below a critical threshold, diacetyl is rapidly reduced to acetoin and further to 2,3-butanediol. The reduction of diacetyl results in the loss of the characteristic nutmeat flavor of cultured dairy products. It is crucial that the desirable nutmeat flavor is conserved in the cultured product. The reduction of diacetyl plays a physiological role in the regeneration of  $\text{NAD}^+$  to keep the cycle operative. There are a few practical steps that could be taken to conserve diacetyl. Under normal incubation temperatures used for production of cultured buttermilk and sour cream (21–24°C), the product should be cooled rapidly soon after the

titratable acidity of the product reaches 0.75–0.8%. At that level of acidity, the diacetyl concentration is at its peak. Rapid cooling will retard the reduction of diacetyl by the enzyme diacetyl reductase and conserve the flavor. If a greater acidity (>0.8%) is desired in the product, the rapid reduction of diacetyl could be arrested by initial fortification of the milk or dairy mix with citrate (regulations allow addition of 0.15% citrate in cultured buttermilk and sour cream). Sufficient availability of citrate not only provides higher concentration of precursor for diacetyl, but also acts as a damper against diacetyl reductase activity. Another way to prevent the loss of diacetyl is to incorporate air into the product, accompanied by rapid cooling once the acidity reaches 0.8%. This could be done by agitation.  $\text{Cit}^+$  lactococci possess a class of  $\text{NAD}$ —oxidases that facilitate the transfer of hydrogens from  $\text{NADH} + \text{H}^+$  (reduced nicotinamide adenine dinucleotide) directly to oxygen (or air) with the formation of nontoxic water and molecular oxygen as by-products. The reaction thus provides an alternate route for the regeneration  $\text{NAD}^+$ . The alternate regeneration mechanism thus spares diacetyl from functioning as the hydrogen acceptor. The entire operation could be accomplished by simultaneous cooling of the product with gentle agitation to

incorporate air. Agitation also helps in rapid heat transfer.

With the rapid strides in biochemical analyses, enzyme assays, and molecular biology, strategies have been worked out for metabolic engineering of high diacetyl-producing lactococci. A few successful genetic constructs with high potential have already been made. For information on these subjects, the reader is encouraged to consult references listed at the end of this chapter.

More is now known about the nature of EPS produced by lactococci, the pathways involved in the synthesis of EPS, and the genetic sequences that code for EPS production. Some of these aspects are covered under specific cultured products discussed elsewhere in this book. References provided at the end of this chapter should be consulted for greater details.

### Comments on Cit<sup>+</sup> *L. lactis* subsp. *lactis*

Generally, citrate-metabolizing lactococci are slow acid producers. Most strains take longer than 20–24 hours to form a *firm* coagulum in milk. Most strains produce a lot of gas (CO<sub>2</sub>) in milk. They produce a fairly high concentration of diacetyl in milk, but they also rapidly reduce diacetyl (have an active diacetyl reductase). They are capable of competing well in the presence of rapid acid-generating (non-citrate-fermenting) lactococci. They, however, produce relatively high concentrations of acetaldehyde, which skews the ratio of diacetyl and acetaldehyde in favor of the aldehyde. This imparts an undesirable “green apple flavor” to cultured buttermilk and sour cream. For this reason, they are not generally preferred in starters for cultured buttermilk and sour cream.

### GENUS *LEUCONOSTOC*

Dairy leuconostocs constitute the secondary or associated bacteria in mesophilic lactic acid starters. The function of leuconostocs in these starters is flavor generation. Leuconostocs in pure cultures in milk do not bring about much change, and are generally considered inert. In association with lactococci, however, leuconostoc metabolize citrate present in milk to produce diacetyl. Dairy leuconostocs ferment lactose, but *very slowly*. Lactococci and leuconostocs act synergistically in generating diacetyl from citrate found in milk. For optimal activity of citrate permease, acid environment is necessary. The lactococci, which rapidly ferment lactose in milk, facilitate the uptake of citrate by leuconostocs. Leuconostocs

possess the enzymes necessary to ferment citrate to diacetyl, but the associated acid-producing lactococci (subspecies *cremoris* and Cit<sup>-</sup> *lactis*) lack these enzymes. Thus, diacetyl generation by mesophilic lactic starters represents coordinate or cooperative activity of lactococci and leuconostocs.

In selecting *Leuconostoc* strains for inclusion in mixed starters, *functional compatibility* with lactococci should be first determined. Otherwise, the cultures will fail to generate flavor in the cultured product. Leuconostocs lack the metabolic vigor of lactococci in milk, and to get good flavor generation, lower incubation temperature is necessary so that a balanced growth of both leuconostocs and lactococci is obtained.

The natural habitat of leuconostocs, like the lactococci, is vegetable matter containing fermentable sugars. They are introduced in dairy environs from the green pasture and via fodder fed to the cows. Morphologically, leuconostocs are spherical cells occurring in long chains. They are Gram-positive bacteria, and display unusual resistance to fairly high concentration (about 500 µg/ml) vancomycin, an antibiotic. Leuconostocs are heterofermentative and produce D-lactic acid. They are like other LAB, catalase-negative. The citrate metabolic pathway in leuconostocs is the same as that for Cit<sup>+</sup> lactococci (Fig. 6.2). The heterofermentative dissimilation of sugar by leuconostocs through the phosphoketolase pathway (PK) is shown in Figure 6.3. Lactose is transported in leuconostocs by β-galactoside permease, and the disaccharide is cleaved into its hexose units by β-galactosidase.

### GENUS *STREPTOCOCCUS*

*Streptococcus thermophilus* is the only species in the genus that is used in dairy starter cultures. The organism is thermotolerant, and is used in dairy fermentations that require a little higher temperature for incubation and processing (incubation at 35–43°C; processing or cooking of certain cheese in the temperature range of 48–53°C). Young cells of *S. thermophilus* are spherical in shape and occur in chains. Older cultures or colonial growth on solid media often display altered morphology, almost resembling short rod-shaped bacteria. *S. thermophilus* is included in Sherman’s *varidans* group, but does not fall under any of Lansfield’s serological groupings. Transportation of lactose into *S. thermophilus* cells is mediated by β-galactoside permease, and β-galactosidase cleaves the disaccharide. The organism metabolizes

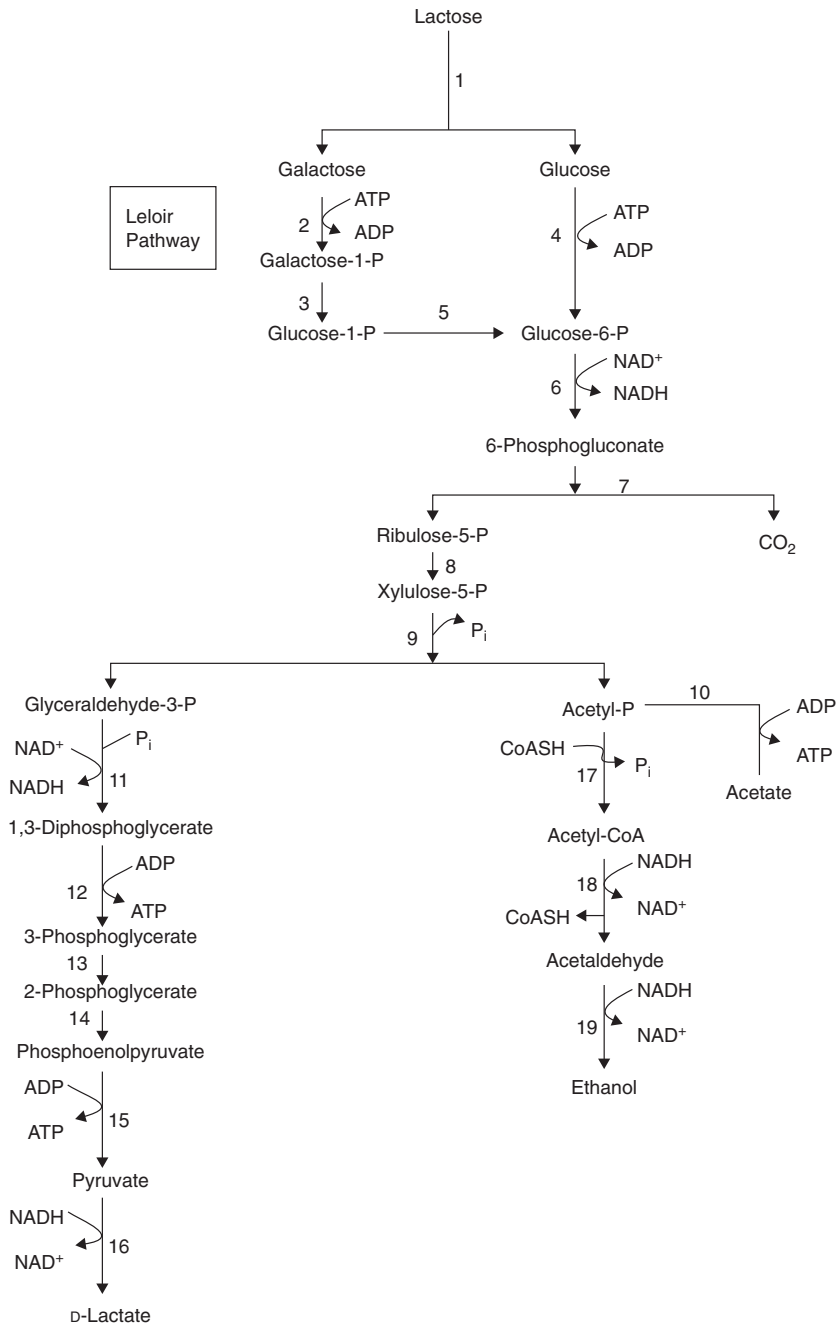

**Figure 6.3.** Heterofermentative pathway for lactose metabolism among starter lactic acid bacteria. 1 =  $\beta$ -galactosidase, 2 = galactokinase, 3 = glucose:galactose-1-phosphate uridylyl transferase uridine diphosphate-glucose epimerase, 4 = glucokinase, 5 = phosphoglucomutase, 6 = glucose-6-phosphate dehydrogenase, 7 = 6-phosphogluconate dehydrogenase, 8 = epimerase, 9 = phosphoketolase, 10 = acetate kinase, 11 = triose phosphate dehydrogenase, 12 = phosphoglycerokinase, 13 = phosphoglyceromutase, 14 = enolase, 15 = pyruvate kinase, 16 = lactate dehydrogenase, 17 = phosphoacetyl transferase, 18 = acetaldehyde dehydrogenase, 19 = ethanol dehydrogenase. Adapted from Hutkins, 2001, and Ray, 2004.

only the glucose portion of lactose via HMP, and galactose is expelled from the cell into the environment. In the dairy industry, the organism is often referred to as “coccus.”

*S. thermophilus* cultures generally produce a weak coagulum in milk because of low acid production. Some strains, however, are rapid acid producers and generate acidity comparable to lactococci. The acid-producing ability of *S. thermophilus* strains was recently shown to be *inversely related* to its urease activity. Urea normally occurs in milk, and the enzyme urease splits urea into ammonia and carbon dioxide. *S. thermophilus* strains are normally used in association with *Lb. delbrueckii* subsp. *bulgaricus*. The *Lactobacillus* subspecies is commonly referred to as “rod” in the dairy industry, and the *combination of the two bacteria* is called “rod-coccus.” The rod-coccus combinations display *synergistic* growth response in milk. To maximize the synergistic effect, strains of *the bacteria need to be paired with care after experimenting with various combinations*.

The synergism between the coccus and the rod is rooted in their individual physiological characteristics. *S. thermophilus* is more aerotolerant than *Lb. bulgaricus*. The coccus lacks good proteolytic ability relative to the rod, but possesses greater peptidase activity than the rod. When growing together in milk, *S. thermophilus* grows vigorously at first, because of greater aerotolerance. The rod at this stage grows slowly but because of its greater proteolytic activity provides sufficient peptides to stimulate the growth of the coccus. Fermentation by *S. thermophilus* depresses the oxidation–reduction O/R potential of the system, and releases formate as a metabolic by-product. Lowered oxygen tension and formate in turn stimulate *Lb. bulgaricus* growth, which is further aided by the amino acids released by the active peptidases secreted by the coccus. The coordinated tandem activities of the coccus and the rod accelerate the entire fermentation, which neither the coccus nor the rod would be able to achieve individually. The dominance of *S. thermophilus* in the milk fermentation wanes when the pH approaches 5.0. Beyond that, *Lb. bulgaricus* gradually supplants the coccus in the overall fermentation.

The cell morphology of *S. thermophilus* as it appears under a light microscope is shown in Figure 6.4. In Figure 6.5, the cell morphology of *Lb. bulgaricus* is shown. Cells of yogurt starter bacteria in a microscopic smear are shown in Figure 6.6.

*S. thermophilus* strains also produce EPS. Such strains are used in yogurt fermentations to obtain



**Figure 6.4.** Stained cells of *Streptococcus thermophilus* under light microscope.

viscous body and smooth texture. The genetics and physiology of EPS production by coccus are now well understood. More information on the genetics of *S. thermophilus* is now available in the literature.

## GENUS *LACTOBACILLUS*

Lactobacilli are rod-shaped, Gram-positive bacteria. Morphologically, they are variable. Some occur as long slender straight rods; others are curved. Some others are short, almost coccoid rods. A few exhibit pleomorphic cells. On the basis of sugar metabolism, lactobacilli are divided into three groups. The lactobacilli generally used as starters for cultured milks are *Lb. delbrueckii* subsp. *bulgaricus* and *Lb. acidophilus*. Occasionally, *Lb. delbrueckii* subsp. *lactis* may be used. All the aforementioned lactobacilli belong to group 1. Group 1 lactobacilli ferment hexoses via HMP to lactic acid, and do not ferment pentoses. The morphological and physiological characteristics





**Figure 6.5.** Stained cells of *Lactobacillus delbrueckii* ssp. *bulgaricus* under light microscope.

of lactobacilli used in dairy starter cultures are given in Tables 6.2–6.4.

*Lb. bulgaricus* is used in combination with *S. thermophilus* for the production of yogurt and the industrial production of dahi. *Lb. bulgaricus* is an extremely fastidious organism. Lack of certain essential nutrients and minerals in propagation medium affects the cellular integrity of these bacteria, and the cells exhibit abnormal morphology under nutritional stress. Additionally, commercial preparation of “rod” cultures is an extremely challenging task, because of their nutritional and environmental (temperature and pH control, exclusion of air) fastidiousness, compounded by the need for close control of harvesting and preservation operations.

*Lactobacillus* subsp. *lactis*, on the other hand, is comparatively a rugged organism and is easier to grow and concentrate. Because regulations call for the use of subspecies *bulgaricus* in yogurt, the use of subspecies *lactis* in yogurt starters is no more practiced.

*Lb. acidophilus* is a unique organism that is found in the gut of humans, animals, and birds. The organism possesses the characteristics necessary to survive the harsh environmental conditions in the gut, namely, high acid tolerance and tolerance of surface-reducing effect of bile salts. *Lb. acidophilus* grows slowly in milk, but produces high amounts of lactic acid. It is used for the production of *acidophilus* milk, which is a highly acidic, acrid product. *Acidophilus*



**Figure 6.6.** Stained microscopic smear of yogurt bacteria.

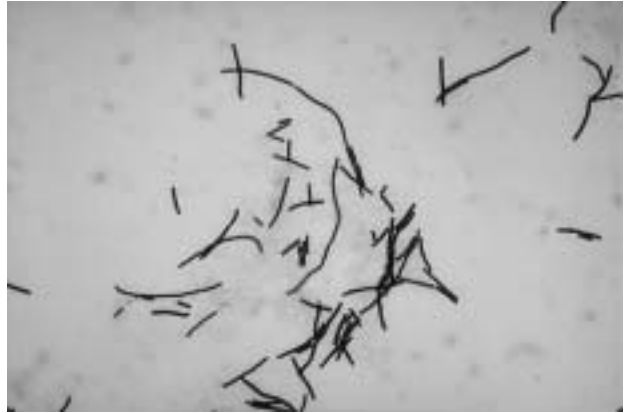

**Figure 6.7.** Stained cells of *Lactobacillus acidophilus* under light microscope.

milk, however, has long been known to be therapeutic, and helpful in maintaining intestinal health. It is the forerunner of the present-day sweet acidophilus milk and probiotic milks. For a more extensive discussion of the use of *Lb. acidophilus* in cultured dairy products, the chapters in this book dealing with yogurt and probiotic milk(s) should be consulted. Cells of *Lb. acidophilus* are shown in Figure 6.7.

Lactobacilli are also used as *probiotic cultures*. Probiotics are microbial cell preparations that have a beneficial effect on health and well-being of the host. Probiotic cultures may be incorporated into fermented and nonfermented milk products to provide beneficial health effects to the consumer. Probiotic cultures, however, *cannot be classified as starter cultures*, because probiotic cultures do not play a part in the fermentation or the preparation of the dairy product. The cultured or the noncultured milk serves as the carrier or the vehicle for the delivery of the health-promoting probiotic cells. Table 6.6 lists various probiotic microorganisms in commercial products. Several *Lactobacillus* spp. are included in the list.

## GENUS BIFIDOBACTERIUM

Genus *Bifidobacterium* consists of cleft, rod-shaped bacteria in the shape of the letter “Y.” Not all cells in a culture exhibit the split, Y-shaped morphology; most of the cells occur as short straight rods. Bifidobacteria are obligate anaerobes and are catalase-negative. Some strains may tolerate limited amount of air slightly better than others. They are classified under *Actinomyces*, a subdivision under eubacteria.

**Table 6.6.** Microorganisms Used as Probiotics

<i>Lactobacillus</i> spp.	<i>Bifidobacterium</i> spp.
<i>L. acidophilus</i>	
<i>L. casei</i>	
<i>L. reuteri</i>	
<i>L. gasseri</i> ADH	
<i>L. johnsoni</i> LAI	<i>B. bifidum</i>
<i>L. plantarum</i>	<i>B. longum</i>
<i>L. casei</i> subsp. <i>rhamnosus</i>	<i>B. infantis</i>
<i>L. brevis</i>	<i>B. breve</i>
<i>L. delbrueckii</i> subsp. <i>bulgaricus</i>	<i>B. adolescentis</i>
<i>L. fermentum</i>	<i>B. animalis</i>
<i>L. helveticus</i>	

### Other organisms

*Streptococcus thermophilus*

*Enterococcus faecium*

*Pediococcus acidilactici*

*Saccharomyces boulardii*

*Source:* Reproduced with permission from Chandan RC. 1999. Enhancing market value of milk. *J. Dairy Sci.* 62:2248, American Dairy Science Association.

Nutritionally bifidobacteria are fastidious. They are from a portion of the normal intestinal flora of humans. Bifidobacteria could be isolated from the feces of newborn infants. The bifidobacterial species found in newborn infants differ from that found in adults. Bifidobacteria are considered to play a role in regulating the ecology and microbial flora of the gut. This role is considered to have a beneficial,

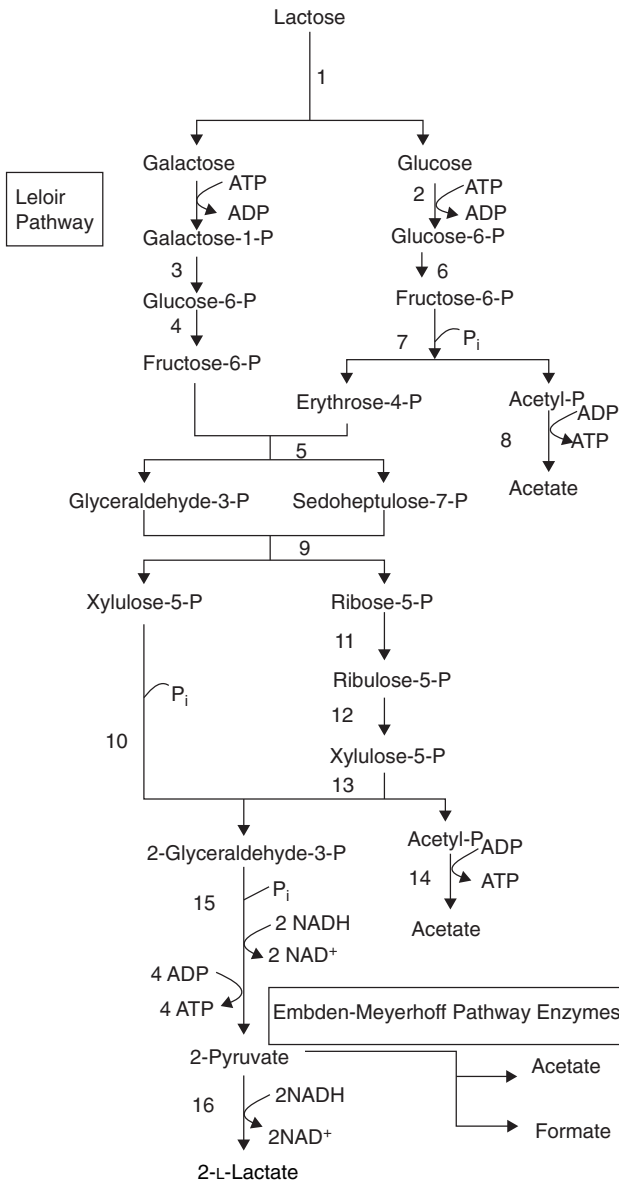

**Figure 6.8.** Pathway used by Bifidobacteria for lactose metabolism.

1 =  $\beta$ -galactosidase, 2 = glucokinase, 3 = phosphoglucose mutase, 4 = phosphoglucose isomerase, 5 = transaldolase, 6 = phosphoglucose isomerase, 7 = fructose-6-phosphate phosphoketolase, 8 = acetate kinase, 9 = transketolase, 10 = xylulose-5-phosphate phosphoketolase, 11 = ribose-5-phosphate isomerase, 12 = ribulose-5-phosphate-3 epimerase, 13 = xylulose-5-phosphate phosphoketolase, 14 = acetate kinase, 15 = Embden-Meyerhoff pathway enzymes, 16 = lactate dehydrogenase. Adapted from Cogan and Accolas, 1996, and Ray, 2004.

probiotic effect on intestinal health. Bifidobacteria use a unique pathway for carbohydrate metabolism. The by-products consist of a mixture of acetic and lactic acids. The pathway includes a unique enzyme, fructose-6-phosphate phosphoketolase, and is used as a key diagnostic test to identify bifidobacteria. The pathway for lactose metabolism by bifidobacteria is depicted in Figure 6.8.

Because of the anaerobic nature of bifidobacteria, they are somewhat difficult to grow, harvest, and preserve. Their viability is of critical importance in their use as probiotics. Their interaction with yogurt starter bacteria and other probiotic lactobacilli greatly influences their viability in these systems. Hydrogen peroxide generated by the associated flora also affects bifidobacterial viability in mixed culture systems.

Further details are given in the chapter dealing with probiotic milks in this book.

## STARTER CULTURE PRODUCTION

This section may be discussed under two subheadings, namely, bulk starter production in the dairy plant and commercial starter culture production. With the exception of yogurt production, where bulk starters are still widely used, for most other cultured dairy products, commercial, concentrated direct-to-vat-set (DVS) cultures are used to inoculate product vats. For probiotic supplementation of cultured dairy products and nonfermented milk, DVS cultures of probiotics are used. Currently DVS cultures to inoculate up to 4,000 liters are commercially available.

### BULK STARTER PRODUCTION

Unlike starters for cheese production, starter cultures for cultured milks are made with milk. Reconstituted skim milk powder (nonfat dry milk powder) is preferred for making up starter cultures, because consistency in composition, microbial quality, and absence of inhibitors and antibiotics are necessary. Pretested nonfat milk powder (tested for absence of inhibitors, good solubility, and for supporting good growth and “activity” of cultures) procured in bulk from specific lots are reserved for starter production. The powder is reconstituted to give 10–11% solids.

Stainless steel double-jacketed vats equipped with suitable agitators, connected to appropriate plumbing for circulating hot and cold water (for heating and cooling cycles), and provided with thermostat equipment for temperature control are used. The vats also need sufficient number of sanitary ports for venting, sampling, and temperature and pH probes. The vents need filter setup to exclude microflora and phage during cooling, when pressure equilibration takes place. Additional ports for adding the inoculum or other materials are also provided. Another requirement is to have a manhole for inspecting and manual cleaning of the vat periodically. Additionally, provisions should be made for cleaning-in-place (spray-ball) connection to the vats.

The preparation of starter consists of the following steps:

1. Reconstitution of skim milk powder to the required solids level by metering in the required volume of water, followed by the addition of weighed

amount of powder and mixing to get the solids completely dissolved. Care should be exercised to wash down any milk solids adhering to the sides of the vat above the liquid level.

2. Heating the milk to 85–90°C, and holding at that temperature for 30–45 minutes to destroy contaminants in the milk including spore-forming bacteria and phages if any.
3. Cooling to the required incubation temperature by turning on the chill water with the agitator turned on.
4. Inoculation with the culture using aseptic precautions with agitation to uniformly mix in the inoculum.
5. Incubating at thermostatically preset temperature quiescently. If the temperature and pH recording equipment are connected to the vat, they need to be turned on.
6. When the desired pH is reached, cooling with agitation should be promptly initiated. Agitation should be slow and gentle. The starter is ready for use once the cooling to the desired temperature (preferably 5–7°C if needed to be held longer before use) is reached.

The incubation temperature would vary with the starter flora. For cultured buttermilk and sour cream production, the starter is incubated at 20–22°C. For yogurt, the starter is incubated at 35–37°C if it contains EPS producers; for regular yogurt starters, most dairy plants incubate them at around 40–43°C. Careful calibration of temperature and pH probes at least twice a week is recommended. It is advisable to use the starter as soon as it is ready. Other precautions were discussed earlier in this chapter.

Very few dairy plants nowadays carry their own strains or maintain a frozen or lyophilized stock. From the stock culture a mother culture is prepared. The mother culture is made up in volumes no greater than 1 liter. The milk used in mother culture is heat-treated in a steam chamber for 45 minutes. The mother culture is used to inoculate an intermediate culture, which is used to inoculate the starter vat. Inoculation rate for cultured buttermilk and sour cream production is normally 1.0%. Current yogurt production demanding 4-hour turnovers require inoculation rates ranging from 2.5% to 5.0%. To attain shorter incubation time in product vats, higher incubation temperature (40–42°C) is necessary. For more detailed information on starter preparation for the various products discussed in this book, the relevant chapters should be consulted.

## COMMERCIAL STARTER CULTURE PRODUCTION

Commercial starter culture production is a highly demanding operation. It requires specialized knowledge of microbiology, microbial physiology, process engineering, and cryobiology. In addition to production knowledge, a full-fledged quality control program is necessary to test incoming raw materials, design and maintain plant sanitation, test sterility of production contact surfaces, monitor plant environment quality, and test every product lot for the prescribed quality standards. The quality control section is also required to train and update plant personnel on the importance of sanitation and strict adherence to process control protocols. The maintenance of the starter culture strain bank, and the entire stepwise process of preparing the final inoculum for the large-scale fermentor (from the stock or “seed” culture stage), falls under the purview of the quality control section.

Commercial starter cultures currently available for direct addition to production vats contain billions of viable bacteria per gram, preserved in a form that could be readily and rapidly activated in the product mix to perform the functions necessary to transform the product mix to the desired cultured product. To attain that, the selected starter bacteria need to be grown in a suitable menstruum to high numbers and to concentrate the cells. The composition of the media used to grow various bacteria differs. Usually, the materials used in the growth media consist of food-grade, agricultural by-products and their derivatives. The trade has special requirements for the raw materials that go into media formulations and for the way they are mixed and processed. Examples of such requirements include Kosher standards, absence of ingredients derived from genetically modified crops, absence of allergenic materials, etc.

The generally used ingredients in media formulations include nonfat milk, whey, hydrolysates of milk and whey proteins, soy isolates, soy protein hydrolysates, meat hydrolysates and extracts, egg proteins, corn steep liquor, malt extracts, potato infusions, yeast extracts/yeast autolysates, sugars such as lactose, glucose, high-fructose corn syrup, corn sugar, sucrose, and minerals such as magnesium, manganese, calcium, iron, phosphates, salt, etc. For some fastidious bacteria, amino acids and vitamins may be included. The phosphates are added to provide mineral requirements as well as for buffering. For some bacteria, which need unsaturated fatty acids

to protect cell membranes, trace quantities of polysorbates (Tweens) are added. To control foaming, food-grade antifoam ingredients may be incorporated.

The medium is then either sterilized by heating at 121°C for a minimum of 15 minutes or heat-treated at 85–95°C for 45 minutes or subjected to ultra-high temperature treatment (UHT) for a few seconds. After heat treatment, the medium is cooled to the incubation temperature. After the addition of the inoculum, the medium is incubated until the predetermined endpoint is reached. During incubation, the pH is maintained at a predetermined level (constant neutralization to maintain pH). Generally, the endpoint coincides with the exhaustion of sugar reflected by the trace of the neutralization curve. The frequency of neutralization reflects the activity of the culture in the fermentor, and when the frequency decreases, it indicates the near depletion of the sugar. Samples are usually taken to microscopically examine the fermentate for cell morphology, for any gross contamination, for a rough estimation of cell numbers, and for quantitative measurement of sugar content. After ascertaining these, the fermentor is cooled.

The cells are harvested either by centrifugation or by ultrafiltration. The cell concentrate is obtained in the form of a thick liquid of the consistency of cream and is weighed and rapidly cooled. Sterile preparations of cryoprotectants (glycerol, nonfat milk, monosodium glutamate, sugars, etc.) are added, and uniformly mixed with the cell concentrate. The concentrate may be filled as such into cans and frozen or frozen in droplet form in liquid nitrogen (pellets), retrieved, and packaged. The concentrate as such or in pellet form may also be lyophilized in industrial-scale freeze dryers.

Quality control tests for commercial cultures include the following:

- Viable cell numbers.
- Absence of contaminants, pathogens, and extraneous matter.
- Acid-producing and other functional activities.
- Package integrity, accuracy of label information on the package.
- Shelf life of the product according to specification.

### Miscellaneous Starters

In traditional production of Kefir, the starter consists of Kefir grains. Kefir grains are made up of polysaccharide matrix with a convoluted structure. Within

the folds of the grain yeasts, an assortment of LAB is found. This flora is responsible for Kefir fermentation. The grains could be reused. After the completion of one batch, the grains are strained out, washed in water, dried, and reused. More details on the Kefir grains and other starters used in Koumiss production are discussed in the chapter dealing with those products.

## BIBLIOGRAPHY

Literature on starter cultures is extensive and voluminous. It is difficult to cover the vast amount of information on starter culture bacteria in a chapter. Literature citations were deliberately avoided in this chapter to provide continuity, and to avoid an extensive bibliography. Instead references for the following books, book chapters, monographs, reviews and research articles are provided for the reader to gain a greater understanding of starter flora, their physiology, their genetics, their functions in fermented dairy products, and their various applications in dairy foods.

For a comprehensive treatment of starter cultures, the reader should consult *Dairy Starter Cultures* (1996), *Bacterial Starter Cultures for Foods* (1985), and *Lactic Acid Bacteria—Microbiology and Functional Aspects* (1998). For the technology and practical aspects of dairy starter cultures, the monograph *Lactic Starter Culture Technology* is recommended.

Other practical information on starter cultures may be gleaned from *Cheese and Fermented Milk Foods*, Volumes I and II (1997), and the trade publication *Cultures for the Manufacture of Dairy Products* (1985). For historical and basic information on lactic starter cultures, the book *Dairy Microbiology* (1957) is excellent.

There are chapters from several books that deal with starter cultures. They contain valuable information. In *Dairy Microbiology Handbook* (2002), Tamime has covered several aspects of the organisms used in dairy starter cultures, and their production. In *Food Biotechnology* (1995), dairy lactococci are discussed by Sanders, dairy lactobacilli by Arihara and Luchansky, and dairy leuconostocs by Dessart and Steenson. The book *Applied Dairy Microbiology* (1998) contains a chapter on starter cultures by Frank and Hassan, and the genetics and metabolism of starter cultures are covered by Steele. Vedamuthu has discussed the role of starter cultures in flavor generation in fermented foods in a chapter in *Handbook on Anaerobic Fermentations* (1988).

The recommended reviews listed below cover specific starter bacteria, bacteriophages affecting starter bacteria, genetics and physiology of EPS production by starter bacteria, and other relevant topics on starter bacteria.

## BOOKS

- Cogan TM, Accolas J-P (Eds). 1996. *Dairy Starter Cultures*. VCH Publishers, New York, p. 277.
- Foster EM, Nelson FE, Speck ML, Doetsch RN, Olson JC Jr. 1957. *Dairy Microbiology*. Prentice-Hall, Englewood Cliffs, NJ, p. 492.
- Gilliland SE (Ed). 1985. *Bacterial Starter Cultures for Foods*. CRC Press, Boca Raton, FL, p. 205.
- Kosikowski FV, Mistry VV. 1997. *Cheese and Fermented Milk Foods*, Vols. I and II, 3rd ed. F.V. Kosikowski, L.L.C., Westport, CT.
- Ray B. 2004. *Fundamental Food Microbiology*. CRC Press, Boca Raton, FL, pp. 142–146.
- Salminen S, von Wright A (Eds). 1998. *Lactic Acid Bacteria—Microbiology and Functional Aspects*. Marcel Dekker, New York, p. 617.
- Sandine WE. 1979. *Lactic Starter Culture Technology*, Pfizer Cheese Monographs. Pfizer Inc., New York, p. 55.
- Sellars RL, Babel FJ. 1985. *Cultures for the Manufacture of Dairy Products*, 2nd ed. Chr. Hansen's Laboratory Inc., Milwaukee, WI, p. 62.

## CHAPTERS IN BOOKS

- Arihara K, Luchansky JB. 1995. Dairy Lactobacilli. In: YH Hui, GG Khachatourians (Eds), *Food Biotechnology: Microorganisms*. VCH Publishers, New York, pp. 609–643.
- Chandan RC, Shahani KM. 1995. Other fermented dairy products. In: H-J Rehm, G Reed (Eds), *Biotechnology, Vol. 9: Enzymes, Biomass, Food and Feed*. VCH Publishers, New York, pp. 386–418.
- Dessart SR, Steenson LR. 1995. Biotechnology of dairy *Leuconostoc*. In: YH Hui, GG Khachatourians (Eds), *Food Biotechnology: Microorganisms*. VCH Publishers, New York, pp. 665–702.
- Frank JF, Hassan AN. 2001. Starter cultures and their use. In: EH Marth, JL Steele (Eds), *Applied Dairy Microbiology*, 2nd ed. Marcel Dekker, New York, pp. 151–206.
- Hutkins RW. 2001. Metabolism of starter cultures. In: EH Marth, JL Steele (Eds), *Applied Dairy Microbiology*, 2nd ed. Marcel Dekker, New York, pp. 207–241.

- Porubcan RS, Sellars RL. 1979. Lactic starter culture concentrates. In: HJ Peppler, D Perlman (Eds), *Microbial Technology*, Vol. 1, 2nd ed. Academic Press, New York, pp. 59–92.
- Sanders ME. 1995. Lactococci. In: YH Hui, GG Khachatourians (Eds), *Food Biotechnology: Microorganisms*. VCH Publishers, New York, pp. 645–664.
- Steele JL. 1998. Genetics and metabolism of starter cultures. In: EH Marth, JL Steele (Eds), *Applied Dairy Microbiology*, 1st ed. Marcel Dekker, New York, pp. 173–194.
- Tamime AY. 2002. Microbiology of starter cultures. In: RK Robinson (Ed), *Dairy Microbiology Handbook: Microbiology of Milk and Milk Products*, 3rd ed. John Wiley & Sons, New York, pp. 261–366.
- Vedamuthu ER. 1998. Engineering flavor into fermented foods. In: LE Erickson, DCY Fung (Eds), *Handbook on Anaerobic Fermentations*. Marcel Dekker, New York, pp. 641–694.
- REVIEW ARTICLES AND RESEARCH PAPERS**
- Allison GE, Klaenhammer TR. 1998. Phage resistance mechanisms in lactic acid bacteria. *Int. Dairy J.* 8:207–226.
- Boucher I, Moineau S. 2001. Phages of *Lactococcus lactis*: An ecological and economical equilibrium. *Recent Res. Dev. Virol.* 3:243–256.
- Broadbent JR, McMahon DJ, Walker DL, Oberg CJ, Moineau S. 2003. Biochemistry, genetics and applications of exopolysaccharide production in *Streptococcus thermophilus*: A review. *J. Dairy Sci.* 86:407–423.
- Chandan RC. 1999. Enhancing market value of milk by adding cultures. *J. Dairy Sci.* 82:2245–2256.
- Cogan TM, Peitersen N, Sellars RL. 1991. Starter system. *Bull. Int. Dairy Fed.* 263.
- Deveau H, Moineau S. 2003. Use of RFLP to characterize *Lactococcus lactis* strains producing exopolysaccharides. *J. Dairy Sci.* 86:1472–1475.
- Everson TC. 1991. Control of phage in the dairy plant. *Bull. Int. Dairy Fed.* 263.
- Hemme D, Foucaud-Scheunmann C. 2004. *Leuconostoc*, characteristics, use in dairy technology and prospects in functional foods. *Int. Dairy J.* 14:467–494.
- Hughenoltz JM. 1993. Citrate metabolism in lactic acid bacteria. *FEMS Microbiol. Rev.* 12:165–178.
- Hughenoltz JM, Starrenburg JC, Veerkamp AH. 1994. Diacetyl production by *Lactococcus lactis*: Optimisation and metabolic engineering. In: *Proceedings of the 6th European Congress on Biotechnology*, pp. 225–228.
- Mercenier A. 1990. Molecular genetics of *Streptococcus thermophilus*. *FEMS Microbiol. Rev.* 87:61–74.
- Moineau S, Tremblay D, Labrie S. 2002. Phages of lactic acid bacteria: From genomics to industrial applications. *ASM News* 68:388–393.
- Neve H, Teuber M. 1991. Basic microbiology and molecular biology of bacteriophages of lactic acid bacteria in dairies. *Bull. Int. Dairy Fed.* 263.
- Nomura M, Kobayashi M, Ohmomo S, Okamoto T. 2000. Inactivation of the glutamate dehydrogenase gene in *Lactococcus lactis* subsp. *cremoris*. *Appl. Environ. Microbiol.* 66:2235–2237.
- Oberg CJ, Broadbent JR. 1993. Thermophilic starter cultures: Another set of problems. *J. Dairy Sci.* 76:2392–2406.
- Orban JL, Patterson JA. 2000. Modification of the phosphoketolase assay for rapid identification of bifidobacteria. *J. Microbiol. Methods* 40:221–224.
- Van Kranenberg R. 1999. Exopolysaccharide biosynthesis in *Lactococcus lactis*: A molecular characterization. Doctoral Dissertation, Wageningen University, Holland, Ponsen Looijen BV, Wageningen, Holland.
- Vedamuthu ER. 1994. The dairy *Leuconostoc*: Use in dairy products. *J. Dairy Sci.* 77:2725–2737.
- Zourari A, Accolas JP, Desmazaud MJ. 1992. Metabolism and biochemical characteristics of yogurt bacteria. A review. *Lait* 72:1–34.

# 7

## Laboratory Analysis of Fermented Milks

*Robert T. Marshall*

- Compositional Tests
  - Tests for Fat Content
  - Tests for Moisture and Total Solids
  - Tests for Nonfat Milk Solids
  - Tests for Protein
  - Tests for Lactose
  - Titrateable Acidity
  - Measurement of pH
- Chemical Tests
  - Tests for Flavorful Substances
  - Tests for Free Fatty Acids
- Physical Properties Tests
  - Density and Specific Gravity
  - Rheological Tests
  - Water-Holding Capacity
- Microbiological Properties
  - Tests for Coliform Bacteria
  - Tests for *Enterobacteriaceae*
  - Yeast and Mold Counts
  - Tests for Culture Bacteria
- Antimicrobial Substances
- Sensory Tests
  - Preference Testing
  - Acceptance Testing
  - Descriptive Analysis
  - Sensory Tests for Quality Control
- References

Routine analyses of fermented milk products are limited normally to those that are pertaining to the gross composition of the product and to its quality and safety. The progress of fermentation is monitored with tests of the acidity or pH value. Composition is controlled primarily by tests done on the ingredients at the time of preparation of the basic mix. These tests are usually limited to the analyses of the content of fat and total solids of the dairy ingredients.

Tests of the fermented product, done prior to the addition of fruits, flavorings, and other additives, reveal whether the formulated and processed product meets the specifications. Together these pre- and postprocessing tests reveal whether the product contains the correct amount of valuable characterizing ingredients and has been fermented correctly. When flavorings or other additives are added, further testing may be needed to determine whether specifications for color, viscosity, flavor, distribution of particulates, and filling of containers have been satisfied. The finished product then needs to be tested for microorganisms that are indicators of postprocessing contamination. Usually this is done with a test for coliform bacteria or for enterobacteria. Some manufacturers test for yeasts and molds. Microbiological tests of ingredients are needed when significant risks to safety and/or quality are encountered.

This chapter has been designed to present a comprehensive discussion of tests that may be used with fermented dairy products and their ingredients. The categories are compositional, chemical, physical, microbiological, antimicrobial substance, and sensory tests. The approach used is to discuss the general principles and applications of the tests, to provide references of sources of most of them, and to comment on the utility of the tests.

### COMPOSITIONAL TESTS

The main purpose of compositional testing is to determine whether the amounts of valuable characterizing ingredients are within formulated tolerances. Most important among these are the milk fat and nonfat milk solids components. When concentrated or dried



sources of ingredients are used, moisture content or total solids must be known. Knowing these parameters, the process of standardization can proceed. For example, in preparing sour cream, nonfat milk may be combined with heavy cream to adjust the fat content to 18%. The formula then depends on how much fat is present in each ingredient and on how much the fat will be diluted with other additives such as nonfat milk and stabilizer.

## TESTS FOR FAT CONTENT

The volumetric Babcock and Gerber methods, the gravimetric ether extraction method, and instrumental tests are available. These methods are described in *Standard Methods for the Examination of Dairy Products* (Hooi et al., 2004). The International Dairy Federation has set tolerances for testing the percentage of fat in dairy foods as follows: milk, 0.02%; skim milk, 0.01%; and 20% cream, 0.1%. Application of a satisfactory method should result in no more than 5% of the tests falling outside these limits. Although the varying viscosities of cream make it necessary to weigh the sample in performing the Babcock and Gerber tests, the amount of fat extracted is determined by measurement of the height of fat column in the graduated cylinder of the test bottle. Applications of these “volumetric-type” tests are limited to liquid products, and added sugars may produce charred particles that occlude the fat column.

### Babcock Test

The method calls for measuring a specific volume of milk, nonfat milk, or cream into a bottle that has a calibrated neck, digesting the nonfat organic substances of the sample with concentrated sulfuric acid, centrifuging to separate the light-weight fat from the heavier serum. Then water is added to the sample to cause the fat to rise into a calibrated neck of the test bottle, and the sample is centrifuged again to cleanly separate the fat into the neck where its volume is measured. Close control of the temperature of the test is required, especially at the time of reading the volume of fat in the neck of the bottle. Heat produced by the chemical degradation of the milk’s protein and carbohydrate components, as well as the high density of the sulfuric acid provides a large difference in the densities of the serum and fat. In addition, the acid breaks the emulsion of the fat by digesting the fat globule membrane. Because of the large difference in the amount of fat contained in skim (nonfat) milk,

milk, and cream, diameters of the necks of test bottles vary directly with the expected fat content.

### Gerber Test

Similar to the Babcock test, a volume of sample is measured into a test bottle containing concentrated sulfuric acid. After the milk or cream is mixed with the acid, isoamyl alcohol is added and further mixing is done to fully digest the nonfat components. Centrifugation separates the fat from the aqueous phase, and tempering in a water bath permits reading of the volume of extracted fat in the calibrated neck of the specially designed Gerber test bottle.

### Ether Extraction Test

Precise determination of fat content is provided by the ether extraction method, which is also known as the Roese–Gottlieb test or the Mojonnier modification of that test. This is the official reference method for milk fat. Weighing of the sample and of the extracted fat reduces the probability of error that may be introduced by the volumetric measurements used in the Babcock and Gerber tests. Furthermore, this test is easily adapted to testing all types of fermented milk products regardless of their viscosity and composition. Ammonium hydroxide and ethanol are added to condition the sample prior to the extraction of fat with ethyl ether and petroleum ether. The lighter weight solvent layer that contains the fat is separated from the aqueous layer by centrifugation before it is poured into a clean, dried, and preweighed dish. Traces of fat are removed from the residue in the extraction flask by twice-repeated extractions with ether. The ether is then evaporated from the dish leaving the fat in the dish. After cooling in a desiccator, the dish plus fat is weighed and the net weight of the fat is determined. The percentage of fat is then calculated as weight of fat divided by weight of sample  $\times 100$ . Sample weight varies inversely with the percentage of fat expected in the sample. In transferring the sample to the extraction flask it is important to assure that the sample is homogenous. Warming of raw milk decreases the tendency for fat to stick to the surfaces of pipets.

### Instrumental Tests

The absorption of infrared energy at different wavelengths by certain bonds of fats, proteins, and

carbohydrates coupled with the abilities to measure that absorption has made possible the development of instruments that can quantify the amount of these components in milk and certain milk products. Optimal absorption is observed for carbonyl groups in ester linkages of fat molecules at 5.723 nm, for carbon to hydrogen bonds in fatty acids at 3.47 nm, for peptide linkages of proteins at 6.465 nm, and for hydroxyl groups in lactose molecules at 9.610 nm. Although absorption is not solely by these bonds, corrections can be made for absorption by other species of bonds. Although the instruments are expensive the rate of testing can be quite high. Samples of milk must be homogenized uniformly to minimize the error caused by light scattering. The instrument must be calibrated with samples of the same type of milk that are being tested by the reference method.

Another instrumental method of determining fat content of samples employs nuclear magnetic resonance (NMR) technology developed by the CEM Corporation. The sample must first be dried to remove hydrogen bound in water of the sample. The instrument then sends a pulse of radio-frequency energy through the sample causing the remaining hydrogen to generate a signal known as free induction decay (FID). The intensity of the FID is then analyzed to determine the amount of protons of the fat present in the sample. In the application by the CEM firm the sample is dried in their moisture/solids analyzer, rolled into a film, and inserted into the NMR chamber for analysis. The test is reported to have a precision of  $\pm 0.01\%$ , is applicable to a wide variety of samples, and requires a few minutes for completion ([www.cem.com](http://www.cem.com)).

## TESTS FOR MOISTURE AND TOTAL SOLIDS

### Hot Air Oven Tests

The rather simple test for moisture and total solids in most milk products involves evaporation of water from a weighed sample followed by weigh-back of the cooled dish containing the dry sample. Either a vacuum oven or a forced-draft oven may be used in the official method for fermented dairy foods (see *AOAC Official Methods of Analysis* or *Standard Methods for the Examination of Dairy Products*) (Horowitz, 2003; Wehr and Frank, 2004). The procedure calls for accurate and quick weighing of  $3 \pm 0.5$  g of sample into a dry "moisture dish" on an analytical balance. Conditions of drying vary with the type of sample and oven. The sand pan method for

concentrated dairy products, including yogurt, calls for adding about 25 g of clean sand and a small stirring rod to the weighing dish then drying this in a vacuum oven at  $102^\circ\text{C}$  for at least 1 hour. After the sample is weighed into the center of the cooled pan, the sample is mixed into the sand with the stirring rod and is covered with a dried fiberglass cover. The entire unit is then placed in the vacuum oven to dry for 2 hours at  $102^\circ\text{C}$  and at a minimum vacuum of  $-86$  kPa. After cooling the dish in a desiccator at room temperature for 45 minutes, the dish is weighed on an analytical balance. The percent moisture is calculated by dividing the loss in weight by the weight of the sample and then multiplying the result by 100. The percent solids is 100 minus the percent moisture. A small amount of dried air is permitted to pass through the oven during drying. The reference methods of the International Dairy Federation for milk, cream, and evaporated milk (Anonymous, 1987) and for yogurt (Anonymous, 1991) call for drying the samples at  $102^\circ\text{C}$ .

The forced-draft oven may be used for most of the milk products and their ingredients. After weighing into the dried dish, liquid samples are evaporated to a semidry state on a steam bath. Oven temperature for milk products is  $100^\circ\text{C}$  and the time of heating is 3 hours. Following drying the procedure continues as with the vacuum oven method.

### Microwave Oven Test

Moisture of solid and semisolid samples can be determined by a microwave oven method. Since microwave units vary in power and uniformity of distribution of that power, power setting, position in the unit, and time of drying must be determined for each unit and the expected moisture content of the sample. These results should be compared to the results obtained by a reference method. The sample, located between the dried fiberglass pads, is placed on the analytical balance inside the oven where it is weighed, dried, and weighed back. Some instruments provide direct reading of the moisture or solids.

### Infrared Instrument Test

Total solids in milk can be estimated using infrared milk analysis instruments that are capable of determining the content of fat, protein, and lactose. An experimentally determined factor is added to the sum of the content of these major fractions of milk to provide the amount of total solids.

## TESTS FOR NONFAT MILK SOLIDS

When the sample is composed only of the constituents of milk, the percentage of nonfat milk solids is the product of subtraction of the percent fat from the percent total solids. Direct determination of nonfat solids content of products containing constituents other than milk requires detailed analyses and is not practical under industrial conditions. Knowledge of the amount of each ingredient used plus the composition of the ingredients containing milk solids permits accurate calculation of the nonfat solids content of the product. For example, when 20% flavoring is added to plain nonfat yogurt that contains 14% total nonfat milk solids, the nonfat solids content of the finished product is  $[(100-20)/100] 14 = 11.2\%$ .

## TESTS FOR PROTEIN

Although the content of protein is not determined routinely for most dairy products, protein in raw milk is measured in markets in which producers receive payment on a component basis. Furthermore, the average protein content must be known for the purpose of creating nutrition facts labels. Therefore, processors may need to know the protein content of ingredients or products.

### Kjeldahl Test

This is the reference method for protein. The major steps in the procedure follow. A known quantity of sample is digested by boiling in concentrated sulfuric acid plus a catalyst. The nitrogen that is freed from the protein and the nonprotein nitrogen of the sample are converted to ammonia, and then distilled into an acid that is partially neutralized by the ammonia. The excess acid in the receiving flask is then determined by titration, and the concentration of protein is calculated by multiplying the percent nitrogen in the distillate by the accepted factor of 6.38 that applies to milk proteins. Although this method provides accurate results, it is time-consuming and fails to provide a precise value. However, it is the method on which the instrumental tests are calibrated.

### Dye-Binding Test

Certain dyes in acidic conditions are bound to amino groups of lysine, arginine and histidine, amino acids of milk proteins, in a constant manner such that when

an excess of dye is added to a specified quantity of acidified sample, the dye-protein complex that forms can be removed and the amount of unbound dye can be quantified colorimetrically. This value is then compared to values in a calibration curve to ascertain the protein content. Acid orange 12 is the dye that has been selected for the official dye-binding test published in *Standard Methods for the Examination of Dairy Products* (Hooi et al., 2004). Since the dye-binding constant between normal milk protein and acid orange 12 is known, the amount of dye bound in a test can be used to calculate the amount of milk protein in a tested sample. Treatments that change the nature of the protein affect the dye-binding constant and, therefore, produce error in the test. Since concentrations of the various protein fractions of milk vary among animals, the test is more variable among cows than among lots of mixed herd milk.

### Infrared Analyzer Test

As presented in the preceding discussion of instrumental methods of determining fat content, the application of infrared light to compositional analysis includes quantification of protein. Because of their unique absorption of infrared energy, the number of peptide bonds of proteins can be quantified and the data used in comparison to a standard curve. This curve is constructed using samples that have been tested by the Kjeldahl reference method. These “calibration samples” are tested on the infrared analyzer, and the standard curve is developed by the software of the instrument.

## TESTS FOR LACTOSE

The concentration of lactose in fermented milk products decreases as fermentation progresses, lactic acid being the end product of a series of enzymatic reactions produced by culture bacteria under anaerobic conditions. The concentration of lactose in a product can be important to persons who are lactose malabsorbers and need to limit their intake of this natural sugar of milk. Whereas milk normally contains 4.6–5.0% lactose, development of 1% titratable acidity in that milk reduces the lactose content to about 4%. However, the addition of nonfat milk solids to milk or nonfat milk, as is often done in making cultured buttermilk and yogurt, raises the lactose content by about one-half of the amount of nonfat milk solids added. For these reasons it is necessary to quantify

the amount of lactose in products to provide information for writing the nutrition facts label.

### Polarimetric Method

This is the reference method for lactose measurement in liquid milks. The procedure calls for precipitating the protein from milk with mercuric iodide and phosphotungstic acid and removing the coagulum, including the fat, by filtration. The rotation of plane-polarized light in a polarimeter is then read and converted to concentration of lactose.

### HPLC Method

This method provides for weighing  $10 \pm 0.003$  g of sample into a 100 ml volumetric flask, and then adding 1 ml of 0.9N sulfuric acid to precipitate the protein. The sample is diluted to volume before being vigorously shaken. After the curds have settled, filtrate is collected for injection through a membrane filter (0.45- $\mu$ m pore size) and into the high-pressure liquid chromatograph. Samples are carried through the chromatographic column with a mixture of acetonitrile and water. Standards, made with  $\alpha$ -lactose and  $\beta$ -lactose, are used as quantitative references. Areas under the peaks of the samples are compared with areas under the peaks of the standards to determine concentrations of lactose in the samples.

In a similar manner concentrations of glucose and galactose, the products of lactose hydrolysis, can be quantified in fermented milk products.

### TITRATABLE ACIDITY

The most important characterizing component common to fermented dairy foods is lactic acid. The most common method of estimating the content of lactic acid in dairy products is the test for titratable acidity. Although lactic acid is not the only acidic substance in these fermented products, it is the dominant one so that the result of this test is expressed in percentage lactic acid. The titratable acidity of fresh milk in which no fermentation has occurred ranges from 0.12% to 0.16% and varies directly with the amount of phosphates, citrates, protein, and carbon dioxide in the sample. This "titer" is called the apparent acidity, and the additional titer that results from fermentation of the sugars of milk is called the "developed acidity." Together they constitute the total or titratable acidity. Addition of nonfat milk solids to products such

as yogurt increases the apparent acidity, and, consequently, the titratable acidity. Milk tastes sour to most people when the developed acidity is between 0.05% and 0.10%. When the titratable acidity of yogurt containing 14% nonfat milk solids is 1%, the apparent acidity would be expected to be about 0.20% and the developed acidity about 0.80%.

The test involves measurement of 9 or 18 g of sample into a beaker, addition of two volumes of water plus 0.5 ml of the pH indicator phenolphthalein, and titration to the first permanent shade of pink produced by the indicator. This color appears at a pH of approximately 8.3, a pH at which the buffering capacity of milk is quite low. The titrant, 0.1000N sodium hydroxide, is added from a calibrated buret. When the sample weight is 9 g and normality of the alkali is 0.1000, the titer is easily read as the ml of NaOH used in the titration divided by 10. This is true because 1 ml of 0.1N NaOH neutralizes 0.009 g of lactic acid that has a molecular weight of 90.

Error in the test occurs with variations in the apparent acidity, speed of titration, amount of indicator, and temperature of the sample. When the rate of titration is slow, the calcium phosphate of milk precipitates freeing hydrogen ions thus neutralizing some alkali. Therefore, consistent speed of titration is important. Addition of water to the sample lowers the rate of precipitation of these phosphates and limits the effect of them on the titer.

When the color of the sample can interfere with the color of phenolphthalein, it is necessary to detect the end point of the titration at pH 8.3 with a pH meter.

### MEASUREMENT OF pH

The quick and dependable method of measuring the acid produced during fermentation is with a pH meter. The instrument is standardized with solutions of buffers that have pH values above and below the expected pH of the samples to be tested. For fermented dairy foods this normally means that buffers of pH 4 and 7 are used to calibrate the instrument. When measuring or standardizing, the electrode must be immersed sufficiently to cover both the pH-sensitive bulb and the wick of the reference electrode. Often a "combination electrode" is used so that a single bulb is visible. To assure that potassium chloride moves through the wick, the vent hole on the side of the electrode must be open. The electrode must be kept clean. Coatings of fat on the surface can be removed by swabbing the bulb with hexane, isopropanol, or

dilute detergent. The most accurate results are obtained when the buffers and samples are at the same ambient temperature.

## CHEMICAL TESTS

### TESTS FOR FLAVORFUL SUBSTANCES

Certain components of fermented milk products characterize typical flavors. The most important of these flavors are diacetyl of cultured buttermilk, sour cream, and cottage cheese; acetaldehyde of yogurt; and ethanol of the yeast-fermented products that include kefir and koumiss. Because of the high volatility of these flavorful substances, their concentrations can be determined by gas chromatography (GC). Richelieu et al. (1997) developed a method that essentially prevents the oxidative decarboxylation of  $\alpha$ -acetolactic acid to diacetyl and its subsequent reduction to acetoin during analysis. This is a potential problem in the quantification of diacetyl because of the chemical instability of  $\alpha$ -acetolactic acid. The method involves adjustment of pH to 7 followed by headspace analysis by GC. The procedure (Richelieu et al., 1997) permits the quantification of other volatiles in samples including acetone, ethylacetate, 2-butanone, ethanol, and acetoin.

### TESTS FOR FREE FATTY ACIDS

Chemical substances that are detrimental to flavors of fermented milk products include free fatty acids that can be enzymatically released from the acylglycerides of milk lipids. Milk that contains an excess amount of free fatty acids is said to be rancid or lipolyzed. Concentrations of free fatty acids are most often determined by the acid degree value test. The procedure calls for combining 18 g of liquid milk product with surface-active BDI reagent (Bureau of Dairy Industry reagent) that consists of Triton X-100 and sodium tetraphosphate. This mixture, in a Babcock test bottle, is agitated and placed in a boiling water bath. After agitating the hot mixture and exposing it to heat for 15–20 minutes, the bottles are centrifuged and then filled with aqueous methanol so the separated fat rises into the slim neck of the bottle. After centrifuging again, the sample is tempered to 57°C in a water bath before 1 ml of fat is removed, dissolved in a 4:1 mixture of petroleum ether and n-propanol, and titrated to the phenolphthalein end point with 0.02N potassium hydroxide. Acid degree

value is defined as the milliliters of 1N base required to neutralize the acids in 100 g of fat. Raw milk normally tests between 0.25 and 0.40. Values exceeding 1.0 are suspect, and most people can detect the rancid flavor when values reach 1.5.

Abnormal fermentations can produce significant quantities of acetic and propionic acids. Quantification of these acids can be done by gas chromatography.

## PHYSICAL PROPERTIES TESTS

Producers of fermented milk products generally target their product's physical characteristics toward a selected market. These characteristics are primarily color, texture, body, and, in products containing fruits or other inclusions, the size, color, and distribution of particulates. Several of the physical attributes can be measured instrumentally while sensory tests are required to match the results with the likes and needs of consumers. In general the desirable attributes of fermented milk products include color typical of the flavor, body that has significant viscosity or is a soft gel, texture that is smooth, and an abundance of particulates that are typical in color and are distributed uniformly throughout the product. The weight per unit volume is of importance in formulation and preparation of the mix as well as in some aspects of packaging. Determination of the effects on viscosity of using "ropy cultures" may be of particular interest for yogurt producers who seek to enhance the body of yogurt with capsule-producing lactic cultures. Furthermore, tests of the effects of variations in solids content and of added stabilizers and emulsifiers include measurements of the physical properties.

### DENSITY AND SPECIFIC GRAVITY

Weight per unit volume is rather easily determined, but density varies inversely with temperature, especially with water and fat. Therefore, change in density with change in temperature may demand consideration especially when the ingredients are not at the same temperature as is the final product. The density of the final product can be predicted when densities and quantities of the ingredients are known. For example, assume that sour cream contains 18% fat (F), 8% nonfat milk solids (NMS), and 74% water (W) for which the densities (at 15°C) are 0.93, 1.58, and 1, respectively. The following formula is used in the

calculation:

$$\begin{aligned} \text{Density} &= \frac{100}{(\%F/0.93) + (\%NMS/1.58) + (\%W/1)} \\ &= \frac{100}{(18/0.93) + (8/1.58) + (74/1)} \\ &= 1.016\text{g/ml} \end{aligned}$$

Specific gravity of a substance is the density of the substance divided by the density of water at the same temperature. Although the density of milk decreases considerably with increases in temperature, for example from about 1.032 at 10°C to about 1.027 at 40°C, specific gravity of milk changes little over the same temperature range. This is true because water is the major component of milk.

## RHEOLOGICAL TESTS

The structure of yogurts is basically a protein network that forms during successful lactic fermentation when the pH is lowered to the isoelectric point of casein, about pH 4.7. The strength of this network is affected by several factors. Most processes for yogurt production involve high heat treatment of the milk that results in denaturation of the  $\beta$ -lactoglobulin and the  $\alpha$ -lactalbumin causing them to form complexes with the casein micelles. These complexes increase the viscosity of the system. As fat globules are broken down during homogenization, proteins are adsorbed to the newly formed surfaces and the surface area increases markedly. For example, a globule 5  $\mu\text{m}$  in diameter will produce 125 globules 1  $\mu\text{m}$  in diameter ( $d^3$ ) and these will have five times the surface area of the original globule. Associations among the restructured fat globules, resulting from depositions of denatured whey proteins and caseins on their surfaces, add strength to the structure. Formulation is an important determinant of consistency of fermented milk products. As solids are added, with the consequent reduction in water content, viscosity and firmness increase. This is especially true when proteins are added, because they bind water and their increased concentration enhances the protein structure. Prentice (1992) reported that increasing the dry matter of yogurt from 12% to 15% resulted in an increase in the firmness of a set yogurt by a factor of nearly 2 and of stirred yogurt by slightly more.

Although it is possible to measure an apparent viscosity of broken down yogurt gel, a more useful measure of the firmness of the set-type yogurt is its resistance to rupture, i.e., the yield point of the

structure as determined by a compression-type test. As the gel is compressed, an instrument, such as an Instron texture-measuring device, records the stress (force divided by area of application) in kPa. The point at which there is a break in the stress/strain curve is the yield point, and this point coincides with the rearrangement of the internal structure. At a somewhat higher stress, called the rupture stress, the structure collapses completely and the product has properties of a viscous fluid, i.e., it will flow. Stirred yogurts may be induced to flow so that the apparent viscosity can be measured as with a thin paste. This viscosity is shear-sensitive and the yogurt may be described as partially thixotropic. (With thixotropic fluids, as shear rate increases apparent viscosity decreases.) Apparent viscosity tends to decrease with time during application of continuous shearing in the same way as with cream.

The low stresses that must be applied in measuring the rheological properties of yogurt require the use of delicate instruments. The structure of the yogurt must be undisturbed as measurement commences. Therefore, preparing of set-type yogurt in the test apparatus is preferred. With stirred yogurts, recovery of the structure may take place within a few minutes after it is disturbed. In comparisons among treatments it is necessary to avoid differences in time and temperature among samples within the experiment. The presence of particulates within yogurt leads to variance in measurements of rheological parameters.

The fluid nature of cultured buttermilk and other such fermented milks permits their viscosities to be measured with instruments such as the cone and plate viscometer or the double cylinder Couette-type viscometer. However, the capillary-type viscometer does not work well for such viscous materials. It is important to observe that with most fermented milk products the measured viscosity decreases progressively as shear rate is increased. Since the viscosity that is measured over the span of stresses is not a constant value, as would be true of Newtonian fluids, this response is said to be non-Newtonian, and the value derived at a single designated stress is referred to as the apparent viscosity.

## WATER-HOLDING CAPACITY

One of the defects in appearance of fermented dairy foods is free whey. Although free whey is not in itself detrimental to the food, presence of it may suggest there were problems in production or distribution of the product. Factors that favor the release of

whey from the product include insufficient proteins or stabilizing ingredients, improper processing, excess acidity, high storage temperature, and/or vibrations of the containers sufficient to destroy a gel network. Although visual inspection of the finished product is the usual method of determining the presence and extent of the defect, it is possible to quantify the water-holding capacity of these products by centrifuging them at the normal storage temperature in a transparent graduated centrifuge tube. Set-type yogurts should be set in the tube. Stirred-type yogurts and cultured cream products should be permitted to rest and be refrigerated after filling the tubes to allow development of the normal structure. This type of test is useful when comparisons are being made among formulas, especially in tests of stabilizers, protein types or concentrations, and among heat treatments. Laboratories should develop their own standards of acceptability based on their unique formulas and operations. The objective is to minimize the occurrence and magnitude of the defect under acceptable conditions of operation.

## MICROBIOLOGICAL PROPERTIES

Fermented products of milk were first naturally produced and became accepted by humans who came to realize that natural souring not only prolonged the useful life of milk but also decreased the incidence of transmission of disease through it. The production of lactic acid in milk decreases the pH to a point below which many spoilage bacteria and some pathogens grow. Furthermore, fermentation reduces the amount of lactose in the product making it more suitable for consumption to lactose malabsorbing persons than the unfermented form of the product. Still there is some risk that pathogenic microorganisms may survive in fermented dairy foods. Therefore, tests have been developed to detect and/or enumerate undesirable bacteria in fermented milk products.

### TESTS FOR COLIFORM BACTERIA

This method selects for aerobic or facultatively anaerobic, Gram-negative, nonspore-forming, rod-shaped bacteria that are able to ferment lactose with the production of acid and gas within 48 hours when incubated at 32°C or 35°C. These bacteria are destroyed by pasteurization; therefore, their presence in finished dairy products is an evidence of

postpasteurization contamination. The test has some limitations in application to fermented dairy products because viability of coliforms is decreased in the acid environment of these products. It is recommended that tests be completed on freshly processed samples. Furthermore, the presence of fermentable sweeteners in flavored yogurts or other products may lead to false positive results.

Several methods are described in *Standard Methods for the Examination of Dairy Products* (Davidson et al., 2004). The most applicable to fermented products are the plate method with violet red bile (VRB) agar or the dry rehydratable film (Petrifilm) method. The plate method can be modified to improve the chances of recovering cells that may have been injured. The modification calls for plating the sample in a layer of tryptic soy agar, allowing it to solidify, then overlaying that layer with an equal amount of double-strength VRB agar. Pectin may be substituted for agar as the gelling agent in the plate test when the probability exists that injured cells will be killed by the heat of the VRB agar. Incubation is at 32°C for 24 ± hours. Typical colonies are dark red and at least 0.5 mm in diameter on uncrowded plates. Confirmation of the identities of representative colonies should be done when products contain sugars other than lactose.

The Petrifilm method requires that 1 ml of sample be deposited onto a 20 cm<sup>2</sup> area of an absorbent pad that contains nutrients, inhibitor, lactose, gelling agent, and an indicator dye. A transparent film is lowered onto the surface of the prepared plate. After incubation under the conditions cited above, counts are made of red colonies that are associated with a gas bubble.

### TESTS FOR ENTEROBACTERIACEAE

This group of Gram-negative bacteria containing the coliform group plus similar microorganisms can ferment glucose when plated in MacConkey glucose agar and incubated at 35°C for 24 ± 2 hours. The test is otherwise completed as is the plate-type coliform test, and it is a more sensitive indicator of postpasteurization contamination than is the coliform test.

### YEAST AND MOLD COUNTS

Yeast and molds grow well in acidic environments. However, their rates of growth at cold temperatures are slow. They can be selected from among bacteria in samples by using media acidified to pH

3.5 or media containing broad-spectrum antibiotics, i.e., equal portions of chlortetracycline hydrochloride and chloramphenicol (Frank and Yousef, 2004). The latter favors recovery of acid-sensitive fungal cells. Greater recovery of these aerobic fungi is expected when samples are surface-plated rather than pour-plated. Because these organisms typically grow slowly at the incubation temperature of 25°C, incubation time is 5 days. To limit the spreading of certain fungi on the plate surfaces, it is recommended that rose bengal and dicloran be added to the medium.

### TESTS FOR CULTURE BACTERIA

Developments in microbiology have made it possible to select, reproduce, and store bacteria that consistently produce the desired flavor, aroma, texture, and appearance in several types of fermented dairy foods. It is sometimes necessary to selectively quantify their numbers in these foods.

Counts of lactic acid bacteria are done using Elliker's lactic agar in plates that are either overlaid with a layer of the medium or are incubated in an oxygen-reduced environment. Incubation is for 48 hours at 32°C for mesophilic or 37°C for thermophilic bacteria. Because the method has a low degree of selectivity, confirmation of the identities of representative colonies should reveal Gram-positive, catalase-negative rods, or cocci as expected in the sample. Acid production by well-separated colonies can be detected when bromocresol purple indicator is added to the medium.

Counts of yogurt bacteria are facilitated by the use of yogurt lactic agar that differentiates rods from cocci (Frank and Yousef, 2004). The medium is composed of Elliker's lactic agar supplemented with non-fat milk solids. Yogurt is diluted 1:100 in 0.1% peptone water and blended at high speed for 2 minutes to break up the chains and clumps of cells. Then 0.1 ml portions of serial dilutions are surface-plated on dried surfaces of the plates. Incubation in an atmosphere low in oxygen and high in CO<sub>2</sub> is at 37°C for 48 hours. Colonies of *Streptococcus thermophilus* are small, white, and without a cloudy zone; whereas, those of *Lactobacillus bulgaricus* are large, white, and surrounded by a cloudy zone.

Diacetyl is produced primarily from citrate by *Leuconostoc cremoris* and *Lactococcus lactis* var. *diacetylactis*. These citrate-fermenting bacteria can be enumerated according to the International Dairy Federation Standard 180:1997 (Anonymous, 1997).

### ANTIMICROBIAL SUBSTANCES

Although the two major reasons for excluding antibiotics from human foods are to protect the consumer from untoward reactions to the antibiotic and to avoid development of resistance by microorganisms to antibiotics, the manufacturer of fermented dairy foods has the additional and vital concern that there be no inhibition of growth of the culture bacteria by antimicrobial substances. Therefore, antimicrobial tests should be done routinely on the milk to be fermented. In the United States it is required that all bulk truckloads of milk be screened for antibiotics. This affords a minimal level of protection to the manufacturer of fermented products. However, screening tests do not detect all antibiotics nor are they sufficiently sensitive to assure that there will be no inhibition of any specific culture. *Standard Methods for the Examination of Dairy Products* (Bulthaus, 2004) provides 18 methods for antimicrobial testing. The major indicator bacterium used in the tests is *Bacillus stearothermophilus* var. *calidolactis*. In the reference method, spores suspended in an agar medium germinate and grow rapidly making the medium cloudy if the antibiotic is not present at an inhibitory concentration. The milk to be tested is placed on a paper disc resting on the medium, and the diameter of the zone of inhibition around the paper disc indicates the concentration of the inhibitor present. The test bacterium is sensitive to varying concentrations of several antibiotics. The same bacterium is used in the Delvotest. In this method a pH indicator dye, nutrients, and milk are added to a small glass vial containing the bacterial spores and agar. After incubation for 2.5 hours, the analyst checks the color of the medium to see whether the bacterium has grown and produced acid sufficient to change the color of the medium from purple to yellow. The Brilliant Black Reduction Test (BR Test AS) is similar to the Delvotest, the main difference being the indicator. In the BR Test AS, growth of the *B. stearothermophilus* var. *calidolactis* strain C953 cells is indicated when the black dye is reduced to the colorless state.

Immunoassays have been developed for specific antibiotics. In general these assays can be described as follows. A sample of milk is introduced to a solid phase, such as polystyrene, to which are adsorbed antibodies for specific antibiotics. Any such antibiotics are adsorbed from the milk onto the specific antibodies. This solid phase is then washed to remove the unadsorbed material, and a tracer with an attached enzyme is then added. The tracer is adsorbed



to sites on the antibody that contain no antibiotic. A chromagenic substrate for the specific enzyme is then added. The amount of color that develops during an incubation period indicates the amount of the specific inhibitor present. The more antibiotic present the less color develops, because the adsorbed antibiotic limits the adsorption of the tracer and, thus, the concentration of the enzyme.

## SENSORY TESTS

Manufacturers must have the likes and dislikes of consumers in mind as they formulate and produce fermented milk products. Regardless of how positively the consumer thinks about the nutritional and health benefits of consumption of these foods, repeated purchases depend heavily on flavor, body, texture, and appearance. Therefore, it is vital that the producers have in place an effective process of evaluating these characteristics using members of the target population. Obtaining representative respondents is essential. Frequency of use or purchase of the product is a good criterion for making selections.

## PREFERENCE TESTING

Consumers are often asked to indicate a preference for one product versus another or to rank a group of products in order of preference. Results of such tests are useful in product development. Of course, the analyst wants results of preference testing to be valid. When the question is “Which product do you like better?” consumers respond to the characteristics of the product as a whole. To ask them why they like it better is likely to lead to confusion on their part and to difficulty in the analysis on the part of the analyst. Numbers of respondents must be large, and samples must be presented in random order and coded. The results may be tested with the two-tailed  $z$  value. Tables showing minimum numbers of agreeing judgments for numbers of participants up to 100 are published in most statistics or sensory analysis books. Analysts must realize that showing no significant preference of one sample over another does not mean the samples do not differ. For example, there may be no difference in preference between peppermint and spearmint, but the two flavors are different.

In preference ranking there must be a forced-choice for each participant so that no ties in rank are permitted. Although rankings provide preferences

among a group of samples, they do not reveal the magnitude of differences within the ranking. However, if one sample is consistently ranked at the top or bottom of the group, while others are inconsistently ranked, that sample can be considered to differ markedly from the others. Analysis of the results of ranking tests can be analyzed by reference to Basker's tables (Basker, 1988).

It is also possible to do a preference test in which the panelists scale their degree of preference. For example, they may indicate whether the difference is large or moderate in the like or dislike direction or whether there is no preference.

## ACCEPTANCE TESTING

The common method of acceptance testing involves the use of a hedonic scale that may have 9 or 11 points. A 9-point scale contains the following points: like extremely, like very much, like moderately, like slightly, neither like nor dislike, dislike slightly, dislike moderately, dislike very much, and dislike extremely. Consumer preferences are considered to exist on a continuum. Samples are served in randomized succession and panelists respond by marking on the hedonic scale. Truncating the scale to 5 or 7 points is not advised since there is a tendency for panelists to avoid extremes in ranking. Such a practice will tend to force the results toward the center—neither like nor dislike.

“Just right” scaling is useful in testing whether a selected characteristic is at the desirable level of intensity. For example, a “just right” scale of sourness would be anchored on the left with “highly lacking sourness” and at the other end with “much too sour.” It would have “just right” in the center. The distribution of a desirable set of responses should be peaked in the center and symmetrical. The center of the plotted distribution may not, of course, occur over the “just right” segment of the scale. Furthermore, the mean may not reflect the true result if, for example, the panel contains two groups of consumers, one that prefers a high and another low level of the characteristic being tested. The latter may yield a bimodal distribution.

## DESCRIPTIVE ANALYSIS

Sometimes a detailed description of the sensory attributes of a product is needed to enable comparison of one product to another or to characterize a single

product. Such a test is called descriptive analysis. The method requires that a specific defined language be used in the description of product attributes—a language that is fully understood by the sensory panelists. Therefore, sensory judges must be trained to use exact product descriptors, ones that will reflect true differences among the tested products. Furthermore, terms should not be redundant or correlated to other descriptors. For example, it is not advisable to use both the terms smooth and coarse in describing texture. Panelists should be able to readily agree on the meaning of a specific term. Reference standards for each descriptor are highly recommended.

Descriptive analysis is often used in developing a flavor profile of a product. Four to six highly trained judges are required. Panelists precisely define the flavors of the product category over a period of several days before they are employed in describing the flavorful components of the target product. Both the intensity of the flavor and the order of occurrence among all of the flavor notes are recorded. The panel leader, through discussion and consensus, derives a consensus profile from the responses of the panelists.

The method described above has been expanded to provide quantitative results, i.e., quantitative descriptive analysis (QDA). Data are generated on an unstructured line scale by a panel of 10 to 12 judges who individually generate a set of terms to describe the product. The panel then develops a standard vocabulary by consensus. They choose reference samples and define the descriptors. Evaluations of coded, randomly served samples are performed individually by the panelists. Panelists mark on 6-inch graphic lines anchored with single chosen descriptors (example: sourness—from weak on the left end to strong on the right end of the scale). Numerical values are then found for each descriptor by measurement from the left end of the line. The resulting data can be analyzed statistically.

Another method of describing the sensory attributes of a food product is called “free-choice profiling.” Each individual panelist describes the sensory attributes and develops a personal rating scale. This set of attributes and rating scale are then used by the panelist to describe the product in question. Results are then subjected to an elaborate statistical procedure called the generalized Procrustes analysis. This method allows for minimal training of panelists, but interpretation of the meaning of the chosen descriptors is difficult. Furthermore, the number of descriptors may vary widely among panelists.

## SENSORY TESTS FOR QUALITY CONTROL

In the dairy industry it is a common practice to use highly trained analysts to evaluate finished products using as a reference the scoring guide generated by the Committee on the Sensory Evaluation of Dairy Products of the American Dairy Science Association. In this practice the judge must have a mental standard of the high quality desired in the product. Defects that are observed in a product are then given a numerical value that determines the acceptability of a product. Often multiple trained judges meet around a set of representative samples and, using the scoring guide, come to an agreement as to the acceptability of these products. By describing the defects of the product they can develop recommendations for improving products produced in the future.

It is vital that sensory analysts be screened for reliability and consistency in judgment. A procedure should be in place to ensure that multiple judges agree both on types and intensities of defects, as well as their relative importance to the acceptability of the fermented dairy food. Use of reference and control samples is highly recommended. Reference samples are those that have been described by experts as representing the ideal product profile of the firm. Control samples are unidentified samples taken from one or more of those being evaluated and placed within the series of samples being evaluated. Consistency can be determined by randomly presenting to the analysts a set of coded samples in which there are multiple samples of the same product. Abilities to reproduce the equivalent quality ratings on replicated products should be required.

Since analysts vary in the flavor thresholds for significant off-flavors, especially bitter and rancid (lipolyzed), it is important that these deficiencies be recognized and controlled.

Implementation of a sensory QC program has four requirements. First, representative products must be used to establish quality specifications. Second, qualified sensory analysts must be employed. Third, protocols that will minimize error must be developed for testing. These include instructions for collecting, storing, and handling samples; methods of serving, blind coding, and provision of reference samples. Fourth, procedures must be developed for reporting and using the data generated, including criteria for action.

Readers are directed to the textbook by Lawless and Heymann (1999) for further descriptions of these methods of sensory analysis.

**REFERENCES**

- Anonymous. 1987. Determination of Total Solids in Milk, Cream and Evaporated Milk. Standard 21B:1987. Brussels: IDF/ISO/AOAC.
- Anonymous. 1991. Determination of Total Solids Content in Yogurt. Standard 151:1991. Brussels: IDF/ISO/AOAC.
- Anonymous. 1997. Enumeration of Citrate Fermenting Lactic Acid Bacteria in Mesophilic Starter Cultures. Standard 180:1997. Brussels: IDF/ISO/AOAC.
- Basker KD. 1988. Critical values of differences among rank sums for multiple comparisons. *Food Technol.* 42(2):79–84, 42(7):88–89.
- Bulthaus M. 2004. Detection of antibiotic/drug residues in milk and dairy products. In: H Wehr, JF Frank (Eds), *Standard Methods for the Examination of Dairy Products*, 17th ed. American Public Health Association, Washington, pp. 293–323.
- Davidson PM, Roth LA, Gambrel-Lenarz SA. 2004. Coliform and other indicator bacteria. In: H Wehr, JF Frank (Eds), *Standard Methods for the Examination of Dairy Products*, 17th ed. American Public Health Association, Washington, pp. 187–226.
- Frank JF, Yousef AE. 2004. Tests for groups of microorganisms. In: H Wehr, JF Frank (Eds), *Standard Methods for the Examination of Dairy Products*, 17th ed. American Public Health Association, Washington, pp. 227–247.
- Hooi R, Barbano DM, Bradley Jr RL, Budde D, Bulthaus M, Chettiar M, Lynch J, Reddy R. 2004. Chemical and physical methods. In: H Wehr, JF Frank (Eds), *Standard Methods for the Examination of Dairy Products*, 17th ed. American Public Health Association, Washington, pp. 363–536.
- Horowitz W. 2003. *Official Methods of Analysis*, 17th ed., 2nd rev. AOAC International, Gaithersburg.
- Lawless HT, Heymann H. 1999. *Sensory Evaluation of Food: Principles and Practices*. Kluwer Academic Publishers, Hingham.
- Prentice JH. 1992. *Dairy Rheology: A Concise Guide*. VCH Publishers, New York.
- Richelieu M, Houlberg U, Nielsen JC. 1997. Determination of  $\alpha$ -acetolactic acid and volatile compounds by headspace gas chromatography. *J. Dairy Sci.* 80:1918–1925.
- Wehr H, Frank JF. 2004. *Standard Methods for the Examination of Dairy Products*. 17th ed. American Public Health Association, Washington.

# 8

# Fermented Dairy Packaging Materials

*Aaron L. Brody*

- Introduction
- Fundamentals of Packaging
  - Definition
  - Packaging Technology
  - Graphics
  - Structural Design
- Packaging Materials
  - Paper and Paperboard
  - Metal
  - Glass
  - Plastic
  - Packaging Levels
- Interactions of Product and Packaging
- The Package in Product Distribution
- Graphic Design and Assessment
- Economics of Packaging
- Regulation
- Packaging and the Environment
  - Source Reduction
  - Recycling
  - Incineration
  - Biodegradability
- Packaging for Yogurt and Fermented Dairy Products
  - Pasteurized Fluid Milk
  - Shelf Stable Fluid Dairy Products
  - Solid Dairy Product Packaging
- Future trends
- Bibliography

## INTRODUCTION

Perhaps as much as any component of the dairy product processing and distribution system, packaging contributes to the safe delivery of the contained products to end consumers. Without packaging the contained dairy products would not be protected against

the environment whose elements are always working to revert contents back to their original molecular components.

This chapter addresses the totality of containment and protection of yogurt and fermented dairy products from process through consumer use but, of course, represents only a brief overview. Readers who require greater depth are referred to various textbooks and articles on the subject cited in the bibliography. Much of the secondary literature on this topic is not in the peer-review journals, but will be found in trade journals and analogous publications. The information to be derived from such a probe is generally contemporary and relevant, and should be valuable to readers.

This chapter begins with fundamentals, including the requirements, the major package materials employed, and their principal applications in dairy foods. Dairy packaging operations, including those for fermented dairy products such as yogurt and cottage cheese are also described. Since suppliers play a major role in providing packaging integers, they are classified and in some instances, identified, with no implication of endorsement as a result of inclusion or criticism as a result of omission. The more traditional (from a dairy technologist's standpoint) "packaging" or product/packaging interactions are reviewed. The more traditional (from a packaging technologist's standpoint) distribution packaging is also discussed briefly. Graphic design, regulations affecting packaging, and the role of packaging solid waste in the environment are discussed. This chapter concludes with an enumeration of fermented dairy product packaging, both current and projected for the future.

## FUNDAMENTALS OF PACKAGING

Packaging is the most effective means to protect contained fresh, stable, and fermented dairy products from their point of manufacture through to their consumption. It is also arguably the most effective means of communication between the dairy products marketer and the end user of the fermented dairy products, since the form and graphics of packages are visible at the instant of purchase decision and subsequently in the home and/or point of actual consumption.

### DEFINITION

Packaging is the totality of all elements required to contain the product within an envelope that functions as a barrier between the product and the environment that is invariably hostile to the product unless the protection afforded by packaging is present. Environmental insults include temperature, moisture, oxygen, microorganisms, animals, insects, vibration, impact shock, and human intrusion. By totality is meant the package material and its visual and tactile appearance, the machinery for linking the product to the package materials, the external distribution packaging and its associated equipment, the distribution itself, opening and removing the contents when and where desired, disposal of the spent package, etc.

The package is the material in its structural form such as a bottle, jar, can, pouch, bag, carton, case, etc.

The most important definitional element is that packaging is a means of protection for the product while it is in distribution.

### Primary Packaging

Primary packaging is that which is in intimate and direct contact with the contents. As such it represents the principal barrier between the product and the environment. Most if not all of the protection against oxygen, microorganisms, light, moisture gain, or loss, etc., is built into the primary packaging. Among the more common primary packages are metal cans and bottles; glass jars and bottles; flexible pouches, paperboard folding cartons; and plastic cups, bowls, tubs, and trays.

### Secondary Packaging

Secondary packaging is external to the primary packaging and often an outer carton or a multipacker. It

enables the consumer to carry more than one primary package of a product at a time, i.e., the multipacker. It is also the external label, carton, tag, etc., that complements the primary package.

### Distribution Packaging

Distribution packaging is a means of unitizing many primary and/or secondary packages to facilitate the movement of a large multiple of packages as a single entity. In this manner the packages are protected and may be economically moved rather than having to move one package at a time. Typical distribution packages include corrugated fiberboard cases, shrink film bundles, and pallets.

## PACKAGING TECHNOLOGY

Packaging technology is the application of scientific and technical principles to employ packaging for functional purposes, including protection and communication.

### GRAPHICS

Graphics represent the external appearance of the package and usually includes copy, form, shape, color, typography, pictorials, etc., to communicate some essential or desired information to the consumer or intermediary.

### STRUCTURAL DESIGN

Structural design is the three-dimensional shape of the package, cylinder, rectangular solid, tapered cylinder, flat, etc. Structure is also the word used to connote the components and order of a multilayer package material such as a flexible lamination.

## PACKAGING MATERIALS

In an ideal world a single package material and structure would suffice to protect all yogurts and fermented dairy products. In this case, a steel can could function in this role, but the size, heavy weight, and adverse economics of a steel can in many contexts dictate that it may not necessarily be employed when a less expensive and lighter weight material is available. Because of the nature of package materials it is usually necessary to combine different materials to achieve a desired objective, but even the combination of materials is usually less expensive than employing all metal or glass plus a metal closure for many

applications. Even metal requires coating for protection to be useful in most food applications, and so even the “single-ply” package materials are really multiples.

### **PAPER AND PAPERBOARD**

Paper and paperboard represent by far the most widely used package material both in the United States and around the world. Because of its derivation from cellulose fibers, paper per se is not a barrier to moisture or oxygen and so it is generally combined with other materials such as plastic or even aluminum foil to render it effective in packaging applications. Most of this category is comprised of paperboard rather than paper, with the dividing boundary being 0.010 inch caliber or gauge, paper being below the line and paperboard being above 0.010 inch.

The two basic types of paperboard are virgin or that originating directly and primarily from trees and their wood, and recycled, or that whose raw material is used paper and paperboard. Generally virgin paperboard, i.e., from tree wood, is cleaner and more uniform, and has the greatest strength per caliper (unit gauge). Furthermore, it accepts the barrier material for coating more easily than does recycled paperboard. On the other hand recycled paperboard may, if desired, have a superior surface for printing. Recycled paperboard has been used as a secondary (non-food contact) package material for many decades, with the origins of the material being largely trimmings and scrap from paper, paperboard, and corrugated fiberboard converting plants.

Because paperboard is moisture sensitive, for dairy products packaging it is generally necessary to protect the paperboard, which then functions primarily as a structural material. Among the coatings used are low-density polyethylene applied by hot melt extrusion over the entire surface. Polyethylene is an excellent moisture and water barrier to protect the base paperboard.

Paperboard is used in dairy product packaging as the substrate for both gable top and aseptic brick/block-shaped cartons to contain fluids. In the latter application it is extrusion laminated with plastic and aluminum foil to foster a long time shelf life. Coated paperboard is also used to fabricate cups and trays to contain semisolid dairy products such as yogurt and cottage cheese.

Probably the major dairy products packaging application for paperboard, however, is in three-layer form in corrugated fiberboard cases used for distribu-

tion. The corrugated structure consists of three layers of two outer flat sheets called liners of paperboard, usually virgin, plus an inner fluted sheet or medium that can be either virgin or recycled. The corrugated structure offers vertical and horizontal compression and impact strength to protect the contents, usually primary packages.

Increasingly, the printing on corrugated fiberboard liners is being improved to permit the cases to be used as retail displays or even as consumer packages and multipacks.

### **METAL**

Metal is most often used for cylindrical cans, which are either thermally processed for microbiological stability, e.g., evaporated milk, or internally pressurized with carbon dioxide as for beer, and carbonated beverages. Aluminum is by far the most important metal used for can fabrication, being the primary metal for beer and carbonated beverage cans, and increasingly used for still beverage cans such as for juices and aseptically canned milk, but only sparsely for food cans except for shallow pet food and fish cans. In the past aluminum cans with easy open tops were used to contain milk-based puddings and yogurts that were filled aseptically. This application has been replaced by barrier plastic cups with peelable flexible lidding materials. Almost all aluminum cans are two-piece. More recently, impact/extrusion-formed aluminum bottles are being applied for dairy products. Bottles are narrow neck structures, usually closed with metal screw closures, but sometimes with polypropylene closures.

Steel represents the major metal used for food cans, usually being coated with chromium oxide and later coated with a thermoset plastic to protect the metal from corrosion.

Aluminum is also used in very thin or foil gauges—ca 0.00035 inch or below, as a flexible or semirigid packaging laminant to impart oxygen and water vapor barrier to the lamination. In this form, because it is fragile, the aluminum must be protected from damage by plastic or paper.

### **GLASS**

Glass is historically the oldest packaging material still in use. Glass is the best barrier known and by far the most inert to product contents. Furthermore, in appropriate structures, glass has the greatest vertical compressive strength. On the other hand, glass is very

heavy per unit of contents contained, is energy intensive to manufacture, and, as is well known, is prone to breakage with impact. Glass may be fabricated into bottles and jars, almost all of which require plastic or metal devices to close. Although glass was the most widely used material for packaging fluid milk and its fermented analogues during the first half of the twentieth century, its dairy products applications during the past two decades have dwindled to virtually zero. Occasionally, a few dairies offer yogurt in glass to convey a high quality image, but most dairies shun glass as a hazardous material in production and packaging operations.

## PLASTIC

Plastic is the newest package material having been developed during the last century and having come into prominence only since the 1950s. In actuality, the term “plastic” describes a family of materials related by their common derivation from petrochemical sources. Each is quite different in properties relative to packaging requirements, and so no single plastic material is capable of being universally employed. All plastic package materials are characterized by their lightweight, relative ease of fabrication, low cost, and ability to be tailored for specific end applications. Together, by weight, all plastics comprise about 20% of package materials, but because of their low densities, protect far larger volumes of contents than any other package materials, perhaps 60–70% of all foods and dairy products.

### Polyethylene

The most commonly used packaging plastic is polyethylene, which may be obtained in high, medium, and low densities with variations now available on each of these. Low-density polyethylene (LDPE) is tough, flexible, easily formed after heating, lightweight, and forgiving as a heat sealant. It is an excellent water and water vapor barrier, but a poor oxygen and flavor barrier. LDPE's most common uses are as flexible pouches and bags, and as the heat sealable extrusion coatings on paper, paperboard, and aluminum foil. Thus LDPE is the coating on gable top fluid cartons, the laminant on aseptic bricks and blocks, and the heat seal coating on many flexible lidding materials.

High-density polyethylene (HDPE) is a semirigid, somewhat stiff translucent easily thermoformable plastic. With fairly good heat resistance, HDPE has

excellent moisture and water resistance but is a very poor gas barrier. HDPE is used to form bottles for milk and many other liquids, as well as a wide variety of other products with modest barrier requirements. HDPE may also be formed into cups, tubs, or trays to contain yogurt and cottage cheese.

### Polyester

Polyethylene terephthalate polyester (PET) has been available as a specialty film packaging material for many years, but only since the late 1970s did it enter as a significant package material. A modest oxygen and water vapor barrier, in package form after orientation, PET is tough and transparent. PET's major packaging applications today are for carbonated beverage bottles, with other bottles and jars as for drinkable yogurt, salad dressing, peanut butter, etc., thermoformed cups and tubs, etc., in the semirigid category are secondary applications at present. PET may also be formed into films that are tough and dimensionally stable and, therefore, are quite good as laminants to protect aluminum foil or for lidding-type flexible closures. In partially crystallized form PET may be fabricated into trays for dual oven (microwave and conventional conduction–convection) reheating.

### Polypropylene

In oriented film form, polypropylene is an excellent, economic, tough, transparent, high-moisture barrier, low-gas barrier package material, which has captured almost the entire quality flexible packaging market. Among the packages being made with oriented polypropylene (OPP) are potato chip pouches, bakery goods overwraps, and candy bar wraps. Because of its relatively high temperature resistance (up to 250°F), polypropylene resin is combined with other higher barrier packaging materials to produce multi-layer plastic bottles and cans such as for ketchup or for “bucket-type” cans for microwave reheating. For economic reasons (i.e., when the commodity price is favorable), polypropylene may be injection molded into tubs and cups to contain fermented dairy products such as yogurt and cottage cheese.

### Polystyrene

Polystyrene is a plastic with a relatively poor oxygen and water vapor barrier but good structural properties. Being inexpensive and easy to form by sheet extrusion and thermoforming or injection molding

methods, polystyrene has been one plastic of choice for cup/tub containment of yogurt, cottage cheese, etc., since the demise of wax-coated paperboard during the late twentieth century.

### Oxygen-Barrier Materials

Most of the above plastics are not good oxygen barriers. To obtain the oxygen barrier, two plastic resins, polyvinylidene chloride (PVDC), and ethylene vinyl alcohol (EVOH) are employed commercially. PVDC is the older of the two and has excellent water vapor and fat resistance but is relatively difficult to fabricate, as well as being questioned on environmental grounds for its hydrogen chloride content. Much PVDC is used in emulsion-coating form on films to achieve oxygen barrier in films used for processed meats and cured cheese.

EVOH is a better oxygen-barrier material and is easier to fabricate but is very sensitive to moisture. The economics of both high-oxygen barrier materials dictate that they be combined with other less expensive structural plastic resins. Thus EVOH is usually coextruded (i.e., forced with another plastic through a common die) with polypropylene to produce films, sheets, or coatings. The EVOH is protected from environmental or product moisture in these applications. In addition to its involvement in “bucket-style” cans, EVOH is also an increasingly important material to protect food and beverage contents from flavor interaction with packaging materials. With many food and beverage contents now being held for prolonged periods up to a year at ambient temperature, the probability of adverse product plastic interactions, largely flavor changes, is relatively high. Consequently, an intermediate high-barrier material such as EVOH serves to minimize such interactions in packages such as those for chilled juices.

### PACKAGING LEVELS

No such entity as comprehensive packaging exists in a single supplier or user organization, even though comprehensiveness should be indispensable to effective and functional packaging. All packaging is divided into a large number of individual entities selected from a broad array of offerings to permit the dairy products packager to select according to the product, protection, distribution, marketing, need, or desire. These operations may be defined in tier or horizontal form. Examples of the levels include the

suppliers of raw materials, those who convert these raw materials into useful packages, suppliers of machinery, designers, publishers, schools, etc.

### Raw Material Suppliers

Raw material suppliers include organizations, which obtain basic materials from the planetary resources such as the ground, air, or oceans and transform them in very large quantities into bulk materials that may then be converted into packaging. Among such organizations that generally do not supply dairies are aluminum miners and refiners, steel mills, paper and paperboard mills, and petrochemical companies. Such companies deliver materials such as coils of metal sheet, rolls of paperboard, carloads of plastic resin, etc., to converters. The principal exception to this is the glass industry whose nature fosters the direct integration of raw material and converting into bottles and jars without intermediate companies.

Among the packaging material, suppliers of interest to dairy product packagers currently are in the area of paperboard: International Paper; Blue Ridge; Smurfit Stone; and Weyerhaeuser, which are examples of companies that manufacture virgin paperboard used downstream in gable top cartons and/or corrugated fiberboard cases. Basic aluminum suppliers include Alcan and Alcoa. Steel suppliers include USX and Weirton. Plastic resin suppliers include DuPont, Dow, and Exxon Mobil for polyethylene; Voridian for polyester; Dow for polystyrene; and BP Chemical for polypropylenes.

### Converters

Converters are organizations, which supply useful packaging to dairies and other food packagers. Such organizations acquire commodity-type raw materials from their own suppliers and process and combine them to produce flexible films, sheets, cups, cans, tubs, trays, bottles, jars, cartons, cases, etc. Among the operations provided by converters are printing, extruding, cutting, molding, lamination, adhesion, cup formation, nesting, slitting, and coating. Quantities involved are generally much smaller than those offered by their new material suppliers, and sufficient for their dairy and food users.

Converters tending to focus on the dairy industry include International Paper, Blue Ridge, and Tetra Pak for gable top paperboard cartons; and Sweetheart and Sealright for paperboard rounds. Corrugated fiberboard case manufacturers include International



Paper, Smurfit-Stone, and several hundred other smaller companies. Ice cream and frozen yogurt carton manufacturers are headed by Graphic Packaging, with Sealright (Huhtamaki) as the major supplier for bulk ice cream containers. Steel metal can makers include Rexam and Crown Cork and Seal. Aluminum can makers include Ball and Crown Cork and Seal. Glass bottle manufacturers include Owens Illinois, St. Gobain, and Consumers. Flexible packaging converters include Curwood, Printpack, Alcan, Wimpak, and Cryovac, as well as several hundred smaller firms. Plastic bottle blow molders and injection blow molders include Owens-Illinois, Consolidated, Amcor and Alcan, as well as many smaller companies and self-manufacturers. Cup and tub molders include Fabri-Kal, Berry, Sweetheart, and Solo (particularly for polyester cups). These are intended only to indicate a few of the wide array of suppliers which are available to fermented dairy product packagers to provide their package material needs. In almost every instance there are many suppliers. In no instance can a single supplier provide a complete range of all package materials that a fermented dairy packager might require.

### Packagers

Packagers are the yogurt and fermented dairy product processors which marry the package materials to the food and dairy products. Packagers employ machinery designed, engineered, and built by specialist firms.

### Distributors

Distributors include the means to deliver the packaged dairy and food products to the consumers. Distribution channels include warehouses, transportation, wholesalers, brokers, jobbers, retailers, etc. Retailers include grocery and food service outlets.

In addition to these tiers a range of suppliers provide goods and services to comprehend the requirements of comprehensive packaging. Graphic designers, for example, offer the services, which are converted by printing plate makers into the hardware required to deliver ready-to-display packages. The output of graphic designers is intended to comply with regulatory requirements, as well as to meet the desires of marketing managers for retail communication.

### Packaging Equipment

Not the least important of providers are the packaging equipment manufacturers, agents, and importers. Of some importance to dairy packagers are Evergreen and Nimco for gable top paperboard cartoning. Tetra Pak now supplies not only its traditional aseptic packaging equipment but also gable top cartoning machinery. Among the aseptic plastic cup equipment suppliers are Bosch, Hassia, Hamba, Autoprod, and Holmatic. Plastic bottle-filling equipment is supplied by U. S. Bottlers, Krones, etc. Cup fillers may be obtained from Autoprod, Holmatic, and Sealright. Suppliers for flexible packaging equipment for products such as cheese include Hayssen, Multivac, and Tiromat. Secondary packaging equipment suppliers include MeadWestvaco and Graphic Packaging. Suppliers of machinery for distribution packaging include ABC, Salwasser, Douglas, and Pearson.

### Packaging Development

The development of packaging is a sequence that involves a broad range of disciplines and professionals who interact in overlapping to finally deliver packages to the consumer. The most indispensable consideration in developing packaging is the product, and hence, consumer safety, with the interaction of packaging and contained food or dairy product being one element, and the interaction of processing and package another. Interactions are not permitted that might in distribution extract contaminants from the contained food or dairy contents.

No processing operation such as heating can compromise the safety as, for example, hot filling or retort processing, which could conceivably disrupt heat seals and permit recontamination by microorganisms.

The above are *axiomatic* in the selection of package materials and structures.

The next requirement in the development of packaging is the technical function. If the package can contain and protect the product in normal distribution, it has fulfilled its basic objective. Thus, an initial step in packaging development is the engineering to ensure technical functionality. Variables such as moisture protection, seal integrity, protection against the entry of oxygen or microorganisms, resistance to heat or cold or both in sequence, product/package flavor interaction, etc., are specified and measured versus the ability of the package to meet the other

necessary and desired criteria. Subsequently, the ability of the package to withstand the distribution environment using such measures as impact, vibration, and compression resistance are predicted and measured.

In some instances, the variables may be predicted by mathematical models knowing the end objective in terms, first, of desired shelf life under specific temperatures; and second, the effect of that variable on the shelf life. A typical example might be a cottage cheese product in refrigerated distribution that would have a target shelf life of 40 days. The model would begin with microbiological growth as probably independent of packaging. From a packaging perspective a variable such as no more than 1% moisture loss through the package structure in those 40 days at 40°F would be inputted to predict the gauge of the package material options required in the particular structure being considered. Of course the mathematical models in shelf-life prediction are only screening the guidelines today, and so actual laboratory testing will be required to verify the tests.

Similarly distribution resistance may be mathematically predicted with fairly good accuracy, but actual laboratory testing is needed in almost every instance. In many instances, the use of real distribution is employed although, of course, the test variables of a single truck ride are such that the results can be misleading. Nevertheless, many packaging developers use actual truck shipments as a testing protocol in lieu of vibration and drop testers.

Most of the time the sequence is to extrapolate from known packages of similar products such as, for example, if the product is a flavor variation of an existing commercial product, relatively little shelf-life testing is necessary. Some testing should be performed to ascertain the effects of the differences such as flavor interactions.

Although laboratory samples are satisfactory for initial evaluations, it is necessary to conduct tests on actual production samples, since these invariably differ significantly from the pristine prototypes. When actual production line sample packages are not immediately available, the closer the samples are to machine-made, the better for real-life prediction. While functionality testing and its associated reengineering of the package structure are underway, the marketing inputs are incorporated into the package. These include the graphic requirements, both legal and those desired for marketing and communication, structural features such as pour spouts, reclosure tabs,

tamper-evident/tamper-resistant devices, etc. Whenever a structural change is made, the resulting package should be reevaluated, but this step is not always performed in the haste of meeting the marketing, production, distribution, financial, etc. schedules.

Today graphic design is usually performed with computer assistance and so rapid action is quite feasible. In a large project, it is highly recommended that the package design including all its structural features undergo both consumer and retail display testing. Too much investment has been made in the package to avoid this key step, although many dairy product companies may overlook it. A host of consumer and marketing research firms conduct such tests ranging from focus groups to actual in-store displays or in-home testing. None is perfect and comprehensive, although each purveyor of a test procedure believes that it is the ideal measuring tool. The most important design test must be the simulation of in-store display, i.e., perception of the package by consumers in the normal shopping environment as in a mass display among other similar and competitive products. Yet another necessary test is how consumers actually use the package to deliver the product to themselves to ascertain any consumer perceived flaws or areas, in which the package design may be improved.

During the development of the package, it is necessary to select the equipment on which the package is to be made to ensure that the product, package material, and machine are compatible. Machine retrofitting and reengineering is not only feasible, it is to be encouraged prior to completion of development. Package and equipment development should be a totally integrated effort and should be continuous from the inception of any packaging development project. As much as possible, off-the-shelf equipment should be used since custom equipment development requires high investment. Standard equipment can be modified to accommodate special requirements of the product and package.

Not the final step in the initial development is secondary and tertiary or distribution packaging. Here both the package and the equipment must be developed and selected or modified for the unitization and containment of primary packages.

Throughout the process, it is desirable to develop the economics of the package including the cost of the package materials, equipment, labor, utilities, etc. Each should be developed in a total systems context to ensure that the economics are not dictated solely by the purchase price of the package materials—a

variable that can be highly misleading in the context of the total distribution and marketing objectives.

All packaging development must include continuous monitoring, feedback, and refining to ensure that some environmental variable has not changed, or that there has not been a change in the product, or that some improvement in package materials has not introduced the possibility of effecting a change to better the performance or the economics, or both.

### **Resources Available for Packaging Development and Implementation**

In addition to the suppliers indicated above for providing the hardware and software, there are many other resources that are not always immediately visible. As indicated above, graphic designers are valued suppliers since, unlike mainstream advertising agency or free lance artists, they are experienced in packaging design including the peculiar nature of shelf display and the vagaries of package material converter printing.

Consulting firms (such as, for example, Packaging/Brody, Inc.) deliver a variety of accurate insights into the technologies of packaging, and also can, if desired, actually engineer and test the package structures and broker the supply. Most consulting organizations, if they are indeed organizations and not single persons, offer advice based on information not gleaned from experience but rather education. Packers seeking insights from consultants are urged to study their dossiers carefully to determine that their counsel is really that and not merely superficial bits of little or no real value. It is also important to ascertain that the counsel is coming from the professional with whom the communication is made. Many larger consultancies often delegate the actual consulting to persons who are either juniors or who are not busy so the inputs contain little relevant substance. The assigned person(s) have been learning about the topic during the consultancy assignment.

Many packaging journals are published in both the United States and the other parts of the world. Each is distinctive in its coverage of packaging subject material, but all share one characteristic: They are assembled and edited by journalists for maximum reader interest. Despite the reporting and investigative research behind the published pieces, they often lack the critical insights that a packaging professional would impact. Furthermore, there is little follow-up to ascertain the progress on developments. Thus packaging journals provide a highlighting service

that can represent an education for novices, and a stimulus for those who function in packaging on an every day basis. For in-depth information there is no outstanding periodical today. Nevertheless, the roles of *Packaging Digest* with its large sprawling personalized articles and *Food and Drug Packaging* with its not infrequent features and editorials, *Packaging World*, and *BrandPackaging*, targeted at marketers, cannot in any way be minimized: All offer good and timely information and are a must-reading for dairy products packaging professionals.

Nonpackaging trade periodicals such as *Dairy Field* cover packaging with rewritten press releases, reporting or, occasionally, professionally prepared pieces. Unfortunately, such journals do not provide regular information on packaging and cannot be depended upon as a source. On the other hand, when there is coverage, the information on the specific application is usually quite good. *Food Technology* offers in-depth pieces, contemporary, and future packaging technologies.

A number of books on packaging have been published, including some by this author, for example, *Encyclopedia of Packaging Technology*, second edition, 1997, John Wiley and Sons, NY. The books are usually general texts and contain only brief or passing references to dairy packaging per se. To date, to our knowledge no definitive text on dairy products packaging has been written and published. Dairy products texts often contain single chapters on packaging like this one, which is necessarily sketchy since such a broad field must be covered in such a short space.

Professional and trade associations both publish information on packaging and sponsor meetings and conferences on the subject. Those by the US professional packaging society, Institute of Packaging Professionals (IOPP), generally emphasize more general packaging topics rather than focusing on specifics of a particular group such as dairy. Recently, however, increased emphasis has been placed on food and beverage, including dairy products packaging. The reverse is true for dairy associations, which tend to focus on the mainstream of dairy products rather than on packaging for dairy products. On the other hand when a professional group covers a dairy packaging subject, the treatment tends to be quite good.

Both professional and trade associations, as well as for-profit companies organize and produce exhibitions and conferences on packaging and on dairy products. There has not yet been an American dairy products packaging exhibition, although in Europe, excellent dairy packaging expositions have been

presented from time to time. The major world packaging exposition is Interpack held every three years in Germany, but generally absent of much direct dairy packaging. In the United States, the major packaging exhibition is Pack Expo held every other year, but also suffering, in this context, from a paucity of dairy products packaging. Regardless packaging professionals involved in dairy packaging have much to gain from alert attendance at major packaging exhibitions, which usually present much that is innovative and applicable to dairy product packaging interests.

Thirteen American universities offer degree programs in packaging with one, Clemson University, offering a program in food packaging. The largest packaging program is the Michigan State University School of Packaging. Behind them is Rochester Institute of Technology. Among the other universities offering packaging are: University of Missouri (Rolla); Rutgers, the State University of New Jersey; University of Wisconsin (Stout); Indiana State University; and San Jose State University. Generally universities offering curricula in food science and technology have a single course in food packaging. Dairy curricula may sometimes offer a course in packaging from a nonpackaging faculty member. A few universities have research programs dealing with dairy packaging, the most prominent of which is North Carolina State University with an aseptic packaging center.

A very limited number of federal and state government agencies conduct research in packaging with the FDA being the most prominent among these, focusing, as might be expected, on safety aspects. Offshore, however, government and quasi-government agencies perform both basic and applied research on packaging. Among these are Campden Chorleywood Food & Drink Research Association and SIK in Sweden.

All of these groups represent resources that should be employed in comprehending the totality of packaging as it applies to dairy products packaging issues.

## **INTERACTIONS OF PRODUCT AND PACKAGING**

As has been previously mentioned, it is axiomatic that no significant interaction takes place between the contained product and the package material. This is particularly important in considering the possibility of any potentially toxic materials being extracted from the package materials into the contained product, an event specifically prohibited by law and regulation. From a business perspective any interaction

that perceptibly alters the quality of the contained product is highly undesirable.

Although the notion of extraction is relatively easy to understand, it is also necessary to grasp the idea that extraction can occur not only in what might be regarded as normal contact but also under unusual conditions. For example migration of package material constituents can occur in distribution, which may take place at ambient, chilled, or frozen conditions. Migration rates vary considerably under the three different temperature conditions with the ambient generally more rapid in accordance with Arrhenius laws that dictate exponentially increasing rates as a function of temperature. But if the product is placed in contact with the interior package material at an elevated temperature during some processing or consumer preparation time, migration can be greatly accelerated, thus leading to brief but nevertheless significant component migration. This situation became evident in the case of microwave susceptors whose normal component migration patterns in original processing, packaging, and distribution demonstrated benign activity. When the susceptors perform their normal function of surface heating, however brief, very high temperature periods occur during which new chemical entities are formed, which may migrate during the interval from the package material into the food. Although this specific situation proved to not present any public health problems, it alerted both officials and food packagers to the possibility and the potential consequences when actual use conditions are not considered.

The microwave susceptor case also highlighted another effect that was initially demonstrated with retort pouches many years ago: indirect migration. The term "indirect" is used in regulatory contexts to indicate a component that is not intentionally introduced into a food or dairy product, but enters from a secondary source such as from the surrounding package material. In this context, however, indirect means that the component comes not from the package material in direct and intimate contact with the product, but rather from a layer that is remote from contact, e.g., an adhesive or an outer ply. In this situation the migrant not only leaves its own substrate, it also migrates across other packaging components to the surface of the inner layer and potential contact with the contained dairy product.

Contact is not necessary since the migrant might evaporate or sublime into the interior package environment and then be borne to the food surface for interaction. As indicated above, these actions are

accelerated at elevated temperatures, even brief exposures.

One variable that was not always considered was that for most of the history of packaged dairy products, contact between plastic and contents was usually brief and at relatively low temperatures, thus minimizing or even hiding any adverse interaction. With the development of aseptic packaging systems, hot filling and extended shelf life using plastic packaging, product-package material contact time at ambient temperatures extended to weeks, months, and even, occasionally, years. Under these circumstances, measurable interactions can take place, with some caution required to ensure against harmful migration. Some of the interior package materials such as polyethylene are not inert to organics, and so long-term exposure can and does result in undesirable interactions. Since no known package material contains or transmutes to components that might be harmful in final product consumption, and this effect is very carefully monitored by plastic resin suppliers, the probability of a public health problem is almost absent. On the other hand interactions that can alter product quality can occur, and even if they are not harmful to consumers, they can be detrimental to sales. Thus all packaging should be tested to ensure that under the total conditions of processing, packaging, and distribution, no measurable interaction of product and package occurs.

The reverse of entry of undesirable materials is the removal of desirable constituents, another of the issues of employing plastics in proximity with the dairy product contents. Scalping or loss of product components to the contact package materials has been a known phenomenon for many years, but largely overlooked, since only infrequently was there any prolonged contact time of plastic and liquid or fluid product at ambient temperature. Since the advent of aseptic and extended shelf-life packaging, however, long-time intimate contact was initiated and conditions were established for the plastic material to remove desirable product compounds. These have been largely oil-based compounds that dissolve in polyethylene, but also include volatiles, which normally contribute to the desirable flavor attributes. Many juices are subject to scalping, an event that has led to the replacement or modification of the interior plastic heat sealants with more inert plastics.

Of some interest to fermented dairy product packagers is that measurable losses may be measured in long-term refrigerated distribution. For example during the 50+ day chilled extended shelf life of juices

in gable top polyethylene-coated paperboard cartons, the desirable flavor constituents are scalped sufficiently to be detectable by consumers. To overcome this serious problem, chilled juice packers often now specify flavor barrier plastics on the interiors of their cartons. Scalping of desirable flavor constituents of dairy products by polyolefin has been noted. Lipid-soluble volatiles might be expected to be found in the interior heat-sealant layers of dairy product packaging and to be responsible for some of the flavor deteriorations because of product over time. Dairy product packagers should be alert for this possibility in developing packaging for their products, even those being distributed under refrigerated conditions for short periods.

Yet another interaction that should be of some concern is the change in package material properties over time or the change in either product contents or the environment. For example, paperboard loses most of its physical strength when exposed to water or even water vapor. Consequently, the protection of paperboard is essential to the protection of the product. Wet strength paperboard has been a standard for years, but this is only a relatively minor temporary expedient. Hiding all raw paperboard edges and seals is another more expensive, but significant step, and is almost always employed for long-term distribution such as for aseptic packages. Perhaps this should also be standard practice for all paperboard packaging for liquid and fluid dairy products.

The nylon gas barriers of cured cheese packaging are altered by the inevitable presence of moisture and must be accounted for in developing packaging for any dairy products. The situation with the newer oxygen barrier, ethylene vinyl alcohol (EVOH), is even more severe, with as much as 75% of the gas barrier properties being lost at relative humidities above 70%. Even under these circumstances these two sensitive plastics are commercially employed for dairy product packaging because even after the property decreases, they represent superior barrier to the alternatives.

These recitations on problems with plastic packaging materials hint that perhaps avoidance of plastic might be a desirable alternative. Given that plastic materials are imperfect, in total, they generally represent a better alternative than attempting, for example, to package in uncoated paperboard, which would have no liquid barrier, or in glass that would be both expensive and hazardous to consumers in these litigious times. Furthermore, the cleaning of glass, particularly in reusable situations, is not devoid of

problems with respect to energy, breakage, and residual cleaning compounds. Metal cans would be an alternative, but metal must be plastic coated in the interior to protect the metal with almost all the problems associated with plastic in contact with product.

It is better to employ the packaging with the best combination of properties knowing in advance the problems that might be encountered, and to account for these issues, than to use a suboptimum material or structure. If plastics appear to present serious problems in this context, consider the alternatives that, in reality, could present even more serious major problems.

## **THE PACKAGE IN PRODUCT DISTRIBUTION**

Among the many functions of packaging are to protect the contents from distributional physical abuse such as vibration, impact, compression, etc. The notion of delivering dairy products one at a time is, of course, preposterous. Therefore, primary packages should be unitized into groups that are more easily moved en masse. All packaging including the primary packages must be protected throughout the entire distribution cycle, including warehousing, transportation, docking, inventorying, retailer handling, etc. The primary package itself must be able to withstand retail display, handling by the consumer, and in-home or food service handling when applicable.

Since the primary package is the principal barrier, it is necessary to engineer it to remain intact throughout the entire distribution cycle. It must withstand physical stresses such as would be encountered on the production and packaging lines, including impact, abrading, turning corners, compression, and, in dairy product plants, heat and water. Subsequent to the packaging lines, primary packages are unitized, sometimes under compression, sometimes by dropping, but in any case, to be further contained and protected by some outer unitizer. The next outer package is most often a corrugated fiberboard case, which is engineered to resist modest vibration impacts, compression, and drops. Unfortunately, corrugated fiberboard cases are susceptible to moisture and water and lose their protective properties rapidly as a result of exposure. This vulnerability must be accounted for when employing corrugated fiberboard as a distribution package.

Alternatives to the corrugated fiberboard case include corrugated fiberboard trays or pads combined with plastic (usually low-density polyethylene film

or a variation) shrink film capable of tightly binding primary packages into a single unit that is stronger than the individual primary packages because of the “cellular” construction. Shrink film is also a good moisture barrier and so protects interior paperboard from the inevitable moisture of dairy product distribution environments. The small amount of heat required to shrink the film around the unitized primary packages is so inconsequential that even ice cream packages are readily unitized and held together by heat shrunk plastic film.

Many dairy products are distributed in returnable rigid plastic crates, totes, or cases. These units, usually injection molded high-density polyethylene but sometimes polypropylene or other structures, are engineered to cradle and contain numbers of primary packages to protect them from virtually any physical abuse. Often the individual primary packages are in cells within the crate or tote to prevent the primary packages from any contact with each other and thus eliminate surface abrasion that can damage glass bottles, paperboard cartons, and even plastic bottles. When the dairy’s distribution system permits, i.e., direct delivery by a person who can take back the relatively bulky and expensive returnable plastic case, it makes physical and economic sense to employ such distribution packaging. The initial capital investment is high but the total system cost over time and repeated reuse, when the infrastructure is available and in place, is well below that of purchasing individual disposable distribution packages.

Distribution stresses and the protection afforded by various alternative distribution packaging systems may be computed by reliable tested methods with excellent predictability. These methods are more often employed by packaging engineers associated with high-price hardware items, but the test bed and computer techniques may be readily applied to distribution packaging for dairy products. In the system, test packages are subjected to known stress inputs such as vibration or impact, and the point of failure is quantified. Knowing the properties of alternative distribution packaging such as corrugated fiberboard of a specific edge crush test and dimension, or an internal egg crate-type structure, computer modeling can predict the distribution performance. In this manner the minimum distribution packaging required to protect the primary packaging may be derived by computation rather than by empirical methods. Nevertheless, it is advisable to conduct actual test shipments to verify the theoretical results. Computer methods avoid the long and tedious and often very inaccurate trial

and error methods that have been the hallmark of distribution packaging selection.

## GRAPHIC DESIGN AND ASSESSMENT

Graphic design is the development of the external appearance of the packaging to comply with regulations and to meet marketing desires that are hopefully dictated by consumer and retailer needs and perceived needs. Good graphic designers also incorporate structural features that are not incompatible with the protection requirements of the product but are compatible with retail display or consumer use, e.g., dispensing spouts. Good graphic design is performed to ensure that the package appearance in retail display has visual impact in mass among an array of other competitive packages. Designs may appear excellent in isolation, but in mass display at retail level, they might be lost. When media advertising is used, it is necessary to ensure that the package appearance is attractive in photography or on television as the case may be.

Graphic design is usually best managed from a marketing department since this is the group that is most influenced by the shelf appearance of the package. It is important, however, that the packaging development professional be actively involved in the process to ensure that the technical aspects are not violated in the name of appearance. Shelf appearance and other marketing oriented features are also important.

Graphic design today should be performed by packaging design professionals. The use of free-lance or advertising agency artists with little or no experience in packaging design is not to be encouraged. It is even better to employ professionals with experience in yogurt and fermented dairy products packaging.

In the past, all graphic design was performed with paper, pencil, colored pens, ink, etc. Such artist's renditions required time and relative difficulty of changing and evaluating changes. Today most graphic designers are able to design on graphic computers, permitting marketing managers to experience design variations immediately. Three-dimensional views may be depicted on the two-dimensional video display screen, and hard copy versions. Mass displays can be represented in virtual reality on video display screens. Almost instant color copies may be wrapped around physical structures to enable marketing managers to actually see and touch three-dimensional samples immediately. While permitting instant

packaging design, computer graphics also generate multiple variations for evaluation. Computer-graphic capabilities are so sophisticated that the camera-ready art for printing plate manufacture are generated by the computer and can even drive the plate-making process.

With design being so critical for market acceptance, personal opinion by marketing managers or graphic design managers is a poor means of selecting the optimum design. Objective evaluation of design is nearly as important for evaluation as is consumer testing of the product. If the consumer does not try the product or cannot find the product, it is of little value to the dairy. Many different techniques for packaging (graphic) evaluation are offered, not one of which is universally accepted. Each, however, has its own advocates. The most common evaluation technique probably is a focus group in which a small group of representative consumers examines and discusses the totality under the guidance of a moderator.

Among the more intriguing evaluation methods are measurement of eye movement, time required to recognize the package on a darkened screen, and measurement of brain waves responding to exposure to the design. Perhaps the best method is placement of the package in a mass display in a test store environment followed by measurement of sales and follow-up with a selected sample of purchasers to ascertain their reasons for their decision.

## ECONOMICS OF PACKAGING

Contrary to general belief, with infrequent exceptions, packaging does not cost more than the product contained. Generally packaging costs represent considerably less than 10% of the retail price of the food or dairy product on the retail shelf.

Not too long ago packaging costs were generally computed solely by the primary package materials purchase price. With education, however, packaging purchasing and marketing managers now usually measure packaging costs by adding all relevant variables and allocating all fixed, including capital, expenditures for equipment. Thus, the economics of packaging include such costs as those for the acquisition of the primary packaging materials; plus the secondary and distribution packaging materials; plus the labels, adhesives, coding inks, etc., i.e., the adjuncts, plus the labor, plus the utilities, etc. In addition, allocation of fixed plant costs such as supervision and maintenance, floor space, etc. is included. Just as important in determination of economics of

packaging is the machinery which invariably has a high initial cost and must be evaluated for output, output speed, efficiency, scrap losses, both for packaging materials and product, down time, and ability to link efficiently with both downstream and upstream packaging equipment. Only after examining all facets of packaging costs can the true economics of packaging be accurately evaluated. Soon the days of judging packaging costs on the basis of the number of colors on the label, such as was, and perhaps still is, being done for the no frills levels of packaged food and dairy products, will be ended. There is much more to packaging economics than number of colors printed, which is usually a trivial contributor to the total economics.

## REGULATION

Beyond the regulatory issues relating to the safety of package materials and the contained products are the regulations governing on-package information, i.e., the so-called labeling declarations. As should be well known to every dairy technologist, a host of federal, state, and local agencies have some manner of label jurisdiction over dairy product packaging.

The most important of these, of course, is Food and Drug Administration (FDA) whose authority usually takes precedence. Were the products meat, the United States Department of Agriculture (USDA) would have jurisdiction, taking their lead from FDA, but exercising a difference in that prior approval is often required. Alcoholic beverages fall under the Bureau of Alcohol, Tobacco, and Firearms of the Treasury Department, taking their lead from the FDA. A considerable amount of authority, usually unexercised, rests with the Federal Trade Commission, which has the power to regulate relationship of on-package information to advertising promotion and other communications.

In addition to those with legal authority are the quasi-legal groups and trade regulations, which stipulate packaging information requirements. For example the Railroad Board stipulates the mandatory labeling relating to board strength on the corrugated shipping cases. Supermarkets dictate the presence of a machine-readable universal product code (UPC) on primary packages. FDA regulations prescribe five major information items on food and dairy packages including the generic identity of the contents, net weight, source of the product, a list of ingredients in descending order or weight or volume importance, and nutritional attributes. Since 1994, all

foods offered at retail outside of food service outlets have been required to carry a complete statement of nutritional attributes in a prescribed format. The regulations also established rules for making limited health claims based on nutritional value or any other aspect of the product.

During the 1970s, FDA established a set of rules for Good Manufacturing Practices, many of which are aimed at ensuring that the packaging is safe, not only from a content standpoint but also from a processing and containment perspective. Specific rules for handling low-acid foods, and many dairy products certainly falling into this category, are in effect. These rules might be regarded as the common sense rules of operating a fermented dairy processing or packaging line, formalized as a regulation. For example anyone operating a retort must be trained in retort operation. Complete records must be kept for all low-acid retort operations. Closures for cans and glass jars, as well as other retort packages for retorted low acid foods are specified. Regulations for aseptic packaging especially with regard to thermal processing of contents, sterilization of package materials, and seal integrity are stipulated with provision made for application to FDA, if the system has not been used previously in commercial practice. FDA also requires that any organization packaging and processing low acid foods for ambient temperature distribution submit its process to FDA prior to initiating operations so that FDA can ascertain that the persons and equipment and operations are qualified to function.

The several highly publicized incidents of tampering with over-the-counter drugs and a few foods that occurred in the 1980s triggered a number of laws and regulations stipulating tamper evidence/tamper resistance for these drug products. Simultaneously many food and dairy processors and packagers implemented tamper evident/tamper resistant package features both to deter criminal intent and to deter innocent in-store taste-testing and content contamination. The rules apply only to the proprietary drugs, and so food and dairy processor/packagers are not required to follow the specific guidelines of the FDA regulations. Nevertheless, almost all food and dairy packagers that have incorporated tamper evident/tamper resistant features use the regulatory guidelines. These guidelines specify a number of devices, which are regarded as being generally effective, and the presence of a printed instruction to signal to the consumer the absence of the device or a tampered package.

In general, government regulations regarding processing and packaging of food and dairy products



are quite good and make very good sense to food and dairy packaging technologists. There is little onerous about any of the regulations since they are reiterations of good technical and commercial practices designed for delivery of safe products in packages that communicate accurate information.

## PACKAGING AND THE ENVIRONMENT

Probably the most widely discussed and debated aspect of packaging today since 1970 has been the environmental impact of the solid waste generated from packaging. Regardless of the merits of the public and private declarations, the issue has generated more laws, regulations, proposals, consumer actions, and media discussion than the combined total of all other issues related to food and dairy product packaging during that period.

According to the environmentalists fostering this issue, packaging is the major component of the municipal solid waste stream and should be eliminated or made of nothing but materials that have been recycled from the solid waste from consumers' homes. If not, goes their story, the rapidly diminishing number of landfills will overflow with this solid waste and contaminate the soil and ground water. As a result of these claims, hundreds of laws and regulations have been passed restricting food and dairy packaging, or at the very least, dictating household separation of packaging solid waste and curbside placement for recycling pick-up. Thousands of laws and regulations have been proposed to limit packaging, including stipulating minimum contents of postconsumer solid waste to be incorporated into the packaging materials. In extreme instances, packages have been banned, as in the State of Maine where the paperboard/plastic/aluminum foil aseptic brick/block pack was largely banned on the grounds that it was "not recyclable."

The actual facts refute almost all the claims regarding the role of packaging in the solid waste stream, and the chronology of the environmentalists movement in this regard reflects abrupt turns to reflect the reactions to initial misinformation that precipitated most of the laws and actions. For example, at the outset, most environmentalist groups cited "biodegradable" packaging as the best answer to the problem of solid waste, but after it was clearly and loudly demonstrated that biodegradation does not occur in reasonable time within properly constituted sanitary landfills, biodegradability was virtually erased as a

viable alternative. When recycling was demanded on the basis that no packaging was being recycled, the food and packaging industries responded with valid data demonstrating that large fractions of spent packaging materials were already being recycled.

In actual fact only 27–28% of the municipal solid waste stream is package material, a proportion that has been declining even as the rate of growth of the stream has been declining.

The argument presented is that paper is recyclable and so newspapers and telephone books may be removed from the waste stream and recycled. Although true in the technical sense, paper loses properties in each recycle and indefinite recycling can lead to no useful raw material. Properties of recycled paperboard are quite different from those of virgin and the two cannot be used interchangeably in all applications.

Without imposed laws, the paper and paperboard industry functioned well using economic laws of supply and demand. The cost of returning used glass packaging to the rapidly decreasing number of glass furnaces in the United States is too high for economic justification, but nevertheless, many municipalities are doing just that. In our lifetime there will be no economic driving force for spent glass return with one probable result being that the decline of glass as a packaging material will be accelerated.

Because the price of aluminum is so high and also because aluminum may be safely and economically recycled, aluminum can recycling has been a commercial practice for more than two decades now, or ever since the aluminum can took a commanding lead in the beer and carbonated beverage packaging market. An infrastructure has been in position, functioning well, even as the supply grows and the demand remains static.

Plastics have been the particular target of environmental agitation and regulation on the rationale that plastic does not degrade in sanitary landfills and that it is an unnecessary expenditure of our limited planetary energy resources. Consumer (and politician, often dairy technologist, marketer, journalist, etc.) perception is that plastics constitute over half of the total packaging solid waste stream. The reality is that plastics constitute about 20% of the weight of packaging.

Both the Environmental Protection Agency and responsible professional and trade organizations have developed a hierarchy of means of "coping" with packaging solid waste, with EPA also indicating that their recommendations deal with all of solid waste

and not just the minority that is packaging. Their order is source reduction, recycling, incineration, sanitary landfill, and degradability.

### **SOURCE REDUCTION**

The reduction in the quantity of packaging materials used to contain food, dairy, and other products. Source reduction is and has always been one of the primary activities of food and dairy packagers. Since these business entities produce volume and profit by lowering the delivering of the best products at the lowest cost, reducing the cost of packaging by rendering it more efficient is a normal operating procedure.

### **RECYCLING**

This category may be divided into reuse of packages directly for the same purposes such as returnable glass or plastic bottles, a procedure that involves considerable caution relative to product safety; closed-loop recycling, which means reuse of the packaging material for the same application; and recycling of the spent materials into some useful but not necessarily similar application (which is often not packaging). Much of the commercial activity centers on recycling into some packaging application that is not the same as the original or into a nonpackaging application. Among the more advanced package material recycling efforts are aluminum cans returned to produce aluminum cans, high-density polyethylene milk and detergent bottles into motor oil and liquid detergent bottles, polyester carbonated beverage bottles into polyester carpet fiber and insulated jacket filling, glass bottles into new glass bottles, and paperboard into recycled paperboard cartons or corrugated fiberboard fluting medium. The high-density polyethylene bottle recycling businesses are relatively new to the package-recycling scene and so are still relatively small.

### **INCINERATION**

When paper and plastic are burned in appropriate facilities, the energy generated can be used to heat or to produce electricity, a useful and cost effective outlet. Well-engineered incinerators can burn waste efficiently with no air contamination and with little residual ash. Although the initial capital cost is high, financial returns can be very good from the sale of steam or electric power. Obstacles to waste to energy plants include consumer perception, particularly of

the property values, dirt, and air pollution; the high amount of truck traffic necessary to feed the input scrap; and the disposal of the ash, which is perceived to be high in undesirable heavy metal elements. The “not in my backyard,” “not in my term of office” syndromes dominate the development of effective waste to energy incinerators.

### **BIODEGRADABILITY**

Self-degradation was viewed by many in the environmentalist movement as the ideal answer to packaging solid waste. The so-called “biodegradability” would remove all packaging, particularly plastic, solid waste just as soon as the packaging had performed its protection function. Archaeological studies of landfills indicate, however, that both plastic and paper in landfills did not degrade in finite times. Furthermore, if the landfills were intended for an eventual use for building foundation or any other useful application, a base that would degrade after time would be highly undesirable. Self-degradation also interferes with recycling efforts. Yet another issue of degradable plastics is the unknown end products of self-degradation, which could be toxic or even more destructive to the environment than the perceived adverse effects of packaging solid waste.

Nevertheless, efforts and investments are underway to develop and produce degradable packaging materials with the term “degradable” meaning either biodegradable or photodegradable.

Dairy interests are working diligently to minimize both the real and perceived effects of packaging on the solid waste stream. Professionals experienced in food and dairy packaging are sensitive to the role of packaging in protecting the contents on behalf of the consuming public, and of the resultant relatively minimum contribution of packaging to solid waste. Regardless of the facts, the packaging industry is working toward the resolution of the real problem, but attempting to employ only rational technical and economic means.

## **PACKAGING FOR YOGURT AND FERMENTED DAIRY PRODUCTS**

To this point, this chapter has addressed dairy packaging principles and not focused on fermented dairy products packaging. This section deals with the specific applications and descriptions of some of the major systems in use or proposed for dairy products packaging.

## **PASTEURIZED FLUID MILK**

Almost by definition pasteurized fluid milk and derivatives such as buttermilk, kefir, and drinkable yogurt are distributed under refrigeration and so are not expected to deliver long shelf lives. Microbiological control protocols today are prolonging chilled shelf lives for such products.

### **Glass Bottles**

The classical package for pasteurized fluid milk and analogs is the returnable glass bottle that is cleaned after each use, refilled with the milk, and resealed with a reclosable but disposable closure. Returnable, reusable glass bottles are used occasionally in the United States but are generally regarded as archaic even as they are advocated by environmentalists' interests. From time to time glass jars are employed for yogurt. Such product packaging is usually applied to convey premium quality. Closure is often with aluminum foil sealed to the glass finish.

### **Returnable Plastic Bottles**

Largely in response to the environmentalist movement, returnable plastic bottles were introduced into the fluid milk and analog distribution system. Any returnable/reusable distribution system requires an infrastructure that can recover the used containers and return them efficiently. To ensure the continued use of such a system, it must be economic to all involved. The thrust of the returnable plastic bottle movement in the United States was for public school-size bottles involving few, if any, fermented dairy products. The preferred plastic, polycarbonate is a tough, low barrier/high temperature-resistant plastic, which is used in packaging mainly for returnable carboys for drinking water. No commercial applications are known for returnable polycarbonate bottle or jar packaging for fermented dairy products.

### **Plastic Pouches**

For decades flexible polyethylene pouches have been used to contain fluid milk and analogues in bag-in-box configurations. The box is corrugated fiberboard for structural rigidity. Both filling and dispensing is through a plastic fitment, i.e., device, heat-welded into the plastic film at the bottom.

In Europe and Canada, consumer-size pouches fabricated from medium-density or linear low-density polyethylene films are commonly used for

fluid milk. The particular grade of polyethylene is required to achieve an effective heat seal to ensure against leakage either during filling or distribution. The resulting pouch resists impact from drops and from internal hydraulic action by the contents. The pouch is filled on a vertical form-fill-seal machine especially engineered for liquid filling. The pouch is intended to be inserted into a rigid plastic pitcher, manually cut open by the consumer, and dispensed from the opened pouch in the pitcher.

### **Tetrahedrons**

Developed as the original structure by Tetra Pak in Sweden more than 50 years ago, the tetrahedral shape has been used for fluid milk and dairy products packaging because it employed less package material per unit volume contents than any other commercial package. The shape continues to be used in Europe and occasionally in North America for liquids, despite its awkward shape for inclusion in distribution packaging, and difficulty of shelf display, in-home storage, opening, and dispensing. Tetrahedrons for pasteurized fluid milk, puddings, etc., containment are fabricated from polyethylene-coated virgin paperboard, or if for ambient temperature, shelf stable contents of a lamination of paperboard/polyethylene/aluminum foil. The package is filled and sealed on vertical form/fill/seal equipment on which the two transverse seals are at 90° angles to each other. The internal polyethylene coating serves as the heat sealant.

### **Plastic Bottles**

Extrusion blow-molded high-density polyethylene bottles are among the most popular package forms for fluid milk and its fermented and flavored analogues. The weight per unit volume of fluid contents is the lowest of any packaging structure that can be opened, reclosed, and comfortably dispensed. High-density polyethylene is an excellent water and water vapor barrier, and therefore is well suited to contain fluid dairy and analogue products. It is a low cost and easy to fabricate plastic package material, which produces a bottle that is tough and impact resistant. Bottles are filled on standard in-line or rotary turret liquid gravity filling equipment and closed with friction fit injection molded polypropylene closures usually with tamper resistant features. In recent years both unit-portion and liter-size plastic bottles have been labeled with printed full body shrink film that are highly decorated. Coupled with extended

shelf-life processing and packaging, these advances have sparked major exponential increases in sales of fluid milk products.

Injection blow-molded polyester bottles are also being applied for fluid dairy product containment. Polyester bottles are usually more expensive than high-density polyethylene but may be useful because of their clarity.

### **Gable Top Paperboard Cartons**

Below gallon size and especially in quart and half-pint sizes popular in the United States for fluid milk products packaging are gable top paperboard cartons. These cartons are made from liquid resistant, virgin paperboard extrusion-coated with low-density polyethylene to impart liquid and water vapor resistance, as well as broad range heat sealability. The cartons are delivered to dairies in knocked-down sleeve form that permits rapid erection into open top cartons on appropriate packaging equipment. On this equipment the sleeves are opened and forced over a mandrel on which a flat bottom heat seal is made by after overlapping the bottom flaps of the carton. The erected open top carton is stripped from the mandrel, set upright and filled using gravity-type filler. The top is heat-sealed by folding in a portion of the edges and face-to-face sealing the gable top using pressure and conduction heat. The cartons are sufficiently robust to contain fluid milk and analogues for the distribution times required with longer term shelf-life impractical because of the edge wicking of the paperboard (for longer distribution times, the internal construction is changed). Among the advantages of paperboard cartons are that they may be preprinted almost always with basic flexographic decoration, and now, increasingly with rotogravure or web-offset high-resolution graphics for consumer display impact. Gable top cartons are not easy to open, but are reasonable to dispense from, and are impossible to reclose improperly. They are relatively inexpensive in almost all small sizes.

### **SHELF STABLE FLUID DAIRY PRODUCTS**

Shelf stability implies heat treatment, either before or after filling to sterilize the contents, i.e., renders them free of all microorganisms of public health significance and of microorganisms that could cause spoilage under normal conditions of distribution, i.e., ambient temperature. (Obviously, altering the water activity of solids could also permit ambient

temperature shelf stability.) The term “shelf stable” means that the contents will not spoil microbiologically but does not necessarily mean that the product will not deteriorate biochemically and thus retain its initial quality.

### **Post-Fill Retorting**

Traditional shelf stability is achieved by sealing the package and applying heat sufficient for sterilization, taking account of the rate of thermal death of the microorganisms and the rate of heat penetration. For fluid dairy products, which are low acid or at a pH above 4.6, temperatures required are usually above 250°F, which implies retorting and control of external and internal pressures of the packages. Canning is the traditional postfilling heat process to achieve ambient temperature shelf stability.

Canning is largely in cylindrical steel or now aluminum cans, which are hermetically sealed mechanically by double-seaming a metal end to the body flange after filling. After closure, the cans are cooked under pressure and cooled to generate a partial vacuum within the container and reduce the rate of biochemical oxidative deterioration. Glass bottles and jars may also be considered as a segment of the canning spectrum.

After filling glass containers are hermetically closed with rubber compound-lined steel or lined polypropylene closures. The glass packages are carefully aligned and placed in retorts for pressure-cooking during which the pressure is carefully controlled with an external overpressure to ensure against internal steam pressure blowing off the closures. Furthermore, because of the usual sensitivity of glass to thermal stresses, careful increase and decrease of temperature is practiced. Very little fluid dairy product today is packaged in glass in the United States, although the practice was not uncommon two generations ago or now in Europe.

In Europe also, retorting in plastic bottles is not uncommon with high-density polyethylene and polypropylene being the packaging materials of choice. Both are resistant to retort temperatures, but are poor oxygen barriers, and so the contents are subject to significant biochemical deterioration at ambient temperatures. The system is used for relatively short-term ambient temperature distribution. Recently in the United States, liquid dairy meal substitutes have been packaged in multiplayer barrier plastic bottles that are retorted after hermetic sealing with semirigid closures.

## Aseptic Packaging

Aseptic packaging is the independent sterilization of product and package and assembly of the components under sterile conditions to achieve ambient temperature shelf stability. Because of the several operations, aseptic packaging is statistically riskier than canning, which has a final heat process to compensate for any errors prior to closure. One reason for using aseptic procedures is to significantly reduce the thermal input to the product since it can be heat sterilized in thin film in heat exchangers prior to filling. A second reason is that almost any package material, structure, or size may be used. Lightweight flexible or composite materials may be sterilized by various technologies that render the material sterile without damaging it. Sterilization of the container may be by thermal methods such as dry heat, steam, or chemicals such as hydrogen peroxide.

The most widely used aseptic packaging is paperboard composite bricks or blocks. In the Tetra Pak system, on a presterilized machine, a prescored web of packaging material is unwound into a bath of hot hydrogen peroxide and dried in a sterile environment. The web is formed into a tube in which previously sterilized, cooled fluid is pumped. Induction energy heat seals both a back longitudinal and transverse seam. The latter takes place through the product contents thus eliminating any headspace. The sealed tube is cut from the web and the pouch is formed into a brick shape on a mandrel.

On Hassia equipment, flexible tubes of barrier flexible laminations are sterilized by exposure to hydrogen peroxide followed by heat drying. The tubes are filled with presterilized yogurt or pudding and sealed at both ends to produce either sterile, or in some cases, extended refrigerated shelf life, puddings, or yogurts that have gained great popularity since the late 1990s.

In the Combibloc system, used more in Europe, paperboard composite materials are preformed in the converting plant into prescored knocked-down sleeves. At the presterilized aseptic packaging machine, the blanks are erected and set upright. Hydrogen peroxide is sprayed into the open top containers and then heated to both raise the operating temperature of the chemical and evaporate away the residual. Filling takes place in a horizontal mode with face-to-face heat sealing of the material using ultrasonic methods. Because the machine is horizontal, multiline operation is possible and speed can be as high as 400 packages per minute.

The Pure Pak gable top paperboard carton system that continues to be used occasionally in aseptic

mode is quite similar in principle of operation to that of Combibloc. Products include liquid egg, long-life cream and flavored milk.

Aseptic packaging of plastic cups may be accomplished on thermoform-fill-seal or preformed cup deposit-fill-seal systems. In thermoform-fill-seal systems, sterilization may be previous to the dairy in the converting plant or may be on the aseptic packaging machine. The most widely used aseptic thermoform-fill-seal system is from France's ERCA. On one ERCA system, the heat of extrusion of plastic may sterilize the webs to be used. On the machine a protective web of film is stripped away from the interior surface and the remaining thermoformable web is heated sufficiently to soften it. Sterile air pressure is applied to form the plastic into a cup shape in a mold. The open top cup is filled in-line and a flexible closure material is stripped of its protective film and heat sealed to the flange of the base cups. With a rate of about 20 cycles per minute 10 or more cups are formed, filled, and sealed simultaneously. Output can be as high as 300+ per minute for 4 to 8 ounce capacity cups.

Other thermoform-fill-seal machines such as another by ERCA or Bosch immerse the two webs in hydrogen peroxide and evaporate the sterilant within the machine to achieve sterility.

On the Hassia thermoform-fill-seal machine, steam is used both to sterilize the materials and to thermoform the base plastic web into cup shape. Hassia equipment has not been accepted for aseptically packaging low-acid dairy products in the United States. Thermoform-fill-seal systems generally use coextrusions of polystyrene as the thermoformable structural component and polyvinylidene chloride as the barrier component.

Deposit-fill-seal systems use inputs of preformed cups, which may or may not be sterilized on the machine. All are closed by heat sealing with flexible materials, which are either predie cut or cut from a web on the machine. The most widely used are those for liquid coffee lighteners in which the nested cups are presterilized by ionizing radiation and then aseptically transferred to the machine for denesting, filling with sterile product, and heat sealed. Portion Packaging and Purity Packaging systems are similar in operation. Both use thermoformed polystyrene cups and aluminum foil/heat seal coating closures. Generally the output is maintained under refrigerated conditions despite their sterility, thus accounting for their use of nonbarrier packaging materials.

Hamba machines are applied for aseptic packaging of milk-based puddings using prethermoformed

polypropylene cups. To date, Hamba machines have not been accepted by regulatory authorities for aseptic operation in the United States, thus accounting for the refrigerated or extended shelf-life distribution. The product's quality, however, benefits from the chilled distribution.

In Europe several aseptic bottle fillers are commercial with hydrogen peroxide as the sterilant of choice. The systems may employ either glass or plastic with polypropylene or high-density polyethylene as the preferred materials for short-term ambient temperature distribution, and coextrusions with ethylene vinyl alcohol for longer term distribution. Bosch systems have been used for infant formula; Serac, Stork, and Kronos systems have been used for fluid milk products. All are more widely used today in an ultraclean mode to produce extended (chilled) shelf-life fluid dairy products including flavored milks and drinkable yogurts. Shelf lives of more than 2 months are commonly commercial.

For larger size bag-in-box, preformed pouches fabricated from metallized polyester film and fitted with filling and dispensing fitments are presterilized using ionizing gamma radiation. On Scholle, DuPont Canada, or similar type aseptic filling equipment, sterile product is introduced through the fitment, which is subsequently sealed. Some web vertical form/fill/seal machines are also operated in aseptic mode.

## SOLID DAIRY PRODUCT PACKAGING

Often in dairy product packaging, there is little difference in filling and closing between solid and fluid products. The difference comes later in distribution after the product has set. Thus, from an initial packaging standpoint, packaging is the same, but from a package selection standpoint, it is important to choose structures that will contain the final product and be useful to the consumer. Products such as yogurt and pudding whose packaging was referred to previously are handled from a packaging operation standpoint as if they were fluids, but from a consumer standpoint, their packages must take account of spoonability. Numerous soft cheeses, spreads, etc., fall into this category.

Soft cheeses are generally pumped into either thermoformed polystyrene or injection-molded polypropylene cups or tubs, which are then closed by a combination of aluminum foil heat-sealed to the flange; friction fit thermoform, with or without tamper resistant ring around the rim. Some soft cheeses are pumped into molds and then cut to be

overwrapped, or the cheese may be pumped hot into aluminum foil lamination overwraps with the heat used to reduce the microbiological count. In Europe considerable quantities of soft cheeses are packaged on thermoform-fill-seal machines using polystyrene as the base cup material and aluminum foil lamination as the heat seal closure.

Frozen yogurt may be packaged in bulk for food service scooping and dispensing. Bulk packaging is generally, but increasingly less so, cylindrical spiral wound virgin paperboard coated with polyethylene with heat-sealed similar paperboard base and friction fit top, also paperboard. Cylindrical shapes are almost traditional from Sealright (Huhtamaki), with filling by fluid methods on their equipment. The cylinders may be received in knocked down form to save on package material inventory space in which case Sealright equipment is employed to erect the containers.

Most frozen yogurt is packaged in coated, bleached virgin paperboard half-gallon cartons received in the form of knocked down sleeves. Cartons are automatically erected and filled through one end after which they are mechanically closed by locking the tabs on the cartons. Increasing quantities of consumer size ice cream, particularly the premium types, are packaged in rectangular corner convolute wound paperboard containers which are closed by friction fit overcaps, again either paperboard or insert injection-molded paperboard/plastic. Novelties are first overwrapped on continuous motion horizontal form/fill/seal equipment with polyethylene coated paper or cavitated core oriented polypropylene as the material. Wrapped novelties are then unitized and placed in the ends of opened paperboard folding cartons, which are closed by hot melt adhesive.

Numerous other packaging technologies and materials are used commercially and are proposed for dairy product packaging. This dissertation cannot encompass every packaging means available to the dairy packager. A sampling has been offered to reflect the principal technologies and basic information has been presented to suggest to dairy packagers alternatives should the suppliers current offerings be less than desired.

## FUTURE TRENDS

There will be continued application of aseptic techniques to deliver products for refrigerated distribution. The quality of thermally processed dairy products will be better retained by chilled distribution procedures. The quality retention durations for chilled

dairy products will be extended by introduction of clean room extended shelf-life technologies.

No longer will there be specific technologies. The new dairy packager will integrate more than one packaging technology into systems that will deliver a synergy of the benefits from each of the contributing technologies. In the more distant future, packaging systems will become so sensitive and responsive that they, and not the process, will be the dominant factors in the delivery of quality dairy products. In an era of active packaging, the package will be called upon to sense the contents and to adjust to its technical needs for lower temperature, or aroma enhancement, or microbiological suppression; and to the marketers desire for impact communications with light and sound taking over for mere passive graphics.

The environmental issue is emotional and replete with misinformation and misperceptions. Regardless of the facts, numerous problems are already present. The issue will continue to mushroom with few predictable paths. Dairy packagers must be cognizant of the volatile situation and be prepared to respond to those having either the force of law or consumer perceptions, however erroneous they might be. Dairy packager suppliers are reactive to environmentalists' pressures and will usually be active in assisting their customers. The decision must be made by the dairy on response: Do they accommodate every single suggestion from the field, regardless of how it disturbs or how much it costs, or do they assume a proactive position and attempt to bring a reasoned approach to the total picture of packaging in the solid waste environment? No matter what stance they take, environmentalism will be the top priority for many years.

As dairy packaging is being advanced, its progress toward a new dimension is already visible on the technological horizon that will be recognized by a perceptive consumer.

## BIBLIOGRAPHY

- Brody A, Marsh KS. 1997. *Encyclopedia of Packaging Technology*, 2nd ed. John Wiley & Sons, New York.
- Brody AL, Lord J. 2000. *Developing New Food Products for a Changing Marketplace*, CRC Press, Boca Raton, FL.
- Brody AL, Strupinsky E, Kline L. 2001. *Active Packaging for Food Applications*, CRC Press Boca Raton, FL.
- David J, Graves R, Carlson VR. 1996. *Aseptic Processing and Packaging of Food*, CRC Press, Boca Raton, FL.
- Doyle M. 1996. *Packaging Strategy*, CRC Press, Boca Raton, FL .
- Gray I, Harte B, Miltz J. 1987. *Food Product—Package Compatability*, Technomic, CRC Press, Boca Raton, FL.
- Hanlon JF, Kelsey RJ, Forcino H. 1998. *Handbook of Package Engineering*, 3rd ed. CRC Press, Boca Raton, FL.
- Harkham, A. 1989. *Packaging Strategy*, CRC Press (Technomic) Boca Raton, FL.
- Holdsworth SD. 1992. *Aseptic Processing and Packaging of Food Products*, Elsevier, New York.
- Hotchkiss J. 1988. *Food and packaging interactions*. American Chemical Society, Washington, DC.
- Institute of Food Science and Technology. 1985. In: *Proceedings of Symposium on Aseptic Processing and Packaging of Foods*, Lund University, Sweden, SIK.
- Institute of Packaging Professionals. 1991. *IOPP Packaging Reduction Recycling and Disposal Guidelines*, Institute of Packaging Professionals, Naperville, IL.
- Jenkins W, Harrington J. 1991. *Packaging Foods with Plastics*, CRC Press (Technomic), Boca Raton, FL.
- Man D, Jones A. 2000. *Shelf-Life Evaluation of Foods*. Apsen Publications, Gaitherburg, MD.
- Osborn KR, Jenkins W. 1992. *Plastic Films, Technology and Packaging Applications*, CRC Press (Technomic), Boca Raton, FL.
- Package Machinery Manufacturers Institute. 2004. *Package Machinery Directory*. Alexandria, VA.
- Packaging Strategies. 1990. *Aseptic Packaging, USA. Packaging Strategies*, West Chester, PA.
- Paine F, Paine H. 1983. *A Handbook of Food Packaging*, United Kingdom, Leonard Hill, London, UK.
- Reuter H. 1989. *Aseptic Packaging of Food*, CRC Press (Technomic), Boca Raton, FL.
- Robertson G. 1993. *Food Packaging*, Marcel Dekker, New York.
- Selke S. 1990. *Packaging and the Environment*, CRC Press (Technomic), Boca Raton, FL.
- Selke S. 1997. *Understanding Plastics Packaging Technology*, Gardner Publications, Cincinnati/Hanser.
- Soroka W. 2002. *Fundamentals of Packaging Technology*, Institute of Packaging Professionals, St. Charles, IL.
- Stern W. 1981. *Handbook of Package Design Research*, John Wiley & Sons, New York.

*Manufacturing Yogurt and Fermented Milks*  
Edited by Ramesh C. Chandan  
Copyright © 2006 by Blackwell Publishing

# **Part II**

# **Manufacture of Yogurt**



# 9

## Yogurt: Fruit Preparations and Flavoring Materials

*Kevin R. O'Rell and Ramesh C. Chandan*

- Introduction
- Fruit as Raw Material for Yogurt Preparations
  - Processing of Fruit for Use in Yogurt Fruit Preparations
  - Formulation of Fruit Preparations
  - Specialty Fruit Preparations
- Processing Yogurt Fruit Preparations
  - Packaging of Fruit Preparations
- References
- Acknowledgement

### INTRODUCTION

Plain yogurt, which makes up 5% of the total refrigerated yogurt category, is used by consumers as low/nonfat dressing for salads, as a topping for potatoes and vegetables, as well as for cooking meals. Nevertheless, the popularity of yogurt has been propelled by the availability of sweetened fruit-flavored product (Chandan, 1982, 2004; Chandan and Shahani, 1993; Tamime and Robinson, 1999). The addition of fruit preparations, fruit flavors, fruit purees, and flavor extracts enhances versatility of taste, color, and texture for the consumer. Fruits are generally perceived as healthy by the consumer. The soluble and insoluble fiber located in the fruit extends protection against cardiovascular diseases and colon cancer, respectively. Also, some fruits, especially blueberries, contain high levels of anthocyanins, which are flavonoids that have potential health benefits functioning as antioxidants. Accordingly, fruit association with yogurt endorses the healthy image of yogurt even further.

The top 10 selling flavors that account for nearly 70% of the total volume of yogurt sold based on dollar sales in descending order are: strawberry,

vanilla, peach, raspberry, strawberry-banana, plain, blueberry, lemon-lime, cherry, and mixed berry.

The fruit preparations for addition to yogurt are specially designed to meet the marketing requirements for different types of yogurt. The stirred variety that now makes up 74% of the total refrigerated yogurt category involves mechanical blending of the fermented mass with fruit preparation. Therefore, the fruit preparation is formulated to furnish adequate viscosity for thorough blending into yogurt mass without significant dilution of the finished product. At the same time, the fruit pieces are designed to be interdispersed throughout the body of yogurt without settling on the bottom of the cup. The sensory attributes (aroma, flavor, and color) and pH (acid-sweetness balance) of the finished product depend on the contribution from fruit preparation.

In the case of fruit-on-the bottom (FOB) style that makes up 8% of refrigerated yogurt sales, the fruit preparation is designed to stay at the bottom, while either white unfermented yogurt mass (low in viscosity) or finished yogurt previously incubated in bulk is being deposited on the top of the cup. For FOB, ideally, the fruit preparation is thickened (but not gelled) to suppress fruit floatation, or mixing with the milk phase during filling or transportation. In addition, the stabilization, the calcium content, the pH, and the osmotic pressure generated by the fruit preparation at the interface of fruit and yogurt base is taken into consideration to assure compatibility of the two layers during incubation of the cup. The casein from the yogurt can precipitate out due to exposure to low pH and the osmotic pressure difference between the yogurt and the fruit preparation resulting in a lumpy or gritty texture after stirring.

The yogurt fruit preparations for consumption by toddlers and children are designed to integrate special requirements for the consumer. For instance, in toddler yogurts, to avoid choking, the fruit preparations are made from fruit purees, fruit juices, and/or flavors. This is also true for yogurt targeting children, where market research has shown a preference for no fruit particulates. Similarly, in the manufacture of whipped yogurt, the fruit preparation generally uses fruit puree that contains fruit fragments small enough so as to avoid interference with the foaming process. In case of drinks, fruit preparations are designed to contain juices, purees, and small fragments to avoid settling of fruit during shelf life of the product and enhance the drinking experience.

Fruit preparation for use in yogurt manufacture may be defined as a stabilized suspension of fruit particles or puree in a sweetened, acidified matrix, with or without added flavors/coloring material. The preparation is heat processed to effect enhancement in shelf life by destroying microorganisms and constituent enzymes. The fruit preparations are generally added to yogurt products within a range of 10–20% level in the final product. In addition, most fruited yogurts contain natural or artificial flavorings to boost the fruit flavor profile of the product. For enhancing the eye appeal, appropriate color preparations may be incorporated in the fruit-for-yogurt preparations.

The most popular fruit flavored yogurts are strawberry, raspberry, cherry, blueberry, mixed berry, boysenberry, peach, banana, lemon, tropical blends, apricot, apple, and their combinations. Also, addition of fruit and other flavors popular in the bakery and ice cream industries are incorporated to bring an innovative assortment of creative flavor profiles to the consumer.

## **FRUIT AS RAW MATERIAL FOR YOGURT PREPARATIONS**

The diversity of fruits available for fruit-for-yogurt preparations necessitates selection of cultivars that would be relevant to fruit integrity and flavor requirements in the finished yogurt product. Accordingly, the fruit should be compatible with the rigors of the processing techniques.

The quality of fruit is determined by the variety, the stock of tree/ bush, growing practices, and soil and weather conditions. The fruit grower picks the fruit according to its ripeness and maturity. Maturity of fruit pertains to the condition of fruit ready to eat right away or after a predetermined time period of ripening. Ripeness of fruit refers to peak condition of

color, flavor, and texture. For instance, fruit picking is appropriate depending on the softness of the ripened fruit. Soft fruit varieties are picked at mature stage to avoid overripeness, which other would near to undesirable transportation and processing problems.

The time to pick fruit depends on the type, variety, location, weather, and end-product use. Citrus fruits do not ripen after harvesting, while some other fruits continue to ripen under favorable conditions. The quality of fruit is generally measured by objective physical–chemical procedures. Texture is measured by compression or by force required to penetrate the fruit. The concentration of juice solids (mostly sugars) as a measure of maturity of fruit can be assessed by a refractometer or a hydrometer. The refractometer determines the ability of a solution to refract or bend a beam of light. The degree of refraction is directly proportional to the strength of the solution. The hand-held refractometers are very convenient in field conditions. A hydrometer also measures the concentration of juice. It consists of a weighted spindle with graduated stem. The hydrometer floats in a juice and the reading at the meniscus of juice and air is a measure of the density/concentration of the juice. The acid concentration changes with fruit maturity. It is measured by simple titration with standard alkali.

The flavor profile of many fruits is a function of sugar and acid ratio. Sweetness and tartness of the flavor of fruit product is assessed by this ratio. Percentage of soluble solids in a fruit is stated as degrees Brix, which relates specific gravity of a solution or juice to equivalent concentration of sucrose. In the fruit industry, the term Brix (sugar) to acid ratio is commonly used. When the Brix-acid ratio is high, the fruit contains high sugar and less acid, which in turn implies that the fruit is sweet and less tart. Seasonal variations in Brix and Brix-acid ratio are noticeable in most fruits.

After the fruit reaches certain Brix and Brix-acid ratio, it is ready for harvesting. Harvesting by hand is labor-intensive but is unavoidable in certain fruits. Use of a mechanical harvester is increasing, but precautions must be taken to avoid damage to the fruit. The harvested fruit is washed thoroughly to get rid of contaminants like soil, microorganisms, pesticides, leaves, and stems. It may be sorted according to the size and grades. Unless the fruit is grown strictly for processing, it is likely that the best quality will be shipped to the fresh market where it can command premium prices. Declining quality generally corresponds with smaller piece size. After the fresh market, the best quality is typically used for individually

quick frozen (IQF) and bulk frozen as a straight pack or a sweetened pack. The IQF processing provides fruit that will most closely approach fresh. This is because in IQF no sugar is added and freezing takes place relatively quickly, minimizing damage to the tissue by the ice crystal formation. Freezing in any form will extend the fruit shelf life for more than a year. Generally, the poorer qualities go to the purees and juice/juice concentrates. These selected fruit lots are processed further for use in the manufacture of juice, jam, fruit toppings, bakery fillings, and fruit preparations for ice cream, yogurt, and cottage cheese.

### **PROCESSING OF FRUIT FOR USE IN YOGURT FRUIT PREPARATIONS**

Yogurt manufacturers use specially processed fruit preparations because of convenience of use and to impart added value to yogurt. Since fruit suppliers specialize in general fruit processing, the economies of scale in purchasing fruit offer economical advantage to the yogurt processor. Also, the expertise of the fruit processor extends food safety and shelf-life optimization in yogurt.

Major fruit processing techniques in order of importance are canning, freezing, drying, preservation with sugar syrups, concentrating by moisture removal, preservation with chemicals, fermentation with yeasts and bacteria, pickling with vinegar, sugar and spices, reduction of oxidation with antioxidants, reducing agents and vacuum treatment, and screening of fruit from light exposure (Woodroof, 1990). The industry utilizes a combination of two or more of these techniques. Some processing methods are more suitable for certain fruits.

#### **Strawberries**

In the United States 75% of strawberry production is from California, followed by the Northwestern region. Of the total frozen strawberries used in the United States, about 25–30% are imported, mostly from Mexico and Poland. Strawberries are hand harvested in the winter and spring in the southern States, and spring and summer in the northern areas. Strawberries for processing are washed, inspected for green and defective fruit, and then sorted for quality. Typical packs include IQF and bulk frozen, with and without sugar. Sugar levels most commonly available are 4 + 1 and 3 + 1 (fruit to sugar) and the berries may be whole, sliced or crushed. The berries that do not meet grade standards are used for production of puree or

juice concentrate. Puree is produced with and without sugar and can be concentrated. For juice concentrate, berries are pressed, filtered and concentrated under vacuum to produce product from 42 to 70° Brix.

#### **Blueberries**

In North America, two distinct types of blueberries are grown. Wild blueberries that are small berries (1/4 to 3/8 inches) known for their sweet intense flavor, and cultivated blueberries that are larger berries (1/2 to 5/8 inches or larger). The wild crop is harvested by hand and the season begins in late July and extends for up to 6 weeks. Most cultivated blueberries are mechanically harvested and the season runs from April to September. Before processing, the berries are cleaned by blowing away the twigs, leaves and other debris. They are then graded for size, washed, and hand inspected for green and defective fruit. Approximately three-quarters of the processed berries are frozen, either IQF or bulk pack, straight or sugar pack (usually 4 + 1). Some blueberries are directly canned with a starch and sugar solution added. Puree and juice products are made from crushed berries, thermally treated to inactivate enzymes. Puree is typically 10–12° Brix, but can be concentrated. For making juice, berries are pressed, filtered and concentrated to 45–65% soluble solids.

#### **Raspberries and Other Berries**

Raspberries come in many varieties, mostly based on color: red, black, purple, or golden. They grow on canes and, depending on the variety, produce one crop midsummer or a second, smaller crop in the fall. The fruit is soft and easily damaged; therefore, it must be harvested by hand. The berries are washed with gentle water sprays, then drained and inspected for leaves and other foreign debris. Frozen berries are processed as IQF, unsweetened bulk or 3 + 1 sweetened pack. Raspberries are pulped to produce puree with or without seeds. For seedless puree, the pulped puree is put through a sieve to remove the seeds. Raspberry juice is typically concentrated to the 68–70° Brix.

Blackberries, boysenberries and loganberries are grown and processed in a manner similar to raspberries.

#### **Peaches**

There are many varieties grown in the United States, but they fall into two classifications: clingstone or

freestone. The name indicates whether or not the flesh adheres tightly to the pit. Freestones are usually sold in the fresh market, but some are processed. Clingstones are typically used for processing and these are canned or frozen. When the fruit is ripe but firm, it is harvested by hand. Peaches for either canning or frozen processing are inspected, graded for size, and put through a pitting machine that automatically halves the fruit. The pitted halves are processed in a lye solution to loosen the skins, which are then removed by shaker-washers. The halves may be sliced or diced in the desired size. Canned peaches are made from fruit and juice or syrups with 20–55% sugar. Frozen peaches may be packed as IQF or as syrup pack, in halves, slices or dices. The fruit-to-sugar ratios vary from 3–1 to 9–1. They may receive an ascorbic acid or citric acid treatment to preserve color. Puree is obtained from the machine pitting process or from whole fruit that is pulped, mixed with citric acid and ascorbic acid, and then pumped through two finishers, 0.25 and 0.02 inches.

### Cherries

There are many varieties of cherries but there are two main categories: tart or sweet. Tart cherries provide the majority of the fruit for the US processing. Harvesting, typically in late June through August, is by hand for the fresh market, or by mechanical shakers for processing cherries. Tart cherries for processing are first placed in a cool water bath, destemmed, washed, inspected, sorted, and then mechanically pitted. The pitting process is not 100% effective and one pit typically appears in 100 to 1,000 ounces of processed fruit. Many processors of yogurt fruit preparation further hand sort cherries before processing to highly reduce the risk of a pit in their products. Most cherries are packed as IQF or as a frozen 5 + 1 pack or puree. Some cherries are canned in juice or syrup. Juice and concentrate (typically 68°Brix) are pressed from whole frozen or fresh cherries.

### Bananas

Bananas are grown in tropical areas of Mexico, Central and South America, the Caribbean and Asia. Bananas are harvested when mature but green. To ripen quickly, they are held at 60°F with ethylene gas added. Bananas can be processed into many forms—frozen whole fruit and slices and puree, canned slices, and puree, all with or without syrup, and aseptically processed and concentrated purees.

### Organic fruits

Almost all variety of fruits can be found in organic form. Depending on the fruit, the cost premium for organic fruits is as much as 30–50% higher compared to conventional. Much of this cost is associated with the strict requirements that must be followed in production. Organic fruits must be grown and handled under the requirements of FDA 7 CFR Part 205 National Organic Program; Final Rule (FDA 2004). For the land to qualify for organic certification, it must be free of prohibited substances, as listed in 205.105 for a minimum of 3 years. For the crops, there are specific requirements for soil and crop nutrient management practice standards 205.203, seeds and planting stock practice standards 205.204, crop pest, weed and disease management practice standards 205.206, and wild-crop harvesting practice standards 205.207. The synthetic substances that are allowed for use in organic production are listed in 205.601. The producer must develop an organic system handling plan to outline how they plan to manage the land, crops, and harvesting within the organic regulations. The producer then files an application for organic certification with an Accredited Certification Agency (ACA), a third party that has been accredited by the USDA to conduct certification activities as a certified agent under the rule. The organic system plan, facilities, and appropriate records are then inspected by the ACA and considered for approval. After organic certification is granted, there are detailed yearly inspections to assure compliance with the regulations. All relevant records must be maintained for a minimum of 5 years.

### FORMULATION OF FRUIT PREPARATIONS

Typical fruit base formulation for use in yogurt using modified starch (MFS) or Pectin is shown in Table 9.1.

In the formulation of fruit preparation, the ingredients of choice are: fruit, fruit puree and juice, sweetener, stabilizer(s), acidifying/buffering agent, color, flavor, and sometimes a preservative. In addition, the fruit preparation can be used as a vehicle to incorporate vitamins, minerals, intensive sweeteners or functional ingredients (i.e., fiber, nutraceuticals).

The various forms of fruit, fruit purees, and juices used in fruit preparations have been mentioned earlier. The manufacturer of yogurt fruit preparation will set raw material specifications based on their customers need in the finished yogurt. In general,

**Table 9.1.** Formulation of Fruit Base Using Modified Food Starch or Pectin

Ingredients	Percentages	
	Starch	Pectin
Fruit	35–40	35–40
Sugar	35–45	35–45
Water	12–18	12–18
Modified starch	3–4%	0
LM pectin	0	0.5–0.7
Flavors	<1	<1
Color (optional)	<1	<1
Citric acid (to desired pH)	<0.5	<0.5
Sodium citrate (as needed for pH control)	<0.5	<0.5
Preservatives (optional)	<0.1	<0.1

for fruit particulates, the manufacturer requires fruit “practically” free from defects and extraneous material, of good character and color, and normal flavor and odor. In addition, they also specify fruit variety, size, form, and microbiological limits. The following is an example of a typical raw material specification for blueberries (Table 9.2).

There would be similar raw material specifications for puree that would include form (i.e., canned, frozen, concentration, added sugar), flavor, color, and microbiological parameters. For fruit juices, the raw

material specification would include concentration, °Brix, flavor, color, and microbiological parameters.

### Sweeteners

The next major component of fruit preparations are sweeteners. The standard of identity for yogurt, low fat yogurt and nonfat yogurt (FDA CFR Parts 131.200 to 206) (FDA 2004) specifies the allowable nutritive sweeteners that can be used. Generally most fruit preparations for FOB or Swiss/blended style yogurt applications, which are sweetened using nutritive sweeteners, use blends of sugar and high fructose corn syrup (HFCS). The sugar can be in granulated or liquid form. For liquid sugar (67.5°Brix of a sucrose solution) the facility must be equipped with an appropriate storage tank to maintain a 70–100°F temperature. Usually a 42% HFCS is used and it must also be stored in an appropriate tank to maintain a 90–100°F temperature. From these storage tanks the syrup is pumped to the batch/mixing kettles.

The most common blends of sugar and HFCS are made up in a 50 : 50 mix based on solids. This blend provides a good balance between clean flavor release and cost. Increasing the portion of HFCS will provide a lower cost, but can mask some of the flavor release. Some private label or economy brands could utilize 100% HFCS as the sweetener. On the other hand,

**Table 9.2.** Typical Specification of Blueberries for Manufacture of Fruit Preparation Designed for Use in Yogurt

Company Information	Date :
Raw Material Specification	
Material item number :	
Material : Wild blueberries.	
1. Fruit variety: Wild blueberries (no specific variety) sourced from the Northwest or Canada.	
2. Form: IQF or frozen straight bulk pack	
3. Character: The berries should have reasonably uniform dark blue-purple color with no more than 8% red-purple color. Berries should be firm, reasonably fleshy, practically all whole with no more than 5% by weight that are crushed, mushy or broken.	
4. Size: $\frac{1}{4}$ to $\frac{3}{8}$ inch preferred. 1000 berries per pound with a range of 900 to 1200.	
5. Extraneous material: Per 30 pound box. No more than 3 whole leaves or 8 stems (larger than $\frac{1}{2}$ inch) and no more than 3 stem clusters. No more than 25 green, undeveloped edible berries.	
6. Foreign material: No insects, nonberry related wood, debris or dirt of any kind.	
7. Microbiological:	
Standard plate count—10,000 CFU/g max	
Yeast and mold—2,000 CFU/g max	
Coliform—50 CFU/g max	
Salmonella—Negative	
Listeria—Negative	
Hepatitis—Negative	

for those looking to get a cleaner ingredient label for their consumer and to provide a sharp, cleaner flavor release, 100% sugar can be used in the fruit preparation.

Other nutritive sweeteners that might be used in fruit preparations include crystalline fructose, fruit juice concentrate, tapioca or rice syrup, agave, honey or maple syrup. The choice of these sweeteners is usually determined by marketing considerations for the label declaration. In addition to providing a “clean label,” crystalline fructose provides more sweetness at the same solids level as sucrose and a cleaner flavor release, but at a higher cost.

The total sweetness of the fruit preparation must be balanced with the usage rate and sweetness, if any, of the yogurt base. Most fruit preparations for Swiss or blended yogurts are used at 12–18% and are formulated for a 36–55°Brix. For FOB fruits, the most common usage is from 15% to 20% with fruit preparation formulated for a 45–50°Brix.

**High Intensity Sweeteners.** There are several high intensity and noncaloric or nonnutritive sweeteners used as sweeteners in fruit preparations used in yogurt. Some of the FDA approved high intensity or nonnutritive sweetener options are: aspartame (APM), sucralose, and acesulfame-K (Ace-K). These can be used alone or in combination with nutritive or other nonnutritive sweeteners.

Aspartame was one of the first high intensity sweeteners used in yogurt fruit preparations. APM is made from two amino acids (L-phenylalanine and L-aspartic acid) and, therefore contributes four calories per gram. But since it is 180 to 200 times sweeter than sugar, the usage levels are so low that it contributes essentially no calories. Limitations of APM include lack of stability and loss of sweetness when exposed to high temperatures over extended periods. For best results, it is recommended not to process APM containing fruit preparations above 96.1°C (205°F) for more than 5 minutes. In addition, the fruit should be cooled down to 32.2°C (90°F) or lower, immediately after heat treatment. Therefore its use is limited to aseptic fruit processing systems, and the packaged fruit is recommended to be stored refrigerated during its code life. Because of these limitations, today most yogurt products add the APM as a sweetener during the time of yogurt manufacturing. In yogurt products, the stability of APM is increased due to refrigeration and the pH range of yogurt. Today, APM is used in combination with Ace-K, HFCS or crystalline fructose in yogurt.

Ace-K is a white, odorless, crystalline sweetener that is not metabolized by the body and is therefore classified as nonnutritive. It is 200 times sweeter than sucrose and remains stable under high temperatures. Studies have shown that after several months of storage at room temperature, virtually no change in Ace-K concentration was found in the pH range common in fruit preparations. Ace-K has a slight aftertaste; however blending with other sweeteners can improve the taste profiles, in addition to offering economic and stability advantages. Ace-K is commonly blended with APM or sucralose in fruit preparations for yogurt.

Sucralose is made from sugar through a patented process involving the selective chlorination of sucrose replacing three hydroxyl groups of the sugar molecule with chlorine atoms. It is 600 times sweeter than sucrose and does not break down in the body (nonnutritive). Sucralose has excellent stability under a broad range of processing, pH, and temperature conditions and does not lose sweetness over extended periods of time. Because of these attributes, it is an excellent sweetener for fruit preparations that are designed for use in low sugar yogurt products. It can be used alone or sometimes it is combined with other nonnutritive sweeteners like Ace-K. There is a synergistic effect using the sucralose-ace-k combination that improves the taste profile and limits the lingering aftertaste sometimes associated with sucralose.

## Stabilizers

The most common stabilizer used for both blended and FOB yogurts is modified food starch (MFS) usually derived from corn. The starch undergoes a two step chemical modification that provides resistance to shear, and stability against retrogradation and syneresis during long term storage in fruit preparation. In addition to its excellent functionality, MFS is easy to handle in processing and is cost effective. One disadvantage of some modified food starches, particularly cook-up starches, is their tendency to mask flavor release. MFS that is derived from tapioca is sometimes desired for labeling purposes and it can exhibit less flavor masking. There are also organic and natural starches that have not been chemically modified. These have been evaluated in fruit preparations, but to date, because of their lack of stability, they have had limited success in commercial production.

Another popular stabilizer used in fruit preparations is pectin derived from either citrus peel or apple

pomace. Pectin is more expensive but is preferred in applications that require a natural label perception. Many FOB fruit preparations use pectin or a blend of pectin and locust bean gum as the stabilizer of choice. (Hoefer, 2004). Various pectins are primarily polymers of polygalacturonic acid, which are esterified to different degrees. Pectin functions as a gelling agent, thickener, and suspending agent in fruit preparations. They are processed to yield two general types of commercial pectin products—high and low methoxyl.

High methoxyl (HM) pectins are characterized by an esterification degree of greater than 50% and are capable of forming gel networks at high acid pH's (around pH 3) in the presence of high soluble solids (greater than 55%). HM pectins are used as the stabilizer for traditional fruit preserves.

Most modern fruit preparations use low methoxyl (LM) pectins either alone or in combination with locust bean gum or a small amount of HM pectin. LM pectins require only a controlled amount of calcium ions to form gels. Gelation can take place across a

wide pH range (from pH 2.9 to 5.6) and soluble solids content from 10% to 80%. LM pectins offer the following advantages in fruit preparations:

- Setting temperature is independent of cooling rate
- The final product is thermo-reversible
- The fruit preparation has an excellent resistance to shearing during mixing or pumping and exhibits no syneresis

When using LM pectin in FOB yogurt fruit preparations, it is essential to obtain the right level of calcium saturation to avoid problems with the fruit texture and degradation of yogurt white mass at the interface. If the LM pectin is too short in calcium saturation, the fruit preparation will form a firm “hockey puck” at the bottom of the cup and the resulting stir-out will contain small colored gelled lumps. If the LM pectin is fully saturated, free ionic calcium from the yogurt, along with citric acid and other constituents from the fruit will result in white mass degradation or a “leathery-gritty” interface. The ideal fruit

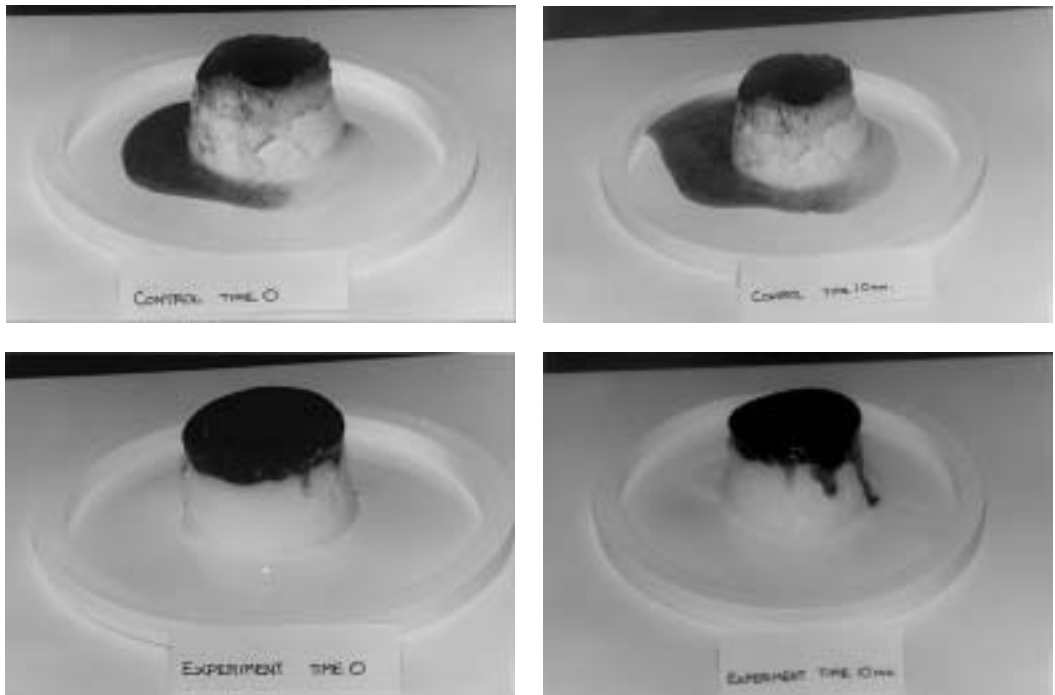

**Figure 9.1.** Effect of low methoxy pectin on the properties of fruit. The Control FOB yogurt fruit contains high methoxy fruit. Following inversion of yogurt cup, notice the fruit flows freely around the yogurt gel. When low methoxy pectin is used in the Experimental samples, the fruit forms a cohesive mass on the top of yogurt layer.

preparation will not cause white mass degradation and will stand upon the inverted white mass with only minimal run off (Fig. 9.1). It will appear to be a soft hockey puck and can be easily stirred into the yogurt, resulting in a smooth appearance.

Locust bean gum (LBG), at range of 0.2–0.3%, is sometimes used in combination with 0.5–0.6% LM pectin. Locust or carob bean gum is a hydrocolloid produced from the seeds of the evergreen locust bean tree, which grows in the coastal regions of the Mediterranean. Chemically, LBG is classed as a galactomannan. It is primarily used for its ability to increase viscosity and it is helpful in preventing fruit flotation especially in large size containers. When used in combination with pectin, it results in a different gel set, usually softer, and provides a slight cost savings.

### Flavor Preparations

Flavor preparations used in yogurt manufacturing consist of vanilla or fruit flavors.

**Vanilla.** This flavor is the second best selling flavor of commercial yogurt accounting for more than \$200 million in total sales. Most of the vanilla beans (65–70%) come from Bourbon islands (Madagascar, Comoro, Reunion, and the Seychelles). Indonesia and India supply 25–30% of the world's bean production. However, Bourbon beans are considered as the source of finest vanilla. Vanilla beans are derived from the fruit of *Vanilla fragrans*. This plant belongs to orchid family. The beans are harvested, and cured. During this process, fermentation and “sweating” of beans gives rise to methyl vanillin, the predominant flavor principal of natural vanilla extract. To prepare the extract, beans are extracted with a mixture of water and alcohol. Optional ingredients of extracting solvent are glycerin and sugar. One gallon of standard strength vanilla extract is equivalent to 13.34 oz. of vanilla beans. Alcohol content of the extract ranges from 30% to 50%. By evaporating solvent, concentrated extracts (2 to 5 fold) are also available (Marshall and Arbuckle, 1996).

It is most common to use vanilla extract added in yogurt production after fermentation for blended yogurts or added prior to fermentation for cup set yogurt. Some manufacturers prefer to obtain vanilla in processed syrup from a typical fruit preparation supplier. To prepare these vanilla syrups, vanilla extract is processed with sugar and/or HFCS to a finished Brix of 50–60°, usually at a similar Brix level to the

fruit preparation that they are purchasing. With this syrup, it is possible to produce both vanilla and fruited yogurts using one plain yogurt base.

Some yogurt producers prefer powdered vanilla because it does not cause dilution of yogurt with vanilla solvent, alcohol. To prepare the powder, vanilla beans are ground with sugar. Specks of vanilla beans are visible in this type of powder. If no specks are required, the powder is obtained by drying under vacuum a blended paste of single strength vanilla extract and sugar. The proportion of vanilla extract and sugar is designed to yield single strength vanilla powder.

Artificial vanilla flavor is prepared from synthetic methyl vanillin. This flavoring offers cost savings because of its flavor potency but the label of the product must indicate artificial flavor. Furthermore, its flavor balance and aroma are considered less desirable than natural vanilla. In relation to flavor strength, 0.7% solution of vanillin is equivalent to one pound of dry vanilla beans. Pure vanilla flavoring has a standard of identity (FDA 21 CFR 169.175) (FDA 2004). Mixtures of pure vanilla and vanillin are covered in FDA 21 CFR 169.177 (FDA 2004). Imitation vanilla is identified in FDA 21 (FDA 2004) CFR .169.181.

**Fruit Flavors.** The flavor options commonly used in fruit preparations or flavored syrups are natural, natural/WONF (with other natural flavors), N&A (natural and artificial) or artificial. The majority of fruit preparations today use natural/WONF. Most manufacturers will custom-formulate the flavor system to meet the customer's need. Usually the purpose of using N&A or artificial flavors is to reduce the flavor cost. Drinkable yogurts might use flavored syrups that consist of sugar or HFCS, a small amount of stabilizer for viscosity and flavoring.

### Colors

The color of the fruit preparation is usually used to color the finished yogurt. The options include, no color added therefore relying on the natural color of the fruit, or color added, natural colors, or artificial colors. Artificial colors (red #40, blue #1, and yellow #5 & #6) are very stable during processing, fruit shelf life and during code life of the yogurt. These are the most economical choice, but have fallen out of favor for labeling reasons.

The use of natural colors in fruit preparations is more common. Natural colors used in the finished yogurt, added either through the fruit preparation



or to the yogurt directly, are considered “color additives” and must be declared as “color added” or by the ingredient name in the ingredient declaration. Color additives not subject to certification may be declared as “Artificial Color,” “Artificial Color Added,” or “Color Added.” Alternatively, such color additives may be declared as “Colored with \_\_\_” or “color,” the blank to be filled with the name of the color additive listed in the applicable regulation in part 73 of this chapter FDA 21 CFR 101.30(k)(2) (FDA 2004). Some of the natural colors that are preferred because of their heat stability during processing are black carrot, grape extract (Kosher or non-Kosher), choke berries, elderberry, red cabbage, radish, black currant, carmine, annatto, and turmeric. Some of these colors that are used will simply appear as “vegetable color” in the ingredient declaration. Beet juice is sometimes used in fruit preparations, but because of its instability to heat processing, many times it will be added at the yogurt manufacturing step.

### Acidulants

Fruit preparations are generally acidified to pH 3.4–4.1. The most commonly used acidulant is citric acid. If a more natural label is desired, lemon juice concentrate, a more costly alternative, can be used. For some fruits, such as strawberry, blueberry, or raspberry, malic acid can be used to help enhance certain

flavor notes. The high acidity level helps bring out the fruit flavor and is more compatible with the acidity of the yogurt. When using acids in fruit preparations, it is common to also add buffering agents such as sodium citrate.

### Preservatives

Some fruit preparations contain added preservatives. This is especially the case for fruit preparations that are processed using the “hot pack” method. The most common preservative used is potassium sorbate, either alone or in combination with sodium benzoate. The total usage rate will range from 0.075% to 0.20% in the fruit preparation. Fruit processed using an aseptic system does not require added preservatives, but some product manufacturers will add them for added protection. Most fruit preparations have a 4-month shelf life, but some formulations that use artificial colors and/or flavors can have as much as a 6-month shelf life.

A sample specification sheet for a raspberry fruit preparation for blended or Swiss style yogurt is shown in Table 9.3.

### SPECIALTY FRUIT PREPARATIONS

There are also other specialty fruit preparations that are produced for a specific application, or market,

**Table 9.3.** Typical Specification Sheet for Fruit Preparation Designed for Use in Blended/Swiss-Style Yogurt

Company Information	Date:
Product: Raspberry swiss-style fruit for yogurt	
Product code #:	
Recommended usage: 15% in a yogurt with 3% added sugar	
Ingredient statement: Sugar, water, raspberries, pectin, locust bean gum, natural flavors	
Physical Specifications:	
°Brix: $50 \pm 2.0$	
pH: $3.6 \pm 0.02$	
%Fruit: 30%	
Appearance: Red, opaque viscous liquid without seeds.	
Microbiological Specifications:	
Total plate count: <10 CFU per gram	
Yeast & mold: <10 CFU per gram	
Coliform: <10 CFU per gram	
E. coli: Negative	
Salmonella: Negative	
Staphylococcus: Negative	
Shelf life & Storage: 150 days refrigerated; 90 days between 60–90°F	
Packaging: 2000 lb stainless steel tote	

**Table 9.4.** Organic Ingredients as Defined by FDA 7 CFR 205 (FDA 2004)

---

Organic fruits, fruit puree, and fruit juice/concentrate
Organic sugar or organic evaporated cane juice
Organic Compliant Ingredients (as defined by 7 CFR 205)
Citric acid—allowed 205.605 (a) (1) (ii)—produced by microbial fermentation of carbohydrate substances
Calcium chloride—allowed 205.605 (a) (4)
Vegetable colors—allowed 205.605 (a) (5)—nonsynthetic sources only
Flavors—allowed 205.605 (a) (9)—nonsynthetic sources only and must not be produced using synthetic solvents and carrier systems or any artificial preservatives.
Ascorbic acid—allowed 205.605 (b) (4)
LM pectin—allowed 205.605 (b) (21)
Sodium citrate—allowed 205.605 (b) (31)
Locust bean gum—allowed 205.606 (b)—gums water extracted only
HM pectin—allowed 205.606 (e)

---

such as organic or unsweetened/concentrated fruit preparations. Unsweetened fruit preparations are very low Brix (12–30°), have a high concentration of fruit (40–60%), and are processed aseptically. They are added at lower usage rates (10–12%) in a yogurt sweetened with nutritive or high intensity/nonnutritive sweeteners. They can provide in-plant flexibility to be used in an array of product formulations, and offer freight and storage savings.

The organic yogurt market is growing at 22% per year in dollar sales, and is gaining interest from yogurt producers. Because fruit preparations are formulated using some ingredients that are nonagricultural, they can not be made to meet the 100% organic label. However, it is very possible to produce organic fruit preparations that meet the 95% minimum of organic agricultural products by weight, excluding water and salt. This is possible because the remaining 5% or less of the necessary ingredients needed are allowed in 7 CFR 205.605—nonagricultural (nonorganic) substances allowed as ingredients in or on processed products labeled as “organic”. . . . (a) nonsynthetics allowed and (b) synthetics allowed and 7 CFR 205.606—nonorganically produced agricultural allowed as ingredients in or on processed products labeled as “organic” . . . . .

Table 9.4 lists organic and organic compliant ingredients typically used in the preparation of an organic fruit preparation.

It should be noted that if any agricultural ingredient, including those listed in 205.606, becomes available commercially it must be used in an organic product. Commercially available is defined in 7 CFR 205.2 as the ability to obtain a production input in an appropriate form, quality, or quantity, to fulfill an

essential function in a system of organic production or handling, as determined by the certifying agent in the course of reviewing the organic plan. Today an organic LBG is being produced, and will be tested in organic formulations to assess its function and quality as a replacement for conventional LBG currently being used.

Table 9.5 shows more popular fruits and flavors/colors used in yogurt. This list contains an array of fruits and flavor combinations to offer a wide variety of innovative selections for various segments of yogurt consumers.

## PROCESSING YOGURT FRUIT PREPARATIONS

There are two basic processes used in the manufacture and packaging of yogurt fruit preparations. The conventional “hot pack” processes using open cooking kettles, and the closed aseptic process and packaging system.

In the conventional hot pack process (Figure 9.2) using modified food starch as the stabilizer, the basic processing steps are:

1. Add fruit, 75% of the sugar, 50% of the water, and preservatives to a steam jacketed kettle with agitation.
2. In a second kettle, add the starch to the remaining water. Mix well and then add the starch slurry to the first kettle.
3. Heat to 85–87.8°C (185–190°F) with continuous agitation.
4. Add the remaining sugar to cool the batch.
5. Add flavor and color and mix well. At this point, the quality control check is applied. Pull sample

**Table 9.5.** Various Fruit Flavors Used in Commercial Yogurt

Style of Yogurt	Flavors Available
Fruit-on-the bottom	Apple cinnamon, blueberry, boysenberry, cherry, mixed berry, peach, raspberry, strawberry, strawberry banana, tropical blends
Stirred/blended	Strawberry, strawberry banana, blueberry, cherry, raspberry, peach, raspberry banana crème, berry banana, blackberry harvest, blueberry crumble, boysenberry, cherry orchard, coconut cream pie, french vanilla, harvest peach, key lime pie, lemon burst, mandarin orange, mixed berry, mountain blueberry, orange crème, peach cobbler, pina colada, pineapple, red raspberry, strawberry, strawberry banana, strawberry cheesecake, strawberry kiwi, strawberry mango, tropical peach, white chocolate raspberry
Whipped	Strawberry, strawberry mist, raspberry mousse, cherry chiffon, french vanilla, key lime pie, orange crème, peaches n' cream, blueberry mist, strawberry banana bliss
Drinks/smoothies	Strawberry, strawberry banana, tropical, raspberry, peach, mixed berry, peach passion fruit
Extra-thick	Banana, blackberry harvest, blueberries 'n cream, crème caramel, key lime pie, lemon supreme, orange crème, peaches n' cream, royal raspberry, strawberry, strawberry banana, vanilla
Light	Apple turnover, apricot mango, banana crème pie, berries n' cream, blackberry, blackberry pie, blueberry, blueberry patch, boston cream pie, cherry vanilla, harvest peach, key lime pie, lemon cream pie, lemon chiffon, orange crème, orange mango, peach, raspberry, red raspberry, strawberry, strawberry kiwi, strawberries n' banana, strawberry orange sunrise, very cherry, very vanilla, white chocolate raspberry, white chocolate strawberry
Children's dual color	Cotton candy/strawberry kiwi, raspberry rainbow/strawberry bash, rockin' rainbow sherbet/outrageous bubble gum, triple cherry/wild berry blue, watermelon burst/strawberry punch
Toddler's	Strawberry-banana, strawberry-strawberry vanilla, strawberry banana-peaches n' cream, peach, pear
Lo carb	Strawberry crème, peach crème, blueberry crème, raspberry crème, peaches 'n cream, raspberry 'n cream, strawberries n' cream, vanilla cream
Probiotic/bio-yogurt	Strawberry, vanilla, orange
Yogurt in a tube/portable	Strawberry milkshake/banana split, red raspberry/paradise punch, strawberry banana burst/watermelon meltdown, strawberry kiwi kick/chill out cherry, strawberry splash/berry blue blast, cool cotton candy/burstin' melon berry, crazy berry bolt/extreme red rush

from fully batched and mixed kettle and check °Brix, pH and color, as per specification.

- Pack the product at 71.1–73.9°C (160–165°F) into the appropriate container.
- Cool the product in the container with blast cooling.

Generally preservatives, such as potassium sorbate, are added to the fruit preparation that is produced using the conventional hot pack process.

In the aseptic process (Figure 9.3) and packaging system, using modified food starch as the stabilizer, the basic processing steps are:

- Add fruit, sugar and 50% water to a steam jacketed kettle with agitation.
- In a second kettle, add starch to the remaining water and mix well. Add starch slurry to the first kettle.
- Preheat ingredients to 37.8°C (100°F).
- Add flavor and color and mix well.

Quality Control check: Pull sample from fully batched and mixed kettle and check °Brix, pH, and color as per specification.

- Pump mixture through an aseptic system capable of rendering the finished product commercially

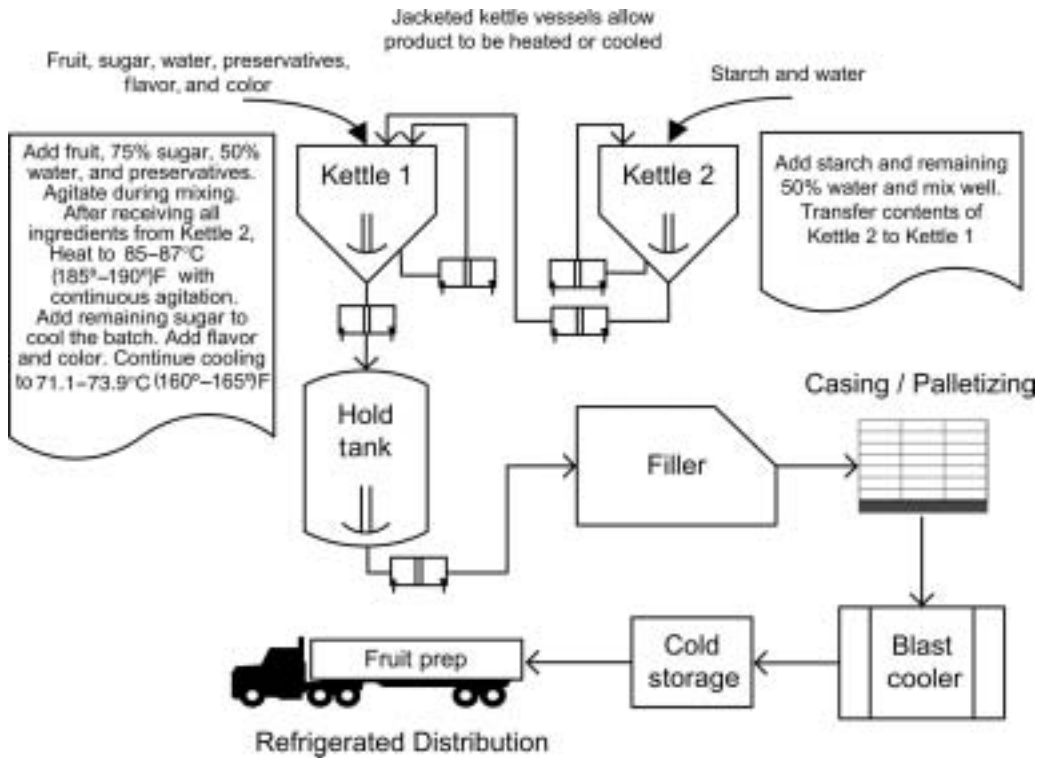

**Figure 9.2.** Process flow sheet for fruit preparation using the Hot Pack kettle procedure.

sterile. Most systems use scraped-surface heat exchangers to achieve temperatures of at least  $87.8^{\circ}\text{C}$  ( $190^{\circ}\text{F}$ ) (usually  $90.6\text{--}93.3^{\circ}\text{C}$  ( $195\text{--}200^{\circ}\text{F}$ )) with continual agitation to insure thorough heating and mixing. After heating, the product is held for 3 minutes to allow heat penetration of the largest particulates.

6. The product is then cooled by scraped-surface heat exchangers to  $26.7\text{--}32.2^{\circ}\text{C}$  ( $80\text{--}90^{\circ}\text{F}$ ).
7. Pack the product using filling equipment designed to maintain commercial sterility into a hermetically sealed container of choice.

When pectin is used as the stabilizer for the fruit preparation, it is prepared as a solution in hot water using a high speed mixer and a separate kettle or slurry tank. The high speed mixer is necessary because pectins swell very fast and lumps may occur. The pectin solution is then added to the hot mix before addition of the bulk of the sugar. If low methoxyl pectin is used, any additional acid should be added with the fruit at the beginning of the boil (cooking),

while with high methoxyl pectin it must be added near the end of the boil. The same high speed mixer-kettle/tank set-up can be used for addition of other hydrocolloids such as locust bean gum or guar gum.

Hermetically sealed container means a container that is designed and intended to be secure against the entry of microorganisms and thereby to maintain the commercial sterility of its contents after processing. [FDA 21 CFR 113.3(j) (FDA 2004)]

Aseptic processing and packaging means the filling of a commercially sterilized cooled product into presterilized containers, followed by aseptic hermetic sealing, with a presterilized closure, in an atmosphere free of microorganisms. [FDA 21 CFR 113.3 (a) (FDA 2004)]

“Commercial Sterility” of thermally processed food means the condition achieved by the application of heat, which renders the food free of:

- Microorganisms capable of reproducing in the food under normal nonrefrigerated conditions of storage and distribution; and

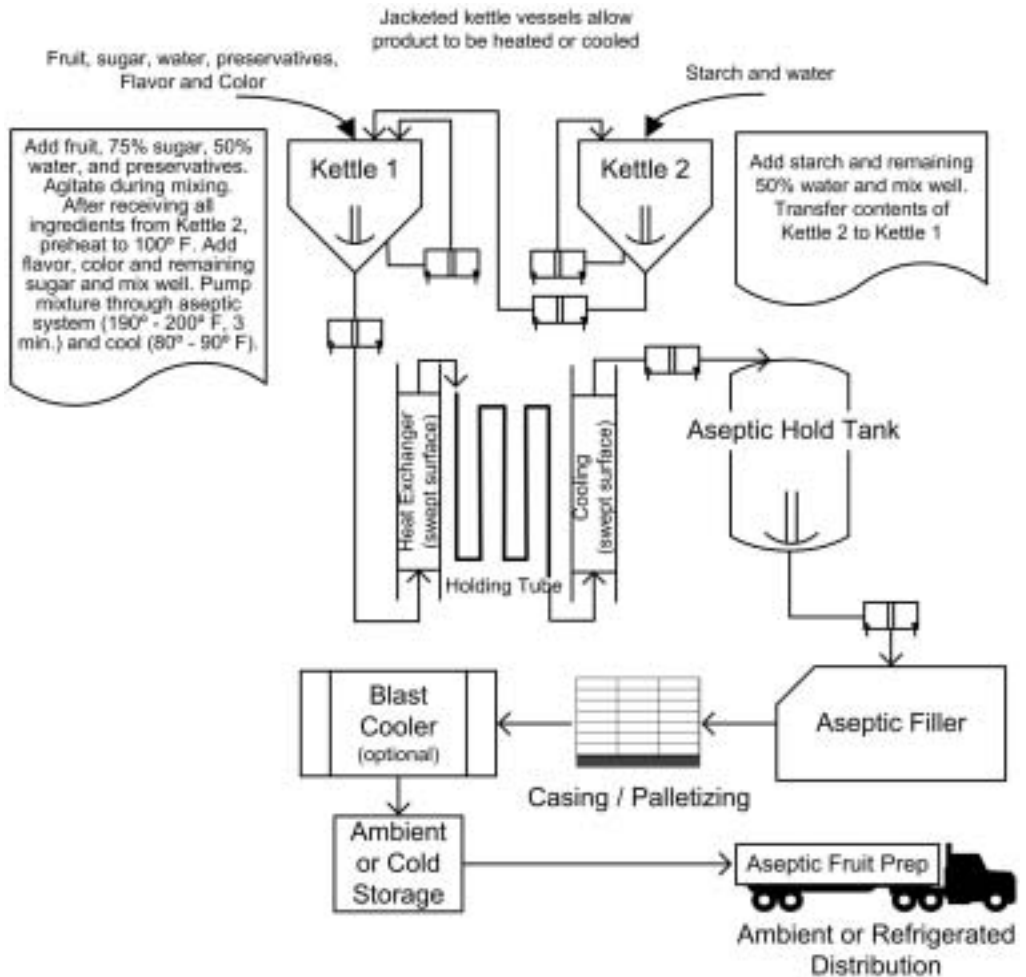

**Figure 9.3.** Flow diagram for Aseptic process of manufacturing fruit preparation for yogurt.

- Viable microorganisms (including spores) of public health significance.
- Commercial Sterility of equipment and containers used for aseptic processing and packaging of food means:
- The condition achieved by application of heat, chemical sterilant(s), or other appropriate treatment that renders the equipment and containers free of viable microorganisms having public health significance, as well as microorganisms of nonhealth significance, capable of reproducing in the food under normal

nonrefrigerated conditions of storage and distribution. [FDA 21 CFR 113.3 (e) (FDA 2004)]

In aseptic processing systems the heating and cooling is usually performed in either vertical or horizontal scraped-surface heat exchangers constructed of a hollow stainless steel or nickel. The heat exchange cylinder is most often six inches in diameter. Around the heat exchange tube, another cylinder is welded or attached creating space for a heat exchange media such as steam for heating, or water, glycol, or ammonia, for cooling. Product is pumped through

the inner tube while heat exchange media is circulated in the annular space between the tubes.

To prevent the product from burning or freezing on the heat exchange wall, a mutator with blades is concentrically positioned inside the inner cylinder. As the mutator turns within the tube, the scraper blades lightly and continuously scrape the wall. This action assures less damage to the particulate identity of the fruit in suspension during heating and cooling.

The filler used in aseptic packaging is independently sterilized by circulating 121.1°C (250°F) steam for approximately 30 minutes. Sterile, heated air is then introduced into the filling chamber of the machine. When filling bags (from 5 to 200 gal), the bags come to the processor presterilized by gamma radiation. During filling, the bag is put inside the sterile filling chamber, the bag cap is removed, the filling head is inserted into the spout area of the bag, and the product flow begins. When the proper amount of product is in the bag as determined by a scale or flow meter, the product flow stops, the filling head is removed from the bag, and the cap is replaced. The bag is then ejected from the filling chamber.

Using fruit preparation that is aseptically processed, not only assures the microbiological sterility of the fruit, but improves the overall quality and greatly helps improve convenience, transportation, and in-plant handling. There are advantages using aseptic processing and packaging as compared to open-kettle or hot-pack processing for the manufacture of yogurt fruit preparation. These include:

- Greater retention of natural fruit color. Open kettle/hot pack processing requires a 30–40 minute heating period to reach the 87.8–93.3°C (190–200°F) cook temperature with a packaging temperature of 60.0–71.1°C (140–160°F), depending on the total solids, preservatives, and pH. After hot filling, the bulk container (5–55 gallons) takes from 4 to 36 hours to bring the equilibrium temperature of the product in the package to 37.8°C (100°F) or below. In an aseptic process system, continuous heating and cooling within required sterilization time exposes the product to considerably less heat, resulting in a retained natural color.
- Improved flavor—Since heating takes place in a completely closed heat exchanger, the volatile flavor components or essences of the fruit cannot escape into the atmosphere.

Better retention of nutrients also results from an enclosed heat exchanger. As much as 90–95% of the nutrients can be retained.

The need for preservatives is eliminated because the product has been heated for sterilization, cooled and filled in a sterile atmosphere, and packaged aseptically. This also means that the product does not require refrigeration in transportation and storage offering refrigeration savings.

A more consistent product can be produced by aseptic fruit processing. Fruit flotation in the package is virtually eliminated by the rapid cool down and accompanying viscosity build-up possible through room temperature packing.

The aseptic process is energy efficient. Approximately 50% of the thermal energy of open kettle heat processing is lost to the atmosphere. In addition less thermal energy usage is required to get the aseptic product back to room temperature.

## PACKAGING OF FRUIT PREPARATIONS

Fruit preparations for yogurt can be packaged into a variety of sizes and container styles (Fig. 9.4).

Sizes generally range from 50 lb bag-in-box to 2000 lb aseptically filled containers. The 50 lb bag-in-box filled either aseptically or “hot packed” is still a popular container choice for yogurt manufacturers. It provides flexibility in the plant for production of small flavor runs. However, it is labor intensive, creates a potential source of contamination when unloading, despite the best efforts to sanitize both bag and hands and it can introduce unwanted corrugated packaging material into the filler room. The next size to consider is the 400–500 lb bag-in-drum. This container is usually aseptically processed where it can be filled at 80–90°F. There are some “hot packed” bag-in-drum products manufactured, but cooling is a challenge and it may not work for all formulations. The 400–500 lb bag-in-drum can be the traditional type bag that is opened at the top and evacuated using a Graco-type fruit pump, or it can be equipped with a bottom unloading valve that can be attached and unloaded with a positive pump.

Large volume yogurt manufacturers prefer to receive and handle fruit preparation in 1800–2000 lb tote containers. Because this size container would not be able to be cooled efficiently and quickly, it is filled using an aseptic processing system. There are generally three types of these containers used, the one-way tote, the collapsible tote, and the returnable stainless steel tote. The one-way tote uses a large multilayered laminate bag equipped with both a filling cap and an evacuation fitting that has been sterilized prior to delivery to the fruit processor. This bag is then filled



**Figure 9.4.** Packaging containers of fruit-for-yogurt. Courtesy of Eric Ducey, Fruit Crown.

aseptically and placed into a large heavy corrugated container and delivered on a pallet. The yogurt manufacturer will recycle the corrugated and dispose of the plastic liner. The collapsible tote uses a similar inner bag but uses a custom crate to hold the bag in place during shipping and use at the yogurt manufacturing plant. After use, the inner bag is disposed at the plant and the crate “breaks down” or collapses for easier and more economical shipping back to the fruit preparation supplier. The stainless steel tote is steam sterilized at the fruit preparation manufacturing plant and then filled on the aseptic process system. The tote is equipped with an outlet that is used for unloading at the yogurt plant. Because the outlet is stainless steel, it is possible to attach a steam barrier prior to unloading to establish a sterile connection. Because the empty stainless steel totes must be returned to the fruit processor, it is generally not economical to use them when the yogurt manufacturer is located more than 500 miles from the fruit processor.

Twenty four hours after packaging, first preparation samples are evaluated to assure compliance to the product specification prior to release of the product. The following are usually the criteria used for evaluation:

- °Brix (by refractometer)
- pH—Must use a consistent temperature for product testing.
- Viscosity/Consistency—The best method for products containing fruit particulates is a Bostwick consistometer measuring device, where the sample is measured at a specific temperature and time, i.e., 21.1°C (70°F) for 30 seconds. The Bostwick consistometer provides accurate determination of sample consistency by measuring the distance, which a material flows under its own weight during a given time interval and temperature. It consists of a level, stainless-steel trough with two compartments. The first compartment, which holds the sample at a predetermined temperature, is separated from the second compartment by a spring loaded gate. The second compartment is 24 cm long and has graduated parallel lines at 0.5 cm intervals. The measurement is taken by fully filling the first compartment with the sample to be tested, releasing the gate, and letting the fruit preparation flow freely down the slope. The distance that the fruit preparation flows from the gate after 30 seconds is measured in centimeters as the Bostwick reading. A Brookfield viscometer can be used for products without particulates or flavored syrups. Brookfield instruments utilize a principle of rotation viscosity measurement in centipoises. The device consists of a spindle immersed in the fluid sample to sense torque resistance when running at a constant speed.

**Color.** It is usually done visually comparing fruit color in relation to a control sample. Sometimes the fruit is mixed in the finished product to augment the color. Some companies use pantone charts for this evaluation, while other companies might use instruments like colorimeters or spectrophotometers that quantify color by assigning a numerical description as opposed to a qualitative description.

**Organoleptic.** Sensory evaluation is conducted to insure that the product complies with sensory standards.

**Microbiological testing.** Standard Plate count, Yeast & Mold count and Coliform count.

## REFERENCES

- Chandan RC. 1982. Fermented Dairy Products in Prescott and Dunn's Industrial Microbiology, 4th ed. AVI Publ, Westport, CT, pp. 113–184.
- Chandan RC. 2004. Dairy: yogurt. In: P Smith, YH Hui (Eds), Food Processing, Blackwell, Publishing Co., Ames, IA.
- Chandan RC, Shahani KM. 1993. Yogurt. In: YH Hui (Ed), Dairy Science and Technology Handbook, Vol. 2. VCH Publications, New York, pp. 1–56.
- Food and Drug Administration (FDA), 2004. U.S. Department of Health and Human Services. Code of Federal Regulations. Washington DC.
- Hoeffler AC. 2004. Hydrocolloids. Eagen Press, St. Paul, MN, pp. 78–82.
- Marshall RT, Arbuckle WS. 1996. Ice Cream. 5th ed. Chapman and Hall, New York, pp. 91–103.
- Tamime AY, Robinson RK. 1999. Yogurt Science and Technology, 2nd ed. Woodhead Publ, Cambridge, England, and CRC Press, Boca Raton, FL.
- Woodroof JG. 1990. 50 years of fruit and vegetable processing. Food Technology, pp. 92–95.

## ACKNOWLEDGEMENT

We are grateful to Andrew Hoeffler for sharing his expertise on the use of LM pectin for sundae style yogurt. We also appreciate the contribution of Brent Cannell for preparing flow sheet diagrams.



# 10

## Milk and Milk-Based Dairy Ingredients

*Isabelle Sodini and Phillip S. Tong*

- Introduction
- Composition and Specifications
- Performance in Yogurt Formulation
  - Fresh Milk
  - Cream
  - Milk Powders
  - Condensed Milk
  - Buttermilk Powder
  - Milk Protein Concentrates
  - Whey Products
  - Caseinates
- Conclusion
- References

### COMPOSITION AND SPECIFICATIONS

Table 10.1a gives the composition of a wide range of dairy ingredients, which have been and are available and evaluated in yogurt formulations. The impact of these ingredients on the observed properties of yogurt is presented in Performance in Yogurt Formulation section. Broadly speaking, the major differences in the effect of such products on yogurt can be attributed to differences in composition (proximate, ratios of protein to lactose, mineral content, and ratio of casein to whey proteins). However, the physical state of the constituents of these ingredients is also important to their observed behavior in yogurt. This can be related to the ingredients thermal history, morphology, and particle size distribution—particularly in the case of dry dairy ingredients.

Therefore, specifications usually detail the proximate composition, microbiological quality, and aspects of the physical properties of the ingredient. In many cases industry standards (e.g., American Dry Products Institute) are used to facilitate a common language of communication regarding specification. In addition, customer specific standards can be developed to provide additional specifications not covered by various industry standards.

Nonetheless, one key standard that has been commonly used is the whey protein nitrogen index (WPNI). This is a test, which measures the amount of soluble nitrogen in a fixed weight of an ingredient (ADPI, 1990). Although the test is not without its

### INTRODUCTION

Milk is the primary ingredient in fermented milk manufacturing. Historically, fresh milk was concentrated by evaporation (reduction of 1/3) to increase the dry matter before fermentation and coagulation. Now, this practice is limited to rural communities and the standardization of the fat content, protein content, and dry matter in industrial yogurt manufacture is realized by the addition of dairy ingredients (powders or concentrates). Furthermore, high quality, readily available, convenient dairy-based concentrates, and powdered ingredients can be used to replace (partially or totally) fresh milk when it is not available (e.g., recombined milk yogurts). The choice of the dairy ingredients used in yogurt formulation has an impact on yogurt characteristics (acidification, flavor, texture).

**Table 10.1a.** Proximate Composition of Select Dry Dairy Ingredients

Ingredient	Fat	Protein	Lactose	Ash	Moisture
Sweet whey	1–1.5%	11–14.5%	63–75%	8.2–8.6%	3–4.5%
Reduced lactose whey	1–4%	18–24%	52–58%	11–22%	3–4%
Demineralized whey	0.5–1.8%	11–15%	70–80%	1–7%	3–4.5%
Whey protein concentrate 34	5–6%	34–36%	48–52%	6.5–8%	3.5–4.5%
Whey protein concentrate 80	4–8%	80–82%	4–8%	3–4%	3.5–4.5%
Whey protein isolate	0.5–1%	90–92%	0.5–1%	2–3%	4–5%
Nonfat dry milk	0.7–1.5%	34–37%	48–52%	8.2%	3.5–5.5
Milk-protein concentrate	3.0%	65%	22%	6%	4.0%

Source: ADPI Bulletin 916, 1990; Chandan, 1997.

limitations, it continues to be widely utilized to provide a basic “heat classification” of milk powders. Table 10.1b gives the basic classification of these powders based on WPNI.

## PERFORMANCES IN YOGURT FORMULATION

### FRESH MILK

Fresh milk is the major ingredient in yogurt manufacture. Its chemical composition fluctuates depending on various factors as species, breed, and season of the year. This can affect the fermentation, as well as the properties of the yogurts.

### Effect of the Species of Mammals on Yogurt Properties

The gross composition of the milk of different species of mammals used for manufacture of fermented milks is given in Table 10. 2. The dry matter is very different according to the species, from 18.8% for sheep milk to 10.8% for mare’s milk. Carbohydrate content ranges from 4.6% to 6%. They are in excess for fermentation, so their variation does not affect the acidification of the milk. However, naturally present inhibitory substances in milk can affect the rate of acidification. It has been reported that camel milk

exhibits a slower acidification rate than in cow, sheep, or goat milk (Fig.10.1). This could be due to a higher concentration of lysozyme in camel milk as compared to the other milks (El-Agamy, 2000).

The texture and the flavor of the fermented milks are dependent on the protein and fat content, which shows strong differences according to the species. Sheep and buffalo milk exhibit very high fat content, more than 7%; whereas horse milk contains less than 2% fat. Sheep milk has the highest protein content (4.6%), and mare’s milk has the lowest (1.3%). This leads to differences in the quality of the yogurts. For example, a yogurt from sheep or buffalo milk will present a creamy texture and a buttery flavor associated with the high fat content (Aneja, 1991; Anifantakis, 1991). If the milk is not homogenized, a layer of cream will occur in the manufacture of set-type yogurt (Anifantakis, 1991). Yogurt from sheep milk, because of the high protein content, does not require milk fortification (Muir and Tamime, 1993). On the other hand, a yogurt from mare’s milk will have a very thin texture, and the blending with cow or sheep milk, or the addition of caseinates or thickeners, is recommended to afford a convenient texture (Di Cagno et al., 2004). Figure 10.2 illustrates the effect of milk source (cow, sheep, and goat) on yogurt viscosity and syneresis.

Finally, the content of minor components also has an impact on the yogurt flavor. For example, a “goaty”

**Table 10.1b.** Heat Classification of Nonfat Dry Milk

Classification	Whey Protein Nitrogen Index (mg/g)	Solubility	Application
High heat	<1.5	Least	Baked goods, meats confections
Medium heat	1.51–5.99	Average	Ice cream
Low heat	>6.0	Most	Recombined milk dairy products,

Source: ADPI Bulletin no. 916, 1990.

**Table 10.2.** Approximate Average Composition (% w/w) of Milk of Different Species of Mammals Used in Yogurt and Fermented Milk Manufacture

Specie	Dry Matter	Fat	Casein	Whey Protein	Lactose	Ash
Sheep	18.8	7.5	4.6	1	4.6	1
Buffalo	17.5	7.5	3.6	0.7	4.8	0.8
Camel	13.4	4.5	2.7	0.9	4.5	0.8
Goat	13.3	4.5	3	0.6	4.3	0.8
Cow	12.7	3.9	2.6	0.6	4.6	0.7
Horse	10.8	1.7	1.3	1.2	6.0	0.5

Source: After Walstra et al., 1999.

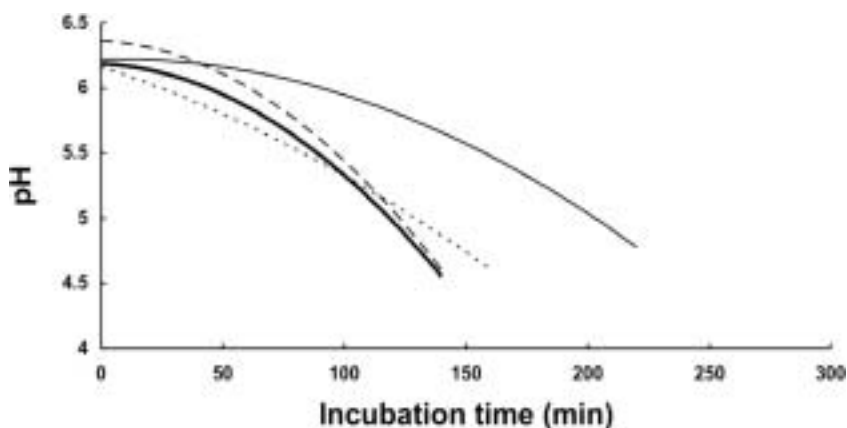

**Figure 10.1.** Effect of milk source on yogurt acidification. —, cow milk; ----, sheep milk; ·····, goat milk; —·—, camel milk. After Jumah et al., 2001.

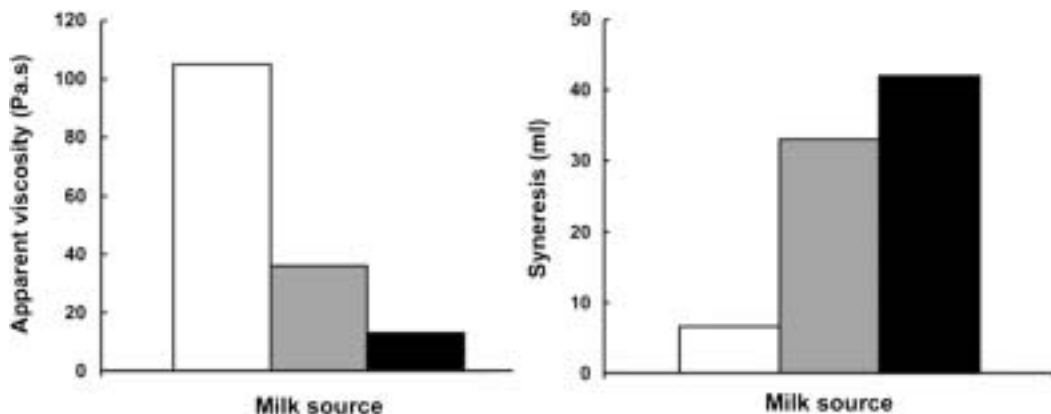

**Figure 10.2.** Effect of milk source on yogurt apparent viscosity (A) and syneresis (B). Yogurt viscosity was measured by Brookfield LV viscometer using spindle n° 3 at 0.6 rpm. Yogurt syneresis was determined by draining 180 mL of yogurt on stretched cheese cloth. □, sheep milk; ▒, cow milk; ■, goat milk. After Kehagias et al., 1986.

flavor noticeable in the yogurt from goat milk, has been associated with a high amount of free fatty acids in goat milk (Abrahamsen and Rysstad, 1991). Acetaldehyde is one of the major aromatic components characteristic of yogurt flavor. It is produced mainly from the conversion of threonine into acetaldehyde and glycine during fermentation. Threonine aldolase is the key enzyme in this conversion. Low amount of acetaldehyde observed in goat milk yogurt has been attributed to high amount of free glycine in goat milk, which causes a feedback inhibition of the threonine aldolase (Rysstad et al., 1990). The addition of threonine to milk has been recommended in the manufacture of yogurt from goat milk (Rysstad et al., 1990), as well as mare's milk (Di Cagno et al., 2004,) in order to improve yogurt flavor.

### Effect of the Breed and Genetic Variant on Yogurt Properties

Table 10.3 shows the gross composition of milk produced by four breeds of cows, Friesian, Holstein, Brown, and Jersey. Fat and protein content varies depending on the breed. This affects the textural properties of the yogurt resulting due to the relationship between protein content in milk and yogurt viscosity (Schkoda et al., 2001b). For example, Allmere et al. (1999) observed a strong difference in elastic modulus for yogurts made with milk from individual cows from two breeding selection lines. An increase of 40% was observed with yogurt made with milk from one selection line as compared to the other. This was correlated to a difference in protein content (3.71% versus 3.37%). Furthermore, an effect of the genetic variants on the physical properties of yogurt has been demonstrated for  $\beta$ -lactoglobulin and  $\kappa$ -casein variants. Allmere et al. (1998) and Bikker et al. (2000) reported higher elastic modulus with milk gels containing  $\beta$ -lactoglobulin B and C than the ones containing  $\beta$ -lactoglobulin A. For instance, Allmere et al. (1998) observed a 30% higher storage modulus in acidified milk gels containing only the B

variant of  $\beta$ -lactoglobulin compared with those containing only the A variant. The use of milk containing  $\kappa$ -casein variant AA or BB does not affect the viscosity or the texture of yogurts (Allmere et al., 1998; Muir et al., 1997). However, Muir et al. (1997) observed that the serum leakage was lower for yogurts made from milk with the  $\kappa$ -casein variant AA than yogurts containing the  $\kappa$ -casein variant BB.

### Effect of the Seasonal Variation in Milk Composition on Yogurt Properties

The composition of milk can vary across the seasons. For instance, approximately a 10% variation in fat and protein is observed in milk received in July and August (lowest level) compared to that received in October and November (highest level) in the United States (Chandan, 1997). These variations of composition are known to affect the consistency and the quality of the manufactured dairy products. Seasonal variation of sheep milk in Scotland has been shown to change viscosity, serum separation, and acidity in yogurts (Muir and Tamime, 1993). Seasonal variation of cow milk in Australia has been reported to affect the viscosity and serum separation in both set and stirred yogurts (Cheng et al., 2002). Standardization of the protein content by addition of milk protein in various forms (powders or concentrates, fractionated or whole milk protein) reduces the effects of milk seasonality in yogurt manufacture.

### CREAM

Yogurt can have a fat content ranging from 0% to 10%, with most common values comprised between 0.5% and 3.5% (Tamime and Robinson, 1999). In the United States, regulations distinguish three types of yogurts: regular yogurts (more than 3.25% milkfat), low-fat yogurts (between 0.5% and 2% milkfat), and non-fat yogurts (less than 0.5% milkfat).

The effect of cream addition on yogurt texture is linked to the integration of the fat globules into the

**Table 10.3.** Approximate Average Composition (% w/w) of Milk of Different Breeds of Cow

Breed	Dry Matter	Fat	Crude Protein	Lactose	Ash
Friesian (in the Netherlands)	13.3	4.4	3.4	4.6	0.75
Holstein (in the US)	12.1	3.4	3.3	4.5	0.75
Brown Swiss	12.9	4.0	3.3	4.7	0.72
Jersey	15.1	5.3	4.0	4.9	0.72

Source: After Walstra et al., 1999.

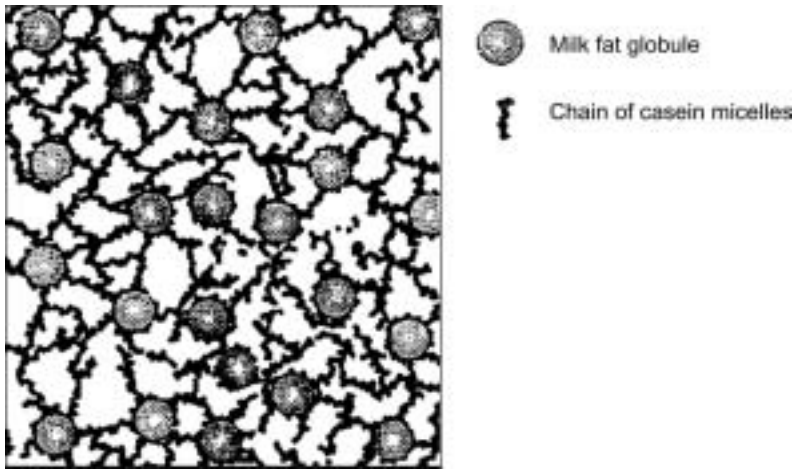

**Figure 10.3.** Simplified structure of full fat yogurt issued from homogenized milk. Note that fat globules are integrated into the gel structure. After Schkoda et al., 2001a.

gel structure. This integration does not occur if the cream is added after the fermentation (Schkoda et al., 2001a), or if the milk is not homogenized (van Vliet and Dentener-Kikkert, 1982). In this case, addition of cream decreases the viscosity of the yogurt, because milk fat globules act as “structure breakers” (Schkoda et al., 2001a; van Vliet and Dentener-Kikkert, 1982). On the other hand, when the cream is added in milk before fermentation, and when milk is then submitted to homogenization before inoculation with starter culture and acidified, which is the usual practice in yogurt manufacture, the addition of milk fat increases the yogurt viscosity and firmness, and decreases the serum separation. For instance, Martens (1972) reported an increase of 44% in the consistency score of stirred yogurt when the fat content varied from 0% to 3.9%. Becker and Puhan (1989) found that gel firmness was increased by 23% in whole milk yogurt (3.5% fats) compared to nonfat yogurt. De Lorenzi et al. (1995) observed a higher (23%) apparent viscosity at  $100 \text{ s}^{-1}$  in full-fat yogurts (4% fat content) as compared to a nonfat yogurt. Finally, Becker and Puhan (1989) observed that yogurts made from whole milk did not show any whey separation, while in 63 nonfat yogurt samples, 15 showed a whey layer on the surface after 14 days of storage.

The effect of cream addition on yogurt physical properties can be explained by the integration of the milk fat globules in the gel network. During homogenization, the native milk fat globule membrane is

removed and a new membrane is formed, which stabilizes the homogenized fat globules. The new layer covering the fat globules is predominantly composed of micellar casein. Cano Ruiz and Richter (1997) determined the percentage distribution of proteins in the milk fat globule membrane of homogenized milk and found a repartition between caseins, whey protein, and proteins from native membrane equal to 67%, 10%, and 13%, respectively. The new layer of the milk fat globules interacts with the casein micelles during acidification (Barrantes et al., 1996; Lucey et al., 1998) and acts as a “structure promoters” in this case (van Vliet and Dentener-Kikkert, 1982), as reported in Figure 10. 3.

## MILK POWDERS

Milk powders can be used to enrich the protein content of the milk before fermentation and increase the viscosity of the yogurts. This allows the standardization of the protein content of the milk and helps to maintain a constant quality of the products. Skim milk powder or whole milk powder can be used. However, it is more common to use skim milk powder, which has no effect on the fat content of the milk base compared to whole milk powder. Hence, the fat content can be entirely controlled by the addition of cream, while the addition of the milk powder allows for adjustment of the protein content.

The level of addition of milk powder determines the viscosity, gel strength, and ability to retain the whey of the yogurt. Several studies have established a positive relationship between the addition of milk powder, and the rheological and physical properties of yogurt (Becker and Puhán, 1989; Harwalkar and Kalab, 1986; Rohm, 1993; Wachter-Rodarte et al., 1993). Rohm (1993) compared the viscosity of yogurts without adding skim milk powder and also with 1%, 2%, and 3% of added skim milk powder. The apparent viscosities measured at  $10 \text{ s}^{-1}$  were respectively, 0.53 Pa.s, 0.65 Pa.s, 0.77 Pa.s, and 0.91 Pa.s, for yogurts prepared with a classical yogurt culture. In this case, a 1%, 2%, and 3% skim milk powder addition allows an increase of viscosity of respectively 22%, 43%, and 70%. In another work, Becker and Puhán (1989) reported an increase in the gel strength of 25% and an increase of viscosity as measured with the posthumus funnel of 15% with an addition of 1% skim milk powder compared to yogurt made without added skim milk powder. Finally, the susceptibility to syneresis has been shown to be decreased with a higher addition of milk powder. Harwalkar and Kalab (1986) reported a percentage of whey drained in a drainage test equal to 31%, 24.5%, 13.5%, and negligible when the total solid content of the yogurt was 10%, 12.5%, 15%, and 20%, respectively.

A low-heat or a medium-heat powder is usually recommended for yogurt fortification (Tamime and Robinson, 1999). However, it has been reported that recombined milk from low-heat skim milk powder gives lactic gels with a lower elastic modulus as compared with lactic gels made from recombined milk from high-heat and medium-heat skim milk powder (50% decrease) (Cho et al., 1999). The reason is probably the difference in the composition of the fat globule surfaces. Fat globules stabilized by high-heat and medium-heat skim milk powder have a higher concentration of denatured whey protein on their surface compared to those stabilized by low-heat skim milk powder. Higher denatured whey proteins provide additional cross-links in the yogurt gel (Cho et al., 1999). The type of the powder also can impact the flavor of the yogurt. It has been demonstrated in yogurts fortified with four different commercial low-heat skim milk powders that there were significant differences of flavor according to the choice of the skim milk powder (Drake, 2004). Among the four milk powders tested, one presented an off-flavor characterized as animal/barny flavor. The acceptability of the yogurt fortified with the defected powder was significantly lower than for the other samples.

## CONDENSED MILK

Fresh liquid condensed skim milk can be used instead of skim milk powder to enrich milk in yogurt manufacture. There is no difference in quality between these two methods of enrichment (Guzman-Gonzalez et al., 1999). The choice between one and the other is dictated by the easiest way for providing the factory between these two ingredients. The incorporation of condensed milk, on a liquid form, into yogurt milk, is easier than the dissolution of skim milk powder. However, it requires specific equipment for storage and blending.

## BUTTERMILK POWDER

Buttermilk powder has been used successfully to replace skim milk powder for milk fortification in yogurt manufacture (Guinée et al., 1995; Trachoo and Mistry, 1998). No significant differences were observed in viscosity and water-holding capacity of low-fat stirred yogurt stabilized with skim milk powder or buttermilk powder at a 5% protein content (Guinée et al., 1995). Trachoo and Mistry (1998) compared the firmness and sensorial properties of nonfat and low-fat set yogurts enriched with skim milk powder and buttermilk powder at a 3.7% and 4.4% protein level, respectively. They reported that for the both types of yogurts, enrichment with buttermilk powder yielded a smoother product as compared to yogurts enriched by addition of skim milk powder. Sensorial score for smoothness were respectively 8.2 and 7.8 for nonfat yogurt, and 8.3 and 6.9 for low-fat yogurt. For the low-fat yogurt, the fortification with buttermilk powder led to a slightly softer product as compared with skim milk powder.

## MILK PROTEIN CONCENTRATES

The replacement of skim milk powder by milk protein concentrates in yogurt manufacture has been studied by Guzman-Gonzalez et al. (1999), Mistry and Hassan (1990), Modler and Kalab (1983a), Modler et al. (1983b), and Rohm (1993). When the protein content of the yogurt is kept the same, the substitution of skim milk powder by milk protein concentrates does not change the firmness (Mistry and Hassan, 1990; Modler et al., 1983b), the viscosity (Guzman-Gonzalez et al., 1999; Rohm, 1993), the syneresis (Modler et al., 1983b), the texture (Mistry and Hassan, 1992), and the flavor of the yogurts (Mistry and Hassan, 1992; Modler et al., 1983b). This

substitution does allow one to two-thirds reduction in the amount of powder required for fortification, because the protein content of milk protein concentrates is between 50% and 85%, as compared to 34–36% protein for a typical skim milk powder.

Another option is to use milk protein concentrate directly as the yogurt milk. Some authors have studied the properties of yogurts produced from ultrafiltered milk at protein levels varying from 3.3% to 11.8% (Becker and Puhan, 1989; Biliaderis et al., 1992; Lankes et al., 1998; Savello and Dargan, 1995). When compared to the yogurts produced from milk fortified with skim milk powder at the same dry matter level, the viscosity and firmness of yogurts produced from ultrafiltered milks are higher because of the higher proportion of the protein in the milk base (Becker and Puhan, 1989; Biliaderis et al., 1992; Lankes et al., 1998). Biliaderis et al. (1992) noticed an increase of elastic modulus from 511 Pa to 1220 Pa between yogurt enriched to 14% dry matter by addition of skim milk powder or by ultrafiltration of skim milk, respectively. The corresponding protein levels were respectively 5.3% and 9.5%. Savello and Dargan (1995) compared yogurts produced from ultrafiltered milk and skim milk powder-fortified milk at a same protein content of 5%. They reported a higher viscosity and higher gel strength (100% and 50% increase, respectively) for the yogurt produced from the ultrafiltered milk. However, no explanation was proposed to explain this phenomenon.

## WHEY PRODUCTS

### Whey Powders

The use of whey powder is limited in yogurt manufacture because it can be associated with some defects in texture, flavor, and appearance when added at a high level. Nonetheless, because it is a relatively inexpensive functional dairy solid, its use has been well-studied.

Shah et al. (1993) studied whey powder to replace skim milk powder in yogurt prepared from reconstituted milk. They reported that it was feasible to manufacture yogurt with reconstituted skim milk and with 25% of whey powder replacing the skim milk powder. Replacement of skim milk powder by 50% with whey powder resulted in lower flavor scores and affected body and texture. González-Martínez et al. (2003) reported a yellowish color developed in yogurt when whey powder was added, and the yellow color intensity was proportional to the amount of whey added.

When whey powder is used to substitute skim milk powder on a dry matter basis, it decreases the firmness of the gel and lowers the viscosity of the yogurt because of the lower protein content of whey powder (6% protein) as compared to skim milk powder (34% protein) (Bhullar et al., 2002; Dave and Shah, 1998). For instance, for a plain set yogurt fortified with 2% powder, whey powder-fortified yogurt was less viscous than skim milk powder-fortified yogurt. The viscosity, as determined with a Brookfield viscosimeter, was respectively 14 Pa.s and 25 Pa.s. However, at the same time, protein level was lower in case of the whey powder-fortified yogurt than in skim milk powder-fortified yogurt, respectively 3.47% and 3.70% protein (Bhullar et al., 2002).

When whey powder is used instead of skim milk powder to fortify protein content of the milk, some defects have been observed (yellow color, increased syneresis) (González-Martínez et al., 2003). However, texture defects are less pronounced, because whey proteins have a texturing effect in yogurt manufacture, where the high heat treatment applied allows their denaturation and their involvement in the building of the protein network. González-Martínez et al. (2003) reported that substitution of skim milk powder by whey powder in a yogurt formulated at 4.2% protein gives a more firm and viscous yogurt, showing better flow properties (more homogeneous fluid, without lumps) than the control. This has to be put in relation with the results of other works involving whey protein concentrates demonstrating higher gel strength when the ratio between casein and whey protein was lowered by the addition of whey protein concentrates (Augustin et al., 2003; Cheng et al., 2000; Greig and Harris, 1983; Modler et al., 1983b; Puvanenthiran et al., 2002; Remeuf et al., 2003). The positive effect of whey protein on the firmness of the network was attributed to the size of the particles constituting the gel network. They are larger in case of addition of whey protein because of the binding of the denatured whey protein on the casein micelles. These larger particles are suspected to absorb more of an applied force by flexing without breaking the intraparticle cross-link bonds. This leads to higher gel strength (Puvanenthiran et al., 2002).

### Whey Protein Concentrates

Whey protein concentrates are very commonly used in yogurt manufacture to replace skim milk powder because it can be less expensive than using the skim milk powder. Furthermore, whey proteins are highly



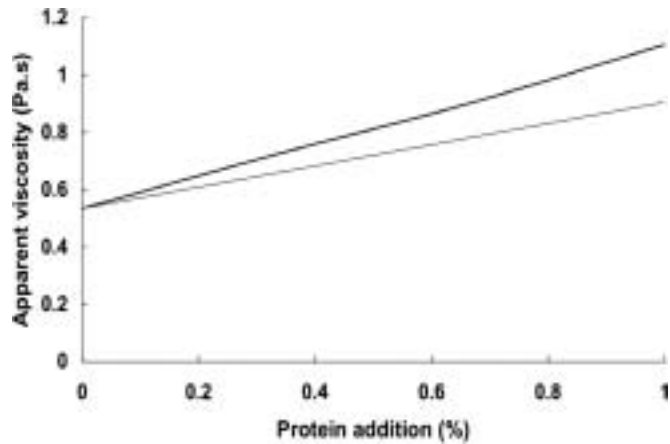

**Figure 10.4.** Effect of source of protein fortification on yogurt apparent viscosity. Apparent viscosity has been calculated at  $10 \text{ s}^{-1}$  using the flow curve parameters. —, addition of skim milk protein; —, addition of Na-caseinate. After Rohm et al., 1993.

functional in yogurts. The substitution of skim milk powder by whey protein concentrates in yogurts usually increases the water-holding capacity of the yogurts and reduces ability to syneresis (Augustin et al., 2003; Cheng et al., 2000; Remeuf et al., 2003). However, at a high level substitution (more than 1% on a protein basis), defects as lack of bright and graininess have been reported (Greig and Harris, 1983; Kailasapathy and Supriadi, 1998; Remeuf et al., 2003).

The results on the texturing effect of whey protein concentrates in yogurt, as compared to skim milk powder, on a constant protein basis, are contradictory in literature. Some report an increase of firmness and viscosity when fortification is done with whey protein concentrates instead of skim milk powder (Augustin et al., 2003; Cheng et al., 2000; Greig and Harris, 1983; Modler et al., 1983b; Puvanenthiran et al., 2002; Remeuf et al., 2003); whereas other researchers report a loss of consistency when whey protein concentrates are used to replace skim milk powder in yogurt formulation (Greig and Harris, 1983; Guinée et al., 1995; Guzman-Gonzalez et al., 1999; Modler et al., 1983b).

For instance, comparing the viscosity of yogurt fortified at a 5% protein level with three different kinds of whey protein concentrates (35–75% protein) or with skim milk powder, Guinée et al. (1995) reported no difference of viscosity at  $116 \text{ s}^{-1}$  for yogurt fortified with skim milk powder or whey protein concentrates at 45%, 60%, and 75% protein (viscosity 0.25–0.28 Pa.s). But a much lower viscosity (0.06 Pa.s) was observed when whey protein concentrate at 35% protein was used to fortify the milk. On the other hand,

Remeuf et al. (2003) observed higher apparent viscosity at  $10 \text{ s}^{-1}$  in yogurt fortified at 4.5% protein level with whey protein concentrates at 84% protein than in yogurt fortified with skim milk powder, respectively 3.5 Pa.s and 2 Pa.s.

This inconsistency between results in literature can be explained by differences between the reports in quality of the whey protein concentrates (Augustin et al., 2003; Guinée et al., 1995; Sodini et al., 2005), level of addition of whey protein concentrates in milk (Greig and Harris, 1983), pH of the milk (Augustin et al., 2003; Vasbinder and De Kruif, 2003), and intensity of the heat treatment applied to the milk (Jelen, 1997).

Whey protein concentrates can also be added in the yogurt after the fermentation and gelation in the case of stirred yogurt manufacture. In this case, it has been shown that any texturing effect is very different. Patocka et al. (2004) reported a strong thinning effect of the addition of whey protein hydrolysate when it was added from 2% to 8% level in a stirred yogurt. The thinning effect was not only due to dilution of the protein matrix, because the addition of sugar decreased the viscosity to a lesser extent.

### Microparticulated Whey Protein

A microparticulation process has been developed by Kelco Ltd to produce microparticulated whey protein ( $1 \mu\text{m}$  average) enhancing the properties of low-fat foods. The commercial name of the product is Simplese®. Some works have demonstrated their ability to improve the consistency of nonfat (Tamime et al., 1984) and low-fat yogurts (Sandoval-Castilla



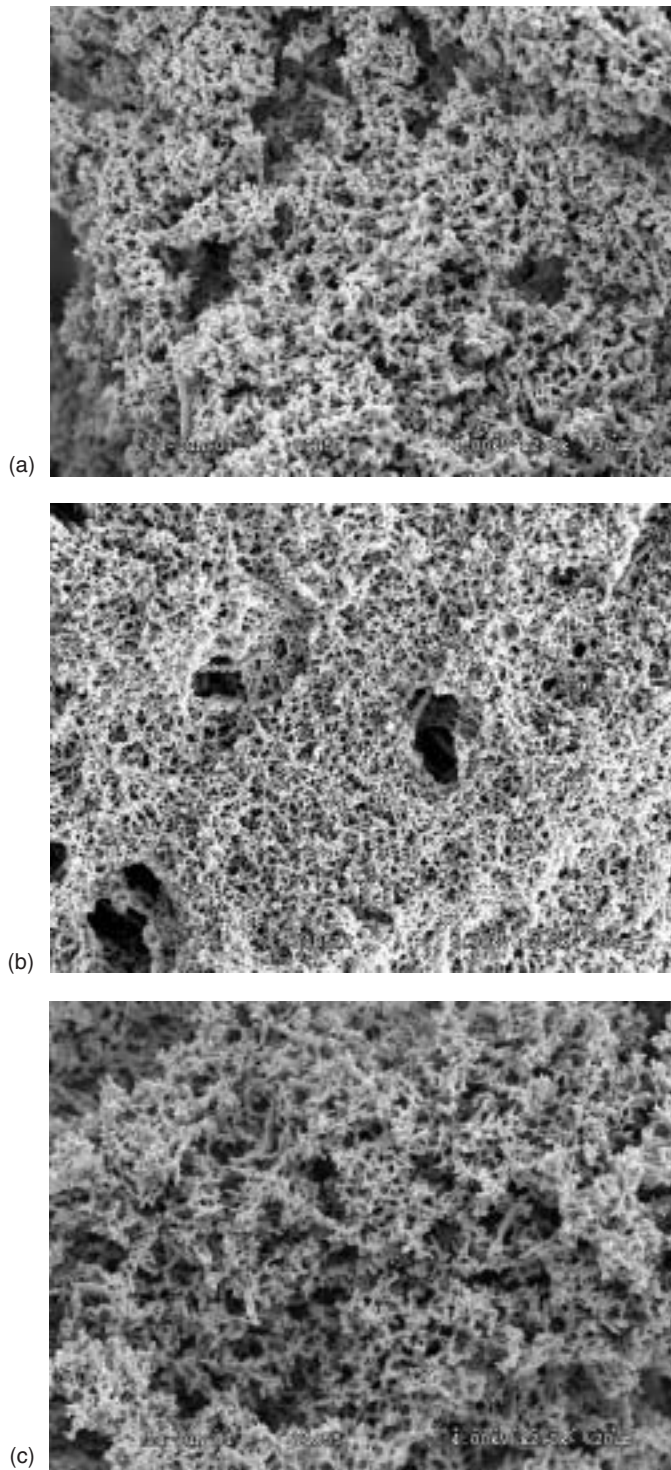

**Figure 10.5.** Microstructure of yogurts obtained from milk base enriched with skim milk powder (a), whey protein concentrates (b), and Na-Caseinate (c). Bar-20  $\mu\text{m}$ . After Remeuf et al., 2003.

et al., 2004). Tamime et al. (1984) and Sandoval-Castilla et al. (2004) showed the particles integrate in the protein matrix of the yogurt; they were found to be a part of the casein micelle chains or spanned adjacent chains. They were not freely dispersed into the aqueous phase, maintaining their corpuscular nature. The microparticulated whey protein seems to limit the casein aggregation in clusters. A low-fat yogurt containing 1% microparticulated whey protein presented the same profile analysis as a full fat yogurt (Sandoval-Castilla et al., 2004).

## CASEINATES

Na, Ca, or Na-Ca-caseinates have been used in yogurt formulation to increase the protein content, alone (Guinée et al., 1995; Guzman-Gonzalez et al., 2000; Modler and Kalab, 1983a; Modler et al., 1983b; Remeuf et al., 2003; Rohm, 1993; Tamime et al., 1984) or in combination with whey protein concentrates (Guzman-Gonzalez et al., 2000; Remeuf et al., 2003) to control the casein/whey protein ratio.

When compared with skim milk powder enrichment, fortification with caseinate gave a more rough and less smooth yogurt texture (Modler et al., 1983b; Remeuf et al., 2003), with a higher gel firmness and viscosity (Guinée et al., 1995; Guzman-Gonzalez et al., 2000; Modler et al., 1983b; Remeuf et al., 2003; Rohm, 1993; Tamime et al., 1984). Figure 10.4 reports the apparent viscosity of yogurts fortified with skim milk powder or Na-caseinate. It has been noticed by some researchers that texturing effect is different between Na- and Ca-caseinates. Higher viscosities were reported for Na-caseinates than Ca-caseinates fortified yogurts (Guzman-Gonzalez et al., 2000; Remeuf et al., 2003). For instance, Remeuf et al. (2003) determined complex viscosities of 40 Pa.s, 55 Pa.s, and 100 Pa.s respectively for yogurts enriched to 4.5% protein with skim milk powder, Ca-caseinate, and Na-caseinate. Guzman-Gonzalez et al. (2000) showed yogurts enriched at 4.3% protein with skim milk powder, Ca-caseinate and Na-caseinate had apparent viscosities of 34 Pa.s, 53 Pa.s, and 63 Pa.s, respectively.

Microstructure studies showed that the structure of the network is different when adding caseinates instead of skim milk, with a more open and loose structure. This difference of structure explains while lower water holding capacity is reported in case of caseinate fortification (Guzman-Gonzalez et al., 2000; Remeuf et al., 2003). Figure 10.5 reports the microstructure of

three yogurts fortified with skim milk powder, whey protein concentrates, and Na-caseinate. Large and extensively fused casein are noticeable in Na-caseinate fortified yogurts (Fig. 10.5c), while a fine network with small pore size is observed in WPC-fortified yogurt (Fig. 10.5b), as compared to SMP-fortified yogurt (Fig. 10.5a). This can be explained by the coverage of casein micelle by denatured whey protein during the heat treatment, which is not the same depending on the casein/whey protein ratio (Puvanenthiran et al., 2002).

## CONCLUSION

There is a wide range of dairy ingredients that can impact the properties of yogurt texture, flavor, and appearance. Continued advances in the technologies for fractionation and purification of milk into these ingredients will offer yogurt manufacturers better tools to manipulate and tailor the properties of yogurt for the desired end use.

## REFERENCES

- ADPI. 1990. American Dairy Products Institute Standards for Milk Powders. Chicago, IL.
- Abrahamsen RK, Rysstad G. 1991. Fermentation of goats' milk with yogurt starter bacteria: A review. *Cultured Dairy Products J.* 26:20–26.
- Allmere T, Akerlind M, Andren A. 1999. Rheological properties of acidified gels of skim milk from cows selected for high or low milk fat concentration. *Int. Dairy J.* 9:703–707.
- Allmere T, Andren A, Lindersson M, Björck L. 1998. Studies on rheological properties of stirred milk gels made from milk with defined genetic variants of kappa-casein and beta-lactoglobulin. *Int. Dairy J.* 8:899–905.
- Aneja RP. 1991. Processing and distribution of buffalo milk. In: *Proceeding of the XXIII International Dairy Congress*, Montreal, Canada. International Dairy Federation, Brussels, Belgium, pp. 383–396.
- Anifantakis, E. M. 1991. Manufacture of sheep's milk products. In: *Proceeding of the XXIII International Dairy Congress*, Montreal, Canada. International Dairy Federation, Brussels, Belgium, pp. 420–432.
- Augustin MA, Cheng LJ, Glagovskaia O, Clarke PT, Lawrence A. 2003. Use of blends of skim milk and sweet whey protein concentrates in reconstituted yogurt. *Aust. J. Dairy Technol.* 58:30–35.
- Barrantes E, Tamime AY, Sword AM, Muir DD, Kalab M. 1996. The manufacture of set-type natural

- yoghurt containing different oils – 2. Rheological properties and microstructure. *Int. Dairy J.* 6:827–837.
- Becker T, Puhán Z. 1989. Effect of different processes to increase the milk solids non fat content on the rheological properties of yoghurt. *Milchwissenschaft.* 44:626–629.
- Bhullar YS, Uddin MA, Shah NP. 2002. Effects of ingredients supplementation on textural characteristics and microstructure of yoghurt. *Milchwissenschaft.* 57:328–332.
- Bikker JF, Anema SG, Li Y, Hill JP. 2000. Rheological properties of acid gels prepared from heated milk fortified with whey protein mixtures containing the A, B and C variants of beta-lactoglobulin. *Int. Dairy J.* 10:723–732.
- Biliaderis CG, Khan MM, Blank G. 1992. Rheological and sensory properties of yogurt from skim milk and ultrafiltered retentates. *Int. Dairy J.* 2:311–323.
- Cano Ruiz ME, Richter RL. 1997. Effect of homogenization pressure on the milk fat globule membrane proteins. *J. Dairy Sci.* 80:2732–2739.
- Chandan R. 1997. Dairy-based ingredients. Eagan Press, Saint-Paul, MN.
- Cheng LJ, Augustin MA, Clarke PT. 2000. Yogurts from skim milk – whey protein concentrate blends. *Aust. J. Dairy Technol.* 55:110.
- Cheng LJ, Clarke PT, Augustin MA. 2002. Seasonal variation in yogurt properties. *Aust. J. Dairy Technol.* 57:187–191.
- Cho YH, Lucey JA, Singh H. 1999. Rheological properties of acid milk gels as affected by the nature of the fat globule surface material and heat treatment of milk. *Int. Dairy J.* 9:537–545.
- Dave RI, Shah NP. 1998. The influence of ingredient supplementation on the textural characteristics of yogurt. *Aust. J. Dairy Technol.* 53:180–184.
- De Lorenzi L, Pricl S, Torriano G. 1995. Rheological behaviour of low-fat and full-fat stirred yoghurt. *Int. Dairy Journal.* 5:661–671.
- Di Cagno R, Tamborrino A, Gallo G, Leone C, Angelis MD, Faccia M, Amirante P, Gobbetti M. 2004. Uses of mares' milk in manufacture of fermented milks. *Int. Dairy J.* 14:767–775.
- Drake MA. 2004. Flavor of dried dairy ingredients. In: *Proceeding of the 4th International Symposium on Recombined Milk and Milk Products*, Cancun, Mexico. U.S. Dairy Export Council, Arlington, VA.
- El-Agamy EI. 2000. Effect of heat treatment on camel milk proteins with respect to antimicrobial factors: a comparison with cows' and buffalo milk proteins. *Food Chemistry.* 68:227–232.
- González-Martínez C, Cháfer M, Albors A, Carot JM, Chiralt, A. 2003. Influence of substituting milk powder for whey powder on yoghurt quality. *Trends in Food Sci. & Technol.* 13:334–340.
- Greig RIW, Harris AJ. 1983. Use of whey protein concentrate in yogurt. *Dairy Industries Int.* 48:17–19.
- Guinée TP, Mullins CG, Reville WJ, Cotter MP. 1995. Physical properties of stirred-curd unsweetened yoghurts stabilised with different dairy ingredients. *Milchwissenschaft.* 50:196–200.
- Guzman-Gonzalez M, Morais F, Amigo L. 2000. Influence of skimmed milk concentrate replacement by dry dairy products in a low-fat set-type yoghurt model system. Use of caseinates, co-precipitate and blended dairy powders. *J. Sci. Food and Agric.* 80:433–438.
- Guzman-Gonzalez M, Morais F, Ramos M, Amigo L. 1999. Influence of skimmed milk concentrate replacement by dry dairy products in a low fat set-type yoghurt model system. I: Use of whey protein concentrates, milk protein concentrates and skimmed milk powder. *J. Sci. Food and Agri.* 79:1117–1122.
- Harwalkar VR, Kalab M. 1986. Relationship between microstructure and susceptibility to syneresis in yoghurt made from reconstituted nonfat dry milk. *Food Microstructure.* 5:287–294.
- Jelen P. 1997. Texture of fermented milk products and dairy desserts. *Trends in Food Sci. & Technol.* 8:345–347.
- Jumah RY, Shaker RR, Abu-Jdayil B. 2001. Effect of milk source on the rheological properties of yogurt during the gelation process. *International Journal of Dairy Technology.* 54:89–93.
- Kailasapathy K, Supriadi D. 1998. Effect of partially replacing skim milk powder with whey protein concentrate on the sensory qualities of lactose hydrolysed acidophilus yoghurt. *Milchwissenschaft.* 53:385–389.
- Kehagias C, Komiotis A, Koulouris S, Koroni H, Kazazis J. 1986. Physico-chemical properties of set type yogurt made from cow's, ewe's and goat's milk. *Bull. Int. Dairy Fed.* 202:167–169.
- Lankes H, Ozer HB, Robinson RK. 1998. The effect of elevated milk solids and incubation temperature on the physical properties of natural yoghurt. *Milchwissenschaft Milk Sci. Int.* 53:510–513.
- Lucey JA, Munro PA, Singh H. 1998. Rheological properties and microstructure of acid milk gels as affected by fat content and heat treatment. *J. Food Sci.* 63:660–664.
- Martens R. 1972. Influence de quelques facteurs sur la consistance et le goût du yoghurt brassé. *Revue de l'agriculture.* 3:461–480.

- Mistry VV, Hassan HN. 1990. Manufacture of low fat yogurt using a high protein powder. In: Proceeding of the XXIII International Dairy Congress, Montreal, Canada. International Dairy Federation, Brussels, Belgium, p. 518.
- Mistry VV, Hassan HN. 1992. Manufacture of nonfat yogurt from a high milk protein powder. *J. Dairy Sci.* 75:947–957.
- Modler HW, Kalab M. 1983a. Microstructure of yogurt stabilized with milk proteins. *J. Dairy Sci.* 66:430–437.
- Modler, HW, Larmond ME, Lin CS, Froelich D, Emmons DB. 1983b. Physical and sensory properties of yogurt stabilized with milk proteins. *J. Dairy Sci.* 66:422–429.
- Muir DD, Horne DS, West IG. 1997. Genetic polymorphism of bovine kappa-casein: Effects on textural properties and acceptability of plain, set yoghurt. In: Proceeding of the IDF Seminar on Milk Protein Polymorphism, Palmerston North, New Zealand. International Dairy Federation, Brussels, Belgium, pp. 182–184
- Muir DD, Tamime AY. 1993. Ovine milk. 3. Effect of seasonal variations on properties of set and stirred yogurts. *Milchwissenschaft.* 48:509–513.
- Patocka G, Cervenkova R, Jelen P. 2004. Textural effects of soluble whey protein isolate in stirred yogurt. *Milchwissenschaft.* 59:37–40.
- Puvanenthiran A, Williams RPW, Augustin MA. 2002. Structure and visco-elastic properties of set yoghurt with altered casein to whey protein ratios. *Int. Dairy J.* 12:383–391.
- Remeuf F, Mohammed S, Sodini I, Tissier JP. 2003. Preliminary observations on the effects of milk fortification and heating on microstructure and physical properties of stirred yogurt. *Int. Dairy J.* 13:773–782.
- Rohm H. 1993. Influence of dry matter fortification on flow properties of yogurt. 2. Time-dependent behaviour. *Milchwissenschaft.* 48:614–617.
- Rysstad G, Knutsen WJ, Abrahamsen RK. 1990. Effect of threonine and glycine on acetaldehyde formation in goats' milk yogurt. *J. Dairy Res.* 57:401–411.
- Sandoval-Castilla O, Lobato-Calleros C, Aguirre-Mandujano E, Vernon-Carter EJ. 2004. Microstructure and texture of yogurt as influenced by fat replacers. *Int. Dairy J.* 14:151–159.
- Savello PA, Dargan RA. 1995. Improved yogurt physical properties using ultrafiltration and very-high temperature heating. *Milchwissenschaft.* 50:86–89.
- Schkoda P, Hechler A, Hinrichs J. 2001a. Improved texture of stirred fermented milk by integrating fat globules into the gel structure. *Milchwissenschaft.* 56:85–89.
- Schkoda P, Hechler A, Hinrichs J. 2001b. Influence of the protein content on structural characteristics of stirred fermented milk. *Milchwissenschaft.* 56:19–22.
- Shah NP, Spurgeon KR, Gilmore TM. 1993. Use of dry whey and lactose hydrolysis in yogurt bases. *Milchwissenschaft.* 48:494–498.
- Sodini I, Montella J, Tong PS. 2005. Physical properties of yogurt with various commercial whey protein concentrates. *J. Sci. Food Agric.* 85:853–859.
- Tamime AY, Kalab M, Davies G. 1984. Microstructure of set-style yoghurt manufacture from cow's milk fortified by various methods. *Food Microstructure.* 3:83–92.
- Tamime AY, Robinson RK. 1999. *Yoghurt : Science and Technology*, 2nd ed. Woodhead Publishing Limited, Cambridge, England, UK.
- Trachoo N, Mistry VV. 1998. Application of ultrafiltered sweet buttermilk and sweet buttermilk powder in the manufacture of nonfat and low fat yogurts. *J. Dairy Sci.* 81:3163–3171.
- van Vliet T, Dentener-Kikkert A. 1982. Influence of the composition of the milk fat globule membrane on the rheological properties of acid milk gels. *Netherlands Milk and Dairy J.* 36:261–265.
- Vasbinder AJ, De Kruif CG. 2003. Casein-whey protein interactions in heated milk: the influence of pH. *Int. Dairy J.* 13:669–677.
- Wacher-Rodarte C, Galvan MV, Farres A, Gallardo F, Marshall VME, Garcia-Garibay M. 1993. Yoghurt production from reconstituted skim milk using different polymer and non polymer forming starter cultures. *J. Dairy Res.* 60:247–254.
- Walstra P, Geurts TJ, Noomen A, Jellema A., van Boekel MAJS. 1999. *Dairy technology, principles of milk properties and processes.* Marcel Dekker, New York, NJ, pp. 15–16.

# 11

## Ingredients for Yogurt Manufacture

*Ramesh C. Chandan and Kevin R. O'Rell*

### Dairy Ingredients and Their Origin

Condensed Skim Milk

Nonfat Dry Milk

Whey Solids

Milk Protein Concentrate (MPC) (or Ultrafiltered Milk)

Sweeteners

Stabilizers

Native and Modified Starch

Gums and Pectins

### References

Previous chapters have offered valuable information on the quality attributes, including chemical and microbiological characteristics and specifications, of the raw materials used to formulate yogurt mixes. The manufacture of yogurt starts with a judicious selection of raw materials, accurate formulation, and processing of yogurt mix.

### DAIRY INGREDIENTS AND THEIR ORIGIN

Various dairy raw materials for formulating yogurt mixes consist of fresh milk, skim milk, cream, condensed milk, and nonfat dry milk. In the United States, Yogurt is a Grade A product (United States Department of Health and Human Services, 1999). Chapter 3 details the requirements for milk production, transportation, and processing. Grade A implies that all dairy components used must come from The Food and Drug Administration (FDA) supervised Grade A dairy farms and Grade A manufacturing plants, as per regulations enunciated in Pasteurized Milk Ordinance. The basic raw material is milk. It is emphasized that all dairy raw materials should be

selected for high bacteriological quality for securing best flavor potential in yogurt. Milk should come from healthy cows that are fed wholesome feed and kept in clean surroundings. The flavor, consistency, and acid production is adversely affected by using milk from cows with infected udders (mastitis), general sickness, or in early or late stages of lactation, including milk containing high bacterial count, abnormal somatic cell count, and antibiotics, disinfectants or sanitizers. This is related to the fact that growth of yogurt culture is affected adversely in milk partially fermented by contaminating organisms and in milk containing high somatic cells, or antibiotics and sanitizing chemical residues. Therefore, such milk cannot be used for yogurt production. For the most part, in bulk milk, the adverse effects of the quality of milk from a single cow or a small herd of cows can be balanced through dilution. Chapter 10 contains detailed information related to dairy ingredients used in yogurt manufacture.

The major concern in milk for yogurt production is the bacterial quality which is discussed in detail elsewhere (Chandan, 1982, 1997, 2004; Chandan and Shahani, 1993, 1995; Tamime and Robinson, 1999) and the presence of inhibitors. The inhibitory action of antibiotics against lactic cultures has been responsible for production losses in the manufacture of cultured products. One of the two organisms in yogurt culture, *Streptococcus thermophilus* is particularly sensitive to antibiotics (0.01–0.05 IU/ml of penicillin). Regular testing for antibiotics in milk in the plant laboratory and other measures connected with the use of antimastitis drugs on the farm represent a good system for controlling these residues.

In addition to antibiotics, residual disinfectants and sanitizing chemicals may inhibit the growth of starter

cultures. Chlorine compounds such as hypochlorites and iodophors may partially inhibit starter cultures at a level of 6 mg/l to 10 mg/l of milk. Normal precautions regarding their use on the farm should greatly reduce the chance of obtaining residual levels affecting yogurt cultures. On the other hand, quaternary ammonia compounds inhibit lactic acid bacteria at concentrations as low as 0.1–1.0 mg/l, depending on particular strain sensitivity. On the farm, these compounds should be used with great caution and their use followed by thorough drainage and rinsing with clean water. Preferably, these compounds should be avoided in plants manufacturing yogurt and cultured dairy products.

The microbiological quality of milk for yogurt should contain a low bacterial count, coliform count, and mold and yeast count. Standard Plate count and coliform tests should be performed on each load of milk to be used for yogurt production. A yeast and mold test should be done on a random basis. Although coliform, yeast, and mold are readily destroyed by pasteurization, their presence along with significant number of bacteria is an indication that the milk was handled in unclean equipment, or held under warm conditions. When milk comes into contact with unclean surroundings, it is very possible that it has become contaminated with thermophilic/thermophilic organisms, which are capable of withstanding destruction at pasteurization temperatures. If present, these bacteria will grow rapidly during the incubation period of yogurt fermentation and compete with the yogurt culture. This would result in slow fermentation time and/or weak body of the yogurt. The formation of pin-point colonies on Standard Plate

count plates incubated at 32–35°C is an indication of thermophilic organisms, since they grow better at 40–45°C.

Also, if the milk has been contaminated with a high number of bacteria, it is possible that these bacteria might be psychrophiles or psychrotrophs. These organisms grow well in cold conditions. They grow slowly in milk held at 3°C, but the growth may be rapid as the temperature rises to 10°C or higher. Although psychrophiles are readily destroyed by pasteurization temperature, if allowed to grow in significant numbers, they can produce heat-stable proteolytic enzymes, which would degrade the protein. This protein degradation results in slow, weak sets, and possible off-flavors. There is a procedure for detecting psychrophilic organisms outlined in the Standard Methods for Analysis of Dairy Products (American Public Health Association). However, a quicker modified version can be performed by incubating pour plates at 21°C for 25 hours.

The procurement of all ingredients should be done on the basis of specifications and standards, which are checked and maintained with a systematic sampling and testing program by the quality control laboratory.

Yogurt mix composition regarding milk fat and milk solids nonfat is generally standardized from whole, partially defatted milk, condensed skim milk, cream, and/or nonfat dry milk. The chemical composition of dairy ingredients commonly used in yogurt manufacture is given in Table 11.1. Formulating yogurt mix to desired fat and milk solids-not-fat by the use of these ingredients can be easily accomplished by appropriate software programs.

**Table 11.1.** Typical Chemical Composition of Dairy Ingredients Used in Formulating Yogurt Mix

Ingredient	%Total Solids	%Fat	%Protein	%Lactose	%Ash
Whole milk	12.6	3.8	3.2	4.9	0.7
Skim milk	9.1	0.1	3.3	5.1	0.7
Whipping cream	42.7	36.8	2.2	3.2	0.5
Condensed skim milk	40.1	0.4	14.4	22.3	3.0
Nonfat dry milk	96.5	0.8	35.9	52.3	8.0
WPC <sup>a</sup> -34	96.5	4.0	34.5	51.0	7.0
WPC-50	96.5	4.0	50.5	36.0	6.0
WPC-80	96.5	6.0	80.5	5.0	5.0
Whey protein isolate	96.5	0.5	93.0	1.0	2.0
Fluid UF milk	25–30	11–14	10–12	<5	>2.5
Fluid UF skim milk	15–20	<0.5	10–12	<5	>2.5
Fluid UF skim milk, with diafiltration	18–20	<0.5	16–17	<1	>1.5

Adapted from Chandan, 1997.

<sup>a</sup> Whey Protein Concentrate



The current FDA specification calls for a minimum of 8.25% nonfat milk solids (SNF) in the fermented mix prior to fruit or flavor addition. In a typical nonfat, low fat, or full fat yogurt formulation, the total milk serum solids (or solids-not-fat) content of yogurt mix ranges from 8.25% to 12%, depending on the choice of stabilization. The serum solids associated with the fluid portion of milk is usually 8.8–9%. Additional nonfat dry milk (NFDM) solids are added to the yogurt mix to build up the total solids and to increase the protein content. In late spring and summer months, the protein content of milk is about 10% lower than the rest of the year. Consequently, the viscosity of yogurt declines during this period unless additional nonfat solids are added to compensate for the seasonal dip in protein content. Therefore, depending on the stabilization system, additional 0.5–1.0% nonfat solids may be needed to maintain the consistent viscosity of the finished product during late spring and summer months.

In general, the level of added NFDM will vary, depending on the desired mouth feel of the finished product, the processing conditions, the fat content, the culture, and type of stabilizer used, if any. Generally, the addition of 2–4% NFDM solids raises the protein level sufficiently so that with the proper heat treatment, there is an increase in bound water leading to improved firmness and consistency of the coagulum. Another benefit is the control of wheying-off or syneresis on the surface of yogurt. Thus, the consistency of yogurt is dependent on the nonfat solids portion, as well as the use of appropriate stabilizers and heat treatment of the mix. Generally, the added NFDM solids will contribute to heavier mouth feel, which cannot be achieved with stabilizers alone. Higher nonfat solids will also provide additional buffering capacity to the mix, which in comparison with a mix containing lower nonfat solids would lead to higher lactic acid content when the fermentation end point of the mix is determined by the same pH. Therefore, the higher nonfat solids mix will result in comparatively sourer tasting yogurt. In commercial practice in North America, supplementation of milk solids-not-fat with some solids from condensed skim milk or nonfat dry milk and/or whey protein concentrate is the most common procedure.

Removal of a significant portion of water from milk yields a series of dairy ingredients (Chandan, 1997). Details are given in Chapter 10. Consequently, these ingredients offer tangible savings in costs associated with storage capacity, handling, packaging, and transportation. A concentrated dairy ingredient used

in large yogurt manufacturing plants is condensed skim milk.

### CONDENSED SKIM MILK

Condensed skim milk process begins with liquid raw whole milk, which is stored at the processing plant at temperatures below 7°C. Raw whole milk has a variable fat content and is separated into cream and the nonfat milk using a centrifugal separator. This separation step facilitates standardization of the fat content prior to further processing. Centrifugal separators used also serve to further clarify the milk. The skim milk is pasteurized (high-temperature, short-time) by heating to at least 71.7°C, and holding at or above this temperature for at least 15 seconds. In its production, the original skim milk volume is reduced to about one-third to yield about 35–40% solids in the final product using energy efficient multieffect evaporators that operate in high vacuum condition to boil off water at moderate temperatures of 46–55°C. The condensed milk is continuously separated from water vapor to achieve a desirable concentration of milk solids. It is cooled to 4°C or below and pumped to insulated trucks for transportation to yogurt plants. The cream produced from the separator is HTST pasteurized, cooled, and transferred to cream storage tanks for use as a manufacturing ingredient.

### NONFAT DRY MILK

Nonfat dry milk is made from condensed skim milk. Spray drying involves atomizing condensed milk into a hot air stream at 180–200°C. The atomizer may be either a pressure nozzle or a centrifugal disc. By controlling the size of the droplets, the air temperature, and the airflow, it is possible to evaporate almost all the moisture while exposing the solids to relatively low temperatures. Spray drying yields concentrated and dry milk ingredients with excellent solubility, flavor, and color. This is the most common procedure for manufacturing concentrated and dry milk ingredients.

The spray drying process is typically a two-stage process that involves a spray dryer at the first stage with a static fluid bed integrated in the base of the drying chamber. The second stage is an external vibrating fluid bed. The product is moved through the two-stage process quickly to prevent overheating of the powder. The powder leaves the dryer and enters a system of cyclones that simultaneously cools it.

Heat treatment affects the functional properties of NFDM, so the temperature and time combinations

**Table 11.2.** Approximate Composition of Grade A Nonfat Dry Milk

Constituents	Amount	Typical Range
Protein (N × 6.38)%	36.0	34.0–37.0
Lactose (Milk sugar)%	51.0	49.0–52.0
Fat%	0.7	0.6–1.25
Moisture%	3.0	3.0–6.0
Minerals (Ash)%	8.2	8.2–8.6

Source: American Dry Milk Products Institute, with permission.

can vary widely depending on the required properties. The milk heat treatment determines the kind of powder produced. For nonfat dry milk produced by a “low-heat” method, the milk is simply pasteurized and no preheating is done. However, heat treatment for a “high-heat” method requires heating milk to 85–88°C for 15 to 30 minutes in addition to pasteurization. Heat treatment in between pasteurization and “high-heat” treatment yields “medium-heat” powder. Tables 11.2, 11.3, and 11.4 contain information on the characteristics of nonfat dry milk, which are important from yogurt formulation standpoint.

Typical composition of nonfat dry milk is shown in Table 11.2. The standards for extra-grade spray-dried nonfat dry milk are given in 11.3. The requirements for low-heat nonfat dry milk are shown in Table 11.4.

The extent of heat treatment can be measured by the whey protein nitrogen index, which measures the amount of undenatured whey protein. For use in yogurt, only low-heat (WPN ≥ 6.0 mg/g) NFDM is used.

**Table 11.3.** Standards for Extra Grade Spray Dried Nonfat Dry Milk

Parameter	Not Greater Than
Milkfat	1.25%
Moisture	4.0%
Titratable acidity	0.15%
Solubility index	1.25 ml <sup>a</sup>
Bacterial estimate	10,000 cfu per g
Scorched particles	Disc B (15.0 mg)

<sup>a</sup> Except product designated as “high-heat” which shall not be greater than 2.0 ml.

Note: Extra Grade nonfat dry milk shall be entirely free from lumps, except those that break up readily under slight pressure. The reliquefied product shall have a sweet and desirable flavor, but may possess the following flavors to a slight degree: chalky, cooked, feed, and flat.

Source: American Dry Milk Products Institute, with permission.

## WHEY SOLIDS

The addition of whey solids in the form of sweet whey or acid whey to replace NFDM in yogurt should be avoided. Whey solids will contribute to the total solids content of yogurt mix; however, because of lower protein content (13–15%) for whey solids as compared to 35–36% for NFDM solids, and lower protein functionality in terms of water binding capacity, the addition of whey solids can be detrimental to the consistency and firmness of the body of yogurt.

On the other hand, whey protein concentrates (WPC), in relatively undenatured form, furnish excellent water binding properties and are a useful functional protein source in yogurt mix. Whey-protein concentrates are products derived from cheese whey by removal of minerals and lactose. The process of protein concentration utilizes membrane filtration (ultrafiltration), which uses a semipermeable membrane of appropriate pore size to retain large protein molecules while letting small molecules consisting of water, lactose, minerals, small peptides, and amino acids to selectively go into the permeate. On a dry basis, the WPC contains 34%, 50%, or 80% protein, and whey protein isolate contains at least 92% protein. In addition, WPC-80 is available as gel type, which is designed to generate more viscosity in liquid foods. WPC-34 is commonly used in yogurt formulation, while WPC-50 is occasionally used. Since Whey protein isolate and WPC-80 contain low levels of lactose, they are important ingredients in the formulation of “low-carb” yogurt. The use of WPC-34 allows the yogurt processor to reduce the ingredient cost and at the same time provides unique functional properties including desirable nutrients, namely, high quality whey proteins and calcium. Since yogurt is classified as a Grade A product in the United States, only Grade A whey-protein concentrate produced in a Grade A cheese plant can be used. WPC helps in heat-set gelation. Whey protein gets denatured by the heat treatment used in yogurt mix preparation. The denatured protein has desirable water binding and adhesion characteristics. In addition, as a dairy product, it has a favorable image because of a clean label. WPC should be free of bixin or β-carotene colorant generally used in Cheddar cheese manufacture. To remove the colorant, the whey is bleached with benzoyl peroxide during the WPC process. Cheese plants manufacturing Swiss and mozzarella cheese use no colorants, but do use thermophilic cultures identical to those used in yogurt production. Accordingly, there



**Table 11.4.** Heat–Treatment Classification of Nonfat Dry Milk

Classification	Processing Treatment	Undenatured Whey-Protein Nitrogen <sup>a</sup> (mg/g)
Low heat	Cumulative heat treatment of milk not over 71.1°C (160°F) for 2 minutes	Over 6.0
Medium heat	Preheat to 71.1°C–79.4°C (160°–175°F) for 20 minutes	1.51–5.99
High heat	Preheat to 87.8°C (190°F) for 30 minutes	Under 1.5

*Adapted from:* American Dry Milk Products Institute, with permission. Chandan 1997.

<sup>a</sup> Higher temperatures and/or extended holding times contribute directly to whey protein denaturation. This index is used as a measure of the cumulative heat effects during processing.

is a possibility of phage carryover from such cheese manufacturing plants to yogurt production. To avoid phage contamination, WPC ingredient should come from cheese plants, where only mesophilic cultures are used, (e.g., Cheddar or Cheddar-type varieties.)

In general, whey proteins of WPC lack opacity and white appearance as compared to caseins present in NFDM. However, whey proteins have fewer tendencies to mask flavor in yogurt than caseins. Accordingly, more fruit flavor will be perceived in fruit flavored yogurt when skim milk solids are partially replaced with WPC. In general, WPC (with 34% protein level) concentration in yogurt mix ranges from 0.5% to 1% level. In yogurt beverage, a higher amount up to 6% may be used.

### MILK PROTEIN CONCENTRATE (MPC) (OR ULTRAFILTERED MILK)

Milk protein concentrate obtained by ultrafiltration of skim milk is a functional ingredient to raise protein level of the mix, but the main reason for its use is to reduce lactose content of the mix to produce “low-carb” yogurt. As yogurt is a Grade A product in the United States, the MPC must be derived from a Grade A process. The labeling for this ingredient is “ultrafiltered skim milk.” It contains 80–85% water, 10–12% protein, <0.5% fat, <5% lactose, and >2.5% ash.

In the formulation of yogurt, the lactose level can be reduced significantly, as much as 70%, by judicious use of lactose-reduced MPC and high-protein WPC in the formulation, replacing milk and NFDM. To conform to the legislation in certain countries or to satisfy the consumer demand, yogurt with no stabilizers can be produced. In such products, the consistency and stability of texture are accomplished by addition of nonfat dry milk, condensed skim milk, and/or whey protein concentrates. In rare practice,

milk may be partly concentrated by removal of 15–20% water in a vacuum pan. In such a specialty yogurt, the mix is formulated to contain high nonfat solids as much as 12% to provide a desirable body and texture and freedom from syneresis.

Since yogurt is a manufactured product, its chemical composition is likely to vary depending on the quality standards established by marketing considerations. Nonetheless, it is extremely important to standardize and control the day-to-day product to meet the consumer expectations and regulatory obligations associated with a certain brand or label. The mix is formulated to predetermined milk fat and milk solids-not-fat content and the weights of each ingredient are calculated with the aid of computer software. Most yogurt plants are equipped with computer programs to calculate the amount of each ingredient needed to achieve target levels of milk fat, milk SNF, total solids, sugar, stabilizers, and other ingredients. The program usually also calculates the cost of the mix.

The level of milk fat found in commercial samples of yogurt ranges from 0.05% to 3.60%. Generally, consumers view milk fat negatively from the caloric standpoint. Consequently, 90% of the refrigerated cup yogurt sold in the United States today is either low fat or nonfat. The fat level in yogurt has a favorable effect on texture quality of the yogurt. Milk fat also has a masking effect on the perception of yogurt acidity. It has been observed that nonfat yogurt (<0.5% fat) tastes more acidic and less mild than the same pH yogurt with a fat content of >1.5%. Therefore, it is important to use a “mild” yogurt culture in nonfat and 1% low-fat yogurt to maintain the finished pH above 4.2 to please today’s consumer tastes. It has also been concluded that milk fat stabilizes the contraction of the protein gel formed after fermentation of the yogurt mix and hinders whey separation. Thus,

in yogurt with little or no stabilizer, a low fat content in milk encourages whey separation, while a high fat content prevents the separation. As the fat content is increased, there is a significant improvement in flavor, viscosity, and taste. However, there is also an increase in the caloric value. In most low-fat and nonfat yogurts produced today, stabilizers are used to compensate for the loss of the stabilizing effect of milk fat. For products produced in the United States, the milk fat levels are standardized to a minimum of 3.25% before the addition of bulky flavors for full-fat yogurt. Low-fat yogurt is manufactured from the mix containing not less than 0.5%, nor more than 2.00% milk fat before the addition of bulky flavors. Nonfat yogurt mix has milk fat level not exceeding 0.5%. These fat levels correspond to the Food & Drug Administration requirement for nutritional labeling of nonfat yogurt, low-fat yogurt and yogurt. (Chandan, 1997, 2004).

## SWEETENERS

### Nutritive Sweeteners

In the manufacture of flavored yogurt, it is usually desirable to add a sweetening agent to the yogurt base. The standard of identity for yogurt, low-fat yogurt and nonfat yogurt (FDA CFR Parts 131.200 to 206) specifies the allowable nutritive sweeteners that can be used. The level of sweetness in the yogurt mix will depend on the Brix of the fruit or flavoring ingredient and the desired level of sweetness in the finished product. Most fruit-flavored yogurts contain approximately 10–13% sugar equivalent, whereas flavored yogurts (vanilla, lemon, coffee etc.) contain 8–10% sugar. The sweetener most commonly used in the industry is sucrose in either liquid (65–67% total solids) or granulated form. When liquid sugar is used, the added water is taken into consideration to avoid dilution of the total solids of the mix. The total amount of sugar solids in yogurt mix should not exceed 10–11% because of the inhibitory effect on the traditional yogurt culture. Depending on the culture, some inhibitory effect will be seen with sugar solids content between 7% and 10%. The addition of the sugar generally occurs before pasteurization due to following reasons:

- Heat treatment of the milk destroys any osmophilic yeasts and molds that might be present in the sugar ingredient.
- Potential source of postpasteurization contamination (HACCP).

- The consistency of yogurt is better when sugar is added to the milk rather than into the coagulum, unless the formulation has been adjusted to allow for this dilution.

If it is necessary to add sweeteners after fermentation, only pasteurized liquid sugar or flavored sweetened syrups should be used. When using this method, the total solids of the yogurt mix must be adjusted for the dilution associated with these liquid sweeteners. Also, Good Manufacturing Practices and HACCP control should be practiced to minimize the potential risk of microbiological or physical contamination.

Refined crystalline sucrose is manufactured industrially from sugar cane or sugar beet processing. Both sources give identical sucrose with no chemical, physical, or structural differences. Crystalline sugar is either refined from crude raw sugar or is processed from sugar cane juice. The first step is to extract juice from sugar cane using a series of roller presses. Nonsugar impurities are removed by mechanical filtration, followed by lime-carbon dioxide purification step. The juice is allowed to settle and then filtered to get purified juice. In some factories, this step involves lime-phosphoric acid floatation procedure. Furthermore, purification of the juice is achieved by treatment with activated charcoal and ion exchange reactors. This juice (12–15% total solids, 91–92% purity) is evaporated in multistage vacuum evaporators to get sugar concentrate containing 65–71% solids. Furthermore, crystallization of sugar is effected in vacuum pans under controlled conditions of temperature, pressure, density, and viscosity. The resulting sugar crystals are separated from mother liquor by centrifugation at 1,000–2,500 x g. The semidry sugar is rinsed with water and dried further with hot air in a rotating drum, cooled, classified on vibrating screens, and packaged. The mother liquor goes through a series of crystallization steps to harvest maximum yield of premium quality sugar. The left over liquor is a by-product of sugar industry, called blackstrap molasses.

Refined cane sugar is also manufactured from raw sugar produced at the point of origin. In this case, raw sugar is refined by extracting cane sugar juice, clarification, concentration, and crystallization. Other products from raw sugar production are white sugar, turbinado sugar, and various grades of molasses. Raw sugar is then shipped to sugar refineries where it is subjected to a series of purification steps, such as centrifugation, filtration, decolorization, evaporation, and crystallization. The by-products of refining

**Table 11.5.** Various Sugar Products Used in Formulation of Foods

Sucrose Product	Sucrose Content(%)	Moisture Content(%)
High-purity sucrose	99.90–99.95	0.02–0.04
Brown/soft sugars	92.00–98.00	3.5–4.0
Raw sugar	96.50–97.50	0.5–0.7
Blackstrap molasses	38.00–45.00	12–18
Raw molasses	56.00–62.00	14–18

steps are brown sugar, refinery syrups, liquid sugar, and molasses.

Beet sugar is produced in a single step. Beets are sliced, followed by diffusion of sugar in water, clarification, concentration, and crystallization directly to white sugar. Purity and moisture content of various sucrose products are shown in Table 11.5.

When granulated sugar (High Purity) is used for yogurt production, it is purchased in 50–100 pound bags, 1,000–2,000 lb tote bags or in bulk. In large plants, bulk sugar is stored in silos. The color of sugar is measured by procedures approved by International Commission for Uniform Methods of Sugar Analysis. The procedure involves measuring the absorbance of 50% sugar solution (filtered through 0.45 micron membrane filter) at 420 nm wavelength. The absorbance is converted to International Color Units (ICU). The higher the ICU number, the darker is the sugar color. Generally, most granulated sugars fall below 35 ICU. The inorganic ash content of sugar is approximately 0.02%.

The moisture level in sugar is less than 0.04%. Part of the moisture in sugar results from the syrup trapped within the crystal during its formation, which can be removed only by grinding sugar crystals. Another type of moisture is bound water associated with saturated syrup enveloping the crystals. Free moisture is attributed to a supersaturated solution coating the sugar crystal during rapid drying process of sugar manufacture. Furthermore, crystallization of supersaturated solution during the storage of sugar causes the free water to be released in the surrounding air. The dried granulated sugar is conditioned by the manufacturer to reach equilibrium with the surrounding atmosphere.

The size of crystals is selected for quick dissolution during the mix preparation. The crystal size distribution is normally defined by the percent of the crystals retained on the standard U.S. mesh screen. The higher the mesh number, the finer would be the crystal size. Regular fine and extra fine grade of sugar has fine crystals. The grain size ranges from U.S. #20/40 and

#100 mesh screens. It is preferred by yogurt processors for its bulk handling properties and resistance to caking or lumping during storage.

The rating for sweetness varies according to the crystalline form and size. It is related to the stereochemistry of the structural units in the sugar.

### Liquid Sugar

Many large yogurt plants prefer using liquid sugar because it lends itself to an efficient handling (metering and pumping ability). Although liquid sugar may be economically priced, conversion from dry sugar to liquid sugar set up requires capital cost for sugar storage tanks, appropriate pumps, heaters, strainers, and meters. The storage space and the inventory control of liquid sugar must be coordinated with plant production volumes. If the delivery of liquid sugar is by tank cars, storage capacity requirements are of the order of at least 1.5 cars or 12,000 gallons. If truck delivery is convenient, the volume per delivery may be in the range of 1,000 to 3,000 gallons. To cope up with emergencies like delays and increased usage, the inventory should be adjusted accordingly.

Liquid sugar is obtained by dissolving refined granulated sugar in water. Some cane sugar refining plants produce liquid sugar directly prior to crystallization and drying. It is delivered in tanks and stored in yogurt plant in specific tanks equipped with ultraviolet light to control growth of yeasts and molds. Adequate ventilation of the tanks is necessary to avoid moisture condensation and resulting microbial growth. Storage temperature range is 30–32°C. This ingredient contains 66–67% solids (67° Brix) consisting of minimum of 99.7% sucrose and invert sugar level <0.35%. The ash content is restricted to less than 0.04% and iron content may not exceed 0.5 ppm. The pH is within the range of 6.7–8.5. A gallon of liquid sugar has 7.42–7.55 pounds of solids and weighs 11.08–11.12 pounds. The viscosity of liquid sugar is around 2 poises. The color of liquid sugar is similar to that of granulated sugar (less than 35 ICU).

Conversion of mix formula from dry sugar to liquid sugar can be done as follows:

$$\text{Pounds of liquid sugar required} = \frac{\text{Pounds of dry sugar required}}{\text{Percentage of solids in liquid sugar}}$$

Normally, for 100 lbs of dry sugar, 149.25 lbs of liquid sugar is needed to add the same amount of sucrose in the formula.

More often, conversion of dry sugar to gallons of liquid sugar is required. To calculate gallons of liquid sugar to replace dry sugar, divide the pounds of dry sugar with pounds of sugar solids per gallon. To replace 100 lbs of dry sugar, gallons of liquid sugar required would be:  $100/7.42 = 13.48$  gallons of liquid sugar.

The level of sucrose in yogurt mix appears to affect the production of lactic acid and flavor by yogurt culture. A decrease in characteristic flavor compound (acetaldehyde) production has been reported at 8% or higher concentration of sucrose (Chandan, 2004), but cultures capable of growth at higher sugar levels are available.

## Corn Sweeteners

Corn sweeteners are normally not used in the manufacture of yogurt per se, but are commonly the constituents of frozen yogurt mixes, where they are blended after fermentation. They are also sweeteners of choice in the preparation of fruit-for-yogurt (Chapter 9). The corn sweeteners offer savings in ingredient costs. Nonetheless, they do exert much more inhibitory effect on fermentation rate as compared to sucrose. This is attributed to higher osmotic pressure exerted by monosaccharides contained in corn syrup sweeteners. In comparison, sucrose being a disaccharide is less inhibitory to yogurt culture growth. The corn-derived sweeteners, fructose and glucose, usually enter yogurt via the processed fruit flavor in which they are extensively used for cost efficiency and flavor enhancing characteristics. It is desirable for a yogurt manufacturer (especially if frozen yogurt is a part of the product profile or fruit-for-yogurt is a part of the plant operation) to be knowledgeable about basics of corn sweeteners.

Sweeteners can be made by hydrolyzing any food starch. In the United States, corn starch is an economical starting material to manufacture corn sweeteners. The 1, 4 glucoside linkages holding together dextrose molecules in starch are broken down to smaller fragments and eventually to individual building blocks

consisting of monosaccharide glucose. The hydrolysis is accomplished by treatment of starch slurry with hydrochloric acid, followed by enzymatic action of  $\alpha$ -amylase. If the reaction is stopped at an intermediate point, the end products are composed of an assortment of sugars and oligosaccharides (maltodextrins). The degree of hydrolysis or conversion is termed by a number "dextrose equivalent," (D.E.) which is used to signify the percent reducing sugars calculated as dextrose. Hydrolysis of each glucoside linkage liberates a free aldehyde group that displays the same reducing ability as dextrose (glucose). Thus, reducing ability is an indicator of the progress of starch hydrolysis. For instance, 42 D.E. corn syrup is a product made from corn starch that has reducing sugars in such proportions as to be equivalent to 42% dextrose. If the conversion is complete at 100% D.E., the product is dextrose.

## Maltodextrins

Maltodextrins are products of very low hydrolysis of starch. Their D.E. ranges from 4 to 20. They are only slightly sweet. Hydrolysis of starch is random resulting in the formation of smaller chain oligosaccharides to saccharide polymers of varying chain length. They are made from common corn starch, as well as from waxy starch. The maltodextrins from each of these starting materials display slightly different functionality. In general, their pH value ranges from 4.4 to 5.0 and moisture level is 5–6%. Maltodextrin 5 D.E. from waxy starch has an actual D.E. range of 5–8, contains <0.5% dextrose, 1% maltose, and >98.5% higher polymers of dextrose. On the other hand, Maltodextrin 5 D.E. derived from common starch has an actual D.E. range of 4–7 and contains <1% dextrose, <1% maltose, and >98% higher polymers of dextrose. Maltodextrins of 10 D.E. have actual D.E. range of 9–13 and contain 0.5–1.0% dextrose, 2% maltose, and 96–97% higher polymers of dextrose. Finally, maltodextrins D.E.15 have an actual D.E. range of 13–18 and contain 2% dextrose, 3% maltose, and >94% higher polymers of dextrose (Alexander, 1997). It is good to remember that lower the D.E., the higher the molecular weight of the product and lower the intensity of sweetness. To enhance dispersability, maltodextrins are agglomerated. Agglomeration of corn-derived 10 D.E. maltodextrins reduces the bulk density from 0.54 to 0.34 g/cc. In dry mixes, they promote flowability and reduce dust during handling. They are also good bulking agents in the formulation of low/non fat frozen yogurt.

**Table 11.6.** Properties of Liquid and Dry Corn Sugars

Type	Actual DE	% Moisture	% Dextrose	% Maltose	DP3 <sup>a</sup>	Higher DP <sup>b</sup>	Relative Sweetness: Sucrose = 1
Corn syrup 36 D.E.	35–37	20	13–14	11–12	10	64–66	0.40
Corn syrup 42 D.E.	41–43	18–20	19	13–14	12	55	0.50
Corn syrup solids 36 D.E.	34–38	4–5	13–14	11–12	10	64–66	0.40
Corn syrup solids 42 D.E.	40–44	4–5	19	12–14	11–12	55–58	0.50
Dextrose	100	0.5	99.5	0	0	0	0.8

Adapted from Alexander, 1997.

<sup>a</sup> Degree of polymerization, 3 dextrose units.

<sup>b</sup> Degree of polymerization.

Corn syrups are defined as the products in which 20–70% of the glucoside linkages have been hydrolyzed. Three types of corn sweeteners are common in the frozen yogurt industry. They are classified as low conversion (28–38 D.E.), regular conversion (38–48 D.E.), intermediate conversion (48–58 D.E.) and high conversion (58–68 D.E.). High-conversion syrups may be obtained by a combination of acid and enzyme action on starch. High maltose syrup is made from a combination of acid and  $\beta$ -amylase hydrolysis. The disaccharide maltose consists of two molecules of glucose. Dry corn syrups are obtained by spray drying partially hydrolyzed corn starch of various D.E. Crystalline dry forms of refined dextrose and fructose are available. Generally, frozen yogurt producers use 36 or 42 D.E. corn syrup in liquid form or as dry corn syrup solids. Since the liquid form is very viscous, to facilitate their pumping and metering, this ingredient is stored in heated tanks at 32°C.

Corn syrup solids are economical to use. They contribute firmness and extend the shelf life of the frozen dessert. The sweetness and other properties of corn sweeteners are shown in Tables 11.6. The high-polymer content contributes adhesive and cohesive properties to mix (Marshall and Arbuckle,

1996). The corn syrup solids ingredient is a white powder and is susceptible to caking when exposed to moist air. Since too much corn syrup in the mix may impart a flavor defect, its use in frozen dessert is limited to one-third of the total sweetener level. Crystalline dextrose is a white powder with 80% of the sweetening power of sucrose. Dextrose, being a monosaccharide of molecular weight nearly one-half of sucrose, depresses the freezing point of the mix twice as much as sucrose. Frozen yogurt from a mix containing corn syrup displays less stiff consistency as it extrudes from the ice cream freezer. Accordingly, its usage level is adjusted not to exceed 25% of the total sweetener level.

High fructose corn syrups (HFCS) and crystalline fructose equal or exceed the sweetness of sucrose (Table 11.7). HFCS production involves dextrose conversion to fructose in corn syrup by enzymatic means. They also lower the freezing point of frozen dessert mixes to the same extent as the original corn syrups.

Crystalline fructose is commonly used to effect flavor improvement in light yogurt by rounding off sweet flavor of aspartame and other nonnutritive sweeteners.

**Table 11.7.** Properties of High Fructose Corn Syrups and Crystalline Fructose

Type of HFCS	%Moisture	%Fructose	%Glucose	%Higher Polymers	Relative Sweetness: Sucrose = 1
42	20–29	42	53	5	0.9–1.0
55	23	55	41	4	1.0–1.2
90	20	90	7	3	1.4–1.6
Crystalline Fructose	0.05	99.5	0.5	0	1.2–1.6

Source: Adapted from Alexander, 1997.

Other nutritive sweeteners for use in specialty yogurt manufacture are honey, maple sugar, and brown sugar. Honey is used in honey-flavored natural yogurt. Honey has a pH of 3.9 and consists of 17.1% moisture, 38.5% fructose, 31% glucose, 7.2% maltose, 1.5% sucrose, 4.2% higher chain sugars, 0.5% protein, 0.6% acids, and trace amounts of minerals, vitamins, enzymes and amino acids. Due to the high fructose content, honey is sweeter than sugar. The colors of honey form a continuous range from water white to dark amber. In general the flavor of honey is related to its color. Dark colored honey is more intense in flavor while lighter honey is usually mild. Honey flavor is the result of a number of variables such as the floral source, the geographical region, sugars, acids, tannins, and volatile and nonvolatile constituents. Honey can be used as the sole sweetener source or in combination with equal parts of sucrose for a honey flavor in yogurt.

Maple sugar comes from the sap of sugar maple and black maple trees. The sap is 98% water. The sap is concentrated in open kettles to 65.5% solids. Typical composition of maple syrup is: 34% moisture, 58–66% sucrose, 0–8% glucose, fructose and other hexoses, 0.09% malic acid, 0.01% citric acid, and various minerals. The flavor of maple syrup is attributed to ligneous materials present in sap and caramelized sugars produced during the concentration step. The color of maple syrup can range from light amber to dark amber. Maple sugar is the end product of further evaporation of maple syrup and contains 92% solids.

Brown sugar is described in the sucrose section. It is basically unrefined sugar and has flavor similar to molasses.

Fruit and grain sweeteners are used in products marketed with a no added sugar label. They are concentrates of apple, grape, and other juices. Syrups made from rice, oats, and other grains are used in yogurts identified as containing natural ingredients and no sugar added label.

Sweeteners such as crystalline fructose, glucose, lactose, invert sugar, or honey are not often used except in certain circumstances, such as manufacture of dietetic yogurt or yogurts marketed with an “all natural” or health food appeal.

### High Intensity Sweeteners

Because the U.S. standards of identity for yogurt, low-fat yogurt and nonfat yogurt do not allow non-nutritive sweeteners to be used, there are labeling options that must be considered. Two of these options

include using a nonstandardized name for the food or using the two-food concept (i.e., nonfat yogurt with aspartame). Currently these sweeteners are used to produce “Light” and “low-carbohydrate” products. Today, the use of aspartame alone or in combination with crystalline fructose or other nonnutritive sweeteners is common in the marketing of low-calorie or “low-carb” yogurt.

Regular low-fat and nonfat yogurts contain approximately 43 g of sugar per 8 oz. cup. By replacing the sucrose in yogurt, the sugar content drops to 13 g. This reduction in sugar content is of the order of 70%. The remaining sugar is lactose, part of which may be removed by using 80% milk protein concentrate obtained by ultrafiltration and diafiltration of skim milk. This approach is the basis of “low-carbohydrate” yogurt. Concomitantly, reduction in sugar in yogurt results in significant reduction in calories as well. Regular low-fat yogurt contains 230 calories per 8 oz. cup. By replacing added sugar, the calories drop to 130. Similarly, the calories in nonfat yogurt drop from 207 to 102 per cup by sugar replacement.

The following high intensity sweeteners are approved by the Food and Drug Administration for use in yogurt (Table 11.8).

### Aspartame

Aspartame is a dipeptide. It is L- $\alpha$ -aspartyl-L phenyl alanine methyl ester. Intestinal esterases hydrolyze to individual peptides and methanol. The end products do have calories, but since the level used is so small, the calorie contribution is essentially zero. The stability of aspartame to heat, yogurt fermentation and acidic conditions must be understood. Aspartame breaks down with excessive heat exposure to diketopiperazine, but is reasonably stable at dairy processing temperatures. It is partially metabolized by yogurt cultures during fermentation. Accordingly, pasteurized aspartame solution is blended with yogurt base after fermentation. Use of

**Table 11.8.** High Intensity Sweeteners Approved by FDA for Use in Yogurt

Non-Nutritive Sweetener	Sweetness Factor, Sucrose = 1
Aspartame	160–220
Sucralose	600
Acesulfame K	200
Neotame	7,000–13,000

aspartame requires the statement “Phenylketonurics: Contains phenyl alanine.” Aspartame degrades slowly during storage and shelf life of yogurt. Studies have shown that about 7% aspartame is inactivated in yogurt stored at 4°C for 8 weeks. To compensate for expected loss in sweetness, it is advisable to adjust aspartame level for incorporation into yogurt.

Granular or liquid aspartame preparations may be used in manufacturing light yogurt and smoothies. Aspartame is dissolved in water along with an acidulant (for example, citric acid). To obtain optimum sweetness control, it is preferable to add aspartame in the granular form at the first point of breaking and cooling the yogurt coagulum. It requires 30–45 minutes of swept-surface agitation to properly disperse the granular aspartame. A less preferred route is to incorporate aspartame in fruit preparation during the cooking step. Addition of this fruit adds appropriate level of aspartame to the fruit flavored yogurt or smoothie. However, since the level of fruit preparation in finished yogurt varies considerably due to mechanical variations in dosing of fruit preparation, the sweetness level in yogurt would vary accordingly. For processing yogurt fruit as a carrier of aspartame, cooking at 96°C for 5 minutes, followed by quick cooling to 32°C or lower maximizes the stability of aspartame. The shelf life of the processed fruit is 6 months at 4°C or below.

### Sucralose

Sucralose is another high intensity sweetener which is truly nonnutritive. It is poorly absorbed in the gastrointestinal tract (11–27%). The absorbed sucralose is excreted intact in the urine; the unabsorbed portion is excreted in the feces. This is how it provides no calories. It is synthesized from sucrose by replacing three hydroxyl groups with chlorine. Chemically speaking, it is 1,6-dichloro-1,6-dideoxy-β-D-fructofuranosyl-4-chloro-4-deoxy-α-D-galactopyranoside. It is three times sweeter than aspartame or 600 times sweeter than sucrose. It is stable to heat and acidic conditions prevalent in food processing and storage. Currently, it is being used in light and “low carbohydrate” yogurt, drinks and smoothies.

### Acesulfame-K

Acesulfame-K is 5,6-dimethyl-1,2,3-oxathiazine-4(3H)-one-2,2-dioxide. In general, the potassium salt is used. It provides no calories because 95% or more is excreted, unchanged in the urine. It is 200 times sweeter than sucrose. It is stable to baking and cooking temperature. It works well with other nonnutritive sweeteners by providing sweetness synergy and masking unpleasant flavors.

### Neotame™

Neotame™ was approved by the Food and Drug Administration on July 5, 2002. It is 7,000 to 13,000 times sweeter than sucrose. Like aspartame, it is a derivative of dipeptide of aspartic acid and phenylalanine. Since it is rapidly metabolized by esterases and the end products are excreted in body wastes, it is noncaloric. Compared to aspartame, phenylalanine released in plasma is not significant. Therefore, neotame™ requires no warning label for PKU. Its flavor is clean and sweet with no off-flavors. It lacks metallic flavor. It enhances other flavors. It is heat stable and can be incorporated directly in yogurt products. Alternatively, it can be incorporated in fruit preparations and then blended with fermented yogurt base. Adding the sweetener through fruit preparation is not preferred because of inconsistency of mechanical dosing of the fruit in each cup. Compared to aspartame, neotame™ is stable to yogurt processing temperature and fermentation conditions. Studies have shown that 99% of neotame™ survived UHT pasteurization conditions and 88% survived after yogurt fermentation and subsequent storage for 5 weeks at 4°C.

Usage level of neotame™ and aspartame to achieve 6–10% sucrose level in yogurt is shown in Table 11.9.

### Saccharin

Saccharin is a synthetic compound that is 300 times sweeter than sucrose. It provides no calories. It is excreted unchanged through the kidneys. It has

**Table 11.9.** Usage Levels of Neotame and Aspartame in Yogurt

Product	Neotame™	Aspartame
Fruit flavored yogurt	0.0011–0.0017% (11–17 ppm)	0.055–0.08% (550–800 ppm)
Fruit-for-yogurt preparation	0.006–0.012% (60–120 ppm)	0.25–0.35% (2500–3500 ppm)

relatively bitter taste but is widely used as sugar replacer in beverages, cooking, and table top sweetener. However, it has little or no use in yogurt processing.

There are several nonnutritive sweeteners awaiting approval by the FDA. Alitame is a peptide of L-aspartic acid and D-alanine with a C-terminal moiety. It is 2000 times sweeter than sucrose. It has no metallic or bitter taste. It blends with other high intensity sweeteners to maximize quality of sweetness. However, it is pending approval. Cyclamates are used in 50 countries worldwide, but were banned by the FDA in 1969. Cyclamates are 30 times sweeter than sucrose. The application for reapproval is pending with the FDA. Neohesperidene dihydrochalcone is a by-product of the citrus industry. It is 1500 times sweeter than sucrose. It has licorice flavor. It is approved by the FDA as a flavor ingredient, but not as a sweetener. However, in the EU countries, it is approved as a sweetener. Another high-intensity sweetener, not yet approved by the FDA, is stevia or stevioside. It is obtained from South African shrub. Similarly, thaumatin has Generally-Regarded-As-Safe status for use as flavor adjunct in the United States. It is a mixture of proteins with tight disulfide bonds. It has an intense sweet flavor but used as a flavor enhancer.

Current trend in the use of high-intensity sweeteners in yogurt is to blend two or more sweeteners to optimize the flavor profile of yogurt. A combination of acesulfame-K with aspartame, or sucralose can enhance perceived sweetness, optimize flavor, reduce cost, and improve sweetness stability. However, research is required to determine the right combination and ratio in yogurt or fruit for yogurt formulation to achieve optimum sensory quality of the product.

## STABILIZERS

They are hydrocolloids of plant and animal origin. In North America, they are commonly used in the manufacture of yogurt. The primary purpose of adding stabilizers in yogurt is to improve consistency and build viscosity, to minimize whey separation and bind free water, and to maintain the gel structure after pumping, mixing, and cooling. The stabilizer increases shelf life of the product and provides a reasonable degree of uniformity from batch to batch. Stabilizers function through their ability to form gel structures in water, thereby leaving less free water for syneresis.

In addition, some stabilizers complex with casein. A good yogurt stabilizer should not impart any flavor, should be effective at low pH values, and should be

easily dispersed in the normal working temperatures in a yogurt plant. In addition, the stabilizer should be easily soluble, display good water holding capacity, and aid in forming stable emulsion. Furthermore, it should promote stable foam formation (in whipped yogurt), gelation, and adhesion.

Preferably, the incorporation of the stabilizer should take place using a high shear-type blender that has strong agitation resulting in complete dispersion and a uniform suspension (Chapters 5 and 13). An alternative method would be to use a pump and funnel, but care must be taken to avoid lumps. To minimize potential lumps or “fish eyes,” it is best to disperse the stabilizer in granulated sugar or NFDM during addition. Once dispersed in the mix, it is necessary to have continuous agitation to keep the stabilizer in suspension until it is fully hydrated while receiving proper heat treatment.

There are many stabilizers and their combinations available in the industry for use in yogurt. For choosing a stabilizer, the following areas should be considered:

- Type of yogurt being produced: vat/cup set, Swiss/blended type or drink/smoothie, mousse/whipped type.
- Formulation: fat content, total solids.
- Desired firmness and consistency of the finished product as per marketing objectives.
- Desired ingredient labeling (natural, organic, kosher, etc.).
- Processing equipment available: batch process (ease of incorporation), continuous heating system, in-line dosing and mixing, cooling, and pumping of coagulum.
- Possible masking effect on the flavoring system.

## Gelatin

Gelatin has been extensively used as a stabilizer in various styles of yogurt. It is derived by irreversible hydrolysis of the proteins collagen, and ossein. It is used at a level of 0.1–0.5%, depending on the firmness desired in refrigerated yogurt. Gelatin is a good stabilizer for frozen yogurt as well. The term Bloom refers to the gel strength as determined by a Bloom gelometer under standard conditions. Gelatin of Bloom strength of 225 or 250 is commonly used. The gelatin level should be geared to the consistency standards for yogurt. The amount of gelatin above 0.35% tends to give yogurt of relatively high milk solids a curdy and lumpy appearance upon stirring.



Gelatin tends to degrade during processing at ultrahigh temperatures and its activity is temperature dependent. At temperatures below 10°C, the yogurt acquires a pudding-like consistency. The yogurt gel developed by gelatin is considerably weakened by a rise in temperature.

Gelatin is desirable because of its sheen-like appearance and its ability to take a lot of abuse and still produce a good product. However, when using only gelatin, the product could have a jelly-like body which tends to stir out lumpy, which is undesirable in most markets. For this reason, it is more common to use gelatin in combination with other stabilizers to lessen the stiff jelly effect and produce a body which stirs out smooth and is free of lumps. Two combinations are commonly used: modified starch-gelatin and gelatin-pectin. When the objective is to produce a “natural” Swiss style yogurt with medium viscosity without the use of conventional stabilizers, the addition of WPC and MPC is helpful. Their addition increases the protein content and water binding capacity.

The stabilizers generally used in yogurt are shown in Table 11.10.

For effective use of stabilizers, it is imperative to understand their interactions with milk constituents for possible synergy or interference with the ingredients of yogurt mix.

### NATIVE AND MODIFIED STARCH

A new technology has been developed for producing native starches without chemical modification that have properties similar to modified starches for application in low to moderate temperature and shear

food systems. This functional native starch can be derived from corn or tapioca. They have been used alone or in combination with WPC or gums in specially marketed yogurt products with some success. Although these specially processed native starches are designed to resemble the textural properties of modified starches, they have both product and process limitations. For most applications, starch products that have been subject to chemical and physical modification, result in starch gels that are made to withstand processing conditions involving high heat, shear, and acidic environment. Improvement in gelatinization and pasting characteristics, solubility, and clarity are possible with appropriate modification. Furthermore, modification of starch can lead to viscosity generation or reduction, freeze-thaw stability, increased gel strength and enhanced appearance, and syneresis control, making them versatile for use in food processing. Chemical modification is effected by esterifying hydroxyl groups of starch with acetic anhydride, succinic anhydride, phosphoryl chloride, various phosphates or by etherification with propylene oxide, or by reaction with hydrochloric/sulfuric acid, or by bleaching with hydrogen peroxide, hypochlorite, etc. A combination of these treatments may be applied. In addition, cross-linking of starch chains with phosphate diester reduces the degree and rate of granule swelling, which helps stabilize the yogurt and provide resistance to break down during mechanical shearing.

Modified corn/tapioca starch suitable for use at low pH is commonly used in yogurt formulation. For instance, stabilized and medium cross-linked waxy maize starch (hydroxypropyl distarch phosphate) is a viscosity generator and a stabilizer. It has a bland

**Table 11.10.** Common Stabilizers for Yogurt and Yogurt Drinks

Stabilizer	(%) Concentration in Yogurt Mix
Whey protein concentrate (34%, 50%, or 80% protein) or/and milk-protein concentrate	0.7–1.5
Starch, modified (tapioca/corn)	0.8–2.0
Gelatin (225/250 Bloom)	0.1–0.5
Agar	0.25–0.70
Pectin (low methoxy for yogurt)	0.08–0.20
Pectin (high methoxy for yogurt beverages)	0.30–0.50
Locust bean gum (in combination)	0.3–0.5
Xanthan gum (in combination)	0.01–0.05
Carrageenan (in combination)	0.01–0.05
Natural corn starch	1.5–2.0
Carboxymethyl cellulose	0.1–0.2

flavor, gives clear paste, smooth short texture, and can withstand severe processing conditions of low pH, high heat and extreme shear.

## GUMS AND PECTINS

Frozen yogurt contains plain yogurt of the order of 10–20%, while the rest of the product is constituted from ice milk mix. The ice milk mix is designed for optimum freezing characteristics, as well as for desirable texture during shelf life of composite frozen yogurt product. Various gums are used to achieve these effects. The seaweed gums impart a desirable viscosity as well as gel structure to yogurt. Algin and sodium alginate are derived from giant sea kelp. Carrageenan is made from Irish moss and compares with 250 Bloom gelatin in stabilizing value. These stabilizers are heat stable and promote stabilization of the yogurt gel by complex formation with  $\text{Ca}^{+2}$  and casein.

Pectins are commonly used alone or in combination with other hydrocolloids to stabilize stirred and set yogurt. The source, structure, and type of pectins are discussed in Chapter 12. Low Methoxy (LM) pectin is the preferred type for (refrigerated) cup yogurt. Very small amount (0.07–0.15%) modifies the consistency of the yogurt making it stiffer and preventing any syneresis that might arise during handling, transportation, and distribution. LM pectin retains the lactoserum in a very flexible network that is formed in reaction with calcium ions present in the yogurt. The maximum amount of pectin to be added to yogurt is 0.20%, as higher concentrations could result in a chalky or sandy texture and decreased viscosity in stirred yogurt.

High Methoxy (HM) pectin is preferred to ensure stability and control viscosity in acidified milk drinks. HM pectin stabilizes the milk proteins to produce products without sedimentation and whey separation and ensures a smooth mouth feel without “sandy-ness.” The stabilization is obtained by absorption of pectin onto the surface of the protein particles with the proper application of shear force. The absorbed pectin imparts a similar charge to all particles causing repulsion between particles preventing agglomeration that would result in sedimentation, separation, and a sandy texture. The optimum HM pectin level is determined by:

- Protein concentration
- Protein particle size

- Heat treatment
- Length of shelf life

Among the seed gums, locust bean gum or carob gum is derived from the seeds of a leguminous tree. Carob gum is a neutral polysaccharide and therefore, pH has little effect on viscosity in the range pH 3–11. It is insoluble in cold water and must be heated to be dissolved. It does not have gelling properties on its own and is used primarily in yogurt to add viscosity or increase gel strength in combination with other stabilizers. It is commonly used in frozen yogurt where its principal function is stabilizing and the binding of water, which provides heat-shock resistance and a slow creamy meltdown. Guar gum is also obtained from seeds and can be used in stabilizer systems for frozen yogurt. Guar gum is readily soluble in cold water and is not affected by high temperatures used in the pasteurization of yogurt mix. Guar gum is nongelling and is used mainly as a viscosity builder, stabilizer, and moisture-binding agent. Guar gum imparts body, texture, chewiness, and heat-shock resistance to frozen yogurt. Carboxy methyl cellulose is a derivative of the natural product cellulose. It is readily soluble in either hot or cold water and is effective at high processing temperatures. Its primary function in yogurt would be as a thickener and moisture-binding agent. In frozen yogurt, it functions to bind water, thus preventing the formation of large ice crystals that can develop during temperature fluctuations in storage. The result is a frozen yogurt with smoother texture and improved melt down characteristics.

The stabilizer system used in yogurt mix preparations is generally a combination of various vegetable stabilizers. Their ratios as well as the final concentration (generally 0.5–2.00%) in the product are carefully controlled to get desirable effects.

Other important ingredients used in yogurt manufacture are fruits and flavors. They are described separately in Chapter 9.

## REFERENCES

- Alexander RJ. 1997. Sweeteners: Nutritive. Eagan Press, St. Paul, MN, pp. 17–43.
- American Dairy Products Institute. 1990. Standards for grades of dry milks including methods of analysis. Bulletin 916 (Revised). Elmhurst, IL, 60126. pp. 1–56.
- Chandan RC. 1982. Fermented dairy products. In: G Reed (Ed), Prescott & Dunn's Industrial

- Microbiology. Avi Publishing, Westport, CT, pp. 113–184.
- Chandan RC. 1997. Dairy-Based Ingredients. Eagan Press, St. Paul, MN, pp. 48–49.
- Chandan RC. 2004. Dairy: yogurt. In: JS Smith, YH Hui (Eds), Food Processing: Principles and Applications, Blackwell Publishing, Ames, IA, pp. 297–328.
- Chandan RC, Shahani KM. 1993. Yogurt. In: YH Hui (Ed), Dairy Science and Technology Handbook, Vol. 2. VCH Publishers, New York, New York, pp. 1–56.
- Chandan RC, Shahani KM. 1995. Other fermented dairy products. In: G Reed, TW Nagodawithana (Eds), Biotechnology, Vol. 9, 2nd ed. VCH Publishers, Weinheim, Germany, pp. 386–418.
- Marshall RT, Arbuckle WS. 1996. Ice Cream. Chapman and Hall, NY, pp. 317–318.
- Tamime AY, Robinson RK. 1999. Yogurt Science & Technology, 2nd ed. Woodhead Publishing Limited, Cambridge, England and CRC Press, Boca Raton, Florida.
- United States Department of Health and Human Services. 1999. Public Health Services, Food and Drug Administration. Grade “A” Pasteurized Milk Ordinance. Revision. Publication no. 229. Washington, DC.

# 12

## Principles of Yogurt Processing

*Ramesh C. Chandan and Kevin R. O'Rell*

Mix Preparation  
Heat Treatment  
Homogenization  
Yogurt Starter  
    Factors Influencing Growth of Yogurt Starter  
    Yogurt Strain Selection  
    Changes in Milk Constituents During Yogurt Production  
References

Yogurt is a fermented, low to high acid semisolid cultured milk product (Chandan, 2002; Shah, 2003; Vedamuthu, 1991). The sequence of stages of processing in a yogurt plant is given in Table 12.1.

### MIX PREPARATION

During standardization of the mix for yogurt manufacture, the contribution of common dairy ingredients to the milk fat and milk solids-not-fat portion of yogurt mix is given in Chapter 11 (Table 11.1). In most yogurt formulations, standardization of milk for fat and solids-not-fat content results in fat reduction and a possible 30–35% increase in lactose, protein, mineral, and vitamin content (Chandan and Shahani, 1993, 1995; Chandan, 1997, 2004). The nutrient density of yogurt mix is thus increased over that of milk. Specific gravity changes from 1.03 to 1.04 at 20°C. Addition of stabilizers (gelatin, starch, pectin) and sweeteners further impacts physical properties.

### HEAT TREATMENT

Yogurt processing requires intense heat treatment, which destroys all the pathogenic flora and most vegetative cells of all microorganisms contained therein. In addition, milk enzymes inherently present are

inactivated. From microbiological standpoint, destruction of competitive organisms produces conditions conducive to the growth of desirable yogurt bacteria. This contributes to the long shelf life as well as to food safety aspects of yogurt. Furthermore, the heat processing results in the expulsion of oxygen, creation of reducing conditions (sulfhydryl generation), and production of protein-cleaved nitrogenous compounds. All these effects enhance nutritional status of the medium for growth of the yogurt culture.

Physical changes in the proteins as a result of heat treatment have a profound effect on the viscosity of yogurt (Shah, 2003). Optimum results are obtained by using a heat treatment of 90–95°C and a holding time of 5–10 minutes (Robinson, 2003a). Consequently, whey protein denaturation of 70–95% enhances water absorption capacity, thereby creating smooth consistency, high viscosity and stability from whey separation in yogurt.

Nutritional changes include ease of digestion of denatured whey proteins in the gastrointestinal tract, soft curd in the stomach, and rapid gastric emptying rate attributed to viscous nature of yogurt.

Heat treatment of yogurt mix can be conducted using a variety of methods:

- Jacketed mix/processing tank
- Plate heat exchanger
- Tubular heat exchanger
- Scraped-surface heat exchanger.

In most yogurt manufacturing facilities today the heat treatment of the yogurt mix is accomplished using plate heat exchangers. The plate heat exchanger consists of a pack of stainless steel plates clamped in a frame. The frame may contain several plate packs or sections in which different stages of treatment such

**Table 12.1.** Sequence of Processing Stages in the Manufacture of Blended Style Yogurt.

Step	Salient Feature
Milk procurement	Sanitary production of Grade A milk from healthy cows is necessary. For microbiological control, refrigerated bulk milk tanks should cool to 10°C in 1 hour and <5°C in 2 hours. Avoid unnecessary agitation to prevent lipolytic deterioration of milk flavor. Milk pickup from dairy farm to processing plant is in insulated tanks at 48-hour intervals, as appropriate.
Milk reception and storage in manufacturing plant	Temperature of raw milk at this stage should not exceed 7°C. Insulated or refrigerated storage up to 72 hours helps in raw material and process flow management. Quality of milk is checked and controlled.
Centrifugal clarification and separation	Leucocytes and sediment are removed. Milk is separated into cream and skim milk or standardized to desired fat level at 5°C.
Mix preparation	Various ingredients to secure desired formulation are blended together at 5°C in a mix tank equipped with powder funnel and an agitation system.
Heat treatment	Using plate heat exchangers with regeneration systems, milk is heated to temperatures of 95–97°C for 7–10 minutes, well above pasteurization treatment. Heating of milk kills contaminating and competitive microorganism, produces growth factors by breakdown of milk proteins, generates microaerophilic conditions for growth of lactic organisms, and creates desirable body and texture in the cultured dairy products.
Homogenization	Mix is passed through extremely small orifice at a pressure of approx. 1,700 MPa (2,000–2,500 psi), causing extensive physicochemical changes in the colloidal characteristics of milk. Consequently, creaming during incubation and storage of yogurt mix is prevented. The stabilizers and other components of a mix are thoroughly dispersed for optimum textural effects.
Inoculation and incubation	The homogenized mix is cooled to an optimum growth temperature (41–42°C). Inoculation is generally at the rate of 0.5–5% and the optimum temperature is maintained throughout incubation period to achieve a desired titratable acidity or pH. A pH of 4.5–4.6 is commonly used as an endpoint of fermentation. Quiescent incubation is necessary for product texture and body development.
Cooling, fruit incorporation and packaging	The coagulated product is cooled down to 5–22°C, depending upon the style of yogurt. Using fruit feeder or flavor tank, the desired level of fruit and flavor is incorporated. The blended product is then packaged.
Storage and distribution	Storage at 5°C for 24–48 hours imparts in several yogurt products desirable body and texture. Low temperatures ensure desirable shelf life by slowing down physical, chemical, and microbiological degradation.

Source: Chandan, 2004.

as preheating, final heating, and cooling take place. The plates are corrugated in a pattern designed for optimum heat transfer as the liquid product enters and leaves the channels on one side and the heating or cooling medium on the opposite side. Most heat plate exchangers contain a section that is used for regeneration. Regeneration is a process using the heat of a hot liquid (yogurt mix) to preheat the cold incoming liquid (yogurt mix). The cold liquid (yogurt mix) is also cooling the hot liquid (yogurt mix) saving

on water and energy. Regeneration efficiencies of up to 94–95% can be achieved using efficient plate heat exchangers. Proper heat treatment of the yogurt mix requires that the mix be held for a specified time at a desired final heating temperature. This is usually accomplished in an external holding tube. The holding tube consists of stainless steel pipe arranged in either a spiral or zigzag pattern. The tube can be insulated or contained in an insulated box to minimize heat loss during the extended hold time. The length of the pipe

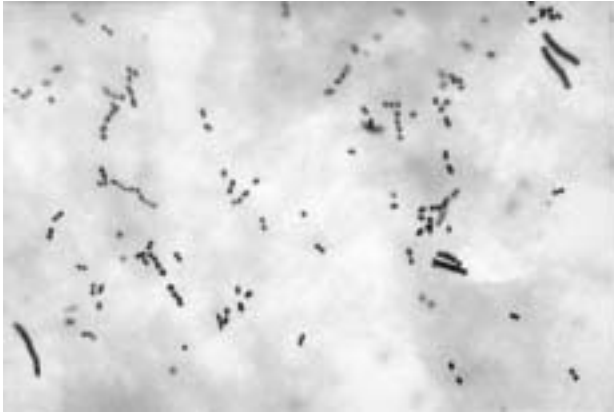

**Figure 12.1.** Stained cells of yogurt bacteria under microscope. 1,000 × magnification.

and flow rate is calculated to give the desired hold time in the tube.

## HOMOGENIZATION

Homogenization treatment reduces the fat globules to an average of less than 1  $\mu\text{m}$  in diameter and assures a uniform distribution of the milk fat in the yogurt. Consequently, no distinct creamy layer (crust) is observed on the surface of yogurt produced from homogenized mix. There is also an improvement in the consistency of the yogurt and greater stability of the coagulum against whey separation. In general, homogenized milk produces soft coagulum in the stomach, which may enhance digestibility.

Homogenization temperatures used are usually from 55°C to 80°C with homogenization pressures between 10 and 20 MPa (100–250 bar). In general the homogenizer is placed after the first regenerative section and before the final heating. This is because homogenization is most efficient when the fat phase is in a liquid state.

Most yogurt facilities use a two-stage homogenizer to achieve optimal homogenization. Although homogenization always takes place in the first stage, the second stage serves two basic functions: (a) It supplies a constant and controlled back-pressure to the first stage that improves homogenization efficiency; (b) it prevents the clumping of fat globules that can occur immediately following the first-stage homogenization.

Yogurt is traditionally made from fortified whole milk, low-fat milk or skim milk to which a yogurt culture is added and allowed to grow. In general,

yogurt should have a custard-like or soft spoonable consistency that is free from syneresis or wheying off. The coagulum should be smooth without grains or lumpiness and break cleanly when spooned from the container. The coagulum should also have a close texture with complete absence of any gas space or open texture. The activity of yogurt culture plays a key role in getting the required texture and flavor. The fermentation is carried out by yogurt starter.

## YOGURT STARTER

Starters for yogurt production are discussed in detail in Chapter 6. A starter culture consists of food-grade microorganism(s), which when allowed to grow in milk produce predictable attributes characterizing yogurt (Fig. 12.1).

The composition of yogurt starter is shown in Table 12.2.

Also, shown in this table are some additional organisms found in yogurt or yogurt-like products marketed in various parts of the world.

All types of yogurt in the United States are fermented with the yogurt characterizing cultures mandated by FDA regulations. The yogurt culture contains *Streptococcus thermophilus* (ST) and *Lactobacillus delbrueckii* subsp. *bulgaricus* (LB). Furthermore, a majority of the yogurt sold contains optional bacteria, especially those of intestinal origin. The optional organisms include *Lactobacillus acidophilus*, bifidobacteria, and other lactobacilli that are often referred to as probiotic bacteria. Their inclusion in yogurt starter is motivated by their unique health-promoting effects. Such effects include improvement

**Table 12.2.** Required and Optional Composition of Yogurt Bacteria.

Required by FDA Standard of Identity	Optional Additional Bacteria Found in Yogurt
<i>Streptococcus thermophilus</i> (ST)	<i>Lactobacillus acidophilus</i>
<i>Lactobacillus delbrueckii</i> subsp. <i>bulgaricus</i> (LB)	<i>Lactobacillus casei</i>
	<i>Lactobacillus casei</i> subsp. <i>rhamnosus</i>
	<i>Lactobacillus reuteri</i>
	<i>Lactobacillus helveticus</i>
	<i>Lactobacillus gasseri</i> ADH
	<i>Lactobacillus plantarum</i>
	<i>Lactobacillus lactis</i>
	<i>Lactobacillus johnsoni</i>
	LA1
	<i>Lactobacillus fermentum</i>
	<i>Lactobacillus brevis</i>
	<i>Bifidobacterium longum</i>
	<i>Bifidobacterium breve</i>
	<i>Bifidobacterium bifidum</i>
	<i>Bifidobacterium adolescentis</i>
	<i>Bifidobacterium animalis</i>
	<i>Bifidobacterium infantis</i>

Source: Adapted from: Chandan, 1999, 2004.

in protein digestibility, alleviation of lactose intolerance, enhancement of mineral absorption, control of intestinal health, lowering of serum cholesterol, antihypertensive effects, anticancer properties, and immunity enhancement (Takano and Yamamoto, 2003). Some yogurt manufacturers incorporate them after yogurt fermentation, whereas others coculture them with yogurt organisms.

Both ST and LB are fairly compatible as well as symbiotic for growth in milk medium. However, the optional organisms do not necessarily exhibit compatibility with LB and ST. Judicious selection of strains of LB, ST, and the optional organisms is necessary to insure survival and growth of all the component organisms of the starter. Nevertheless, product characteristics, especially flavor, may be significantly altered from traditional yogurt flavor, when yogurt culture is cocultured with optional bacteria, especially bifidobacteria. Normally, the yogurt culture, which is composed of LB and ST, is responsible for the characteristic flavor and aroma of yogurt through the production of acetaldehyde, diacetyl, and acetic acid during the fermentation process. Lactic acid, being a nonvolatile substance, contributes to the acidic and refreshing taste of yogurt,

whereas the volatile by-products contribute to its pleasant and characteristic aroma. Of the volatile flavor components, acetaldehyde accounts for almost 90%. However, bifidobacteria produce more acetic acid than lactic acid. Therefore, if they are used in the culture makeup, the overall flavor profile will change as a result of higher acetic acid content.

With the advice of culture suppliers, the proper culture can be selected that yields a finished yogurt with desirable flavor and consistency and is suitable for the plant equipment and production schedule.

The physiological state of a starter culture is determined by microscopic examination of the dyed cells of the culture. Cells of ST grown fresh in milk or broth display pairs or long chains of spherical coccid shape (Figure 12.2). Under stressed condition of nutrition and age (old cells, cells exposed to excessive acid, solid media colonies, inhibitor containing milk), the cells appear oblong in straight chains, resembling somewhat like LB.

The acid producing ability is measured by pH drop and titratable acidity rise in 12% reconstituted nonfat dry milk medium (sterilized at 116°C/18 minutes) incubated at 40°C for 8 hours. A ratio of 3 parts of ST and 1 part of LB gives a pH of 4.20 and % TA of 1.05 (Chandan and Shahani, 1993) under the above conditions.

Since starter cultures from culture suppliers are added to the pasteurized yogurt mix, it is essential that the commercial starter be contaminant-free. Commercial starter culture suppliers provide microbiological specifications in terms of contaminant tolerances for their products. Accordingly, microbiological specifications of commercial cultures are outlined (Sellars, 1989). In general, counts of mesophilic lactics, yeasts and molds, coliforms, anaerobic sporeformers, and salt-tolerant micrococci should not exceed 10 CFU/g. *Escherichia coli*, *Enterococcus faecium*, and coagulase positive staphylococci should be <1 CFU/g. The culture must be free of salmonella, listeria, and other pathogenic contaminants.

Data relative to various characteristics of bacteria most commonly used for yogurt processing are presented in Table 12.3.

## FACTORS INFLUENCING GROWTH OF YOGURT STARTER

Yogurt fermentation constitutes the most important step in its manufacture. To optimize the parameters for yogurt production, an understanding of factors

**Table 12.3.** Certain Characteristics of Most Commonly Used Microorganisms in Yogurt Production.

Characteristic	<i>Streptococcus thermophilus</i>	<i>Lactobacillus delbrueckii</i> subsp. <i>bulgaricus</i>	<i>Lactobacillus acidophilus</i>
Cell shape and configuration	Spherical to ovoid, pairs to chains	Rods with round ends, single, short chains, metachromatic granules	Rods with round ends, single, pairs, short chains, no metachromatic granules
Catalase reaction	—	—	—
Growth temperature, °C			
Minimum	20	22	20–22
Maximum	50	52	45–48
Optimum	40–45	40–45	37
Incubation temperature, °C	40–45	42	37
Heat tolerance (60°C/30 minutes)	++	+	—
Lactic acid production in milk	0.7–0.8%	1.8%	2.0%
Lactic acid isomers	L(+)	D(–)	DL
Acetic acid	Trace	Trace	+
Gas (CO <sub>2</sub> ) production	—	—	—
Proteolytic activity	+/-	+	+/-
Lipolytic activity	+/-	+/-	+/-
Citrate fermentation	—	—	—
Fermentation ability for carbohydrates:			
Lactose	+	+	+
Glucose	+	+	+
Galactose	—	—	+
Sucrose	+	+	+
Fructose	+	+	+
Aroma/Flavor compounds	++	++	+
Hydrogen peroxide production	+/-	+	+
Mucopolysaccharide production	+	++	—
Alcohol production	—	Trace	Trace
Salt tolerance: % maximum	2.0	2.0	6.5

Source: Compiled from: Chandan and Shahani, 1995; Surono and Hosono, 2003; Nauth, 2004.

involved in the growth of yogurt bacteria is important to manage the uniformity of product quality and cost effectiveness of manufacturing operation.

### *Streptococcus thermophilus*

*Streptococcus thermophilus* (ST) is characterized by its typical attributes, which distinguish it from lactococci used in the manufacture of cheese, buttermilk, and sour cream. ST originates exclusively from the

dairy environment from which it can be easily isolated. ST (Fig. 12.2) is a Gram-positive, anaerobic, nonmotile, and catalase negative organism with spherical/ovoid cells of 0.7–0.9 μm in diameter (Robinson, 2003b).

ST can survive 60°C for 30 minutes (Nauth, 2004). It does not grow at 10°C. Although the optimum growth temperature for ST is 37°C, it grows well in cooperation with LB at the yogurt incubation temperature of 43°C. During yogurt fermentation, the





**Figure 12.2.** *Streptococcus thermophilus* cells under microscope. 1,000 × magnification.

initial need of ST for nitrogen source is fulfilled by free amino acids present inherently in milk medium. As fermentation proceeds, the peptides generated by LB are hydrolyzed by the peptidases of ST to generate free amino acids for its nutritional needs.

Milk is a good medium for its growth. ST can ferment glucose, fructose, mannose, sucrose, and lactose. Milk lactose is transported through the cell membrane with the help of the enzyme galactoside permease located in the membrane. The lactose in the cell is then hydrolyzed by lactase or  $\beta$ -galactosidase enzyme. ST produces significant levels of lactase, which catalyzes the hydrolysis of lactose to glucose and galactose. Glucose is converted to pyruvate via Embden-Meyerhof pathway (Chapter 6). Pyruvate is metabolized to lactic acid by the enzyme lactic dehydrogenase. In most strains, glucose is readily utilized in milk medium while lactic acid and galactose accumulate. Some strains can utilize galactose. These strains display galactokinase activity converting galactose to galactose-1-phosphate, which is further converted to glucose-1-phosphate or galactose-6-phosphate and further metabolized to lactic acid (Robinson, 2003b). The lactic acid produced by this organism is L (+) lactic acid. ST is inhibited by increasing levels of lactic acid and at approximately 1% concentration (pH 4.3), its growth is arrested and cell numbers reach stability. At this stage the fermented mass displays ST counts of log 7–8 CFU/g.

The lactase activity of ST has a physiological significance in aiding the digestion of lactose in human

digestive tract following consumption of yogurt by lactose intolerant individuals.

When cultured in milk at 43°C, many strains appear as spherical occurring in pairs or long chains of 10–20 cells. Most cells appear as diplococci. At high acidity levels in milk, if the cells are aged or if the culture is grown on solid media, ST may exhibit long chains. When plated on solid media, ST produces pin-point colonies. The display of abnormal shapes of cells obtained from liquid media are indicators of stress conditions on the organism, viz., bacteriophage attack, and inhibitors (sanitizers, antibiotics, cleaning compounds, etc.) in the growth medium. ST is very sensitive to inhibitory substances, especially antibiotics. It is readily inhibited by 0.005 IU penicillin/ml of milk. It should be noted that ST is more often attacked by bacteriophage than LB.

### ***Lactobacillus delbrueckii* subsp. *bulgaricus***

This organism was originally described by Orla Jensen in 1919 as *Thermobacterium bulgaricum*. On the basis of DNA homology studies, four subspecies of *Lb. delbrueckii* are classified as *bulgaricus*, *leichmannii*, *lactis*, and *delbrueckii*. LB is a Gram-positive, catalase-negative, and nonmotile organism. (Fig. 12.3).

LB is an anaerobic/aerotolerant homofermentative organism that produces D (–) lactic acid and some hydrogen peroxide. It can produce a large quantity of lactic acid (up to 1.8%), but for yogurt production the strains, which are moderate acid producers

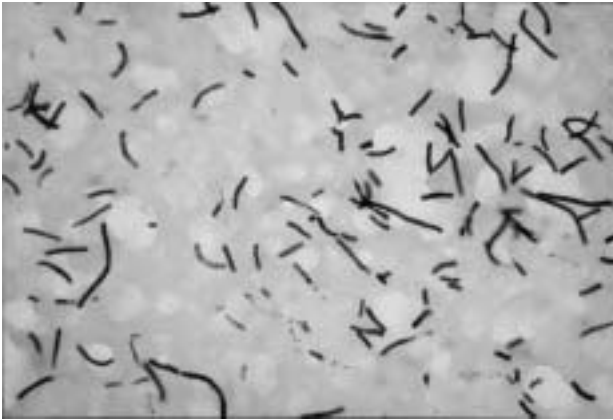

**Figure 12.3.** *Lactobacillus delbrueckii* spp. *bulgaricus* cells under microscope. 1,000 × magnification.

are selected. Like ST, LB produces lactase enzyme to hydrolyze lactose to glucose and galactose. Glucose is metabolized to lactic acid, while galactose accumulates in the growth medium.

The cells of LB appear under microscope as slender rods with rounded ends. The cells occur singly or in chains of 3–4 short rods ( $0.5\text{--}0.8 \times 2.0\text{--}9.0 \mu\text{m}$ ) with rounded ends. In a young and vigorous state, the cells occur mainly singly or in pairs. Younger LB cells under microscopic examination do not show volutin (metachromatic) granules. With increasing age (20–24 hours), the cells elongate and the volutin granules become more visible. Nutritional stress leads to copious granules in the rods. LB has a higher resistance to antibiotics than ST, but is inhibited by 0.3–0.6 IU of penicillin/ml of milk.

The optimum growth temperature of LB is  $45^\circ\text{C}$ , but for yogurt production, a temperature of  $42\text{--}43^\circ\text{C}$  is used to accommodate the lower optimum growth temperature of ST. LB utilizes lactose, glucose, fructose, and in some strains galactose to produce as high as 1.8% D(–) lactic acid. It tolerates low pH much better than ST. Unlike ST, LB can hydrolyze casein ( $\beta$ -casein, preferentially) to peptides, using its cell wall bound proteinase (Argyle et al., 1976a, 1976b; Chandan et al., 1982). But to convert the resulting peptides to free amino acids, LB has to rely on ST, which has active peptidase activity.

### Collaborative Growth of ST and LB

Yogurt starter organisms display obligate symbiotic relationship during their growth in milk medium. The

rates of acid and flavor production by yogurt starter containing both ST and LB are considerably higher than by either of the two organisms grown separately (Loones, 1989; Robinson, 2003b). Although they can grow independently, they utilize each other's metabolites to effect remarkable efficiency in acid production. In general, LB has significantly more cell-bound proteolytic enzyme activity, producing stimulatory peptides and amino acids (especially, valine) from casein protein for ST. The relatively high aminopeptidase and cell-free and cell-bound dipeptidase activity of ST is complementary to strong proteinase and a low-peptidase activity of LB. ST in turn produces formic acid and removes oxygen, which stimulates the growth of LB. In addition, urease activity of ST produces  $\text{CO}_2$  which also stimulates LB growth. Concomitant with  $\text{CO}_2$  production, urease liberates ammonia, which acts as a weak buffer. Consequently, milk cultured by ST alone exhibits considerably low titratable acidity or high pH of coagulated mass. Formic acid formed by ST as well as by heat treatment of milk accelerates LB growth. During the early part of incubation, ST grows faster and outnumbers LB by 3–4 to 1. However, in the later stages, (at pH 5.0), ST growth slows down due to adverse effect of acid development and the numbers of LB gradually approach the population of ST. Therefore, acid production is accomplished in the first stage of incubation predominantly by ST, and in the second stage, mainly by LB.

Yogurt organisms are microaerophilic in nature. Heat treatment of milk drives out oxygen. It also destroys competitive flora. Furthermore, heat produced



**Figure 12.4.** *Lactobacillus acidophilus* cells under microscope. 1,000 × magnification.

sulfhydryl compounds tend to generate reducing conditions in the medium. Accordingly, rate of acid production in high heat-treated milk is considerably higher than in raw or pasteurized milk.

Viability of yogurt culture is an important attribute for consumer acceptance. The number of ST and LB cells in a sample of yogurt can be enumerated by standard International Dairy Federation procedure (IDF, 2003). Provided the fermentation conditions are optimal, the manufacturer of yogurt should achieve combined yogurt culture level of at least 100 million CFU/g of the product.

### ***Lactobacillus acidophilus***

*Lactobacillus acidophilus* is an adjunct culture commonly found in yogurt marketed in the United States and other countries with highly developed yogurt markets (Fig. 12.4).

There has been strong interest in the microflora of the mammalian gastrointestinal (GI) tract and its role in promoting health of the host (Chandan, 1989; Chandan, 2002; Fernandes et al., 1992; Takano and Yamamoto, 2003). Certain strains of this organism can be implanted in the colon after surviving the harsh conditions of low pH and surface active bile secretions in stomach and small intestine. These strains possess properties required of probiotics and are considered to be desirable dietary adjuncts. Probiotics are defined as live microorganisms, which contribute to the well being of human and animals by improving their microbial balance in the GI tract. Probiotics are discussed in Chapters 21 and 22. Consuming yogurt containing the probiotics allows continuous passage

of these organisms through the gut and the possibility of obtaining the benefits associated with them. Such benefits include improvement of gastrointestinal health and overall prevention of disease. Research studies show that *Lb. acidophilus* in the formula results in the improvement of nutritional profile for babies and protects them from diarrheal episodes and assists in lactose digestion. Further benefits of consuming the culture include control of intestinal infections in the very young and very old, cancer prevention, and enhanced competence of immune function (Chandan, 1999). For efficacy, desirable acidophilus level in yogurt should exceed one million CFU/g at consumption stage. Other lactobacilli occasionally found in yogurt are *Lactobacillus reuteri* and *Lb casei*.

### **Bifidobacteria**

Other probiotic cultures frequently found in yogurt are species of bifidobacteria (Fig. 12.5).

They are a group of Y-shaped anaerobic organisms. Some are tolerant to oxygen and can be successfully used as adjunct cultures in yogurt. They are characterized by the production of 2 moles of L (+) lactic acid and 3 moles of acetic acid from 2 moles of glucose. Commonly used bifidobacteria are: *Bifidobacterium bifidum*, *B. infantis*, *B. adolescentis*, and *B. breve*.

Although the adjunct organisms do not play an essential role in yogurt manufacturing, the yogurt fermented with these organisms generally tends to taste milder in terms of acidity and flavor. Also, their use can be declared on the label and ingredient statement to provide possible marketing advantage, particularly



**Figure 12.5.** Bifidobacteria cells under microscope. 1,000 × magnification.

for consumers familiar with the benefits of probiotic bacteria.

### Inhibiting Factors

As given in Chapter 6, proper selection of ST and LB strains is necessary to achieve maximum symbiosis between the two organisms. Certain abnormal milks (mastitic cows, hydrolytic rancidity in milk) are inhibitory to their growth. Seasonal variations in milk composition resulting in lower micronutrients (trace elements, nonprotein nitrogenous compounds) may affect starter performance. Natural inhibitors secreted in milk (lactoperoxidase thiocyanate system, agglutinins, lysozyme) are generally destroyed by proper heat treatment and therefore do not pose a problem. Antibiotics residues in milk and entry of sanitation chemicals (quaternary compounds, iodophors, hypochlorites, hydrogen peroxide) have profound inhibitory effect on the growth of yogurt starter.

Yogurt mixes designed for manufacture of refrigerated or frozen yogurt may contain appreciable quantities of sucrose, high fructose corn syrup, dextrose, and various DE corn syrups. The sweeteners exert osmotic pressure in the system, leading to progressive inhibition and decline in the rate of acid production by the culture. Being a colligative property, the osmotic-based inhibitory effect would be directly proportional to concentration of the sweetener and inversely related to the molecular weight of the solute. In this regard, solutes inherently present in milk solids-not-fat part of yogurt mix accruing from starting milk and added milk solids and whey products would also

contribute toward the total potential inhibitory effect on yogurt culture growth.

Phage infections and accompanying loss in the rate of acid production by lactic cultures results in flavor and texture defects, as well as major product losses in fermented dairy products. Serious economic losses have been attributed to phage attack. It is known that specific phages affect ST and LB, and that ST is relatively more susceptible than LB.

Yogurt fermentation process is relatively fast (3–4 hours using bulk starter and 5–6 hours using direct set starter cultures). It is improbable that both ST and LB would be simultaneously attacked by phages specific for the two organisms. In the likelihood of a phage attack on ST, acid production may be carried on by LB, causing little or no interruption in production schedule. However, it may affect the flavour characteristic. In fact, lytic phage may lyse ST cells spilling cellular contents in the medium, which could conceivably supply stimulants for LB growth. Also, the use of mixed strain yogurt starter cultures minimizes the risk of production failure from a single phage attack. This rationale may explain partially why the yogurt industry has experienced low incidence of phage problems. Nonetheless, most commercial strains of yogurt cultures have been phage typed. Specific phage sensitivity has been determined to facilitate starter rotation procedures as a practical way to avoid phage threats in yogurt plants. If the plant begins to experience longer fermentation times, the starter culture can be pulled out of production and replaced with a new starter that has different phage sensitivity.

The ST phage is destroyed by heat treatment of 74°C for 23 seconds. This phage proliferates much

faster at pH 6.0 than at pH 6.5 or pH 7.0. Methods used for phage detection include plaque assay, inhibition of acid production (litmus color change), enzyme immunoassay, ATP assay by bioluminescence, changes in impedance, and conductance measurement.

Phage problem in yogurt plants cannot be ignored. Accordingly, adherence to strict sanitation procedures and attention to proper air quality would insure prevention of phage attack.

Commercial production of yogurt relies heavily on fermentation ability and characteristics imparted by the starter. By controlling the culture strains and balance, the acidity and flavor development of yogurt can be optimized. Traditionally, the ratio between ST and LB was maintained between 1:1 and 3:2 in the finished yogurt. With current technology and today's market toward a more mild yogurt acid and flavor, the ratio is maintained to favor ST around 80–90% of the total yogurt culture.

In yogurt, the ratio of yogurt bacteria, production of lactic acid and aroma compounds, and body characteristics can be controlled to some degree by the following factors:

## YOGURT STRAIN SELECTION

The culture suppliers deliver frozen or freeze dried forms of cultures containing one or more types of selected strains which exhibit discreet properties. Several characteristics should be considered in selecting the strains which are best suited to meet the marketing objectives.

1. *Acid production during fermentation and pH stability during shelf life of yogurt.* At present, the US consumer shows a preference for yogurt with mild acidity (pH 4.2–4.4). A culture with strong acid production usually leads to overacidification during cooling and storage including shelf life. It is recommended to select a culture with weak to medium acid production ability. The use of mixed strain cultures with mild acid production is particularly important during the long shelf life (6–7 weeks) of the product. In particular, it assumes even more importance during interruption in the refrigeration chain starting from product delivery to grocery market ending with consumer refrigerated storage. The ability of acid production by the culture can be ascertained by plotting an acid curve (pH drop versus time).

2. *Flavor and aroma production.* The best method for determining the sensory quality is an organoleptic evaluation 24–48 hours after packaging and at the end of code. It is also customary to check the pH/titratable acidity and viscosity of the stored samples.
3. *Mucopolysaccharide production.* There are several strains producing polysaccharide or slime/ropiness within both ST and LB. Production of some polysaccharide by the culture is sometimes desirable to improve the consistency and viscosity of yogurt, particularly cup-set yogurt, yogurt with low solids or a “natural” product produced without the use of stabilizers. Excess ropiness should be avoided since it tends to mask flavor and aroma, and imparts slick mouth-feel and an undesirable stringy consistency. The intensity of polysaccharide production can be controlled from none to heavy. Also, the temperature of incubation affects the degree of polysaccharide production by the culture. Low incubation temperature appears to induce polysaccharide production.
4. *Proteolysis.* Protein hydrolysis favorably affects the digestibility of proteins in yogurt, but is detrimental to the consistency and taste. Certain strains of LB to avoid are those which produce bitter peptides from casein as a result of extensive protein degradation by proteolysis. ST exhibits very weak proteolysis in milk.
5. *Sugar resistance.* Depending on culture strain, the sensitivity of yogurt culture to sucrose concentration varies between 5% and 12%. In general, most cultures show significant inhibition at 8–10% sucrose concentration. However, there are specialized cultures, which can ferment yogurt mixes containing sucrose levels as high as 10–13% without a significant slow down in acid development.

## Ratio of ST and LB in the Culture

Depending on the type or form of yogurt culture used in yogurt manufacture, the ratio of its constituent bacteria may be controlled to enhance flavor, acid level, and texture.

**Fresh Bulk Starter.** Since bulk starter is produced and controlled by the yogurt manufacturer, it is more easily subject to variability in the culture-strain ratio. The manufacturer must strive to maintain consistent fermentation temperature and rate of cooling at the end of fermentation with bulk starter to assure

consistent yogurt production. However, the benefits that are obtainable from exact control of the culture-strain ratio are more difficult to accomplish at this level. This is one reason that most yogurt manufacturers use direct set starter cultures.

**Frozen Concentrated Cultures.** Using direct set frozen concentrated cultures provides more consistent yogurt production because the culture manufacturer controls the strain ratio. However, there are still some limitations to frozen mixed strain cultures due to their inability to utilize single-strain culture production. They have limited ability to “customize” cultures and control of downward shift in post fermentation pH; also they are unable to alter ratios of ST: LB, all of which have desirable effects on the final yogurt. Furthermore, they are sensitive to temperature abuse during shipping and storage.

**Freeze-dried or Pelletized cultures.** This newer technology has greatly enhanced the functional benefits of these direct set products. The use of direct set freeze-dried cultures provides the best opportunity to control strain ratios to optimize yogurt quality. This process combines defined single-strain culture with the blending of specific freeze dried or pelletized strains in precise ratios. The advantages consist of:

- Ability to obtain abnormal ratios of ST: LB (50:1 to 100:1) to produce mild yogurt.
- Exact control of viscosity and mouth feel.
- Exact control of tartness and flavor intensity.
- Control of post-processing acidification.
- Possibility of developing new value added yogurts containing bifidobacteria and *Lactobacillus acidophilus*.
- Better protection of multiple strains from bacteriophage attack.
- Provide customized strain blends for specific functionalities.

**Incubation Time.** In general, the longer the incubation time, the higher the numbers of LB and more chances of postprocessing acidification. Accordingly, caution must be exercised so that the LB does not produce too much lactic acid to make yogurt bitter and too sour.

**Incubation Temperature.** The optimum growth temperature for LB is 40–50°C and for ST, it is 35–40°C. The incubation temperature for yogurt culture ranges from 31°C to 45°C. However, most yogurt

base is incubated at 41–43°C. When time permits, it is possible to use a low temperature (32–37°C) with bulk starter for the production of vat incubated Swiss-style or blended-type yogurt. The lower temperature range produces a steady acid development and a slightly fuller body with fewer tendencies toward wheying off, grainy texture, and over-acidification. For the production of cup-set Sundae-style yogurt with bulk starter, it is preferable to use a temperature range of 41–43°C to provide efficient use of incubation room. At temperatures higher than 45°C, the finished product can experience more wheying-off problems, harsher flavors, and a grainy texture due to rapid acid development. This is because rapid acidification leads to a very dense aggregation of the protein particles with a corresponding decrease of bound water. Also, higher temperature (>45°C) favors the differential growth of LB resulting in undesirable culture ratio and flavor. When using direct set cultures, most manufacturers recommend a temperature range of 41–42°C to achieve the benefits of the specific culture ratio maintained by the supplier.

**Composition of the mix.** The total solids in the mix including sucrose content should be taken into account for selection of the culture.

**Amount of bulk starter.** The rate of inoculum changes the ratio of ST: LB in the finished yogurt, as shown below (Table 12.4).

Addition of too high level of culture may cause a defect in the structure and in the aroma of the finished yogurt. The optimum amount of bulk starter should be about 1.0–2.0% and may be increased to 4–5% if sugar content of the mix is high (10–11%).

Both incubation temperature and inoculation rate influence the structure and properties of yogurt gel. In general, the conditions favoring faster acid production (higher temperature and higher inoculation rate) tend to produce weak gel and more whey separation. It appears that weak yogurt gel and syneresis

**Table 12.4.** Effect of Inoculum Size of Bulk Starter on the Ratio of ST and LB.

%Inoculum	Ratio of ST/LB <sup>a</sup>
0.5	3:1
1.0	2:1
2.0	3:2
5.0	2:3

<sup>a</sup> incubation to 0.85% titratable acidity

are related to rearrangement of casein particles in the gel network and the rate of solubilization of colloidal calcium during fermentation (Lee and Lucey, 2004).

## CHANGES IN MILK CONSTITUENTS DURING YOGURT PRODUCTION

### Biochemical and Microbiological Changes During Fermentation

Conversion of milk base to yogurt is accompanied by intense metabolic activity of the fermenting organisms ST and LB. Yogurt is a unique product in that it supplies the consumer vital nutrients of milk, as well as metabolic products of fermentation along with abundant quantities of live and active yogurt cultures. As a result of culture growth, transformation of chemical, physical, microbiological, sensory, nutritional, and physiological attributes in basic milk medium is noted. Changes during fermentation are profound and many are relevant to the health attributes of yogurt.

**Carbohydrate.** Lactose content of yogurt mix is generally around 6%. During fermentation lactose is the primary carbon source resulting in approximately 30% reduction. However, a significant level of lactose (4.2%) remains unutilized. One mole of lactose gives rise to 1 mole of galactose, two moles of lactic acid, and energy for bacterial growth. Some strains of ST exhibit both  $\beta$ -galactosidase and phospho  $\beta$ -D-galactosidase activity. Therefore, these strains also use a phospho-enolpyruvate-phospho transferase system. Lactose is converted to lactose phosphate, which is hydrolyzed by phospho  $\beta$ -D-galactosidase to galactose-6-phosphate and glucose and that on glycolysis gives lactic acid (Chapter 6). Although lactose content is in excess in the fermentation medium, lactic acid build-up beyond 1.5% acts progressively as an inhibitor for further growth of yogurt bacteria. Normally, the fermentation period is terminated by temperature drop to 4°C. At this temperature, the culture is alive but its activity is drastically limited to allow fairly controlled flavor in marketing channels.

Lactic acid produced by ST is L (+) isomer, which physiologically is more digestible than the D (-) isomer produced by LB. It seems that the kidneys of small infants are not capable of handling D (-) lactic acid. Yogurt contains both isomers. The L (+) isomer is normally 50–70% of the total lactic acid. Normal consumption level of yogurt does not pose hazard from D (-) lactic acid, but relatively large

doses have been implicated in toxicity problems in small infants.

Lactic acid production results in coagulation of milk beginning at pH 5.2–5.3, at the point where the casein is first destabilized, and continues until completion at pH 4.6. During lactic acid production, there is a gradual removal of phosphorus and calcium that is bound to the stable casein particle as tricalcium phosphate. Texture, body, and acid flavor of yogurt owe their origin to lactic acid produced during fermentation.

Small quantities of organoleptic moieties are generated through carbohydrate catabolism, via volatile fatty acids, ethanol, acetoin, acetic acid, butanone, diacetyl, and acetaldehyde. (See Chapter 6). Homolactic fermentation in yogurt yields lactic acid as 95% of the fermentation output. Lactic acid acts as a preservative.

**Proteins.** Aggregation of whey proteins in yogurt has been observed (Argyle et al., 1976a,b), which contributes to the consistency of yogurt during storage. Hydrolysis of milk proteins is easily measured by liberation of  $-\text{NH}_2$  groups during fermentation. LB displays appreciable proteolytic activity in milk (Argyle et al., 1976a,b; Chandan et al., 1982). In his review, Loones (1989) reported that free amino groups double in yogurt after 24 hours. The proteolysis continues during the shelf life of yogurt, doubling free amino group again in 21 days storage at 7°C. The major amino acids liberated are proline and glycine. The essential amino acids liberated increase 3.8–3.9 fold during the storage of yogurt, indicating that various proteolytic enzymes and peptidases remain active throughout the shelf life of yogurt. The proteolytic activity of the two yogurt bacteria is moderate but is quite significant in relation to the symbiotic growth of the culture and production of flavor compounds.

**Lipids.** A weak lipase activity results in the liberation of minor amounts of free fatty acids, particularly stearic and oleic acids. Individual esterases and lipases of yogurt bacteria appear to be more active toward short-chain fatty acid glycerides than toward long-chain substrates (DeMoraes and Chandan, 1982). Since nonfat and low fat yogurts comprise the majority of yogurt marketed in the United States, lipid hydrolysis contributes little to the product attributes.

**Formation of Yogurt Flavor Compounds.** Lactic acid, acetaldehyde, acetone, diacetyl, and other

carbonyl compounds produced by fermentation constitute key flavor compounds of yogurt. Acetaldehyde content varies from 4 to 60 ppm in yogurt. Diacetyl varies from 0.1 to 0.3 ppm and acetic acid varies from 50 to 200 ppm. These key compounds are produced by yogurt bacteria. Certain amino acids (threonine, methionine) are known precursors of acetaldehyde. For example, threonine in the presence of threonine aldolase yields glycine and acetaldehyde. Acetaldehyde can arise from glucose, via acetyl CoA or from nucleic acids, via thymidine of DNA. Diacetyl and acetoin are metabolic products of carbohydrate metabolism in ST. Acetone and butane-2-one may develop in milk during prefermentation processing.

Several compounds contribute to yogurt aroma (Marsili, 2003). They include acetaldehyde, dimethyl sulfide, 2,3-butanedione, 2,3-pentanedione, 2-methylthiophene, 3-methyl-2-butenal, 1-octen-3-one, dimethyl trisulfide, 1-nonen-3-one, acetic acid, methional, (cis,cis)-nonenal, 2-methyl tetrahydrothiophen-3-one, 2-phenylacetaldehyde, 3-methylbutyric acid, caproic acid, guaiacol, benzothiozole and more.

**Synthesis of Oligosaccharides and Polysaccharids.** Both ST and LB are documented in the literature to elaborate different oligosaccharides in the yogurt-mix medium. As much as 0.2% (by weight) of mucopolysaccharides has been observed in 10 days of storage period. In stirred yogurt, drinking yogurt, and reduced-fat yogurt, potential contribution of exo-polysaccharides to impart smooth texture, higher viscosity, lower syneresis, and better mechanical handling is possible. Excessive shear during pumping destroys much of the textural advantage because the viscosity-imparting function of the mucopolysaccharides is not shear resistant. Most of the polysaccharides elaborated in yogurt contain glucose, galactose along with minor quantities of fructose, mannose, rhamnose, xylose, arabinose, or N-acetylgalactosamine, individually or in combination. Molecular weight is of the order of 0.5–1 million Daltons. Intrinsic viscosity range of 1.5–4.7 dl g<sup>-1</sup> has been reported for exo-polysaccharides of ST and LB (Zourari et al., 1992). The polysaccharides form a network of filaments visible under the scanning electron microscope. The bacterial cells are covered by part of the polysaccharide and the filaments bind the cells and milk proteins. Upon shear treatment, the filaments rupture off from the cells, but maintain links with casein micelles. Ropy strains of ST and LB are

commercially available. They are especially appropriate for stirred yogurt production.

It is conceivable that some of the exopolysaccharides exert physiological role in human nutrition because of their chemical structure resembling dietary fiber.

**Other Metabolites.** Bacteriocins and several other antimicrobial compounds are generated by yogurt organisms. A bacteriocin called bulgarican is elaborated by LB that has been shown to possess antagonistic property toward the growth of several spoilage bacteria (Reddy et al., 1984). Similarly, *Lb. acidophilus* produces acidophilin, which is shown to exhibit a wide spectrum activity against both Gram-positive and Gram-negative bacteria (Shahani et al., 1972). Benzoic acid (15–30 ppm) in yogurt has been detected, which is associated with metabolic activity of the culture (Chandan et al., 1977). These metabolites tend to exert preservative effect by controlling the growth of contaminating spoilage and pathogenic organisms gaining postfermentation entry. As a result, the product attains extension of shelf life and reasonable degree of safety from food borne illness.

**Cell Mass.** As a consequence of fermentation, yogurt organisms multiply to a count of 10<sup>8</sup> to 10<sup>10</sup> CFU g<sup>-1</sup>. Yogurt bacteria occupy some 1% of volume or mass of yogurt. These cells contain cell walls, enzymes, nucleic acids, cellular proteins, lipids, and carbohydrates. Lactase or  $\beta$ -galactosidase has been shown to contribute a major health-related property to yogurt. Clinical studies have concluded that live and active culture containing yogurt can be consumed by several millions of lactose-deficient individuals without developing gastrointestinal distress or diarrhea.

**Minerals.** Yogurt is an excellent dietary source of calcium, phosphorus, magnesium, and zinc in human nutrition. Research has shown that bioavailability of the minerals from yogurt is essentially equal to that from milk. Since yogurt is a low-pH product compared to milk, most of calcium and magnesium occurs in ionic form.

The complete conversion from colloidal form in milk to ionic form in yogurt may have some bearing on the physiological efficiency of utilization of the minerals.

**Vitamins.** Yogurt bacteria during and after fermentation affect the B-vitamin content of yogurt. The processing parameters and subsequent storage



conditions influence the vitamin content at the time of consumption of the products. Incubation temperature and fermentation time exert significant balance between vitamin synthesis and utilization by the culture. In general, there is a decrease of vitamin B<sub>12</sub>, biotin, and pantothenic acid and an increase of folic acid during yogurt production. Nevertheless, yogurt is still an excellent source of vitamins inherent to milk.

### Postfermentation Changes

These changes refer to the shelf life period of yogurt following manufacture.

**Refrigerated Yogurt and Drinkables.** The chain comprised of distribution, marketing, and retail leading to eventual consumption of product by the consumer may require 4–7 weeks of shelf life. Nutritional quality is reasonably preserved by temperatures of 4–6°C in this chain. Maintenance of product integrity by appropriate packaging is achieved. However, a slight increase in acidity (of the order of 0.2%) is noticeable during this period. Viability of the yogurt culture is also slightly reduced by one log cycle. These changes are relatively minor compared to the changes observed during fermentation.

**Soft Serve Mix and Soft Serve Yogurt.** Soft serve mix may be marketed refrigerated or frozen until dispensed as soft serve frozen yogurt by the operator. If marketed refrigerated, changes similar to those in refrigerated yogurt are projected in the mix until extrusion through the soft serve freezer. If marketed frozen, the mix has to be thawed prior to extrusion. A loss of 1–2 log cycles in viable cell counts of yogurt culture may be noticed by the freeze-thaw cycle. Furthermore, destruction of cell viability is possible during the freezing process through the soft serve freezer. Other than viable cell counts, no significant changes are known.

**Hard Pack Frozen Yogurt.** Shelf-life requirements of 6–12 months are normal for this type of yogurt. A loss of 1–2 log cycles in viable counts of yogurt bacteria may be attributed to the freezing process of the mix. During the shelf-life storage conditions, especially fluctuation in temperatures could have a deleterious effect on the viability and activity of yogurt cultures. The formation of crystals during frozen state conceivably may rupture bacterial cells, reducing live cell counts progressively.

## REFERENCES

- Argyle P, Jones N, Chandan RC, Gordon JF. 1976a. Aggregation of whey proteins during storage of acidified milks. *J. Dairy Research*, 43:45–51.
- Argyle P, Mathison GE, Chandan RC. 1976b. Production of cell-bound proteinase by *Lactobacillus bulgaricus* and its location in the bacterial cell. *J. App. Bact.* 41:175–184.
- Chandan RC (Ed). 1989. *Yogurt: Nutritional and Health Properties*. National Yogurt Association, McLean, VA.
- Chandan RC. 1997. *Dairy-Based Ingredients*. Eagan Press, St. Paul, Minnesota, MN.
- Chandan RC. 1999. Enhancing market value of milk by adding cultures. *J. Dairy Sci.* 82:2245–2256.
- Chandan RC. 2002. Symposium: Benefits of live fermented milks: Present diversity of products. In: *Proceedings of International Dairy Congress, Paris, France* [Available in CD Rom].
- Chandan RC. 2004. Dairy: Yogurt. In: JS Smith, YH Hui (Eds), *Food Processing: Principles and Applications*. Blackwell Publishing, Ames, IA. pp. 297–328.
- Chandan RC, Argyle PJ, Mathison GE. 1982. Action of *Lactobacillus bulgaricus* protease preparations on milk proteins. *J. Dairy Sci.* 65:1408–1413.
- Chandan RC, Gordon JF, Morrison A. 1977. Natural benzoate content of dairy products. *Milchwissenschaft* 32(9):534–527.
- Chandan RC, Shahani KM. 1993. Yogurt. In: YH Hui (Ed), *Dairy Science and Technology Handbook*, Vol. 2. VCH Publishers, New York, pp. 1–56.
- Chandan RC, Shahani KM. 1995. Other fermented dairy products. In: G Reed, TW Nagodawithana (Ed), *Biotechnology*, 2nd ed., Vol. 9, VCH Publishers, Weinheim, Germany, pp. 386–418.
- DeMoraes J, Chandan RC. 1982. Factors influencing the production and activity of *Sterptococcus thermophilus* lipase. *J. Food Sci.* 47:1579–1583.
- Fernandes CF, Chandan RC, Shahani KM. 1992. Fermented dairy products and health. In: BJB Wood (Ed), *The Lactic Acid Bacteria*, Vol. 1. Elsevier, New York, pp. 279–339.
- International Dairy Federation. 2003. *Yogurt: Enumeration of Characteristic Organisms-Colony Count Technique at 37 C*. IDF Standard No. 117A, Brussels, Belgium.
- Lee WJ, Lucey JA. 2004. Structure and physical properties of yogurt gels: Effect of inoculation rate and incubation temperature. *J. Dairy Sci.* 87:3153–3164.
- Loones A. 1989. Transformation of milk components during yogurt fermentation. In: RC Chandan (Ed),

- Yogurt: Nutritional and Health Properties. National Yogurt Association, McLean, VA, pp.95–114.
- Marsili R. 2003. Flavors and off-flavors in dairy products. In: H Roginski, JW Fuquay, PF Fox (Eds), *Encyclopedia of Dairy Sciences*, Vol. 2. Academic Press, New York, pp. 1069–1081.
- Nauth KR. 2004. Yogurt. In: YH Hui, L Meunier-Goddik, AS Hansen, J Josephsen, W-K Nip, PS Stanfield, F Toldra (Eds), *Handbook of Food and Beverage Fermentation Technology*. Marcell Decker, New York, pp. 125–145.
- Reddy G, Shahani KM, Friend BA, Chandan RC. 1984. Natural antibiotic activity of *Lactobacillus acidophilus* and *bulgaricus* III. Production and Partial Purification of Bulgarian from *Lactobacillus bulgaricus*. *Cultured Dairy Prod. J.* 19(5):7–11.
- Robinson RK. 2003a. Yogurt types and manufacture. In: H Roginski, JW Fuquay, PF Fox (Eds), *Encyclopedia of Dairy Sciences*, Vol. 2. Academic Press, New York, pp. 1055–1058.
- Robinson RK. 2003b. Yogurt, role of yogurt cultures. In: H Roginski, JW Fuquay, PF Fox (Eds), *Encyclopedia of Dairy Sciences*, Vol. 2. Academic Press, New York, pp. 1059–101063.
- Sellars RL. 1989. Health properties of yogurt. In: RC Chandan (Ed), *Yogurt: Nutritional and Health Properties*. National Yogurt Association, McLean, VA, pp. 115–144.
- Shah N. 2003. Yogurt: The product and manufacture. In: B Caballero, L Truco, PM Finglas (Eds), *Encyclopedia of Food Sciences and Nutrition*, Vol. 10, 2nd ed. Academic Press, New York, pp. 6252–6259.
- Shahani KM, Vakil JR, Chandan RC. September 5, 1972. Antibiotic acidophilin and process for preparing the same. United States Patent 3,689, 640.
- Surono I, Hosono A. 2003. Starter cultures. In: H Roginski, JW Fuquay, PF Fox (Eds), *Encyclopedia of Dairy Sciences*, Vol. 2. Academic Press, New York, pp. 101023–101028.
- Takano T, Yamamoto N. 2003. Health aspects of fermented milks. In: H Roginski, JW Fuquay, PF Fox (Eds), *Encyclopedia of Dairy Sciences*, Vol. 2. Academic Press, New York, pp. 1063–1069.
- Vedamuthu ER. 1991. The yogurt story—past, present and future. *Dairy, Food Environ. Sanit.* 11:202–203, 265–276, 371–374, 513–514.
- Zourari A, Accolas J-P, Desmazeaud MJ. 1992. Metabolism and biochemical characteristics of yogurt bacteria: A review. *Le Lait.* 72(1):1–34.

# 13

## Manufacture of Various Types of Yogurt

*Ramesh C. Chandan and Kevin R. O'Rell*

- Introduction
- General Procedures Applicable to All Categories
  - Packaging Equipment and Materials
  - Production of Yogurt Starters
- Yogurt Styles and Definitions
- Market Statistics on Yogurt Trade
- Manufacturing Processes for Major Types of Yogurt
- General Manufacturing Procedures
  - Plain Yogurt
  - Fruit-Flavored Yogurt
  - Vanilla-Flavored Yogurt
  - Natural Yogurt
  - Organic Yogurt
  - Yogurt Drink/Smoothies
  - Yogurt Whips/Mousse
  - Concentrated/Greek-Style/Strained Yogurt
  - Frozen Yogurt
- Postculturing Heat Treatment
- Acknowledgment
- References
- Bibliography

### INTRODUCTION

The yogurt market is highly sophisticated, complex, and diverse. The evolution of the yogurt market has been dictated by market forces and consumer demands. Different types or styles or categories (and subgroups) of yogurt have entered the marketplace in response to consumer preference, changing lifestyles, and dietary adjustments. The first major change in the yogurt market was the entry of “flavored yogurts.” Under this category different styles were introduced. This was followed by subcategories that offered dietary choices, for example, full-fat, low-fat, and fat-free types. Changing lifestyles gave rise to liquid yogurts and “snacking types” and “on-the-go tubular types.” The emphasis on “healthy” and

“natural” foods gave rise to entirely specialized groups of products. These products will be discussed in this chapter.

The topics included in this chapter will be discussed under the following headings: (a) General manufacturing procedures applicable to all categories, (b) yogurt types, styles, subcategories, and definitions, (c) market statistics on yogurt trade, and (d) manufacturing process for major yogurt categories.

### GENERAL PROCEDURES APPLICABLE TO ALL CATEGORIES

As discussed in Chapter 3, in the United States, a yogurt plant must be a Grade A milk processing facility. All the equipment must conform to Grade A regulations for processing (FDA, 1999). The equipment for transportation, handling, and storage must be made of nontoxic, smooth, nonabsorbent, and corrosion-resistant materials. The construction of the processing equipment such as tanks, pumps, valves, heat exchangers, piping, and others must be designed for cleaning in place (CIP) and sterilization. Grade A milk and cream must be stored at 4°C in vertical/silo tanks for a period not to exceed 72 hours. The storage vessels must be equipped with agitators for slow agitation to prevent the separation of cream. One more legal requirement is the provision for accurate temperature-indicating thermometers and an appropriate recording system with charts.

### PACKAGING EQUIPMENT AND MATERIALS

Most plants attempt to synchronize the packaging lines with the termination of the incubation period.

Generally, textural defects in yogurt products are caused by excessive shear during pumping or agitation. Therefore, positive drive pumps are preferred over centrifugal pumps for moving the product after culturing or ripening. For adding fruit to the product, it is advantageous to use a fruit feeder system. Various packaging machines of suitable speeds (up to 400 cups/minute) are available to package various kinds and sizes of yogurt products. More details of packaging materials and containers for yogurt are given in Chapter 8.

Yogurt is generally packaged in plastic containers varying in size from 4 to 32 oz. Yogurt packaged in tubes weighs even less per tube (2 to 3 oz). The machines involve volumetric piston filling. The product is sold by weight and the machines delivering volumetric measure are standardized accordingly. The pumping step of fermented and flavored yogurt base exerts some shear on the body of yogurt. In some cases, specific shape of the cup characterizes certain product branding. Some plants use preformed cups. The cup may be formed by injection molding—a process in which beads of plastic are injected into a mold at high temperature and pressure. In this type of packaging, a die-cut foil lid is heat sealed on to the cups. Foil lids are cut into circles and procured by the plants from a supplier along with preformed cups. A plastic over-cap may be used. In some cases, partially formed cups are procured and assembled at the plant. Some other plants use roll stock, which is used in form–fill–seal system of packaging. In this case, cups are fabricated in the plant by a process called thermoforming. This involves ramming a plug into a sheet of heated plastic. Multipacks of yogurt are produced by this process. Following the formation of cups, these are filled with appropriate volume of yogurt and are heat-sealed with foil lid. These are then placed in cases and transferred to a refrigerated room for cooling and distribution. For breakfast yogurt, a mixture of granola, nuts, chocolate bits, dry fruits, and cereal is packaged in a small cup and sealed with a foil. Subsequently, the cereal cup is inverted and sealed on the top of yogurt cup. This package is designed to keep the ingredients isolated from yogurt until the time of consumption. This system helps to maintain crispness in cereals and nuts, which otherwise would become soggy or interact adversely if mixed with yogurt at the plant level, i.e., during packaging.

Some interesting innovations in yogurt packaging include spoon-in-the-cup lid and squeezable tubes. The former adds convenience in eating yogurt, while

the squeezable tubes add convenience, portability, and play value to children. In addition, yogurt in tubes is freeze–thaw stable, which adds another dimension of convenience and versatility of its use.

## PRODUCTION OF YOGURT STARTERS

The first step in the manufacture of yogurt is the preparation of starter. The same procedures for starter preparation are used regardless of the type or style of yogurt being produced in the plant.

The starter is a crucial component in the production of high quality yogurt delivering consistent quality attributes desired by consumers. The movement of personnel assigned to starter room and traffic between the starter room and the rest of production area should be strictly restricted. An effective sanitation program including filtered air and positive pressure in the culture and fermentation area should significantly control airborne contamination. The result would be controlled fermentation time and consistently high-quality product (Chandan, 2004; Chandan and Shahani, 1993).

As discussed in Chapters 6 and 11, yogurt cultures are available from various culture suppliers as frozen concentrates or freeze-dried concentrates for direct inoculation into fermentation tanks. These offer convenience of use and reliability of performance and functionality of the culture. However, for economic reasons, large manufacturers of yogurt may prefer to make their own bulk starters.

The characterizing culture for yogurt manufacture consists of *Lactobacillus delbrueckii* subsp. *bulgaricus* (LB) and *Streptococcus thermophilus* (ST). Frozen/freeze-dried culture concentrates available from commercial culture suppliers can be used for direct inoculation into yogurt mix or making bulk starters. Reasons for their use include convenience, ease of handling, dependable quality, and reliable activity. The frozen concentrates are shipped frozen in dry ice and stored at the plant in special freezers at  $-40^{\circ}\text{C}$  or below for a limited period of time specified by the culture supplier. Presently, the freeze-dried concentrates are preferred by many yogurt manufacturers because these can be stored in a refrigerator (freezer) and do not require dry ice for shipping.

The starter area is segregated in most yogurt plants for maintaining a sanitary environment. It should have positive pressure and HEPA-filtered (capturing particles larger than  $0.3\ \mu\text{m}$ ) air supply to prevent possible contamination from airborne bacteria and bacteriophages.

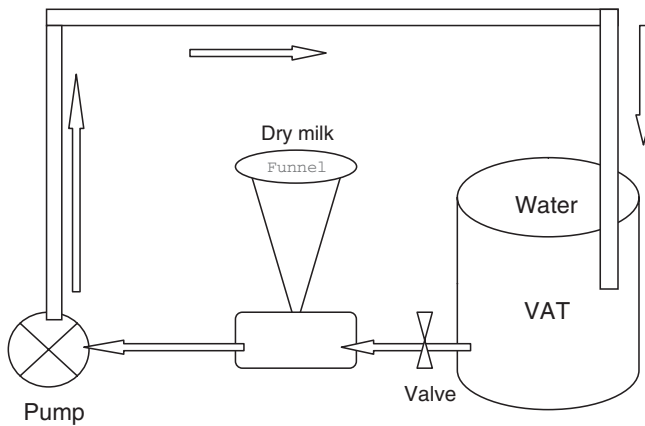

**Figure 13.1.** Equipment set up for reconstitution of nonfat dry milk (NFDM) using a “powder cone”/funnel/hopper. The vat on the right contains measured volume of water. The weighed NFDM is deposited in the cone and the valve on the vat is opened. The pump on the left circulates the reconstituted milk until all the dry milk is dispersed.

For making bulk starter, Grade A skim milk is used. In most yogurt plants, it is Grade A, antibiotic-free, low-heat nonfat dry milk (NFDM). The dry milk is reconstituted in water and contains 9–12% solids. Mainly, two types of equipment are used for reconstitution. One is cone/funnel/hopper type of set up (see Fig. 13.1). The other type of equipment is a high shear blender in which all the ingredients are weighed in and blended together (Fig. 13.2).

The practice of using fresh skim milk or pretested reconstituted NFDM reduces the risk of off-flavors being transferred to the finished yogurt from untested or held-over milk used for making starter. Pretesting for the absence of inhibitory principles (antibiotics, sanitizers) is also advisable to insure desirable growth of the starter in the medium. Another quality attribute preferred with the NFDM for starter preparation is low-heat powder with not less than 6.0 mg of whey protein nitrogen/g of powder (Chapters 10 and 11).

The starter medium is never fortified with growth activators like yeast extract, beef extract, or protein hydrolysates because they tend to impart undesirable flavor to the starter, which would be carried over to yogurt. Additionally, kosher requirements would preclude the use of such ingredients. Bulk starter is usually made in specially designed aseptic tanks.

Figure 13.3 outlines the process for making bulk starters. Following addition of fresh skim milk or reconstitution of NFDM in water in the tank, the medium is heated to 90–95°C and held for 30–60 minutes. Such a heat treatment improves the growth properties of the medium by destroying original microorganisms and bacteriophages, and

facilitates the denaturation of the milk proteins and expulsion of dissolved oxygen. The medium is then cooled in the tank to the inoculation temperature, 42–43°C. During cooling, the air drawn into the vat should be free of airborne contaminants (phages, bacteria, and yeast and mold spores). Accordingly, use of proper filters (e.g. HEPA) on the tanks to filter-sterilize incoming air is desirable.

The next step is inoculation of frozen or lyophilized (freeze-dried) culture concentrate (Fig. 13.4). Instruction for handling the culture concentrate as prescribed by the supplier should be followed carefully. When using the frozen culture concentrate, the can is thawed by placing it in cold or lukewarm water containing a low level of sanitizer, preferably chlorine (quaternary ammonium compounds have a residual effect), until the contents are partially thawed. The culture cans are emptied into the starter vat as aseptically as possible and bulk starter medium is agitated sufficiently to facilitate mixing and achieving uniform dispersion of the culture. For freeze-dried culture, the contents of the container are emptied into the medium taking due precautions not to introduce contamination from improper handling, followed by sufficient agitation time, usually 20–30 minutes, assuring proper dispersion of the culture.

Incubation period for yogurt bulk starter ranges from 4 to 6 hours and the proper temperature of 42–43°C is maintained by holding hot water in the jacket of the tank. The fermentation must be quiescent (i.e., lack of agitation and vibrations) to avoid phase separation in the starter following incubation. The progress of fermentation is monitored by titratable

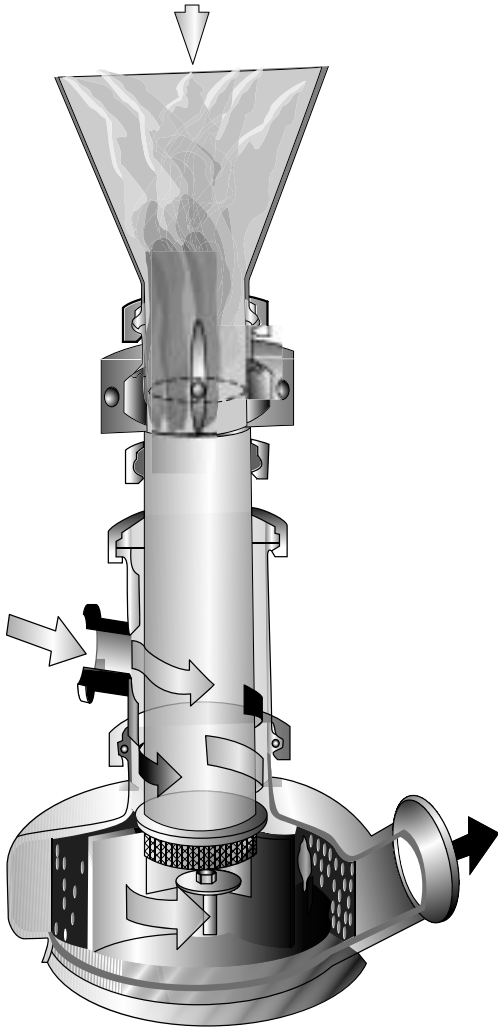

**Figure 13.2.** High shear mixer for blending dry milk and water. Courtesy: Tetra Pak.

acidity/pH measurements at regular intervals. When the titratable acidity is 0.85–0.90% (or the pH is 4.4–4.5), the fermentation is terminated by turning the agitators on and replacing warm water in the jacket with chilled water. If the culture is going to be used within next 4–6 hours, circulating chilled water is used to drop the temperature of the starter to 10–12°C. If the starter will not be used within next 6 hours, it is advisable to drop the temperature to 4–5°C. The starter is now ready to use. Occasionally, a microscopic examination of the culture

smear (stained with methylene blue dye) is helpful in determining the physiological condition of the starter bacteria by observing the cell morphology as well as the ST/LB ratio. In the earlier literature, a ratio of 1:1 was considered desirable, but more recent trend is in favor of ST predomination (66–80%). An organoleptic examination is also helpful to detect any unwanted flavors in the starter.

## YOGURT STYLES AND DEFINITIONS

To assist in the understanding of various types of yogurt available in the market, Fig. 13.5 shows classification of the yogurt category. We will discuss their manufacture later. All types of yogurts may be labeled nonfat, low fat, or full fat, depending on the milk fat content of yogurt mix. Further, they may be prepared for consumption by toddlers, children, or adults.

Table 13.1 lists various types of yogurt found in the market in North America and Europe.

## MARKET STATISTICS ON YOGURT TRADE

In the United States, the sale of refrigerated yogurt category in 2004 is \$2.7 billion and is growing. Its sales are up by 6% compared to that in 2003. Blended/Swiss style and single-serve product forms are the primary product types. The blended style constitutes 74% of the category, while fruit-on-the-bottom (FOB) style has shrunk to 8%. Drinkable yogurts form 12% of the market, whereas plain and yogurt with toppings constitute 5% and 1%, respectively. Compared to the previous year, the blended yogurt, plain, and drinkables grew by 1%, 5.7%, and 97.1%, respectively. The category decline was 13.6% in FOB and 3.9% in yogurt with toppings, respectively. The yogurt market is dominated by flavored varieties and plain yogurt is only a fraction of the yogurt sold. Among the flavored varieties, 10 flavors account for 70% of the category volume.

Organic/natural yogurt experienced dramatic growth accounting for 22% sales increase in yogurt sold in regular grocery stores and 17% increase in natural yogurt sold in natural food grocery stores. In the refrigerated yogurt category based on packaging, the single serve package accounts for 62% with 2.8% growth over previous year. Multipacks are gaining in popularity and have 20% share of the market with a growth of 21.3% over the previous year. Large multi-serve packs have 10% of the market and have grown

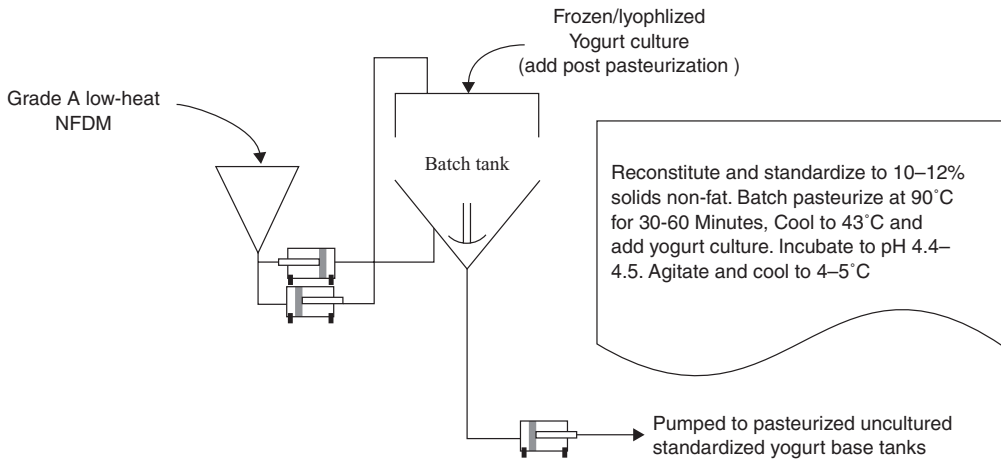

**Figure 13.3.** Preparation of bulk starter in yogurt plant.

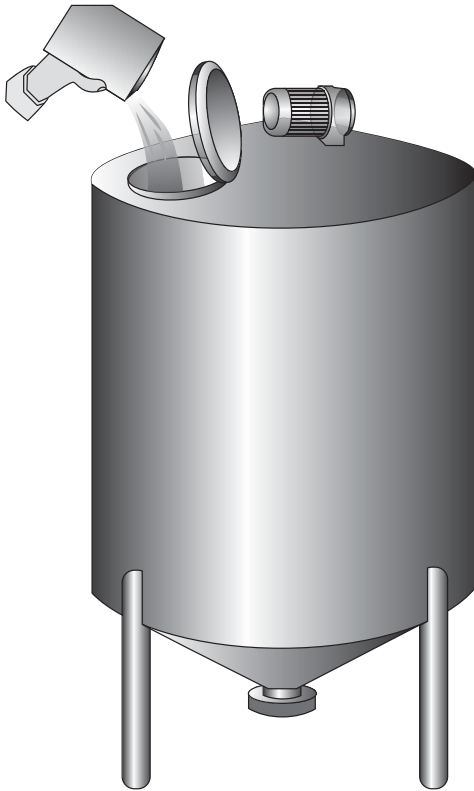

**Figure 13.4.** Inoculation of freeze-dried culture concentrate during starter preparation. Courtesy: Tetra Pak.

7% over the previous year. Multipack tube market is 8% and its share has declined 1.8% as compared to previous year.

The total U.S. market for yogurt may be divided into three categories based on the fat content: non-fat, low fat, and full fat. All types of yogurt (Table 13.1) are divided into one of these categories based on milk fat content and the code of federal regulations standard of identity Title 21, Parts 131.200–131.206 (FDA, 2003). In the year 2004, the estimated sales of all types of full fat yogurt were \$262.1 million (increase of 1.7% as compared to 2003), the low fat yogurt sales were \$1,506.2 million (increase of 3.9%), and the fat-free/nonfat sales were \$901.3 million (increase of 10.9%) (see Table 13.2).

Nonfat yogurt is available as plain, sugar sweetened with vanilla or with fruit preparations or with fruit flavor only. A significant share of nonfat yogurt is light yogurt, which is sweetened with aspartame and/or other high-intensity sweeteners.

The market share of full fat, low fat, and nonfat in all styles of yogurt is illustrated in Fig. 13.6. Full fat yogurt has declined from 30% in 1985 to 10% in 2004, whereas in the same period, low fat yogurt declined from 66% to 56% and nonfat yogurt increased from 4% to 34%.

Figure 13.7 shows recent trend in full fat, low fat, and nonfat yogurt with respect to plain, blended, and FOB styles. At present, the blended/Swiss-style yogurt in the market consists of 11% full fat, 56% low fat, and 33% fat-free. The corresponding data for FOB yogurt type is 2% full fat, 86% low fat, and

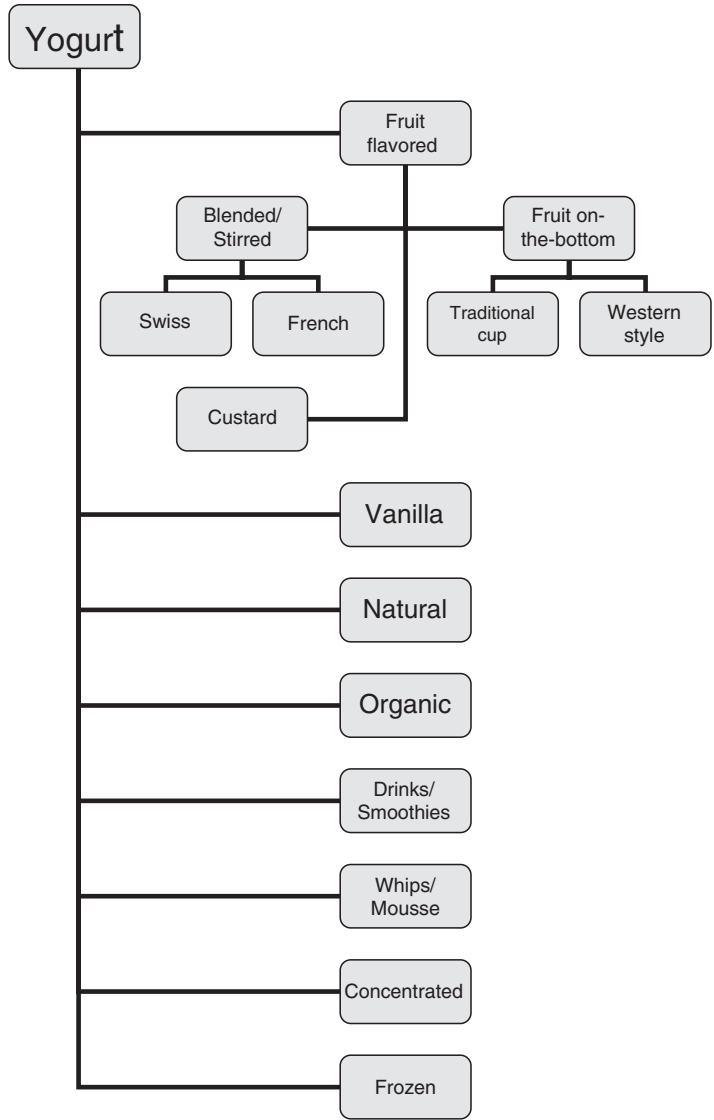

**Figure 13.5.** Classification of various types of yogurt.

12% fat-free; while for plain yogurt it is 19% full fat, 31% low fat, and 50% is fat-free.

Lately, an extra-creamy yogurt has been introduced in the market. It contains fat content of the order of 4.0–4.5%, but would still be characterized as full fat yogurt by US Federal standards and market data tracking. This type of yogurt is characterized by its mild and creamy taste. Also available in the

market are whipped yogurts, which are full fat yogurts with a mild and sweet flavor and a foamy/fluffy texture. Several yogurts are designed for children. The attributes preferred by children (darker colors, enhanced sweetness, fruit purees without fruit integrity, thicker custard-like consistency) are built into such products. Yogurt drinks and smoothies are gaining market growth (Fig. 13.8).



**Table 13.1. Major Styles of Commercial Yogurts and Their Definition**

Style of Yogurt	Definition
Plain	Unflavored yogurt may be cultured in individual cups or cultured in a vat and dispensed into cups. No sugar is added to the formulation.
Fruit flavored	This type of yogurt is cultured in a vat or bulk and then flavored with a fruit preparation. Styles consist of blended/stirred and fruit-on-the-bottom.
Blended/stirred	In this style, fermented base containing sugar is blended with fruit preparation to disperse the fruit throughout the body of the yogurt. This style is further subdivided into Swiss- and French-style blended yogurt.
Swiss/blended	The fermented base is blended with fruit preparation to disperse the fruit throughout and packaged. On cooling, the product thickens and viscous custard-like texture is formed. The product contains stabilizers to assist in texture formation.
French/blended	Similar to Swiss style, but is characterized by a distinctly less viscous texture. Generally contains no stabilizers other than milk solids.
Light	Nonfat yogurt in which no sugar is added to yogurt base and high intensity sweeteners are used, resulting in significant reduction in calories.
Lo carb	Nonfat yogurt in which high intensity sweeteners are used in place of sugar. Fruit preparations are replaced with fruit flavors. Lactose content of nonfat milk is reduced by membrane processing. Milk protein concentrate and whey protein isolate are used to reduce the lactose content further.
Custard	Designed for children. It has a very viscous body resembling custard. Only fruit puree/juice is used for fruit flavoring. Usually, fermented in the cup.
Sundae/fruit-on-the-bottom	The fruit is deposited on the bottom of the cup, followed by a top layer of unfermented or fermented yogurt. Before consumption it requires blending to mix the fruit preparation.
Cup-incubated traditional sundae	The fruit is layered in the bottom of the cup and <i>unfermented</i> (inoculated) yogurt mix is deposited on the top. The cups are incubated individually to desired pH and cooled quickly to control further acid production.
Vat-incubated sundae	The fruit is layered in the bottom of the cup and white <i>fermented</i> yogurt base is deposited on the top. On cooling, the texture of the top layer is developed.
Western sundae	The fruit is layered on the bottom of the cup, and yogurt base <i>fermented</i> in vat is deposited on the top. It is characterized by special formulation of yogurt base in that corresponding color and flavor of the fruit-on-the-bottom is included in the top layer.
Vanilla flavored	The yogurt may be cup- or vat-incubated. Following fermentation, yogurt base is mixed with vanilla flavor.
“Natural”	Contains natural ingredients only. Generally, it does not contain stabilizers, artificial colors, or flavors.
Organic	Contains only ingredients certified as organic.
Yogurt drink/smoothie	Drinkable yogurt is fluid enough to drink. May be sweet and fruit flavored. Smoothies are drinking yogurt, often fortified with minerals and vitamins, prebiotics and probiotics. Some may be designed as a meal replacement.

*Continued*

**Table 13.1. (Continued)**

Style of Yogurt	Definition
Whips/mousse	This yogurt contains up to 50% (by volume) of inert gas/air to create a fluffy/light texture.
Yogurt with topping	Sweetened fermented base is packaged separately in a cup and sealed. Topping consisting of cereals, nuts, or fruits and is packaged in a smaller cup and sealed. Then the smaller cup is inverted and placed on the larger yogurt cup. The two cups are tied together by plastic wrap. The consumer mixes the toppings prior to consumption.
Concentrated/Greek/strained	It is relatively high in milk fat and milk solids-not-fat. It has a creamy texture and mild flavor as a result of whey removal by centrifugal/membrane separation or by straining through cloth.
Frozen	The fermented yogurt is blended with low fat/nonfat ice cream to obtain pH of 6.0. The yogurt mix is then extruded through a soft serve machine at 50% overrun and garnished with nuts and other foods to get soft serve frozen yogurt. If the extruded frozen yogurt is hardened like ice cream, it is called hard frozen yogurt.

**Table 13.2. Estimated Sales of Full Fat, Low Fat, and Nonfat Yogurts in the Overall United States Refrigerated Yogurt Market During 2004**

	Type of Yogurt		
	Full Fat	Low Fat	Fat-Free
Sales <sup>a</sup>	262.1	1,506.2	901.3
Change <sup>b</sup>	+1.7%	+3.9%	+10.9%

<sup>a</sup> Million dollars.

<sup>b</sup> Against year 2003.

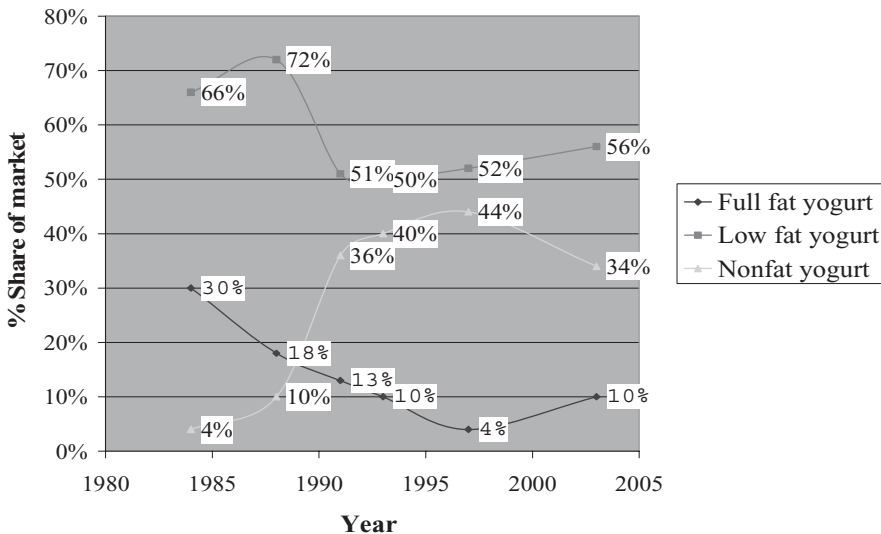

**Figure 13.6. Recent trends in the U.S. market for full fat, low fat, and nonfat yogurts.**

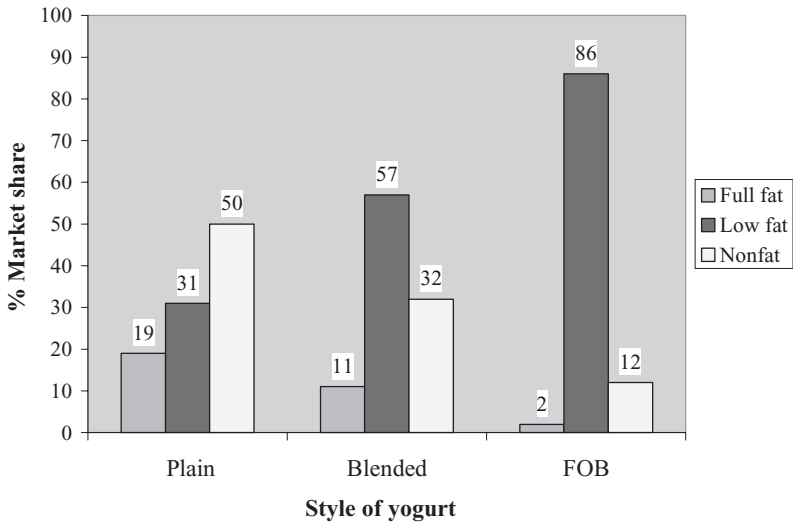

**Figure 13.7.** Current market share of major styles of full fat, low fat, and nonfat yogurts with respect to plain, blended, and fruit-on-the-bottom varieties in the United States.

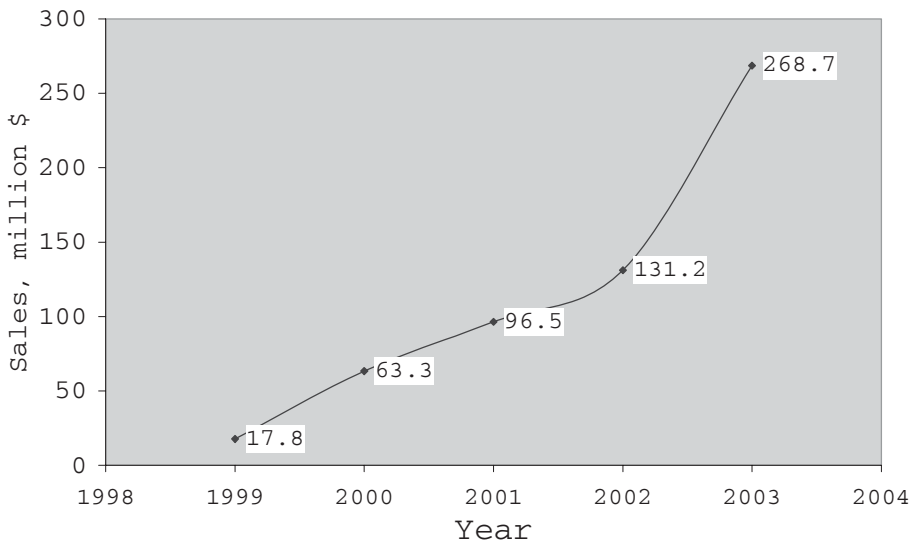

**Figure 13.8.** Recent trend in the sales of yogurt drinks.

## MANUFACTURING PROCESSES FOR MAJOR TYPES OF YOGURT

The sequence of stages for yogurt manufacture is summarized in the previous Chapter 12 in Table 12.1. The formulation of yogurt varies considerably, depending on the style that is being produced. Nevertheless, the first step in the manufacture of yogurt is basically the same regardless of the style made. The starting step is to make yogurt mix by blending various ingredients. In this step, the formulation for a particular yogurt production is calculated in terms of the weight/volume of each ingredient for the batch size desired. At the time of manufacture, the liquid dairy ingredients like condensed milk, cream, whole milk, low fat milk, or skim milk are pumped into a processing vat. Next, NFDM solids may be added with the aid of powder blender equipment consisting of a funnel and a circulating pump (Fig. 13.1) or a high shear type blender (Fig. 13.2).

The product is then pasteurized and then subjected to high heat treatment to facilitate the growth of yogurt culture and to denature the milk protein aiding in the formation of desirable body and texture in the yogurt. The mix is homogenized, cooled to incubation temperature, and inoculated with the culture. From this point, the process varies with the style of yogurt that is being produced. The yogurt mix is either left in the fermentation vat for incubation or pumped into individual cups and placed in the incubation room. The flavoring system used will also vary according to the style.

The following are the critical physical, chemical, and biological steps in yogurt technology.

1. *Blending*: In the mix preparation, it is necessary to homogeneously disperse and dissolve the dry ingredients in the liquid phase obtaining a uniform mixture. The following are important considerations during this step:
  - (a) Sufficient agitation in the mix tank.
  - (b) Incorporate dry ingredients using a pump and funnel set-up or preferably a special high shear blending equipment.

- (c) Minimize air incorporation.
- (d) Perform prepasteurization tests to conform to chemical composition standards of butterfat and solids.

(e) Restandardize, if necessary.

2. *Pasteurization and Heat Treatment*: Generally, pasteurization of milk is carried out with the purpose of killing all the pathogenic microorganisms, and significantly reducing the majority of other organisms present and inactivating the inherent enzymes of milk. In the U.S. yogurt processing industry, the FDA regulations require the plant operators to install legal pasteurization equipment, although the heat treatment of yogurt mix uses higher temperatures with a longer holding time than legal milk pasteurization. Accordingly, there are two sets of heat treatments: first one is to comply with the legal requirements and the second one in tandem is more intense in temperature and holding time. The main purpose of this additional heat treatment is to denature whey proteins and to create optimum conditions for the growth of yogurt culture. Proper denaturation of whey proteins (80–85%) increases their water binding capacity, which improves the consistency and viscosity of yogurt and helps to prevent free whey separation (syneresis). The level of desired denaturation depends on the type of yogurt being processed. The manufacture of a “natural” yogurt, which has no stabilizers, requires a greater denaturation of serum or whey proteins. Studies have shown that heating the mix at 85°C for 20 minutes is optimum for maximum water binding capacity of milk proteins. This treatment gives minimum amount of drainage of whey from coagulated product when compared to lower or higher treatments of the milk. Other equivalent time–temperature heat treatments that are equally effective are given in Table 13.3.

Heat treatment exceeding the above-mentioned guidelines adversely affects the consistency of yogurt because of too much serum protein denaturation,

**Table 13.3.** Denaturation of Whey Proteins as a Function of Heat Treatment

Temperature (°C)	Holding Period (min)	Denaturation of Whey Proteins (%)
85	20–30	85–90
85.0–90.6	30	85–90
90.6	15	85–90
90.6–93.3	2	70–75
95.	8–10	90–95

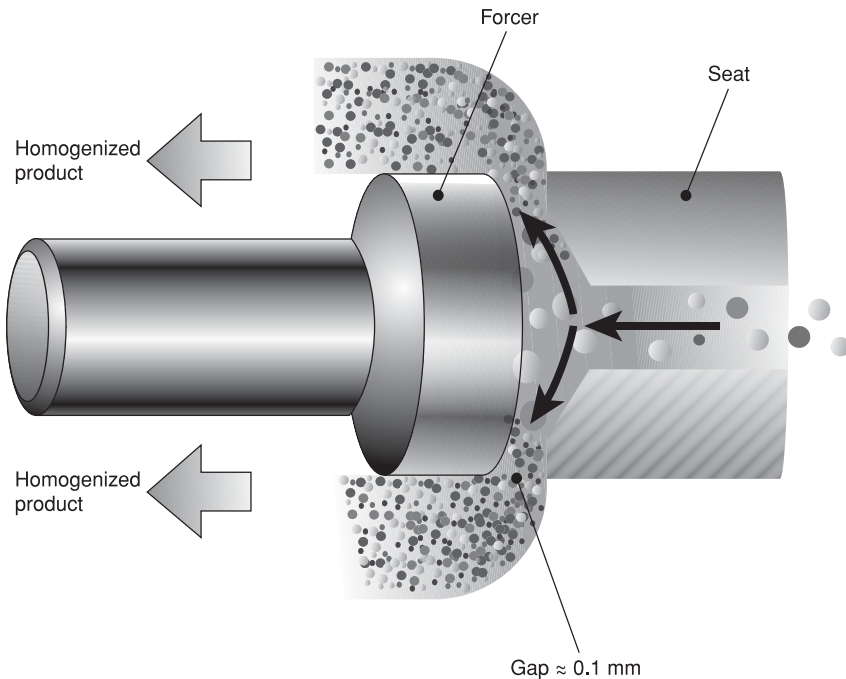

**Figure 13.9.** Principle of a homogenizer. Milk stream is forced from the right through a narrow orifice where fat globules are split and homogenized milk exits from the left. Courtesy: Tetra Pak.

which results in yogurt that is weak set with significant syneresis.

Other kinds of yogurt containing increased milk solids content and stabilizers technically require lower serum protein denaturation, since these depend on the higher solids and stabilizer to impart the desired consistency and prevention of whey separation. For these products, high-temperature–short-time systems can be used, provided that a temperature of 90.6–93.3°C can be obtained and the holding period is at least 30 seconds. If this holding period can be extended using a special tube with a holding period of 1–5 minutes, better consistency and increased protection from whey separation are usually observed.

3. **Homogenization:** This process of mechanically breaking milk fat globules to smaller size also helps in more uniform dispersion of stabilizers in yogurt mix (Fig. 13.9). The homogenization of yogurt mix with fat content greater than 1.5% has the following advantages:

(a) No rising of cream during incubation, which is the main purpose of homogenization. In some

Greek-style yogurts and natural whole milk yogurts, no homogenization is done because a cream layer on the top is desired.

- (b) Improvement of the consistency and viscosity of the yogurt because of uniform distribution of finely divided fat globules within the coagulum structure.
- (c) Greater stability of the coagulum against whey separation. In addition it has been shown that a high temperature–pressure homogenization breaks up the casein micelles altering the hydrogen bonds of the casein, increasing its hydrophilic ability and denaturing serum proteins, both of which result in a more stabilized protein complex and increased whey retention. This procedure can be used in the production of all “natural” yogurts with minimum or no stabilizer use.

Studies have shown that homogenization after pasteurization favors better consistency in the final product. The optimum range for homogenization has been found to be 50–60°C, with 35°C as the minimum effective temperature.

In the manufacture of “natural” yogurt with minimum stabilization (MSNF 11–13%), a high pressure of homogenization of approximately 23–28 MPa/6MPa (2000–2500/500 psi), double stage or 23–28 MPa (2000–2500 psi), single stage is used in order to improve consistency and help prevent whey separation.

Yogurt with higher total solids content and/or stabilizers can use lower homogenization pressures of the order of 6–17 MPa (500–1500 psi). Improving the consistency, viscosity, and prevention of whey separation using homogenization is less important with this type of yogurt because of the increased solids content and the effect of the stabilizer.

If the stabilizer that is being used contains a modified starch, which is not resistant to shear, a minimum homogenization pressure should be considered to prevent destruction of the starch structure resulting from severe shearing from the homogenizer. In this case, a homogenization pressure of 3–4 MPa (250–300 psi) single stage is recommended. Since homogenization follows heat treatment, the need for utmost care in cleaning and sanitation of the homogenizer is emphasized.

4. *Coagulation*: The protein content of yogurt milk consists of casein, (comprising of 80% of the total protein) and serum/whey proteins. Casein is present in milk in the form of micelles composed of a calcium–caseinate complex (Chapter 2).

These casein particles are very stable in fresh milk of normal composition partly because of their electrical charge. The charged particles repel each other and stay in suspension. This stability is affected by changes in milk composition relating to ionic balance and salt concentration, by processing treatments, especially by changes of the hydrogen ion concentration.

During yogurt fermentation, lactic acid is produced as a result of bacterial growth. As the pH is lowered due to acid production, there is a gradual removal of calcium and phosphorus (bound to casein as tricalcium phosphate) from the casein particles. At the pH of 5.2–5.3, the caseinate particles are destabilized, initiating precipitation. Complete precipitation occurs at a pH of 4.6–4.7, which represents the isoelectric point of casein. At this point casein is free of bound calcium phosphate and the particles have no charge to keep them repelled from each other leading to their precipitation.

As mentioned earlier, denaturation of the serum proteins results in their decreased solubility in the

acidic range and coagulation is observed at pH 4.6–4.7. During heat processing, a major whey protein,  $\beta$ -lactoglobulin, interacts with  $\kappa$ -casein and during coagulation this complex is coprecipitated as well. Thus, the coagulated proteins in the yogurt are a coprecipitate of casein and denatured whey proteins with entrapped fat globules.

5. *Cooling*: The objective of cooling fermented mass is to restrict the growth of yogurt culture and its enzyme activity as quickly as possible and maintain the desired pH, body, and texture. Under practical conditions, the introduction of cooling yogurt mass after completed incubation depends on

- (a) manufacturing conditions such as temperature of incubation or intensity of acidification.
- (b) processing facilities available for cooling, such as cooling tunnel or cells, tube cooler, vat with agitator, plate cooler, or scraped surface cooler.
- (c) type of yogurt produced, i.e., cup set, fruit flavored, vat set, and plain (natural).
- (d) the desired organoleptic properties, such as final acidity and aroma production.

Generally, cooling in yogurt plants should take place at a pH of 4.5–4.65. Cooling with agitation at pH 4.7 or above can result in a grainy body and undesirable texture in the finished yogurt. The rate of cooling should be steady but not too fast. Cooling too rapidly can bring unfavorable changes in the structure of the coagulum contributing to whey separation in the finished yogurt. It is thought that this defect is probably due to the very rapid contractions of the protein filaments and their disturbed hydration. The method of cooling depends on the style of yogurt that is being produced. It is desirable to reach a temperature of 18–20°C within 1 hour to quickly stop further culture growth. Cup-incubated yogurt is cooled in the retail containers using a blast of cold circulated air in a cooling chamber/cell or a blast cold tunnel. High-velocity air creates simulated wind-chill conditions.

Vat-incubated yogurt is cooled using a special plate cooler, a multitube cooler, or in some cases in a processing vat with the circulation of refrigeration water in its jacket wall and agitation of the coagulum in the vat. When cooling in the vat, it is better to use a narrow high tank with swept surface agitation for quick cooling of the gel. Wide and high processing tanks with a propeller-type agitator are unfavorable for cooling. Many plants pump their cooled fermented base

through a back-pressure valve, a perforated stainless steel disk, a stainless steel mesh screen, or a “sour cream” cone in the line to insure a smooth texture in the fermented mass.

In the vat-incubated yogurt, the temperature of filling varies according to the type of stabilizers used. Generally, it is desirable to cool the yogurt to 7–13°C.

6. *Stirring*: Stirring should not be too rigorous or too long. This is especially important in the manufacture of natural yogurts; however, it should also be considered in stabilized yogurt since excessive stirring may break down some of the stabilization and change the level of stabilizer needed to obtain desirable body. In order to obtain a homogeneous gel, it is preferable to use a higher rate of stirring initially, reducing the rate of agitation as the temperature drops below 30°C. Stirring at pH above 4.70 gives a partially formed gel resulting in a grainy texture; therefore, stirring should commence at pH 4.65 or below.
7. *Pumping*: Pumps are needed to transport stirred yogurt from fermentation tanks through pipes and possibly a plate cooler to the filling machine. They operate with different pressures, depending on the design. However, for this application only positive drive pumps should be used. This insures a positive displacement of the gel without impairing its structure. Centrifugal pumps should not be used because the high centrifugal force produced by the rotary propeller forces the product to leave the pump with high speed and high pressure, which damages the gel consistency resulting in a weaker body.

## GENERAL MANUFACTURING PROCEDURES

We will now discuss general processes for major types of yogurt.

### PLAIN YOGURT

Plain yogurt is gaining share of the refrigerated yogurt category. Its market share is currently around 5% of the total refrigerated yogurt category in the United States. Plain yogurt is made either by cup-incubation or by vat-incubation. It can be found in the market as full fat, low fat, or nonfat yogurt. Formulations vary widely and the total solids range from 12.50% to 14.0%. Plain yogurt is an integral component of the

manufacture of frozen yogurt. The steps involved in the manufacturing of set-type and stirred-type plain yogurts are shown in Fig. 13.10.

Plain yogurt normally contains no added sugar or flavors in order to offer the consumer natural yogurt flavor for consumption or as an option of flavoring with other food materials of the consumer’s choice. In addition, it may be used for cooking or for salad preparation with fresh fruits or grated vegetables. In most recipes, plain yogurt is a substitute for sour cream providing a lower fat/calories alternative. For these reasons it is common to find plain yogurt packaged in larger multiserve containers.

### FRUIT-FLAVORED YOGURT

For the production of blended/Swiss style, the fermented yogurt base is mixed with various fruit preparations. The fruit incorporation is conveniently done using a fruit feeder or metering pump at a 10–20% level followed by a static in-line mixer to assure homogenous blending of the fruit with the yogurt base. Prior to flavoring, the texture of stirred-yogurt can be made smoother by pumping it through a back-pressure valve or a stainless steel screen.

The second class of fruit-flavored yogurt is FOB. In this case the fruit is dispensed on the bottom of the cup and the top layer is that of fermented yogurt or cultured yogurt mix. In the latter case, individual cups are incubated, and then cooled. We will now discuss all the types of fruit-flavored yogurts.

### Blended or Swiss-Style Yogurt

This type of yogurt is the most popular and commands more share of the market than the other varieties. Its volume has grown consistently over the years. There are two contributing factors for its growth: First is the reformulation of the stabilization system that results in a smoother body and less gel-like texture. Second is the incorporation of “mild” yogurt cultures, which produces a more pleasing mild taste and very little or no acidification (lowering of pH) during the entire shelf life. These yogurt attributes have gained broad consumer acceptance in the market.

Swiss or blended yogurt is a homogeneous blend of fruit and/or fruit-flavored syrup with fermented yogurt base. This product is made using vat-incubation and almost always requires the use of stabilizers. The stabilizers and their level can be varied to obtain the desired product. The sugar solids vary, depending on

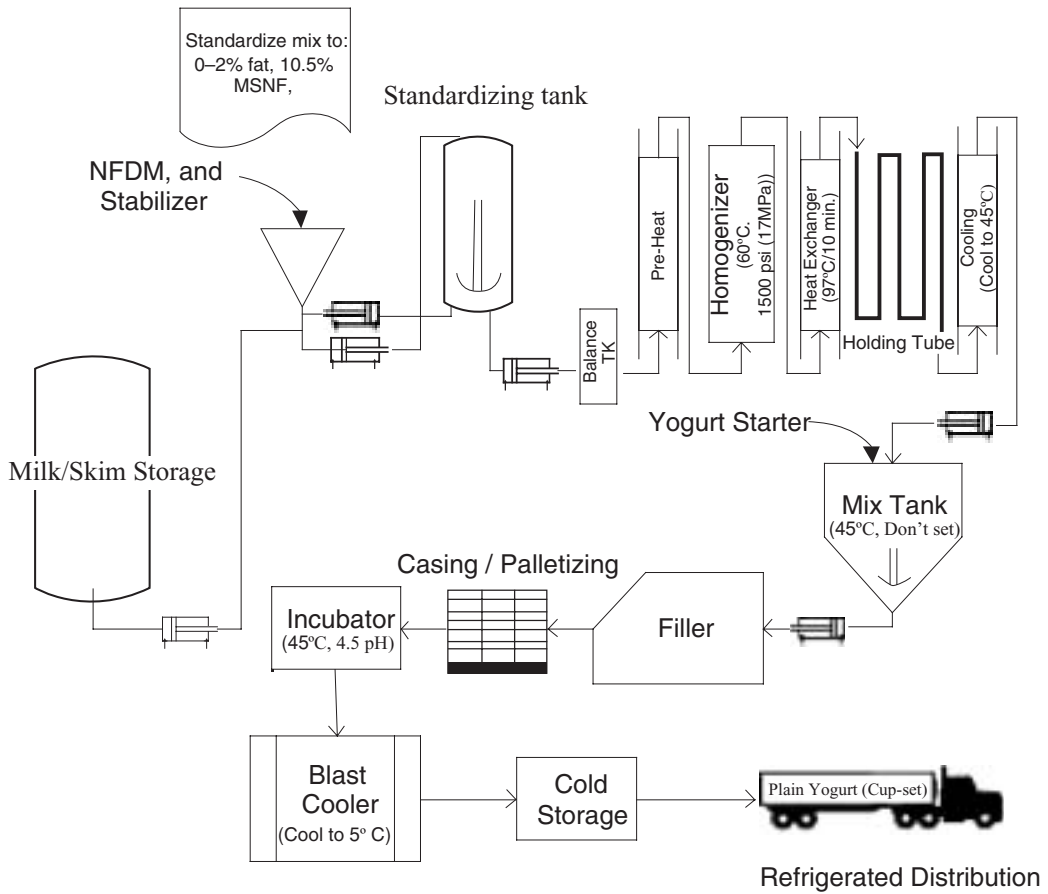

**Figure 13.10.** Flow sheet for the manufacture of cup-set plain yogurt.

the sugar content of fruit preparation and flavoring. The fat content varies according to the desired product category, namely, full fat, low fat, or nonfat yogurt (see Table 13.4 for variations in the formulation).

One of the most common stabilizer blends used for blended yogurt consists of a combination of modified food starch (0.6–1.5%) and gelatin of 225–250

Bloom (0.25–0.40%). It produces a creamy, firm yogurt, which is resistant to wheying-off and comes out smooth and free of lumps. If a “natural” approach is desired, a gelatin–pectin stabilizer or agar–pectin stabilizer can be used. Again, other stabilizer combinations can be used to meet specific marketing or manufacturing needs.

**Table 13.4.** Typical Formulation of Blended/Swiss-Style Yogurt Base

Composition	Nonfat Yogurt (%)	Low Fat Yogurt (%)	Full Fat Yogurt (%)
Milk fat	0.3–0.5	1.0–2.0 (>0.5–<2)	3.25–3.50
Milk solids-not-fat	11.0–12.0	10.5–12.0	10.5–11.0
Sugar solids	0–6.0	0–6.0	0–6.0
Stabilizer	0.4–1.6	0.3–1.4	0.3–1.2



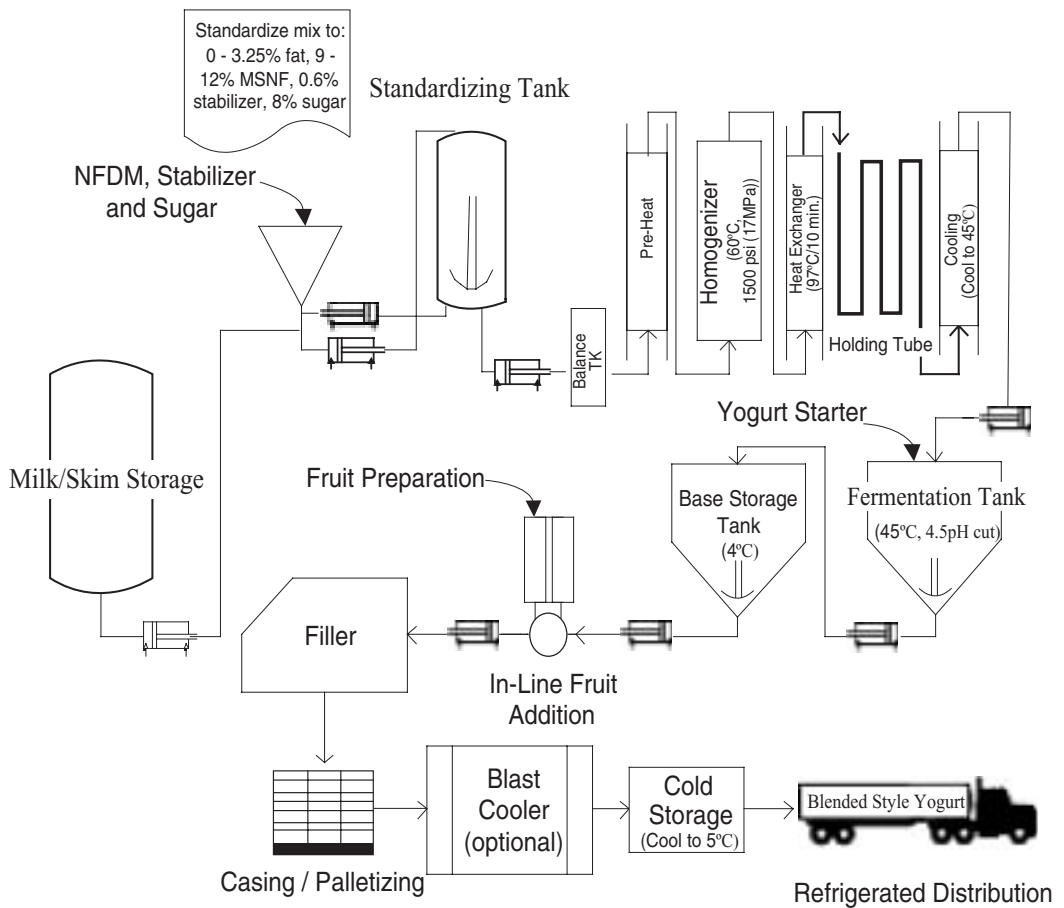

**Figure 13.11.** Flow sheet for stirred/blended/Swiss style yogurt.

Over-stabilized yogurt possesses a solid-like consistency and lacks a refreshing character. Blended or Swiss-style yogurt should be spoonable and should not be of flowing kind or have the consistency of a drink. The steps involved in the manufacture of blended/Swiss-style yogurt are illustrated in Fig. 13.11. A typical in-line fruit mixing is illustrated in Fig. 13.12.

Typical flavorings for stirred style yogurt are as follows:

- (a) Fruit preparations used at 10–18% level
- degree Brix ( $^{\circ}\text{Bx}$ ): 45–64
  - % fruit: 15–35
  - sweetener: sugar and/or corn sweeteners
  - stabilizer: pectin/modified food starch

- (b) Flavored syrup or flavored concentrate and/or fruit juice
- no visible fruit
  - lower calorie versus fruited yogurt
  - 8–9% sugar versus 10–12%

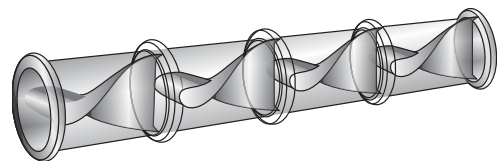

**Figure 13.12.** Fruit mixer built into the pipe. Courtesy: Tetra Pak.

- (c) Combination of fruit preparation and flavored syrup or flavored concentrate
- economy version
  - 6–10% fruit (40–50°Bx)
  - 2–4% flavoring.

Details of the fruit preparation are given in Chapter 9.

### Light Yogurt

This is made without the addition of sugar. High-intensity sweeteners are used to replace the sugar in the formulation. The synthetic sweetener is added either in the fruit preparation or flavoring or directly to the yogurt base. Light yogurts are stirred-style products that use a special fruit preparation characterized by 10–12°Bx, 30–60% fruit content, and is designed for use at 10–18% level.

### Custard Style

This fruit-flavored yogurt is a reduced fat product containing enough starch to create custard-like consistency. Furthermore, it contains no fruit chunks and is preferred mostly by children. It is a cup-fermented product. Other children-directed yogurts contain bright colors and are sweeter than regular yogurt. Some are packaged in a cup in such a manner so as to produce multiple colored vertically deposited layers during packaging. Other yogurts for children are packaged in plastic tubes.

### French-Style Yogurt

This style of yogurt is more common in Europe. In the United States, it has been popular in the past, but now its market is virtually nonexistent. It is a blended yogurt similar to Swiss style in that it has fruit dispersed throughout the body of yogurt, but it is characterized by distinctly weak set and creamy texture. The relatively runny body (low viscosity) style has lost popularity in the United States and has given way to viscous pudding-like body and texture of Swiss style. It is a vat-incubated product and depends on the technology of the stabilization system (hydrocolloids or protein preparations) to develop its characteristic soft body and texture. In some cases, it also employs the use of selective culture strains, which produce a “ropy” body and/or special processing methods such as evaporation, ultrafiltration, or reverse osmosis to concentrate milk solids. Table 13.5 gives the typical composition for a low fat French-style yogurt.

**Table 13.5.** Composition for a Low Fat French-Style Yogurt

Ingredients	%
Milk fat	1.5–2.00
Milk solids-not-fat	8.62–8.66
Added nonfat dry milk	3.85–5.00
Sugar solids	3.00–3.60
Stabilizer <sup>a</sup>	As needed
Total solids	17.00–20.00

<sup>a</sup> Gelatin–pectin (0.35–0.45%), modified starch–gelatin (0.60–0.90%), pectin, low methoxy (0.10–0.12%), agar–pectin (0.50–0.65), or whey protein concentrate (0.5–0.9%).

There are other typical processing methods used in the manufacture of European and other special yogurts. Two of these processes for concentrating solids and increasing protein concentration are reverse osmosis and ultrafiltration.

Reverse osmosis (RO) is a pressure filtration process that utilizes a semipermeable membrane made of cellulose acetate, vinyl, ceramic, or certain high-polymer materials. The membrane is characterized by the molecular weight and the size of molecules that are retained by it. With RO, water molecules pass through the membrane while practically all the dry matter is retained. RO is a high-pressure process and can concentrate skim milk into a concentrate containing 5.4% protein, 7.2% lactose, and 1.1% ash. The concentrate is standardized with cream, homogenized, heat treated, and cultured.

Ultrafiltration is a similar kind of membrane filtration process that works at much lower pressures than RO process. It utilizes a specific semipermeable membrane that is more porous than the membrane used in the RO process. With ultrafiltration membrane, water molecules, lactose, and minerals pass through the membrane while proteins and fats are retained. Skim milk is concentrated to 6.8% protein, 4.9% lactose, and 1.0% ash. This concentrate (retentate) is then blended with cream, homogenized, pasteurized, and cultured. The ultrafiltration concentrate can be used in various mixtures to increase the protein concentration at different levels in the final product.

### Sundae Style or Fruit-on-the-Bottom (FOB-)Style Yogurt

The popularity of this variety has significantly declined in recent years and has a market share of only 8% of the total refrigerated yogurt category in the

**Table 13.6.** Formulation for a Traditional Sundae-Style Low Fat Yogurt Base That Is Cup-Incubated

Ingredients	%
Milk fat	1.00
Milk solids-not-fat	8.64
Added nonfat dry milk	4.00
Stabilizers (optional) <sup>a</sup>	0.07–0.15
Total solids	13.64+

<sup>a</sup> Usually pectin, agar, or gelatin.

United States. There are two types of sundae-style yogurt. First is the traditional style and the second is the Western style. The traditional sundae style constitutes the majority of sundae-style yogurt. The traditional-style product is made using plain yogurt on the top and fruit preparation on the bottom. The yogurt top phase can be produced by either incubation in the container or adding vat-incubated yogurt.

- (a) *Cup-incubated traditional sundae-style yogurt:* The largest percentage of sundae-style yogurt is produced by incubation in the cup and can be formulated without a stabilizer by relying on added nonfat milk solids, proper heat treatment of the mix, and proper fermentation to obtain a semifirm body without wheying-off. However, with current trend toward increased code dates, warehouse distribution, and handling, the addition of a small amount of pectin, agar, or gelatin to the yogurt will help maintain product consistency throughout the product's shelf-life. Table 13.6 gives formulation for a traditional sundae-style low fat yogurt base that is cup-incubated.

In a typical traditional 8 oz cup of sundae-style yogurt, 59 ml (2 oz) of special fruit preparation is layered at the bottom followed by 177 ml (6 oz) of inoculated yogurt mix on the top. After the containers are sealed, incubation and setting of the yogurt takes place in the individual cup. When a desirable pH of 4.3–4.4 is attained, the cups are placed in refrigerated rooms, or blast cooling tunnels or cells for rapid cooling. For consumption, the consumer mixes the fruit and yogurt layers. Flow sheet for the manufacture of traditional sundae-style yogurt is illustrated in Fig. 13.13.

- (b) *Vat-incubated sundae-style yogurt:* If the yogurt is first incubated in the vat and then pumped into the cup with fruit preparation on

the bottom, a stabilizer must be added to the yogurt base. Table 13.7 gives the formulation for sundae-style yogurt that is vat-incubated.

- (c) *Western style sundae type yogurt:* One specific kind of sundae-type yogurt is called "Western style." It is made with flavored sweetened yogurt on the top. The top layer may consist of yogurt mix containing stabilizers, sweeteners, and the flavor and color indicative of the fruit on the bottom. The flavored yogurt on the top can be made with or without color. The bottom layer consists of fruit. This yogurt can be either incubated in the cup or the vat, but a stabilizer is used regardless of the method of incubation. The sugar solids in the yogurt base vary, depending on the Brix of fruit preparation and top phase flavoring. Table 13.8 gives formulation for a typical low fat formulation.

### Typical Flavorings for Sundae-Style Yogurt

- (a) Fruit Preparations to be used at 18–23% level.
- °Bx: 40–64
  - % fruit: 35–45
  - sweetener: sugar and corn sweeteners
  - stabilizer: modified food starch or pectin or pectin–locust bean gum
- (b) Combination of flavored syrup or flavor concentrate and fruit preparation
- Western style
  - 1–4% top phase flavoring
  - 12–14% FOB

### VANILLA-FLAVORED YOGURT

Vanilla is the second largest selling flavor in the U.S. market with the sales of \$240 million for 2004. Chapter 11 details the sourcing and manufacture of vanilla and its various forms used in the production of vanilla yogurt. As discussed in Chapter 11, it is most common to use vanilla extract added in yogurt production after fermentation for blended yogurts or added prior to fermentation for cup-set yogurt. When using pure vanilla extract the usage rate will vary depending on the fold or concentration of the extract, the source of the vanilla beans, and the desired flavor profile in the finished yogurt. In yogurt production it is most typical to use vanilla extracts from 1× (1-fold) to 3× (3-fold). The higher the fold or concentration of the vanilla extract, the lower the usage rate in the yogurt. For a 2× vanilla extract a typical usage rate is 0.45–0.60%. The vanilla extract supplier should

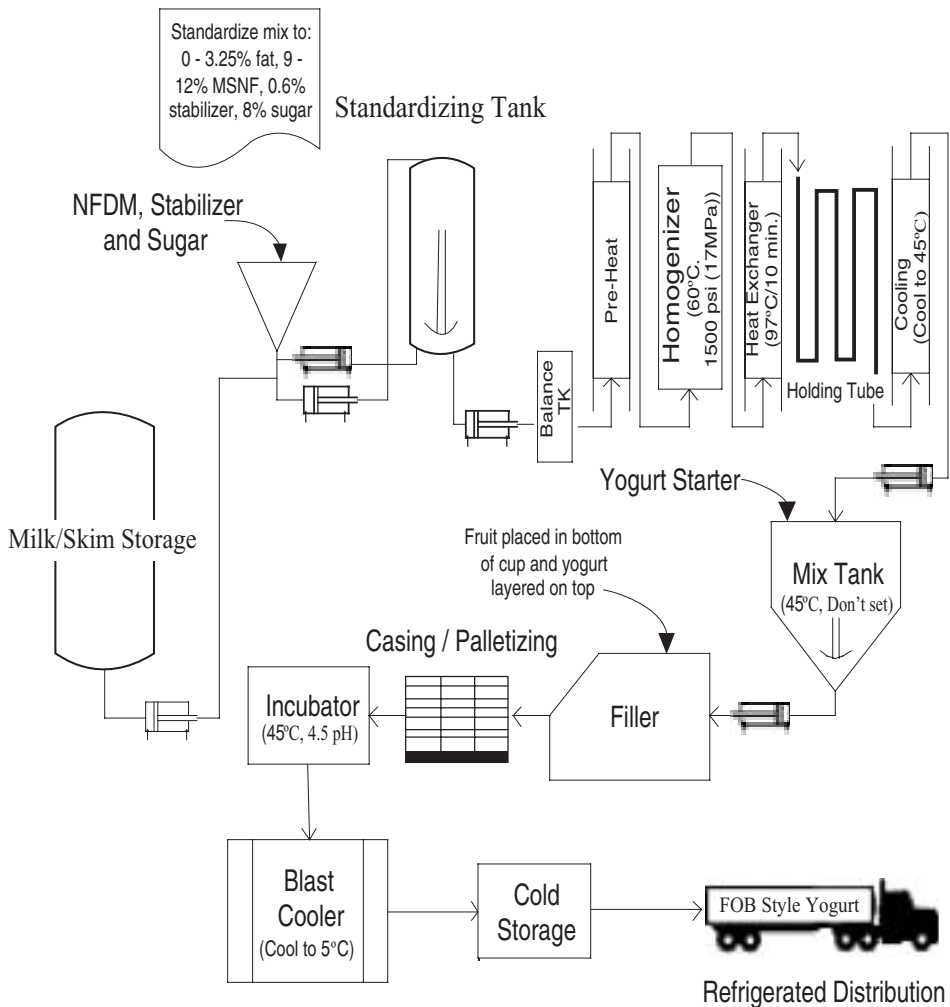

**Figure 13.13.** Flow sheet for the manufacture of fruit-on-the-bottom yogurt.

**Table 13.7.** Formulation for Sundae-Style Yogurt That Is Vat-Incubated

Ingredients	%
Milk fat	1.00
Milk solids-not-fat	8.64
Added nonfat dry milk	2.00 (2.0–4.0)
Stabilizer	1.00 (0.45–1.40)
Total solids	12.64 +

**Table 13.8.** Formulation for a Western Style Sundae Type Yogurt

Ingredients	%
Milk fat	1.00
Milk solids-not-fat	8.64
Added nonfat dry milk	3.00 (2.00–4.00)
Sugar solids	4.00 (3.0–6.0)
Stabilizer*	1.20 (0.45–1.80)
Total solids	17.64 +/-

\* Typical gelatin or gelatin-modified starch combination.

be consulted to provide recommended starting usages for the various extracts. For economic reasons some manufacturers might choose to blend a vanilla flavor or vanillin with pure vanilla extract to lower the cost. This would also impact the product label. Some manufacturers prefer to obtain vanilla in processed syrup (vanilla extract in liquid sugar syrup) from a typical fruit preparation supplier. With this syrup, it is possible to produce both vanilla and fruited yogurts using one plain yogurt base. Whether vanilla yogurt is produced from pure vanilla extract or in a 50–60°Brix syrup, the finished yogurt usually targets a finished sugar content of 7–9%. This sugar level gives the balance of sweetness and acidity in most yogurts to deliver a well-rounded vanilla flavor for the consumer.

### NATURAL YOGURT

In the United States there is no definition for “natural” in food regulations. Since there is no legal definition, so called natural yogurts are defined by the consumer. In formulating yogurts for this market segment there are certain guidelines that yogurt manufacturers have come to use:

- Natural or WONF (with other natural flavors) flavorings.
- No added preservatives.
- No high-intensity sweeteners or corn sweeteners; preferred carbohydrate sources include sucrose, fructose, fruit juice concentrates, or honey.
- No stabilizers or the minimum use of acceptable gums like pectin, agar, or locust bean gum.
- No artificial colors; if colors are needed, it is preferable to use extracts derived from vegetable or fruit sources (i.e., grapes, beet, annatto, blackberry).

In the processing of blended or cup-set natural yogurts, as discussed earlier, the heat treatment to obtain 80–90% protein denaturation is important to help control syneresis, since either no or minimal use of stabilizers is preferred.

### ORGANIC YOGURT

The total sales for organic yogurt are approximately \$179 million, representing 6.5% of the total refrigerated yogurt category for the 52-week period ending in May 2004. The popularity of this category is

represented by its annual growth of 17.1% in the natural market and 21.9% in grocery. The birth of the organic regulations occurred when Congress passed the Organic Foods Production Act (OFPA) in 1990. The OFPA required the USDA to develop national standards for organically produced agricultural products to assure consumers that the organic foods that they purchase are produced, processed, and certified to one consistent national organic standard. This was accomplished by the implementation of the National Organic Program (NOP); Final Rule on October 21, 2002. Yogurt that is sold, labeled, or represented as organic will have to be produced and processed in accordance with the NOP standards as defined in 7 CFR Part 205 (FDA, 2003).

Under the NOP standards, food products meeting the requirements for “100% organic” and “organic” may display these terms and may use the USDA organic seal. Products labeled as “100% organic” must contain (by weight, excluding water and salt) only 100% organically produced ingredients, including any processing aids. This product category is primarily found in produce, meat, or minimally processed foods. Manufacturers of multiingredient foods, such as yogurt, strive to achieve the organic label. Yogurt, as well as all products labeled “organic,” must consist of at least 95% organically produced ingredients (by weight, excluding and salt), and any remaining product ingredients must be organic compliant, that is, consist of nonagricultural substances approved on the National List (FDA, 7 CFR 205.605) or non-organically produced agricultural products that are not commercially available in organic form (7 CFR 205.606). Any yogurt, or other product, labeled as organic must identify each organically produced ingredient in the ingredient statement on the information panel. The regulations also prohibit the use of genetic engineering, ionizing radiation, and sewage sludge in organic production and handling.

A yogurt manufacturer interested in producing organic products must be certified. Certification standards under the NOP regulations establish the requirements that organic production (crops and livestock) and handling (processing) operations must meet the standards necessary to be certified by a USDA-accredited certifying agent. The information that an applicant must submit to the certifying agent includes the applicant’s organic system plan. The organic system plan describes (among other things) practices and substances used in processing, record keeping procedures, practices to prevent

**Table 13.9.** Organic Ingredients for yogurt manufacture (as defined by 7 CFR 205)

---

Organic Ingredients (as defined by 7 CFR 205)
Organic milk and cream
Organic Nonfat dry milk
Organic sugar or organic evaporated cane juice
Organic agave
Organic tapioca, rice, or corn starch
Organic fruits, fruit puree, and fruit juice/concentrate
Organic Compliant Ingredients (as defined by 7 CFR 205)
Agar-agar: allowed 205.605 (a)
Colors: allowed 205.605 (a) (5)—nonsynthetic sources only
Dairy cultures: allowed 205.605 (a) (6)
Flavors: allowed 205.605 (a) (9)—nonsynthetic sources only and must not be produced using synthetic solvents and carrier systems or any artificial preservatives
Ascorbic acid: allowed 205.605 (b) (4)
Nutrient vitamins and minerals: allowed 205.605 (b) (19)—in accordance with 21 CFR 104.20, Nutritional Quality Guidelines for Foods
LM pectin: allowed 205.605 (b) (21)
Gelatin: approved by the National Organic Standards Board, pending listing in the Federal Register

---

commingling of organic and nonorganic products, and on-site inspections.

There are many available organic ingredients that can be used in the production of a certified organic yogurt, low fat yogurt, or nonfat yogurt. Table 13.9 lists some of these agricultural organic ingredients as well as some ingredients that can be found on the National List and be used for the other 5% portion of the formulation.

### YOGURT DRINK/SMOOTHIES

Yogurt drinks have registered a significant growth (Berry, 2004) in the current yogurt market (Fig. 13.9). This product is designed to be consumed as a drink or shake. It consists of (a) refreshing low-milk-solids drink or (b) a health-promoting yogurt drink supplemented with prebiotics, probiotics, vitamins, and minerals. In order to be labeled as yogurt drink, the white mass (yogurt component) of the drink/beverage must conform to the FDA standard of identity that calls for >8.25% milk solids-not-fat and fat level to satisfy nonfat yogurt (<0.5%), low fat yogurt (2.00%), or yogurt (>3.25%) label (Chandan, 1997), prior to the addition of other ingredients. After the addition of fruit and flavors, it does not have to meet these standards. If a yogurt-based beverage is produced that does not conform to these standards, it can still be marketed given a fanciful name other than “yogurt” drink. Similarly, smoothies are not necessarily standardized and some may not contain

yogurt at all. If the product contains descriptors such as “a blend of yogurt and fruit juice,” it automatically requires that the product use yogurt in its preparation. A descriptor “a blend of juice and milk” allows the use of directly acidified milk (Roberts, 2004).

Typically, commercial drinkable yogurt is a low fat (<2.0% fat) drink containing 8.0–9.5% milk solids-not-fat and 8–12% sugar. Its pH varies from 4.0 to 4.5. Low-calorie drinks are made with high-intensity sweeteners replacing all the sugar. Yogurt drinks generally contain fruit juices or purees, although in some markets they may contain only sugar, with or without fruit flavors. The fruit content is generally in the range of 8–15%. In some markets the fruit juice range may be as high as 30–49%.

Yogurt drinkables and smoothies are of two types: regular and those fortified with prebiotics, probiotics, minerals, and vitamins. The prebiotic fructo-oligosaccharides (FOS) or inulin, along with synergistic probiotic cultures of *Lactobacillus casei*, *Lactobacillus reuteri*, and bifidobacteria are present in addition to yogurt culture. The type and level of stabilizer chosen is designed to keep the product from settling into two phases during its shelf life. The stabilizers prevent the milk protein from aggregation and subsequent separation of clear layer on the top. The stabilizers also help in appropriate viscosity of the drink. A mixture of hydrocolloids in the range of 0.01–0.5% is usually employed. High-methoxy pectin is especially functional in imparting the required viscosity and protein interaction to prevent

separation. Another important processing step is low-pressure homogenization (6 MPa (500 psi)) of fermented base to create small casein particles, which interact with pectin to stop aggregation of the protein and creating thereby a stable suspension.

The production method for drinkables is similar to that of blended/Swiss-style yogurt. The mix contains milk solids, sugar, stabilizers, and optional ingredients consisting of mineral–vitamin supplement, fructo-oligosaccharide. This blended mix is heat-treated at 85°C for 30 minutes or at 95°C for 10 minutes to create conditions favorable for culture growth and for viscosity generation. The mix is then cooled to 39–41°C, inoculated with 1–2% of yogurt starter and optional probiotic cultures, and incubated in quiescent state until a pH of 4.3–4.4 is achieved. The curd is broken while cooling to 18–19°C. The next step is distinctly different for yogurt drinks. Certain processes require addition of pasteurized solution of high-methoxy pectin to achieve 0.3% pectin level in the yogurt drink. The cooled fermented mass is homogenized at low pressure (6 MPa (500 psi), single stage) to convert casein to low particle size and facilitate interaction with pectin to obtain desired low viscosity and to render stable suspension. At this point, fruit puree and flavoring or syrup may be incorporated. Typical flavorings for yogurt smoothies consist of flavored syrups or flavor concentrate and/or fruit juices. After proper blending, the drink is ready for packaging in paper cartons or bottles. Individual serving bottles are commonly used for yogurt drinkables. When the yogurt drink is en route to the bottle filler, it is desirable to cool it to 5°C by passing it through a plate cooler. Prior to filling, the bottles are unscrambled and air-blown to remove any dust or foreign material. These are then turned upside down, rinsed, sterilized, and filled with required weight, followed by sealing with aluminum foil and application of a cap. The finished product is checked for pH, viscosity, and color at regular intervals. After coding and shrink-wrapping, the bottles are packed in cases and mechanically moved to cold room. These are then placed on pellets, shrink-wrapped, and transferred to the cooler before being shipped out of the plant (Clark and Plotka, 2004).

Aneja et al. (2002) and Chandan (2002) have given details for the manufacture of a long-life sweetened yogurt drink (*lassi*). Table 13.10 gives the formulation for *lassi*.

The process used in the manufacture of this yogurt drink includes pasteurization, homogenization, and culturing systems. The shelf life can be extended by

**Table 13.10.** Formulation for the Manufacture of a Long-Life Sweetened Yogurt Drink (*Lassi*)

Ingredients	%
Milk fat	0.5–3.5
Milk solids-not-fat	9.00
Sugar	10–11
Sodium dihydrogen phosphate	0.5
High-methoxy pectin	0.5

UHT processing after fermentation and aseptic packaging. Wheying-off is controlled by using a suitable stabilizer and proper processing conditions. The process has been patented for the manufacture of long-life sweetened drink, which maintains phase stability and does not separate over extended storage in aseptic packs. Standardized low fat milk (9–10% SNF and 0.5–1.0% milk fat) is heated to 85°C for 30 minutes or to 91°C for 2.5–5 minutes and cultured with yogurt culture. It is then fermented to lower the pH to 4.5. The set curd is broken with the help of stirrer while pasteurized sugar solution (30% in water) is added so as to give 8–12% sugar concentration in the blend. The blend is then homogenized at 23 MPa (2000 psi) and UHT processed at 135–145°C for 1–5 seconds and packaged aseptically employing standard equipment. A flow sheet for the production of sweetened yogurt drink is shown in Fig. 13.14. The figure shows procedure for making drink with live cultures as well as for heat-treated and aseptically packaged (extended-life) drink.

### YOGURT WHIPS/MOUSSE

Whipped yogurt has unique eating quality in that it is fluffy and light textured and has a good mouth feel. It adds variety and new taste sensation to the product portfolio. The foam formation of the mix takes place during processing. Compared to stirred-type yogurt, the mix for whipped yogurt contains more sugar and stabilizers. Gelatin is an essential ingredient of whipped yogurt. Low to regular fat mix whips better than the nonfat mix. The stability of the foam is facilitated by the use of suitable emulsifiers and stabilizers in the mix. An emulsifier aids in foam formation while stabilizer is responsible for viscosity, mouth feel, and stability of the foam and emulsion structure. The bubbles formed are prevented from collapsing by the action of stabilizer–emulsifier during

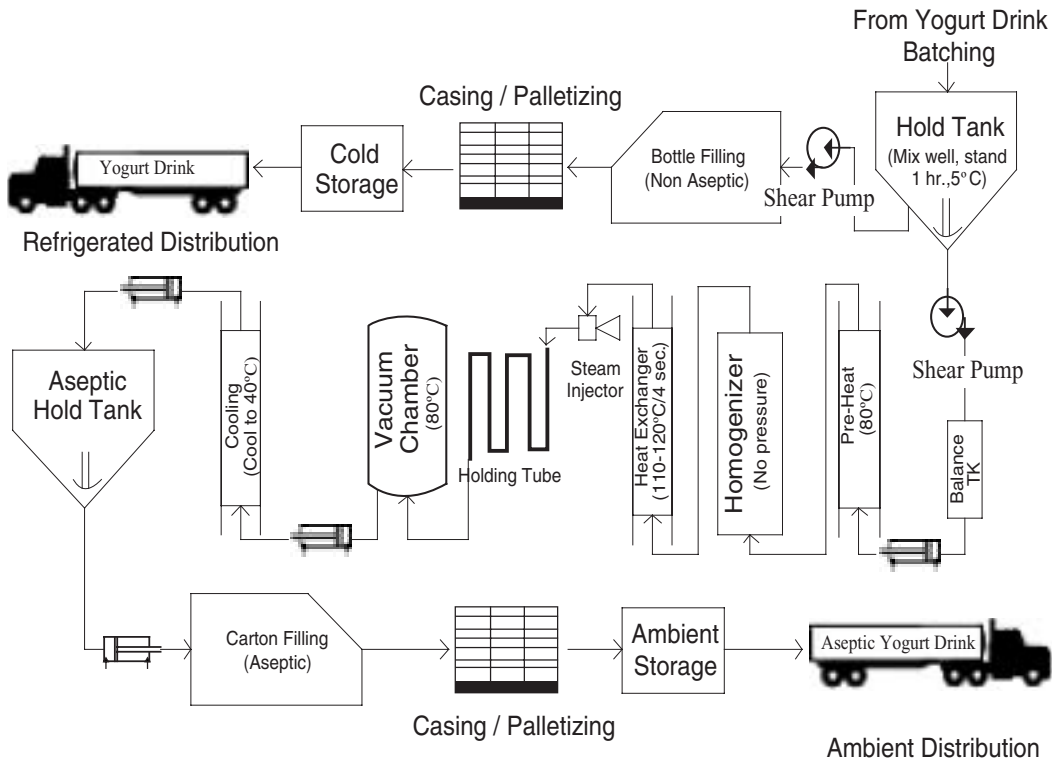

**Figure 13.14.** Flow sheet of the manufacturing procedure for refrigerated and long-life sweetened yogurt drink.

the shelf life of the product. High altitude can affect the stability of the foam as well. Generally, a stabilizer system includes starch, gelatin, carageenan, guar gum, xanthan gum, and locust bean gum. The emulsifiers include mono- and diglycerides, especially the lactylated type. The stabilizer-emulsifier blend is incorporated directly in the yogurt mix prior to the heat treatment. After fermentation, the mix is whipped using inert gas like nitrogen to increase the volume of the mix by 50%. Thus, the whipped yogurt has an overrun of 50%. Thus, a 6-oz cup will hold 4 oz of yogurt whip. During whipping, the high turbulence in the equipment results in fine gas bubbles dispersed in the aqueous phase. The mixing head of the aeration machine disintegrates large gas bubbles into finer bubbles forming desirable foam structure. The emulsifiers are surface-active agents. By reducing surface tension, they facilitate bubble formation, while the stabilizers enhance viscosity and form a coating around the bubbles to give them strength and capacity to resist from collapse. The

foam matrix consisting of fat globules, gas bubbles, and aqueous phase containing soluble and insoluble components of the mix is formed at low whipping temperature.

### CONCENTRATED/GREEK-STYLE/STRAINED YOGURT

This type of yogurt is more common in the United Kingdom and some other countries. The base for this type of yogurt is whole milk, supplemented with cream to standardize the fat level to 7%. In traditional process, after fermentation is complete, the yogurt is concentrated by straining through cheese cloth at 4°C overnight. Because of the drainage of whey, the total solids increase from 14% to 21–23% (Tamime and Robinson, 1999; Robinson, 2003). The concentration step results in a remarkably thick viscous body. The fat content of this type of yogurt rises to approximately 10%. The high fat content imparts very creamy flavor and moderates the



acid flavor. The fermented protein also concentrates and contributes to smooth texture. The traditional method is labor intensive and lacks sanitation conditions for obtaining desirable shelf life of the product. Accordingly, modern processing procedures for whey removal are employed. Drainage of the whey is accomplished by ultrafiltration or is done when the fermented milk passes through Quarg/centrifugal separators. The resulting concentrated yogurt is subsequently packaged.

Alternatively, Greek yogurt can also be found in the UK market that does not involve the concentration step. Such Greek yogurt is formulated with high fat content of 7–10% and SNF content of 10–12%.

### FROZEN YOGURT

The sale of frozen yogurt category in the United States has been on the decline in recent years. For the 52-week period ending on May 16, 2004, this category has shown a decline of 7.8% but still represents \$195 million in sales. It remains a viable business perhaps because of its low fat and nonfat attribute and the health image of yogurt. The frozen yogurt base mix may be manufactured in a cultured dairy plant and shipped to a soft-serve operator or an ice cream plant. Alternatively, the mix may be prepared and frozen in an ice cream plant. (For details, see Marshall and Arbuckle, 1996.)

Currently, no Federal standards have been approved for frozen yogurt. The product may be defined as a food prepared by freezing while stirring a blend of pasteurized nonfat or low fat ice cream mix and yogurt (Marshall and Arbuckle, 1996). Yogurt used for blending with ice milk mix must comply with the Federal and State compositional standards for yogurt. It must be cultured with LB and ST to titratable acidity of minimum of 0.85%. In general,

frozen yogurt mix obtained by blending yogurt and low fat/nonfat ice cream has a pH of 6.0 or titratable acidity of 0.30%. Thus, the industry standards require minimum titratable acidity of 0.30%, with a contribution of approximately 0.15% as a consequence of fermentation by yogurt bacteria. Most manufacturers use 10% of yogurt in their formulations. As a consequence, frozen yogurt tastes very similar to low fat/nonfat ice cream, with a hint of yogurt flavor at the end. This flavor attribute is preferred by the consumer because the perceived health attributes of yogurt bacteria are available along with the popular taste of low fat/nonfat ice cream. Frozen yogurt is labeled according to the fat content of standard serving size (4 fl oz) used in the ice cream industry. Accordingly, the product containing >3 g of fat per 4 fl oz is labeled as frozen yogurt, the product containing 0.5–3.0 g per 4 fl oz is low fat frozen yogurt, and the product with <0.5 g fat is labeled nonfat frozen yogurt.

A typical formulation of low fat frozen yogurt is given in Table 13.11. The table shows a mix composed of 10% nonfat sweetened plain yogurt and 90% low fat ice cream mix. If a lower pH (<6.0) is desired in the finished product, the proportion of plain yogurt can be increased to >10% and vice versa.

Some manufacturers may pasteurize the soft frozen yogurt mix, which is a low acid food, to enhance its shelf life. Pasteurization also assures safety of the food by destruction of possible contaminating pathogens, including *Listeria* and *Campylobacter*. However, the label of the heat-treated product must display the phrase “heat treated after culturing” on the package panel.

Figure 13.15 illustrates the typical process for making frozen yogurt. Like ice cream, frozen yogurt is flavored and extruded from ice cream freezer at  $-8^{\circ}\text{C}$  to obtain soft serve frozen yogurt for immediate consumption.

**Table 13.11.** Formulation for Low Fat Frozen Yogurt

Component	Yogurt 10%	Ice Milk 90%	Frozen Yogurt Mix
Milk fat	0.07	2.39	2.16
Milk solids-not-fat	10.96	10.02	10.11
Whey protein concentrate 34 (97% solids)	0.0	2.7	2.4
Sucrose, (100% solids)	4.0	13.5	12.6
Corn syrup solids, 36 or 42 DE (95% solids)	0.0	6.0	5.4
Maltodextrin 10DE (96% solids)	0.0	4.0	3.6
Stabilizer (90% solids)	0.0	0.7	0.6
Total solids,%	15.03	36.04	33.94
Titrateable acidity,%	0.85	0.15	0.30
pH	4.6	6.7	6.0

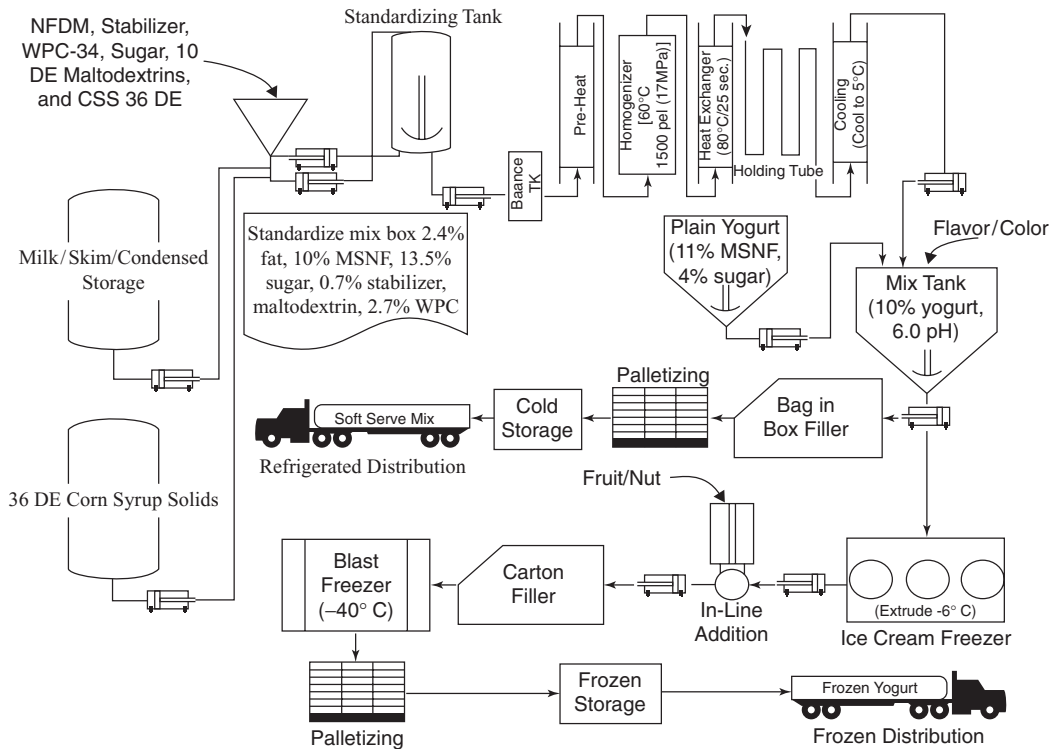

**Figure 13.15.** Flow diagram for the manufacture of soft serve mix and hard frozen yogurt.

Soft serve frozen yogurt may be garnished with nuts and other food materials to enhance its eating experience. The extruded frozen yogurt may be packed in suitable containers and hardened at  $-25^{\circ}\text{C}$  to obtain hard pack frozen yogurt. The ice cream freezer is a scraped surface freezing barrel (heat exchanger) (Fig. 13.16). As the liquid mix is pumped through the barrel, removal of the sensible and latent heat leads to formation of frozen mass. The dasher scrapes the inner surface of the barrel while the frozen mass moves toward the exit point. Simultaneously, air cells are formed as a result of whipping action of the dasher and the volume of the mix increases. Eventually, the semifrozen yogurt mass exits from the barrel as foam with a specific controllable degree of aeration. The overrun or the degree of air incorporated in the foam is around 50%. It implies that the original volume of the mix is increased by 50% in the finished frozen yogurt.

The calculation of overrun involves weighing a cup of the mix before freezing and determining the net

weight of the mix. Using the same cup, the frozen yogurt is packed and its net weight is determined. The overrun is calculated as follows:

$$\begin{aligned} \% \text{ Overrun} &= \frac{(\text{Density of mix} - \text{Density of frozen yogurt}) \times 100}{\text{Density of frozen yogurt}} \\ &= 100 \times \frac{(\text{Net weight of mix} - \text{Net weight of frozen yogurt})}{\text{Net weight of frozen yogurt}} \end{aligned}$$

Assuming the mix weighs 9 lb/gallon, and the frozen yogurt has 50% overrun, a gallon of frozen yogurt would weigh 6 lb. Accordingly, one serving of one-half cup (or 4 fl oz) would weigh 85 g.

## POSTCULTURING HEAT TREATMENT

The shelf life of yogurt may be extended by heating yogurt after culturing to inactivate the culture and the constituent enzymes. Heating to  $60\text{--}65^{\circ}\text{C}$  stabilizes the product so the yogurt shelf life will be 8–12 weeks

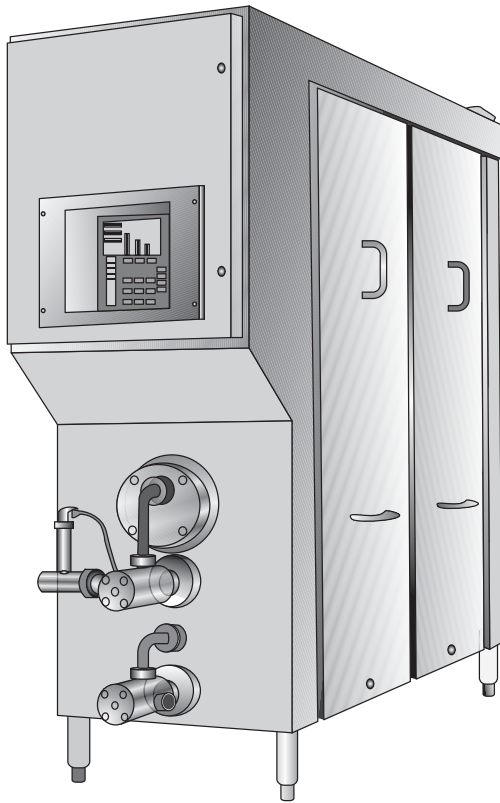

**Figure 13.16.** An ice cream freezer used for manufacturing frozen yogurt. Courtesy: Tetra Pak.

at 12°C. However, this treatment destroys the “live” nature of yogurt, which may be a desirable consumer attribute to retain (Chandan and Shahani, 1993; Shah, 2003). Federal Standards of Identity for refrigerated yogurt permit the thermal destruction of viable organisms with the objective of shelf life extension, but the phrase “heat treated after culturing” must be displayed on the principle display panel of the package. The postripening heat treatment may be designed to (1) ensure destruction of starter bacteria, contaminating organisms, and enzymes and (2) redevelop the texture and body of the yogurt by appropriate stabilizer and homogenization processes.

The heat-treated yogurt possibility is quite controversial in the United States. Although legal, the major players in the yogurt industry believe that such product will not deliver live and active yogurt expectation of the consumers (Chandan, 1989, 1999; Fernandes

et al., 1992; Mistry, 2001; Tamime and Robinson, 1999; Nauth, 2004). Indeed, the scientific evidence has been compelling that the health properties of yogurt are mostly lost by heat treatment (Chapters 21 and 22). This issue has been debated around the world. The Codex standard for yogurt does call for live and active status to be labeled as yogurt. Furthermore, if the product is heat-treated after culturing, it has to be labeled as “heat-treated fermented milk.” A similar standard, which is awaiting clearance, has been proposed by National Yogurt Association to US FDA. The standard would also require a minimum yogurt culture count of 10 million CFU/g in refrigerated yogurt at the time of consumption to insure the live and active status of the product.

## ACKNOWLEDGMENT

We appreciate the contribution of Brent Cannell for preparing flow sheet diagrams for this chapter.

## REFERENCES

- Aneja RP, Mathur BN, Chandan RC, Banerjee AK. 2002. Technology of Indian Milk Products. Dairy India Yearbook, New Delhi, India, pp. 158–182.
- Berry, D. 2004. Cultured dairy foods: A world of opportunity. Dairy Foods, April 2004.
- Chandan RC (Ed). 1989. Yogurt: Nutritional and Health Properties. National Yogurt Assoc, McLean, VA.
- Chandan RC. 1997. Dairy-Based Ingredients. Eagan Press, St. Paul, MN.
- Chandan RC. 1999. Enhancing market value of milk by adding cultures. J. Dairy Sci. 82:2245–2256.
- Chandan RC. 2002. Benefits of live fermented milks: Present diversity of products. In: Proceedings of International Dairy Congress, Paris, France. [Available in CD-ROM.]
- Chandan RC. 2004. Dairy: Yogurt. In: JS Smith, YH Hui (Ed), Food Processing: Principles and Applications. Blackwell, Ames, IA, Ch 16.
- Chandan RC, Shahani KM. 1993. Yogurt. In: YH Hui (Ed), Dairy Science and Technology Handbook, Vol. 2. VCH Publ., New York, pp. 1–56.
- Clarke S, Plotka VC. 2004. Yogurt and sour cream: Operational procedures and processing equipment. In: YH Hui, L Munier-Goddik, AS Hansen, J Josephson, W-K Nip, PS Stannfield, F Toldra (Ed), Handbook of Food and Beverage Fermentation Technology. Marcel Dekker, New York, pp. 159–182.

- Fernandes CF, Chandan RC, Shahani KM. 1992. Fermented dairy products and health. In: BJB Wood (Ed), *The Lactic Acid Bacteria*, Vol. 1. Elsevier, New York, pp. 279–339.
- Food and Drug Administration (FDA). 2003. United States Department of Health and Human Services, Public Health Services. 2002. Code of Federal Regulations. Title 21. Section 131. US Government Publishing Office, Washington, DC.
- Food and Drug Administration (FDA). 1999. United States Department of Health and Human Services, Public Health Services. Grade “A” Pasteurized Milk Ordinance. 1999 Revision. Publication No. 229. US Government Publishing Office, Washington, DC.
- Marshall RT, Arbuckle WS. 1996. *Ice Cream*, 5th ed. Chapman and Hall, New York, pp. 317–318.
- Mistry VV. 2001. Fermented milks and cream. In: EH Marth, JL Steele (Eds), *Applied Dairy Microbiology*, 2nd ed. . Marcel Dekker, New York, Ch 9, pp. 301–325.
- Nauth KR. 2004. Yogurt. In: YH Hui, L Meunier-Goddik, AS Hansen, J Josephsen, W-K Nip, PS Stanfield, F Toldra (Eds). *Handbook of Food and Beverage Fermentation Technology*. Marcel Dekker, New York, Ch 7, pp. 125–145.
- Roberts B. 2004. Dairy Foods, June 2004, pp. 56.
- Robinson RK. 2003. Yogurt types and manufacture. In: H Roginski, JW Fuquay, PF Fox (Eds), *Encyclopedia of Dairy Sciences*, Vol. 2. Academic Press, New York, pp. 1055–1058.
- Shah N. 2003. Yogurt: The product and manufacture. In: B Caballero, L Truco, PM Finglas (Eds), *Encyclopedia of Food Sciences and Nutrition*, Vol. 10, 2nd ed. Academic Press, New York, pp. 6252–6259.
- Tamime AY, Robinson RK. 1999. *Yogurt Science & Technology*, 2nd ed. Woodhead Publ. Cambridge, England, and CRC Press, Boca Raton, FL.

## BIBLIOGRAPHY

- Dairy Management, Inc. (DMI). 2003. *Concentrated and Dry Milk Ingredients. Dairy Ingredient Application Guide*. DMI, Chicago, IL.

# 14

## Plant Cleaning and Sanitizing

*Dennis Bogart*

### Cleaning

- Normal Soils
- Special Soils
- Manual Cleaning
- Foam Cleaning
- COP Cleaning
- CIP Cleaning

### Sanitizing

#### Bacteriophage (Phage) Control

#### Phage Control

#### A Final Thought

The concepts of cleaning and sanitizing in a yogurt processing plant are fairly simple and basic. First clean the soil from the surface, and then sanitize the surface. Simple to look at, read about and talk about; however, very difficult to accomplish on a regular basis. In fact, millions of dollars worth of yogurt and other cultured dairy products have been lost due to poor sanitation and it would be almost impossible to calculate the number of good customers lost due to poor sanitation. There are a lot of companies today that I call “used-to-bees.” Some of these companies, at one time, were major players in the dairy industry and some were small independent operations. They all have one thing in common. They no longer exist. They are gone, a part of history and we can think of many dairy companies that are “used-to-bees.” Some are “used-to-bees” because of the financial burden of business; however, far too many because of poor quality product.

The issues with the product not only involve topics such as shelf life, flavor, appearance, and other quality issues but also product safety. The Center for Disease Control and Prevention (CDC) estimates that

approximately 75 million people in the United States have food poisoning every year. That is roughly 25% of the population every year. Also CDC estimates that over 5,000 people every year die from food poisoning in the United States. This is a true tragedy and in many cases could be prevented if the food-processing plants use good GMPs and sanitation. Simple things such as washing hands for 20 seconds with soap, and cleaning and sanitizing the plant can go a long way toward preserving a good company name.

In cleaning and sanitizing yogurt plants there are a few ideas that need to be dismissed right away:

- Yogurt is a “safe product because the product’s acidity takes care of any ‘bad bugs’”—FALSE
- Sanitizers kill everything—FALSE
- Phage will not attack yogurt as in other products like buttermilk—FALSE
- Cleaning removes all the bacteria and phage from a surface—FALSE
- The external environment is not important—FALSE
- Sanitizer rotation is important because we develop “resistant” bacteria—FALSE
- Quat sanitizers are too dangerous to use—FALSE

## CLEANING

Cleaning is simply the removal of soil from a surface (notice that this says nothing about killing microorganisms—that is for later). There are no gradients of clean. The surface is either clean or it is dirty. If all the soils are removed, the surface is clean. If the soil is not completely removed, it is still dirty. There are several types of soil with which we have

to be concerned. Some of these are called normal, whereas others can be called special.

## **NORMAL SOILS**

### **Fat–**

All yogurts and other cultured dairy foods contain fat. Even nonfat products may contain up to 0.5% butterfat, while others may contain 4% butterfat or more. The fat will coat the surfaces with a greasy film that over time becomes rancid, attracts other soils, resists rinsing and, as all other soils, protects microorganisms from the action of sanitizers. Oil (fat) and water do not mix. This is one reason we need to use a good detergent or soap (surfactants). A surfactant is simply a chemical that has two functional ends on its molecule. One end is hydrophilic and “likes water.” The other end is hydrophobic and “likes fats and oils.” When the surfactant is in a solution of water and gets close to fat, it attaches itself to the water and on the other end to the oil. Thus the fat or oil mixes with the water. If the cleaning procedures are properly followed, the cleaner will remove the fat from the surface. There is also a very special circumstance, where it is very good that there is a little fat on the surface, when the cleaning operation starts. This is especially true for clean-out-of-place (COP), clean-in-place (CIP), and pasteurizer cleaning. The cleaning chemicals normally used for these applications usually do not contain any surfactants. This is especially true for the chlorinated CIP cleaners used in COP and CIP. Also caustic cleaners used to clean pasteurizers frequently do not have surfactants in their formulas. So how is the fat removed? Chemically all of these cleaners contain strong alkalis such as caustic soda (NaOH) or caustic potash (KOH). When these alkalis are mixed with fats or oils in normal cleaning, the fat or oil will undergo a chemical process known as saponification. In other words it makes good old-fashioned soap, a natural surfactant. This is a very desirable reaction and greatly boosts the cleaning action of the cleaner. It is extremely important to have a vigorous prerinse to remove excess butterfat from tanks and lines and an even more vigorous postrinse to thoroughly rinse the now dissolved or suspended soils from the system.

### **Sugars**

The various sugars in yogurt are relatively easy to clean. Water will usually do the trick. Most of the

sugars such as lactose, sucrose, and fructose are easily rinsed out with the prerinse. That is assuming that they are not all complexed within the other four soils. This will happen frequently and thus compounds the issues with the complex carbohydrates. Also there is a very dangerous situation that develops inside tanks, silos, and other enclosed spaces. When lactose is mixed with caustics, carbon monoxide (CO) may be formed. There have been several incidences where personnel have entered a tank after cleaning and succumbed to the colorless and odorless gas.

### **Complex Carbohydrates**

Complex carbohydrates are actually a matrix of all the soils together attached to the surface. Most of the time this happens when the yogurt mix is pasteurized and the soil is simply referred to as “burn-on.” The second circumstance where this complex soil forms is on equipment that has not been properly cleaned and the soil keeps building upon itself. The addition of stabilizers and emulsifiers compound the soiling issue. The more ingredients added, the more likely a soil will form. As with butterfat, strong alkaline cleaners are needed to clean this tough soil from the surface.

### **Proteins**

Milk is an excellent source of protein and most cultured dairy products have added proteins and other milk solids. Protein is the last and the hardest to remove organic soil that we normally encounter. They are relatively easy to see on a surface because of their typical blue film. However, if the cleaning has been neglected or the protein film has been allowed to thicken, it will change from a blue haze to an “applesauce” appearance. Further development will lead to a serious white film that may be confused with a mineral film. There are four common ways to remove protein films and to keep them from building up. The first is in cleaning a pasteurizer. Extremely strong (1–3%) caustic circulated hot (>170°F) for more than 30 minutes will usually control the protein film. The issue is that the protein is an extremely long and complex molecule that is not soluble in water. The caustic acts to break this long molecule up into shorter chains that are soluble in water and removed in the postrinse. As this treatment with caustic is neither feasible nor recommended in COP, CIP, foam, or manual cleaning, other ways need to be used

to break the protein molecule. The most common in North America is to add chlorine to the cleaner. Chlorine, at typical concentrations between 75 and 300 ppm, will quickly remove protein soils. Other alternatives including enzymes, hydrogen peroxide, and selected acids will also act to remove protein films. Protein films are especially important for they may harbor phage that will destroy the yogurt during the culturing phase of production. One issue to be very aware of is if chlorinated cleaners are being used, they will clean protein films, boost general cleaning, and deodorize. One thing that they will not do is to kill sufficient microorganisms to achieve sanitizing. The pH is too high for the chlorine to be active as a sanitizer. This is critical because you must always clean prior to sanitizing.

### Minerals–

Mineral films are formed in many ways. A common industry name for mineral films is “stone.” These stones are further referred to by their common origin such as milkstone, beetstone, beerstone, waterstone, and soapstone. In the cultured dairy-products industry the three most common stones are milkstone, soapstone, and waterstone. All of these hard to clean stones have one thing in common, they generally need to be cleaned with an acid. The food grade acids such as phosphoric, nitric, sulfuric, and sulfamic are most commonly used. Normally the surface is cleaned with an alkaline detergent to remove all the organic soils, rinsed thoroughly with water, and then the acid is applied.

## SPECIAL SOILS

### Biofilms–

Biofilms are formed by many bacteria when they attach to a surface. They secrete a very viscous polysaccharide slime to cover for protection. This slime is a complex carbohydrate film and can be cleaned with an alkaline cleaner. It is not easy to clean biofilms, as vigorous agitation may be needed. The significance of these films is that they protect the bacteria from the action of the sanitizer, thus the bacteria will survive sanitizing. To further emphasize the significance of biofilms, *Listeria* and *Pseudomonas* form biofilms. The first is a psychrotrophic pathogen and the second spoils probably more dairy products than any other bacteria.

### Bacteriophage–

In many ways, bacteriophage, the virus that attacks the bacterial culture can be considered a soil. In a culture plant, phage (as it is more commonly known) is frequently associated with dirty equipment, air, or the environmental surfaces. Controlling phage is a constant battle for any cultured products plant and especially a yogurt operation. To control phage, good sanitation, adherence to GMPs, and culture rotation are needed.

As stated previously cleaning is the removal of soil from a surface and if any soil is left on the surface, the surface will be dirty. There are three main principles that must be remembered when cleaning in a yogurt plant:

1. The prerinse is the most important step in the entire cleaning process.
2. The surface is either clean or it is dirty.
3. You cannot sanitize a dirty surface.

The cleaning process is fairly simple. First, prerinse to remove all the gross soil; second, wash with an appropriate cleaner; and third, rinse off or remove the soil. These steps sound simple, but there are numerous ways to foul up the process in the four main cleaning methods: manual, foam, COP, and CIP.

## MANUAL CLEANING

Manual cleaning is normally accomplished with a bucket of suds and a brush or pad. It is a very common method of cleaning and has been used in the dairy industry for literally hundreds of years. Although manual cleaning is very common, there are issues that occur frequently:

- *Failure to use the right detergent or cleaner.* Manual cleaners are specifically designed to be active at moderately hot temperatures (100–120°F), to produce copious amounts of stable foam and to be relatively mild to skin. Other types of cleaners, such as CIP or foam cleaners, may function quite differently and produce poor results, possible corrosion of the surfaces, or be too harsh to use even with gloves. Always follow the manufacturer’s recommendations as to what product to use for manual cleaning.
- *Failure to use the correct amount.* If a little bit is good, more is better. This idea has caused numerous problems in plants. It will cause poor rinsing, too strong a solution for operator’s skin, heavy streaking, and possibly corrosion issues.

Many times an operator will put far too much detergent in a bucket and just keeps adding water to the bucket. Most powdered manual cleaners will have directions to use approximately one ounce per gallon of water. Using more than that level will not clean better but will waste considerable money and will have all the other consequences listed above.

- *Failure to use the right type of manual cleaner.* The best type of manual cleaner for a yogurt operation is a chlorinated alkaline cleaner. These types of cleaners come in powdered and liquid form and will do a very good job. They are especially good at removing the protein films that frequently form on the product contact surfaces. The proper cleaning solutions will have a mild alkali and high foaming surfactants to remove any butterfat and carbohydrate soils. The chlorine will be present at between 60 and 200 ppm and will break up and help remove the very tough protein films.
- *Failure to use clean, fresh solutions.* If the solutions become too dirty or are more than 30 minutes old, they lose their chlorine and temperature and become very poor cleaners. Streaks, films, and poor rinsing will result.
- *Failure to use the proper tools.* Good brushes and pads are essential to good manual cleaning. The brushes need to be of the proper size and color (follow color coding system) and in good condition. Wood-handled brushes must never be used. Many operations use what are termed “green pads.” I strongly recommend against their use. Although they do clean well, they will severely scratch stainless steel and their green color makes it very hard to tell when they need to be replaced. I recommend that these “green pads” be replaced with “white pads.” These pads will not scratch stainless steel as the green ones do and you can tell when they need to be replaced.
- *Failure to scrub.* Manual cleaners are the mildest of all the commonly used cleaners. Because of this, they need heavy scrubbing and a little time to do their job. These cleaners will never “soak” clean a surface and therefore should never be used in any other type of cleaning such as CIP or COP.

## FOAM CLEANING

Foam cleaning is a quick and effective method for cleaning surfaces that have a light or moderate soil load on them. The process is quite simple. First, and

most importantly, gross soils are rinsed from the surfaces. After a thorough prerinse, a thin layer of foam cleaner is applied to the surface. After waiting 5 to 10 minutes, the foam and soils are rinsed off the surface. As with manual cleaning, there are several issues that need to be addressed when you foam clean:

- *Failure to use the proper detergent.* Because foam cleaners are used with minimal scrubbing, they are approximately 5–10 times stronger than a manual cleaner. The best type of foam cleaner in a yogurt operation for general cleaning is liquid-chlorinated alkaline foam cleaner. This type of cleaner removes all the organic soils and leaves the surface ready to sanitize. Occasionally, depending on water hardness and other conditions, acid foam cleaner may also be used. This acid foam cleaning removes mineral films and leaves the surface shiny. Take special note that when you acid foam clean, it is always best to use it after an alkaline foam cleaner and be *very careful* to avoid mixing the two cleaners in any way.
- *Failure to use the proper amount of cleaner.* Always follow the manufacturer’s directions for the amount of product to use. If the directions are too vague, always ask your supplier to clarify what is the right amount. Typical usages are between 2 and 4 oz/gallon; however, some products are recommended outside of this range.
- *Allowing the foam to dry.* This is a primary failure in foam cleaning. If the foam dries on the surface, all the soils that the cleaner has removed will be redeposited on the surface. This redeposited soil is frequently referred to as “redep.” “Redep” is extremely hard to remove and will make it impossible to sanitize the surface. Frequently an operator will either foam too much equipment and surfaces or will go on break after foaming. The worst situation is if the equipment is warm or hot, it quickly dries the foam. All of these situations must be avoided when foam cleaning. Only let the foam stay on a cool surface for 5–10 minutes and rinse thoroughly.
- *Failure to use the proper temperatures.* Prerinse and postrinsing with too hot water will “cook” the soils on the surface and cause, at a minimum, streaking. For good cleaning, rinse waters should be between 70°F and 110°F. This temperature will remove the soil and help eliminate streaking. The temperature of the water to generate the foam is also very important. Always use cool or cold



water for this purpose. If hot water is used, the product may not foam properly and may quickly dry and cause “redeposition.”

- *Too wet or dry foam.* The amount of water trapped in the foam determines if the foam is too dry or too wet. All foamers currently sold by reputable companies will have a method for adjusting the foam. This is usually by adjusting the water and/or air pressure or the air/solution mixture. If the foam is too dry, there will not be enough water in the foam for it to act as a good cleaner; and if the foam is too wet, it will be very heavy or soupy and fall from the equipment very fast. Good foam is similar to a wet shaving cream and will hang on a vertical surface for at least 5 minutes.
- *Poor foaming technique.* Here is the second reason for foam cleaning to fail. If good foaming technique is not used, the operator will miss large areas of the surfaces being cleaned. Always foam from the bottom up. Never foam from the top down, and always have a plan as to how the foam will be applied to the equipment.
- *Failure to scrub difficult soils.* Even as good as foam cleaning is, it may not clean all the soil from a surface. There will be areas that need to have some scrubbing to remove all the soil.

## COP CLEANING

Clean-Out-of-Place (COP) cleaning is a wonderful method to clean small parts, pipes, and other miscellaneous items. The parts are rinsed and placed into a specially designed tank that will circulate a cleaning solution around and through all the parts. Again, as with all types of cleaning, there are issues to address:

- *Failure to use the proper detergent.* COP tanks are not designed to tolerate foam. Foam in these tanks causes the pump to cavitate, thus greatly reducing the flow rate of the wash water. For this reason only a cleaner designed to be a CIP cleaner is to be used. I strongly recommend a chlorinated CIP cleaner for good soil removal. Remember to always follow the manufacturer’s directions as to the proper concentration.
- *Improper cleaning temperature.* If the cleaning temperature is too cold the equipment will be dirty; and if it is too hot the equipment might be damaged and it could be dangerous to the operator. COP tanks are not “boil-out” tanks. Keeping the cleaning temperature at 145–160°F will help in cleaning and saving energy.
- *Failure to properly prerinse.* All the parts that are to be cleaned in a COP vat must be thoroughly rinsed prior to placing into the vat. Failure to properly rinse might overload the detergent with soil and may cause excess foaming. This is a major reason that can cause COP cleaning to be ineffective. Ensure that the prerinse is with cool or lukewarm (<120°F) water or else there is a risk of “cooking” the soils onto the surface.
- *Overloading the COP vat.* This is the number two reason for failure. Always leave some room in the vat for the water to properly circulate. COP cleaning depends upon temperature, time, chemical strength, and vigorous water circulation. If the vat is overloaded, there will be poor circulation and the process will probably fail. Another situation I have frequently seen is an operator trying to clean an 8-foot pipe in a 6-foot COP vat. Half of the pipe will stick out of the vat and never get cleaned. In fact, none of the pipes will be cleaned because there is absolutely no circulation of the cleaner in the pipe. Taking the pipe out and turning it around surely will not help. Long pipes need to be cleaned in a CIP system, pipe wash vat, or manually scrubbed with pipe brushes.
- *Postrinse failure.* In a COP vat when the cleaning time is finished, the supply pump is turned off and the tank is drained. Frequently, the soil that has been removed off the equipment’s surface floats when the circulation of the cleaner ceases. This floating soil redeposits onto the surfaces if the vat is simply drained at this time. Always add cool to warm water to the vat and overflow the floating soil. When doing so be very careful not to get any of the cleaning chemicals on yourself or others. When the soil has overflowed, drain the tank and thoroughly rinse parts with either a cold water hose or by refilling the vat with cold water.
- *Failure to Disassemble.* The number one reason for cleaning failures in a COP vat is not completely disassembling all the parts to be cleaned. Any equipment that is not *completely* disassembled will not clean and will be dirty. There is no exception to this rule. All gaskets, joints, and other assemblies must be taken apart. Small and/or delicate pieces should be placed into a COP basket to facilitate cleaning and to protect them. As stated, I have found this to be the number one cause for failure and I frequently recommend that sanitation leaders and supervisors not walk by a COP vat without

looking into it to verify that all the parts are disassembled and that the vat is not overloaded.

## CIP CLEANING

Generally prior to the mid 1940s, all equipment in a dairy plant was completely taken down and manually cleaned every day. It was usually left overnight to dry and reassembled the next workday. This worked reasonably well in small dedicated operations; however, this would be virtually impossible in today's massive processing plants where silos and tanks holding 60,000 gallons or more are common and have miles of welded processing pipes and lines. A way of cleaning this type of equipment had to be developed prior to the introduction of modern processing plants. That breakthrough came in the mid 1940s and 1950s with the advent of CIP cleaning. Today, CIP cleaning systems range from simple manually operated systems to huge systems completely run by powerful computers. There are two fundamental CIP systems used in modern cultured dairy product plants:

1. *Reclaim CIP.* The heart of a reclaim system is a large tank used to reclaim the CIP cleaning solution for the next cycle. These systems can save energy and possibly water; however, the systems, by their very nature, will wash over and over with the same wash water. This may cause contamination to be spread throughout the plant if the system is not running at top efficiency.
2. *Single use CIP.* A single-use CIP system always uses fresh-wash water to wash each system. Modern single use systems will not use excess water or energy and can be an asset to the production of high-quality products.

CIP systems offer an excellent way to clean if they are properly designed and running well. They do, as with other methods of cleaning, have a number of issues that are critical to cleaning:

- *Low flow rate.* CIP cleaning totally depends upon the flow of the cleaning solution for mechanical action. The flow rate through a pipe must be at a minimum of 5 ft/sec for the water to have enough turbulence to clean. Any flow under this rate results in the flow being too easy (laminar) to clean. Also tanks and silos must have proper flow down the walls to clean. There is a simple formula used to calculate the minimum flow—two times the circumference measured in feet. As an example, if the circumference is 40 ft,

the minimum flow to the spray device in the tank will be 80 gal/min. This amount of water will cause a turbulent flow down the side of the tank.

- *The wrong detergent.* I recommend chlorinated CIP cleaners for most CIP cleaning in a cultured plant. This will clean and leave the surfaces ready to be sanitized. If nonchlorinated cleaners are used, the equipment needs to be periodically inspected for a protein buildup. When using a chlorinated cleaner, you not only have to measure the concentration of the cleaner but also the concentration of the chlorine. Both have to be at optimal concentration. Always follow the supplier's recommendations for the cleaner and keep the chlorine between 70 and 250 ppm. If a reclaim system is used, extra chlorine may have to be added.
- *Too low or high a cleaning temperature.* For most cleaning of a processing plant, a temperature of 140–170°F should work well. If excess temperature is used, the equipment may be damaged and poor cleaning may result. Too low a temperature could leave the equipment dirty.
- *System out of "balance."* "Balance" is a term used to describe the CIP system's hydraulics. A well running system will have all the rinse and wash water following correct flow/time patterns. A system out of balance will loose water, contaminate solutions, mix chemicals, poorly clean, and waste money. "Balance" is extremely important and must be addressed. As a hint if the CIP supply pump has an air eliminator, the CIP system may be out of balance. Normally there is no need for an air eliminator on the CIP supply pump.
- *Poor prerinse.* The most important step in the CIP cleaning process is the prerinse. The CIP system must be programmed to thoroughly remove all the gross soils from the equipment. If the gross soils are not removed, the cleaning solutions will be overloaded with soil and the equipment will probably be dirty.

Cleaning in a cultured plant is vital to the safe production of high-quality products. There is still the simple truth that the surfaces are either clean or dirty. If the cleaning operations listed above are properly performed, the surfaces will be clean and ready to sanitize. I am frequently asked, "Why do we need to sanitize when we clean all the bacteria from the surface?" This is a good question and the best way to address it is that effective cleaning will remove

between 90% and 99% of the bacteria from the equipment's surface. This is a very good reduction but not enough. Not enough to protect public health and to assure high-quality cultured products.

## SANITIZING

Sanitizing is the treatment of a cleaned surface with a chemical or physical agent to destroy pathogenic microorganisms and to reduce the total microbial vegetative cell population to a safe level. Always note that "sanitizing" is not "sterilizing" and not all microorganisms are killed. Typically, sanitizing of a surface will reduce the microbial population by three logs. That is another 99.9% beyond what is accomplished by cleaning. What is left on the surface is a matter of numbers. If there are a large number of microbes on a surface and the population is reduced by 99.9%, there could still be a substantial population of microbes left. Vigorous cleaning and good sanitizing will leave a surface with very few bacteria and other microbes. It is an accepted criterion that, after sanitizing, there should be fewer than two microbes per square centimeter of surface area. If the cleaning or sanitizing steps fail, there may be massive numbers left on the surface and product quality will be compromised.

There are a number of general rules for sanitizing:

- Only use sanitizers that are approved by the Federal EPA for use on food contact surfaces.
  - Always follow label directions for use on food contact surfaces. It is a violation of Federal law if these directions are not followed.
  - Pick the best sanitizers for your plant and then let them do their job. Put 95% of your effort into properly cleaning the surface.
  - Pick sanitizers based upon how they are to be used and the individual plant circumstances.
  - In a cultured plant, never rinse the sanitizer from food contact surfaces with water.
  - Constantly check the sanitizer concentrations.
  - Rotation of sanitizers because of "resistant bugs" is not necessary. If there are problems, it is almost always a cleaning issue.
  - There is no sanitizer that can make up for poor cleaning.
  - Sanitize open surfaces within 30 minutes of use and closed tanks within 3 hours of use.
  - All sanitizers have broad-spectrum activity except quaternary ammonium compounds (Quats).
- Store all sanitizers out of direct sunlight in a cool, dry room with good ventilation.
- There are numerous ways to sanitize cultured dairy plants. Various chemicals and heat have been used over the years and I offer the following recommendations specifically designed for culture operations.
- For sanitizing in CIP systems and HTST units a para acetic acid sanitizer (PAA) is normally recommended. All reputable suppliers of cleaners and sanitizers will be able to supply an appropriate PAA sanitizer. Most PAA sanitizers have a fairly wide concentration range approved for food contact surfaces. It is recommended that the PAA sanitizer be used at maximum strength to help control yeast, mold, and bacteriophage. For CIP systems, always use the products in cool water and handle carefully. When used in HTST units, the heat of forward flow may cause gasket damage and I recommend that Viton gaskets be used. They are more expensive than other gaskets but will tolerate the PAA well. Because PAA sanitizers are not strong acids, the normal cleaning regimen may need to have an acid cleaning cycle. Always consult with your chemical supplier regarding acid cleaning.
  - COP vats are excellent vats in which to sanitize previously cleaned equipment. There are two good sanitizers for use in a COP tank. The first choice is an iodine sanitizer. When using an iodine sanitizer, always make sure that the concentration is set at 25 ppm and that the use solution has a pH <4.5. Do not use an iodine sanitizer if the pH is over 5.5. A good iodine sanitizer is very effective on bacteria, yeast, and mold and is color-coded. The second choice is to use a PAA sanitizer. I recommend that the strength be set at mid-range of the use concentrations. Note: Only use iodine for soaking gaskets and other rubber parts to avoid excessive corrosion.
  - The best sanitizer for manual sanitizing of pieces and parts either by using a central sanitizer unit or in a bucket is iodine. Use a concentration of 25 ppm and be sure the pH is acceptable. Iodine is well accepted by operators. Its color makes it easy to judge the concentration and it does not have a harsh odor. I have heard that iodine will stain stainless steel. Under proper use, that does not happen. What an iodine sanitizer will stain is soil, especially protein films. A second choice is to use PAA. It is a good sanitizer; however, it does have

a mildly offensive odor and is not tolerated well by many operators.

- Now the topic comes up about what product to use for sanitizing environmental surfaces such as floors, walls, drains, and doorway entrances. I recommend that the best product for most of these applications is a Quat sanitizer, especially an acid Quat sanitizer. I am very well aware that there are many people in the cultured products industry who are very much against this type of sanitizer because it could kill the culture. There is some truth that Quats, even small amounts like 5 ppm, are very effective against the Gram-positive bacteria that make up culture. For this reason, I recommend Quats only for the environment. If the Quat that is on the floor ends up in the culture, the plant has a problem far worse than a dead culture. Quat sanitizers are excellent products for controlling yeast, mold, and pathogenic bacteria on environmental surfaces. They have low corrosion and no offensive odor. I recommend using a disinfecting strength of 500–1,000 ppm for nonfood contact surfaces. Apply the Quat to a clean surface and do not rinse it off and it will form a residual effect that will help control unwanted microbes. The most effective method for applying to the floor and building microbial barriers at doorways is to use “door foamers.” They deposit sanitizing foam at the door for sanitizing shoes and fork lift wheels. This approach is far superior to trying to use a footbath, which frequently becomes very dirty or dry.

To sum up the recommendations for sanitizers:

1. PAA for CIP
2. Iodine for central sanitizer systems and manual sanitizing
3. Acid Quats for environmental sanitizing

## BACTERIOPHAGE (PHAGE) CONTROL

In a dairy plant producing cultured dairy products, the term “phage” will cause even the most seasoned employee to become immediately concerned for their product. Phage (or phage particles) is a very special type of virus that only attacks bacteria. In the cultured plant, the phage can attack and destroy all the culture needed to make the product. Many vats of almost cheese and tanks of almost yogurt or buttermilk have found their way to the drain or as other forms of waste because of phage.

What is a virus and how do they multiply? Are they really alive, dead, or somewhere in-between? These are really good questions. First of all a virus is the smallest “living” thing that we know of, being much smaller than bacteria. The question, as to if they are alive, arises from the fact that a virus cannot multiply or duplicate itself. To replicate, a virus will attack a very specific host cell. During this attack, the virus will inject its DNA into the host cell and catastrophically change the complete function of the cell from whatever it was doing into becoming a virus manufacturing plant. After the host cell makes around 30–200 new virus cells, the cell ruptures, thus releasing the viruses (lysing) and the process starts all over. As discussed above, phage is a virus that specifically attacks bacteria, such as culture. Because of the rapid and massive multiplication of the phage in the culture, the phage will rapidly kill all the culture bacteria and ruin the production. For example, a typical scenario would be that after the culture is added to the main product, the pH starts to drop from approximately 6.8 toward the desired finished pH. However, about half way to the desired pH, further acid production just stops and without quick intervention the production is lost. The phage have completely taken over and killed all the “good” bacteria.

## PHAGE CONTROL

There are four specific issues in controlling phage that must be addressed:

- Culture and culture rotation
- Sanitation
- Emergency recovery
- Plant design and condition

**Environmental Sanitation.** First of all, the environmental areas such as the HVAC, floors, walls, ceilings, drains, and doors need to be in good repair and of sanitary design. If these areas are neglected, it will be very difficult to control phage. Install a floor sanitizing foam system on each doorway or entryway. The sanitizer of choice for these floor foamers is Quat at 800–1000 ppm. PAA may also be used following label directions. For cleaning the environmental surfaces, foam cleaning with chlorinated foam cleaner at 3–4% concentration is recommended. If the plant has a phage problem, add one quart of chlorine sanitizer to 15 gallons prediluted chlorinated foam solution in a tank foamer and foam onto the surfaces. Let stand for 15 minutes and thoroughly rinse. Foaming with the

added chlorine once a week will further help control phage. Clean the drains every day with chlorinated cleaner. After cleaning and thoroughly rinsing, sanitize all the surfaces with chlorine at 200 ppm. Fog sanitizing is of little use for phage control and we do not recommend its use. If the HVAC is clean and properly filtered, positive pressure maintained, and environmental surfaces cleaned and sanitized, phage will not have anywhere to “hide.”

**Open Cheese Vats.** Clean the vats every day with a chlorinated cleaner using both foaming and hand scrubbing. Thoroughly rinse the chlorinated cleaner and reclean with a manual acid cleaner and rinse again. Prior to production, sanitize the vats with 50–75 ppm chlorine sanitizer. Be very sure to also completely clean and sanitize the vat superstructure, paddles, and knives.

**Loose pieces and parts.** Take every effort to handle these pieces and parts in a sanitary manner. This especially includes gaskets, scoops, pipe joints, lubricant tubes, and other small items. After thorough cleaning, store these items in sanitizer solutions, not laid out or hung all over the plant. The best sanitizer for long-term storage is iodine at 25 ppm. It will kill phage and minimize any possible corrosion and is “kinder” on gaskets than other sanitizers. Change the solution at least once a day.

**CIP of Closed Vats, Tanks and Silos.** After determining that the CIP system is properly functioning, CIP all systems every day using a “built” chlorinated CIP cleaner following manufacturing directions for

concentration. Following a thorough rinse, acid-wash with a surfactated CIP acid cleaner and rinse again. Sanitize prior to production with PAA following manufacturer’s recommendations.

Always remember that a surface must be absolutely clean prior to sanitizing and that most microbiological issues, including phage, are cleaning issues not sanitizing issues. With thorough care and adherence to procedures, phage problems will be a problem of the past.

## A FINAL THOUGHT

The one factor that will make or break the sanitation program in a plant is people. For many years the cleanup crew has been made up of the newest, least trained, least supervised, and lowest paid employees. Yet these are the employees that totally control the future of the company. If this seems like a disconnect, it is. These employees need to be well trained and given all the tools they need to do their job. This includes proper incentives to do a good jogg and to keep good employees on the job. Many companies today have recognized the absolute importance of their cleanup crews and have addressed the issues in several ways. There are companies that have moved sanitation from third shift to first shift. Others pay premiums for sanitation or build in bonuses for good performance. There are other ways like shift rotation and other incentives that can make a difference. It is fair to say that if a company relegates sanitation to a third class operation, it is losing unrealized profit and will probably be a “USED-TO-BEE.”

# 15

## Yogurt Plant: Quality Assurance

*Ramesh C. Chandan and Kevin R. O'Rell*

### Regulatory Obligations

- Food & Drug Administration (FDA)
- Standard of Identity
- Food Labeling in the United States
- Analytical Tests
- Quality Control Programs

### National Yogurt Association Criteria for Live and Active

- Culture Yogurt
- Refrigerated Yogurt
- Frozen Yogurt

### Specification Program

### Defects and Trouble Shooting

### References

The quality assurance program for yogurt plant encompasses various functions to assure the quality of the products produced. It also is designed to insure that manufacturing plant meets all the state and federal regulatory obligations in regard to package labeling, proper ingredient usage, safety, and shelf life requirements.

## REGULATORY OBLIGATIONS

Milk production, processing, marketing, and manufacture of dairy products are all regulated by federal, state, and local authorities. The regulatory composition for the manufacture of yogurt in the United States is discussed below. Chapter 3 includes detailed discussion of regulatory requirements for milk production, transportation, and processing.

### FOOD & DRUG ADMINISTRATION (FDA)

Production, transportation, and processing of Grade A dairy products are regulated by the Milk Safety Branch of the FDA. Product safety, labeling,

packaging, and other product issues are included. In addition, other departments of the FDA are involved in product standards and labeling in general under the Fair Packaging and Labeling Act, and matters related to overall compliance. Milk specialists represent Milk Safety Branch's regional offices and work with the state regulatory agencies by providing scientific, technical, and inspection assistance. In this manner, compliance with regulatory policies and procedures is assured. Besides liaison with the FDA, the State Department of Agriculture (Dairy Division or Health Department) is also involved in regulating milk production and manufacturing in a particular state. To assist States and municipalities in initiating and maintaining effective programs for the prevention of milk borne disease, the Public health service, in 1924, developed a model regulation, known as the Standard Milk Ordinance for voluntary adoption by State and local milk control agencies. To provide for the uniform interpretation of this Ordinance, an accompanying code was published in 1927 that provided administrative and technical details as to satisfactory compliance. This model regulation now titled the Grade A Pasteurized Milk Ordinance (PMO)—Recommendations of the United States Public Health Service/Food and Drug Administration. The PMO is recommended for legal adoption by States, counties, and municipalities, to encourage a greater uniformity and a higher level of excellence of milk sanitation practice in the United States. An important purpose of this recommended standard is to facilitate the shipment and acceptance of high quality milk and milk products in interstate and intrastate commerce.

The Pasteurized Milk Ordinance describes the requirements for product safety, milk hauling, sanitation, equipment, and labeling. The PMO is very

extensive and covers milk production at the farm to the manufacturing facility. The requirements for chemical, physical, bacteriological, and temperature standards are given in Table 3.3 in Chapter 3. Some salient features include the following:

- Must contain the word Grade A on the container
- Must contain the identity of the plant
- Product standards of identity must be met
- Temperature—cooled to 7°C (45°F) or less and maintained there at
- Bacterial limits not to exceed 300,000 CFU/ml in commingled raw milk and 20,000 CFU/ml in pasteurized milk
- Coliforms—not to exceed 10 CFU/ml
- Phosphatase test—less than 350 milliunits/liter for pasteurized fluid products by the Fluorometer or Charm ALP or equivalent. The test represents detection of 0.075% raw milk or less
- Drugs—no positive results on drug residue testing by approved procedures

National Conference of Interstate Milk Shippers (NCIMS) plays a key role in setting standards and regulations related to the PMO, methods of making sanitation ratings of milk supplies, and sanitation requirements for Grade A condensed and dry milk products, including condensed and dry whey. Furthermore, NCIMS is involved in regulations pertaining to the fabrication of single service containers, and closures for milk and milk products, and in the evaluation of milk laboratories. The purpose of NCIMS is to promote the best possible milk supply for all the people and to provide for unrestricted availability of milk and milk products in interstate shipment. The NCIMS operates to establish uniformity of product standards from state to state. Both producers and processors of milk are represented in NCIMS. They address issues related to laws and regulations governing Grade A milk sanitation (storage, handling), reciprocity between regulatory jurisdictions and violations of reciprocity.

**STANDARD OF IDENTITY**

All dairy products with standard of identity definition must conform to the FDA standard and the regulations published in Code of Federal Regulations (USDHHS FDA, 2003) (Table 15.1). Chapter 4 contains more information on this topic.

A few dairy products (e.g., butter and nonfat dry milk) are regulated by USDA grading and inspection programs. The FDA has the authority to establish standards of identity for foods whenever doing

**Table 15.1.** Code of Federal Regulations (21 CFR): Standard of Identity for Dairy Foods

	CFR Part:
<i>Dairy food</i>	
General, definitions	130
Milk and cream, definitions	131.3
Milk	131.110
Acidified milk	131.111
Cultured milk	131.112
Concentrated Milk	131.115
Sweetened–condensed milk	131.120
Sweetened–condensed skimmed milk	131.122
Low fat dry milk	131.123
Nonfat dry milk	131.125
Nonfat dry milk fortified with vitamins A and D	131.127
Evaporated milk	131.130
Evaporated skimmed milk	131.132
Low-fat milk	131.135
Acidified low-fat milk	131.136
Cultured low-fat milk	131.138
Skim milk	131.143
Acidified skim milk	131.144
Cultured skim milk	131.146
Dry whole milk	131.147
Dry cream	131.149
Light cream	131.155
Light whipping cream	131.160
Sour cream	131.157
Acidified sour cream	131.162
Eggnog	131.170
Half-and-half	131.180
Sour half-and-half	131.185
Acidified sour half-and-half	131.187
Yogurt	131.200
Low-fat yogurt	131.203
Nonfat yogurt	131.206
<i>Frozen desserts</i>	
Definitions	135.3
Ice cream and frozen custard	135.110
Goat’s milk ice cream	135.115
Mellorine	135.130
Sherbet	135.140
Water ices	135.160
<i>Food labeling</i>	
Food labeling	Part 101
Nutritional quality guidelines for food	Part 104
Current Good Manufacturing Practice in manufacturing, packaging holding human food	Part 110

Source: Adapted from USDHHS, FDA Revised April 1, 2003. <http://www.cfsan.fda.gov/~1rd/FCF131.html>

so will promote honesty and fair dealing in the interest of consumers. Standards generally specify the types of ingredients the food must contain (mandatory ingredients), as well as those it may contain (optional ingredients). Standards also may set minimum and maximum content requirements for valuable constituents as well as for fillers. FDA has established standards for staple food items, including milk, peanut butter, jams and jellies, and milk chocolate. The USDA's Food Safety and Inspection Service (USDA/FSIS) also has standards for foods regulated by that agency.

### FOOD LABELING IN THE UNITED STATES

Detailed discussion for food labeling regulations is described in Chapter 4.

Under the Nutrition Labeling and Education Act of 1990, the FDA promulgated new labeling regulations that became effective on May 8, 1994. Actual label values depend on a particular formulation and actual nutrient analysis relative to the food being labeled. All the nutrients designated in dairy foods label are declared in relation to a standard reference amount (serving size) of the food. The label must declare the amounts per serving for calories, calories from fat, total fat, saturated fat, cholesterol, sodium, total carbohydrates, sugars, dietary fiber, and protein. Also, percentage Daily Reference Values must be shown to a 2,000-calorie and 2,500-calories/day diets for the above nutrients, as well as for vitamins A and C, and calcium and iron to make the label consumer-friendly and useful. Effective January 1, 2006, food labels will also be required to declare the content of fat containing trans fatty acids.

Daily reference value (DRV) relative to various dairy foods is based on an evaluation of scientific data. For example, scientific data indicate that carbohydrates should compose 60% of the daily caloric allowance. Therefore, the DRV for carbohydrates is 300 grams, providing 1,200 calories. This amount of carbohydrate would furnish approximately 60% of reference caloric intake for 2,000 calories per day. Accordingly, if a food serving contains 30 g of carbohydrates, the DV percentage will be 10%.

Daily Reference Values used for calculations for Nutritional Labeling are shown in Table 15.2. The DRV for macronutrients is based on the daily diet of 2,000 calories, except fats, carbohydrates, and fiber, which are based on 2,500-calorie diet. The reference daily intakes (RDI) relates to micronutrients (vitamins and minerals) regardless of caloric intake.

Certain claims on foods have also been defined for inclusion in the label. Table 15.3 lists these product definitions in terms of low fat, nonfat, and other terms.

The percentage value for a food label is calculated as percent of the values shown in Nutritional label for yogurt (Fig. 15.1).

The calorie calculation is based on 4, 4, and 9 cal/g of carbohydrate, protein, and fat, respectively. All the calculated numbers are rounded to the nearest whole number.

The FDA regulations also address health claims as shown below:

- Calcium and osteoporosis: Product must be high in calcium content
- Sodium and hypertension: Product must be low sodium
- Food high in potassium and high blood pressure
- Fat and cancer: Product must be low fat
- Fat and heart disease: Product must be low fat, low saturated fat, and low cholesterol
- Soluble fiber from whole oats and coronary heart disease
- Soluble fiber from psyllium seed husk and coronary heart disease
- Whole grain foods and coronary heart disease
- Fiber-containing grain products, fruits, and vegetables and cancer
- Fruits and vegetables (High in vitamins A and C) and cancer
- Fruits, vegetables, and grain products that contain fiber, particularly soluble fiber and coronary heart disease
- Folate and neural tube defects
- Soy protein and risk of coronary heart disease

In addition, when making any health claims, the product must contain (before fortification) at least 10% of one of the nutrients: Vitamin A, Vitamin C, calcium, iron, protein, or fiber.

Under the current standards, Vitamin A fortification to 2000 International Units (IU) (which is 500 IU or 10 per cent of the daily value (DV) per 8 ounce serving) is optional for yogurt. When Vitamin D is added, its level must be 400 IU per quart (100 IU or 25% of the DV per serving). Because vitamins A and D are fat soluble, they get removed in the process of fat removal from milk. As a result, nonfat and low-fat yogurt would be low in vitamins A and D content as compared to full-fat yogurt. Therefore, addition of Vitamins A and D to low fat and nonfat yogurt is practiced by some yogurt manufacturers.

The general standard also provides that, under certain circumstances, safe and suitable ingredients that



**Table 15.2.** Daily Reference Values and Reference Daily Intakes for Nutrition Labeling (based on a 2000 calorie intake; for adults and children 4 or more years of age) in the United States

Macronutrient	Daily Reference Values (DRV)
Total fat <sup>a</sup> , maximum	65 g
Saturated fatty acids <sup>a</sup> , maximum	20 g
Cholesterol <sup>a</sup> , maximum	300 mg
Sodium <sup>a</sup> , maximum	2.4 g
Potassium <sup>a</sup>	3.5 g
Total carbohydrate <sup>a</sup>	300 g
Fiber <sup>a</sup>	25 g
Protein <sup>a</sup>	50 g
Micronutrient	Reference Daily Intakes (RDI)
Vitamin A <sup>a</sup>	5000 IU
Vitamin C <sup>a</sup>	60 mg
Calcium <sup>a</sup>	1 g
Iron <sup>a</sup>	18 mg
Vitamin D	400 IU
Vitamin E	30 IU
Vitamin K	80 µg
Thiamin	1.5 mg
Riboflavin	1.7 mg
Niacin	20 mg
Vitamin B <sub>6</sub>	2 mg
Folate	400 µg
Vitamin B <sub>12</sub>	6 µg
Biotin	300 µg
Pantothenic acid	10 mg
Phosphorus	1 g
Iodine	150 µg
Magnesium	400 mg
Zinc	15 mg
Selenium	70 µg
Copper	2 mg
Manganese	2 mg
Chromium	120 µg
Molybdenum	75 µg
Chloride	3.4 g

<sup>a</sup> FDA regulations require these nutrients be listed in the Nutrition Facts panel. Labeling of other nutrients is optional.

Source: Adapted from: <http://www.cfsan.fda.gov/~dms/flg-7a.html> REV. Jan 30, 1998.

perform a technical effect (for example, thickeners and stabilizers) may be added to the modified foods to maintain performance characteristics similar to the traditional food.

In addition, the FDA permits certain qualified health claims. The following summarizes them:

1. Qualified Claims About Cancer Risk
  - a. Selenium & Cancer
  - b. Antioxidant Vitamins & Cancer
2. Qualified Claims About Cardiovascular Disease Risk
  - a. Nuts & Heart Disease
  - b. Walnuts & Heart Disease
  - c. Omega-3 Fatty Acids & Coronary Heart Disease
  - d. B Vitamins & Vascular Disease
3. Qualified Claims About Cognitive Function
  - a. Phosphatidylserine & Cognitive Dysfunction and Dementia
4. Qualified Claims About Neural Tube Birth Defects
  - a. 0.8 mg Folic Acid & Neural Tube Birth Defects

**Table 15.3.** Definitions of Nutrient Content Claims

Nutrient	Free	Low	Reduced/Less	Comments
Calories 21 CFR 101.60(b)	Less than 5 cal per reference amount and per labeled serving	40 cal or less per reference amount (and per 50 g if reference amount is small) Meals and main dishes: 120 cal or less per 100 g	At least 25% fewer calories per reference amount than an appropriate reference food Reference food may not be "Low Calorie" Uses term "Fewer" rather than "Less"	"Light" or "Lite": If 50% or more of the calories are from fat, fat must be reduced by at least 50% per reference amount. If less than 50% of calories are from fat, fat must be reduced at least 50% or calories reduced at least 1/3 per reference amount "Light" or "Lite" meal or main dish product meets definition of "Low Calorie" or "Low Fat" meal and is labeled to indicate which definition is met For dietary supplements: Calorie claims can only be made when the reference product is greater than 40 calories per serving "__% Fat Free": OK if meets the requirements for "Low Fat" 100% Fat Free: food must be "Fat Free" "Light"—see above For dietary supplements: calorie claims cannot be made for products that are 40 calories or less per serving
Total Fat 21 CFR 101.62(b)	Less than 0.5 g per reference amount and per labeled serving (or for meals and main dishes, less than 0.5 g per labeled serving) Not defined for meals or main dishes	3 g or less per reference amount (and per 50 g if reference amount is small) Meals and main dishes: 3 g or less per 100 g and not more than 30% of calories from fat	At least 25% less fat per reference amount than an appropriate reference food Reference food may not be "Low Fat"	
Saturated Fat 21 CFR 101.62(c)	Less than 0.5 g saturated fat and less than 0.5 g trans fatty acids per reference amount and per labeled serving (or for meals and main dishes, less than 0.5 g saturated fat and less than 0.5 g trans fatty acids per labeled serving) No ingredient that is understood to contain saturated fat except as noted below <sup>a</sup>	1 g or less per reference amount and 15% or less of calories from saturated fat Meals and main dishes: 1 g or less per 100 g and less than 10% of calories from saturated fat	At least 25% less saturated fat per reference amount than an appropriate reference food Reference food may not be "Low Saturated Fat"	Next to all saturated fat claims, must declare the amount of cholesterol if 2 mg or more per reference amount; and the amount of total fat if more than 3 g per reference amount (or 0.5 g or more of total fat for "Saturated Fat Free") For dietary supplements: saturated fat claims cannot be made for products that are 40 calories or less per serving

*Continued*

**Table 15.3. (Continued)**

Nutrient	Free	Low	Reduced/Less	Comments
Cholesterol 21 CFR 101.62(d)	Less than 2 mg per reference amount and per labeled serving (or for meals and main dishes, less than 2 mg per labeled serving) No ingredient that contains cholesterol except as noted below <sup>d</sup> If less than 2 mg per reference amount by special processing and total fat exceeds 13 g per reference amount and labeled serving, the amount of cholesterol must be “Substantially Less” (25%) than in a reference food with significant market share (5% of market)	20 mg or less per reference amount (and per 50 g of food if reference amount is small) If qualifies by special processing and total fat exceeds 13 g per reference and labeled serving, the amount of cholesterol must be “Substantially Less” (25%) than in a reference food with significant market share (5% of market) Meals and main dishes: 20 mg or less per 100 g	At least 25% less cholesterol per reference amount than an appropriate reference food Reference food may not be “Low Cholesterol”	Cholesterol claims only allowed when food contains 2 g or less saturated fat per reference amount; or for meals and main dish products—per labeled serving size for “Free” claims or per 100 g for “Low” and “Reduced/Less” claims Must declare the amount of total fat next to cholesterol claim when fat exceeds 13 g per reference amount and labeled serving (or per 50 g of food if reference amount is small), or when the fat exceeds 19.5 g per labeled serving for main dishes or 26 g for meal products For dietary supplements: cholesterol claims cannot be made for products that are 40 calories or less per serving
Sodium 21 CFR 101.61	Less than 5 mg per reference amount and per labeled serving (or for meals and main dishes, less than 5 mg per labeled serving) No ingredient that is sodium chloride or generally understood to contain sodium except as noted below <sup>d</sup>	140 mg or less per reference amount (and per 50 g if reference amount is small) Meals and main dishes: 140 mg or less per 100 g	At least 25% less sodium per reference amount than an appropriate reference food Reference food may not be “Low Sodium”	“Light” (for sodium reduced products): if food is “Low Calorie” and “Low Fat” and sodium is reduced by at least 50% “Light in Sodium”: if sodium is reduced by at least 50% per reference amount. Entire term “Light in Sodium” must be used in same type, size, color & prominence. Light in Sodium for meals = “Low in Sodium” “Very Low Sodium”: 35 mg or less per reference amount (and per 50 g if reference amount is small). For meals and main dishes: 35 mg or less per 100 g

“Salt Free” must meet criterion for “Sodium Free”  
 “No Salt Added” and “Unsalted” must conditions of use and must declare “This is Not A Sodium Free Food” on information panel if food is not “Sodium Free”  
 “Lightly Salted”: 50% less sodium than normally added to reference food and if not “Low Sodium”, so labeled on information panel  
 “No Added Sugars” and “Without Added Sugars” are allowed if no sugar or sugar containing ingredient is added during processing. State if food is not “Low” or “Reduced Calorie.” The terms “Unsweetened” and “No Added Sweeteners” remain as factual statements  
 Claims about reducing dental caries are implied health claims  
 Does not include sugar alcohols

Sugars  
 21 CFR  
 101.60(c)

At least 25% less sugars per reference amount than an appropriate reference food  
 May not use this claim on dietary supplements of vitamins and minerals

Not Defined. No basis for recommended intake

“Sugar Free”: Less than 0.5 g sugars per reference amount and per labeled serving (or for meals and main dishes, less than 0.5 g per labeled serving)  
 No ingredient that is a sugar or generally understood to contain sugars except as noted below<sup>a</sup>  
 Disclose calorie profile (e.g., “Low Calorie”)

<sup>a</sup> Except if the ingredient listed in the ingredient statement has an asterisk that refers to footnote (e.g., “<sup>a</sup>adds a trivial amount of fat”).

Note: “Reference Amount” = reference amount customarily consumed; “Small Reference Amount” = reference amount of 30 g or less or 2 tablespoons or less (for dehydrated foods that are typically consumed when rehydrated with water or a diluent containing an insignificant amount, as defined in 21 CFR 101.9.0(1)), of all nutrients per reference amount, the per 50 g criterion refers to the prepared form of the food).

• When levels exceed: 13 g Fat, 4 g Saturated Fat, 60 mg Cholesterol, and 480 mg Sodium per reference amount, per labeled serving or, for foods with small reference amounts, per 50 g, a disclosure statement is required as part of claim (e.g., “See nutrition information for content” with the blank filled in with nutrient(s) that exceed the prescribed levels). Based on <http://www.cfsan.fda.gov/~dms/ftg-6a.html>

Nonfat Light Yogurt Yogurt With Aspartame and other Sweetener. Vitamins A & D Added	Low Fat 1% Milk fat Vitamins A & D added
<b>Nutrition Facts</b>	<b>Nutrition Facts</b>
Serving Size 1 Container (170g)	Serving Size 1 Container (170g)
<b>Amount Per Serving</b>	<b>Amount Per Serving</b>
<b>Calories 100</b>	<b>Calories 170</b>
Calories from Fat 0	Calories from Fat 15
	% Daily Value
<b>Total Fat</b> 0g.	<b>Total Fat</b> 1.5g.
0%	3%
Saturated Fat 0g	Saturated Fat 1g
0%	8%
Trans Fat 0g	Trans fat 0g
<b>Cholesterol</b>	<b>Cholesterol</b> 10mg
Less than 5mg	3%
<b>Sodium</b> 85mg	<b>Sodium</b> 80mg
4%	3%
<b>Potassium</b> 250mg	<b>Potassium</b> 260mg
7%	7%
<b>Total Carbohydrate</b> 19g	<b>Total Carbohydrate</b> 33g
6%	11%
Sugars 14g	Sugars 27g
<b>Protein</b> 5g	<b>Protein</b> 5g
10%	11%
Vitamin A	Vitamin A
15%	15%
Vitamin D	Vitamin D
20%	20%
Calcium	Calcium
20%	20%
Phosphorus	Phosphorus
15%	15%
Not a significant source of Iron, Vitamin C and dietary fiber.	Not a significant source of Iron, Vitamin C and dietary fiber.
* Percent Daily Values are based on a 2,000 calorie diet.	* Percent Daily Values are based on a 2,000 calorie diet.

**Figure 15.1.** Typical nutrition facts label for light nonfat yogurt and low-fat yogurt. The format is shown in Chapter 4, page 67.

**ANALYTICAL TESTS**

To conform to the regulatory standard of identity and company standards of quality, safety and cost, various analytical tests are performed in the industry (Chandan and Shahani, 1993, 1995; Christen, 1993; Tamime and Robinson, 1999). Chapter 7 deals with the laboratory analysis of yogurt and fermented milks. In general, quality tests for milk and dairy products include analysis for chemical composition, physical attributes, microbiological quality,

and sensory characteristics. Analytical tests for milk composition are for fat, total solids, protein, lactose, ash, vitamins, and minerals. Basic quality of milk is assessed by tests such as titratable acidity, added water, foreign materials, antibiotics, sanitizers, aflatoxins, pesticides, and other environmental contaminants. Abnormal milk tests include Wisconsin and California somatic cell counts (SCC) for mastitis. SCC is a measure for white blood cells in the milk and is used as an indicator of herd health. Among the

microbiological tests for raw and pasteurized milk, total aerobic plate count gives a measure of total bacteria present and is a good indicator of the overall milk quality. Coliform count is a marker of sanitary quality of milk. Yeast and mold count is an indicator of the spoilage tendency of low pH products like yogurt, sour cream, and buttermilk. Pathogenic bacteria may gain entry in commercial dairy products as postpasteurization contaminants or by cross contamination with raw milk. Dairy testing in the industry is typically directed toward the incoming milk, cream, condensed, and dry dairy ingredients to determine their suitability for use in the plant operations. Incoming tanker loads of raw milk are generally laboratory-pasteurized and subjected to organoleptic assessment (odor, flavor, and mouth-feel). Various tests on raw milk include temperature check, sediment, fat content, moisture, total solids content, freezing point determination to detect adulteration with water and antibiotic tests. Freshly pasteurized milk and product mixes are tested for coliform count (violet red bile agar) as an overall index of sanitary quality. Pathogenic organisms receiving attention include *Salmonella* spp., *Staphylococcus aureus*, *Yersenia enterocolytica*, *E.coli* 0157: H7, and *Aeromonas hydrophillia* due to profound impact associated with their recent outbreaks of food-borne illness.

With a view to expedite the results of microbiological analyses and to implement corrective actions in a timely manner, various rapid methods are being developed. Accuracy, speed, simplicity, cost, and validity are the key factors in their development.

### Procedures for Analytical Tests

Various physical, chemical, microbiological, and sensory analyses are typically conducted (See Chapter 7) in accordance with the standard official procedures, developed and updated by AOAC International (Horowitz, 2003) and American Public Health Association (Marshall, 1993). For regulatory compliance of Standard of Identity, the FDA specifies certain analytical tests to be performed on a dairy food.

## QUALITY CONTROL PROGRAMS

### General

A well planned quality control program must be executed in the plant to consistently produce products with high quality, to maximize keeping quality, and to deliver yogurt with the with most desirable attributes of flavor and texture to the consumer. As part of this

program, it is imperative to enforce a strict sanitation program along with good manufacturing practices. Shelf-life expectations from commercial yogurt vary but generally approximate 30–55 days from the date of manufacture provided the temperature during distribution and retail marketing channels does not exceed 10°C (45°F). Because lactic acid and some other metabolites produced in the fermentation process protect yogurt from most Gram-negative psychotrophic organisms, most quality issues in yogurt are not related to proliferation of spoilage bacteria.

Most problems related to yogurt spoilage are associated with yeast and molds, which are highly tolerant to low pH and can grow under refrigeration temperatures.

The control of yeast contamination is done by aggressive sanitation procedures related to equipment, ingredients, and plant environment. Clean-in-place chemical solutions should be used with special attention to their strength and proper temperature. Hypochlorites and iodophors are effective sanitizing compounds for fungal control on the contact surfaces and in combating the environmental contamination. Hypochlorites at high concentrations are corrosive. Iodophors are preferred for their noncorrosive property as they are effective at relatively low concentrations. For detailed discussion of sanitizing procedures, see Chapter 14.

Yeast and mold contamination may also arise from starter, fruit preparations, packaging materials, packaging equipment and overall plant environment. Organoleptic examination of yogurt starter may be helpful in eliminating the fungal contamination there from. If warranted, direct microscopic view of the starter may reveal the presence of budding yeast cells or mold mycelium filaments. Plating of the starter on acidified potato dextrose agar would confirm the results. Avoiding contaminated starter for yogurt production is necessary.

Efficiency of equipment and environmental sanitation can be verified by enumeration techniques involving exposure of poured plates to atmosphere in the plant or making a smear of the contact surfaces of the equipment, followed by plating. Also, for a quick check of food contact surfaces prior to production start-up, ATP detection can be used. ATP swabs and use of an ATP luminator provide an indirect measurement of microbes, food residue, or other biological material that is an indicator of the effectiveness of sanitation. In yogurt manufacturing a quick ATP swab on filler valves, fruit hoppers, blending tanks, etc., can identify low levels of contamination in a matter of seconds. Filters on the air circulation system

should be on a maintenance schedule to be checked and changed regularly. Walls and floors should be cleaned and sanitized frequently and regularly.

The packaging materials should be stored in dust-free and humidity-free conditions. The filling room should be fogged with chlorine or iodine regularly.

Quality Control checks on fruit preparations, and flavorings (Chapter 9) should be performed (spot checking) to minimize yeast and mold entry into fruit flavored yogurt. Certificate of analysis (COA's) containing physical, chemical, and microbiological analysis should be requested for each lot.

### Quality Control in Yogurt Plant

Quality control programs for finished yogurt include control of product viscosity, flavor, body and texture, color, pH, and composition. In addition, daily chemical, physical, microbiological, and organoleptic test programs must be in place for ingredients and finished product. Also, the quality control program should include a detailed "plan of control" for critical processing parameters and milk receiving. All of these should be included in the product specifications for the plant. A summary of typical quality tests in a yogurt plant is outlined in Table 15.4.

There are many areas in formulation and processing that when overlooked lead to quality issues in yogurt. The most common flavor defects are generally described as high acid, weak flavor, or unnatural flavoring. The sweetness level may be excessive, weak, or may exhibit corn syrup flavor. The ingredients used may impart undesirable flavors like stale, metallic, old ingredients, oxidized, rancid, or unclean. Lack of control in processing procedures may cause overcooked, caramelized, or excessively sour flavor notes in the product. Proper control of processing parameters and ingredient quality assure a consistent good flavor. Product standards for fat, total solids, viscosity, pH (or, titratable acidity) and organoleptic characteristics should be strictly followed. Wheying off or appearance of watery layer on the surface of yogurt is undesirable and can be controlled by judicious selection of effective stabilizers and by following proper processing conditions.

The evaluation of yogurt quality should be approximately 24 hours (D+1) after packaging. The following organoleptic evaluations are generally performed:

- *Taste*—Typical yogurt flavor, fruit flavor, and mouthfeel. Absence of any off-flavor.
- *Aroma*—Typical yogurt and fruit bouquet.

- *Visual appearance*—Color, fill of container, syneresis, fruit bleeding, white specks in the product, lumpiness, overall body and texture, fruit chunks/integrity.

In addition, the following laboratory analysis should be conducted:

**Titratable Acidity/pH Measurement.** Titratable acidity (TA) is used as a measure of quality in dairy products. %TA is obtained by titrating 9 g of milk/yogurt with a standard alkali to pH 8.6 or the phenolphthalein end point. It is expressed as % lactic acid. A standard procedure for titratable acidity measurement for yogurt is described in the International Dairy Federation publication (IDF1991a).

$$\%TA = \frac{\text{milliliters of 0.1 N alkali}}{10}$$

%TA is attributed to the constituents of serum solids or milk solids-not-fat. In yogurt processing, TA is commonly used for following the progress of fermentation, as well as a quality parameter in finished yogurt product. TA is composed of "apparent" and "developed" acidities. Fresh milk should not have any significant lactic acid content, since it has not been subjected to bacterial growth (acid production from lactose) or severe heat treatment. However, when fresh milk is titrated with a standard alkali, it requires some alkali titer to reach phenolphthalein endpoint. This is "apparent acidity," which is due to salts and proteins present in fresh milk. The approximate contribution of various constituents to TA is: carbon dioxide 0–0.01%; caseins 0.05–0.08%; whey protein 0.01–0.02%; phosphate 0.06%; and citrate 0.01%. Accordingly, an apparent TA of 0.13–0.18% is contributed by milk constituents other than lactic acid.

Developed acidity is the portion of TA that is attributed to lactic acid produced as a result of bacterial fermentation of lactose under anaerobic conditions such as in yogurt. Certain yogurt plants prefer to use pH in place of TA. There is a correlation between %TA and pH. Depending on the milk solids-not-fat content of yogurt, a pH of 4.4 approximately corresponds to 0.85% TA in yogurt processing.

The current consumer preferred pH for yogurt is in the range of 4.2–4.4 at D+1 stage of shelf life. If incubation is not terminated in time to result in this pH range at D+1, the lactobacilli may continue to grow well below pH 4.2 during shelf life. When this occurs, the streptococci start to disappear, upsetting the optimum bacterial ratio and resulting in a product,

**Table 15.4.** Summary of a Typical Yogurt Plant Quality Tests and Their Purpose

Incoming Material	Test	Purpose
Milk	Direct microscopic count Sensory (odor, flavor) Titratable acidity, freezing point depression test, antibiotic assay, fat and total solids tests Temperature	Microbiological quality General quality Freshness, handling practice Water adulteration Insure absence of antibiotics Verify chemical composition Meet company and Regulatory requirements
Starter	pH/titratable acidity, direct microscopic examination	Activity and integrity of yogurt culture
Fruits, nuts, syrups, sweeteners	Yeasts and molds Osmophilic yeasts	Microbial contamination Shelf life of the product
Packaging materials	Sterility testing  Check print quality	Safety/shelf life of the product Verify printing standards
Fresh Product		
Yogurt after 24 hours of packaging	pH/titratable acidity Evaluate flavor and texture Measure Viscosity	Acidity control Assure sensory quality
Yogurt after packaging (Day of manufacturing)	Coliform count	Detecting unsanitary processing or packaging conditions Indicator of postpasteurization contamination
Yogurt 24 hours after packaging (D+1)	Preincubate product in its container at 30°C for 24 hours, followed by yeast and mold count	Prediction of Shelf life
End of Code (store shelf life samples at 7.2°C (45°F))	Sensory pH Observe spoilage	Assure quality standards are met at end of code
Inline Sampling and Plant Sanitation		
Yogurt mix	Fat and total solids after 10–15 minutes of agitation.	Check on formulation
Yogurt mix in fermentation tank	Titratable acidity/pH	Follow progress and determine end point of fermentation
HTST/Filler or packaging machine/glycol or ice water and equipment surfaces	Preincubation followed by Standard Plate Count and coliform count	Contamination with Psychrotrophic organisms and general sanitation
Environmental air and water samples	Standard Plate Count and coliform count	General sanitation practices
Filler Checks	Seals, coding, record weights, fill temperature	Assure proper filing requirements and coding
ATP Swabs	Filler Fruit hopper and/or blender Other contact surfaces	Prestart up sanitation check of yogurt contact surfaces



which is too high acid and weak in typical yogurt flavor.

**Shelf-Life Test.** As a check for shelf-life quality, incubate yogurt cups for 3 days at 30°C to detect yeast contamination, and for 7 days at 20°C for mold detection. This will give an indication of consumer shelf-life issues. For large production runs it is recommended to take samples at the beginning, middle, and end for each flavor. It is also recommended to store yogurt cups at 8–10°C until the end of code life to detect any organoleptic changes in the product. Yeast and mold spoilage manifests on the surface. Yeast spoilage appears as colorless, flat, moist colonies and mold spoilage as white or blue-green spots with the eventual formation of film and overgrowth over the whole surface. Also, the taste and smell of the product might indicate typical bacterial/yeast/mold spoilage or enzymatic degradation. It is important to record the percentage of spoiled cups at the end of code life.

**Compositional Analysis.** Record the fat and total solids of plain yogurt and fermented base before the addition of fruit to insure conformation to proprietary and regulatory obligations. The fat content is measured by the AOAC procedure (Horowitz, 2003) and the total solids are determined by IDF procedure (IDF 1991b).

**Viscosity Measurement.** An instrument such as penetrometer, Brookfield viscometer, or Rheomat, provides a quantitative value that can be assigned to the viscosity of yogurt. An acceptable range can be established and maintained to help produce a more consistent body of yogurt from production batch to batch.

Using Brookfield viscometer, the following procedure is suggested:

1. Temper yogurt sample in the cup to 3.3–4.4°C.
2. Use Brookfield Viscometer model RVT or equivalent and Spindle #5 at 10 rpm. Attach the spindle. Place the yogurt cup on the counter and lower the spindle through the surface of yogurt to level the notch on the spindle to the surface of yogurt.
3. Turn the viscometer on.
4. Depress the lever after 25 seconds and take the reading.
5. Calculate the viscosity (in centipoises) of the sample by multiplying the reading with 400.

Typically, most commercial yogurts fall within the range of 12,000 cps to 30,000 cps.

**Microscopic Examination.** Occasionally, the ratio of yogurt culture bacteria (*S. thermophilus* (ST) and *L. delbrueckii* ssp *bulgaricus* (LB)) in the final yogurt product should be evaluated to provide the history of culture performance. This check is also useful to detect slow down in acid production due to inhibitors or phage attack when one of the yogurt organism ST may form abnormal shape and cell counts.

**Microbiological Analysis.** Generally, yogurt is tested for coliforms, which indicates postpasteurization contamination, since coliforms do not survive pasteurization. This sanitation test is important in clearing yogurt for shipping and marketing.

Another test, which has a strong bearing on the shelf life of yogurt, is yeast and mold count, especially in fruit flavored yogurt. This test should be conducted on yogurt samples that have been preincubated at 30°C for 24 hours before plating.

**Sensory Evaluation of Yogurt After 24 hours.** The plant should develop a quantitative rating scale on the basis of marketing product objectives for flavor, consistency, and appearance. It is important to establish the consumer “minimum acceptable” quality level.

**Control of Overrun in Whipped Yogurt.** In the production of whipped yogurt, the foam formation as a result of aeration of yogurt mix is called overrun. It is important in giving a fluffy texture to whipped yogurt and must be controlled during the aeration process. Overrun (OR) is the volume of yogurt obtained over and above the volume of yogurt mix used and can be calculated as follows:

$$\% \text{ OR} = \frac{(\text{Volume of whipped yogurt}) - (\text{Volume of yogurt mix used})}{(\text{Volume of mix used})} \times 100 \quad \text{Equation 15b}$$

On weight basis:

$$\% \text{ OR} = \frac{(\text{Weight of cup of yogurt mix}) - (\text{Weight of cup of whipped yogurt})}{(\text{Weight of cup of whipped yogurt})} \times 100$$

**Frozen yogurt.** In the production of frozen yogurt the overrun (OR) is an important parameter of the finished product texture and the overall eating quality. It can be calculated as shown in the section as above for whipped yogurt.

In hard-pack frozen yogurt, a coarse and icy texture may be caused by the formation of ice crystals due to fluctuations in storage temperatures. Sandiness may be due to lactose crystals resulting from

too high levels of milk solids. A soggy or gummy defect is caused by too high milk solids-not-fat level or too high sugar content. A weak body results from too high overrun, insufficient total solids or improper stabilization.

Color defects may be caused by the lack of intensity or authenticity of hue and shade. Proper blending of fruit preparations and yogurt mix is necessary for uniformity of color. The compositional control tests are: fat, total solids, pH, overrun, and microscopic examination of yogurt culture to ensure desirable ratio in LB and ST. Also, good microbiological quality of all ingredients is necessary.

### **NATIONAL YOGURT ASSOCIATION CRITERIA FOR LIVE AND ACTIVE CULTURE YOGURT**

National Yogurt Association (NYA) is a nonprofit association of major yogurt producers in the United States. Their mission is to enhance consumption of yogurt and to protect consumer perception and integrity of yogurt. Accordingly, in the absence of FDA requirements for quantitative counts of yogurt bacteria in commercial yogurt, they have established criteria for live and active yogurt through their seal program. It should be noted that any yogurt manufacturer in the United States may declare “live & active” yogurt culture on the label without using the NYA proprietary seal provided that the statement is true and not misleading. According to NYA, live and active culture yogurt (refrigerated cup and frozen yogurt) is the food produced by culturing Grade A dairy ingredients with a characterizing bacterial culture in accordance with the standards of identity for yogurt (21 C.F.R. S 131.200), low-fat yogurt (21 C.F.R. S 131.203), and nonfat yogurt (21 C.F.R. S 131.206). In addition to the use of the bacterial cultures required by the referenced federal standards of identity and by the NYA criteria, live and active culture yogurt may contain other safe and suitable food grade bacterial cultures. The NYA offers a trademark seal for use by its members for declaring the presence of cultures of live and active yogurt cultures on the label.

According to the NYA, heat treatment of live and active yogurt is inconsistent with the maintenance of live and active cultures in the product. Accordingly, heat treatment, which is intended to kill the live and active organisms should not be undertaken after fermentation. Likewise, manufacturers of live and

active culture yogurt should undertake their best efforts to ensure that distribution practices, code dates, and handling instructions are conducive to the maintenance of live and active cultures.

To meet these NYA criteria, live and active culture yogurt must satisfy each of these requirements:

1. The product must be fermented with both *L. delbrueckii* subsp. *bulgaricus* and *S. thermophilus*.
2. For refrigerated yogurt, the total viable count at the time of manufacture will be  $10^8$  CFU per gram. In the case of frozen yogurt, the total viable count at the time of manufacture will be  $10^7$  CFU per gram.
3. The cultures must be active at the end of the stated shelf life as determined by the activity test described in the NYA “Sampling and Analytical Procedures.” Compliance with this requirement shall be determined by meeting the criteria for the activity test on two of the three representative samples of yogurt, which have been stored at temperatures between  $0^{\circ}\text{C}$  ( $32^{\circ}\text{F}$ ) and  $7.2^{\circ}\text{C}$  ( $45^{\circ}\text{F}$ ) for refrigerated cup yogurt and at temperatures of  $-17.8^{\circ}\text{C}$  ( $0^{\circ}\text{F}$ ) or colder for frozen yogurt for the entire stated shelf life of the product. The activity test is met if there is an increase of one log during fermentation.
4. In the case of frozen yogurt, the product shall have a total titratable acidity expressed as lactic acid of at least 0.3% at all times. At least 0.15% of total acidity must be obtained by fermentation. This is confirmed by demonstrating the presence of both D & L forms of lactic acid.

The applicant should submit samples, each representing a single line of product, ideally taken from the beginning, middle, and end of a manufacturing run that demonstrates that the yogurt has met the standard. The samples should be analyzed according to the following procedures:

#### **REFRIGERATED YOGURT**

1. Total viable yogurt counts will be enumerated by the standard procedure (IDF, 2003a, 2003b). The total viable count is the sum of colony forming units of *Streptococcus thermophilus* and *Lactobacillus delbrueckii* subsp. *bulgaricus* per gram of the product.
2. At the end of the stated shelf life designated by the yogurt manufacturer, activity of the culture will be reported for at least two of the three random samples on the NYA “Laboratory Report Form.”

The activity test is carried out by pasteurizing 12% solids nonfat dry milk at 92°C (198°F) for 7 minutes, cooling to 43°C (110°F), adding 3% inoculum of the material under test and fermenting at 43°C (110°F) for 4 hours. The total yogurt organisms in the inoculated milk substrate are to be enumerated both before and after fermentation by IDF methodology (2003a).

The activity test will be reported as log increase in yogurt organisms (CFU/g) following fermentation of the defined substrate under the standard condition at the end of the stated shelf life.

## FROZEN YOGURT

1. The titratable acidity of samples, one each representing beginning, middle, and end of a manufacturing run, will be determined (IDF, 1991a). In addition, the manufacturer must certify that at least 0.15% titratable acidity in the product was derived from yogurt fermentation.
2. Total viable yogurt counts will be enumerated by the IDF procedure (2003). The total viable count is the sum of colony forming units of *Streptococcus thermophilus* and *Lactobacillus delbrueckii* subsp. *bulgaricus* per gram of the product.
3. At the end of the stated shelf life designated by the manufacturer, activity of the culture will be reported for at least two of the three random samples.

The activity test is carried out by pasteurizing 12% solid nonfat dry milk at 92°C (198°F) for 7 minutes, cooling to 43°C (110°F), adding 3% inoculum of the material under test and fermenting at 43°C (110°F) for 4 hours. The total yogurt organisms in the inoculated milk substrate are to be enumerated both before and after fermentation by IDF methodology (2003).

The activity will be reported as Log increase in yogurt organisms (CFU/g) following fermentation of the defined substrate under the standard conditions at the end of the stated shelf life.

## SPECIFICATION PROGRAM

A specification program should include parameters for raw materials, ingredients, and packaging materials as well as the product formulation, processing steps and plan of control in the plant. It should also cover, milk receiving, HACCP, and rework controls, and product storage and shipping. As an example, the specification for milk is shown below.

## Raw Milk Quality Specifications

It involves several parameters as discussed below.

- *Standard Plate Count (SPC)* is a measure of the total bacteria count and measures the overall quality of milk. High SPC can cause reduced shelf life of the finished product and off flavors from enzyme activity and elevated acidity. Federal Standards allow 100,000 CFU/ml maximum for an individual producer (300,000 CFU, commingled). However, some states may differ. For example, Idaho standard is 80,000 CFU/ml maximum and California standard is 50,000 CFU/ml maximum. It is recommended to set the standard at 50,000 CFU/ml.
- *Coliform Bacteria Count* is a measure of milk sanitation. High coliform counts reflect poor milking practices and unsatisfactory cleanliness of the dairy operation. Occasionally, coliform count may indicate sick cows in smaller herds. Coliform is an indicator that food poisoning organisms may possibly be present. There are no Federal Standards for coliform counts in raw milk, but California does have a standard for coliform (750 CFU/ml maximum). A recommended standard is 500 CFU/ml.
- *Laboratory Pasteurized Count (LPC)* is a measure of heat-stable bacteria, which may survive pasteurization. It is performed by heat-treating laboratory samples to simulate batch pasteurization at 62.8°C for 30 minutes and enumerating the bacteria that survive using the SPC method. High LPC results indicate potential contamination from soil and dirty equipment at the dairy. High LPC will cause reduced shelf life of finished products. *Bacillus cereus* is a common soil microorganism that can survive pasteurization resulting in a high LPC. There are no Federal Standards for LPC. However, California standard for LPC is 750 CFU/ml maximum. A recommended standard is 500 CFU/ml.
- *Preliminary Incubation (PI) count* is a measure of bacteria that will grow in refrigerated conditions. The test requires holding the sample at 10°C for 18 hours followed by a Standard Plate Count (SPC) test. PI type of bacteria will be destroyed by pasteurization but can still result in lower quality milk due to enzymatic activity on the protein. High PIs (3- to 4-folds higher than SPCs) are generally associated with inadequate cleaning and sanitizing of either the milking system or cows and/or poor milk cooling.

There are no Federal Standards for PI results in raw milk. Since the type of bacteria and the initial count of the SPC may vary, it is not possible to set a numerical standard for this test although counts higher than 50,000 CFU/ml are excessive for both PI and SPC. A recommended standard is less than two times the SPC count.

- *Somatic Cell Count (SCC)* is a measure of the white blood cells in the milk that is used as an indicator of herd health. High SCCs are undesirable because the yield of all cultured products is proportionally reduced, the flavor becomes salty, development of oxidation increases, and it usually relates to higher SPC in a time-lag process. Staphylococci and streptococci are heat-tolerant bacteria that normally cause mastitis. Coliform bacteria that are easily killed by heat may also cause mastitis. Federal Standards allow 750,000 Cells/ml maximum. State standards vary. For example, Idaho standard is 750,000 Cells/ml maximum and California standard is 600,000 Cells/ml maximum. A recommended standard is 500,000 Cells/ml.
- *Titrateable Acidity (TA)* is a measure of the lactic acid in milk. High bacteria counts will produce lactic acid as the bacteria ferment lactose. Elevated temperatures for extended time will allow the bacteria to grow quickly and generate a higher TA value. The normal range is 0.13–0.16%. Lower values may indicate that alkaline/ buffering chemicals are added to the milk. A recommended standard is 0.13–0.16%.
- *Temperature* According to Federal Law, the temperature of milk must never exceed 7.2°C. A recommended standard is 5.2°C or less.
- *Flavor* is an important indicator of quality. The milk should be fresh, clean and creamy. Elevated bacteria counts can produce off flavors (i.e., acid, bitter). Feed flavors may vary from sweet to bitter and indicate the last items in a cow's diet such as poor feed, weeds, onion, or silage. Elevated somatic cell counts will render milk taste salty and watery. Water in the milk will taste weak. Dirty, "barny," and "cowy" flavors occur from sanitation conditions and air quality at the dairy farm. Oxidized or rancid flavors occur from equipment operation and handling.

There are no federal standards for flavor. All receiving plants should flavor milk (laboratory pasteurized) for defects before accepting it.

A recommended standard is that no off flavor exists.

- *Appearance* is not a measured criterion but is as important as flavor for indications of quality. There are no federal standards for appearance. Most receiving plants will note any color or debris defect in the milk before accepting it. A recommended standard is "White, clean, no debris, and filter screen of two or less (sediment test)".
- *Antibiotics and other drugs* may not be present in milk. All raw milk must conform to Grade A law.

To be considered organic, no milk can be used from a cow that has been treated with antibiotics. For conventional milk, a treated cow will be withheld from the milking herd for about 5 days.

- *Added Water* is an adulteration. Testing the freezing point of milk using a cyroscope indicates if abnormal amounts of water exist in the load. In most states it is illegal to have a freezing point above  $-0.530$  Horvet scale. A recommended standard should be  $-0.530$  Horvet or less.
- *Sediment* is measured by drawing 1 pint of sample through a cotton disk and assigning a grade of 1 (good) to 4 (bad) to the filter. A grade of 1 or 2 is acceptable. A processor also may monitor for sediment by screening the entire load through a 3-inch mesh filter at the receiving line. There are no federal standards. Most receiving plants should require a filter grade of 1 or 2 although 3 may be accepted.

A recommended standard is "No excessive material in a 3-in. sani-guide" filter.

- *Fat and milk solids-not-fat (MSNF)* Milk is composed approximately of 88% water, 3.5% fat, 5.0% lactose, 3.5% protein, and <1% of minerals. MSNF is the percentage of total milk solids minus the fat portion. The Standard of Identity for milk is 3.25% fat and 8.25% MSNF. This is the recommended standard.

## Process and Product Specifications

Process and product specifications pertain to formulation, target processes, and a process plan of control. A manual for the plant should detail finished product characteristics, establish a target value, acceptable limits, and rejection values. The manual should include equipment and processing parameters, plan

**Table 15.5. Defects in Yogurt and Their Causes**

Defect	Causes
Whey separation	Low-fat content Wrong choice of modified starch Insufficient heat treatment of milk Heating or disturbing the coagulum during incubation or thereafter Addition of rennet Insufficient acid formation, e.g., pH 4.8 High incubation temperatures or too fast incubation High acidification before cooling, resulting in too low pH in finished product Mechanical shaking of the gel Low solids content in the mix Air incorporation in the stirred yogurt Poor culture
Weak body	Too low pasteurizing temperature and time Too fast incubation Poor culture Too strong stirring of the gel or abuse in pumping (high shear) Low solids content of yogurt Insufficient or improper addition of the stabilizer Low protein content of the milk Mechanical shaking of the gel before completed coagulation
Sandy/Grainy body	Poor culture Severe heating of the milk causing unstable casein Homogenization of the mix at high temperature and pressure Excessive addition of nonfat dry milk Vibration during incubation Too fast set or incubation Containers disturbed before sufficiently cooled Excessive inoculation rate Poor distribution of starter Wrong type of modified starch
“Ropy”	Addition of slime producing strains of yogurt culture Too low incubation temperature in the production of the yogurt
Gummy	The use of unsuitable stabilizer Faulty incorporation of stabilizers Excessive addition of stabilizers
Slow acid development	Culture imbalance Too low pasteurizing temperature Too low incubation temperature Insufficient inoculum Weak cultures Too high sugar Inhibitors/antibiotics in milk supply Phage infection
Fruity/fermented/yeasty flavor	Growth of microbial contaminants
Oxidized flavor	Effect of exposure to light Metal catalyst

*(Continued)*

**Table 15.5.** (Continued)

Defect	Causes
Lacking in flavor	Culture imbalance Starter growth slowed due to too low heat treatment
Bitter/ off flavor	Culture imbalance (too many lactobacilli) Poor quality milk Microbiological contamination. Poor quality flavoring used
Color of flavoring fading	Microbiological contamination Heavy metal contamination Color unstable at low pH

of controlling them, and finished packaging parameters. In addition, the manual should include quality control test methods and procedures, as well as cleaning and sanitizing procedures.

Similarly, specifications should be set up for fruit preparations, dairy ingredients, and dry milk (DMI, 2003) (Chapter 9, 10, and 11, respectively).

**Weight Control Program.** To conform to weights and measure regulations, it is imperative to set up a program on the basis of tolerances of the yogurt fillers. Based on the variations in the weight of filled cups from the weight set on the filling machine, a statistical model is set up to calculate standard deviations for the weights of product contained in the cups. Final setting on the filler is then made to achieve a given confidence limit, say 95–99% confidence level. To minimize give away of the product, some companies decide to set up fillers to deliver the weight declared on the cup plus two standard deviations, giving 95% confidence limits.

## DEFECTS AND TROUBLE SHOOTING

When using poor ingredients or improper processing methods or improper formulation, several defects can develop in the finished yogurt. Some of the more common defects and their causes are shown in Table 15.5.

Finally, in the consistent manufacture of high-quality yogurt, it is important to give full consideration to the following key areas:

- The use of high-quality milk with adequate protein content.
- Correct heat treatment and homogenization of yogurt mix.

- Absolutely clean processing and packaging equipment.
- Proper inoculation of active pure cultures.
- Maintenance of proper incubation time and temperature.
- Use of high-quality ingredients and flavors.
- Storage of yogurt in a temperature below 4°C.

## REFERENCES

- Chandan RC. 1997. Dairy-Based Ingredients. Eagan Press, St. Paul, MN. pp. 48–49.
- Chandan RC, Shahani KM. 1993. Yogurt. In: YH Hui (Ed), Dairy Science and Technology Handbook, Vol. 2. VCH Publishers, New York, pp. 1–56.
- Chandan RC, Shahani KM. 1995. Other fermented dairy products. In: G Reed, TW Nagodawithana (Eds), Biotechnology, Vol. 9, 2nd ed. VCH Publishers, Weinheim, Germany, pp. 386–418.
- Christen GL. 1993. Analyses in Dairy Science and Technology Handbook vol. I. Y.H. Hui, Editor. VCH Publishers, Inc. N.Y. pp. 83–156.
- Dairy Management, Inc. (DMI). 2003. Concentrated and Dry Milk Ingredients. Dairy Ingredient Application Guide. Chicago, IL.
- Horowitz W. 2003. Official Methods of Analysis, 17th ed., 2nd Rev. AOAC International, Gaithersburg, MD.
- International Dairy Federation. 1991a. Yogurt: Determination of Titratable Acidity. IDF/ISO/AOAC Standard 150:1991.Brussels, Belgium.
- International Dairy Federation. 1991b. Yogurt: Determination of total solids content. IDF/ISO/AOAC Standard 151:1991. Brussels, Belgium.
- International Dairy Federation. 2003a. Yogurt: Enumeration of characteristic microorganisms-Colony Count Technique at 37°C. IDF 117/ISO 7889 Standard, Brussels, Belgium.

- International Dairy Federation. 2003b. Yogurt: Identification of characteristic microorganisms (*Lactobacillus delbrueckii* subsp. *bulgaricus* and *Streptococcus thermophilus*. IDF 146/ISO 9232 Standard 150:1991.
- Marshall, RT (Ed). 1993. Standard Methods for the Examination of Dairy Products. 16th ed. American Public Health Association, Washington, DC.
- Tamime AY, Robinson RK (1999). Yogurt Science & Technology, 2nd ed. Woodhead Publishing Limited, Cambridge, England and CRC Press, Boca Raton, FL.
- United States Department of Health and Human Services, Public Health Services, Food and Drug Administration. Grade "A" Pasteurized Milk Ordinance. 1999 Revision. Publication no. 229. Washington, DC.
- United States Department of Health and Human Services, Public Health Services, Food and Drug Administration (USDHHS FDA). 2003. Code of Federal Regulations. Title 21. Section 131. US Government Publishing Office. Washington, DC. USDHHS, FDA Revised April 1, 2003.<http://www.cfsan.fda.gov/~1rd/FCF131.html>

# 16

## Sensory Analysis of Yogurt

*Yonca Karagül-Yüceer and MaryAnne Drake*

Introduction  
Sensory Analysis Techniques  
Sensory Analysis of Yogurt  
Conclusions  
References

### INTRODUCTION

Sensory qualities (flavor and texture/mouthfeel) are crucial for consumer acceptance. As such, understanding and measuring sensory properties of dairy products is important. Although sensory science is a relatively young field (ca 1940), the importance of flavor and texture to the consumer has existed since products were first traded and sold in the marketplace. This chapter will focus on a brief review of sensory techniques followed by specific applications to yogurt and other fresh fermented dairy products.

### SENSORY ANALYSIS TECHNIQUES

The dairy industry has long recognized the importance of sensory quality and developed tools to assess these parameters before mainstream sensory science evolved. These traditional tools are grading and judging of dairy products (ADSA, 1987; Bodyfelt et al., 1988). Both of these tools are still used today for specific applications in the industry. These tools are not advised for research and product development, as they are not quantitative nor completely qualitative in nature (Drake 2004; Singh et al., 2003). Both grading and judging were developed in the early 1900s (1913 and 1916, respectively) and were designed to rapidly assess the overall product quality based on the presence or absence of predetermined defects. Product

quality is evaluated on the basis of reference to the individual's ideal product. In the case of grading a grade is issued; in the case of judging a numerical quality score is issued.

Grading is still conducted by the US Department of Agriculture through the Agricultural Market Service ([www.ams.usda.gov](http://www.ams.usda.gov)). Any dairy product can theoretically be graded; however, grading has traditionally been conducted on Cheddar cheese, butter, and skim milk powder. Standards also exist for whey and buttermilk powder, condensed milk; and Swiss, Emmentaler, Colby, Monterey Jack, and bulk American cheese. Specific grading criteria do not exist for other dairy products; however, they may still receive a USDA quality approval rating. The USDA quality approval rating can be used on retail packaging as with USDA grades and is based on USDA inspection of the product and facility where it was produced. A set of standards for yogurt to receive the USDA Quality Approved Inspection Shield was published by the AMS in 2001 ([www.ams.usda.gov](http://www.ams.usda.gov)).

The primary function of grading is to provide a specific set of criteria for quality, which can be appraised by an impartial individual (USDA grader). Such criteria can be useful for marketing products and promoting product uniformity. A list of defects and grading criteria for skim milk powder are listed in Table 16.1.

The flavor and texture guidelines published for yogurt are listed in Table 16.2. These criteria are general, and not specific. Products can have quite a distinct flavor and/or texture properties and still receive uniform grades. This discrepancy has been demonstrated with Cheddar cheese and skim milk powders (Drake, 2004). This does not devalue the application of grading to the industry uniformity, but it does



**Table 16.1.** US Standards for Grades of Nonfat Dry Milk (Spray Process).

Ideal Flavor—Reconstituted nonfat dry milk shall possess a sweet, pleasing, and desirable flavor, but may possess slight intensities of the following attributes: Cooked, feed, flat and chalky

Flavor Defect	US Extra Grade	US Standard Grade
Bitter	Not permitted	Slight
Chalky	slight	Definite
Cooked	slight	Definite
Feed	slight	Definite
Flat	slight	Definite
Oxidized	Not permitted	Slight
Scorched	Not permitted	Slight
Storage	Not permitted	Slight
Utensil	Not permitted	Slight

Not permitted—sensory attribute not allowed in product for this grade; slight—slight intensity allowed for this grade; definite—definite intensity allowed for this grade [www.ams.usda.gov](http://www.ams.usda.gov)

mean that grading is not an appropriate tool for product research where very subtle differences can impact experimental conclusions and consumer acceptance.

Dairy products judging or scorecard judging was developed to stimulate and promote student interest in sensory quality of dairy products. Similar to grading, products receive a score based on the presence or absence of specific defined defects (Bodyfelt et al., 1988). Butter was the first product included in the contest. Today, six products are evaluated including strawberry yogurt. A list of judging criteria for strawberry yogurt are listed in Table 16.3. As with grading, product judging is a useful skill and can provide valuable insight when troubleshooting in a manufacturing facility. Neither of these approaches are optimal tools for product research for several reasons. Quality scores generated are not discriminating of subtle differences (both qualitative and quantitative) among products. This means that products may

receive identical or very similar quality scores and yet still display very distinct specific flavor and/or texture differences that the scoring criteria do not take into account. Scores are not uniformly spaced or assigned and thus cannot be subjected to parametric statistical analysis. Finally, judgments are generally made by a few individuals, typically one or two and are not replicated. Even highly experienced or trained individuals can vary from day-to-day in their sensory acuity and judgment. As a result, larger numbers of panelists are recommended for sensitive, reproducible results. Although the use of both grading and judging, as well as other overall quality-based analysis criteria can be found in research literature and will be addressed in this chapter, mainstream sensory techniques have great and powerful application to dairy products research and should be used.

Grading and dairy products judging were developed in the United States. The International

**Table 16.2.** Quality Guidelines for USDA Specifications for Yogurt

#### Flavor

Shall possess a clean acid flavor, free from undesirable flavors such as bitter, rancid, oxidized, stale, yeasty, and unclean. Flavoring ingredients shall be uniformly distributed, flavor shall be pleasing and characteristic of the flavoring used. Flavor shall not be harsh or unnatural.

#### Body/texture

Shall possess a firm, custard-like body with a smooth homogenous texture. A spoonful shall maintain its form without displaying sharp edges, flavoring ingredients shall be uniformly distributed throughout the product.

#### Color/appearance

Shall present a clean, natural color with a smooth velvety appearance. Unflavored yogurt may be a bright white to off-white color. Surface should appear smooth and not exhibit excess whey separation or surface growth or discoloration. Flavoring ingredients shall be uniform in size, distribution, and color.

**Table 16.3.** Quality Judging Criteria for Strawberry Yogurt—Approved by the American Dairy Science Association

Attribute	Defects	Scoring
Appearance	Atypical color	Perfect score (no defects) is 5 Different deductions are subtracted based on the specific defect and the intensity (slight, definite, or pronounced) of the defect
	Color leaching	
	Excess fruit	
	Lacks fruit	
	Lumpy	
	Free whey	
	Shrunken	
Body/texture	Surface growth	Perfect score (no defects) is 5 Different deductions are subtracted based on the specific defect and the intensity (slight, definite, or pronounced) of the defect
	Gel-like	
	Too firm	
	Weak	
	Grainy	
Flavor	Ropy	Perfect score (no defects) is 10 Different deductions are subtracted based on the specific defect and the intensity (slight, definite, or pronounced) of the defect
	High acid	
	Low acid	
	Acetaldehyde	
	Cooked	
	Lacks fine flavor	
	Too high flavor	
	Unnatural flavor	
	Lacks sweetness	
	Too sweet	
	Stabilizer flavor	
	Lacks freshness	
	Unclean	
Oxidized		
Rancid		
Storage		

Source: Bodyfelt et al., 1988.

Dairy Federation has also developed a quality-based method for sensory evaluation of fermented dairy products (IDF, 1997), which covers the evaluation of appearance, consistency, and flavor (Table 16.4). Products are given scores based on their variability from a previously established specification. A numerical interval scale is used to demonstrate the magnitude of the possible deviation from the preestablished sensory product specification. The following scale shows the magnitude of the deviation for each attribute in scoring:

### Points

- 5 conformity with the preestablished sensory specification
- 4 minimal deviation from the preestablished sensory specification
- 3 noticeable deviation from the preestablished sensory specification

2 considerable deviation from the preestablished sensory specification

1 very considerable deviation from the preestablished sensory specification

0 unfit for human consumption

1. The evaluation of *appearance* can be carried out simultaneously by the whole panel with separate scoring; involving the filling and the surface of the product, color, visible purity, presence of foreign matters, spots of mold, seepage of whey, and phase separation. The evaluation is made by examination in the opened package, if necessary by pouring out the product from the package.
2. The evaluation of *consistency* involves thickness, stickiness, and coarseness. Evaluation can be made by blending the product with a (black) spoon before evaluating the sample in the mouth.
3. The evaluation of *flavor* is made by smelling and tasting the product.

**Table 16.4.** Fermented Milk Product Quality Terms

Appearance	Consistency	Flavor
Overfilled	Setting	Watery
Underfilled	Lumps or flakes	Flat
Shrunken	Dripping	Bitter
Heterogeneous surface	Uneven	Cooked
Untypical color	Gritty	Burnt
Brown color	Sticky	Smoked
Non-uniform color	Too thick	Oily
Marbled	Too fluid	Chemical flavor
Air bubbles	Ropy/stringy	Feed flavor
Foreign matter	Dried	Foreign flavor
Separation of whey	Brittle	Light-induced flavor
Mould	Gelatinous	Defective aromatization
Yeast		Defective ingredients
Separation of phases		Cheesy
Sedimentation		Malty
Lack of, or poor distribution of ingredients		Metallic
		Musty
		Oxidized
		Acid
		Sharp
		Harsh
		Sour
		Tallowy
		Yeasty
		Rancid
		Astringent
		Unclean
		Stale/old
		Too sweet
		Too salty
		Soapy, alkaline

Source: IDF, 1997.

The IDF quality terms developed for fermented milk products are listed in Table 16.4.

Mainstream sensory techniques, applicable to all products, both food and nonfood items, include a variety of tools to explore and define sensory properties and consumer perceptions. These groups of tools are comprised of two basic groupings: analytical and affective tests. Several comprehensive textbooks are available on these topics (Lawless and Heymann, 1998; Meilgaard et al., 1999). Analytical tests involve the use of screened or trained panelists whose responses are treated as instrumental data. Such tests include discriminatory tests (difference and threshold) and the most powerful tool in the sensory arsenal: descriptive analysis.

Discrimination tests comprise of tests that are designed to answer the question: Does a difference exist

between samples? These tests are often used to determine the effect of specific processing parameters or ingredient substitutions. They can provide useful information when a trained descriptive panel is not an option. Two common examples are the triangle test and the duo-trio test. Both tests are designed to compare two products at a time (as are most difference tests). If more than two products or treatments are involved, multiple pairwise comparisons will need to be conducted. The triangle test involves the presentation of three randomly coded products. Two of the products are the same; one is different. The panelist is asked to indicate which of the three products is different. For the duo-trio test three products are presented as with the triangle test, but one of the products is labeled as a reference, and the panelists are asked to choose the product that is the same as

the reference. Correct results are tabulated and a binomial calculation or statistical tables (provided in most sensory textbooks) are used to determine if a significant difference exists. A minimum of 15 individuals are recommended for these tests and the discriminatory power is improved if larger numbers are used. Several things are important to note about these types of tests. First preference or acceptance questions *are not* asked in conjunction with a difference determination. Such a question is meaningless as panelists do not even know if the product they choose is actually the different product. Second, difference tests provide evidence that a difference exists between products. They do not provide information on the type of difference nor the amount of difference. Finally lack of a statistical difference does not mean that two products are identical.

Attribute difference tests can be applied when more specific information is desired, but again extensive panel training is not an option. Some examples include paired comparison tests and ranking tests. A paired comparison test allows comparison of one particular attribute between two samples. Ranking tests involve ranking a group of products based on the intensity of a single selected attribute (highest to lowest, most to least). An example would be ranking a set of yogurts based on perceived thickness. Distinct differences for a particular attribute can be provided but results are not quantitative. How close the products are to one another in that particular attribute is not known. Numbers of panelists used are similar to those used for difference tests. Threshold tests can be used to determine the concentration of a particular compound (such as a desirable or undesirable flavor of a particular ingredient) that can be added for sensory detection. There are several types of thresholds and the reader is referred to a sensory textbook for complete definitions. Testing for thresholds are more time-consuming than other discriminatory tests primarily because to obtain a realistic threshold, large numbers of panelists are required (at least 50) and testing must cover the threshold range, which requires multiple presentations. Difference, ranking, threshold, and paired comparison tests can be used as stand-alone sensory tools to solve research problems but they can also be used as quick preliminary tests prior to descriptive sensory analysis.

The purpose of descriptive analysis is to train a group of individuals to evaluate specific sensory properties analytically. Descriptive analysis is the tool of choice for qualitatively and quantitatively differentiating foods. Descriptive analysis of any food

requires a descriptive technique and a lexicon or language to describe the sensory properties. There are several valid approaches to descriptive analysis (Murray et al., 2001; Drake and Civille, 2003). These approaches include flavor profile method, quantitative descriptive analysis (QDA), the Spectrum technique, and other techniques, which have been taken from two or more parts of the previous methods. Sensory languages can be identified for any dairy food and/or dairy food property of interest using any of these approaches. Many sensory languages have been identified for cheeses (Delahunty and Drake, 2004), and sensory languages have also been developed for fluid milk (Chapman et al., 2001), dried dairy ingredients (Drake et al., 2003), and chocolate milk (Thompson et al., 2004).

Panelist selection scales and scale usage, and training are critical parts of any descriptive analysis approach. These specifics are reviewed elsewhere (Drake and Civille, 2003; Meilgaard et al., 1999). A panel or a group of individuals (generally 8–12) is used for descriptive sensory analysis rather than one or two experts. A panel of individuals is used as factors such as age, saliva flow, and onset of fatigue vary between them. Panelists also vary in sensitivity to a particular stimuli, and it is highly probable that they also vary in their concentration response functions. Panelists, even highly trained panelists or experts, can vary in sensory function daily. Thus, a group or panel is used rather than one or two individuals for consistent results. Training a descriptive panel requires time, persistence, practice, and group effort. The amount of time varies with the modality and number of attributes. Visual attributes are generally quicker to train than texture attributes, which are generally quicker to train than flavor or odor attributes. Trained panelists are components of the sensory instrument (the panel). Thus, replication by each panelist is *required* for statistical analysis of results. Trained panelists as instrumental components are not consumers. Thus, liking and preference measurements from these individuals have little or no meaning. Descriptive sensory analysis provides a powerful platform for enhanced product understanding, identifying chemical sources of specific flavor, and understanding consumer results.

Affective tests involve the use of untrained consumers and measure consumer responses. Such tests evaluate consumer liking, attitudes, and perceptions. Focus groups involve qualitative analysis of consumer perceptions, whereas quantitative questionnaires and ballots can be used to probe consumer

intensity and liking of specific attributes and/or concepts. Focus groups involve guided discussion with small groups of screened and selected consumers ( $n = 10\text{--}12$ ). The moderator is experienced in guiding such discussions. Sessions are generally observed through a two-way mirror or are taped for transcribing and observation of nonverbal as well as verbal cues from participants. Focus groups can provide powerful qualitative information for marketing, product development, and product positioning. They are not used often for research. Quantitative questionnaires and ballots probing liking and other attributes are most commonly used in product research. A large number of consumers need to be polled if a reasonable projection of consumer response is to be obtained. A minimum of 50 (untrained) individuals is recommended for these types of evaluations, and more commonly 100 or more individuals are polled. Acceptance and consumer perception of specific product attribute intensities can be quantitatively measured using line or category scales (Lawless and Heymann, 1998). The 9-point hedonic scale is by far the best-known and established scale for measuring consumer responses. Following analysis of variance, product preference can be inferred from specific differences in product liking. Alternatively, preference can be directly determined using a preference question. Numerous questions including overall acceptance, liking, and intensity perception of specific product attributes and preferences can be asked on one consumer ballot. As mentioned previously, measuring hedonic responses of a trained panel provides little useful information and violates the basis for both analytical and affective testing. They are different types of tests and use different groups of respondents.

Consumers provide information on product likes and dislikes. Understanding what specific product attributes drive their likes and dislikes requires the application of descriptive analysis as well as consumer testing. This approach is called preference mapping. Preference mapping is a commonly used tool in understanding the descriptive sensory attributes that drive consumer preferences (McEwan, 1996; Schlich, 1995). The procedure requires an objective characterization of product sensory attributes, achieved by descriptive analysis, which is then related to preference ratings for the product obtained from a representative sample of consumers (Murray and Delahunty, 2000). Both internal and external preference mapping techniques have been implemented in a number of studies with a variety of products, including dairy products (Young et al.,

2004; Thompson et al., 2004; Hough and Sánchez, 1998; Richardson-Harman et al., 2000). Similar approaches can be used to explore sensory and instrumental relationships.

## SENSORY ANALYSIS OF YOGURT

Several studies have addressed sensory properties of yogurts. Quality judging, although far from ideal, has been used prevalently (Tamime and Robinson 1987). Karagül-Yüceer et al. (1999) investigated sensory properties of sweetened low fat (1%) plain yogurt and Swiss-style strawberry and lemon yogurts with/without carbon dioxide treatment. Stored yogurts were evaluated for flavor and texture quality after 7, 21, and 45 days refrigeration. Preference testing with consumers was subsequently used to determine preference. McGregor and White (1986) likewise used dairy product judging to evaluate flavor and texture quality of fruit flavored yogurts with different sweeteners. Farooq and Haque (1991) used quality judging to demonstrate that sucrose esters improved quality of nonfat low calorie yogurt. Penna et al. (1997) used sensory quality assessments of appearance, texture, and flavor to optimize the amount of whey powder that could be added to yogurts without detrimental sensory effects. Quality assessments were used to determine sensory properties of plain yogurts with added oat fiber and fructose (Fernandez-Garcia et al., 1998), drinkable yogurts (Penna et al., 2001), the effect of milk somatic cell counts (Oliviera et al., 2002), and to characterize application of buttermilk powder in yogurts (Trachoo and Mistry, 1998).

Discrimination tests have been used to identify the effects of specific parameters. Triangle tests followed by consumer testing were applied to evaluate sensory properties of yogurts with and without added fiber from different sources (Dello Staffolo et al., 2004). Pairwise difference tests were conducted to establish if differences existed between products with and without added fibers. Subsequently, consumers evaluated overall acceptance of products. Triangle tests were also used to determine the effects of different high-pressure treatments on yogurt mix prior to fermentation (de Ancos et al., 2000), to determine the effect of carbon dioxide treatment of milk used for yogurt (Gueimonde et al., 2002), and to evaluate the effect of pasteurization and the addition of hydrogen peroxide on labneh (strained or concentrated yogurt) quality (Dagher and Ali, 1985).

Descriptive analysis has also been recently applied to yogurts. Al-Kadamany et al. (2003) used a

panel trained to score the intensity of yeasty flavor to determine the shelf life of labneh. To conduct the sensory analysis, seven panelists (four females, three males; age 22–32 years) were selected. The panelists were served with commercial labneh samples, stored for different periods of time, and asked through group discussion to determine and agree on sensory failure attributes. During training sessions, yeasty flavor was detected at an earlier stage than yeasty odor. Thus, yeasty flavor was selected as a key attribute for determining labneh quality. Panelists were then trained to rate the intensity of yeasty flavor. At each sampling time, panelists were presented with a fresh sample labeled a control, fresh sample designated as a control, duplicate samples from a stored pack, and a blind control coded with three-digit random numbers. Panelists used a 7-point intensity scale to rate the magnitude of difference of yeasty flavor of the coded samples from the fresh control product. The shelf life of labneh ranged between 18.5 and 18.9; 8 and 9.5; and 2.7 and 3.1 days at 5°C, 15°C, and 25°C, respectively.

In many cases, sensory attributes evaluated are provided but have not been defined (Table 16.5), whereas

in other studies they have been defined and references provided (Table 16.6). The use of specific definitions and references greatly enhances the application and the ability to reproduce published results. Drake et al., (1999) used descriptive analysis of aroma to characterize the sensory impact of different lactobacilli. The effect of varying levels of sugar (18, 20, 22%) and fruit concentrations (15, 20, 25%) on the sensory properties of frozen yogurt was investigated (Güven and Karaca, 2002). Sensory evaluation of the products was performed on a 20-point scale by five experienced panel members. The attributes asked for panelists to evaluate were “color and appearance,” “structure and consistency,” “taste and smell,” and “totals.” The results indicated that frozen yogurts with 25% strawberry, 20% sugar, and 22% sugar had the potential for consumer acceptance.

Skriver et al. (1999) investigated the sensory texture and instrumental rheological characteristics of stirred yogurts varying in fermentation temperature, heat treatment of milk, dry matter content, and composition of bacterial cultures. Basically two sensory texture attributes, nonoral and oral viscosity, were evaluated. For sensory analysis a modified

**Table 16.5.** Sensory Descriptors Used for the Characterization of Fermented Milks and Yogurts for Which Definitions and References Were not Published

Odor	Appearance and Texture on the Spoon	Flavor/Taste	Mouthfeel	Aftertaste
Intensity	Yellowish	Intensity	Light	Persistent
Milky	Bubbles	Creamy	Thick	Milky
Yogurt	Heterogeneous	Buttery	Floury	Sour milk
Cottage cheese	Compact	Cottage cheese	Sandy	Acid
Sour milk	Lumpy	Acid	Small lumps	Lemon
Pungent	Thick	Sweet	Graininess	Astringent
Onion	Smooth/coarse	Cooked	Firm	Bitter
Cooked		Bitter	Slimy	
Acid		Astringent	Creamy	
Sulfur		Sour milk	Smoothness	
Acetaldehyde		Sour		
Sharp		Watery		
Fruity		Flat		
Unclean		Yogurt		
Diacetyl		Grassy		
Cheddar		Fresh		
Sweet		Bland		
Sweaty		Old ingredient		
Bandaïd				
Fusel oil				
Whey				

Source: Ott et al., 2000; Drake et al., 1999; Biliaderis et al., 1992; Lorenzen et al., 2002; Lee et al., 1990; Modler et al., 1983.

**Table 16.6.** Sensory Attributes and References Used to Describe Sweetened Unflavored and Flavored Yogurts

Attribute	Reference
Color (light to dark)	Visual appearance ranging from light to dark, plain low-fat yogurt is the light reference
Dairy aroma/flavor	Plain low-fat yogurt
Dairy/culture	Buttermilk
Acid/sharp	Lactic acid
Acetaldehyde	0.66 and 2 ppm acetaldehyde in milk
Cooked milk	2% milk heated to 90°C for 30 seconds
Caramel	Kraft caramels
Milky	2% milk
Buttery	Butter
Cheesy	Parmesan cheese
Yeasty	0.1% baking yeast in water
Fruity/sulfur	Cantaloupe
Rotten/sulfur	Boiled eggs
Creamy	Whipping cream/fat-free cream cheese
Sour cream	Sour cream
Cottage cheese	Low-fat cottage cheese
Fresh fruit strawberry (strawberry yogurt)	Fresh frozen strawberries
Jammy strawberry (strawberry yogurt)	Smuckers strawberry jam
Artificial strawberry (strawberry yogurt)	Premixed strawberry Koolaid
Fresh lemon (lemon yogurt)	Fresh wedge of lemon
Lemon juice (lemon yogurt)	Lemon juice
Artificial lemon (lemon yogurt)	Lemon jello
Metallic	Ferrous sulfate –0.1% in water
Chalky	Amount of chalk-like particulates perceived in the mouth, reference is yogurt with 7% added soy protein concentrate
Ropy	The degree to which a strand/rope forms when a spoon is dipped into the product and slowly pulled out
Thickness	Force required to push tongue up through product against palate and then back down
Sweet (sucrose)	Sucrose –7.3% in water, 5 and 10% sucrose in water
Sweet (aspartame) (APM)	APM –400 ppm in water
Bitter	Caffeine, 0.08% caffeine in water
Sour	Lactic acid, 0.32% lactic acid in water, 0.08 and 0.15% citric acid in water
Salty	0.2% NaCl in water
Astringent	Alum –0.1% in water, soak 10 tea bags in 1 qt boiling water for 1 hour
Aftertaste (after 30 seconds)	Overall aftertaste-driven by APM

Source: Harper et al., 1991; King et al., 2000; Barnes et al., 1991a; Drake et al., 2000.

quantitative descriptive analysis was conducted. The samples were evaluated by a trained panel of assessors. A 150-mm unstructured line scale with anchor points placed at 15 and 135 mm from the left was used to score nonoral viscosity and oral viscosity. The attributes were defined thus, enhancing the clarity of the study.

**Nonoral Viscosity (The panel chose “gel firmness,” but the alternative term was used for clarity).** This was assessed by penetrating the yogurt gel with a teaspoon, placing about 5 ml on the surface of the undisturbed yogurt and observing how fast this dissipated. A high disappearance rate of the mounded spoonful indicated a low nonoral viscosity.

**Oral Viscosity (The panel chose “mouthfeel,” but the alternative term was used for clarity).** This was assessed as the perceived degree of thickness when the yogurt was placed in the mouth.

The results indicated that nonoral viscosity was related to low deformation tests ( $G^*$  from oscillation measurements and Brookfield viscosity) and oral viscosity to large deformation tests (posthumus viscosity and thixotropic behavior).

The rheological, sensory, and chemical characteristics of yogurts made from skim milk (SM) and ultrafiltered (UF) SM retentates were compared (Biliaderis et al., 1992). Quantitative descriptive analysis was used to profile selected sensory properties (thickness, graininess, sourness) of yogurt by seven trained panelists. Sensory results indicated a difference between the UF versus SM yogurt samples in perceived thickness and graininess, but not in sourness when examined at similar solids level.

The sensory properties of traditional acidic and mild, less acidic yogurts were determined by a trained panel using descriptive sensory analysis (Ott et al., 2000). For sensory evaluation, odor, taste, and flavor terms were used:

*Odor* refers to the organoleptic attribute perceptible by the olfactory organ (nose) on sniffing certain volatile substances. The term “aroma” was used thereafter, like the term “odor,” without any hedonic aspect.

*Taste* refers to sensations perceived by the taste organ (tongue) when stimulated by certain soluble substances.

*Flavor* refers to a complex combination of the olfactory, gustatory, and trigeminal sensations perceived during tasting.

Panel training and language development were well-characterized. During the first panel training session, panelists were served four samples of yogurt prepared with strains of *Str. thermophilus* and *Lb. delbrueckii ssp. bulgaricus* and were asked to list the terms appropriate to describe the appearance, texture with spoon, aroma, flavor, mouthfeel, and aftertaste of the samples. A total of 55 terms were generated. Additional training sessions were used to (a) expose panelists to more yogurt samples, and possibly identify new terms; (b) present other dairy foods (e.g., cottage cheese, kefir) to help panelists characterize some specific descriptive terms; (c) reduce the total number of terms by eliminating redundant ones or those for which the panel could not reach a consensus; (d) agree on precise definitions of the terms and on the tasting protocol; (e) practice the use of the rating

scale and make sure that panelists rated samples coherently. After training, the panel agreed on a list of 33 terms and an evaluation protocol.

To prepare samples for sensory evaluation, the samples were vigorously shaken until the yogurt was homogeneous, and then poured into small glass pots, which were closed to contain volatiles. Before serving, the samples were equilibrated to room temperature. In each session four samples were presented monadically to the panelists with random three-digit codes and in a balanced presentation order. Panelists were asked to open the lid and to evaluate odor first and then the appearance and texture with the spoon. After placing product in the mouth, flavor and texture attributes in the mouth were rated. Finally, 10 seconds after swallowing the sample, they evaluated aftertaste attributes. Each attribute was associated with a 12 cm unstructured linear intensity scale with two anchors at 3 mm from each extremity. Rating marks on the scale were converted to numerical values (left anchor = 0; right anchor = 100).

Descriptive sensory analysis and time intensity measures were investigated to measure flavor changes and perceived sweetness in yogurt made with three concentrations of aspartame (APM) and fat (200, 400 or 600 ppm APM and 1% or 2% fat respectively) (King et al., 2000). Twelve panelists were trained in descriptive methodology and time-intensity evaluation techniques. For descriptive sensory analysis, panelists rated samples using a 15 cm anchored line scale. For time-intensity measurements, panelists consumed a single tsp of sample, swirled it in their mouth for 5 seconds, and then swallowed. After swallowing assessors began to rate the sweetness aftertaste intensity for a total of 1 minute. The results of this study showed that aspartame concentration had a greater effect on flavor characteristics and sweetness aftertaste than did fat content. Addition of aspartame reduced the yogurt-based related flavor properties, while enhancing the sweetness and aftertaste in the product. Addition of fat reduced some of the sweetness impact demonstrating that fat has the potential of reducing some of the lingering sweetness that may be objectionable to consumers.

Sensory analysis was used to compare flavor and texture properties of milk-based yogurt to soymilk yogurt (Lee et al., 1990). Soymilk yogurts were characterized by a lack of acidity and typical yogurt flavors. Drake et al. (2000) used descriptive analysis to determine sensory properties of low-fat yogurts fortified with 0, 1, 2.5, or 5% soy protein concentrate



during 1-month storage at 5°C. Descriptive analysis was conducted on the yogurts following the Spectrum™ procedures. During training, the panelists were asked to identify and define appearance, flavor, and texture terms for the yogurts. Panelists were presented with an array of yogurts with and without added soy protein to generate the descriptive terms with definitions and references. Attributes for appearance (color, free whey), aroma (fermented dairy, soy), flavor/taste/feeling factors (soy, fermented dairy, acidity, sweetness, astringency), and texture (ropiness, chalkiness, thickness) were selected.

Evaluations were divided into three categories including visual, flavor/aroma, and texture evaluation. Panelists evaluated sample sets for visual attributes followed by evaluation of separate sample sets for flavor/aroma evaluation and texture evaluation. Yogurt with 5% soy protein was darker, chalkier, and less sweet compared to control yogurt with lower concentrations of soy protein. In addition, yogurts with 1 or 2.5% soy protein were most similar to control yogurt. Descriptive analysis was subsequently used to explore the specific effects of soy protein addition, sweetener type, and fruit flavoring on dairy yogurts (Drake et al., 2001).

Trained-panel sensory analysis of appearance and texture demonstrated that whey protein concentrates produced yogurts with improved sensory attributes compared to yogurts stabilized with casein-based products (Modler et al., 1983). Trained panelists evaluated sensory properties of milks fermented with different mesophilic starter cultures as part of a larger study to characterize the effect of different cultures on fermented milk properties (Kniefel et al., 1992). Texture profiling (a form of descriptive texture analysis) was used to profile the texture properties of yogurts made using exopolysaccharide-producing starter cultures (Marshall and Rawson, 1999). Lorenzen et al. (2000) used attribute profiling with experienced assessors to determine the effect of enzymatic cross-linking of milk proteins on yogurt odor, flavor, and consistency. Hekmat and McMahon (1997) used trained panelists to characterize the effect of iron fortification of yogurts on specific sensory attributes (oxidized and metallic flavors, bitter taste). Trained panelist analysis of yogurt has also been used as a model system to study the effect of fat on flavor release and texture perception (Brauss et al., 1999).

Many of the previously mentioned studies evaluated consumer acceptance using untrained

consumers following analytical sensory testing. However, consumer testing alone can be a useful tool provided a large enough sample of consumers is polled. Carbonated and strawberry flavored yogurt drink was produced to attract customers who would normally not enjoy a traditional yogurt product (Choi and Kosikowski, 1985). For this purpose yogurt and soft drink consumers evaluated products using a 7-point hedonic scale (where 1 = dislike very much to 7 = like very much). Carbon dioxide had no effect on specific sensory properties through 45 days of storage or consumer preference. Adhikari et al. (2000) used consumer testing to determine acceptability of plain yogurts with and without encapsulated Bifidobacteria. Consumers ( $n = 547$ ) were used to ascertain acceptance and attitudes toward soy-fortified dairy yogurts (Drake and Gerard, 2003).

Harper et al. (1991) used a combined approach of descriptive analysis and consumer testing to evaluate the sensory properties of commercial plain yogurts. Seventeen plain yogurts (whole, low fat, and fat free) were evaluated. Consumers ( $n = 153$ ) evaluated yogurts for liking attributes using a 9-point hedonic scale while sweetness, sourness, and thickness were evaluated for “just right” intensities using a 7-point just right scale. Wide variability in attribute intensities was noted among the yogurts. Consumer results indicated that consumers preferred plain yogurts that were less sour and more sweet in taste. Laye et al. (1993) likewise demonstrated that untrained consumers could differentiate between fresh plain yogurts. A similar descriptive and consumer panel study was also conducted with strawberry and lemon yogurts (Barnes et al., 1991a). Acceptance of commercial flavored yogurts differed for men and women, but trained panel sweet taste was correlated with consumer acceptance. In a subsequent study, the same lab used descriptive analysis of sweet and sour tastes in combination with consumer testing to explore relationships between trained panel sweet and sour taste scores and consumer acceptance of plain, strawberry, raspberry, and lemon yogurts (Barnes et al., 1991b). Trained panel sweet and sour taste scores were useful in predicting consumer liking of fruit-flavored yogurts.

## CONCLUSIONS

Sensory quality (appearance, texture, flavor) ultimately determines consumer acceptance. The use of appropriately designed sensory tests, tools, and

statistical analyses is a powerful technique for measuring the specific sensory effects of processing parameters and ingredients. Testing with appropriate numbers of consumers provides compelling information on consumer acceptance. Many recently developed sensory tools have been effectively applied to other dairy foods. Future sensory work with yogurt should focus on the application of these recent and powerful tests.

## REFERENCES

- Adhikari K, Mustapha A, Grun IU, Fernando L. 2000. Viability of micro-encapsulated Bifidobacteria in set yogurt during refrigerated storage. *J. Dairy Sci.* 83:1946–1951.
- ADSA. 1987. Committee on Evaluation of Dairy Products. Score Card and Guide for Cottage Cheese. Amer. Dairy Sci. Assoc., Champaign, IL.
- Al-Kadamany E, Khattar M, Haddad T, Toufeili I. 2003. Estimation of shelf-life of concentrated yogurt by monitoring selected microbiological and physicochemical changes during storage. *Leben Wiss Technol.* 36:407–414.
- Barnes DL, Harper SJ, Bodyfelt FW, McDaniel M. 1991a. Correlation of descriptive and consumer panel flavor ratings for commercial pre-stirred strawberry and lemon yogurts. *J. Dairy Sci.* 74:2089–2099.
- Barnes DL, Harper SJ, Bodyfelt FW, McDaniel M. 1991b. Prediction of consumer acceptability of yogurt by sensory and analytical measures of sweetness and sourness. *J. Dairy Sci.* 74:3746–3754.
- Biliaderis CG, Khan MM, Blank G. 1992. Rheological and sensory properties of yogurt from skim milk and ultrafiltered retentates. *Int. Dairy J.* 2:311–323.
- Bodyfelt FW, Tobias J, Trout GM. 1988. Sensory evaluation of cultured milk products. *The Sensory Evaluation of Dairy Products*. AVI Publishers, New York.
- Brauss MS, Linforth RST, Cayeux I, Harvey B, Taylor AJ. 1999. Altering the fat content affects the flavor release in a model yogurt system. *J. Agric. Food Chem.* 47:2055–2059.
- Chapman KW, Lawless HT, Boor KJ. 2001. Quantitative descriptive analysis and principal component analysis for sensory characterization of ultra-pasteurized milk. *J. Dairy Sci.* 84:12–20.
- Choi HS, Kosikowski FV. 1985. Sweetened plain and flavored carbonated yogurt beverages. *J. Dairy Sci.* 68:613–619.
- Dagher S, Ali A. 1985. Effect of pasteurization, centrifugation and additives on quality of concentrated yogurt (labneh). *J. Food Prot.* 48:300–302.
- de Ancos B, Cano MP, Gomez R. 2000. Characteristics of stirred low-fat yogurt as affected by high pressure. *Int. Dairy J.* 10:105–111.
- Delahunty CM, Drake MA. 2004. Sensory character of cheese and its evaluation. In: PF Fox, PLH McSweeney, TM Cogan, TP Guinee (Eds), *Cheese: Chemistry, Physics and Microbiology*, Vol. 1, General Aspects, 3rd ed. Elsevier, London, pp. 455–487.
- Dello Staffoloa M, Bertolaa N, Martinoa M, Bevilacqua A. 2004. Influence of dietary fiber addition on sensory and rheological properties of yogurt. *Int. Dairy J.* 14:263–268.
- Drake MA. 2004. Defining dairy flavors. *J. Dairy Sci.* 87:777–784.
- Drake MA, Chen XQ, Tamarapu S, Leenanon B. 2000. Soy protein fortification affects sensory, chemical and microbiological properties of dairy yogurts. *J. Food Sci.* 65:1244–1247.
- Drake MA, Civille GV. 2003. Flavor lexicons. *Compr. Rev. Food Sci.* 2(1):33–40.
- Drake MA, Gerard PD. 2003. Consumer attitudes and acceptability of soy fortified yogurts. *J. Food Science.* 68(3):1118–1112.
- Drake MA, Gerard PD, Chen XQ. 2001. Effects of sweetener, sweetener concentration and fruit flavor on sensory properties of soy fortified yogurt. *J. Sensory Stud.* 16:393–406.
- Drake MA, Karagul-Yuceer Y, Cadwallader KR, Civille GV, Tong PS. 2003. Determination of the sensory attributes of dried milk powders and dairy ingredients. *J. Sensory Stud.* 18:199–216.
- Drake MA, Karagul-Yuceer Y, Chen XQ, Cadwallader KR. 1999. Characterization of desirable and undesirable lactobacilli from cheese in fermented milk. *Leben Wissen Technol.* 32:433–439.
- Farooq K, Haque ZU. 1991. Effect of sucrose esters on the textural properties of nonfat low calorie yogurt. *J. Dairy Sci.* 75:2676–2680.
- Fernandez-Garcia E, McGregor JU, Traylor S. 1998. The addition of oat fiber and natural alternative sweeteners in the manufacture of plain yogurt. *J. Dairy Sci.* 81:655–663.
- Gueimonde M, Alonso L, Delgado T, Bada-Gancedo JC, Reyes-Gavilan CG. 2002. Quality of plain yoghurt made from refrigerated and CO<sub>2</sub>-treated milk. *Food Res. Int.* 36:43–48.
- Güven M, Karaca OB. 2002. The effects of varying sugar content and fruit concentration on the physical properties of vanilla and fruit ice cream-type frozen yogurts. *Int. Dairy Technol.* 55:27–31.

- Harper SJ, Barnes DL, Bodyfelt FW, McDaniel MR. 1991. Sensory ratings of commercial plain yogurts by consumer and descriptive panels. *J. Dairy Sci.* 74:2927–2935.
- Hekmat S, McMahon DJ. 1997. Manufacture and quality of iron-fortified yogurt. *J. Dairy Sci.* 80:3114–3122.
- Hough G, Sanchez R. 1998. Descriptive analysis and external preference mapping of powdered chocolate milk. *Food Qual. Pref.* 9(4):197–204.
- IDF. 1997. Sensory Evaluation of Dairy Products by Scoring—Reference Method. International IDF Standard. 99C:1997. Brussels: Belgium.
- Karagül-Yüceer Y, Coggins PC, Wilson JC, White CH. 1999. Carbonated yogurt: Sensory properties and consumer acceptance. *J. Dairy Sci.* 82:1394–1398.
- King SC, Lawler PJ, Adams JK. 2000. Effect of aspartame and fat on sweetness perception in yogurt. *J. Food Sci.* 1056–1059.
- Kniefel W, Kaufmann M, Fleischer A, Ulberth F. 1992. Screening of commercially available mesophilic dairy starter cultures: Biochemical, sensory, and microbiological properties. *J. Dairy Sci.* 75:3158–3166.
- Lawless HT, Heymann H. 1998. Sensory Evaluation of Food: Practices and Principles. Chapman and Hall, NY.
- Laye I, Karleskind D, Morr CV. 1993. Chemical, microbiological, and sensory properties of plain nonfat yogurt. *J. Food Sci.* 58:991–995.
- Lee SY, Morr CV, Seo A. 1990. Comparison of milk-based and soymilk-based yogurt. *J. Food Sci.* 55:532–536.
- Lorenzen PC, Neve H, Mautner A, Schlimme E. 2002. Effect of enzymatic cross-linking of milk proteins functional properties of set-style yogurt. *Int. J. Dairy Technol.* 55:152–157.
- Marshall VM, Rawson HL. 1999. Effects of exopolysaccharide-producing strains of thermophilic lactic acid bacteria on the texture of stirred yogurt. *Int. J. Food Sci. Technol.* 34:137–143.
- McEwan JA. 1996. Preference mapping for product optimization. In: T Naes, E Risvik (Eds), *Multivariate Analysis of Data in Sensory Science*. Elsevier, Amsterdam, pp. 71–80.
- McGregor JU, White CH. 1986. Effect of sweeteners on the quality and acceptability of yogurt. *J. Dairy Sci.* 69:698–703.
- Meilgaard MC, Civille GV, Carr BT. 1999. Sensory Evaluation Techniques, 3rd ed. CRC Press, Boca Raton, FL.
- Modler HW, Larmond ME, Lin CS, Froehlich D, Emmons DB. 1983. Physical and sensory properties of yogurt stabilized with milk proteins. *J. Dairy Sci.* 66:422–429.
- Murray JM, Delahunty CM. 2000. Mapping consumer preference for the sensory and packaging attributes for Cheddar cheese. *Food Qual. Pref.* 11:419–35.
- Murray JM, Delahunty CM, Baxter IA. 2001. Descriptive sensory analysis: present and future. *Food Res. Int.* 34:461–471.
- Oliviera CA, Fernandes AM, Neta OCC, Fonseca LFL, Silva EOT, Balian SC. 2002. Composition and sensory evaluation of whole yogurt produced from milk with different somatic cell counts. *Austr. J. Dairy Technol.* 57:192–196.
- Ott A, Hugi A, Baumgartner M, Chaintreau A. 2000. Sensory investigation of yogurt flavor perception: Mutual influence of volatiles and acidity. *J. Agric. Food Chem.* 48:441–450.
- Penna ALB, Sivieri K, Oliveira MN. 1997. Optimization of yogurt production using demineralized whey. *J. Food Sci.* 62:846–850.
- Penna ALB, Sivieri K, Oliveira MN. 2001. Relation between quality and rheological properties of lactic beverages. *J. Food Eng.* 49:7–13.
- Richardson-Harman NJ, Stevens R, Walker S, Gamble J, Miller M, Wong M, McPherson A. 2000. Mapping consumer perceptions of creaminess and liking for liquid dairy products. *Food Qual. Pref.* 11:239–246.
- Schlich P. 1995. Preference mapping: Relating consumer preferences to sensory or instrumental measurements. In: P Etiévant, P Schreier (Eds), *Bioflavour=95. Analysis/Precursor Studies/Biotechnology*. INRA Editions, Versailles, pp. 231–245.
- Singh T, Drake MA, Cadwallader KR. 2003. Flavor of Cheddar cheese: A chemical and sensory perspective. *Compr. Rev. Food Sci.* 2:139–162.
- Skriver A, Holstborg J, Qvist KB. 1999. Relation between sensory texture analysis and rheological properties of stirred yogurt. *J. Dairy Res.* 66:609–618.
- Tamime AY, Robinson RK. 1987. *Yoghurt Science and Technology*. Oxford: Pergamon Press.
- Thompson JL, Drake MA, Lopetcharat K and Yates MD. 2004. Preference mapping of commercial chocolate milks. *J. Food Sci* 69(11/12):S406–S413.
- Trachoo N, Mistry VV. 1998. Application of ultrafiltered sweet buttermilk and sweet buttermilk powder in the manufacture of nonfat and low fat yogurts. *J. Dairy Sci.* 81:3163–3171.
- Young ND, Drake MA, Lopetcharat K, McDaniel MR. 2004. Preference mapping of Cheddar cheese with varying maturity levels. *J. Dairy Sci.* 87:11–19.

# **Part III**

# **Manufacture of Fermented Milks**

# 17

## Cultured Buttermilk

*Charles H. White*

Milk Supply  
Processing of Milk  
Buttermilk Starter Culture  
Breaking, Cooling, Bottling, and Distribution  
Acknowledgment  
References

The term buttermilk can be somewhat confusing in that buttermilk can mean:

1. The liquid remaining after cream is churned into butter.
2. The milk product made by adding a bacterial culture to fat free, low fat, reduced fat, or whole milk.

The second product is a topic that merits our discussion. The product has great popularity as a baking aid but also as a satisfying milk beverage. As a milk beverage, it is a product that fits the image of a nutritious food that can be extremely refreshing. Vedamuthu (1985) stressed the sales potential for buttermilk by considering:

- Buttermilk contains all the high-quality nutrients that are found in milk. It is rich in calcium, and unlike cheeses, there is no loss of the high-quality whey proteins in its production.
- There is little or no milk fat in buttermilk, since it is made from skim milk (buttermilk can be made with milk of varying fat content, which can even taste better than that made from skim).
- Unless salted, which in many cases is unnecessary, buttermilk can be labeled as a sodium free or low sodium product (many people agree that buttermilk tastes better with added salt).
- There is about 15% less lactose in buttermilk as compared with milk.

- Buttermilk provides an excellent base for making various kinds of dressings and baked goods, which require a smooth, tangy flavor.

Buttermilk has steadily declined in per capita consumption from 4.7 pounds in 1975 to 2.1 in 2001 (USDA-IDFA). Some of this decline is because of more interest in buttermilk for baking purposes rather than just for drinking. Also, the unfamiliarity with cultured buttermilk as a refreshing drink has spread in the current generation. As a result, the poor quality of some buttermilk has caused first-time consumers to not want to become a repeat consumer. A lack of good refrigerated temperature control results in poor quality buttermilk in many restaurants. The American Cultured Dairy Products Institute has held annual product clinics. At these clinics, cultured dairy products of members would be evaluated by expert sensory judges. During a 4-year period (1972–1975), of 87 samples of buttermilk, 55 (63%) were found to have a flavor of only fair or poor quality. Only one sample was judged to be excellent. Since that time, the flavor quality of buttermilk has not changed appreciably. From a technical point of view, buttermilk should be the easiest cultured dairy product to make; however, this product consistently scores lower than other cultured products in product clinics.

Many people judge a dairy processor based on the quality of buttermilk produced, since this product can be the showcase of a dairy. The thinking tends to be that if a company produces good buttermilk, the other products also have to be good. Vedamuthu (1985) indicates that the successful marketability of buttermilk is based on four major product characteristics:

1. Body—Thick body
2. Texture—Smooth texture

3. Flavor—Good blend of acid, diacetyl, and some carbonation, and
4. Freshness—Shelf-life or keeping quality

Many times body and texture are put together but they are different characteristics. Flavor is extremely important and can actually consist of more than just taste. Aroma is a big part of flavor as are mouthfeel and aftertaste.

Lundstedt (1975) suggested that there are five phases, which must be considered in the manufacture of cultured buttermilk:

1. Quality of the milk
2. Preparation of the milk for buttermilk
3. Cultures and ripening of the milk
4. Cooling and pumping the buttermilk to the filling machine
5. Storage and distribution of the buttermilk

In looking more specifically at these major phases, White (1977, 1979) outlined the key steps in good buttermilk manufacture:

#### *Key Steps in the Manufacture of Cultured Buttermilk*

1. Milk supply
  - a. Never use returned milk
  - b. Free of inhibitory substances (antibiotics and sanitizers)
  - c. High bacterial quality
  - d. Needs some fat, 1.0–1.8% minimum
  - e. Standardized milk solids-not-fat content
2. Processing of milk
  - a. Standardization
  - b. Homogenization
  - c. Heating
    - 85°C (185°F) for 30 minutes
    - 88–91°C (190–195°F) for 2.5–5.0 minutes
3. Addition and development (acidity and flavor) of lactic starter culture
4. Breaking, cooling, bottling, and distribution

## **MILK SUPPLY**

Buttermilk may contain cream, milk, partially skimmed milk, or skim used alone or in combination. It may also be made from concentrated skim, nonfat dry milk (NFD), or other milk derived ingredients to increase the nonfat solids content of the food (CFR, 2000). Not just the raw milk but all ingredients used in making buttermilk must be of high quality. Such ingredients include salt, sodium citrate (a source of diacetyl for the flavor producing bacteria), NFD,

and/or whey protein concentrate (WPC) as a source of added milk solids, stabilizer, and culture.

Fresh fluid milk should be used whenever possible. When using milk powder, fat should be incorporated to approximately 1% with 40% cream, which appears to be superior to whole milk as a source of fat. The fat content of buttermilk ranges all the way from approximately 0.05% to 3.5% milkfat. For optimal flavor, most processors find that milk with at least 1.0–1.8% fat produces the most acceptable product.

Regardless of the source of solids, there must be the absence of any stale or “off” note, which will almost certainly carryover into the finished product. Care must be taken to ensure a consistent product with regard to the body and viscosity when using different sources of fat and solids. Seasonal variations can also reflect changes in the body and flavor of buttermilk. Solids may be added in high-volume periods to keep the body constant.

Sodium citrate may be added as a basis for diacetyl production. A recommended level of addition is 0.10% w/w (legal maximum is 0.15% w/w). In times of the year, when solids are reduced more, citrate may be required for good diacetyl production than is naturally present in the raw milk. Many processors add sodium citrate on a regular basis to ensure a ready source of citrate for the *Leuconostocs* or “flavor producers” (Petersen, 1997). Diacetyl is a key flavor compound, which can result in excellent buttermilk. In the past some processors did not believe that one needed to add stabilizer to make good buttermilk. These thoughts have changed due to longer distribution chains and buttermilk being packaged in clear plastic containers. Extensive syneresis or wheying off can look very unattractive in the dairy case. One should avoid using too much stabilizer to eliminate the possibility of a “slick” body. Follow the recommendation of the stabilizer supplier for best results. In an excellent overview of buttermilk, Danisco (2003) summarizes the commonly used stabilizers in making cultured buttermilk.

1. Food starch or modified food starch—Added to increase viscosity, the modified product is reported to give better water-binding properties, improved acid tolerance, and shear stability.
2. Locust bean gum—Increases viscosity. Synergistic with carrageenan.
3. Carrageenan—Added to reduce tendency of buttermilk to whey-off.

The direct microscopic count and the standard plate count are still the most commonly used methods

to evaluate the microbial quality of the raw milk. Although the legal maximum for commingled raw milk in the United States is 300,000 cfu/ml, a lower standard should be utilized by the processor to further ensure that only high-quality milk is being used. The coliform test can also provide meaningful information as to the quality of the raw milk. Although most states do not have coliform standards for raw milk, high numbers can indicate that the milk has been handled in an unsanitary manner, e.g., improperly cleaned/sanitized equipment. Just as with pasteurized products, coliforms are “indicator” organisms, in that their presence indicates that conditions are suitable for the presence of enteric pathogens. A reasonable goal would be <100 coliforms per milliliter of milk.

At any rate, the quality of raw milk must be high. Each raw milk load should be tested for the following (at a minimum) *prior to* unloading the milk:

- Direct microscopic count (DMC)
- Inhibitory substances (antibiotics)
- Temperature
- Sensory evaluation (aroma and taste after lab pasteurization)
- Sediment

Other tests may be run after the milk has been pumped into the silo storage tanks. These could be normal compositional tests or troubleshooting tests such as the acid degree value (for rancid milk), lab pasteurization count (for thermodurics), titratable acidity, etc. If there is a high psychrotrophic population in the raw milk, heat-stable proteases and lipases can cause flavor problems in any type of dairy food. Some estimate of the psychrotrophs needs to be done on a regular basis.

## PROCESSING OF MILK

The milk should be standardized to a minimum of 9.0% solids-not-fat if fresh skim is being used. If using a low-heat powder, a 10% SNF should be required (White, 1979). The firmer the body desired, the higher the SNF level needed. In no case should the total solids of the buttermilk be allowed to fall under 10% if full-bodied buttermilk is desired. Salt should be added prior to pasteurization to get the desired taste. A level of 0.10–0.20% by total batch weight is common and yields a recognizable and desirable diacetyl flavor (Danisco 2003).

Following standardization/fortification, milk is subjected to a heat treatment. To achieve the desired effects of denaturing the whey proteins (to achieve

the desired viscosity) and destroying the microbial contaminants, milk should be heated either to 85°C (185°F) for 30 minutes or 88–91°C (190–195°F) for 2.5–5 minutes. Although most processors using the batch method claim a better body in the finished buttermilk, heating to higher temperatures at the same hold results in a thinner body. Extended holding tubes on the high-temperature-short-time (HTST) pasteurizing give plants more flexibility with regard to their heating capabilities.

Prior to final heating, the milk should be homogenized at approximately 1800 psi to improve the body/viscosity of the finished product. The temperature of the milk at the homogenizer should be maintained approximately at 49°C (120°F).

It has been reported (Danisco, 2003) that the pumping and cooling steps can have the biggest influence on the final viscosity. These reports indicated that intermittent cooling with side swept agitation is the best. In moving the buttermilk from the buttermilk vat/tank to the filler, avoid the use of a centrifugal pump, which adds air and reduces the product viscosity.

## BUTTERMILK STARTER CULTURE

After processing, the milk is cooled to a temperature from 22.2°C (72°F) to 23.3°C (74°F) and pumped to the buttermilk vat/tank when it is ready to be inoculated with the starter culture. The culture manufacturer’s directions for storage and handling of the starter should be strictly followed. To understand the temperature and time of product inoculation required for good flavor and body characteristics, one must realize the characteristics of the bacteria in the starter culture. There are two types of bacteria:

1. *Lactic acid producers*. Typically *Lactococcus* (formerly streptococcus) *lactis* subsp. *cremoris* and *Lactococcus lactis* subsp. *lactis* are used. These two bacteria with many different strains are homofermentative, since they convert lactose to only lactic acid (Harris, 1997). Their optimum temperature is 30°C (86°F).
2. *Flavor (diacetyl) producers*. *Leuconostoc mesenteroides* subsp. *cremoris*. This is a heterofermentative bacterium with an optimum growth temperature of 20–22°C (70–72°F) (Harris, 1997). Strains of this species metabolize the sodium citrate discussed previously to produce diacetyl and CO<sub>2</sub> (Harris, 1997).

Thus, with the two types of bacteria in the starter culture, it is imperative to select a temperature that would be compatible for both. If the incubation temperature is too high, the lactic acid producers are favored. As a result, an acid flavor predominates and a pleasing culture flavor is lacking. On the other hand, if the incubation temperature is too low, the growth of the leuconostocs are favored, but the acid production will take significantly longer, which can further interfere with processing schedules. Therefore, a common ground is needed and 22.2°C (72°F) to 23.3°C (74°F) appears to provide the opportunity to maximize both bacterial types.

The primary flavor problem seen in buttermilks in the United States is a “high acid” and “lacks cultured flavor.” Normally, this occurs due to incubation at too high a temperature and too short an incubation time. The temperature must be low enough to allow for the secondary growth (after pH drop) of the leuconostocs. Also, there needs to be sufficient sodium citrate as a source of diacetyl. Vedamuthu (1985) reported that the increase in diacetyl concentration slows down as the citric acid content decreases and the maximum level of diacetyl is attained in 14–18 hours of incubation. The exact time is determined by:

- The culture used
- The citric acid concentration of the raw milk
- The temperature of incubation

Vedamuthu (1985) listed five ways to prevent the loss of diacetyl in buttermilk:

1. Rapidly cool the vat once the desired acidity is reached. He indicated that when the buttermilk is cooled, the diacetyl destroying enzyme (diacetyl reductase) is retarded and the high level of flavor concentration is preserved. Diacetyl reductase acts rapidly at the incubation temperature of cultured buttermilk, but slows down considerably at lower temperature, e.g., 3.3°C (38°F) to 4.4°C (40°F).
2. Fortify the vat milk with sodium citrate. This helps due to the fact that fortification evens out any seasonal variations or deficiencies in citric acid content of raw milk.
3. Slow, gentle agitation during cooling. Oxygen or air that is worked into the buttermilk greatly inhibits diacetyl reductase.
4. Holding the buttermilk in a cooler for one or two days. This step will also enhance the diacetyl level. Due to the longer distribution system, this step may not be feasible.
5. Strict sanitation during the filling operation. Psychotrophic bacteria are known for having a high

diacetyl reductase activity even at low temperatures. Filling machines are probably the largest single source of contamination microorganisms.

Following addition of the starter, the mixture should be agitated at high speed for 15–30 minutes, depending upon the type of tank and agitation employed.

The buttermilk should be checked after 12–14 hours for acidity and flavor (taste plus aroma). Many processors have a rule on “breaking” the buttermilk at pH 4.50–4.60, plus desired aroma or flavor. All too often though, the only criterion is acidity without proper regard for flavor development. Many times incubation for an additional hour or two will result in the delicate aroma and flavor desired.

If “breaking” buttermilk on titratable acidity (TA) consider that this measurement is dependent on the solids content. Since a minimum total of solids of 10.0–10.5% is desired, a “breaking” TA of 0.90% should be the rule.

## **BREAKING, COOLING, BOTTLING, AND DISTRIBUTION**

Knowing when to “break” a tank of buttermilk is many times the difference between a good and poor product. As a rule, there will be several small pockets or bubbles of whey on top of the buttermilk when the tank is ready. When the decision is made (based on pH/acidity reading and aroma evaluation) that further incubation would be injurious to the quality of the product, the ice water is circulated through the jacket 10–15 minutes prior to turning on the agitator. With a two-speed agitator, the agitator should be turned on high speed until the product is moving easily in the vat and the body is smooth—this is “breaking” the buttermilk (White, 1976, Personal communication). The agitator should then be switched to low speed and cooled to 17°C (45°F) for bottling. Rapid cooling is essential to retard further bacterial action and stop excessive acid development. Agitation should be stopped when bottling to prevent any excessive air incorporation and adverse effects to the final viscosity. As indicated previously, air incorporation causes shrinkage during storage and contributes to syneresis.

The cooled buttermilk should be pumped to the filler with a positive pump. After packaging, the buttermilk should be held at a temperature of less than 4.4°C (40°F). This will retard the continued acid production and help keep the growth of microbial contaminants to a minimum. Temperature control



must be maintained throughout the storage and distribution system.

Finished product testing is needed to ensure that specifications are attained. The following test should provide the manufacturer adequate control (one should not feel limited to these and these alone):

1. Sensory evaluation—Taste samples at the following:
  - a. At “breaking”
  - b. When bottled—Packaging operator
  - c. Daily production samples—QA staff
2. Milk fat—Prior to inoculation and bottled product
3. Coliform—Goal should be <1 coliform/ml
4. pH/titratable acidity
5. Viscosity—Use of a Zahn cup or equivalent is recommended. A minimum of at least 25 seconds in a #2 Zahn cup at 10°C (50°F) yields desirable product viscosity
6. Temperature
7. Shelf life—Measured at 7°C (45°F)
8. Competitor product evaluation—Evaluate blind samples to ensure competitive properties of finished product

Custer (1982) reviewed the sensory evaluation defects of buttermilk. He mentioned the cause/prevention of each defect.

#### 1. Flavor defects

##### (a) Green (yogurt flavor)

*Cause.* Accumulation of acetaldehyde

*Prevention.* Avoid starters containing *Lactococcus lactis* subsp. *diacetylactis*

##### (b) Lacks flavor

*Cause.* High incubation temperature, insufficient citric acid in milk, low acid development

*Prevention.* Incubate at 22°C (72°F) to 23.3°C (74°F) to obtain a “balanced” growth of acid producers, as well as aroma bacteria. To insure sufficient citric acid in the milk for the starter bacteria add 227 g sodium citrate per 379 liters (100 gallons) of milk. To prevent low acid development increase the incubating time, increase the amount of starter, be certain the incubation temperature is not lower than 22°C (72°F) minimum.

##### (c) Bitter

*Cause.* Poor quality milk, temperature fluctuation during handling, psychrotrophic contamination

*Prevention.* Use only fresh-quality milk; eliminate excessive acid production, which

results in the starter bacteria breaking down the protein in the milk. Bitter flavor is usually more pronounced as the age of the product increases. Check for improperly cleaned equipment, especially from the buttermilk vat through the filler and eliminate psychrotrophic contamination.

##### (d) Acid

*Cause.* Over-ripening, inadequate, and/or slow cooling

*Prevention.* Determine the solids-not-fat content of the milk and break at the proper titratable acidity or pH (9.0% SNF → 0.85% TA; 10.0% SNF → 0.90% TA; 11.0% SNF → 0.95% TA)

##### (e) Stale

*Cause.* Use of old powdered milk. Use of whey powder along with nonfat dry milk.

*Prevention.* Check the quality of the fresh milk powder. Check the rotation of the inventory of powder especially if the defect occurs only occasionally. Never use whey solids.

##### (f) Cheesy

*Cause.* Due to psychrotrophic contamination.

*Prevention.* Never use returned dumped milk for making buttermilk.

##### (g) Unclean

*Cause.* Usually caused by bacterial contamination at some point such as poor quality starter milk, poor quality skim, and especially poor quality cream when used as a source of milk fat for buttermilk. Dirty equipment almost always results in bacterial contamination.

*Prevention.* Use only excellent quality, fresh dairy ingredients in the manufacture of buttermilk. Clean all equipment thoroughly.

##### (h) Cooked

*Cause.* Excessive heat treatment either in milk or more commonly in reconstituted milk powder.

*Prevention.* If NDM is used, ensure proper rotation. Avoid over heating of milk.

#### 2. Body and texture

##### (a) Weak

*Cause.* Low level of milk solids not fat in the milk. Low heat treatment. Low acid development.

*Prevention.* Use proper level of milk solids (at least 9.0%.) This provides sufficient casein, which is a natural stabilizer involved in coagulation as well as water retention. Use of sufficient high-heat treatment of milk

partially denatures the whey proteins. This contributes to the thickening of the buttermilk body.

(b) Slick

*Cause.* Excessive use of stabilizer. Bacterial contamination.

*Prevention.* Cut back on use of stabilizer or eliminate stabilizer completely. Check for psychrotrophic bacterial contamination.

(c) Grainy

*Causes.* Excessive acidity, undissolved salt, or milk powder, high incubation temperature, poor-quality milk.

*Prevention.* Check acidity or pH of buttermilk at both top of vat and outlet valve. Break buttermilk at correct acidity (9.0% SNF → .95% TA; 10.0% SNF → .90% TA etc.) and cool rapidly. Too high incubation temperature results primarily in fast acid development and the tendency of casein precipitation in a similar manner as in the manufacture of cottage cheese. Use of poor-quality milk, which causes physical casein precipitation during the heating process.

Although the procedures in the manufacture of buttermilk seem fairly straightforward and simple, still very poor-quality buttermilks are seen. Companies with multiple processing plants may have the same basic formula and very similar equipment. Thus, the only variable (other than the raw milk) remaining is the “people-factor.” No matter how basic the steps, to make good buttermilk, there must be that one person who “cares” enough to do the right thing at the right time. In this regard, it is very important to keep daily records to ensure that each “right thing” is in fact

done at the “right time.” When the correct manufacturing procedure coincides consistently with people who care about quality, the customer will recognize these attributes and the sales of this nutritious and delicately flavored product will likely increase.

## ACKNOWLEDGMENT

Approved for publication as Book Chapter No. BC-10613 of the Mississippi Agricultural and Forestry Experiment Station, Mississippi State University.

## REFERENCES

- Code of Federal Regulations. 2002. Part 131.112.
- Custer EW. 1982. Cultured dairy foods: Quality improvement manual. Am. Cult. Prod. Inst. Orlando, FL.
- Danisco. Fall. 2003. Dairy News. Cultured products. Cultured buttermilk. Danisco USA Inc., New Century, KS 66031.
- Harrits J. 1997. Culture nomenclature. In: Cultures for the Manufacture of Dairy Products, Chr. Hansen, Milwaukee, WI, pp. 18–26.
- Lundstedt E. 1975. All you wanted to know about buttermilk. Cult. Dairy Prod. J. 10:18–22.
- Petersen LW. 1997. Buttermilk, sour cream and related products. In: Cultures for the Manufacture of Dairy Products, Chr. Hansen, Milwaukee, WI, pp. 106–110.
- Vedamuthu ER. Better buttermilk. 1985. Microlife Technics, Sarasota, FL, 34230
- White CH. 1977. Manufacturing better buttermilk. Cult. Dairy Prod. J. (Feb.) 12:16–20.
- White CH. 1979. Buttermilk—Love it or leave it. Am. Dairy Review. (July) 41:34–38.
- White, HW. 1976. Personal Communication.

# 18

## Cultured/Sour Cream

*Bill Born*

Early History  
Present Standards  
    Summary of Procedures  
    Problems and Correction  
Sour Cream Products  
References

### EARLY HISTORY

Historians speculate that man began domestication of animals around 10,000 years ago. With the advent of herding and milking mammals, sour milk foods came about naturally (Pariser, 1975). Milking was by hand and there was no such thing as sanitation. Milk that was not consumed within a few hours turned sour. The type of fermentation that took place was determined by temperature and type of organisms in the milk. As mammals grazed through pastures, they picked up organisms from plants and soil on their udders. During hand milking, these organisms were imparted to the milk. Lactic bacteria are found on plant blossoms and are usually the predominant flora, although pathogens could be picked up from the mud of streambeds and manure. Rapid souring of milk by lactic organisms allowed them to dominate the fermentation (Clark and Goldblith, 1975). Prompted by hunger and guided by his nose, man began to consume sour milk products. Through ingenuity, trial, and error, samples of good sour milks were added to new milk to improve the chance of an eatable product on the next batch. Techniques and information were passed on and cultured dairy products evolved.

In the ancient city of Ur, archaeologists unearthed frieze dating 2900 BC. A part of the frieze depicts a man milking while other workers make sour milk products in pottery containers. The menu of a dinner

party held during this period in Ur consisted of an appetizer of garlic in sour cream, Tigris salmon, roast pig or lamb, unleavened bread, dates, goat cheese, and plenty of beer and wine (Editors of *Life*, 1961). By this time agriculture and dairy products had been well-established and somewhat refined. As the art of making sour milk foods was carried from tribe to tribe though Europe, each local artisan put an individual touch to his work and a variety of products evolved. Some of those products surviving today are “quark” of Germany, “crème fraîche” of France, “clotted cream” of England, and “yogurt” from the Mediterranean area (Food News Service, 2003).

While dairy cows arrived at the Jamestown Colony in 1611, sour cream, as we know it today, had not developed to its present form until 1890 to 1900 (FarMore, 2003). First sour cream products were either incubated in the package or in a ten-gallon can. Invention of homogenization in 1919 greatly helped give sour cream a more uniform body and texture (International Dairy Foods Association, 2003a). This was a time of entrepreneurs, and in 1919, Harry Bovarnick developed his secret process for making heavily bodied sour cream, and he would allow no one in the room when he prepared the mix. Harry’s secret was to add 0.5 ml of rennet per ten gallons of sour cream mix (Fig. 18.1). Breakstone Brothers in Walton, New York bought Harry’s process in 1923. Then Breakstone was bought by Kraft in 1928, and Breakstone/Kraft became one of the largest producers of sour cream and cream cheese in the world (Lundstedt, 1977). In the mid 1940s Martin Kloser of Bowman Dairies in Chicago eliminated ten-gallon cans for incubation and set sour cream in a large tank. When the product reached correct acidity, it was pushed out of the tank with 5 lb air pressure to



**Figure 18.1.** Sour cream production in the 1920s.

force the sour cream through a stainless steel screen to smooth the product as it was packaged. At that time consumer packages were glass jars that were returned, washed, and used again.

Some East Coast dairy manufacturers made both cream cheese and sour cream. It was a logical step for them to use the processing procedures from cream cheese to make a hot-pack, long shelf-life sour cream. After sour cream was fermented to pH 4.5, it was stirred and heated to kill all organisms, pumped through a homogenizer, and packaged hot into hermetically sealed glass containers. As the product cools, a vacuum forms producing a stable product that maintains its quality up to 12 months. When exposed to light, the glass-packed sour cream did develop an oxidized flavor. Hot-pack sour cream differed from cream cheese processing in that it was not drained and no salt was added. Hot-pack sour cream flavor differs from conventional sour cream in that it has no diacetyl or carbon dioxide (CO<sub>2</sub>) and has a cooked, lactic acid flavor (Kosikowski and Mistry, 1997).

The first sour cream stabilizer was gelatin and this did a reasonably good job. In the 1930s Arthur Ambrose of the Kraft-Phoenix Cheese Company, while working on ice cream stabilizers, tried some gum combinations in sour cream. He discovered that a mixture of 60% locust bean gum, 25% Irish

Moss, and 15% Karaya gum was a good substitute for gelatin, which was more expensive. Arthur Ambrose's pioneer work was followed by professional stabilizer manufacturers, which developed sour cream stabilizers that greatly improved body, texture, and palatability of sour cream (Lundstedt, 1977).

University researchers developed considerable knowledge of sour cream technology for the dairy industry to use. Some of the hallmark names that set the standards for our present sour cream processing and composition are: FJ Doan and CD Dahle, Pennsylvania Agricultural Station; LD Hilker, ES Guthrie, and FV Kosikowski, Cornell University; HE Calbert, University of Wisconsin; and S Tuckey, University of Illinois (Tuckey, 1963).

Guthrie (1952) developed a method to measure the body strength of sour cream using a plummet of given weight and dropped from a given height. The plummet was divided in ten equal segments and was used to measure body strength by depth of penetration into a sour cream sample. This was used to evaluate results from their experiments on factors effecting sour cream. Their experiments encompassed fat content, time and temperature of pasteurization, homogenization techniques, use of rennet, addition of milk solids not fat (MSNF), effect of stirring, and cooling

sour cream to 40°F after incubation. They found that sour cream could be made by either vat pasteurization or high temperature/short time (HTST). A composition of 18% fat, 9.5% MSNF, and addition of rennet gave the most desirable consistency. It was also found that cooling the incubated product to 40°F before packaging weakened the body (Gutherie, 1963). The work of these early researchers set the standards for our present sour cream.

## PRESENT STANDARDS

Federal standards require that sour cream be 18% butterfat (International Dairy Foods Association, 2003b). Acidification may be by a lactic culture or by direct acid addition using an approved blend of acids. The acid blend most often used is a combination of lactic and citric acid. Other food grade acids, such as acetic, propionic, or phosphoric are commonly used to achieve a particular flavor or improve keeping quality. Lactic, acetic, and propionic have bacterial static effects, while citric can be fermented by many organisms, and if used in high levels or out of proportion with other acids can cause excessive gas production which will result in bloated cartons. One advantage of direct acidification is extended shelf life. Direct acidified sour cream and dips do not have the fine flavor of cultured sour cream for the first 2 weeks of shelf life. Starting on about the 15th day, depending on storage temperature, enzymes from the culture will start producing a noticeable “aged” flavor similar to aging Cheddar or other cured cheeses. Proteolysis becomes apparent as bitter, cheesy, and stale flavors. The action of culture enzymes on dip spices becomes particularly unpleasant. If sour cream is made by direct acidification, it must be so labeled.

Body and texture of sour cream, which does not contain stabilizer, is determined by composition and processing. Mix should contain high-quality cream and high-protein MSNF. Natural solids-not-fat content of an 18% cream will be between 7.1% and 7.5%. To produce an optimum quality sour cream, solids-not-fat should be increased to 9.0–9.5%, using high protein condensed skim milk or non-fat dry milk (NFDM). Standardized mix, ready for processing, should test 18.5% fat and 27.5–28.5% total solids (Calbert, 1961).

Processing can be accomplished by different methods. Mix is heat treated by vat or HTST pasteurization. In both cases, time and temperature of heating should denature a consistent amount of whey proteins, which then coprecipitates with casein during

fermentation to produce a smooth body with improved moisture binding properties. Vat pasteurization at 73.9–79.4°C (165–175°F) for 30 minutes or HTST at 82.2–85°C (180–185°F) for 3–4 minutes hold will denature sufficient whey proteins. Vat pasteurization lower than 65.6°C (150°F) or more than 85°C (185°F) for 30 minutes will produce a weaker body that is more susceptible to syneresis when product is stressed. Firmness of body is also determined by methods of homogenization. Temperature and pressures of homogenization are key factors in the body of sour cream. A long used method, giving an excellent body and texture, is two single-stage 2500 psi passes using a Manton–Gaulin homogenizer. This requires two available tanks and much processing time. The same effect can be accomplished by HTST with a long hold tube and two homogenizers positioned in line after the holding tube. This system requires one pass and saves much processing time and tank space (Gutherie, 1963). Mix goes back through the regeneration and cooling section where it is cooled to 21.1–23.9°C (70–75°F) and on to the fermentation tank for setting. The high heat treatment and homogenization technique produces enough free fat crystallization and fat clumping to form a firm-bodied sour cream without the use of stabilizers.

As the popularity and sales of sour cream increased, the use of stabilizers allowed the producers to simplify processing and install larger, higher speed operations. Stabilizer companies have met the demands of cultured product manufacturers for stabilizers to produce sour cream with excellent body and texture. Stabilizers may be composed of gums, gelatin, modified food starch, whey proteins, and protein conditioners such as phosphates. A stabilizer specialist can furnish stabilizers to give the body and texture of sour cream for a particular market.

The majority of sour cream is incubated in large tanks rather than 10-gallon cans, as was done in the early history of cultured products. Usual incubation temperature is between 22.2°C (72°F) and 23.9°C (75°F). This temperature range produces a good balance between organic acids and aromatic flavor compounds. Higher temperatures produce more acid flavor and less aromatic flavor. In sour creams for industrial applications that do not require a fine flavor such as in baking and dips, incubation temperatures of 26.7–31.1°C (80–88°F) are often used to reduce set times of 14–18 hours to 6–8 hours. A good sour cream culture is a blend of *Lactococcus lactis* and *cremoris* plus *leuconostoc* or *Lc. lactis* sp *diacetylactis*. For fast-set industrial sour cream,

cottage cheese cultures containing no flavor organisms are often used at 31.1°C (88°F) to give sets as fast as 4–5 hours. Citric acid or sodium citrate is often added to consumer sour cream to enhance flavor and produce a small amount of CO<sub>2</sub>. Excessive CO<sub>2</sub> can cause problems. Since sour cream is usually packaged at incubation temperatures, culture continues to ferment citrate until the product cools. If cooling is slow, which often happens when the case is corrugated and palletized, excess carbon dioxide will swell carton and pop lids. This is particularly severe when cartons have a gas tight seal and CO<sub>2</sub> cannot escape. Customers think that swelled cartons indicate spoilage. Culture should produce enough diacetyl for a balanced flavor without overcarbonization. The high fat content of sour cream smooths out the sharp acid flavors that would be noticeable in buttermilk. Some manufacturers take advantage of this trait to shorten incubation time by increasing set temperature to 29.4–31.1°C (85–88°F). Product will have a clean acid flavor, but will lack the pleasant lingering aroma produced at lower incubation temperature. Direct set cultures work very well to inoculate sour cream. These are the most reliable methods and are consistently balanced between acid and flavor-producing organisms.

Rennet may be added at set time to produce a firmer body. If sour cream is to be used for dips, salt content of dip seasonings will cause product to thin if stabilizers or rennet are not used. Usage level of single-strength rennet varies between 0.5 and 50 ml per 100-gallon mix. The upper level is close to that used for Cheddar cheese and is not recommended. The usual level is 5 ml per 100 gallon. Even at this level caution must be taken to have rennet well diluted with cold, pure water and limit agitation after addition so that product is quiescent before rennet coagulates casein. If rennet reacts with casein, while mix is still in motion, a grainy texture will develop and whey-off may occur. Rennet should be added after culture is added. At 22.2–23.9°C (72–75°F), usual incubation time is 14–18 hours.

The automated mix blending operation shown in Figure 18.2 is for a sour cream and dip base. Tanks are on load cells, liquid ingredients are metered into tanks, and dry ingredients are added through a liquefier. Mix is circulated through a shear pump until uniform. It is analyzed for fat and solids before processing through HTST and homogenization. Mix goes to a fermentation tank at 22.2°C (72°F) for fermentation to pH 4.5.

Sour cream may be incubated in the cup, 10-gallon can, or tank. Most large volume operations incubate

in the tank. End point of fermentation is determined by titratable acidity or pH (pH is preferred). The titratable acidity will range from 0.70 to 0.90% depending on the amount of MSNF used in mix. The pH should be 4.45–4.5. Proper level of MSNF added to mix buffers acid development so that it is rare for sour cream to develop a harsh acid flavor. When correct acid is developed, cup sets are placed in a cooler and tank incubated product is broken with a slow-sweep agitator. Agitation should be used only intermittently during packaging. Tank sets are not usually cooled below 18.3°C (65°F) before packaging because body will be thin. Cups are filled at 22.2–23.9°C (72–75°F) and product is cooled while quiescent in package. With tank-set sour cream, a positive pump is used to pump the product through a screen, backpressure valve, or similar device to smooth out the texture. When pumping at 18.3°C (65°F) or above, body will resist thinning by shear. As temperature is reduced below 18.3°C (65°F), viscosity is reduced and body does not reset firmly in the cup. Warming cups to 21.1°C (70°F) and cooling again will restore some body. This procedure would only be used to correct a mistake.

### SUMMARY OF PROCEDURES

A summary of sour cream processing is available in *Gourmetsleuth* (2001). Use only those ingredients that are free of defects. Do not try to salvage old and off-flavored ingredients by using them in cultured products. Best advertising dollars are spent on quality products.

1. Standardize mix to 18.5% fat and 27.5% total solids. Avoid incorporation of air while blending mix.
2. Vat pasteurize at 73.9–79.4°C (165–175°F) for 30 minutes or HTST 82.2–85°C (180–185°F) for 3 to 4 minute hold.
3. To produce a firm-bodied sour cream, homogenize two single-stage 2500 psi passes. High-speed operations that use the same homogenizer for milk and sour cream processing and two-pass system cannot be used. A stabilizer will be required to give a proper viscosity to the sour cream.
4. Cool to 21.1–23.9°C (70–75°F) and set with direct set or bulk sour cream culture. Use 5 ml rennet per 100-gallon mix.
5. Break at pH 4.5 with slow-sweep agitation, then turn off agitator and start packaging. Turn agitator on periodically during packaging to blend in any pockets of whey. Agitation should be automated so each batch is consistent.



**Figure 18.2.** Automated mix blending in modern sour cream plant.

6. Pump sour cream with positive pump through a screen, backpressure valve, or similar smoothing device to packaging machine.
7. Package at incubation temperature and cool in package for maximum body firmness.

### PROBLEMS AND CORRECTION

Simple mistakes account for many problems but are often the most difficult to find. People do not like to admit a mistake especially if they think their job is in jeopardy. Because of incubation time, cultured products are usually made at the end of the day or at night when supervision is minimal and low seniority personnel are working; therefore, good methods of communication are essential in determining and preventing problems. Working atmosphere should encourage workers to tell a supervisor immediately if a problem is suspected. Problems can often be corrected if found early.

### Body and Texture

1. Weak body
  - a. Stabilizer or milk solids left out of mix: (have a check list for mix personnel)
  - b. Agitator left on through part or all of incubation: (tank set)
  - c. Low casein milk: (spring and summer milk)
  - d. Homogenizer difficulty: (bad valves, type of valve, pressure not correct)
  - e. Excessive agitation before packaging and packaging sour cream too cold
  - f. Excessive heat treatment
  - g. Consistently weak-bodied: (basic mix formula should be changed and processing methods evaluated)
2. Weak body at beginning of packaging and heavily-bodied at end: (often fat test is low on first product and high at end of packaging)
  - a. Steam valve leaked on tank during incubation causing bottom of tank to be warm. Whey forms in bottom and fat rises to top. Often pH is different in top and bottom of the tank because of temperature difference. Sweep agitation will not completely blend viscous mass. Double valves should be used on steam and refrigerated lines to insure no leakage
  - b. Some homogenizer systems will promote fat clumping severe enough that fat will rise before acid is sufficient for coagulation
  - c. Excessive agitation at set can cause fat to churn and rise to top of tank

3. Different pH on top and bottom of tank
  - a. Temperature is different at top and bottom of tank. Steam valve or refrigerated water valves leak
  - b. Excessive air incorporation in mix. Air rises to top of tank. Cultures are microaerophilic and will work faster at bottom of tank than top
4. Grainy texture
  - a. Excessive rennet, which was insufficiently diluted with water when added to mix, will coagulate casein before mix is quiescent
  - b. Excessive heat treatment of mix
  - c. Culture agglutination: (should not occur if heat treatment is sufficient)
  - d. Stabilizer reaction with milk protein: (certain pectin, algin, and carrageenan will react with milk protein unfavorably)
  - e. Screen or backpressure device left out of line between tank and filler
  - f. Fat churning due to excessive agitation at set
5. Free whey on packaged product
  - a. Packaged sour cream has suffered physical and/or temperature shock
  - b. Improper heat treatment of mix
  - c. Insufficient acid development: (above pH 4.6 at packaging)
  - d. Wrong stabilizer
  - e. Low solids mix: (low casein resulting in weak, fragile body)
6. Slick texture or gummy body
  - a. Wrong or too much stabilizer
  - b. Using a culture that produces high levels of polysaccharides
4. Bitter
  - a. Lactic culture that produces high levels of proteolytic enzymes
  - b. High psychrotrophic bacteria counts in raw milk supply
5. Rancid
  - a. Raw milk contains heat-stable lipolytic enzymes
  - b. Old and poorly handled cream
6. Absorbed and unnatural flavors
  - a. Sour cream stored next to fruits, vegetables, solvents, cleaning supplies, etc.
  - b. Mix contaminated with sanitizers or other agents used in plant

## SOUR CREAM PRODUCTS

In the beginning it was determined that 18% fat made the optimum sour cream and the Food and Drug Administration (FDA) set this as the standard. Those were the days when butter was the king and skim milk was a by-product. Later came heart disease research that indicated butterfat was a potential villain. Media-hyped various nutritional papers denouncing any food containing high fat and high cholesterol and this redirected the diet of the general populous. Dairy marketing people requested products to satisfy public demand for low fat and low cholesterol products. This led the way to development of lower fat sour cream products. In November 1996 the FDA changed the standard of identity for sour cream to cover products lower than 18% fat. To give the consumer a wide selection, sour cream was divided into lower fat categories. Sour half and half, reduced fat, light sour cream, and nonfat or fat free are some names now in use (refer to FDA standards for labeling). Sour skim milk is identified as fat-free sour cream, and it must be stabilized heavily enough to have a sour cream-type body otherwise it is buttermilk. Replacing butterfat with vegetable fat is called a filled sour cream. Taking it a step further, replacing butterfat with vegetable fat and skim milk solid with sodium caseinate produces an imitation sour cream. It must be noted that some vegetable fats do more damage to the human circulatory system than butterfat.

Producing a firm-bodied *reduced fat sour cream* is not a difficult project. By increasing NFDM and selection of the correct stabilizer blend, reduced fat sour cream can be made that is about comparable to 18% sour cream. Making a good *fat-free sour cream* is difficult. Skim milk solids must be increased with NFDM, whey solids or whey protein, and a

### Flavor Defects

1. Lacks flavor
  - a. Incorrect incubation temperature
  - b. Not enough acid development
  - c. Culture does not contain flavor-producing organisms
  - d. Low citrate level
  - e. Flavor mask by high level or wrong stabilizer
2. Green flavor (like a green apple flavor, occurs when diacetyl is reduced to acetaldehyde)
  - a. Wrong culture selection
  - b. High temperature and over incubation
3. Oxidized
  - a. Mix exposed to copper in processing system
  - b. Product exposed to sunlight or fluorescent light





**Figure 18.3.** Production of sour cream dips.

compatible stabilizer blend is essential to give a body close to sour cream. Correct selection of emulsifiers can produce a texture similar to milk fat, but the final product still falls short of 18% fat sour cream. Culture selection is also more critical for no fat sour cream. Because of high levels of MSNF, cultures produce excessive amounts of  $\text{CO}_2$  giving a sharp bite to the product. If the product is packaged with a gas-tight seal, the carton puffs up and alarms consumers that something may be wrong with it. Making an acceptable no fat sour cream requires close attention to every detail, but there are acceptable products in the market.

*Filled sour creams* have found a niche in the system. By selecting the correct vegetable oil and compatible emulsifier system, a heart-healthy sour cream product can be produced that is pleasing to eat. Another large volume use for filled sour cream is in the manufacturing of chip dips (Fig. 18.4). For the first 2 weeks of shelf life, there is nothing better than a dip made with butterfat. Then bacteria and enzymes from dip seasonings start to decompose butterfat and unpleasant flavors develop. Chip dips often have a shelf life of over 90 days. Using direct acid in place of cultures and vegetable fat in place of butterfat, dip

bases can be formulated to keep a fresh flavor for long periods of time and stand up to abuses received in the distribution chain. Three flavor blending tanks are shown at center left in Figure 18.3. Dry dip spices are palletized on deck to be added to each tank.

To make an acceptable *imitation sour cream* requires skilled research. Correct vegetable fats, emulsifiers, sodium casein, whey powder, whey proteins, and some times corn syrup solids and other body builders are used to develop a usable formula. The vegetable fat and emulsifier must produce a creamy consistency, which resist crystallization when heat shocked. Some imitation sour creams on the market have a body more like lard than sour cream due to excessive fat crystallization. Body building solids should work together to give coagulation similar to MSNF and without off-flavors. Caseins in particular can produce off-flavors tasting like glue. When all elements are compatibly put together, a reasonably eatable product can be made. But why make an imitation sour cream when the others will usually make a better product? There is a small market for people with specific health problems, and people who will not eat animal products of any kind. Also an imitation sour cream can be made to meet Orthodox



**Figure 18.4.** Production of filled sour cream dips.

Jewish laws. (Note that kosher gelatin is available, but mixing any animal gelatin with milk is not kosher). Imitation sour cream has found favor with some industrial bakers, dessert, and salad makers because it is cheap and fat crystallization produces a firm body when mixed with other ingredients.

Sour cream's popularity has grown logarithmically since its development on the East Coast in early 1900. Homemakers and professional chefs have developed thousands of recipes using sour cream. Many of the products that were developed became very popular and are now manufactured by large food companies (i.e., sour cream for cheesecake toppings, sour cream for herring, sour cream in salad dressings, freeze/thaw-stable sour cream, and sour cream that can stand temperature and agitation of ultra-high temperature [UHT] sterilization). Each of these applications requires the research person to find the correct combinations of stabilizer, starch, and emulsifier for the specific conditions. If sour cream is to be combined with other ingredients containing amylase, starch cannot be used because it will be degraded and the product becomes thin with free whey present. UHT destroys the protein structure of sour cream; therefore, body must be achieved with a combination of gums and special modified starches. To get sour

cream to adhere to an oily piece of fish requires a combination of emulsifiers and starch. Each application of sour cream is an individual challenge, which when met with expertise, will increase sales. The future sour cream, in many forms, will continue to grow as these challenges are met.

## REFERENCES

- Calbert H. 1961. Cultured sour cream. Manufacturers' Conference, University of Wisconsin, Madison. January.
- Clark J, Goldblith S. 1975. Processing foods in ancient Rome. *Food Technol.* 29(1):30–32.
- Editors of *Life*. 1961. The epic of man. Time, Inc. p. 76.
- FarMore F. 2003. Milk history: Milestones of milk history in the United States. Retrieved February 2004 from [http://www.wegotmilk.com/milk\\_history.html](http://www.wegotmilk.com/milk_history.html)
- Food News Service. 2003. Ochef—Questions: What are all the dairy products under the sun? Retrieved February 2004 from <http://www.ochef.com/100.htm>
- GourmetSleuth. 2001. How to make sour cream. Retrieved February 2004. Available at [http://www.gourmetsleuth.com/recipe\\_sourcream.htm](http://www.gourmetsleuth.com/recipe_sourcream.htm).

- Gutherie E. 1952. Study of the body of cultured cream. Bull. 880, Cornell University, Ithaca, NY.
- Gutherie E. 1963. Further studies of the body of cultured cream. Bull. 986, Cornell University, Ithaca, NY.
- International Dairy Foods Association. 2003a. Industry facts-milk: Milestones of milk history in the U.S. Washington, DC: Milk Facts, 2002 ed. Retrieved February 2004. Available at <http://www.idfa.org/facts/milk.cfm>
- International Dairy Foods Association. 2003b. Industry facts-milk: Definitions of fluid milk and milk products. Washington, DC: Milk Facts, 2002 ed. Retrieved February 2004 from. Available at <http://www.idfa.org/facts/milk.cfm>
- Kosikowski FV, Mistry VV. 1997. Cheese and fermented milk foods: Origins and principles. Vol. 1, 3rd ed. Westport, CT. p. 82.
- Lundstedt E. 1977. Manufacture of superior sour cream. *Cult. Dairy Prod. J.*, 10(1):20–22.
- Pariser E. 1975. Food in ancient Egypt and classical Greece. *Food Technol.* 29(1):23–27.
- Tuckey S. October, 1963. Sour cream processing. Dairy Conference, University of Illinois, Urbana. Available at <http://em.wilipedia.org/wikicream>.

# 19

## Other Fermented and Culture-Containing Milks

*Ebenezer R. Vedamuthu*

- Introduction
- Dahi
  - History
  - Production and Packaging
  - Product Description and Keeping Quality
  - Microbiology
- Kefir
  - History
  - Production, and Packaging
  - Product Description and Quality
  - Microbiology
- Koumiss
  - History
  - Production
  - Product Description
  - Microbiology
- Acidophilus Milk and Sweet Acidophilus Milk
  - History
  - Production of Acidophilus Milk
  - Production of Sweet Acidophilus Milk
  - Quality Standards
  - Microbiology
- Probiotic Milks
  - History
  - Production of Probiotic Milks
  - Quality Standards
- Bulgarian Milk
- Skyr
- Vilii
  - Microbiology
- References

geographical region of their origin but also the types of milk used in their production, the gradation in the technology employed, the cultural conditions, and the types and species of microflora involved in those fermentations. Short descriptions of the various cultured milks in the following paragraphs illustrate that diversity:

*Dahi* is a semisolid cultured product popular throughout South Asia, but there are subtle variations in the body and flavor of *Dahi* made in different parts of the subcontinent. In a large portion of the country, *Dahi* is made from cow milk. There are pockets where a mixture of cow milk and buffalo milk is used, and in certain areas buffalo milk is almost exclusively used. Buffalo milk being high in solids content, yields a very firm product, while cow milk *Dahi* is a relatively softer product. In terms of flavor, in certain regions a mildly acidic, yeasty-sweet product is desired, whereas in other regions a more acidic *Dahi* is preferred. Because of the higher solids content of buffalo milk, the acidity of buffalo milk *Dahi* is higher. There is general agreement among the scientific community that the microorganisms involved in *Dahi* fermentation consist of dairy lactococci, leuconostocs, and certain yeasts (Rangappa and Achaya, 1975) although the yeasts may be considered as secondary contaminants that are carried over by the extensive “back-slopping” that is practiced in households and cottage industry involved in *Dahi* production. Back-slopping is the practice of using a small remnant of the previous day’s product to inoculate a fresh batch. The Bureau of Indian Standards recognizes a category called “Sour *Dahi*” for which additional secondary flora consisting of the thermotolerant “coccus-rod” mixtures used in *Yogurt* may be included (Aneja et al., 2002).

### INTRODUCTION

*Dahi*, *Kefir*, *Koumiss*, *Acidophilus Milk*, *Probiotic Milk*, and other cultured milks represent the great diversity of cultured dairy products produced around the world. The diversity not only reflects the

*Kefir* is popular in Russia, and originated in the area abutting the Caucasus mountain range. Traditional *Kefir* is produced using *Kefir* grains as inoculum. The incubation is at room temperature. *Kefir* is an acidic–alcoholic product as both lactic acid bacteria and yeasts are involved in the fermentation. According to Kosikowski and Mistry (1997), in Russia, *Kefir* may be made from goat, sheep, or cow milk. The lactic acid content is usually around 0.8% and alcoholic level about 1.0%. Carbon dioxide is the other major fermentation byproduct in *Kefir*. Modern production of *Kefir* in Russia and other European countries where it is popular varies from the traditional process. The microflora involved in *Kefir* fermentation is complex.

*Koumiss* is acidic–alcoholic cultured milk that has considerable commercial and public health significance in Russia (Kosikowski and Mistry, 1997). *Koumiss* is made from mare's milk. *Koumiss* has a milky white appearance with a grayish tint. Unlike most other cultured milk products, which form coagula of different consistencies, *Koumiss* remains a fluid even after the fermentation is complete. The protein in mare's milk is different from the protein in milk from other species, and does not coagulate even with increase in acidity or when rennet is added (Kosikowski and Mistry, 1997). According to Vedamuthu (1982), mare's milk does not coagulate at the isoelectric point of casein and hence, *Koumiss*, which may contain about 0.7–1.8% lactic acid and 1.0–2.5% ethanol, is not a curdled product. Robinson et al. (2002) report that *Koumiss* or *Koumiss*-like products carrying names such as *Airag*, *Arrag*, *Chige* or *Chigo* are produced in Mongolia and Western Chinese provinces.

Vedamuthu (1982) defines *Acidophilus* milk thus, “*Acidophilus* milk or *reform yogurt* is the product obtained by fermenting milk with an authentic culture of *Lactobacillus acidophilus*.” *Acidophilus* milk may be considered the prototype of all the present day *probiotic* milks. One of the unique features of *Lactobacillus acidophilus* is its ability to survive the severe environmental conditions found in the intestinal tract of man, animals, and birds. This bacterium is commonly a part of the total microbial flora of healthy humans. Scientific evidence has been steadily accumulating to establish that the normal intestinal flora contributes in no small measure to gut health. Traditional *Acidophilus* milk is an extremely sour product and does not contain other balancing flavors. Hence, it has not been a popular product. Accordingly, alternative means to deliver gut health promoting

*Lactobacillus acidophilus* bacteria have been designed. These products are generally called “Sweet *acidophilus* milks” (Foster et al., 1957).

The definition for the term “*probiotics*” varies from a general description such as, “live microorganisms administered in adequate amounts that confer a health effect on the host” (Skovsende, 2003) to a more narrow specification, which states, “*probiotics* are live microbial food supplements, which benefit the health of consumers by maintaining, or improving their intestinal balance” (Mattila-Sandholm et al., 2002). Several species comprising the genera *Lactobacillus* and *Bifidobacterium* are normal inhabitants of healthy human gut, and have been shown to play a regulatory role in the ecology and the microbial flora of the gut (Sanders and Huis in't Veld, 1999). Regular intake of probiotic-rich foods may contribute to maintaining intestinal health and general well-being. Various other health benefits, such as improvement of lactose metabolism, reduction in serum cholesterol, antimicrobial, anticarcinogenic, antimutagenic effects, and immune stimulation have been ascribed to the regular intake of probiotics (Shah, 2001). Skovsende (2003) has cited other reported benefits. The scientific evidence, however, is stronger and more equivocal with respect to the maintenance of intestinal health. Although several food products other than dairy foods like sausages, breakfast cereals, health food bars have been explored as vehicles for the delivery of probiotics, by far the greatest success has been with dairy products, especially fluid milk (Skovsende, 2003). A more comprehensive discussion of the benefits of adding probiotics to milk is found in Chandan's review (1999).

Besides the products discussed in the foregoing paragraphs, there are few other cultured dairy products that are either confined to limited geographical areas or little known beyond the areas where they are produced and consumed.

*Bulgarian milk* is cultured milk that is popular in the Eastern European countries. This product may be considered to be the forerunner of the present day traditional *Yogurt*. The appellation “*Bulgarian*” came about because the product originated in Bulgaria. For the product produced in Bulgaria, only *Lactobacillus delbrueckii* ssp. *bulgaricus* (rod) is used as starter. In other places, the “*coccus*” (*Streptococcus thermophilus*) may be included along with the “*rod*.” It is believed that the species name “*bulgaricus*” was derived from *Bulgarian milk* from which the *Lactobacillus* species was first isolated. It is a highly acidic

product with a green acetaldehyde flavor reminiscent of traditional *Yogurt*.

In Scandinavian countries unique cultured milk is consumed. The well known among those products is *Viili*, also known as *Pitkapiima*, or just *Piima* and *Fili*. This product is popular in Finland. In other Scandinavian countries, similar products carry names such as *Langfil*, *Taetemelk*, and *Keldermilk*. The unique feature about those milks is their ropy, stringy, and viscous texture. When a spoon is inserted into one of those products and lifted out, the coagulum clings to the spoon and forms long stringy threads as the spoon is drawn away from the surface of the curdled mass. Special capsular slime-forming dairy lactococci are included along with noncapsular lactococci in starters for those products. The Finnish *Viili* also has a thin layer of mold on the surface. The mold, *Geotrichum candidum* is considered to impart a unique flavor to the product. The immediate layer below the surface of the mold, is less acidic, because *Geotrichum candidum* metabolizes lactic acid formed by the lactococci.

*Skyr* is Icelandic cultured milk. It has been introduced in Denmark. The product is a variation of *Yogurt*. It may be considered as a concentrated *Yogurt*. The starter flora for *Skyr* is similar to *Yogurt*, and consists of a symbiotic combination of “rod” (*Lactobacillus delbrueckii* ssp. *bulgaricus*) and “coccus” (*Streptococcus thermophilus*). Skim milk is used in its production and the concentration of the coagulum is achieved by removing sufficient whey to increase the solids level in the product from 18% to 20%, which increases the initial acidity range from 1.4–1.6% to 2.5–3.0% (Foster et al., 1957).

There are other concentrated variations of *Yogurt*, and other cultured milks made with mesophilic dairy lactococci known by different local nomenclatures, and are listed in Chapter 1.

## DAHI

### HISTORY

The origin of *Dahi* is shrouded in antiquity. According to Aneja et al. (2002), numerous references to *Dahi* are found in Vedic literature, which comprise the sacred books of Hinduism. In the major sacred book, the Rig Veda, various means of curdling milk (for *Dahi*) with a starter consisting of a small portion of an earlier stock, or by introducing greens from the *putika* creeper, the bark from *palasha* plant or the fruit of the *kuvala* (*Ziziphus* spp.) are mentioned. People

of those times presumably were aware that green plants are the natural habitat for lactic acid bacteria. In many of the art forms of India depicting the mythological legends of the exploits of Lord Krishna (incarnate of Lord Vishnu), show young Krishna stealing *Dahi* curd from earthen pots in the larder, or frolicking with milkmaids carrying earthenware, containing *Dahi*.

In Vedic times as well as at present, *Dahi* is made for consumption as such or as a starting material for secondary products. In Southern India, *Dahi* may be eaten as curds or mixed with rice. Sometimes, a variety of spices and condiments cooked in hot edible oil are added to *Dahi*, and the mixture is used to flavor the rice staple. Plain *Dahi* or the product embellished with hot spice-oil mixture may be used as salad dressing (*raitha*, the modern equivalent of *rayata*—royal food item of Vedic times). A doughnut shaped, deep fat-fried product made from a batter consisting of cereal-legume mixture called “*vada*” soaked in plain *Dahi* or *Dahi* containing hot spice-oil mixture, is served in Indian homes as “*Dahi vada*.”

In Northern India, where wheat is the staple, *Dahi* is eaten with flat wheat breads of different kinds. Another favorite in Northern India is salty or sweet *lassi*, which is *Dahi* mixed and whipped with cold water, spices and salt (for salty *lassi*) or sugar (for sweet *lassi*). This drink is popular to quench the thirst during hot summer months. The South Indian equivalent is “buttermilk” (or *moar*). *Dahi* is also the intermediate in the production of *desi* butter or *makhan*. For conversion into *makhan*, the *dahi* curd with or without the addition of cold water is churned with a manual wooden paddle until the butter granules separate from the serum. The granules are collected and consolidated to form a lump or a pat. The serum portion and the residual solid is consumed as a refreshing drink, or mixed with rice and consumed. *Desi* butter is largely used for making *ghee*, the preferred shortening in Indian cooking. In some homes, the upper cream layer on the surface of *Dahi* made from whole milk is removed and stored until enough material is gathered, for churning into *makhan*. Another important product made from *dahi* is *Shrikhand*, popular in the Western States of India. *Shrikhand* is a concentrated curd of *dahi* by draining off the whey, and fortifying the concentrated curd with sugar and flavorings like nutmeg and cardamom.

Besides the foregoing, there are various other *dahi* derivatives. Those products are discussed by Aneja et al. (2002), Rangappa and Achaya (1975), and Prajapati (2003).

## PRODUCTION AND PACKAGING

*Dahi* is largely made in individual households for the immediate needs of the family. In villages and towns, the product is often made on a cottage industry scale for sale, as such or for converting it to *makhan*, and ultimately to *ghee*. *Ghee* is essentially clarified butter oil, which is made by evaporating the moisture off the *desi* butter by heating on an open fire. The heat treatment and the drastic reduction in moisture content render the shortening a relatively stable product under ambient conditions, which could be easily transported to urban markets. Greater care is exercised in making *dahi* for direct consumption than for conversion into butter or *ghee* (Rangappa and Achaya, 1975).

In preparing *dahi* in households and in cottage scale production centers, milk is boiled to destroy contaminants, and after cooling to body or ambient temperature in a covered vessel, is inoculated with a portion of the previous day's product. The vessel may be left undisturbed in a warm place (next to a warm oven) or wrapped with a cloth or straw and placed in a straw box to prevent loss of warmth by radiation for anywhere from 6 to 24 hours depending upon the ambient temperature. Rangappa and Achaya (1975) state that the amount of inoculum would vary depending upon the ambient temperature. In very cold weather, 5–10% by volume may be used, and during summer about 1–2% may be used. During very hot summer months, the vessel containing the inoculated milk may be wrapped in a moist cloth to keep the content insulated from getting too warm. The authors further opine that the seed used is never a pure culture but mixed with the predominance of lactic acid bacteria. The final acidity after incubation may range from 0.7% to 1.0%. And, for good *dahi*, Rangappa and Achaya (1975) suggest a final pH range of 4.6 to 5.2. After incubation and attaining the desired curd formation and acidity, the product is kept in a cold spot or held in clean, covered earthenware to achieve evaporative cooling, or immersed in a shallow pan containing cold water. A similar process is mentioned by Aneja et al. (2002). In village markets and bazaars in towns, *dahi* portioned out in small pottery is offered for sale. The product may also be ladled out of a large earthen vessel into receptacles brought to the market or bazaar by the customers.

To cater to the urban populace of India with greater purchasing power, *dahi* is also made on an industrial scale. The volume is, however, relatively

small. The manufacturing process and the equipment used are similar to other cultured dairy products in the West. Double-jacketed stainless steel vats equipped with suitable agitators and in-place heating and cooling design, and incorporating cleaning-in-place (CIP) piping and equipment are used. Milk may be vat pasteurized or run through a high-temperature-short-time (HTST) or an ultra high temperature (UHT) equipment and piped into stainless steel vats equipped with thermostatic temperature controls (for incubation and cooling). To monitor the course of fermentation, the vats may have sanitary ports for pH probes coupled with a recording chart, or sample ports. After incubation is completed, the curd is gently broken by turning on the agitators and concomitantly cooling the curd mass by circulating chill water (sweet water) in the vat jacket. After sufficient cooling, the curd is gently conveyed to a filling machine. To preserve the desired body and texture, gravity flow is desirable. If pumping is necessary, a positive displacement pump with a back-pressure device is recommended. Plastic cups with lids and displaying attractive graphic designs are used for packaging industrially manufactured *dahi*. For a more detailed description of the equipment and processes used in industrial production of *dahi*, the reader is referred to Aneja et al. (2002).

There are definite differences in process parameters between the small-scale and industrial-scale production of *dahi*. These differences relate to the heat treatment of milk, the incubation temperature and the starter flora. Another variation is the homogenization of the milk or the sweetener containing mix. Homogenization ensures uniformity in body and texture, and prevents the formation of the "cream line." In small-scale production, the milk is brought to a complete boil before it is slowly cooled down without any external coolant to body or ambient temperature. On an industrial scale, by low temperature—long hold (LTLH) procedure, milk is heated to 63°C and held at that temperature for 30 minutes; and, when sweeteners are added to milk, the mixture heated to, and held at 66°C for 30 minutes. This is usually vat pasteurization. For HTST treatment, milk is heated to 73°C and held for 15 seconds, and milk with sweetener is heated to 75°C and held for 15 seconds. The temperature-time parameters for UHT treatment may range from >90°C to 148°C for 2 seconds. When direct culinary steam injection heating is practiced, the temperature attained is 94°C with suitable adjustments made for dilution of the mix by condensation of steam (Aneja et al., 2002). On an

industrial scale, after heating, the milk/mix is cooled rapidly to the desired temperature by external cooling devices.

The incubation for cottage industry preparation of *dahi* is at ambient temperatures, which may range from 28°C to 30°C during summer, and in winter months, the temperatures may vary from 20°C to 24°C. Aneja et al. (2002) report that in industrial production of *dahi*, the incubation temperature is 37°C, and is thermostatically controlled. Because of the accelerated growth at higher temperatures, the incubation period is shorter for industrial production. Shorter incubation probably fits with rapid turn over of equipment and work schedules needed for industrial operations. At the end of fermentation, in industrial operations, the *dahi* is rapidly cooled to <5°C to arrest excessive acid development and “whey-off.”

### PRODUCT DESCRIPTION AND KEEPING QUALITY

Rangappa and Achaya (1975) describe *dahi* as, “Good *dahi* is a weak gel, like junket.” That is a very good description. The coagulum is soft and “livery.” The body of *dahi* may be termed as somewhat lumpy, and the texture as smooth. *Dahi* made from buffalo milk tends to be somewhat firmer than the product made with cow milk or a mixture of cow and buffalo milk. Limited volume of *dahi* made from goat milk also displays a firmer curd than cow milk product. Those differences are reflective of higher solids content of buffalo and goat milks. *Dahi* made industrially usually contains added solids and sweetener, and the mix is homogenized. The coagulum made from such fortified mixes is firmer, which is desired because, postfermentation operations such as breaking of the coagulum, pumping and filling, tend to weaken the curd structure, and loss of desired body characteristics. The firmer body attained industrially compensates for such postfermentation losses in body characteristics.

The Pure Food Act in India defines *dahi* or curd “as a semisolid product, obtained from pasteurized or boiled milk by souring (natural or otherwise), using a harmless lactic acid or other bacterial cultures. *Dahi* may contain additional cane sugar. It should have the same minimum percentage of fat and solids-not-fat as the milk from which it is prepared. Where *dahi* or curd, other than skimmed milk *dahi*, is sold or offered for sale without any indication of the class of milk, the standards prescribed for *dahi*

prepared from buffalo milk shall apply” (Aneja et al., 2002).

The keeping quality of *dahi* made in the unorganized sector varies considerably. Normally, *dahi* made in individual homes and sold in unorganized sector is consumed immediately, with a small portion retained for inoculating the next batch. If properly handled and refrigerated, *dahi* made in unorganized sector may have a shelf life of 2 to 3 days. Industrially manufactured, packaged *dahi* would have a shelf life of 7 to 10 days when properly refrigerated and handled.

*Dahi* is often described as the Indian equivalent of *yogurt*. In reality, however, there are distinct differences between the two products. Plain *yogurt* currently made is a firm, smooth product that can be spooned without much distortion of the curd body and structure. This is attained by the fortification of the mix with additional milk solids and (or) the use of stabilizers. *Dahi*, on the other hand, is a soft coagulum that is lumpy, and would display jagged edges when the curd is broken, and exude whey near the cut edges. While *yogurt* mixes are homogenized to give a smooth body, lack of homogenization and stabilizers in *dahi* manufacture (except in industrial production) give *dahi* a lumpy texture and tendency for whey off. In terms of flavor, *yogurt* is characterized by sharp acid tartness (recent trends in *yogurt* show a preference for mild acidity) and the characteristic “green,” acetaldehyde flavor (lately, a barely perceptible greenness is preferred). *Dahi*, on the other hand, is mildly acidic, and diacetyl is the prominent flavor compound. The difference in the flavor between *yogurt* and *dahi* is because of the starter flora used. This will be addressed in the next section. Industrial scale *dahi*, where coccus or coccus-rod combination is used, the product will have a flavor typical of *yogurt*. Those aspects are discussed by Aneja et al. (2002).

### MICROBIOLOGY

The predominant bacteria in *dahi* starter cultures consist of dairy lactococci and leuconostocs. The dairy lactococci are homofermentative, and produce >99% lactic acid from lactose. The dairy leuconostocs are heterofermentative, and produce about 70% lactic acid from sugars, and the remaining 30% of the byproducts are made up of acetic acid, ethyl alcohol, and carbon dioxide. The dairy leuconostocs also metabolize the citrate present in milk to form diacetyl and its reduced derivatives. While lactic acid



imparts the pleasant, mild acidic flavor, diacetyl contributes to a buttery, nut-meat like flavor. The other components (acetic acid, alcohol, and carbon dioxide) impart a balanced rounded flavor to *dahi*, much like Cultured Buttermilk. The presence of *Streptococcus thermophilus* and *Lactobacillus delbrueckii* subsp. *bulgaricus* in factory scale *dahi* starters, leads to the formation of acetaldehyde as in *yogurt*. The characteristics and the roles played by the starter flora of *dahi* and *yogurt* are summarized by Aneja et al. (2002).

Because *dahi* is largely made in the unorganized sector, where back-slopping is widely practiced, and controlled process conditions are not used, the bacterial flora of *dahi* is highly variable. Those aspects are discussed in detail by Rangappa and Achaya (1975). Because *dahi* is a cultured dairy product, bacterial count such as Standard Plate Count on a general media is unsuitable to provide the index of quality. Being an acid food, coliform count on *dahi* is unsuitable as a sanitary index. Count for enterococci would be more applicable as a sanitary index. In addition, yeast and mold count would be more relevant in quality attributes of *dahi*. For microbiological examination of *dahi* and its significance, the methods and the discussion provided for fermented dairy products in the Compendium of Methods for the Microbiological Examination of Foods (Richter and Vedamuthu, 2001) should be consulted. Aneja et al. (2002) have also detailed the procedures for chemical and microbiological quality control of *dahi*.

*Dahi*, being an acid food containing lactic acid bacteria, is not a conducive medium for the growth and survival of pathogens. Unless grossly contaminated with pathogens, from a public health viewpoint, *dahi* is a relatively safe product.

## KEFIR

### HISTORY

*Kefir* is made using *kefir grains*. Although the origin of *kefir* grains is unknown, the prevailing legend attributes that the grains were given to people inhabiting the region around Caucasus mountain range by Prophet Mohammed (Koroleva, 1991). Kosikowski and Mistry (1997) state that the grains, which sustain *kefir* fermentation were called "the gift of the gods." *Kefir* may be made with milk from different animal species. Kosikowski and Mistry (1997) mention that milk from the sheep, goat, and cow may be used for that product. Traditional fermentation

for *kefir* was carried out in a leather bag made of goat hide on a continuous basis by periodic withdrawal of a portion of the fermented product and replenishing the container with fresh milk. During warm months of the year, the fermentation bag was hung outdoors, and brought indoors during winter to keep it warm. An interesting practice was to hang the leather bag containing the fermenting milk near the door step, so that each person going past can kick or shake the bag to keep the contents mixed (Foster et al., 1957). Now, *kefir* is popular all over Russia, and the annual per capita consumption amounts to 4 to 5 kilograms.

### PRODUCTION, AND PACKAGING

The complete starter flora of *kefir* is contained within and on the surface of the *kefir* grains. *Kefir* grains vary in size and may measure from 0.5 to 3.5 cm in diameter. The grains are gelatinous white- or cream-colored irregular granules ranging in size from that of a wheat grain to a walnut. They have convoluted irregular folded surfaces resembling cauliflower florets and an elastic consistency (Robinson et al., 2002; Vedamuthu, 1982; Kosikowski and Mistry, 1997). Vedamuthu (1982) states that the granules are largely composed of a polysaccharide called *kifran*, which according to Kosikowski and Mistry (1997) is made up of glucose-galactose heteropolymer. There could be some denatured milk protein associated with *kifran* matrix. The grains are insoluble in water and resistant to enzymes. When soaked in water, the grains swell and turn to a slimy, jelly-like product. Within the involutions or folds of the grains, bacteria and yeasts that form the characteristic flora of *kefir* are found, and there appears to be a symbiotic association between the bacteria and the yeasts in that ecological niche (Vedamuthu, 1982).

The attractive feature about *kefir* grains is that they could be reused several times if proper sanitation is observed in recovering, drying, and storing the grains from batch to batch. When *kefir* curd is agitated, the grains migrate to the surface carried up by the entrapped carbon dioxide. The grains are strained out, rinsed in chill water, and either could be stored and refrigerated in cold water or drained and dried in a *warm* oven and stored in foil pouches. Wet-stored grains last up to 8 to 10 days without loss of activity, while dried grains may be active as long as 18 months (Kosikowski and Mistry, 1997). Dried *kefir* grains need to be activated by three consecutive passes in milk.

In traditional manufacture of *kefir*, whole milk pasteurized at 85°C for 30 minutes is cooled to 22°C, and inoculated with *kefir* grains. After overnight incubation at that temperature, a smooth curd is obtained. The curdled milk is run through a wire sieve to recover the grains. The product is then chilled and is ready for consumption (Kosikowski and Mistry, 1997). Commercial manufacture of *kefir* is described by Robinson et al. (2002). The process essentially consists of pasteurizing whole milk at 95°C for 5 minutes, and cooling the milk to 23°C. Incubation at 23°C follows inoculation with *kefir* grains. After 20-hour incubation, the grains are removed, and the curdled milk is used as a bulk starter for fresh batches. The bulk starter is added to the pasteurized (95°C for 5 minutes), tempered milk (at 23°C) at 3.5% (v/v). The inoculated milk is incubated at the same temperature for 20 hours. After cooling to <7°C, the product is held at that temperature for several hours to “ripen.” Ripening imparts “stability” to the product. After a sufficient period of ripening, the curd is gently broken and packaged to preserve the viscosity preferred by consumers.

Variations of that basic procedure are used when lyophilized *kefir* cultures (without *kefir* grains) serve as the inocula. For further details on the variations used in the manufacture of *kefir*, the reader is referred to Robinson et al. (2002).

## PRODUCT DESCRIPTION AND QUALITY

Good quality *kefir* is distinguished by a smooth soft curd, and a thick body preferred by discerning customers. When agitated, *kefir* fizzes and foams like beer (Kosikowski and Mistry, 1997). The flavor of *kefir* may be described as mildly alcoholic, yeasty-sour with a tangy effervescence (Vedamuthu, 1982). The effervescence and foaming is caused by the escaping carbon dioxide entrapped within the curd. The carbon dioxide is generated by the yeasts and heterofermentative lactic acid bacteria present in the *kefir* grains.

The quality and characteristics of *kefir* are highly variable. According to Robinson et al. (2002), the quality is greatly influenced by the origin and microflora of *kefir* grains used and the quality and type of milk (sheep, goat, or cow) used for its manufacture. With storage, there is a progressive increase in the concentration of lactic acid, ethanol and carbon dioxide in *kefir*. The peptide level also increases with aging. With the exception of the accumulation of the metabolic byproducts of fermentation, and a

decrease in the concentration of lactose and milk proteins, the composition of *kefir* does not differ from the milk used in its preparation. For further details, the chapter by Robinson et al. (2002) should be consulted.

## MICROBIOLOGY

The microflora of *kefir* grains are complex and highly variable. The flora associated with the grains varies from one geographical region to another and often within the same region. Sanitation during handling of the grain also introduces variability in the flora. Robinson et al. (2002) state that the microflora of *kefir* grains consists of an undefined mixture of species of bacteria and yeasts. The bacterial species include members of the genera *Lactobacillus*, *Lactococcus*, *Leuconostoc*, *Acetobacter*, and *Streptococcus thermophilus*. Often the mold, *Geotrichum candidum* is also found. In some countries where *kefir* is consumed, the presence of *Acetobacter aceti* and (or) *Acetobacter rasens* and *Geotrichum candidum* is considered to be as undesirable contaminants in some areas, although in other areas, their presence is desired. The authors report that several species belonging to different yeast genera are present in *kefir* grains. The complexity of the microflora associated with *kefir* grains as depicted by the authors is reproduced in Figure 19.1.

Kosikowski and Mistry (1997) also attest to the variability in the flora associated with *kefir*, but state that the dominant yeasts are *Saccharomyces kefir*, *Torula* or *Candida kefir*. The dominant bacteria include *Lactobacillus kefir*, *Lactococcus* spp. and *Leuconostoc* spp. They also mention *Acetobacter* spp. and *Geotrichum candidum*. Furthermore, they state that frequently the *kefir* grains are found to be covered with white cottony mycelia of *Geotrichum candidum*, which does not affect the quality of *kefir* produced from such grains. Improper handling of the grains introduces contaminants like coliforms, micrococci, and bacilli, which cause rapid spoilage of *kefir*.

Other bacteria reported to be present in *kefir* grains are *Lactobacillus brevis* and a capsular polysaccharide-producing strain of *Lactobacillus kifiranofaciens* (Robinson et al., 2002). The architecture of the *kefir* grains appears to consist of highly convoluted laminar sheets of yeasts, with the peripheral sheets dominated by various bacteria and the inner core dominated by yeasts.

*Kefir* made in Russia and the neighboring East European countries makes use of the traditional *kefir*

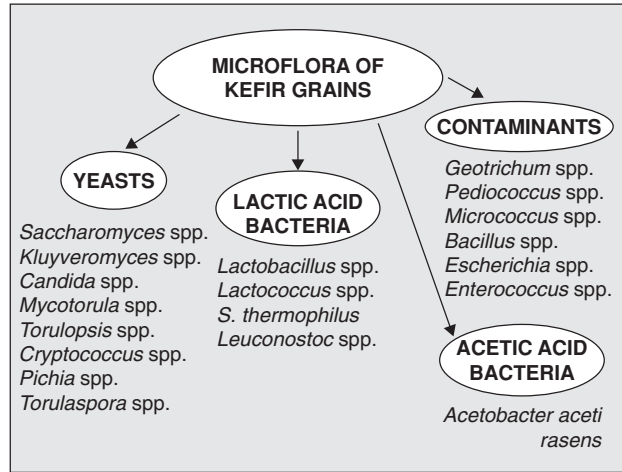

**Figure 19.1.** Microflora of Kefir grains. From Dairy Industries International, 1999. 65(5), 32–33. Reproduced with permission.

grains. Recently, however, several **nonyeast containing** flavored and unflavored fermented milks bearing the label *kefir* have appeared in several Western countries including the United States. Such products do **not** qualify as “traditional” *kefir*. There is no standard definition for *kefir*. Most of the **nontraditional kefir**s found in the Western markets are cultured with a mixture of dairy lactobacilli, lactococci, *Streptococcus thermophilus*, and a few probiotic bacterial species.

## KOUMISS

### HISTORY

The name *Koumiss* may be spelt differently in literature. The various spellings used are *Kumiss*, *Kumys*, and *Coomys* (Robinson et al., 2002). Although the product is fermented and has a titratable acidity ranging from 0.54% to 1.08% it is a liquid product showing no curdling. *Koumiss* is made from mare’s milk. It is believed to have originated among the Tartars, and spread across the Asiatic Steppes to Western regions of China and Mangolia. In China, the product is known by different names as mentioned in an earlier section.

### PRODUCTION

Traditional production was carried out by filling smoked horse’s hide with raw mare’s milk, and incubating at ambient temperatures. The smoked horse-hide used for *Koumiss* production was called

*tursuks* or *burduks*. The microflora adhering to the hides served as the inoculum. After sufficient length of incubation, the product was drained out of the hide containers and refilled with another batch of mare’s milk, essentially employing a back-slopping process (Robinson et al., 2002). Kosikowski and Mistry (1997) add that when mare’s milk incubated in hide containers fails to ferment properly, a piece of fresh horse skin, a tendon of a dead horse or a copper coin encrusted with copper sulfate verdigris were added to impel the progress of fermentation. They speculate that those materials probably contained the needed flora.

Several different commercial processes have been developed in the last four decades. Most of those methods use cow’s milk as the starting material. In one of the processes, skimmed cow’s milk fortified with 2.5% sucrose, and heated at 90° C for 2 to 3 minutes, was cooled to 28°C. Tempered milk was inoculated with starter culture consisting of *Lactobacillus delbrueckii* ssp. *bulgaricus* and a strain of *Torula* yeast at the rate of about 10% (v/v). After mixing for 15 to 20 minutes, the mix was incubated at 26°C, until the titratable acidity reached about 0.9%. Other blends that were used as starting materials consisted of a mixture of whole and skim milk and whey powders, a mixture made up of five parts of cow’s milk and eight parts of ultrafiltered rennet whey (with 2-fold concentration of whey proteins), and a third blend made up of a 50/50 mixture of cow’s milk and clarified whey (Robinson et al., 2002).

Kosikowski and Mistry (1997) have described a commercial process using mare's milk alone or a mixture of cow's milk and mare's milk. They have also described other variations in the manufacturing procedures. In addition to *Lactobacillus delbrueckii* ssp. *bulgaricus*, they also mention the inclusion of *Lactobacillus acidophilus* and *Saccharomyces lactis* instead of *Torula* spp. as starter flora for *Koumiss* production from cow's milk.

## PRODUCT DESCRIPTION

Traditional *Koumiss* is characterized by its milky gray color, with no tendency for "wheying off." The taste is described as, "sharp alcoholic and acidic" (Robinson et al., 2002). The main byproducts of *Koumiss* fermentation are lactic acid, ethanol, and carbon dioxide. Carbon dioxide gives the "fizziness" in the finished product. The viable bacterial counts in *Koumiss* may attain 50 million/ml and the yeast cell count about 14 million/ml. Depending on the extent of fermentation, the product is classified as weak, medium, and strong. The percent titratable acidity will vary from 0.54 to 0.72, 0.73 to 0.90, and 0.91 to 1.08 for weak, medium, and strong categories, respectively. Alcohol content in percentage will vary from 0.7 to 1.0, 1.1 to 1.8, and 1.8 to 2.5 for weak, medium, and strong categories, respectively (Robinson et al., 2002; Kosikowski and Mistry 1997).

*Koumiss* is prized as a therapeutic drink in Russia, and has been claimed to have curative properties for pulmonary tuberculosis (Kosikowski and Mistry, 1997).

## MICROBIOLOGY

The microflora of *Koumiss* is highly variable from region to region. In general, the bacterial species consist of lactobacilli (*Lactobacillus delbrueckii* ssp. *bulgaricus* and *Lactobacillus acidophilus*), lactose-fermenting yeasts (*Saccharomyces* sp. and *Torula koumiss*), nonlactose-fermenting *Saccharomyces cartilaginosus*, and *Mycoderma* spp. which do not ferment carbohydrate substrates. In *Koumiss* made in Mongolia, lactococci have been isolated, but their presence is undesirable, because of their rapid acid-generating property, which retards the development of yeasts that are necessary to give the characteristic properties of finished *Koumiss* (Robinson et al., 2002).

Most of the starter cultures developed was for *Koumiss* made from cow's milk. Such cultures

included different blends of lactobacilli and yeasts, which were mainly chosen for their ability to function in that substrate. A microbial survey of *Koumiss* made in Kazakhstan, showed the predominant presence of a galactose-fermenting *Saccharomyces unisporus*. That yeast, however, does not ferment lactose. The latter characteristic leads to slower fermentation, and a variety of metabolic byproducts such as glycerol, succinic acid, and acetic acid, which impart off-flavors to *Koumiss*.

In *Koumiss* (known as *Chigo*) made in inner Mongolia and China, the majority of lactobacilli found were identified as *Lactobacillus paracasei* ssp. *paracasei* and ssp. *tolerans* and *Lactobacillus curvatus*. The yeast species found were *Kluveromyces marxianus* ssp. *lactis* and *Candida kefir* (Robinson et al., 2002).

## ACIDOPHILUS MILK AND SWEET ACIDOPHILUS MILK

### HISTORY

Original *Acidophilus Milk* is a highly acidic, acid product with no balancing flavors. The acidity in the product may range from 1.5% to 2.0%. Because of its acidic flavor, it is not generally relished by most consumers. Physicians in the United States have prescribed *Acidophilus Milk* in the diet of persons suffering from either constipation or diarrhea and also for persons who experience intestinal distress on consuming ordinary milk. The latter effect is mainly related to the alleviation of lactose malabsorption. *Lactobacillus acidophilus* is found in large numbers in the intestines of normal, healthy individuals. There is some difference among strains of *Lactobacillus acidophilus* to establish in the human intestine. The strains capable of establishing in the human intestine exhibit the ability to survive and grow in the presence of normal levels of surface tension-depressing bile salts found in the enteric environment. Over the years, regular intake of *Acidophilus Milk* was found to be an excellent means of maintaining intestinal health. And, research showed that ingesting high numbers of selected, viable *Lactobacillus acidophilus* bacteria provided similar enteric-health effects. To promote wider consumption of such beneficial bacteria, modifications in the delivery of the microorganisms via milk were sought. That search gave rise to a product called "*Sweet Acidophilus Milk*." (Foster et al., 1957). Actual widespread commercialization of *Sweet Acidophilus Milk* came about in

1970s. This was the forerunner of *Probiotic Milks* widely prevalent today.

### PRODUCTION OF ACIDOPHILUS MILK

Traditional *Acidophilus Milk* is made from low-fat (partially skimmed) milk. The milk is sterilized at 120°C for 15 minutes to stimulate *Lactobacillus acidophilus*, which is used as a pure culture. *Lactobacillus acidophilus* lacks a good proteolytic system for hydrolyzing milk proteins. The high heat treatment used denatures and releases peptides from milk proteins, which helps the growth of the organism. After heat treatment, the milk is tempered to 37 to 38°C, and inoculated with a milk starter at the rate of 5%. The inoculated milk is gently stirred to mix the inoculum, avoiding much incorporation of air, and incubated quiescently for 18 to 24 hours. When the acidity reaches 1.0%, the product is cooled to less than 7°C, and bottled (Vedamuthu, 1982). A similar process is described by Kosikowski and Mistry (1997).

### PRODUCTION OF SWEET ACIDOPHILUS MILK

The original idea for delivering health-imparting *Lactobacillus acidophilus* bacteria in unfermented sweet milk was mooted by Myers in 1931 (Myers, 1931). He reported that *Lactobacillus acidophilus* is inhibited by storage temperatures between 18°C and 20°C, and the development of acid is entirely prevented in milk held below 10°C. He also found that milk containing *Lactobacillus acidophilus* cells could be kept “sweet” for as long as 7 days if kept refrigerated at 2 to 5°C. The first prototype of the product that was commercialized in the 1970s was made in Oregon State University and was described by Duggan et al. (1959). That product was made by adding a concentrated cell suspension of the organism to cold (5°C), pasteurized milk, mixing to obtain homogenous distribution of the culture, bottling, storing, and enumerating the bacterial numbers in the milk held under refrigeration. The *Lactobacillus acidophilus* cells retained their viability, when handled thus for a week, but did not cause any fall in the pH of the milk.

The idea was revived in the 1970s, and a strain of *Lactobacillus acidophilus* isolated from a human subject, was subjected to taxonomic regime required to confirm its identity. The strain was further tested for resistance to low pH and bile levels encountered in

human enteric system and intensively studied in the laboratory at North Carolina State University. A reliable fermentation procedure to propagate the strain in a food compatible medium to high numbers was developed. Further work was pursued to concentrate the cells, preserve the cell concentrate by freezing, and testing the cells for viability in cold, pasteurized milk over 15 to 21 day storage under normal refrigeration conditions prevalent during distribution channels in retail trade. Based upon the results, a suitable usage rate was established. The bacterial strain designated *Lactobacillus acidophilus* NCFM, and the technology developed in the laboratory was licensed by the North Carolina State University Foundation to a marketing firm. The name “Sweet Acidophilus Milk” was registered as a trademark. The marketing company under an exclusive licensing agreement with a commercial starter company popularized the sale of the branded name product. An arbitrary minimum cell count of 2 million colony forming units per milliliter (cfu/ml) was recommended in “Sweet Acidophilus Milk” over the normal “open dating” period used in the industry for pasteurized low-fat and skim milk (usually 14 days). This stipulation was adopted by most States in the United States, and the State of California later amended the requirement to 4 million cfu/ml throughout a 14-day shelf life.

Other starter companies also sold frozen concentrated cultures for making a similar product. Products made with cultures from nonlicensed culture manufacturers were *not* allowed to use the registered trademark, “Sweet Acidophilus Milk.” The frozen culture concentrate (also in pelletized form) was sold in 170 to 200 gram containers for inoculation into 2000 liters of cold pasteurized milk. The manufacturing process was simple and consisted of adding the required amount of frozen culture concentrate to cold pasteurized low fat or skim milk, mixing to distribute the cells evenly, and bottling the product.

### QUALITY STANDARDS

There were no definite standard counting procedures for establishing the viable count of *Lactobacillus acidophilus* cells in *Sweet Acidophilus Milk*, when the product was first introduced in the market. The procedure(s) adopted by State regulatory agencies gradually evolved over time. Early procedure used plating-suitable dilutions (according to Standard Methods for the Examination of Dairy Products—APHA) of a well-mixed sample of milk on deMan/Ragosa/Sharpe agar (MRS agar) and incubating the plates in an

anaerobic jar at 35 to 37°C for 72 hours. Later, the method called for the use of MRS agar containing 0.15% bile salts (Ox bile Salts). Certain establishments required the use of a more stringent Ragosa agar (or acidified Lactobacilli Selective agar) containing 0.15% bile salts.

## MICROBIOLOGY

There has been a considerable discussion among the academic, industrial, and regulatory circles of the need to establish the exact species identity, strain history, and salient characteristics that distinguish their suitability for enteric therapy of various cell concentrates offered for sale to produce *Sweet Acidophilus Milk*. That led Sanders et al. (1996) to examine several commercial cultures on the market for the aforementioned features. The problem has been compounded by the introduction of “*Probiotic Milks*” recently, which contain several different bacterial strains and species. Those aspects will be discussed later.

The most widely studied *Lactobacillus acidophilus* strain for enteric therapy is *Lactobacillus acidophilus* NCFM. The published findings are summarized by Sanders and Klaenhammer (2001).

## PROBIOTIC MILKS

### HISTORY

*Probiotic Milks* came into prominence over the last two decades. The term *probiotic* is of a relatively recent origin. Currently, probiotics form a distinct category under “Functional Foods.” Functional foods (or nutraceuticals) are food components that provide demonstrated physiological benefits or reduce the risk of chronic disease beyond their basic nutritional functions (Shah, 2001). According to the U.N. Agency, Food and Agriculture Organization, “probiotics are live microorganisms, which, when administered in adequate amounts, confer a health benefit on the host” (Shelke, 2003). The benefits of regular intake of probiotics are many, including alleviation of lactose maldigestion, reduction in serum cholesterol, immune stimulation, antimicrobial, antimutagenic, and anticarcinogenic effects, maintaining intestinal health and general well-being (Shah, 2000). Other purported benefits are discussed by Sanders and Huis in’t Veld (1999), Chandan (1999), and others. Bacteria, especially species belonging to the genera, *Lactobacillus* and *Bifidobacterium* are almost exclusively

used as probiotics (Chandan, 1999; Sanders and Huis in’t Veld, 1999; Shah, 2001). Members of the aforementioned two-bacterial genera are normal inhabitants of healthy human gut, and have been shown to play a regulatory role in the ecology and microbial flora of the gut (Chandan, 1999; Sanders and Huis in’t Veld, 1999). Among the various benefits reported for the intake of probiotics, the evidence for maintenance of gut health is equivocal. For extensive discussion of the role of those bacteria in maintaining gut health, the reviews by Sandine (1972), Speck (1976, 1978), Vaughan et. al (2002), and Hopkins (2003) should be consulted.

One of the earliest marketed *Probiotic Milks* contained *Lactobacillus acidophilus* and *Bifidobacterium* spp., and bore the trade name A/B Milk. Presently, several *Probiotic Milks* with different brand names containing a variety of lactobacilli and bifidobacteria are available in the market in North America, Europe, and the Far East (Sanders and Huis in’t Veld, 1999; Shelke, 2003). Every passing day, purported new clinically proven probiotic strains are being added to the list.

## PRODUCTION OF PROBIOTIC MILKS

*Probiotic Milks* are made in the same manner as *Sweet Acidophilus Milk*. Probiotic cultures in concentrated form are added to cold pasteurized low fat or skim milk to give the desired numbers in the milk over the normal open dating target period. After mixing to get uniform distribution of the cells, the milk is bottled. Several different probiotic strains are added presently.

## QUALITY STANDARDS

There are no regulatory standards for *Probiotic Milks* except those that apply to pasteurized milk. For A/B type milk, the consensus in the industry was to require a viable cell count of 2 million cfu/ml for *Lactobacillus acidophilus* and *Bifidobacterium* spp. respectively. When products with multiple strains appeared in the market, there was confusion in the trade as to the exact requirements that should be stipulated to meet an “informal standard.” Guidelines have been developed by regulatory agencies with respect to “health claims” that could be made on the labels on the packages. Presently, most *Probiotic Milks* in the market list the cultures present in the milk on their labels. The technological challenges in the selection, propagation, preservation, and handling of cultures

for probiotic applications are extensively discussed by Mattila-Sandholm et al. (2002).

A major hurdle in fixing the exact viable cell counts (cfu/ml) for each of the probiotic strains is the lack of a reliable, accurate, reproducible, and routinely usable method(s) to get differential counts of the strains/species added to the milk. Several attempts have been made in developing suitable methods (Shah, 2000), but so far none is adequate for regulatory purposes.

As referred to earlier, one of the primary concerns is establishing the exact identity of the strains/species used and declared on the labels of *Probiotic Milks*. Bacterial taxonomy has undergone rapid changes with the advent of genetic probes, and with that development, the taxonomic status of many strains/species has eroded and in many cases entirely altered. Realizing the need for establishing modern criteria to establish the taxonomic status of strains/species used in *Probiotic Milks*, Yeung et al. (2002) examined a large number of cultures using newly developed genetic probes, and published a status paper on the subject. Their work would go a long way in establishing the credibility of the industry in marketing a truly probiotic product.

## BULGARIAN MILK

*Bulgarian Milk* is also known as *Bulgarian Butter-milk*. As the name suggests the product originated in Bulgaria. The longevity enjoyed by people in and around Bulgaria, who regularly consumed *Bulgarian Milk* prompted one of Elias Metchinkoff's associate to study that product. He isolated a *Lactobacillus* culture from that product, which was later assigned the nomenclature, *Lactobacillus bulgaricus* (now, *Lactobacillus delbrueckii* ssp. *bulgaricus*). Metchinkoff studied the organism for its therapeutic value. From his observations, Metchinkoff postulated that high acid produced by the isolate had a suppressive effect on toxin-producing organisms in the large intestines, and prevented putrefaction and autotoxification in the individual consuming fermented milk rich in *Lactobacillus delbrueckii* ssp. *bulgaricus*. Later, he wrote a book, entitled, *The Prolongation of Life*. His observations laid the foundation for the present interest in probiotics (Kosikowski and Mistry, 1997).

In the production of *Bulgarian Milk*, milk is heated at 82–85°C for 30 minutes, and cooled to 37°C. An inoculum of a pure culture of *Lactobacillus delbrueckii* ssp. *bulgaricus* made in sterile milk (incubated at 37°C, and a final acidity of 1.0% or slightly

higher), is used to seed a bulk starter made up of milk. Bulk starter is added at the rate of 1–2% to the prepared milk tempered at 37°C, incubated till the acidity reaches 1.0%, cooled to 5–7°C, and packaged. Most consumers do not relish acidities >1.0% in Bulgarian Milk offered for sale (Foster et al., 1957, Kosikowski and Mistry, 1997).

## SKYR

*Skyr* has been produced in Iceland from the tenth century. The product was introduced into Denmark in the mid-1900. It is actually a concentrated form of *Yogurt* curd. The manufacturing procedure is very similar to the production of *Yogurt*. In commercial production, skim milk heated to 93°C for a few minutes, is tempered at 42–44°C, and inoculated with a mixture of *Streptococcus thermophilus* and *Lactobacillus delbrueckii* ssp. *bulgaricus* (0.1–0.5%). This is followed by the addition of 0.005% rennet. After uniform distribution of the additives, the seeded milk is incubated at 42–44°C. Under those conditions, coagulation is achieved in 3–4 hours. When the acidity reaches 1.4–1.6% (after approximately 20–24 hours), the curd is transferred into cloth bags for the draining of sufficient whey to achieve a curd-solid content of 18–20%, and a titratable acidity of 2.5–3.0%. The product is then packaged and cooled (Foster et al., 1957).

Robinson et al. (2002) report that lactose-fermenting yeasts and *Lactobacillus helveticus* are often found in starters used for *Skyr*. They have also described three mechanized processes, where the use of a nozzle separator and membrane filtration of curd could be used for concentration of solids. Another variation involves the preformulation of milk solids and fat to attain the desired solids concentration, before the fermentation step.

## VILI

*Vili* is known by several different names in the Scandinavian countries. The product is extremely popular in Finland. It is a mildly acidic product made with specially selected exopolysaccharide (capsular slime) producing strains of dairy lactococci. Such strains develop a mucoid and (or) stringy (ropy) coagulum. Often *Geotrium candidum*, a mold is included in the starter. Being strictly aerobic, the mold forms a fuzzy mat on the surface of the product. The mold metabolizes lactic acid generated by the lactococci

in the curd layers immediately below the mycelial mat. The product is often eaten with the addition of powdered cinnamon.

The product is produced from whole or low-fat milk. After heat treatment at 80°C for 30 minutes or modified HTST pasteurization (78°C for 2 minutes), the milk is cooled to 20–21°C and 1.0% starter is added, and mixed. The seeded milk is filled into packages. The filled packages are rolled into a walk-in incubator held at 20–21°C. When the pH reaches 4.6, the containers are rolled into a cooler.

## MICROBIOLOGY

Starter culture for *Villi* consists of a mixture of ropy (mucoid) and nonropy (nonmucoid) strains of *Lactococcus lactis* ssp. *lactis* and *cremoris*. Many of the mucoid lactococci are sluggish acid producers. To compensate, nonmucoid, relatively rapid acid-generating lactococci are included in the starters.

Mucoid lactococci are as susceptible to phages as nonmucoid types (Deveau et al., 2002). Because of the likelihood of phage infection of lactococci in industrial settings, phage-unrelated strains are used in starter rotations. There is a paucity of suitable mucoid lactococcal strains for use in starter rotations for *Villi* manufacture. Exopolysaccharide production among lactococci is an unstable characteristic. Exopolysaccharide production is easily lost upon repeated transfer of cultures, high-temperature incubation, and abuse during propagation. Some of the genes associated with exopolysaccharide production are found on plasmids (Vedamuthu and Neville, 1986). Technology for converting nonmucoid ( $Muc^-$ ) lactococcal strains to mucoid phenotypes ( $Muc^+$ ) through conjugative transfer of plasmid-carrying mucoid genes ( $Muc^-$ -plasmid) has been patented (Vedamuthu, 1989). The entire molecular characterization of exopolysaccharide production among lactococci was elucidated by van Kranenburg (1999).

## REFERENCES

- Aneja RP, Mathur BN, Chandan RC, Banerjee AK. 2002. Cultured/fermented products. Technology of Indian Milk Products. A Dairy India Publication, Delhi, India, pp. 159–182.
- Chandan RC. 1999. Enhancing market value of milk by adding cultures. *J. Dairy Sci.* 82:2245–2256.
- Dairy Industries International. 1999. Microflora of Kefir Grains. 65(5):32–33.
- Deveau H, Van Calsteren M–E, Moineau S. 2002. Effect of exopolysaccharides on phage-host interactions in *Lactococcus lactis*. *Appl. Environ. Microbiol.* 68:4364–4369.
- Duggan DE, Anderson AW, Elliker PR. 1959. Frozen concentrate of *Lactobacillus acidophilus* for preparation of a palatable *Acidophilus* milk. *Food Technol.* 13:465–469.
- Foster EM, Nelson FE, Speck ML, Doetsch RN, Olson JC Jr. 1957. Microbiology of fermented milks. Dairy Microbiology, Prentice-Hall, Inc., Englewood Cliffs, NJ, pp. 318–333.
- Hopkins M. 2003. The intestinal microflora. Understanding the Symbiosis. John Libbey Eurotext, Montrouge, France, p. 47.
- Koroleva NS. 1991. Products prepared with lactic acid bacteria and yeasts. In: RK Robinson (Ed), Therapeutic Properties of Fermented Milks. Elsevier Applied Science, London, pp. 159–179.
- Kosikowski FV, Mistry VV. 1997. Cheese and fermented milk foods. In: FV Kosikowski (Ed), Origin and Principles. Fermented Milks, Vol. 1. LLC, Westport, Ct, pp. 57–74.
- Mattila-Sandholm T, Myllarinen P, Crittenden R, Mogensen G, Fonden R, Saarela M. 2002. Technological challenges for future probiotic foods. *Intern. Dairy J.* 12:173–182.
- Myers RP. 1931. Transformation of the intestinal flora through the feeding of unfermented *acidophilus* milk. *Amer. J. Public Health* 21:867–872.
- Prajapati JB. 2003. Fermented foods of India. Abstract, International Seminar and Workshop on Fermented Foods, Health status and Social Well-being (Souvenir), Gujarat Agricultural University, Anand, India, pp. 1–4.
- Rangappa KS, Achaya KT. 1975. Preparation, Quality and Composition of Dahi and Lassi. Indian Dairy Products, Asia Publishing House, Bombay, India, pp. 124–136.
- Richter RL, Vedamuthu ER. 2001. Milk and Milk Products. In: FP Downes, K Ito (Eds), Compendium of the methods for the microbiological examination of foods, 4th ed. American Public Health Association, Washington, DC, pp.483–496.
- Robinson RK, Tamime AY, Wszolek M. 2002. Microbiology of Fermented Milks. In: RK Robinson (Ed), Dairy microbiology handbook: The microbiology of milk and milk products, 3rd ed. Wiley-Interscience, John Wiley & Sons, New York, pp. 367–430.
- Sanders ME, Huisin't VJ. 1999. Bringing a probiotic-containing functional food to the market: microbiological, product, regulatory and labeling issues. *Antonie van Leeuwenhoek* 76:293–315.



- Sanders ME, Klaenhammer TR. 2001. Invited review: The scientific basis of *Lactobacillus acidophilus* NCFM functionality as a probiotic. *J. Dairy Sci.* 84:319–331.
- Sanders ME, Walker DC, Walker KM, Aoyama K, Klaenhammer TR. 1996. Performance of commercial cultures in fluid milk applications. *J. Dairy Sci.* 79:943–955.
- Sandine WE, Muralidhara KS, Elliker PR, England DC. 1976. Lactic acid bacteria in food and health: A review with special reference to enteropathogenic *Escherichia coli* as well as certain enteric diseases and their treatment with antibiotics and lactobacilli. *J. Milk Food Technol.* 35:691–702.
- Shah NP. 2000. Probiotic bacteria: Selective enumeration and survival in dairy foods. *J. Dairy Sci.* 83:894–907.
- Shah NP. 2001. Functional foods from probiotics and prebiotics. *Food Technology* 55(11):46–53.
- Shelke K. 2003. Gut news. *Food Processing* 64(7):36–38.
- Skovsende A. 2003. Probiotics: Good for what's bugging you. *Nutraceuticals World* 6(9):84–88.
- Speck ML. 1976. Interactions among lactobacilli and man. *J. Dairy Sci.* 59:338–343.
- Speck ML. 1978. Acidophilus food products. *Developments Indus. Microbiol.* 19:95–101.
- van Kranenburg R. 1999. Exopolysaccharide biosynthesis in *Lactococcus lactis*: A molecular characterization. Ph. D. dissertation, Wageningen University, The Netherlands. Ponsen & Looijen NV, Wageningen, The Netherlands.
- Vaughan EE, de Vries MC, Zoetendal EG, Ben-Amor K, Akkermans ADL, de Vos WM. 2002. The intestinal LABs. *Antonie van Leeuwenhoek.* 84:341–352.
- Vedamuthu ER. 1982. Fermented Milks. *Economic Microbiology, Vol. 7, Fermented Foods*, pp. 199–226.
- Vedamuthu ER. 1989. Method for producing mucoid and phage resistant group N *Streptococcus* strains from non-mucoid and phage sensitive parent strains. United States Patent, 4, 874, 616.
- Vedamuthu ER, Neville JM. 1986. Involvement of a plasmid in production of ropiness (mucoidness) in milk cultures by *Streptococcus cremoris* MS. *Appl. Environ. Microbiol.* 51:677–682.
- Yeung PSM, Sanders ME, Kitts CL, Cano R, Tong PS. 2002. Species-species identification of commercial probiotic strains. *J. Dairy Sci.* 85:1039–1051.

*Manufacturing Yogurt and Fermented Milks*  
Edited by Ramesh C. Chandan  
Copyright © 2006 by Blackwell Publishing

# **Part IV**

# **Health Benefits**

# 20

## Functional Foods and Disease Prevention

*Ramesh C. Chandan and Nagendra P. Shah*

- Introduction
- Functional Foods
- Bioactive Dairy Ingredients
  - Milk Proteins
  - Bioactive Peptides
  - Lactose
  - Milk Fat
  - Minerals and Vitamins
- Probiotics
  - Beneficial Microflora
  - Health Benefits of Probiotic Products
  - Requirements for Effective Probiotics
  - Production of Enzymes, Vitamins, and Bacteriocins
  - Bioavailability of Calcium
  - Reduction in Serum Cholesterol
  - Prevention of Diarrhea, Vaginitis and Dermatitis
  - Anticarcinogenesis
  - Immunomodulatory role
  - Manufacture of Probiotics for Use as Food Supplements
- Fortification
- Physiologically Active Ingredients
- References

### INTRODUCTION

The foods that contain significant levels of biologically active components that impart health benefits beyond basic nutrition are generally referred to as functional foods. The driving forces behind the development of functional foods are ascribed to: (a) Scientific advances in our understanding of the role that foods play in disease prevention. Six out of the ten leading causes of death in the Western world can be linked to diet, e.g., cancer, coronary heart disease, stroke, diabetes, atherosclerosis, and liver diseases; (b) The finding that 70% of certain cancers are primarily caused by dietary factors; (c) Consumer

demands. Consumers are starting to regard foods as “miracle medicine;” (d) Increasing cost of health care. Accordingly, prevention rather than cure, is increasingly being recognized; (e) Increases in the proportion of older persons in general population; (f) Technical advances in the food industry leading to a shift in focus from removing harmful components to replacing or enhancing positive components; (g) Changes in regulatory attitudes. The struggle between the Food and Drug Administration and the food industry in relation to health claims for foods is a good example; (h) The recent discovery of phytochemicals and probiotics has boosted the search for and the development of functional foods.

Depending on the supplement, the functional foods can be called designer foods, nutraceutical, pharmafood, or phytochemical food (Goldberg, 1994; Shah, 2004). With the current emphasis on cost-effective health care, the importance of dietary changes to optimize health continues to gain recognition and acceptance. As a result, the food industry is responding to consumer demands for a more healthful food supply by developing nutrient-rich food products, including products lower in fat and sodium that are consistent with the U.S. dietary guidelines for Americans. In another effort to help the public make sound dietary choices, the nutrition labeling and education act has resulted in more responsible labeling of all food items. Food labels provide a reliable source of applicable nutrition information for consumers to help them make informed purchase decisions.

Nutrient-rich foods can be developed either by fortifying a component that improves the nutritional value or by effective plant breeding by genetically engineering of the plants. Success is already seen in production of oranges with high vitamin C content and

high phytochemical broccoflower (Goldberg, 1994). Yet another potential area to generate an array of products that fit into the current consumer demand for health driven foods is the milk-based dairy products (Chandan, 1999). The reader is referred to a book titled *Functional Dairy Products*, edited by Mattila-Sandholm and Saarela (2003) for comprehensive information on this topic.

Diet-health link is now an integral part of a healthy life style. The role of diet and specific foods for the prevention and treatment of disease and improvement of body functions is now being recognized. Present day consumers prefer foods that promote good health and prevent disease. Such foods need to fit into current lifestyles providing convenience of use, good taste, and acceptable price-value ratio. The dairy industry offers foods with established health-related benefits and therefore constitutes a family of natural functional foods.

This chapter presents an overview of functional foods and various bioactive ingredients present in milk and fermented milks. Current trend is to offer products or ingredients specifically enriched for application in various foods to enhance their functional spectrum. Furthermore, the use of probiotics is discussed briefly as a means to supplement the functional attributes in milk products. For detailed discussion of probiotics, the reader is referred to Chapter 22. Possible health benefits of consuming cultured and culture-containing milks have been briefly summarized in this chapter.

## FUNCTIONAL FOODS

The current trend to provide specific health benefits beyond sustenance accorded by food intake has roots in ancient medicine systems. The prevention and management of disease was recognized in India some 5,000 years ago with the development of Ayurvedic (Science of Life) system of medicine. Use of active ingredients isolated from plants, herbs, minerals, and animals formed the core of this medical practice to prevent disease and treat certain disorders. The emphasis was prevention and management of common disorders by following specific dietary pattern in response to individual body requirements. Later, in third century BC, Chinese emperor Shen Nong discovered that certain plants and herbs have a medicinal value.

Currently, an interactive discipline of nutrition and food science has produced an array of food products that represent a vibrant, dynamic, and emerging

segment of the food industry. Such foods in diet furnish traditionally recognized nutrients and in addition provide specific health benefits. The objective of consuming these foods is to rectify or manage certain disease states, reduce the risk of disease, or maintain good health. This category of foods includes medical foods, supplements, biofoods, performance foods, special infant formulas, as well as foods specially formulated to deliver ingredients such as insoluble and soluble fiber, vitamins and minerals, antioxidants, phytosterols, concentrates of specific dairy proteins, soy preparations, probiotics, and healthy fats and oils.

The epidemiological, experimental, and clinical research has shown that consumption of diets high in fiber lowers the risk of colorectal cancer and cardiovascular disease. For example, a diet containing viscous polysaccharides lowers the low-density lipoproteins (LDL) and total serum cholesterol by bile acid turnover and lipid absorption. Furthermore, the beneficial effect may be ascribed to slow down in carbohydrate absorption, increase in stool bulk, and production of short-chain fatty acids in the colon. It is now known that factors in diet influencing the reduction in cardiovascular disease are generally constituents of plant foods including antioxidants, phenolics, carotenoids, and flavonoids. The phytoestrogens (namely, coumesterol) of certain beans may reduce bone loss. Isoflavones present in soy are recognized to be beneficial in reducing risk of cancer and heart disease.

Vitamin E and folic acid are now considered to be important for their role in preventing heart disease. Folic acid is also important in lowering the risk of neural tube defect in babies. Thus, new diet strategies for optimum health involve consumption of much higher level of fruits, vegetables, legumes, nuts, and whole grains than previously believed.

## BIOACTIVE DAIRY INGREDIENTS

Milk has been described as nature's nearly perfect food as it provides vital nutrients including proteins, essential fatty acids, minerals, and lactose in balanced proportions. Leading nutrition experts recognize milk and milk products as important constituents of a well-balanced and nutritionally adequate diet. In this regard, milk products complement and supplement nutrients available from grains, legumes, vegetables, fruits, meat, seafood, and poultry.

Milk is composed of a unique set of constituents. More information on the composition of milk is given

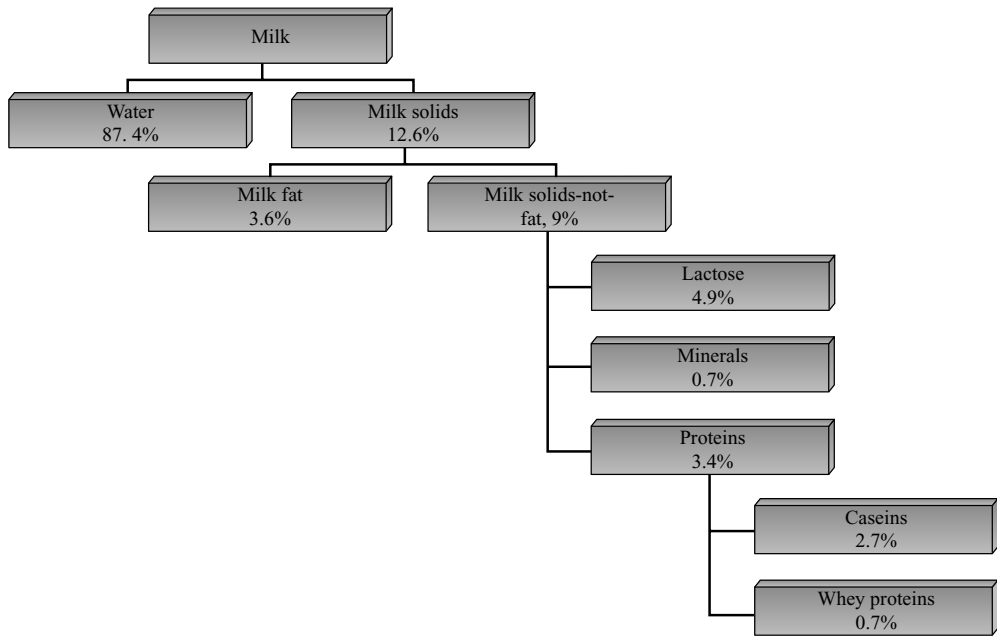

**Figure 20.1.** Nutritional composition of milk.

in Chapter 2. The major components are shown in Fig. 20.1. It is necessary to understand the nutritional composition of milk to comprehend the functional aspects of its constituents.

These constituents perform nutritional function as well as physiological functions. They act independently and synergistically with each other. The role of major and minor constituents in human nutrition is intertwined with newly discovered physiological benefits. We will briefly highlight both nutritional and physiological benefits of consuming yogurt and fermented milks.

Typical nutritional profile of yogurt is shown in Table 20.1.

## MILK PROTEINS

The major proteins of milk are casein and whey proteins in the ratio of 80 to 20. Casein further consists of various fractions including  $\alpha_{S1}$ - and  $\alpha_{S2}$ -casein,  $\beta$ -casein and  $\kappa$ -casein (Table 20.2). Also shown are the major whey proteins of milk.

Nutritional value of milk proteins has been recognized for many years. Table 20.3 shows the nutritional value of milk proteins compared with other proteins.

The protein efficiency ratio of whey protein is slightly lower than that of whole egg protein, which is considered as the best protein. Compared to plant proteins, dairy proteins provide highest quality and absorption characteristics. In other words, to achieve the requisite amino acids, our requirement for protein is much lower when milk proteins are included in our diet. Table 20.4 illustrates this point.

It is apparent from this table that minimum requirement for lactalbumin is lower than that of potato, but a combination of 30 parts of potato and 70 parts of lactalbumin balances the amino acids in a synergistic way and the requirement of the mixture is lower than that of either potato or lactalbumin. Thus, a combination of whey protein and cereal-based food or potato can enhance the nutritional profile.

Various milk constituents contribute to the physiological effects. Table 20.5 illustrates some of the potential benefits.

Both caseins and whey proteins of milk possess biological and physiological properties. For more information on the physical and chemical characteristics of milk proteins, refer to Chapter 2. Hutch et al. (2004) have examined the emerging role of dairy proteins and bioactive peptides in nutrition

**Table 20.1.** Typical Nutritional Profile of Yogurt

Nutrient (Per 8 oz. serving = 227 g)	Plain			Fruit-Flavored		Light, Vanilla
	Nonfat	Low Fat	Whole Milk	Nonfat	Low Fat	Nonfat
Moisture	85	85	88	75	74	87
Calories (kcal)	127	144	139	213	231	98
Protein (g)	13	12	8	10	10	9
Total fat (g)	0.5	4	7	Tr	2	Tr
Saturated fatty acids (g)	0.3	2.3	4.8	0.3	1.6	0.3
Monosaturated fatty acids (g)	0.1	1.0	2.0	0.1	0.7	0.1
Polyunsaturated fatty acids (g)	Tr	0.1	0.2	Tr	0.1	Tr
Cholesterol (mg)	4	14	29	5	10	5
Carbohydrate (g)	17	16	11	43	43	17
Total dietary fiber (g)	0	0	0	0	0	0
Calcium (mg)	452	415	274	345	345	325
Iron (mg)	0.2	0.2	0.1	0.2	0.2	0.3
Potassium (mg)	579	531	351	440	442	402
Sodium (mg)	174	159	105	132	133	134
Vitamin A (IU)	16	150	279	16	104	0
Thiamin (mg)	0.11	0.1	0.07	0.09	0.08	0.08
Riboflavin (g)	0.53	0.49	0.32	0.41	0.40	0.37
Niacin (mg)	0.3	0.3	0.2	0.2	0.2	0.2
Ascorbic acid (mg)	2	2	1	2	2	2

Note: Data is for yogurts fortified with nonfat dry milk, except for plain whole milk yogurt (Chandan, 2004).

Source: United States Department of Agriculture, 2002.

**Table 20.2.** Casein Fractions and Whey Proteins of Cow's Milk

Casein Fractions	Concentration (g/liter)
$\alpha$ - <sub>s1</sub> -Casein	10.3
$\alpha$ - <sub>s2</sub> -Casein	2.7
$\beta$ -Casein	9.7
$\kappa$ -Casein	3.5
C-terminal $\beta$ -Casein fragments	0.8
Whey Proteins Fractions	Concentration (g/liter)
N-terminal $\beta$ -casein fragments	0.8
$\beta$ -Lactoglobulin	3.4
$\alpha$ -Lactalbumin	1.3
Immunoglobulins	0.8
Bovine Serum Albumin	0.4
Lactoferrin	0.02–0.2
Lactoperoxidase	0.03
Lysozyme	130 $\mu$ g/liter

Adapted from: Chandan, 1999; Schaafsma and Steijns, 2000.

and health. The biological properties of milk proteins are summarized in Table 20.6.

In studies with mice, it has been shown that whey proteins enhance humoral immune response. The sulfhydryl containing aminoacids, cysteine and glutathione, are related to immune response. Whey proteins are rich in cysteine.  $\beta$ -Lactoglobulin contains 33 mg of cysteine per gram protein, while  $\alpha$ -lactalbumin and bovine serum albumin contain 68 and 69 mg cysteine per gram protein, respectively. The –SH compounds are also involved in quenching toxic-free radicals.

$\alpha$ -Lactalbumin is a calcium binding protein and thereby enhances calcium absorption. It is an excellent source of essential amino acids such as tryptophan and cysteine. Tryptophan regulates appetite, sleep-waking rhythm, and pain perception. Cysteine is important in functions of –SH compounds.  $\alpha$ -Lactalbumin interacts with galactosyltransferase enzyme to promote transfer of galactose from UDP-galactose to glucose to form lactose in the mammary gland.

The immunoglobulins of milk are important for imparting immune defense for the host. IgG1 is a major component. Milk contains 0.6 g/liter of IgG1,

**Table 20.3.** Comparative Nutritional Value of Proteins

Protein	PER <sup>a</sup>	AAS <sup>b</sup>	BV <sup>c</sup>	PD <sup>d</sup>	PDCAAS <sup>e</sup>
Milk protein	3.1	1.27	91	0.95	1.21
Casein	2.9	1.24	77	0.99	1.23
Whey proteins	3.6	1.16	104	0.99	1.15
Whole egg	3.8	1.21	100	0.98	1.18
Soya	2.1	0.96	–	0.95	0.91
Wheat	1.5	0.47	–	0.91	0.42

<sup>a</sup>PER (Protein Efficiency ratio). Gain in body weight divided by weight of protein consumed by growing rats fed 10% (w/w) of test or reference protein.

<sup>b</sup>AAS (Amino Acid Score). Content of the first limiting essential amino acid of the test protein compared with the content of that essential amino acid in a reference pattern of essential amino acids.

<sup>c</sup>BV (Biological value). Proportion of absorbed protein that is retained for body maintenance and/or growth.

<sup>d</sup>PD (Protein Digestibility). Proportion of food protein absorbed.

<sup>e</sup>PDCAAS (Protein Digestibility Corrected Amino Acid Score). Ratio of mg of limiting amino acids in 1 g of test protein and mg of the same amino acid in reference requirement pattern multiplied with True Digestibility.

$$\text{True Digestibility} = \frac{I(F - f)}{I}$$

Where I = nitrogen intake, F = total fecal nitrogen excretion, and f = fecal nitrogen excretion on a protein-free diet.

Adapted from: Schaafsma and Steijns, 2000.

whereas colostrum contains substantially higher level of 48 g/liter of IgG1. Other fractions are IgG2, IgA, IgM, all of which provide passive immunity.

A number of colostrum products are being marketed to improve functionality of milk. Colostrum contains several functional constituents including antibodies, lactoferrin, lactoperoxidase, cytokines, and growth factors. The antibodies act as antimicrobial agents against infection from rotavirus (which causes diarrhea), *Escherichia coli* (which causes food poisoning), *Candida albicans* (which causes yeast infection), *Streptococcus mutans* (which causes dental caries), *Clostridium difficile* (which causes antibiotic associated diarrhea), *Cryptosporium parvum* (which causes food poisoning), and *Helicobacter pylori*

(which causes ulcer, gastritis). Colostrum stimulates active immune system by enhancing the activity of natural killer cells and phagocytes. The colostrum powder is manufactured by drying process to insure activity. Milk protein concentrate prepared from the milk of hyperimmunized cows is now commercially available, and is claimed to relieve joint pains of arthritis by complementing the body's naturally occurring antiinflammatory substances.

Lactoferrin has a role in nonspecific defense of the host against invading pathogens. It is active against several Gram-positive and Gram-negative bacteria, yeasts, fungi, and viruses. Its iron-binding characteristic aids in enhancing iron absorption. It stimulates and protects cells involved in host defense mechanism. Furthermore, it controls cytokine response.

Lactoperoxidase is an enzyme that breaks down hydrogen peroxide and exerts an antibacterial effect. Therefore, it is considered to be a natural preservative. It is being incorporated in toothpastes to prevent cavities. Another suggested use of lactoperoxidase is to control the acid development in stored yogurt known as postacidification. Lysozyme has antimicrobial activity against Gram-positive bacteria and it acts by lysis of cell walls. Bifidobacteria flora of colon imparts health-promoting properties and healthy gut ecology to the host.

Fermented milks are enhanced functional foods because of the fact that they contain nutrients of milk,

**Table 20.4.** Minimum Requirements of Various Proteins (g/kg body weight) in Humans

Protein	Requirement
Lactalbumin	0.480
Potato	0.512
Potato, 30% + Lactalbumin, 70%	0.374
Cow's milk	0.568
Casein	0.699
Wheat flour	0.892

Adapted from Schaafsma and Steijns, 2000.

**Table 20.5.** Milk Constituents with Putative Physiological Effects

Component	Health Effect
Butyric acid	Reduce colon cancer risk
CLA (Conjugated linoleic acid)	Modulate immune function, reduce risk of cancer (stomach, colon, breast and prostate)
Sphingolipids	May reduce risk of colon cancer
Stearic acid	May modulate blood lipids to reduce risk of cardiovascular and heart disease
Triglycerides	May enhance long-chain fatty acid and calcium absorption
Whey proteins	May modulate immune system, reduce risk of heart disease and cancer, lower blood pressure
Glycomacropeptide	Prevent dental caries, gingivitis, antiviral, antibacterial, bifidogenic
Immunoglobulins	Antibodies against diarrhea and GI tract disturbances
Lactoferrin	Toxin binding, antibacterial, immune modulating, anticarcinogenic, antioxidant, iron absorption
Lactoperoxidase	Antimicrobial
Lysozyme	Antimicrobial, synergistic with immunoglobulins and lactoferrin
Lactose	Calcium absorption
Calcium	Prevent osteoporosis and cancer, control hypertension

Adapted from: Chandan, 1999; Hoolihan, 2004.

as well products of metabolic activities of starter microorganisms in the product. Furthermore, they contain live and active cultures in significant numbers to effect physiological benefits to the consumer.

In general, yogurt contains more protein, calcium, and other nutrients than milk, reflecting the extra solids-not-fat content. Bacterial mass content and the products of the lactic fermentation further distinguish

**Table 20.6.** Some Functional Properties of Major Milk Proteins and Bioactive Peptides Derived From Them

Protein	Function
Caseins-	Precursors of bioactive peptides, iron carrier (Ca, Fe, Zn, Cu)
Casomorphins from $\alpha$ - and $\beta$ -caseins	
Casoxins from $\kappa$ -casein	Opioid agonists
Casokinins from $\alpha$ - and $\beta$ -caseins	Opioid agonists
Casoplatelins from $\kappa$ -casein and transferrin	Antihypertensive
Casocidin from $\alpha$ - and $\beta$ -caseins	Antithrombotic
Isracidin from $\alpha$ -casein	
Immuno-peptides from $\alpha$ - and $\beta$ -caseins	Antimicrobial
Phosphopeptides from $\alpha$ - and $\beta$ -caseins	Antimicrobial
Glycomacropeptide from $\kappa$ -casein	Immunostimulants
	Mineral carriers
	Antistress effects
$\alpha$ -Lactalbumin	Ca carrier, Lactose synthesis in mammary gland,
$\alpha$ -Lactorphin	antocarcinogenic and immunomodulatory effects
	Opioid agonists
$\beta$ -Lactoglobulin	Possible antioxidant, retinol carrier, fatty acid binding
$\beta$ -Lactorphin	Opioid agonists
Immunoglobulins A, M and G	Protection of immune system, provide antibodies
Lactoferrin from Lactoferrin	Opioid agonists

Adapted from: Saxelin et al., 2003; Aimutis, 2004.



yogurt from milk. Fat content is standardized to commensurate with consumer demand for low-fat to fat-free foods.

### BIOACTIVE PEPTIDES

Functional peptides are generated during digestive processes in the body and during the fermentation processes used in fermented dairy foods. They arise from casein as well as from whey proteins (Table 20.6). These peptides are inactive in the native proteins but assume activity after they are released from them. They contain 3 to 64 amino acids and largely display a hydrophobic character and are resistant to hydrolysis in the gastrointestinal tract. They can be absorbed in their intact form to exert various physiological effects locally in the gut or may have a systemic effect after entry into circulatory system. Casomorphins and lactophorins derived from milk proteins are known to be opioid agonists, whereas lactoferroxins and casooxins act as opioid antagonists. The opioids have analgesic properties similar to aspirin. Casokinins are antihypertensive (lower blood pressure), casoplatelins are antithrombotic (reduce blood clotting), immunopeptides are immunostimulants (enhance immune properties), and phosphopeptides are mineral carriers.

Casein phosphopeptides may aid in bioavailability of calcium, phosphorus, and magnesium for optimum bone health. They may also be helpful in preventing dental caries. They may also have a role in secretion of entero-hormones and immune enhancement. The casein peptides also offer a promising role in regulating blood pressure. Conversion of angiotensin-I to angiotensin-II is inhibited by certain hydrolyzates of casein and whey proteins. Since Angiotensin-II raises blood pressure by constricting blood vessels, its inhibition causes lowering of blood pressure. This ACE inhibitory activity would therefore make dairy foods a natural functional food for controlling hypertension. A commercial ingredient derived by the hydrolysis of milk protein, has an anxiolytic bioactive peptide with antistress effects. Psychometric tests and measurement of specific hormonal markers have displayed their antistress effect. The ingredient may be incorporated in milk, cheese, or ice cream.

The glycomacropeptide released from  $\kappa$ -casein as result of proteolysis may be involved in regulating digestion, as well as in modulating platelet function and thrombosis in a beneficial way. It is reported to suppress appetite by stimulating CCK hormone. Consequently, it may be a significant ingredient of satiety diets designed for weight reduction. Furthermore,

this peptide may inhibit binding of toxin in the gastrointestinal tract.

Some miscellaneous bioactive factors are being discovered. Specific proteins for binding Vitamin B<sub>12</sub>, folic acid, and riboflavin may assist in enhancing bioavailability from milk and other foods. Fat globule membrane protein called butyrophilin is a part of the immune system. Other growth factors in milk may help gut repair after radiation or chemotherapy.

### LACTOSE

Lactose, the milk sugar stimulates the absorption of calcium and magnesium. It has a relatively lower glycemic index as compared to glucose or sucrose, hence making it suitable for diabetics. It is less cariogenic than other sugars. Lactose stimulates bifidobacteria in the colon and thereby prevents infection and improves intestinal health.

Lactose absorption in humans is catalyzed by the enzyme lactase or  $\beta$ -D-galactosidase. Lactase is a nonpersistent enzyme in certain individuals, resulting in distressing symptoms of bloating, flatulence, and diarrhea following milk intake. Most individuals can tolerate two cups of milk spread over a day or with meals. In case of lactose malabsorption, the symptoms are ameliorated by using lactase tablets or by consuming yogurt. Yogurt and some fermented milks containing live and active cultures furnish the enzyme lactase to assist in digesting lactose. Lactose-reduced milk and ice cream products are also available.

Heated milk contains up to 0.2% lactulose, a lactose derivative. Since lactulose is not a digestible ingredient, it acts somewhat like a soluble fiber. Lactulose is generally used for treatment of constipation and chronic encephalopathy. Some recent data indicates that lactulose may enhance calcium absorption in the intestine.

### MILK FAT

Several positive findings have emerged for the consumption of milk fat. Milk fat exists in an emulsion form in milk making it highly digestible. Also, milk fat contains 10% short and medium chain fatty acids. Their 1:3 positions in the glyceride molecule allow gastric lipase with specificity for these positions to predigest them in the stomach itself. Butyric acid, a characteristic fatty acid of milk fat, is absorbed in the stomach and small intestine and provides energy similar to carbohydrates. Medium chain fatty acids are transported to the liver for rapid source of energy. The fatty acids lower the pH for facilitating

protein digestion. At the same time, acid barrier for pathogenic activity is enhanced. Free fatty acids and monoglycerides are surface tension lowering agents, thereby exerting an antiinfective effect.

The flavor of milk fat is unique and it adds to mouth-feel of foods comprised of milk and dairy foods. Milk fat is a concentrated form of energy. Fat protects organs and insulates body from environmental temperature effects. It carries vitamins A, D, E, and K and supplies essential fatty acids including arachidonic acid, linolenic acid, omega 3-linoleic, eicosapentaenoic acid, and docosahexaenoic acid. The essential fatty acids cannot be synthesized by the body and must be supplied by our diet. The omega-3 fatty acids have a role in memory development and maintenance.

Conjugated linoleic acids (CLA) are a class of fatty acids found in animal products such as milk and yogurt. Rumen flora synthesizes CLA, which has been demonstrated to exhibit potent physiological properties. CLA is a strong antioxidant constituent of milk fat, and may prevent colon cancer and breast cancer. CLA has been shown to enhance immune response. Prostaglandin PGE-2 promotes inflammation, artery constriction, and blood clotting. CLA may reduce the risk of heart disease by reducing the levels of prostaglandin PGE-2. Studies have indicated that CLA may increase bone density, reduce chronic inflammation, and normalize blood glucose levels by increasing insulin sensitivity.

Another constituent of milk fat is sphingolipids. They occur at a level of only 160  $\mu\text{g}/\text{kg}$ . Recent studies show that they are hydrolyzed in the gastrointestinal tract to ceramides and sphingoid bases, which help in cell regulation and function. Studies on experimental animal show that sphingolipids inhibit colon cancer, reduce serum cholesterol, and elevate the good cholesterol HDL. They could protect against bacterial toxins and infections as well.

Butyric acid is liberated from milk fat by lipase in the stomach and small intestine. It may exert beneficial effect on the gastric and intestinal mucosa cells. In the colon, butyric acid is formed by fermentation of carbohydrates by the resident microbiota. Butyric acid in that location works as a substrate for colon cells and confers anticancer properties.

## MINERALS AND VITAMINS

Milk and dairy products are, in general, an excellent source of calcium, phosphorus, and magnesium in diet. High levels of these minerals are in optimum

ratio for bone growth and maintenance. As a food source, milk offers good bioavailability of minerals and vitamins. To prevent osteoporosis, continued consumption of milk is cited as important by leading experts in nutrition and medical science. Other functions of calcium involve regulation of blood pressure and prevention of colon cancer.

The fat-soluble vitamins A, D, E, K and water-soluble vitamins are well known for their beneficial role in human nutrition. Milk is a good source of B-vitamins.

## PROBIOTICS

Detailed discussion on probiotics is given in Chapter 22. Probiotics may be defined as a food or supplement containing concentrates of defined strains of living microorganisms that on ingestion in certain doses exert health benefits beyond inherent basic nutrition. They are believed to contribute to the well-being of the consumer by improving the host's microbial balance in the gastrointestinal tract. This definition stresses upon the importance of ingestion of several hundred millions of live and active microbial culture. Recent advances in probiotic research show much promise in new product development of functional foods based on milk (Sanders, 1994, Chandan, 1999, Shah, 2001). There has been marked proliferation in the number of probiotic products in the market. Probiotics and associated ingredients might add an attractive dimension to cultured dairy foods for effecting special functional attributes.

Milk is an excellent medium to carry or generate live and active cultured dairy products. They add an attractive dimension to cultured dairy products for augmenting current demand for functional foods. The buffering action of the milk proteins keeps the probiotics active during their transit through the gastrointestinal tract. Other potential carriers are fruit juices, candies, ice cream, and cheese. In general, worldwide consumption of fermented milk products has increased due to their high nutritional profile, unique flavor, desirable texture, and remarkable safety against food-borne illness. Concomitantly, it translates to a sizeable enhancement in milk utilization and the intake of valuable nutrients contained therein. Addition of fruit preparations including fruit flavors and fruit purees has enhanced the versatility of flavor, texture, color, and variety of yogurt containing probiotics. Incorporation of nuts, grains, and chocolate syrups gives the fermented milk novel and multiple textures and flavors to attract its use as a

snack, breakfast food, or as a dessert item. Probiotic mixtures are also exclusively sold either in the form of powders, capsules, or tablets and labeled in the market as natural organic foods/supplements.

### BENEFICIAL MICROFLORA

Cultures associated with health benefits are yogurt bacteria (*Streptococcus thermophilus* and *Lactobacillus delbrueckii* spp. *bulgaricus*), other lactobacilli, and bifidobacteria (Nakazawa and Hosono, 1992; Salminen et al., 1998). Table 20.7 gives a list of various probiotics being used in commercial fermented milks.

Yogurt organisms possess a distinctly high lactase activity, making it easily digestible by individuals with a lactose-maldigestion condition. To bolster probiotic function, most commercial yogurt is now supplemented with *Lactobacillus acidophilus* and *Bifidobacterium* spp.

The probiotic preparations are also available in the form of tablets, powder, or capsules. They contain

**Table 20.7.** Probiotic and Beneficial Microorganisms in Commercial Products

---

<i>Lactobacillus acidophilus</i> group:
<i>Lactobacillus acidophilus</i>
<i>Lactobacillus johnsoni</i> LA1
<i>Lactobacillus gasseri</i> ADH
<i>Lactobacillus crispatus</i>
<i>Lactobacillus casei/paracasei</i>
<i>Lactobacillus casei</i> subsp. <i>Rhamnosus</i>
<i>Lactobacillus reuteri</i>
<i>Lactobacillus brevis</i>
<i>Lactobacillus delbrueckii</i> subsp. <i>bulgaricus</i>
<i>Lactobacillus fermentum</i>
<i>Lactobacillus helveticus</i>
<i>Lactobacillus plantarum</i>
<i>Bifidobacterium adolescentis</i>
<i>Bifidobacterium animalis</i>
<i>Bifidobacterium bifidum</i>
<i>Bifidobacterium breve</i>
<i>Bifidobacterium infantis</i>
<i>Bifidobacterium longum</i>
<i>Streptococcus thermophilus</i>
<i>Enterococcus faecium</i>
<i>Pediococcus acidilactici</i>
<i>Saccharomyces boulardii</i>

---

Adapted from: Chandan, 2004; Shah, 2001, 2004; Saxelin et al., 2003.

organisms from the genera *Lactobacillus*, *Enterobacter*, *Streptococcus*, and *Bifidobacterium*. These genera are important members of the gastrointestinal microflora and are all relatively beneficial. The strains of lactic acid bacteria used in probiotics are mostly intestinal isolates such as *Lb. acidophilus*, *Lb. casei*, *Enterococcus faecium*, and *Bifidobacterium bifidum*.

Yogurt starter bacteria, *Lb. delbrueckii* ssp. *bulgaricus* and *Streptococcus thermophilus*, are also included as probiotics in this table because yogurt has been associated with several health benefits in the past. They are now reported to persist and remain viable throughout the gastrointestinal tract of rats and humans. For sustained benefit, it is necessary to ingest them on continuous basis. Even with intestinal isolates such as *Lb. acidophilus*, it is necessary to dose regularly rather than to assume that a few doses will allow the organisms to colonize the gut permanently. Currently even *Bacillus laterosporus* and *Bacillus sphaericus* and other little-known probiotics are fortified with enzymes, antiinflammatory compounds, specific amino acids, colostrum, and chelated minerals in probiotic preparations. *Lb. acidophilus* and *Bifidobacterium bifidum* strains are known to differ widely in their ability to grow in the presence of bile salts (Gilliland, 2003). Both are reported to be stable at various concentrations of bile salts.

### HEALTH BENEFITS OF PROBIOTIC PRODUCTS

Health benefits of probiotics are enumerated in Table 20.8.

The belief in the beneficial effects of the probiotic approach is based on the knowledge that the intestinal microflora provides protection against various diseases. Probiotics have been with us for as long as people have eaten fermented milks but their association with health benefits dates only from the turn of the century when Metchnikoff drew attention to the adverse effects of the gut microflora on the host and suggested that ingestion of fermented milks ameliorated the so-called autointoxication (Metchnikoff, 1908). It has been shown that germ-free animals are more susceptible to disease than their conventional counterparts who carry a complete gut flora. This difference has been shown for infections caused by *Salmonella enteritidis* and *Clostridium botulinum*. Another source of evidence that supports the protective effect of the gut flora is the finding that antibiotic treated animals, including humans can become

**Table 20.8.** Health Effects of Probiotics

Effects Corroborated by Scientific Evidence	Effects of Potential Nature
Assisting lactose digestion	Controlling candida and bacterial infections (vaginitis)
Treatment of rotaviral diarrhea	Alleviating constipation
Treatment of infant gastroenteritis	Antimutagenic/anticarcinogenic effects
Treatment of antibiotic related diarrhea	Lowering cholesterol and blood pressure
Modulating intestinal (microbiota) ecology	Alleviation of microbial overpopulation in small intestine
Reducing harmful fecal enzymes, biomarkers of cancer initiation	Alleviation of dermatitis and skin allergies
Enhancing/modulating immune system	Prevention and treatment of Crohn disease
Positive effects on cervical and bladder cancer	Treatment of <i>Clostridium difficile</i> diarrhea

Adapted from: Fonden et al., 2003; Shah, 2001, 2004.

more susceptible to disease (Saavedra, 1995). In humans pseudomembranous colitis, a disease caused by *Clostridium difficile*, is almost always a consequence of antibiotic treatment (Shah, 2004).

The third source of the supporting evidence comes from experiments in which dosing with fecal suspensions has been shown to prevent infection (Schwan and Sjolín, 1984). In humans it has been shown that *C. difficile* infection can be reversed by administering fecal enemas derived from a healthy human adult. Probiotics also deplete the essential nutrients for the pathogenic organisms thus eliminating their growth.

Figure 20.2 illustrates how yogurt and cultured dairy products might exert functional benefits to the consumer (Chandan, 1999).

### REQUIREMENTS FOR EFFECTIVE PROBIOTICS

Criteria for live and active cultures have been established by the industry with a view to maintain the integrity of refrigerated and frozen yogurts. In addition, the probiotics must implant and multiply rapidly in the gut to avoid them from being expunged entirely. They must not only be able to tolerate and pass through the high acidity (low pH) of stomach, but also be able to grow and proliferate at physiological levels of bile salts and adhere to the intestinal epithelial cells. Bile salts produced by the gall bladder are essential in helping to emulsify fat before it can be digested in the intestine. Probiotics that can colonize should also be resistant to several antibiotics and producer of bacteriocin as natural antimicrobial substances. A *Bifidobacterium* strain should be negative

for the production of catalase, nitrate reductase, urease, and for the formation of indole. In addition, liquefaction of gelatin, gas formation from glucose, response to rhamnose, sorbose, glycerol, erythritol, adinotol, and dulcitol should be negative. Commercial probiotic strains must have verified safety of use in human diet. They should possess stability to acid and bile, and exhibit colonization and adherence in the GI tract.

### PRODUCTION OF ENZYMES, VITAMINS, AND BACTERIOCINS

Other beneficial effect of probiotics includes the improvement of lactose utilization in large proportion of the world's population who are unable to effectively digest lactose. The enzyme lactase responsible for lactose digestion, although present in the suckling infant, disappears after weaning. In areas of the world where milk is not a staple food, lack of enzyme causes no problems. However, if people from these regions migrate to Europe or North America, problems arise because ingestion of lactose in some form is difficult to avoid. Lactose malabsorption refers to incomplete digestion of lactose resulting in a flat or low rise in blood sugar following ingestion of lactose in a clinical lactose intolerance test. The disaccharide lactose is hydrolyzed to glucose and galactose by lactase and subsequently absorbed in the small intestine. Lactase is a constitutive, membrane-bound enzyme located in the brush borders of the epithelial cells of the small intestine. The intact residual lactose left over following impaired lactase activity enters the colon where it is fermented by inherent microflora to generate organic acids, carbon dioxide,

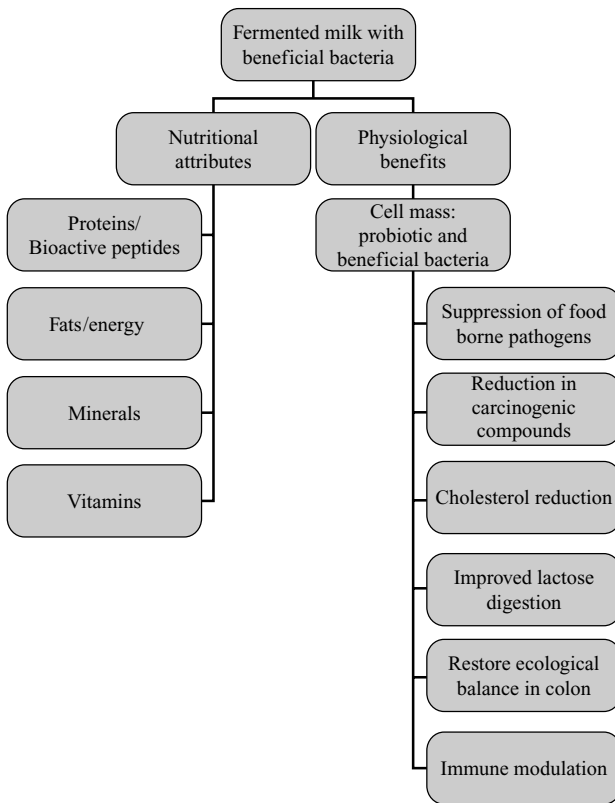

**Figure 20.2.** Potential mode of health attributes of yogurt and fermented milks.

methane, and hydrogen. The fermentation products together with the osmotically driven excessive water drawn into the colon are primarily responsible for abdominal pain, bloating, cramps, diarrhea, and flatulence. These symptoms are associated with lactose maldigestion when lactose is not fully digested in the small intestine. It has been known for some time that lactose deficient subjects tolerate lactose in yogurt better than the same amount of lactose in milk. It is possible to show increased lactase activity in the small intestine of humans that have been fed yogurt.

Probiotics also produce some of the B-vitamins including niacin, pyridoxine, folic acid, and biotin. Probiotics produce antibacterial substances, which have antimicrobial properties against disease-causing bacteria. Acidophilin produced by *Lb. acidophilus* is reported to inactivate 50% of 27 different disease-causing bacteria. Children with Salmonella poisoning and Shigella infections were cleared of all

symptoms using *Lb. acidophilus*. *Bifidobacterium bifidum* effectively kills or controls *Escherichia coli*, *Staph. aureus* and *Shigella*. Acidophilus is also reported to control viruses such as herpes.

### BIOAVAILABILITY OF CALCIUM

One of the primary functions of calcium is to provide strength and structural properties to bone and teeth. The major source of dietary calcium is dairy products, supplying 75% of the intake. Milk and dairy products are excellent sources of bioavailable calcium. Addition of lactic acid to unfermented yogurt, as well as regular fermented yogurt displays an improved bone mineralization as compared to the unfermented yogurt. It is postulated that the acidic pH due to added lactic acid or naturally contained in fermented yogurt converts colloidal calcium to its ionic form and allows its transport to the mucosal cells of the intestine. (Fernandes et al., 1992).

### REDUCTION IN SERUM CHOLESTEROL

Probiotics effectively help to reduce cholesterol levels circulating in blood. Some studies have indicated a modest lowering of serum cholesterol in subjects consuming milk fermented with *Lb. acidophilus*, *Lb. rhamnosus GG* and yogurt cultures.

### PREVENTION OF DIARRHEA, VAGINITIS AND DERMATITIS

Probiotics improve the efficiency of the digestive tract especially when bowel function is poor. Establishment of probiotics in the GI tract may provide prophylactic and therapeutic benefits against intestinal infections. Probiotics may have a role in circumventing traveler's diarrhea (Fernandes et al., 1992; Elmer et al., 1996). Yogurt supplemented with probiotic organisms reduces the duration of certain types of diarrhea. Fermented milk with probiotics has been recommended to replace milk during the treatment of diarrhea because it is tolerated well than milk. A double blind study has shown that only 7% of infants receiving probiotic formula containing *Bifidobacterium bifidum* and *Streptococcus thermophilus* develop diarrhea against 31% incidence in placebo group (Saavedra et al., 1994). The vaginal microflora changes drastically during bacterial infection. Bacteria of genera *Escherichia*, *Proteus*, *Klebsiella*, and *Pseudomonas* along with yeast, *Candida albican* are recognized as etiological agents in urinary tract infection among adult women. It has been shown that the normal urethral, vaginal, and cervical flora of healthy females can competitively block the attachment of uropathogenic bacteria to the surfaces of uroepithelial cells. Lactobacilli strains supplemented in the diet or directly applied are reported to coat the uroepithelial wall and prevent the adherence of uropathogens. Milk fermented with yogurt cultures and *Lactobacillus casei* influences the intestinal microflora of infants (Guerrin-Danan et al., 1998).

### ANTICARCINOGENESIS

Bifidobacteria and lactobacilli, especially *Lb. acidophilus* have been shown to have powerful anticarcinogenic features, which are active against certain tumors (Goldin and Gorbach, 1992). An epidemiological study reported a positive correlation between consumption of probiotic and prevention of colon cancer. Several reports suggest prevention of cancer

initiation by various probiotics by reducing fecal procarcinogenic enzymes nitroreductase and azoreductase (Lee et al., 1996).

### IMMUNOMODULATORY ROLE

An interesting development in recent years has been the finding that lactobacilli administered by mouth can stimulate macrophage activity against several different species of bacteria (Brassart and Schiffrin, 1997, Rangavajhyala et al. 1997. For example, *Lb. casei* given to mice increased phagocytic activity. Lactobacilli injected intravenously are reported to survive in the liver, spleen, and lungs and enhance the natural killer cell activity.

Probiotics have been reported to be useful in the treatment of acne, psoriasis, eczema, allergies, migraine, gout, rheumatic and arthritic conditions, cystitis, candidiasis, colitis and irritable bowel syndrome, and some forms of cancer. Recent reports suggest that *Lb. acidophilus* may be able to inhibit HIV, the virus that causes AIDS. It is reported that certain strains of *Lb. acidophilus* (and certain species of *Enterococcus*) produce large amounts of hydrogen peroxide. Hydrogen peroxide alone, or in combination with certain minerals or dietary components, can arrest the growth of HIV. More research in this area is needed to make a definitive validation of these claims.

Potential mechanisms by which probiotics may exert their beneficial effects are (a), competition with other microflora for nutrients, (b) production of acids inhibitory to certain enteropathogens, (c) production of bacteriocins or inhibitory metabolites, (d) immunomodulation, and (e) competition for adhesion to intestinal mucosa.

Since efficacy of a probiotic is directly related to the number of live and active cells consumed, it is important to specify potency or colony forming units (cfu) of the culture per unit weight or volume of the product. In addition, the culture should be active in terms of growth potential (Chandan, 1999).

### MANUFACTURE OF PROBIOTICS FOR USE AS FOOD SUPPLEMENTS

Various probiotic strains are screened for their effectiveness and formulated for stability during shelf life of the product. In general, the process of probiotic manufacture involves growing of probiotic cultures by a process involving growth in a well-defined nutrient medium. In the manufacturing process, the

microorganisms are concentrated first by removing unspent liquid medium by sedimentation, ultrafiltration, reverse osmosis, and/or centrifugation. Cryoprotectant is added before freezing to prevent “freezer damage” to the bacteria. Following freezing, the mass is freeze-dried. The final product is then subjected to fine screening and quality control involving several tests. When the product passes all the rigorous tests, it is then mixed with excipient to standardize the specific desired count (most commonly > 10 billion CFU/gram). Following that a natural stabilizer is added to prevent the loss of its viability during packaging, shipping, storage, marketing, and consumption. The viability of the cells should not be damaged during the manufacturing and freeze-drying process. The cultures that can be used alone or in combination include *Lactobacillus acidophilus*, *Lb. brevis*, *Lb. delbrueckii ssp. bulgaricus*, *Lb. casei*, *Lb. casei ssp. rhanmosus*, *Lb. helveticus*, *Lb. lactis*, *Lb. plantarum*, *Lb. reuteri*, *Lb. salivarius*, *Bifidobacterium bifidum*, *B. breve*, *B. infantis*, *B. longum*, *Enterococcus faecium*, *Str. thermophilus*, and *Pedicoccus cerevesiae*.

Supplementation of probiotics with prebiotics can be a very effective functional food (Shah, 2001). For example, prebiotic fructooligosaccharide (FOS) is exclusively used by a few strains of *Bifidobacterium bifidum* and *Lb. acidophilus*. Thus a combination of FOS along with these cultures will induce the proliferation of these cultures in preference to other microflora in the gastrointestinal tract. This combination is termed as synbiotics. Prebiotic consumption is reported to increase the levels of bifidobacteria in human volunteers at the expense of less desirable bacterial species. Additionally, prebiotic supplements have been shown to improve the absorption of calcium and

magnesium in animal models, and this may be of importance for humans as well.

## FORTIFICATION

Traditionally, milk has been fortified with vitamins A and D. Now, popular ingredients of functional significance are being incorporated to enhance the market value of dairy foods and dairy-based foods. Some of these ingredients designed to enhance consumer appeal are: (a) calcium, claimed to prevent osteoporosis and cancer, and control hypertension; (b) antioxidants (vitamins C and E), claimed to prevent cancer, cardiovascular disease, and cataracts. In addition, dietary fiber (psyllium, guar gum, gum acacia, oat fiber, soy components) as well as multivitamin-mineral mixes are being incorporated in fat-free milk to provide targeted niche consumers meal replacements. Such products supply a substantial proportion of daily essential nutrients. In addition to infant formula line of products based on fat-free milk, there is a proliferation of energy and weight-reduction shake drinks for consumer segments ranging from adults to geriatric populations. More recently, the food industry has leveraged this area to develop and market a number of drinks and powders targeted to consumers interested in weight reduction, meal replacement, and supplementing their diet with wellness foods (Table 20.9). Antioxidants have shown promise, but fortification strategy must include an understanding of their impact on flavor, texture, mouth feel, and shelf life of the product. Also, it is imperative to know a meaningful dose-benefit relationship associated with the specific fortified dairy food.

Another ingredient of interest is docosahexaenoic acid (DHA). They are long chain polyunsaturated

**Table 20.9.** Various Milk-Based Product Categories Containing Milk Fractions

Category	Food or Supplement
Clinical nutrition	Total enteral formulas containing casein, milk proteins and their hydrolyzates for tube or oral administration in hospitalized patients
Health foods or Sports nutrition	Drinks, tablets, energy bars or cookies can deliver easily absorbable protein hydrolyzates, bioactive peptides and bioavailable milk minerals; Glutamine peptide supports immune system and facilitates iron absorption
Infant nutrition	DeminerIALIZED whey, lactose, caseinates, milk protein concentrate, and dairy minerals are constituents of hypoantigenic and hypoallergenic humanized infant formulas
Weight-reduction drinks	Meal replacement milk shakes fortified with such supplements as milk proteins, vitamins and minerals, prebiotics

fatty acids from fish oils and marine algae. They are claimed to exert cancer inhibition, antiallergy effects, and improvement in learning ability. DHA-fortified drinks are targeted at school children in some countries.

## PHYSIOLOGICALLY ACTIVE INGREDIENTS

Another possible opportunity to develop functional foods is to leverage the use of inherent milk constituents of known physiological attributes. Commercially available milk fractions are being used in a variety of milk-based products (Table 20.9).

Besides milk fractions inherently present in normal milk, a new class of oral therapeutic preparations is being developed. They constitute a new class of bovine antibodies or immunoglobulins. They comprise of antibodies from colostrum of cows. They are designed to attack infections in the GI tract of humans. They are consumed orally to provide passive immunotherapy. Regular bovine colostrum contains antibodies against many human pathogens such as *Escherichia coli*, *Staphylococcus aureus*, *Staphylococcus epidermidis*, *Streptococcus pyogenes*, *Streptococcus faecalis*, *Streptococcus viridans*, *Candida albicans*, *Salmonella typhimurium*, *Proteus vulgaris*, *Klebsiella pneumoniae*, and *Pseudomonas aeruginosa*. Cows are cost effective bioreactors producing about 500 g of antibodies in the first 4 days of parturition. During the dry period, pregnant cows are immunized against specific antigens derived from human pathogens. Postpartum milk is collected for 4 days and harvested for immunoglobulins, followed by formulation for site-specific delivery. Polyclonal antibodies contained in the immunoglobulin formulations may bind multiple target sites.

Application of engineered immunoglobulins (Gregory, 1997) to milk as such or in association with cultures may be another innovative approach to design a product with a distinctive appeal to certain segment of consumers. Certain preparation may contain specific immunoglobulins to combat some conditions.

## REFERENCES

- Aimutis WR. 2004. Bioactive properties of milk proteins with particular focus on anticarcinogenesis. *J. Nutr.* 134:4S, 989S–995S.
- Brassart D, Schiffrin EJ. 1997. The uses of probiotics to reinforce mucosal defence mechanisms. *Trends Food Sci. Technol.* 8:321–326.
- Chandan RC. 1999. Enhancing market value of milk by adding cultures. *J. Dairy Sci.* 82:2245–2256.
- Chandan RC. 2004. Yogurt. In: JS Smith, YH Hui (Eds), *Food Processing*, Blackwell Publishing, Ames, IA, pp. 297–318.
- Elmer GW, Surawicz CM, McFarland LV. 1996. Biotherapeutic agents—A neglected modality for the treatment and prevention of selected intestinal and vaginal infections. *JAMA*, 275:870–876.
- Fernandes CF, Chandan RC, Shahani KM. 1992. Fermented dairy products and health. In: BJB Wood (Ed), *The Lactic Acid Bacteria*, Vol. 1. Elsevier, New York, pp. 279–339.
- Fonden R, Saarela M, Matto J, Mattila-Sandholm T. 2003. Lactic acid bacteria in functional dairy products. In: T Mattils-Sandholm, M Saarela (Eds), *Functional Dairy Products*. CRC Press, Boca Raton, FL, p. 251.
- Gilliland SE. 2003. Probiotics. *Encyclopedia of Food Sciences and Nutrition*, Vol. 8, Academic Press, London, pp. 4792–4798.
- Goldberg I (Ed). 1994. *Functional Foods, Designer Foods, Pharmafoods, Nutraceuticals*. Chapman & Hall, New York.
- Goldin BR, Gorbach SL. 1992. Probiotics for humans. In: R Fuller (Ed). *Probiotics—The Scientific Basis*. Chapman and Hall, New York, pp. 355–376.
- Gregory AG. 1997. Method for microfiltration of milk or colostrum whey. US Patent no. 5,670,196.
- Guerrin-Danan C, Chabanet C, Pedone C, Popot F, Vaissade P, Bouley C, Szyliet O, Andrieux C. 1998. Milk fermented with yogurt cultures and *Lactobacillus casei* compared with yogurt and gelled milk: Influence on intestinal microflora in healthy infants. *Am. J. Clin. Nutr.* 67:111–117.
- Hoolihan L. 2004. Beyond Calcium. The protective attributes of dairy products and their constituents. *Nutrition Today* 39(2, March–April): 69–77.
- Hutch PJ, Layman DK, Brown PH. (Eds). 2004. The emerging role of dairy products and bioactive peptides in nutrition and health. *J. Nutr.* 134(4S):961S–1002S.
- Lee H, Rangavajhyala N, Gradjean G, Shahani KM. 1996. Anticarcinogenic effect of *Lactobacillus acidophilus* on N-nitrosobis(2-oxopropyl) amine induced colon tumor in rats. *J. App. Nutr.* 48: 59–66.
- Mattila-Sandholm T, Saarela M. 2003. *Functional Dairy Products*. CRC Press, Boca Raton, FL.
- Metchnikoff E. 1908. The prolongation of life. In: PC Mitchell (Ed), G.P. Putnam's Sons, The Knickerbocker Press, New York & London.
- Nakazawa Y, Hosono A. 1992. *Functions of Fermented Milk—Challenges for the Health Services*. Elsevier, New York.



- Rangavajhyala N, Shahani KM, Sridevi G, Srikumaran S. 1997. Nonlipopolysaccharide component(s) of *Lactobacillus acidophilus* stimulates the production of interleukin-1 $\alpha$  and tumor necrosis factor- $\alpha$  by murine macrophages. *Nutrition and Cancer* 28:130–134.
- Saavedra JM. 1995. Microbes to fight Microbes: A not so novel approach to controlling diarrheal disease. *J. Pediatr. Gastroenterol.* 21:125–129.
- Saavedra JM, Bauman NA, Oung I, Perman JA, Yolken RH. 1994. Feeding of *Bifidobacterium bifidum* and *Streptococcus thermophilus* to infants in hospital for prevention of diarrhea and shedding of rotavirus. *Lancet*, 344:1046–1049.
- Salminen S, Deighton MA, Benno Y, Gorbach SL. 1998. Lactic acid bacteria in health and disease. In: S Salminen, A von Wright (Eds), *Lactic Acid Bacteria*, Marcel Dekker, New York, pp. 211–253.
- Sanders ME. 1994. Lactic acid bacteria as promoters of human health. In: I Goldberg (Ed), *Functional Foods (Designer Foods, Pharmafoods, Nutraceuticals)*. Chapman and Hall, New York, pp. 295–322.
- Saxelin M, Korpela R, Mayra-Makinen A. 2003. Introduction: classifying functional dairy products. In: T Mattils-Sandholm, M Saarela (Eds), *Functional Dairy Products*. CRC Press, Boca Raton, FL, p. 6.
- Schaafsma G, Steijns JM. 2000. Dairy ingredients as a source of functional foods. In: MK Schmidl, TP Labuza (Eds), *Essentials of Functional Foods*. Aspen Publishers, Gaithersburg, MD.
- Schwan A, Sjolín S. 1984. *Clostridium difficile* enterocolitis cured by rectal infusion of normal faeces. *Scand. J. Infect. Diseases* 16:211–215.
- Shah NP. 2001. Functional foods from probiotics and prebiotics. *Food Technol.* 55(11):46–53.
- Shah NP. 2004. Probiotics and prebiotics. *Agro Food Industry HiTech.* 15(1):13–16.
- U.S. Department of Agriculture (USDA). October 2002. *Nutritive Value of Foods*, USDA, Washington, DC, pp. 22–23.

# 21

## Health Benefits of Yogurt and Fermented Milks

*Nagendra P. Shah*

- Introduction
- Yogurt and Other Fermented Milks
- Cultured Buttermilk
- Cultured Cream
- Fermented Milks of Eastern Europe
- Fermented Milks of Asia
- Nordic (Scandinavian) Fermented Milks
- Fermented Milks from the Middle East
- Health Benefits of Fermented Milks
  - Nutritional Value of Fermented Milks
  - Nutritional Function
- Physiological Effects
  - Antimicrobial Activity and Gastrointestinal Infections
  - Anticancer Effects
  - Reduction in Serum Cholesterol
  - Immune System Stimulation
- Health Benefits of Nordic Fermented Milks
  - Health Effects of Kefir
  - Health Benefits of Bio-Yogurt
- References

### INTRODUCTION

Although there are no records available to trace the origin of yogurt and other fermented milks, it is believed that fermentation was the first technique employed by humans for preservation of milk. Fermented milks are reported to have originated in the Middle East before the Phoenician era. The traditional Egyptian fermented milks, Laban Rayeb, and Laban Khad, were consumed in Egypt as early as 7000 BC. Ancient Turkish people in Asia, where they lived as nomads, are believed to have made yogurt first. The first Turkish name appeared in the eighth century as 'yoghurut.' According to the Persian tradition, Abraham owed his longevity to yogurt consumption (Prajapati and Nair, 2003). Emperor

Francis I of France was cured of debilitating illness by yogurt. Another legend tells that yogurt originated from the Balkans. Peasants of Thrace made soured milks, known as 'Prokish' from sheep milk. Asia contributed to the early spread of fermented milks by the Tartars, Huns, and Mongols in their invasions of Russia and European areas. South East Asia including Persia (or Iran), Iraq, Syria, and Turkey still remains a key area for production and consumption of fermented milk. Fermented milk is also a traditional food in the Balkans. Its popularity has now spread to Europe and many other parts of the world. The word 'yogurt' was derived from the Turkish word 'Jugurt' and Table 21.1 shows the synonyms for yogurt or yogurt-related fermented milks known in different countries.

A major factor in the evolution of fermented product is that the Middle East area has a subtropical climate and the temperature may reach around 40°C. This is the ideal temperature for the growth of starter bacteria and milk turned sour and coagulated rapidly. However, the souring of milk was not a uniform process as there was no control over the starter bacteria in fermentation of milk. This gave rise to insipid product, with irregular coagulum filled with air (Kosikowski and Mistry, 1997).

Fermented milk plays an important role in the diets of some European communities, particularly in Bulgaria. Today, fermented milk is manufactured in many countries around the world.

Yogurt has played an important role in human nutrition. The fermented milk products vary considerably in composition, flavor and texture, depending on the nature of fermenting organisms, the type of milk, and the manufacturing process used.

**Table 21.1.** Yogurt and Yogurt-Like Products as Known in Various Countries of the World

Traditional Name	Country	Traditional Name	Country
Jugurt/Eyran	Turkey	Tiaourti	Greece
Busa	Turkestan	Cieddu	Italy
Kissel Mleka	Balkans	Mezzoradu	Sicily
Urgotnic	Balkan mountains	Gioddu	Sardinia
Leben/Leban	Lebanon and some Arab countries	Filmjolk/Fillbunke/ Filbunk/Surmelk/ Taettem-jolk/Tettemelk	Scandinavia
Zabady	Egypt and Sudan	Tarho	Hungary
Mast/Dough	Iran and Afghanistan	Viili	Finland
Roba	Iraq	Skyr	Iceland
Dahi/Dadhi/ Dahee	India, Bangladesh, Nepal	Yogurt/Yogurt/ Yaort	Rest of the world
Mazun/Matzoon	Armenia	Yourt/Yaourti/ Yahourth/ Yogur/Yaghourt	("Y" is replaced by "J" in some instances)
Katyk	Transcaucasia		

Source: Tamime and Deeth, 1980; Kosikowski and Mistry, 1997.

Although yogurt has many desirable properties, it is still prone to deterioration. The containers traditionally used by nomads were made from animal skins. Because of whey evaporation through the skin, the solids content and lactic acid concentration rose. This gave rise to concentrated or condensed yogurt. Such type of product was manufactured in Armenia, where mazun (Armenian yogurt) is processed to yield concentrated yogurt. Another method of concentration of yogurt was by placing the product in an earthenware vessel. Evaporation through pores of earthenware vessels helped increase solids content and lactic acid concentration. This practice also kept the product cool and is still practiced in some parts of India and Nepal. Nevertheless, the condensed yogurt had a limited keeping quality and salting was carried out to extend the keeping quality. Different types of concentrated yogurt containing various quantities of salt are made in Turkey. Sun drying of salted product was another means of extending the keeping quality further. Dried yogurt balls are stored in glass jars and covered in olive oil. In some countries including Turkey, Lebanon, Iraq, and Iran, rubbing of wheat flour to dried yogurt is carried out to increase the keeping quality to almost indefinite period. This product is known as "kishk." As refrigeration became widespread, a variety of new generation of yogurts emerged and the interest in traditional products declined.

At the beginning of this century, Nobel Laureate Elie Metchnikoff at the Pasteur Institute in Paris was the first to propose a scientific rationale for the beneficial effects of bacteria in yogurt. In his treatise 'The

Prolongation of Life', he hypothesized that yogurt bacteria, *Lactobacillus delbrueckii* ssp. *bulgaricus* and *Streptococcus thermophilus*, control infections caused by enteric pathogens and regulate toxemia, both of which play a major role in ageing and mortality. He linked health and longevity of Bulgarian peasants to their high consumption of fermented milks, particularly yogurt. Later, it was found that yogurt starter is unable to implant in the intestine. Moro in 1900 isolated *Lb. acidophilus* from feces of infants. Hence, focus was given to *Lb. acidophilus* as a more suitable organism for therapeutic properties. This observation provided a major boost to manufacture and consumption of yogurt (Prajapati and Nair, 2003).

The first commercial production of yogurt in Europe was undertaken by Danone in 1922 in Madrid, Spain. There was a rapid advancement in the technology of yogurt and understanding of its properties since 1950.

## YOGURT AND OTHER FERMENTED MILKS

Yogurt is defined as "a product resulting from milk by fermentation with a mixed starter culture consisting of *Str. thermophilus* and *Lb. delbrueckii* ssp. *bulgaricus*." However, in some countries including Australia other suitable lactic acid bacteria in addition to yogurt starter (*Str. thermophilus* and *Lb. delbrueckii* ssp. *bulgaricus*) are permitted for use as starter cultures. As a result, some yogurt manufacturers use *Lactobacillus helveticus* and *Lactobacillus jugurti* for

manufacturing yogurt. Similarly, yogurt in Australia can be made with ABT starter cultures, which include *Str. thermophilus*, *Lactobacillus acidophilus*, and *Bifidobacterium* spp. In ABT starter cultures, *Str. thermophilus* is the main fermenting organism. The first US Federal Standards of Identity for yogurt were published in 1981. The US standard allows the use of other culture organisms as long as *Lb. delbrueckii* ssp. *bulgaricus* and *Str. thermophilus* are used for making yogurt and the titratable acidity, expressed as lactic acid, and must be at least 0.9%. The titratable acidity requirement and some other provisions of the standard have been stayed and are in limbo for many years. Manufacture of yogurt is discussed in details in Chapter 13.

Recent advances have been supplementation of yogurt starter with probiotic organisms such as *Lb. acidophilus* and *Bifidobacterium* spp. to increase the therapeutic value of the product and use of exopolysaccharide producing starter cultures to improve textural characteristics of yogurt.

Bulgarian buttermilk is a high acid product made by fermenting pasteurized (85°C/30 minutes) milk with *Lb. delbrueckii* ssp. *bulgaricus* at 42°C for 10–12 hours. The product is very tart as it contains about

1.4% titratable acidity. This fermented milk is popular in Bulgaria.

## CULTURED BUTTERMILK

Cultured buttermilk is low-acid fermented milk fermented primarily by mesophilic cultures including *Lactococcus lactis* ssp. *lactis* and *Lc. lactis* ssp. *cremoris* as well diacetyl-producing organisms as shown in Table 21.2.

*Lc. lactis* ssp. *lactis* and *Lc. lactis* ssp. *cremoris* are acid producers, while *Lc. lactis* ssp. *lactis* biovar *diacetylactis* and *Leuconostoc mesenteroides* ssp. *cremoris* produce flavor and aroma compounds such as diacetyl. For production of cultured buttermilk, pasteurized milk (85°C for 30 minutes) is fermented at 22°C with starter microorganisms until a titratable acidity of 0.9% is reached. Incubation at higher temperatures favors the growth of *Lc. lactis* ssp. *cremoris* and *Lc. lactis* ssp. *lactis* leading to high acid product, which limit the aroma production by *Lc. lactis* ssp. *lactis* biovar *diacetylactis* and *Leu. mesenteroides* ssp. *cremoris*. The product has a shelf life of 10 days at 5°C.

**Table 21.2.** Some Fermented Milks and Their Starter Cultures

Product	Starter Organisms
Butter milk (Bulgarian)	<i>Lactobacillus delbrueckii</i> ssp. <i>bulgaricus</i>
Butter milk (cultured)	<i>Lactococcus lactis</i> ssp. <i>lactis</i> biovar <i>diacetylactis</i> , <i>Leuconostoc mesenteroides</i> ssp. <i>cremoris</i>
Cultured cream	<i>Lc. lactis</i> ssp. <i>lactis</i> , <i>Lc. lactis</i> ssp. <i>cremoris</i> , <i>Lc. lactis</i> ssp. <i>lactis</i> biovar <i>diacetylactis</i> , and <i>Leu. mesenteroides</i> ssp. <i>cremoris</i>
Dahi	<i>Lb. delbrueckii</i> ssp. <i>bulgaricus</i> , <i>Streptococcus thermophilus</i> or <i>Lc. lactis</i> ssp. <i>lactis</i> , <i>Lc. lactis</i> ssp. <i>cremoris</i> , <i>Lc. lactis</i> ssp. <i>lactis</i> biovar <i>diacetylactis</i> , and <i>Leu. mesenteroides</i> ssp. <i>cremoris</i>
Filjolk	<i>Lc. lactis</i> ssp. <i>lactis</i> , <i>Lc. lactis</i> ssp. <i>cremoris</i> , <i>Lc. lactis</i> ssp. <i>lactis</i> biovar <i>diacetylactis</i>
Kefir	<i>Lc. lactis</i> ssp. <i>lactis</i> , <i>Lc. lactis</i> ssp. <i>cremoris</i> , <i>Lc. lactis</i> ssp. <i>lactis</i> biovar <i>diacetylactis</i> , and <i>Leu. mesenteroides</i> ssp. <i>dextranicum</i> , <i>Str. thermophilus</i> , <i>Lb. delbrueckii</i> ssp. <i>bulgaricus</i> , <i>Lb. acidophilus</i> , <i>Lb. helveticus</i> , <i>Lb. kefir</i> , <i>Lb. kefiranofaciens</i> , <i>Kluyveromyces marxianus</i> , <i>Sacchamycetes</i> spp.
Kumys	<i>Lb. acidophilus</i> , <i>Lb. delbrueckii</i> ssp. <i>bulgaricus</i> , <i>Sacchamycetes lactis</i> , <i>Torula koumiss</i>
Tatmjolk	<i>Lc. lactis</i> ssp. <i>lactis</i> , <i>Lc. lactis</i> ssp. <i>cremoris</i> , <i>Lc. lactis</i> ssp. <i>lactis</i> biovar <i>diacetylactis</i>
Viilli	<i>Lc. lactis</i> ssp. <i>lactis</i> , <i>Lc. lactis</i> ssp. <i>cremoris</i> , <i>Lc. lactis</i> ssp. <i>lactis</i> biovar <i>diacetylactis</i> , <i>Geotrichum candidum</i>
Yakult	<i>Lb. paracasei</i> ssp. <i>casei</i>
Yogurt	<i>Lb. delbrueckii</i> ssp. <i>bulgaricus</i> , <i>Str. thermophilus</i>

Source: Lee and Wong, 1993.

## CULTURED CREAM

Cultured cream, also known as sour cream, is low-acid fermented milk with similar flavor as buttermilk. The product contains 18% fat. The same starter culture and incubation temperature are used as cultured buttermilk.

## FERMENTED MILKS OF EASTERN EUROPE

Kefir is a refreshing drink of northern slope of Caucasian mountains of China. Since early times, people who lived in the mountains learnt to make kefir. Kefir grains are used as starter cultures. Legend tells that kefir was given to orthodox people by Prophet Mohammad. Prophet Mohammad kept the secret of kefir to himself from the outside world; otherwise the so-called magic strength could be lost. Kefir was traditionally made in skin bags. Natural fermentation took place in skin bags under sunlight. The finished product contained substantial amount of lactic acid, alcohol, and carbon dioxide. The sacks were filled with fresh milk and the process repeated (IDF, 1984; Koroleva, 1988). Russian doctors recommended kefir for treatment of intestinal and stomach diseases. The first scientific literature about kefir appeared at the end of eighteenth century.

Kefir is a product made by fermenting milk with acid and alcohol-fermenting organisms. Kefir grains are complex consortium of about 30 species of bacteria and yeasts. The microorganisms are embedded in the matrices made up of polysaccharides. The polysaccharide, known as kefiran, is produced by *Lactobacillus kefiranofaciens*. The product contains 0.9–1.1% lactic acid, 0.3 to 1% alcohol and 1% carbon dioxide. The product is very popular in Eastern Europe (IDF, 1984). The microorganisms associated with kefir grains, which are equivalent to starter cultures in other fermented milks, are shown in Table 21.2. Incubation is carried out at 18–22°C for approximately 20 hours.

Kumys is another fermented milk of Eastern Europe. The product is described in the section below.

## FERMENTED MILKS OF ASIA

Dahi is a popular fermented milk in India, Africa, Central Europe, analogous to the western yogurt. In India, Nepal, and other Asian countries, dahi is still made in every household in villages as well as in urban areas using traditional method (Prajapati and Nair, 2003). The product is typically made from pas-

teurized or boiled milk, inoculated with dahi as starter left over from the previous day. Incubation is carried out in a warm place usually overnight. The organisms used as starter cultures are shown in Table 21.2.

The product is claimed to have good nutritional and health properties, which make the product very popular. Dahi has been used in India since Vedic times. Lord Krishna (c 5000 BC) had been depicted with eating dahi, buttermilk, and ghee. Ayurveda, the traditional Indian medicine, mentions health properties of dahi including its role in controlling gastrointestinal disorders. Dahi is used as a part of daily diet in India and is eaten along with rice and other main meals.

Kumys (also known as kumiss) is traditionally prepared from mare milk and is popular in Eastern Europe and Asiatic regions. The name kumiss is reported to be named after a tribe called Kumanes in the Asiatic Steppes. Scythian tribes, which roamed from place to place in South East Asia and Middle Asia, were reported to drink kumiss made from mare's milk some 2500 years ago (Koroleva, 1988). Kumys has been mentioned by Marco Polo as being a pleasant drink. The finished product had high acidity and varying amount of alcohol and carbon dioxide. It was consumed as a food as well as weak alcoholic drink.

Kumys is fermented milk that contains lactic acid (0.6–1.0%) and alcohol (0.7–2.5%). The main organisms involved in fermentation are *Lb. delbrueckii* ssp. *bulgaricus* and *Lb. lactis* ssp. *lactis* and lactose-fermenting yeasts, e.g., *Saccharomyces lactis* or *Torula* spp. Carbon dioxide is produced by the yeast. The milk is not heat treated, hence a high level of starter culture (30%) is used. The incubation is carried out at 26–28°C and depending on the fermentation time the product may contain 0.6% lactic acid and 0.2% alcohol, 0.8% lactic acid and 1.5% alcohol, or 1.0% lactic acid and 2.5% alcohol.

Yakult is a popular fermented milk in Japan. The product is made with *Lb. paracasei* ssp. *paracasei* strain Shirota. The product contains low milk solids (3.7%) and high levels of sugar (14%).

Dadiah is a popular fermented milk of Indonesia. The product is equivalent to Indian Dahi and is made by natural fermentation of raw buffalo milk at 28–30°C. *Lb. casei* ssp. *casei*, *Leuconostoc mesenteroides* and *Lc. lactis* ssp. *lactis* biovar *diacetylactis* are usually involved in the fermentation.

## NORDIC (SCANDINAVIAN) FERMENTED MILKS

Nordic fermented milks are made from encapsulated EPS producing lactococci, primarily *L. lactis* ssp.

*cremoris*. The products are characterized by high viscosity and ropiness and if one lifts the product with a spoon, long strings will appear. An example of such type of product is “langfil” also known as “tاتمjolk,” a popular product in Sweden. Similar fermented milk marketed in Norway is “tettetmelk.” Filmjolk is sour milk popular in Sweden.

Viili is popular fermented milk of Finland. The product is made primarily with the help of *Lc. lactis* ssp. *lactis* biovar *diacetylactis* and *Leuconostoc mesenteroides* ssp. *cremoris* and lactose fermenting mold *Geotrichum candidum*. The cream layer is usually covered with the mold and the product is eaten with a spoon. Pasteurized milk is fermented at approximately 20°C until a final acidity of 0.9% is reached.

Ymer is Danish fermented milk made from fermentation of ultrafiltered milk retentate (usually 15% solids). The starter cultures used for cultured buttermilk are also used for ymer. Lactofil is a similar product as ymer and is popular in Sweden. Starter culture used for ymer is similar to cultured buttermilk.

Skyr is produced from skim milk and is popular in Iceland. *Lb. delbrueckii* ssp. *bulgaricus* and *Lb. casei* are used as a starter culture. The product is concentrated by separating the whey using a cheese-cloth.

Probiotic fermented milks contain various species of probiotic organisms, particularly *Lb. acidophilus*, *Bifidobacterium* spp. and *Lb. casei*. *Lb. delbrueckii* ssp. *bulgaricus* and *Str. thermophilus* do not survive in the gastrointestinal tract. Since probiotic organisms grow slowly in milk, the trend is to use *Lb. delbrueckii* ssp. *bulgaricus* and *Str. thermophilus* as the primary starter culture and probiotic organisms as adjunct organisms. With this approach, the fermentation time could be short. Some examples of fermented milks containing probiotics include “Bioghurt,” “Biogarde,” and “Bifighurt.” These products are popular in Germany. A similar product popular in Denmark is known as “Cultura.” This product contains *Lb. acidophilus* and *Bifidobacterium bifidum*.

## FERMENTED MILKS FROM THE MIDDLE EAST

Fermented milks in the Middle East are classified based on the total solids content of the product. Fermented milks with similar solids content as milk include zabady, laban rayeb, and laban kad. Concentrated fermented milks containing 20–40% solids include labneh and laban zeer. Dried fermented milks include kishk (Kurmann, and Rasic, 1988).

Zabady is traditionally made by boiling buffalo milk followed by inoculation with previous day’s product as a starter culture. The product is made in uncovered containers and postprocessing contamination with yeasts and molds is very common. As a result, the product has a limited shelf life. Organisms commonly found in zabady include *Str. thermophilus*, and *Lb. delbrueckii* ssp. *bulgaricus*. However, *Bacillus subtilis*, *Alcaligenes* spp. and *Micrococcus* spp. are also found as contaminants.

Laban rayeb is an indigenous product of Egypt. This product is made in households by milking animals in earthenware pots and keeping undisturbed until fermented by natural microflora of milk.

Laban kad is traditionally made in goatskin bags by fermentation with natural flora of milk. The organisms isolated from this product include *Lc. lactis* ssp. *lactis*, *Leu. mesenteroides* ssp. *dextranicum*, *Leu. mesenteroides* ssp. *cremoris* and *Lb. casei*.

Gariss is an indigenous fermented milk of Sudan. The product is made from camel’s milk by natural fermentation of milk in leather bags. *Lactobacillus helveticus*, *Lb. delbrueckii* ssp. *lactis* and yeasts such as *Candida* spp. and *Kluveromyces* spp. are usually involved in fermentation.

Labneh is a popular product of Lebanon and Syria. The product is made as full cream zabady (equivalent to yogurt) followed by draining of whey using a cheese-cloth. Laban zeer is a traditional product of Egypt. Fermented buttermilk (laban kad) obtained from churning of naturally fermented cream is stored in earthenware jar (known as “zeer”). The increase in solids is due to evaporation of moisture through porous pot. Organisms isolated from the product include *Bacillus* spp. and *Lactobacillus* spp. *Saccharomyces* and yeast is also found.

Table 21.2 shows the important fermented milks and starter cultures used in production of these products. Table 21.3 shows the origins of some important fermented milks.

## HEALTH BENEFITS OF FERMENTED MILKS

### NUTRITIONAL VALUE OF FERMENTED MILKS

Health effects are divided into two groups: nutritional function and physiological function. The nutritional attribute is expressed as the function of supplying nutrition sufficiently. The physiological function refers to prophylactic and therapeutic functions beyond

**Table 21.3.** Origins of Some Important Fermented Milk Products

Product	Country of Origin	Period	Characteristics
Airan	Central Asia, Bulgaria	1253–1255 AD	Milk soured by <i>Lb. bulagicus</i> and used as refreshing beverages
Bulgarian milk	Bulgaria	500 AD	Very sour milk fermented by <i>Lact. bulgaricus</i>
Dahi	India	800–300 BC	Milk soured by using previous day soured milk as starter
Kefir	Caucasian China	–	Milk fermented with kefir grains containing lactobacilli and yeast. Lactic acid, alcohol, and CO <sub>2</sub> give sparkling characteristics
Kishk	Egypt, Arab world		Fermented milk mixed with par boiled wheat and dried
Kumys or Kumiss	Central Asia Mongol, Russia	400 BC	Mare milk is fermented by lactobacilli and yeast. Lactic acid, alcohol, and CO <sub>2</sub> give sparkling characteristics
Laban	Egypt	5000–3000 BC	Soured milk coagulated in earthenware utensils
Langfil or Tattemjolk	Sweden		Milk fermented with slime producing lactococci
Leben	Iraq	3000 BC	Milk soured with yogurt bacteria and whey is partially drained by hanging the curd in clothes
Mast	Iran		Natural yogurt with firm consistency and cooked flavor
Skyr	Iceland	870 AD	Fermented milk made from ewe milk with the help of rennet and starter
Taette	Norway	–	Viscous fermented milk
Trahana	Greece	–	Fermented milk made by mixing wheat flour followed by drying
Viili	Finland	–	Viscous milk fermented with lactic acid bacteria and mold
Yakult	Japan	1935 AD	Highly heat-treated milk fermented by <i>L. casei</i> Shirota strain
Ymer	Denmark	–	Protein fortified milk fermented with leuconostocs and lactococci
Yogurt or yoghurt	Turkey	800 AD	Custard-like sour fermented milk

Source: Prajapati and Nair, 2003.

nutritional function. Potential nutritional and health benefits of fermented foods are listed in Table 21.4.

### NUTRITIONAL FUNCTION

Milk is a complete food for newborn mammals. It is the sole food during the early stages of rapid development. Milk contains well-balanced macronutrients including carbohydrate, fat, and protein. Milk contains approximately 5% lactose, 3% protein, 4% fat, and 0.7% minerals used for mammalian growth

and development. Milk is also a good source of micronutrients including calcium, phosphorus, magnesium, and zinc. Milk proteins have high nutritive value due to the favorable balance of essential amino acids (Buttriss, 1997). Milk proteins are deficient only in sulfur-containing amino acids such as cysteine and methionine. Milk also contains antimicrobial substances, which provide protection against infection in neonates. The most important characteristics of human milk as compared with cow's milk are its low protein, low ash, and high lactose contents.

**Table 21.4.** Potential Nutritional and Health Benefits of Fermented Foods

Beneficial Effect	Possible Causes and Mechanisms
Improved digestibility	Partial breakdown of proteins, fats and carbohydrates
Improved nutritional value	Higher levels of B-vitamins and certain free amino acids, viz. methionine, lysine and tryptophan
Improved lactose utilization	Reduced lactose in product and further availability of lactase
Antagonistic action toward enteric pathogens	Disorders such as diarrhoea, mucous colitis, ulcerated colitis; prevention of adhesion of pathogens
Anticarcinogenic effect	Reduction of carcinogen-promoting enzymes; inhibitory action toward cancers of the gastrointestinal tract by degradation of precarcinogens; stimulation of the immune system
Hypocholesterolemic action	Production of inhibitors of cholesterol synthesis; use of cholesterol by assimilation and precipitation with deconjugated bile salts
Immune modulation	Enhancement of macrophage formation; stimulation of production of suppressor cells and $\gamma$ -interferon

Source: Gomes and Malcata, 1999.

Nutritionally fermented milks have a similar composition to that of the unfermented counterpart from which it is made. However, the composition can be modified by addition of other ingredients such as non-fat dry milk, whey powder, fruit, and sugar. Bacterial fermentation results in lowering of lactose and increased level of lactic acid. Fortification with milk solids also results in increased protein and lactose contents, although, some lactose is converted to lactic acid.

### Lactose

Lactose is considered as an excellent food for babies and has a favorable effect in the intestinal tract. Lactose requires longer time for digestion; this provides a suitable medium for beneficial probiotic bacteria including *Lb. acidophilus* and bifidobacteria, which in effect dominate the putrefactive bacteria and minimize the production of gas by them. The beneficial effect of lactose on the absorption of calcium is well established.

Lactose stimulates gastrointestinal activity. Lactose increases the capacity of the body to utilize phosphorus and calcium. Polysaccharides such as cellulose (e.g., carboxy methyl cellulose) are generally added to yogurt mix as a stabilizer and many of these polysaccharides are considered as "bifidus factor" and may prevent constipation by providing bulk.

Lactic acid acts as a preservative by reducing pH, which inhibits the growth of potentially spoilage and harmful bacteria. Lactic acid also influences physical properties of casein curd to induce a finer suspension, which appears to promote digestibility.

During fermentation, lactic acid bacteria convert 20–30% of lactose into lactic acid. Consequently, the lactose levels in fermented milks can be lower than milk. Fermented milks with lower lactose content are better tolerated by lactose intolerant individuals. Yogurt in general is supplemented with 2–4% skim milk powder, so the protein and sugar contents are usually higher than cow's milk. Even after fermentation, the product may contain 4–5 g of lactose per 100 g of the product (Deeth and Tamime, 1981). Nevertheless, yogurts fortified with skim milk powder and containing higher levels of lactose also appear to be tolerated by lactose malabsorbers (Gurr, 1987).

### Milk Proteins

Milk protein is considered to be of high nutritional value in terms of its biological value, net protein utilization, and protein efficiency ratio. The proteins in milk are of excellent quality as caseins and whey proteins ( $\alpha$ -lactalbumin and  $\beta$ -lactoglobulin) contain high levels of essential amino acids. Protein content of fermented milks such as yogurt is often increased due to supplementation with skim milk solids (typically, 2–3%). This means that it is an even more attractive source of protein than its liquid counterpart. The levels of soluble proteins, nonprotein nitrogen and free amino acids are higher in yogurt as a result of heat treatment to milk and breakdown of casein by starter bacteria. Lactic acid bacteria require amino acids for their growth; they break down milk proteins due to their proteolytic activity.

Protein in fermented milks is reported to be totally digestible. Fermented milks are more digestible



than milk due to proteolytic activity of starter bacteria resulting in higher levels of peptides and amino acids (IDF, 1991). Feeding of yogurt resulted in increased weight gains and increased feed efficiency in rats compared to that of milk from which it is prepared. The substance promoting body weight gain was found to be of MW  $\geq$  20,000, possibly related to the cells of *Str. thermophilus*. Thus, it can be assumed that yogurt made with *Str. thermophilus* will have a growth promoting effect, possibly due to enhanced bio-availability of minerals, in particular iron. This indicates a higher protein value of fermented products compared to unfermented milk. Consumption of 250 g of fermented milks per day can serve an individual with the minimum daily requirement of animal protein, which is reported to be 15 g (IDF, 1991).

Milk is heat treated (typically 85°C for 30 min) for making most fermented milks. This results in soft curd when milk proteins are coagulated by the acid produced by yogurt starter bacteria. Milks with softer curds resulting from such high heat treatment show more human milk like characteristics and are more digestible as a substitute for mother's milk than harder curds. Further, the more open nature of the casein aggregates allows the proteolytic enzymes of gastrointestinal tract freer access during digestion. The soft curd does not give rise to any feeling of discomfort; this is very important in children. The curd formed from milk in the stomach of the young by the action of chymosin and pepsin is less accessible to subsequent enzymatic digestion.

The digestibility of milk protein is the highest (>90%) among proteins. This may be due to decrease in protein particle size and an increase in soluble nitrogen, nonprotein nitrogen and free amino acids during heat processing of milk and proteolysis by starter bacteria. In general, yogurt has been found to be more digestible than milk.

### Milk Fat

Milk fat is highly digestible. Lactic acid in fermented milks has been found to promote peristaltic movement, which improves overall digestion and absorption of food. Traditional yogurt contains 3–4% fat. Concentrated yogurt (labneh) or yogurt from sheep milk may contain 7–8% fat. The recent trend is to produce yogurt from skim milk. The overall energy (calorie) content of yogurt reflects both the fat content of the milk from which it was made and the supplementation of ingredients such as cream or sugar. Milk

fat improves consistency and mouthfeel of the product. Milk fat has highest value as an energy source with each gram of fat providing 9 kcal. Milk fat supplies essential fatty acid including linoleic and linolenic acid and fat-soluble vitamins such as vitamin A, carotene, vitamin D, E, and K. Choline, a constituent of phospholipid, promotes the oxidation of lipids in the liver and acts to maintain an equilibrium cholesterol concentration (Deeth and Tamime, 1981). Yogurt is reported to produce hypocholesterolaemic effects.

### Enhancement in Absorption of Vitamins and Minerals.

Milk contains more calcium than other foods. Similarly, absorption of calcium is better from milks than from other forms. The mineral content is hardly altered during fermentation; however, reports suggest that the utilization of Ca, P, and iron in the body is better for fermented milks than that of milk. One possible reason could be phospho-peptides released by the hydrolysis of casein that accelerate absorption. Animal studies on the amount of calcium in bone and bone weight and strength suggested that lactic acid was involved. These observations suggest that calcium absorption from fermented milk is better than unfermented counterpart. The utilization of Ca and P in the body is known to improve in the presence of lactose and vitamin D. Calcium is required for bone metabolism and prevention of osteoporosis. Yogurts contain appreciable quantity of sodium and potassium and thus may not be suitable for feeding babies less than 6 months, unless these minerals are reduced prior to yogurt manufacturing.

Fermented milks are an excellent source of vitamin B<sub>2</sub> and also a good source of vitamin A, vitamins B<sub>1</sub>, B<sub>6</sub>, B<sub>12</sub>, and pantothenic acid. The level of fat-soluble vitamins, particularly vitamin A, is dependent on the fat content of the product. Some lactic bacteria are able to synthesize the B vitamin folic acid (Reddy et al., 1976). Vitamin content of yogurt in general is higher as starter bacteria synthesize certain B group vitamins during fermentation. Levels of some B vitamins, particularly vitamin B<sub>12</sub>, are reduced due to requirement of some lactic acid bacteria for this vitamin.

The fortification of fermented milks with vitamins A and C is possible and losses over 2 weeks in storage are likely to exceed 50%. However, the majority of vitamin C is lost by heat treatment (Bourliouix and Pochart, 1988). Similarly, vitamin B<sub>12</sub> is reported to be undetectable after storage for 5 days. Low-fat

yogurt is popular in many developed countries; hence fortification with vitamin A should be encouraged.

**Alleviation of Lactose Malabsorption.** The average lactose content in yogurt mix is 8.5%, which decreases in yogurt to approximately 5.75% after fermentation. About 25–30% of lactose is converted to lactic acid during fermentation. Lactose content in other fermented milks varies depending on fortification and breakdown of lactose by starter bacteria.

Lactose malabsorbers often complain of “gastric distress” after consuming fresh, unfermented milk or milk products. Lactose malabsorption is a condition in which lactose, the principal carbohydrate of milk, is not completely hydrolyzed into its component monosaccharides, glucose, and galactose. Since lactose is cleaved into its constituent monosaccharides with the help of lactase or  $\beta$ -D-galactosidase enzyme, lactose malabsorption results from a deficiency of this enzyme. Lactase deficiency is a common problem in many parts of the world. The prevalence of lactose malabsorption varies depending on the ethnic origin of the population. Infants in general have higher lactase activity than adults. Prevalence of lactose malabsorption is common in China, Thailand, Japan, and Africa and Australian aborigines, but less common among Caucasians. Temporary deficiency of  $\beta$ -galactosidase occurs in people suffering from diarrhea. The unabsorbed lactose reaches colon, where it is fermented by colonic flora to volatile fatty acids, lactic acid,  $\text{CO}_2$ ,  $\text{H}_2$ , and  $\text{CH}_4$ . The unhydrolyzed lactose withdraws water and electrolytes from duodenum and jejunum. The lactase deficient people can suffer from bloat, flatulence, abdominal pain, and diarrhea (Shah, 1993).

Fermented milks, in particular yogurt appears to be well tolerated by lactose malabsorbers and lactose malabsorbers suffer fewer symptoms with fermented dairy foods. Reduced levels of lactose in fermented products are due to partial hydrolysis of lactose during fermentation and is partly responsible for greater tolerance of yogurt. Factors other than the presence of yogurt starter are responsible for better tolerance of lactose in lactose maldigesters from fermented dairy foods. At least three factors appear to be responsible for better tolerance of lactose from yogurt including (a) yogurt bacteria, (b) lactase enzyme or  $\beta$ -galactosidase elaborated by these bacteria, and most importantly (c) oro-caecal transit time. The traditional cultures used in making yogurt (i.e., *Lb. delbrueckii* ssp. *bulgaricus* and *Str. thermophilus*)

contain substantial quantities of  $\beta$ -D-galactosidase, and it has been suggested that the consumption of yogurt containing cultures with high levels of lactase may assist in alleviating the symptoms of lactose malabsorption. Bacterial enzyme is reported to auto-digest lactose intracellularly before reaching the intestine (Savaiano et al., 1984). Auto-digestion of lactose intracellularly by bacterial  $\beta$ -galactosidase before reaching the intestine is an important factor that improves digestibility of lactose. The organisms are lysed in the presence of bile salts and the released lactase causes hydrolysis of ingested lactose. The action of bile increases the cellular permeability of yogurt bacteria allowing the release of intracellular  $\beta$ -galactosidase activity. Hence, the amount of lactose reaching the colon is too small to cause lactose malabsorption. Yogurt also has buffering effect and due to this the organisms reach the duodenum and the  $\beta$ -galactosidase activity is not inactivated.  $\beta$ -Galactosidase is destroyed *in vitro* at pH below 3.0, but buffering capacity of yogurt is able to keep the pH above 3.0 (Onwulata et al., 1989).

Slower gastric emptying of semisolid fermented milk products such as yogurt is another factor responsible for better absorption of lactose. Delayed gastric emptying is responsible for hydrolysis of lactose by indigenous  $\beta$ -galactosidase located in the sides and tips of the villi of the jejunum and by bacterial  $\beta$ -galactosidase. Viscous foods such as yogurt or foods with higher solids are reported to delay gastric emptying and are effective in alleviating lactose intolerant symptoms (Shah et al., 1992). As a result, fermented milk containing live culture and  $\beta$ -galactosidase is better tolerated than unfermented milk. As coagulated milk, because of its viscous nature, passes more slowly through the gut than unfermented milk. Regular yogurt appears to be more effective than either pasteurized yogurt or buttermilk. Pasteurized yogurt, in which starter bacteria and enzyme activity are destroyed due to heat treatment, is also tolerated well due to slower gastric emptying (Shah et al., 1992).

Yogurt bacteria hydrolyze lactose into glucose and galactose with the help of  $\beta$ -galactosidase. Glucose is used directly as a source of energy by the organisms. There is often accumulation of free galactose in yogurts. A part of the galactose is converted to glucose in the liver. Some of the galactose is used for synthesis of brain cerebroside and nerve tissues. Galactose was reported to cause cataracts of eyes in rats (Goodenough and Kleyn, 1976). However, the diet in rats was composed entirely of yogurt. No such effect

has been reported in humans possibly due to: (i) better metabolism of galactose, (ii) lack of the enzyme responsible for metabolism of galactose in rats, and (iii) yogurt is only a small part of the human diet.

Two types of lactic acid, L (+) and D (–), are produced during fermentation. *Lb. delbrueckii* ssp. *bulgaricus* produces only D (–) lactic acid, whereas *Str. thermophilus* produces L (+) lactic acid. D (–) lactic acid is not metabolised to pyruvic acid in the body because of lack of D2-hydroxy acid dehydrogenase and this results in metabolic acidosis in neonatal infants. The concentration of L (+) will vary with the ratio of *Str. thermophilus*, and *Lb. delbrueckii* ssp. *bulgaricus* and is usually approximately 50% of the total amount as the ratio of the two organisms in the product is usually 1 : 1. L (+) isomer is easily digested and is completely harmless. Both isomers are found to improve the digestibility of the casein and aid in retention of calcium in the intestine (Shah, 1999).

## PHYSIOLOGICAL EFFECTS

Many health benefits have been attributed to fermented milk products as listed in Tables 21.3. A considerable amount of evidence has been accumulated for some benefits such as improved lactose tolerance. Physiological benefits include antimicrobial activity and gastrointestinal infections, anticancer effects, reduction in serum cholesterol, and immune system stimulation (Holm, 2003).

### ANTIMICROBIAL ACTIVITY AND GASTROINTESTINAL INFECTIONS

The gastrointestinal tract has a large number of indigenous microflora. There is a balance between useful microorganisms and harmful microflora. This balance is affected by gastrointestinal illnesses, stress, and use of antibiotics leading to disturbances of its function. Fermented milks have been used to improve intestinal health since ancient times. This includes diarrhea caused by infection due to pathogenic bacteria. Fermented foods are reported to improve the composition and metabolic activity of intestinal microflora.

Starter bacteria used in fermented milks produce lactic acid, and bacteriocins as antimicrobial substances. These antimicrobial substances are produced to suppress the multiplication of pathogenic and putrefying bacteria. Lowering of pH due to lactic acid produced by starter bacteria during fermentation and in the gut has bactericidal or bacteriostatic effect. Many species of lactic acid bacteria also produce

H<sub>2</sub>O<sub>2</sub> as an antimicrobial substance. However, it is believed that lactic acid is the only antimicrobial agent of any importance. The low pH resulting from the production of lactic acid during the fermentation creates an undesirable environment for the growth of spoilage microorganisms (Shah, 2000).

Controversies have surrounded the efficacy of yogurt as a therapeutic agent. Reports suggest that *Lb. delbrueckii* ssp. *bulgaricus* do not survive gastric (acid) and intestine (bile salt) conditions. *Str. thermophilus* is susceptible to acidic conditions. However, *Lb. delbrueckii* ssp. *bulgaricus* is acid tolerant. Some reports suggest that yogurt bacteria can survive passage through the gastrointestinal tract. However, it is agreed that *Lb. delbrueckii* ssp. *bulgaricus* is unable to implant. Hence, it is unlikely that *Lb. delbrueckii* ssp. *bulgaricus* can be used for treating gastrointestinal disorders. Nonetheless, yogurt has been used in treating infantile diarrhea and normalization of gastrointestinal flora. The organism is also reported to increase the population of *Bifidobacterium* spp.

*Lb. delbrueckii* ssp. *bulgaricus* has been shown to produce several bacteriocin including “bulgarican,” which has shown broad spectrum antibacterial activity. Antimicrobial compounds isolated from skim milk cultures of *Lb. delbrueckii* ssp. *bulgaricus* and *Str. thermophilus* have shown activity against a range of organisms including Salmonella, Shigella, *E. coli*, and Pseudomonas (Dave and Shah, 1997).

Fermented milks have shown beneficial effects on intestinal health. Alleviation of infant diarrhea and antibiotic associated diarrhea due to consumption of fermented milks has been reported (Saavedra et al., 1994). Consumption of fermented milks has shown to increase the counts of bifidobacteria and decrease the levels of putrefactive compounds in feces. This is because of enhancement of intestinal immune function by lactic acid bacteria in fermented milks and antimicrobial substances produced during fermentation, which have shown improvement in intestinal microflora.

### ANTICANCER EFFECTS

Cancer is one of the main causes of death in western countries. Epidemiological studies suggest that cancer is caused by environmental factors, particularly diet. The consumption of cooked red meat especially barbecued meat and low consumption of fiber are reported to play a major role. Several factors responsible for causes of colorectal cancer including bacteria and metabolic products such as genotoxic

compounds (nitrosamine, heterocyclic amines, phenolic compounds, and ammonia). Many bacterial enzymes such as  $\beta$ -glucuronidase generate these carcinogenic products, except lactic acid bacteria and probiotics, such as *Lactobacilli* and *bifidobacteria*. Lactic acid bacteria and fermented products have potential anticarcinogenic activity. An inverse relationship between consumption of fermented dairy foods and the risk of colorectal cancer has been found. Lactic acid bacteria suppress bacterial enzymes, and reduce intestinal pH (Orrhage et al., 1994).

Several studies have shown that fermented dairy products or preparation containing lactic acid bacteria inhibit the growth of tumor cells in experimental animals. Animal studies using chemical carcinogen 1, 2-dimethyl hydrazine (DMH) have been carried out. Rats were given DMH to induce colon cancer and fed with fermented milks. DMH is activated in the large intestine by  $\beta$ -glucuronidase. Addition of *Lactobacillus* to the diet has been reported to delay tumor formation. The inhibitory effects of fermented milks on colon cancer are either because of the decrease of mutagenic activity or modification of intestinal microflora. Antimutagenic effects of milk fermented with *Lb. delbrueckii* ssp. *bulgaricus* and *Str. thermophilus* have been reported. Yogurt has been found to reduce the levels of bacterial enzymes,  $\beta$ -glucuronidase, azoreductase, and nitroreductase. These enzymes are believed to contribute to pathogenicity of bowel cancer as they catalyze conversion of procarcinogens to carcinogens (Lankaputhra and Shah, 1998; Goldin and Gorbach, 1977, 1984, Cenci et al., 2002).

Several types of fermented milks including yogurt, colostrum fermented with *Lb. delbrueckii* ssp. *bulgaricus*, *Str. thermophilus*, and *Lb. acidophilus* or milk fermented with *Lb. helveticus* are reported to suppress cancer cell growth. Studies have shown several compounds including supernatants of milk fermented by *Lb. delbrueckii* ssp. *bulgaricus*, cells of *Lb. delbrueckii* ssp. *bulgaricus*, *Str. thermophilus*, and *Lb. helveticus* ssp. *jugurti* in yogurt, exopolysaccharide in kefir have inhibitory effects on cancer cell growth.

Reddy et al. (1973) were the first to report the anticancer effect of yogurt in mice. Since then several studies have demonstrated that *Lb. delbrueckii* ssp. *bulgaricus*, and *Str. thermophilus* strains are able to slow down the evolution of tumors in mice. Antiproliferative effect of fermented milk on the growth of human breast cancer line has also been demonstrated. Only live bacteria appear to have anticancer effect.

Antitumor actions of yogurt are claimed to be due to the stimulation of the immune functions of the body, as well as improvement in intestinal microflora population. The anticarcinogenic effect of lactic acid bacteria is due to the result of removal of sources of procarcinogens or the enzymes, which lead to their formation. Short-chain fatty acids produced by lactic acid bacteria are reported to inhibit the generation of carcinogenic products by reducing enzyme activities. The other mechanism includes improvement in the balance of intestinal microflora, normalized intestinal permeability (prevention or delaying of toxin absorption), and strengthening of intestinal barrier mechanisms.

### REDUCTION IN SERUM CHOLESTEROL

There is a high correlation between dietary saturated fat or cholesterol intake and serum cholesterol level. Elevated levels of serum cholesterol, particularly LDL-cholesterol have been linked to an increased risk of cardiovascular disease, which is one of the main causes of death in developed countries. Cholesterol lowering properties of fermented milks were observed as early as 1960s among Masai tribes of East Africa. Mann and Sperry (1974) observed a decrease in serum cholesterol levels in men fed large quantities (8.33 L/man/day) of milk fermented with *Lactobacillus*. Those people had low-blood cholesterol levels although they consumed a large quantity of meat. Consumption of high quantity of yogurt was found to be responsible for lowering of serum cholesterol. Rabbits fed on a high cholesterol diet supplemented with yogurt showed lower cholesterol levels as compared to the diet supplemented with nonfermented milk. Cholesterol-lowering effects of yogurt have been reported in human volunteers. The subjects consumed 240 mL of yogurt three times per day.

The role of fermented milks in reducing the serum cholesterol is not completely understood. Cholesterol is an essential component of cell membrane and is required to produce certain hormones and bile acids. It is synthesized by the liver and from absorbed foods. The mechanism of controlling blood cholesterol level is complex. Metabolite of starter cultures in fermented milks is reported to produce hydroxymethyl-glutarate, which inhibits hydroxymethylglutaryl-CoA reductase, an enzyme required for the synthesis of cholesterol in the body. This could limit cholesterol synthesis. Calcium, orotic acid, lactose, and casein have been suggested as possible hypocholesterolemic factors.

*Lactobacillus* in fermented milks is reported to cause deconjugation of bile acid in the small intestine with consequent fecal excretion of bile acids and a lowering of the body sterol pool (Klaver and Meer, 1993).

Conjugate bile acids are reported to enhance absorption of cholesterol. Microorganisms also assimilate or absorb cholesterol. EPS produced by *Lc. lactis* ssp. *cremoris* in fermented milks are reported to interfere with absorption of cholesterol similar to that with dietary fiber.

Despite several studies, this effect is still not considered an established effect and double-blinded placebo-controlled human clinical trials are needed to substantiate this claim. Similarly, mechanisms involved in reducing cholesterol level should be clarified. Additional research is needed to substantiate the possible hypocholesterolaemic effect of yogurt.

### IMMUNE SYSTEM STIMULATION

The health benefits of fermented milks are primarily because of the ability of starter bacteria to survive in the gastrointestinal tract. Yogurt starter bacteria are reported to survive in the stomach and are also found in feces. The intestinal system defends the body against bacterial and viral infection and cancer and allergies. The intestine is body's largest immune organ and the intestinal microflora and the metabolic activity of intestine is equivalent to that of the liver. The intestinal tract works as a peripheral organ to protect against intestinal infections and affects systemic immunological function. Its function is affected by intestinal microflora. The mechanism for immunomodulation is not clearly understood. Lactic acid bacteria (LAB) are likely to, directly or indirectly (by changing the composition or activity of the intestinal microflora), influence the body's immune function, but the mechanism is not fully understood. LAB can affect function of immune cells and activation of macrophages and "natural killer" (NK) cells by LAB have been reported. Yogurt cultures are reported to produce  $\gamma$ -interferon by T-cells. LAB also stimulate cytokines as represented by TNF- $\alpha$  (tumor necrosis factor) and IL-6 and IL-10 (interleukines 6 or 10). Translocation of small number of ingested bacteria via M cells to the Peyer's patches of the gut associated lymphoid tissue in the small intestine is claimed to be responsible for enhancing immunity. Ingestion of yogurt has been reported to stimulate cytokine production in blood cells, and activation of macrophages and NK cells has been observed.

Fermented milks have been reported to inhibit infections in mice caused by *Klebsiella pneumoniae*. Mice fed with fermented milks were healthier and lived longer. In a human clinical study, feeding yogurt starter bacteria in yogurt increased the serum level of  $\gamma$ -interferon and NK cell count.

Another potential mechanism of immune system stimulation involves the changes in fecal enzymes such as  $\beta$ -glucuronidase thought to be involved in colon carcinogenesis. Nitrate is metabolized by nitrate reductase. Yogurt bacteria are reported to have nitrate reductase activity. Nitrate is an intermediate product in the formation of N-nitroso compounds, which are highly carcinogenic (Goldin and Gorbach, 1984).

### HEALTH BENEFITS OF NORDIC FERMENTED MILKS

Nordic fermented milks are suggested to play immunomodulating role. This is primarily due to antigenic structures of the surface of lactococci. The primary starter culture, *Lc. lactis* ssp. *cremoris* in viili is reported to stimulate secretion of immunoglobulins, mainly IgM. Proliferation of T lymphocytes was also observed with this strain. This organism has also shown induction of cytotoxicity of peritoneal murine macrophages against sarcoma cells. Intraperitoneal injection (at a dose of 10 mg/kg) of freeze-dried cell preparation was reported to retard the growth of ascitic and solid sarcomas in mice. This effect has also been reported for freeze-dried preparations of langfil (at a dose of 50 mg/kg) and ropy yogurt (at a dose of 100 mg/kg). *Lc. lactis* ssp. *cremoris* is also reported to reduce mutagenic effect of nitrosated beef extract by 40% as determined by Ames test using *Salmonella typhimurium*. *Lc. lactis* ssp. *cremoris*, which is also reported to lower serum cholesterol in rats. Lactococci isolated from Nordic fermented milks are reported to inhibit common pathogens such as *Staphylococcus aureus* and *Escherichia coli* (Kitazawa et al., 1991)

### HEALTH EFFECTS OF KEFIR

Kefir is reported to inhibit the growth of pathogenic and spoilage microflora including *Escherichia coli* O-157, *Salmonella* and *Listeria* by bacteriocin produced by LAB isolated from kefir grains. Oral administration of water-soluble fraction of kefir grains simulated antibody production and reduced tumor size in mice. Reduction in lactose-malabsorption related symptoms is also reported in mini-pigs. The

organisms in kefir grains are reported to assimilate cholesterol (Kitazawa et al., 1991).

## HEALTH BENEFITS OF BIO-YOGURT

A number of health benefits are claimed in favor of products containing probiotic organisms such as *Lb. acidophilus* and *Bifidobacterium* spp. It is recommended that the probiotic products contain at least  $10^6$  viable cells of *Lb. acidophilus* and *Bifidobacterium* spp. per gram of product. It is also recommended that the products must be consumed on a regular basis. The dosage level should be at least 100 g so that the level of organisms consumed would be  $10^8$  or  $10^9$  (Shah, 2000). Health benefits of probiotic bacteria include antimicrobial properties, improvement in lactose metabolism, antimutagenic properties, anticarcinogenic properties, reduction in serum cholesterol, anti-diarrhoeal properties, immune system stimulation, improvement in inflammatory bowel disease, and suppression of *Helicobacter pylori* infection. There is sufficient evidence to support the view that oral administration of Lactobacilli and bifidobacteria is able to restore the normal balance of microbial populations in the intestine (Armuzzi et al., 2001; Cats et al., 2003).

## REFERENCES

- Armuzzi A, Cremonini F, Bartolozzi F, Canducci F, Candelli M, Ojetti V, Cammarota G, Anti M, De Lorenzo A, Pola P, Gasbarrini G, Gasbarrini A. 2001. The effect of oral administration of *Lactobacillus* GG on antibiotic-associated gastrointestinal side-effects during *Helicobacter pylori* eradication therapy. *Aliment Pharmacol. Therapy* 15(2):163–169.
- Bourlioux P, Pochart P. 1988. Nutritional and health properties of yogurt. *World Reviews of Nutrition and Dietetics* 56:217–258.
- Buttriss J. 1997. Nutritional properties of fermented milk products. *Int. J. Dairy Technol.* 50(1):21–27.
- Cats A, Kulpers EJ, Bosschaert MA, Pot RG, Vandembroucke-Gauls CM, Kusters JG. 2003. Effect of frequent consumption of *Lactobacillus casei*—containing milk drink in *Helicobacter pylori*—colonised subjects. *Aliment. Pharmacol. Therapy* 17(3):429–35.
- Cenci G, Rossi J, Throtta F, Caldini G. 2002. Lactic acid bacteria isolated from dairy products inhibit genotoxic effect of 4-nitroquinoline—1—oxide in SOS-chromotest. *Syst. Appl. Microbiol.* 25(4): 483–90.
- Dave R, Shah NP. 1997. Characteristics of bacteriocin produced by *L. acidophilus* LA-1. *Intern. Dairy J.* 7:707–715.
- Deeth HC, Tamime AY. 1981. Yoghurt: Nutritive and therapeutic aspects. *J. Food Prot.* 44(1):78–86.
- Goldin BR, Gorbach SL. 1977. Alterations in faecal microflora enzymes related to diet, age, lactobacillus supplement and dimethyl hydrazine. *Cancer* 40: 2421–2426.
- Goldin BR, Gorbach SL. 1984. The effect of milk and *Lactobacillus* feeding on human intestinal bacterial enzyme activity. *Amer. J. Clin. Nutr.* 39:756–761.
- Gomes AMP, Malcata FX. 1999. *Bifidobacterium* spp. and *Lactobacillus acidophilus*: biological, biochemical, technological and therapeutical properties relevant for use as probiotics. *Trends in Food Sci. Technol.* 10:139–157.
- Goodenough ER, Kleyn DH. 1976. Influence of viable yogurt microflora on digestion of lactose by the rat. *J. Dairy Sci.* 59:601.
- Gurr MI. 1987. Nutritional aspects of fermented milk products. *FEMS Microbiology Reviews* 46:337–342.
- Holm F. 2003. Gut health and diet: the benefits of probiotic and prebiotics on human health. *The World of Ingredients.* 2:52–55.
- IDF. 1984. Fermented milks. *International Dairy Federation Bulletin No. 179*:16–32.
- IDF. 1991. Cultured dairy products in human nutrition. *Int. Dairy Fed..Bulletin No. 225*:1–32.
- Kitazawa H, Toba T, Itoh T, Kumono N, Adachi S, Yamaguchi T. 1991. Antitumoral activity of slime-forming, encapsulated *Lactococcus lactis* ssp. *cremoris* isolated from Scandinavian ropy sour milk, ‘villi’. *Animal Sci. Technol.* 62(3): 277–283.
- Klaver FAM, Meer RVD. 1993. The assumed assimilation of cholesterol by lactobacilli and *Bifidobacterium bifidum* is due to their bile salt deconjugating activity. *Appl. Environ. Microbiol.* 59:1120–1124.
- Koroleva NS. 1988. Technology of kefir and kumys. *International Dairy Federation Bulletin No. 227*, IDF, pp. 96–100.
- Kosikowski F, Mistry VV. 1997. *Fermented Milk Foods—Origins and Principles.* Vol. 1. F.V. Kosikowski-L.L.C., Westport, CT, USA, pp. 87–108.
- Kurmann JA, Rasic JL. 1988. Technology of fermented special products. *Fermented Milks: Science and Technology*, International Dairy Federation Bulletin no. 277, IDF, Brussels, pp. 101–109.
- Lankaputhra WEV, Shah NP. 1998. Antimutagenic properties of probiotic bacteria and of organic acids. *Mutation Research* 397:169–182.

- Lee YK, Wong SF. 1993. Stability of lactic acid bacteria in fermented milk. In: S Salminen, von A Wright (Eds), *Lactic Acid Bacteria* Marcel Dekker, New York, pp. 103–114.
- Mann GV, Spoerry A. 1974. Studies of a surfactant and cholesterolemia in the Massai. *Amer. J. Clin. Nutr.* 27:464–469.
- Onwulata CI, Ramkishan Rao D, Vankineni P. 1989. Relative efficiency of yogurt, sweet acidophilus milk, hydrolysed-lactose milk, and a commercial lactase tablet in alleviating lactose maldigestion. *Amer. J. Clin. Nutr.* 49:1233–1237.
- Orrhage K, Sillerstrom E, Gustafsson JA, Nord CE, Rafter J. 1994. Binding of mutagenic heterocyclic amines by intestinal and lactic acid bacteria. *Mutation Research* 311:239–248.
- Prajapati JB, Nair BM. 2003. History of fermented foods. *Handbook of Fermented Functional Foods*. CRS Press, Boca Raton, New York.
- Reddy GV, Shahani KM, Banerjee MR. 1973. J. Natural Cancer Institute. 50:815 (cited in Deeth HC and AY Tamime, 1981).
- Reddy KP, Shahani KM, Kulkarni SM. 1976. B-complex vitamins in cultured and acidified yogurt. *J. Dairy Sci.* 59:191.
- Saavedra JM, Bauman NA, Oung I, Perman JA, Yolken RH. 1994. Feeding of *Bifidobacterium bifidum* and *Streptococcus thermophilus* to infants in hospital for prevention of diarrhoea and shedding of rotavirus. *Lancet* 344:1046–1049.
- Savaiano DA, ElAnouar AA, Smith DJ, Levitt MD. 1984. Lactose malabsorption from yogurt, pasteurized yogurt, sweet acidophilus milk, and cultured milk in lactase-deficient individuals. *Amer. J. Clin. Nutr.* 40:1219.
- Shah NP. 1993. Effectiveness of dairy products in alleviation of lactose intolerance. *Food Aust.* 45:268–271.
- Shah NP. 1999. Probiotic bacteria: Antimicrobial and antimutagenic properties. *Probiotica* 6:1–3.
- Shah NP. 2000. Probiotic bacteria: Selective enumeration and survival in dairy foods. *J. Dairy Sci.* 83: 894–907.
- Shah NP. 2003. Yogurt: The product and its manufacture. *Encyclopedia of Food Sciences and Nutrition*, Academic Press, London, pp. 6252–6260.
- Shah NP, Fedorak RN, Jelen P. 1992. Food consistency effects of quarg in lactose absorption by lactose intolerant individuals. *Inter. Dairy J.* 2:257–269.
- Tamime AY, Deeth HC. 1980. Yoghurt: Technology and biochemistry. *J. Food Prot.* 43(2):939–977.
- Tamime AY, Robinson RK. 1999. *Yoghurt: Science and Technology*, 2nd ed. Cambridge, Woodhead.

# 22

## Probiotics and Fermented Milks

Nagendra P. Shah

- Introduction
- Taxonomy of Lactic Acid Bacteria
- Probiotic Bacteria
- Selection Criteria for Probiotics
  - Genus *Lactobacillus*
  - Genus *Bifidobacterium*
  - Health Benefits of *Lactobacillus acidophilus* and Bifidobacteria
  - Antimicrobial Activity and Gastrointestinal Infections
  - Effectiveness Against Diarrhoea
  - Improvement in Lactose Metabolism
  - Antimutagenic Properties
  - Anticarcinogenic Properties
  - Reduction in Serum Cholesterol
- Helicobacter pylori* Infection
  - Inflammatory Bowel Disease
  - Immune System Stimulation
- Conclusions
- References

### INTRODUCTION

Lactic acid bacteria are widely used as starter cultures in fermentation of milk, vegetables, meats, beverages, and bakery products. Fermentation with lactic acid bacteria results in altered composition, improved flavor, and prolonged shelf life. Lactic acid bacteria are widespread in nature, and are found primarily in the environment with high concentration of carbohydrates, peptides and amino acids, and vitamins. Many lactic acid bacteria are normal inhabitants of the human body. The use of probiotic organisms such as *Lactobacillus acidophilus* and *Bifidobacterium* spp. in fermented milks became popular by the end of 1970s as a result of increased knowledge about these organisms. New fermented products containing *Lb. acidophilus*, *Bifidobacterium* spp., *Lactobacillus*

*casei* Shirota, *Lactobacillus rhamnosus* GG, and *Lactobacillus reuteri* have been developed in Europe. However, *Lb. acidophilus* and *Bifidobacterium* spp. are most commonly used as probiotics. It is estimated that over 70 products containing *Lb. acidophilus* and *Bifidobacterium* spp. including yogurt, buttermilk, frozen desserts, and milk powder are produced worldwide. Probiotic organisms are also available as powders, capsules, and tablets (Mittal and Garg, 1992). A number of health benefits are claimed in favor of probiotic organisms including antimicrobial properties, control of gastrointestinal disorders, improvement in lactose metabolism, anticarcinogenic properties, and reduction in serum cholesterol.

### TAXONOMY OF LACTIC ACID BACTERIA

Lactic acid bacteria are divided in several genera based on their ability to ferment specific sugars, temperature for growth, nutrient needs, sensitivity to salt, and the presence of specific enzymes. Methods for classifying lactic acid bacteria in various genera, species, or strains have evolved from overall morphology of the organisms and growth conditions to physiological behavior and metabolic pathways. More accurate techniques for the classification of lactic acid bacteria involve molecular structure and genetic information such as DNA-DNA and DNA-RNA homology analyses and sequencing of 16S rRNA (Klein et al., 1998; Stiles and Holzapfel, 1997).

Lactic acid bacteria can be divided into two general categories, according to their metabolic end-products. Homofermentative lactic acid bacteria produce lactic acid as their principal end-product, whereas heterofermentative lactic acid bacteria



produce acetic acid, CO<sub>2</sub>, and ethanol in addition to lactic acid. Mesophilic lactic acid bacteria grow best at a temperature range of 25–30°C, whereas thermophilic lactic acid bacteria prefer a temperature range of 40–44°C.

Lactic acid bacteria are Gram-positive, usually catalase-negative and grow under microaerophilic to strictly anaerobic conditions. The most important genera are: *Lactobacillus*, *Lactococcus*, *Enterococcus*, *Streptococcus*, *Pediococcus*, *Leuconostoc*, and *Bifidobacterium*. Phylogenetically, Gram-positive bacteria are divided into two major branches. With the exception of bifidobacteria, all the above-mentioned genera of lactic acid bacteria have low (<50) %G + C (guanine plus cytosine) content. Nevertheless, *Bifidobacterium* shares similar physiological and biochemical properties as lactic acid bacteria and some common ecological niches such as the gastro-intestinal tract. Species of these genera can be found in the gastrointestinal tract of man and animal as well as in fermented foods. Some physiological characteristics are of interest for their function as probiotics including survival in the gastrointestinal tract. This is based on their resistance to low pH and bile.

## PROBIOTIC BACTERIA

The word “probiotic” originated from Greek meaning “for life”. Probiotics are defined as “live microbial feed supplement, which beneficially affects the host by improving its intestinal microbial balance”. Probiotics have been consumed in foods such as yogurt for perhaps thousands of years, and while the “cultures” were thought to have beneficial effects, it was not until the 1900s that scientists began to investigate the reasons for those benefits.

A number of genera of bacteria (and yeast) are used as probiotics including *Lactobacillus*, *Streptococcus*, *Leuconostoc*, *Pediococcus*, *Bifidobacterium*, and *Enterococcus*; however, the main species believed to have probiotic characteristics are *L. acidophilus*, *Bifidobacterium* spp., and *Lb. casei*. Members of the genera *Lactobacillus* and *Bifidobacterium* have a long and safe history in the manufacture of dairy products and are also found as a part of gastrointestinal microflora. Probiotic bacteria with desirable properties and well-documented clinical effects include *Lb. johnsonii* La1, *L. rhamnosus* GG (ATCC 53103), *Lb. casei* Shirota, *Lb. acidophilus* NCFB 1478, *B. animalis* Bb12 and *Lb. reuteri*.

Traditionally, probiotic organisms have been added to yogurt and other fermented foods; however,

recently, these organisms are incorporated in drinks and marketed as supplements including tablets, capsules, and freeze dried preparations. Today, there are over 70 bifidus- and acidophilus-containing products produced worldwide including sour cream, buttermilk, yogurt, powdered milk, and frozen desserts. More than 53 different types of milk products that contain probiotic organisms are marketed in Japan alone. The probiotics in Europe are very popular, but their use is largely restricted to the yogurt sector.

A probiotic yogurt may contain *Lb. acidophilus* only or *Lb. acidophilus* and *Bifidobacterium* spp. (known as AB culture) or *Lb. acidophilus*, *Bifidobacterium* spp. and *Lb. casei* (known as ABC culture) as probiotic organism in addition to the two yogurt starters (*Lactobacillus delbrueckii* ssp. *bulgaricus* and *Streptococcus thermophilus*). The combined use of two (e.g., AB culture) or three (e.g., ABC culture) probiotic strains is common in commercial probiotic foods, as these strains are believed to act synergistically on each other.

Thus, probiotic yogurts may contain up to five different groups of bacteria. Unlike yogurt starter bacteria, probiotic organisms grow slowly in milk. The fermentation time for making yogurt is approximately 4 hours with yogurt starter bacteria, whereas the fermentation time could be as long as 24 hours with probiotic bacteria only. Thus the trend is to use yogurt bacteria as the main starter culture and probiotic bacteria as an adjunct starter (Shah, 2000a).

## SELECTION CRITERIA FOR PROBIOTICS

There is increasing evidence that probiotics can benefit the human host by acting as a first line of defence against disease-causing pathogens by improving the intestinal microflora.

The parameters for screening microorganisms for potential valuable probiotic strains should include the fact that there is a necessity for the strain to be viable and metabolically active within the gastrointestinal tract. In addition, it is important that viability of the organisms and stability of the desirable characteristics of the strain can be maintained during commercial production as well as throughout the shelf life of the product (Gilliland, 2003). To have probiotic strains with predictable and measurable health benefits, a concerted effort for strain selection is required. Common criteria used for selecting probiotic bacteria are shown in Table 22.1.

**Table 22.1.** Criteria Used for Selecting Probiotic Bacteria

---

Genera of human origin
Nontoxic and nonpathogenic
Resistant to acid, bile, and oxygen
Production of antimicrobial substances and antagonistic toward pathogenic bacteria
Ability to adhere to intestinal mucosa
Colonization potential in the human gastrointestinal tract
Demonstrable efficacy
Immunomodulatory
Able to withstand technological processes and remain viable throughout the shelf life
Viability at high populations, preferably at $10^6$ – $10^8$

---

Source: Adapted from Salminen and Ouwehand, 2003; Gilliland, 2003.

## GENUS LACTOBACILLUS

In 1909, Moro was the first scientist to isolate facultative anaerobic rods from the faeces of breast-fed infants, which he called as *Bacillus acidophilus*. The name of *Lb. acidophilus* has been derived from “acidus” meaning “acid” and “philus” meaning “loving”. *Lb. acidophilus* contains mainly obligately homofermenters whose major end-product is lactic acid, but a few are facultative heterofermenters. They occur naturally in the gastrointestinal tract of humans and animals, in the human mouth and vagina, and in some traditional fermented milks, such as kefir. The G + C content of their DNA is usually between 32 and 53 mol%. They are either microaerophilic, aerotolerant, or anaerobic and strictly fermentative. Glucose is fermented predominantly to lactic acid in homofermenters, or to equimolar amounts of lactic acid, CO<sub>2</sub> and ethanol in the case of heterofermenters. On

the basis of DNA-DNA homology, six major species have been identified: *Lb. acidophilus*, *Lb. crispatus*, *Lb. amylovorus*, *Lb. gallinarum*, *Lb. gasseri*, and *Lb. johnsonii* (Gopal, 2003).

At present, 56 species of the genus *Lactobacillus* have been recognized (Table 22.2).

*Lb. acidophilus* is the most commonly suggested organism for dietary use. *Lb. acidophilus* is a Gram-positive rod with rounded ends that occurs as single cells, as well as in pairs or in short chains. The typical size is 0.6–0.9 μm in width and 1.5–6.0 μm in length. *Lb. acidophilus* is nonmotile and nonspore forming organism. Most strains are microaerophilic or anaerobic, so the surface growth on solid media is generally enhanced by anaerobiosis or reduced oxygen pressure and providing 5–10% CO<sub>2</sub> in anaerobic jars during growth. The organisms require carbohydrates

**Table 22.2.** List of Species (by Alphabetical Order) of the Genera *Lactobacillus*<sup>a</sup>

### *Lactobacillus* Species

---

<i>L. acetotolerans</i>	<i>L. curvatus</i>	<i>L. intestinalis</i>	<i>L. plantarum</i> <sup>a</sup>
<i>L. acidophilus</i> <sup>a</sup>	<i>L. delbrueckii</i>	<i>L. jensenii</i> <sup>a</sup>	<i>L. reuteri</i> <sup>a</sup>
<i>L. alimentarius</i>	<i>L. farciminis</i>	<i>L. johnsonii</i>	<i>L. rhamnosus</i> <sup>a</sup>
<i>L. amylophilus</i>	<i>L. fermentum</i> <sup>a</sup>	<i>L. kefir</i>	<i>L. ruminis</i>
<i>L. amylovorus</i>	<i>L. fructivorans</i>	<i>L. kefiranoferaciens</i>	<i>L. sake</i>
<i>L. avarius</i>	<i>L. fructosus</i>	<i>L. malefermentans</i>	<i>L. salivarius</i> <sup>a</sup>
<i>L. bifementans</i>	<i>L. gallinarum</i>	<i>L. mali</i>	<i>L. sanfrancisco</i>
<i>L. brevis</i> <sup>a</sup>	<i>L. gasseri</i> <sup>a</sup>	<i>L. minor</i>	<i>L. sharpeae</i>
<i>L. buchneri</i> <sup>a</sup>	<i>L. graminis</i>	<i>L. murinus</i>	<i>L. suebicus</i>
<i>L. casei</i> ssp. <i>casei</i> <sup>a</sup>	<i>L. halotolerans</i>	<i>L. oris</i> <sup>a</sup>	<i>L. vaccinosfercus</i>
<i>L. collinoides</i>	<i>L. hamsteri</i>	<i>L. parabuchneri</i> <sup>a</sup>	<i>L. vaginalis</i> <sup>a</sup>
<i>L. confuses</i>	<i>L. helveticus</i>	<i>L. paracasei</i> <sup>a</sup>	<i>L. viridescens</i>
<i>L. coryniformis</i>	<i>L. hilgardii</i>	<i>L. pentosus</i>	
<i>L. crispatus</i> <sup>a</sup>	<i>L. homohiochii</i>	<i>L. pontis</i>	

---

<sup>a</sup>Species isolated from human sources

Source: Adapted from Sgorbati et al., 1995; Gomes and Malcata, 1999.

as energy and carbon source as well as nucleotides, amino acids, and vitamins. Most strains can ferment cellobiose, fructose, galactose, glucose, lactose, maltose, mannose, salicin, sucrose, and aesculine. *Lb. acidophilus* utilizes sucrose more effectively than lactose. The glucose moiety is metabolized via the Embden-Meyerhof-Parnas pathway with lactic acid as essentially the sole end product in homolactics. Supplementation with manganese, oleic acid, esters especially Tween 80, are stimulatory or essential for most species. Therefore, these compounds are included in MRS medium. Acetaldehyde, a carbonyl flavoring molecule, also results from metabolism of lactose. Growth of *Lb. acidophilus* occurs at as high as 45°C; however, the optimum growth temperature is between 35°C and 40°C. The organisms grow in slightly acidic media at pH of 6.4–4.5. Growth ceases when pH of 4.0–3.6 is reached. Acid tolerance of organisms varies from 0.3% to 1.9% titratable acidity, with an optimum pH at 5.5–6.0 (Curry and Crow, 2003; Shah, 1997).

*Lb. acidophilus* tends to grow slowly in milk, leading to the risk of overgrowth of undesirable microorganisms. Ironically, most strains of *Lb. acidophilus* do not survive well in fermented milk due to the low pH, and it is difficult to maintain large numbers in the product. *Lb. acidophilus* grows poorly in milk even as they show a high level of  $\beta$ -galactosidase activity. This is partly related to low concentration of small peptides and free amino acids in milk, which would be insufficient to support the bacterial growth.

### Isolation and Enumeration

MRS agar can be used as a nonselective medium for isolation of *Lb. acidophilus* from pure cultures. However, for selection of *Lb. acidophilus* from a mixed population of different genera of microorganisms, a selective medium must be employed. MRS medium supplemented with bile will assist growth of *Lb. acidophilus*. MRS agar at pH 5.2 can also be used to support the growth of *Lb. acidophilus*. Most media that support the growth of *Lb. acidophilus* also support the growth of *Lb. casei* and *Lb. rhamnosus*. Basal agar (BA; 10 g trypton, 10 g Lablemco powder, 5 g yeast extract, 1 g Tween 80, 2.6 g  $K_2HPO_4$ , 5 g sodium acetate, 2 g tri-ammonium citrate, 2 g  $MgSO_4 \cdot 7H_2O$ , 0.05 g  $MnSO_4 \cdot 4H_2O$ , 12 g bacteriological agar, and 1 liter of distilled water)—sorbitol agar, BA-mannitol agar and BA-esculin agar can be used for selective enumeration of *Lb. acidophilus* in presence of *Lb. casei* and *Lb. rhamnosus*. Similarly, MRS-maltose

agar can be used as a selective medium in presence of these organisms. *Lb. acidophilus* prefers anaerobic conditions and growth is stimulated in agar under a standard anaerobic environment of 5% oxygen, 85% nitrogen, and 10% carbon dioxide. BA-sorbitol agar can be used for enumerating *L. acidophilus* from dairy foods containing *Lb. delbrueckii* ssp. *bulgaricus*, *Str. thermophilus*, and *Bifidobacterium* spp. For further details on isolation and enumeration of *Lb. acidophilus*, see Dave and Shah (1996) and Tharmaraj and Shah (2003).

### GENUS BIFIDOBACTERIUM

Bifidobacteria are normal inhabitants of the human gastrointestinal tract. Recent *in vivo* scientific studies using animals or human volunteers have shown that consumption of live bifidobacteria have an effect on the gut microflora. Selected strains survive stomach and intestinal transit and reach the colon in abundant numbers. Newborns are colonized with bifidobacteria within days after birth and the population appears to be relatively stable until advanced age, then the population declines. However, diet, antibiotics, and stress are reported to influence the population of bifidobacteria in the intestines.

Bifidobacteria were first isolated from feces of breast fed infants by Tissier in 1899–1900. He described it as rod-shaped, nongas-producing anaerobic microorganisms with bifid morphology, which he termed *Bacillus bifidus*. Bifidobacteria are generally characterized as Gram-positive, nonspore forming, nonmotile, and catalase-negative anaerobes. They have various shapes including short curved rods, club-shaped rods, and bifurcated Y-shaped rods. Bifidobacteria are anaerobes with a special metabolic pathway, which allows them to produce acetic acid in addition to lactic acid. Acetic acid and lactic acid are formed primarily in the molar ratio of 3:2. They are fastidious organisms and have special nutritional requirements, thus often these bacteria are difficult to isolate and grow in the laboratory (Shah, 1997; 2002).

The taxonomy of bifidobacteria has changed continuously since they were first isolated. They have been assigned to the genera *Bacillus*, *Bacteroides*, *Nocardia*, *Lactobacillus*, and *Corynebacterium*, before being recognized as separate genera in 1974. All members of genus *Bifidobacterium* contain >50 mol% G + C, whereas *Lactobacilli* contain <50 mol% G + C in DNA. Based on the mol% G + C contents, all lactic acid producers have been

**Table 22.3.** List of Species (by Alphabetical Order) of the Genera *Bifidobacterium*<sup>a</sup> and their mol% G + C contents

<i>Bifidobacterium</i> sp.	Mol% G + C	<i>Bifidobacterium</i> sp.	Mol% G + C
<i>B. adolescentis</i> <sup>a</sup>	58.9	<i>B. indicum</i>	60.0
<i>B. angulatum</i> <sup>a</sup>	59.0	<i>B. infantis</i> <sup>a</sup>	60.5
<i>B. animalis</i>	60.0	<i>B. longum</i> <sup>a</sup>	60.8
<i>B. asteroides</i>	59.0	<i>B. magnum</i>	60.0
<i>B. bifidum</i> <sup>a</sup>	60.8	<i>B. mericicum</i>	59.0
<i>B. boum</i>	60.0	<i>B. minimum</i>	61.6
<i>B. breve</i> <sup>a</sup>	58.4	<i>B. pseudocatenulatum</i> <sup>a</sup>	57.5
<i>B. catenulatum</i> <sup>a</sup>	54.0	<i>B. pseudolongum</i>	59.5
<i>B. choerinum</i>	66.3	<i>B. pullorum</i>	67.5
<i>B. coryneformes</i>	–	<i>B. ruminantium</i>	57.0
<i>B. cuniculi</i>	64.1	<i>B. saeculare</i>	63.0
<i>B. dentium</i> <sup>a</sup>	61.2	<i>B. subtile</i>	61.5
<i>B. gallicum</i>	61.0	<i>B. suis</i>	62.0
<i>B. gallinarum</i>	65.7	<i>B. thermophilum</i>	60.0
<i>B. globosum</i> <sup>a</sup>	63.8		

<sup>a</sup>Species isolated from human species

Source: Adapted from Sgorbati et al., 1995; Gomes & Malcata, 1999.

allocated into two divisions: *Clostridium* and *Actinomyces*. The Actinomycetaceae family consists of five genera: *Bifidobacterium*, *Propionibacterium*, *Microbacterium*, *Corynebacterium*, and *Brevibacterium*. Presently, there are 29 species in the genus *Bifidobacterium* (Table 22.3), 14 of which are isolated from human sources (i.e., dental caries, faeces, and vagina), 12 from animal intestinal tracts or rumen, and three from honeybees. *Bifidobacterium* species found in humans are: *B. adolescentis*, *B. angulatum*, *B. bifidum*, *B. breve*, *B. catenulatum*, *B. dentium*, *B. infantis*, *B. longum*, and *B. pseudocatenulatum*. *B. breve*, *B. infantis*, and *B. longum* are found in human infants. *B. adolescentis*, and *B. longum* are found in human adults (Shah and Lankaputhra, 2002).

Bifidobacteria are saccharolytic organisms and produce acetic acid and lactic acid without generation of CO<sub>2</sub>. All bifidobacteria from human origin are able to utilize glucose as well as galactose, lactose and, usually, fructose as carbon sources. *Bifidobacterium* spp. are also able to ferment complex carbohydrates. The substrates fermented by the largest number of species are: D-galactosamine, D-glucosamine, amylose and amylopectin. Fructose-6-phosphate phosphotolase is the characteristic key enzyme, which is the most direct and reliable test for assigning an organism to the genus *Bifidobacterium*.

The optimum pH for the growth of bifidobacteria is 6.0–7.0, with virtually no growth at pH 4.5–5.0

or below or at pH 8.0–8.5. Optimum growth occurs at a temperature of 37–41°C, maximum growth is at 43–45°C, while minimum growth temperature is 25–28°C.

The main probiotic organisms that are currently used worldwide belong to the genera *Lactobacillus* and *Bifidobacterium* and are shown in Tables 22.4 and 22.5, whereas the leading commercial probiotic lactobacilli and bifidobacteria are shown in Table 22.6.

Strains with peer reviewed published evidence from human clinical trials are shown in Table 22.7.

A limited number of investigations have also been carried out into the potential properties of genera including *Pediococcus*, *Leuconostocs*, and *Propionibacterium* and *Enterococcus faecium*. *E. faecium* is more pH stable than *L. acidophilus* and produces bacteriocins against some enteropathogens. These properties make this organism attractive as a probiotic.

It is obvious from published reviews that four strains with the most published clinical data are *Lb. rhamnosus* GG, *Lb. casei* Shirota, *B. animalis* Bb-12, and *Saccharomyces cerevisiae* Boulardii.

### Isolation and Enumeration

Bifidobacteria are fastidious organisms. MRS agar can be used as a nonselective medium for isolation of *Bifidobacterium* spp. MRS-NNLP (nalidixic acid, neomycin sulfate, lithium chloride, and

**Table 22.4.** Lactobacilli Used as Probiotic Cultures

Species	Strains	
<i>L. acidophilus</i>	LA-1/LA-5	(Chr. Hansen)
<i>L. acidophilus</i>	NCFM	(Rhodia)
<i>L. acidophilus</i> Johnsonii	La1	(Nestle)
<i>L. acidophilus</i>	DDS-1	(Nebraska Cultures)
<i>L. acidophilus</i>	SBT-2062	(Snow Brand Milk Products)
<i>L. bulgaricus</i>	Lb12	
<i>L. lactis</i>	L1A	(Essum AB)
<i>L. casei</i> Immunitas		(Danone)
<i>L. plantarum</i>	299v, Lp01	
<i>L. rhamnosus</i>	GG	(Valio)
<i>L. rhamnosus</i>	GR-1	(Urex Biotech)
<i>L. rhamnosus</i>	LB21	(Essum AB)
<i>L. reuteri</i>	SD2112/MM2)	(Biogaia)
<i>L. rhamnosus</i>	271	(Probi AB)
<i>L. plantarum</i>		(Probi AB)
<i>L. reuteri</i> (also known as MM2)	SD2112	
<i>L. casei</i>	Shirota	(Yakult)
<i>L. paracasei</i>	CRL 431	(Chr. Hansen)
<i>L. fermentum</i>	RC-14	(Urex Biotech)
<i>L. helveticus</i>	B02	

Source: Adapted from Krishnakumar and Gordon, 2001; Holm, 2003.

paramycin sulfate) agar is selective medium for counting bifidobacteria. Bifidobacteria can be selectively enumerated from dairy foods containing *Lb. delbrueckii* ssp. *bulgaricus*, *Str. Thermophilus*, and *Lb. acidophilus* using MRS-NNLP agar. Cysteine (0.05%) must be added to the medium. Cysteine pro-

vides essential nutrient and lowers redox-potential. Incubation conditions are anaerobic environment at 37°C for 72 hours. When L-cysteine is not present in the media, bifidobacteria either do not grow or form pin-point colonies. Bifidobacteria do not grow under aerobic conditions. For further details on isolation

**Table 22.5.** Bifidobacteria Cultures Used as Probiotic Cultures

Species	Strains	
<i>B. adolescentis</i>		
<i>B. longum</i>	BB536	(Morinaga Milk Industry)
<i>B. longum</i>	SBT-2928	(Snow Brand Milk Products)
<i>B. breve</i>	Yakult	
<i>B. bifidus</i>	Bb-11	
<i>B. lactis</i> (reclassified as <i>B. animalis</i> )	Bb-12	(Chr. Hansen)
<i>B. essensis</i>	Danone	(Bioactivia)
<i>B. lactis</i>	Bb-02	
<i>B. infantis</i>	Shirota	
<i>B. infantis</i>	Immunitas	(Danone)
<i>B. infantis</i>	744	
<i>B. infantis</i>	01	
<i>B. laterosporus</i>	CRL 431	
<i>B. lactis</i>	Lafti™, B94	(DSM)
<i>B. longum</i>	UCC 35624	(UCCork)
<i>B. lactis</i>	DR10/HOWARU	Danisco

Source: Adapted from Krishnakumar and Gordon, 2001; Holm, 2003; Playne et al., 2003.

**Table 22.6.** Leading Commercial Probiotic Lactobacilli and Bifidobacteria.

<i>Lactobacillus</i>	Strain	Manufacturer
<i>L. acidophilus</i>	La-5	(Chr. Hansen, Denmark)
<i>L. acidophilus</i>	NCFM	(Rhodia, USA)
<i>L. casei</i>	Shirota	(Yakult, Japan)
<i>L. acidophilus</i>	Johsonii La1	(Nestle, Switzerland)
<i>L. plantarum</i>	299v	(Probi, Sweden)
<i>L. reuteri</i>	MM2	(Biogaia, Sweden and USA)
<i>L. rhamnosus</i>	GG	(Valio, Finland)
<i>Bifidobacterium</i>		
<i>B. lactis</i> (reclassified as <i>B. animalis</i> )	Bb-12	(Chr. Hansen, Denmark)
<i>B. longum</i>	BB536	(Morinaga Milk Industry, Japan)
<i>B. longum</i>	SBT-2928	(Snow Brand Milk Products, Japan)
<i>B. breve</i>		(Yakult, Japan)
<i>B. lactis</i> Lafti™,	B94	(DSM, Australia)
<i>B. longum</i>	UCC 35624	(UCCork, Ireland)
<i>B. lactis</i>	DR10/HOWARU	(Danisco, Denmark)

Source: Adapted from Krishnakumar and Gordon, 2001; Holm, 2003; Playne et al., 2003.

and enumeration of bifidobacteria, see Dave and Shah (1996) and Tharmaraj and Shah (2003).

#### HEALTH BENEFITS OF *LACTOBACILLUS ACIDOPHILUS* AND *BIFIDOBACTERIA*

A number of health benefits are claimed in favor of products containing probiotic organisms. Some of the health benefits are well established, while other benefits have shown promising results in animal models. However, additional studies are required in humans to substantiate these claims. Health benefits imparted by probiotic bacteria are strain specific, and not species- or genus-specific. It is important to understand that no strain will provide all proposed

benefits, not even strains of the same species. Not all strains of the same species will be effective against defined health conditions. The strains *Lb. rhamnosus* GG (Valio), *Sacch. cerevisiae* Boulardii (Biocodex), *Lb. casei* Shirota (Yakult), and *B. animalis* Bb-12 (Chr. Hansen) have the strongest human health efficacy data against management of lactose malabsorption, rotaviral diarrhoea, antibiotic-associated diarrhoea, and *Clostridium difficile* diarrhoea (Playne et al., 2003) (Table 22.8).

Health benefits of probiotic bacteria include antimicrobial activity and gastrointestinal infections, improvement in lactose metabolism, antimutagenic properties, anticarcinogenic properties, reduction in serum cholesterol, antidiarrhoeal properties, immune

**Table 22.7.** Strains with Peer Review Published Evidence from Human Clinical Trials.

<i>Lactobacillus rhamnosus</i>	GG	(Valio)
<i>Lactobacillus casei</i>	Shirota	(Yakult)
<i>Lactobacillus acidophilus</i>	NCFM	(Rhodia)
<i>Lactobacillus plantarum</i>	299v	(ProViva)
<i>Lactobacillus reuteri</i>		(Biogaia)
<i>Lactobacillus acidophilus</i>	Johnsonii La1	(Nestle)
<i>Lactobacillus acidophilus</i>	La5	(Chr. Hansen)
<i>Bifidobacterium animalis</i>	Bb 12	(Chr. Hansen)
<i>Bifidobacterium longum</i>	BB536	(Morinaga)
<i>Bifidobacterium breve</i>		(Yakult)
<i>Enterococcus faecium</i>	SF68	(Cemelle)
<i>Saccharomyces cerevisiae</i>	Boulardii	(Biocodex)

Source: Adapted from Krishnakumar and Gordon, 2001; Holm, 2003; Playne et al., 2003.

**Table 22.8.** Reported Studies and Proven Effects of Some Currently Available Probiotics

Strains	Reported Effects in Clinical Studies	Scientifically Established Effects
<i>L. johnsonii</i> LJ1	Adherence to human intestinal cells, balances intestinal flora	Mucosal adherence, immune enhancement
<i>L. acidophilus</i> NCFM	Lowering of fecal enzyme activity, improvement in lactose absorption, production of bacteriocin	Alleviation of lactose malabsorption
<i>L. rhamnosus</i> GG	Prevention of antibiotic associated diarrhea and rotavirus diarrhea, Shortening of duration of rotavirus	Management of <i>Clostridium difficile</i> diarrhea, prevention of acute diarrhea, prevention of antibiotic diarrhea, reduction in fecal enzyme associated diarrhea
<i>L. casei</i> Shirota	Prevention of intestinal disturbance; balancing intestinal flora; lowering of fecal enzyme activity	
<i>B. animalis</i> Bb12	Treatment of rotavirus diarrhea; balancing intestinal flora	Shortening of duration of rotavirus
<i>L. reuteri</i>	Colonizing the intestinal tract in animal studies Shortening of duration of rotavirus diarrhoea, immune enhancement	Shortening of duration of rotavirus
<i>S. cerevisiae</i> (boulardii)	Prevention of antibiotic associated diarrhoea; treatment of <i>C. difficile</i> colitis	Prevention of antibiotic associated diarrhoea
<i>E. faecium</i> (Gaio)	Reduction in cholesterol	Reduction in cholesterol

Source: Adapted from Fonden et al., 2000; Salminen and Ouwehand, 2003; Plyne et al., 2003.

system stimulation, improvement in inflammatory bowel disease, and suppression of *Helicobacter pylori* infection (Kurmann and Rasic, 1991). There is sufficient evidence to support the view that oral administration of Lactobacilli and bifidobacteria is able to restore the normal balance of microbial populations in the intestine (Ouwehand et al., 1999).

### ANTIMICROBIAL ACTIVITY AND GASTROINTESTINAL INFECTIONS

Probiotic bacteria produce lactic acid and acetic acid, hydrogen peroxide, and bacteriocins as antimicrobial substances. The antimicrobial substances are produced to suppress the multiplication of pathogenic and putrefying bacteria. Lactic acid and acetic acid are the main organic acid produced. Other acids produced in small quantities include citric acid, hippuric acid, orotic acid, and uric acid. Lactic and acetic acids account for over 90% of the acids produced. Lowering of pH due to lactic acid or acetic acid produced by these bacteria in the gut has a bacteriocidal or bacteriostatic effect. Both bifidobacteria and *Lb. acidophilus* show antagonistic effects to-

ward enteropathogenic *Escherichia coli*, *Salmonella typhimurium*, *Staphylococcus aureus*, and *Clostridium perfringens*. *Lb. acidophilus* produces various bacteriocins and antibacterial substances such as Lactocidin, Acidolin, Acidophilin, Lactacium-B, and inhibitory protein (known as bacteriocin-like inhibitory substances; BLIS). Similarly, *Bifidobacterium* produces Bifidolin and Bifilong, which inhibit several pathogenic bacteria. Hydrogen peroxide produced by *Lb. acidophilus* is inhibitory to many pathogens. Preparations containing *Enterococcus faecium* have been used for treatment of acute enteritis and other gut disorders. *Ent. faecium* is found in the feces of healthy adults.

Two types of lactic acid, L(+) and D(-), are produced during fermentation by lactic acid bacteria. Some species of bacteria including *Lb. delbrueckii* ssp. *bulgaricus* and *Lactococcus lactis* produce only D(-) lactic acid, whereas some lactic streptococci and *Lb. casei* produce L(+) lactic acid. *Lb. helveticus* and *Lb. acidophilus* produce a racemic mixture of L(+) and D(-) lactic acid. D(-) lactic acid is not metabolised to pyruvic acid in the body due to a lack of D2-hydroxy acid dehydrogenase and this results in acidosis in neonatal infants. L(+) isomer

is completely harmless. Bifidobacteria and *Lb. casei* produce L(+) lactic acid. Thus the lactic acid produced by bifidobacteria and *Lb. casei* is easily metabolised, while providing antimicrobial properties (Shah, 1999).

### EFFECTIVENESS AGAINST DIARRHOEA

One of the main applications of probiotics has been treatment and prevention of diarrhoea. A major problem associated with antibiotic treatment is appearance of diarrhoea, often caused by *Clostridium difficile*. This organism is found in small numbers in the healthy intestine; however, disruption of indigenous microflora due to antibiotic treatment leads to an increase in their number and toxin production, which causes symptoms of diarrhoea. Treatment with metonidazole or vancomycin is usually effective but recurrences are common. Administration of exogenous probiotic is required to restore the balance of flora. Probiotics have proved to be useful as a prophylactic regimen with antibiotic-associated diarrhoea, as well as for treatment after onset of antibiotic induced diarrhoea. A daily dose of *Lactobacillus* GG has been found to be effective in termination of diarrhoea. Studies with a yeast preparation containing *Sacch. cerevisiae* Boulardii has also been effective in treatment of *Clostridium difficile* related colitis.

Rotavirus is one of the most common causes of acute diarrhoea in children worldwide. During diarrheal stage of infection, the permeability of gut epithelial cells is increased to intact proteins. Probiotics are claimed to shorten duration of rotavirus diarrhoea in children (Saavedra et al., 1994). The strongest evidence of a beneficial effect of defined strains of probiotics has been established using *Lb. rhamnosus* GG and *B. lactis* Bb-12 (now reclassified as *B. animalis* Bb-12) for prevention and treatment of diarrhoea and acute diarrhoea in children mainly caused by rotaviruses. Selected probiotic strains are also effective against antibiotic-associated diarrhoea. Certain probiotic strains can inhibit the growth and adhesion of a range of enteropathogens. Studies have indicated beneficial effects against pathogens such as *Salmonella enteritidis* and *Salm. typhimurium*. *B. longum* SBT-2828 has shown inhibition of enterotoxigenic *Escherichia coli*. Mix of pediatric beverage containing *B. animalis*, *Lb. acidophilus*, and *Lb. reuteri* has been found to be useful in the prevention of rotavirus diarrhoea (Guandalini et al., 2000).

*Lb. rhamnosus* GG has been reported to be more effective in the treatment of rotavirus diarrhoea as compared with preparations containing *Str. thermophilus* and *Lb. delbrueckii* ssp. *bulgaricus*. *Lb. reuteri* has also been effective in shortening the duration of rotavirus diarrhoea. It reduces the duration of diarrhoea in children suffering from rotavirus diarrhoea. Treatment with *Lactobacillus* GG was associated with enhancement of IgA-specific antibody-secreting cells to rotavirus and serum IgA antibody level.

The mechanisms by which fermented dairy foods containing probiotics or culture containing milks reduce the duration of diarrhoea are unclear. One possible mechanism is that probiotic bacteria may prevent the growth of pathogens by competing for the attachment sites by producing specific binding inhibitor or by production of antimicrobial substances. Probiotic bacteria can also potentiate the immune response to intestinal pathogens.

There is also strong evidence that probiotic strains can prevent traveller's diarrhoea (Hilton et al., 1997). Traveller's diarrhoea is caused by bacteria, particularly enterotoxigenic *E. coli*. Several studies have been carried out to assess the effects of probiotic preparations as prophylaxis for traveller's diarrhoea; however, the results have been conflicting. In one study, Danish tourists on a 2-week trip to Egypt, were given a mixture of live freeze-dried preparation of *Lb. acidophilus*, *B. animalis*, *Lb. delbrueckii* ssp. *bulgaricus* and *Str. thermophilus* at a daily dose of  $10^9$  cfu. The administration of probiotic preparation reduced the frequency of diarrhoea. A similar study conducted with Finnish tourists using lyophilized preparation of *Lactobacillus* GG has shown to reduce the occurrence of traveler's diarrhoea.

Yogurt containing *B. longum* was found to be effective in reducing the course of erythromycin induced diarrhoea. Antibiotic treatment disturbs the balance of gastrointestinal flora leading to diarrhoea. Fecal counts of *Lactobacillus* GG indicated that the organisms colonized the intestine despite erythromycin treatment. Probiotic reparations containing  $4 \times 10^9$  *B. animalis* Bb-12 and *Lb. acidophilus* La-5 has shown similar results when volunteers received ampicillin along with probiotic preparation. Recolonization with bifidobacteria as shown by an increase in their counts is reported with treatment with *Lb. acidophilus* La-5 and *B. animalis* Bb-12. A lower degree of colonization by *Clostridium difficile* was also observed. Several studies have shown reduction in diarrhoea in subjects taking *Sacch. cerevisiae* Boulardii during the period of antibiotic treatment.



## IMPROVEMENT IN LACTOSE METABOLISM

Relief of lactose maldigestion symptoms by probiotics is probably the most widely accepted health benefits of probiotic organisms. Lactose malabsorption is a condition in which lactose, the principal carbohydrate of milk, is not completely hydrolysed into its component monosaccharides, glucose and galactose. Since lactose is cleaved into its constituent monosaccharides by the enzyme  $\beta$ -D-galactosidase, lactose malabsorption results from a deficiency of this enzyme. Lactose malabsorbers often complain of "gastric distress" after consuming fresh, unfermented milk or milk products due to the formation of hydrogen gas by microbial action on undigested lactose in the gut. The prevalence of lactose malabsorption varies depending on the ethnic origin of the population. It is common in China, Thailand, Japan, and African and Australian aborigines, but less common among Caucasians. Temporary deficiency of  $\beta$ -D-galactosidase occurs in people suffering from diarrhea (Shah, 1993; Shah et al., 1992).

The traditional cultures used in making yogurt (i.e., *Lb. delbrueckii* ssp. *bulgaricus* and *Str. thermophilus*) contain substantial quantities of  $\beta$ -D-galactosidase as compared with probiotic organisms, and the consumption of yogurt has been found to assist in alleviating the symptoms of lactose malabsorption (Shah, 2000b).  $\beta$ -D-galactosidase is affected by bile. Because bifidobacteria are resistant to bile, they may have a better chance of colonizing the gut and delivering this enzyme to its site of action over an extended period of time.

There is convincing evidence that lactose malabsorbers suffer fewer symptoms with fermented dairy products. Yogurt or probiotic yogurt is tolerated well by lactose malabsorbers. Factors other than the presence of yogurt starter or probiotic bacteria are responsible for better tolerance of lactose in lactose maldigesters from fermented dairy foods. Reduced levels of lactose in fermented products due to partial hydrolysis of lactose during fermentation is partly responsible for greater tolerance of yogurt. Auto-digestion of lactose intracellularly by bacterial  $\beta$ -D-galactosidase before reaching the intestine is an important factor that improves digestibility of lactose (Onwulata et al., 1989). Slower gastric emptying of semisolid milk products such as yogurt is another factor responsible for better absorption of lactose. Because of slower gastric emptying, small quantity of lactose is reached in the jejunum at a time and there is more effective hydrolysis of lactose by indigenous

$\beta$ -galactosidase located in the sides and tips of the villi of the jejunum. Regular yogurt appears to be more effective than either pasteurized yogurt or buttermilk. Pasteurized yogurt is also tolerated well due to slower gastric emptying as the enzyme activity and starter bacteria are destroyed due to heat treatment (Shah et al., 1992).

McDonough et al. (1987) reported that the presence of bacterial-derived  $\beta$ -galactosidase in yogurt contributes to the *in vivo* degradation of lactose. Significantly lower breath hydrogen levels were reported to produce following consumption of yogurt compared with milk or heated yogurt (Savaiano et al., 1984). A French group confirmed that viable cultures reached the duodenum and contained active  $\beta$ -galactosidase. The group confirmed the role of slow gastric emptying of semisolid milk foods in digestion of lactose in milk (Vesa et al., 1996).

Although, there are limited studies conducted on the efficacy of bifidus products in management of lactose malabsorption, the effects of acidophilus milk in alleviation of lactose malabsorption have been thoroughly researched (Gilliland, 1989; 1991).

## ANTIMUTAGENIC PROPERTIES

Antimutagenic effect of fermented milks has been detected against a range of mutagens and promutagens including 4-nitroquinoline-N'-oxide, 2-nitrofluorene, and benzopyrene in various test systems based on microbial and mammalian cells. However, antimutagenic effect might depend on an interaction between milk components and the lactic acid bacteria. The mechanism of antimutagenicity of probiotic bacteria has not been clearly understood. It has been suggested that microbial binding of mutagens to the cell surface could be a possible mechanism of antimutagenicity (Orrhage et al., 1994). Probiotic strains have been associated with a reduction in fecal enzymatic activities. A decrease in fecal and urinary mutagenicity as a result of consumption of *Lb. acidophilus* NCFB 1748 has been reported. *Lactococcus* spp. was ineffective. Similarly, reduction in fecal enzymatic activities including  $\beta$ -glucuronidase, azoreductase, and nitroreductase involved in mutagens activation with strains of probiotics has been reported (Goldin and Gorbach, 1977; 1984).

Lankaputhra and Shah (1998) studied the antimutagenic activity of organic acids produced by probiotic bacteria against eight mutagens and promutagens including 2-nitrofluorene (NF),

Aflatoxin-B (AFTB), and 2-amino-3-methyl-3H-imidazoquinoline (AMIQ). AFTB is a diet-related potent mutagen produced by a fungal strain of *Aspergillus flavus*, which is a major food contaminant species prevalent in most Asian countries. AMIQ is a heterocyclic amine mutagen. This is a major mutagen formed in heat-processed beef in Western diets. The TA-100 mutant of *Salmonella typhimurium* (His<sup>-</sup>) strain is used as a mutagenicity indicator organism. The mutagenicity test is carried out using the Ames Salmonella test. Among the organic acids, butyric acid showed a broad-spectrum antimutagenic activity against all mutagens or promutagens studied. Live bacterial cells showed higher antimutagenicity than killed cells against the mutagens studied. This suggests that live bacterial cells are likely to metabolize mutagens. Inhibition of mutagens and promutagens by probiotic bacteria appeared to be permanent for live cells and temporary for killed cells. Killed cells released mutagens and promutagens when extracted with dimethyl-sulfoxide suggesting binding of mutagens to bacterial cells. The results emphasized the importance of consuming live probiotic bacteria and of maintaining their viability in the intestine to provide efficient inhibition of mutagens.

### ANTICARCINOGENIC PROPERTIES

There are several factors responsible for causes of colorectal cancer including bacteria and metabolic products such as genotoxic compounds (nitrosamine, heterocyclic amines, phenolic compounds, and ammonia). The consumption of cooked red meat especially barbequed meat and low consumption of fiber are reported to play a major role in causing colorectal cancer. The colonic flora has been shown to be involved in colonic carcinogenesis. This effect is mediated by microbial enzymes such as  $\beta$ -glucuronidase, azoreductase, and nitroreductase, which convert procarcinogens into carcinogens. Lactic acid bacteria and fermented products have potential anticarcinogenic activity and an inverse relationship between consumption of fermented dairy foods and the risk of colorectal cancer has been found. Lactic acid bacteria suppress bacterial enzymes such as  $\beta$ -glucuronidase, azoreductase, and nitroreductase, and reduce intestinal pH.

Experiments carried out in animal models showed that certain strains of *Lb. acidophilus* and *Bifidobacterium* spp. are able to decrease the levels of enzymes such as  $\beta$ -glucuronidase, azoreductase, and nitroreductase responsible for activation of procar-

cinogens and consequently decrease the risk of tumor development. Several studies have shown that preparation containing lactic acid bacteria inhibit the growth of tumor cells in experimental animals or indirectly lower carcinogenicity by decreasing bacterial enzymes that activate carcinogenesis (Yoon et al., 2000). Animal studies using chemical carcinogen 1,2-dimethyl hydrazine (DMH) have been carried out. DMH is activated in the large intestine by  $\beta$ -glucuronidase. Addition of *Lactobacillus* to the diet has been reported to delay tumor formation. In human studies indirect evidence of potential benefits of probiotics have been obtained by monitoring mutagenic activity of human intestinal contents and feces. *Lb. acidophilus* 1748 and *Lb. casei* are reported to decrease mutagenic activity in feces caused by fried beef (Lidbeck et al., 1991).

Short chain fatty acids produced by *Lb. acidophilus* and bifidobacteria are reported to inhibit the generation of carcinogenic products by reducing enzyme activities. When incubated *in vitro* with 4-nitroquinoline-1-oxide (4NQO), some probiotic strains inhibited the genotoxic activity of 4NQO. *Lb. casei* was most effective, followed by *Lb. plantarum* and *Lb. rhamnosus*. Some strains of *Lb. acidophilus* and *Lb. delbrueckii* ssp. *bulgaricus* were not as effective (Cenci et al., 2002).

The anticarcinogenic effect of probiotic bacteria is reported to be due to the result of removal of sources of procarcinogens or the enzymes, which lead to their formation. The proposed mechanisms include improvement in the balance of intestinal microflora, normalized intestinal permeability (leading to prevention or delaying of toxin absorption), and strengthening of intestinal barrier mechanisms. Mechanism of anticarcinogenicity also involves activation of nonspecific cellular factors such as macrophages and natural killer cells via regulation of  $\gamma$ -interferon production. Orally administered bifidobacteria are also reported to play a role in the increasing of production of IgA antibodies and functions of Peyer's patch cells (Singh et al., 1997).

### REDUCTION IN SERUM CHOLESTEROL

There is a high correlation between dietary saturated fat or cholesterol intake and serum cholesterol level. The level of serum cholesterol is a major factor for coronary heart diseases. Elevated levels of serum cholesterol, particularly LDL-cholesterol have been linked to an increased risk for cardiovascular disease. Feeding of fermented milks containing very large

numbers of probiotic bacteria ( $\sim 10^9$  bacteria/g) to hypercholesterolemic human subjects has resulted in lowering cholesterol from 3.0 to 1.5 g/liter. The role of probiotic bacteria in reducing the serum cholesterol is not completely understood. Mann and Spoerry (1974) observed a decrease in serum cholesterol levels in men fed large quantities (8.33 liter/man/day) of milk fermented with *Lactobacillus*, possibly because of the production of hydroxymethyl-glutarate by probiotic bacteria, which is reported to inhibit hydroxymethylglutaryl-CoA reductases required for the synthesis of cholesterol.

Probiotic bacteria are reported to deconjugate bile salts. The deconjugated bile acid does not absorb lipid as readily as conjugated counterpart, leading to a reduction in cholesterol level. *Lb. acidophilus* is also reported to take up cholesterol during growth and this makes it unavailable for absorption into the blood stream (Klaver and Meer, 1993). A lower serum cholesterol concentration in rats fed with fermented milk containing *Lb. acidophilus* and bifidobacteria has been observed.

Despite several studies, the reduction in serum cholesterol effect is still not considered an established effect and double-blinded placebo-controlled human clinical trials are needed to substantiate this claim. Similarly, mechanisms involved in reducing cholesterol level need to be clarified.

## HELICOBACTER PYLORI INFECTION

*Helicobacter pylori* is a pathogenic bacterium, which causes peptic ulcers, type B gastritis, and chronic gastritis. *H. pylori* is present in the stomach as an opportunistic pathogen without causing any symptoms (Armuzzi et al., 2001; Sakamoto et al., 2001).

Antibiotic treatments can successfully eradicate *H. pylori*. However, antibiotics often cause side effects and make the bacteria more antibiotic resistant. Probiotic organisms do not appear to eradicate *H. pylori*, but they are able to reduce the bacterial load in patients infected with *H. pylori*. *Lb. johnsonii* La1 and *Lb. gasseri* OLL2716 have been found to reduce *H. pylori* colonization and inflammation (Felley et al., 2001). Similarly, *Lb. casei* Shirota, and *Lb. acidophilus* are able to inhibit the growth of *H. pylori*. In an intervention study, 14 patients infected with *H. pylori* received *Lb. casei* Shirota ( $2 \times 10^{10}$  cfu/day) fermented milk for 6 weeks. *H. pylori* bacterial load was assessed by the breath urea test. Ureolytic activity was reduced in 64% of the patients that

consumed fermented products containing probiotics, compared to 33% of the control group (Cats et al., 2003).

## INFLAMMATORY BOWEL DISEASE

Inflammatory bowel disease (ulcerative colitis and Crohn's disease) is related to the intestinal microflora. Inflammatory bowel disease affects up to 2 million people worldwide. Symptoms of inflammatory bowel disease include a disturbance in bowel habits and mucosal inflammation. In the intestine of people with inflammatory bowel disease, the number of *Lactobacillus* and *Bifidobacterium* is lower, and that of cocci and anaerobes are higher. Probiotics do not cure the disease. However, once patients are in remission through treatment with corticosteroids, some probiotics can prolong the remission, thus reducing the relapses and the use of corticosteroids. This improves the quality of life of patients.

## IMMUNE SYSTEM STIMULATION

The intestine is body's largest immune organ and the intestinal microflora and the metabolic activity of intestine is equivalent to that of the liver. Probiotics may directly or indirectly (by changing the composition or activity of the intestinal microflora) influence the body's immune function (Marreau et al., 1997). Yogurt and probiotic cultures produce  $\gamma$ -interferon by T-cells. Probiotics also stimulate cytokines as represented by TNF- $\alpha$  (tumor necrosis factor), and IL-6 and IL-10 (interleukines 6 or 10). Immunomodulation by *L. acidophilus* and bifidobacteria, in particular IgA levels and the nonspecific immunity has been observed. It is important to note that probiotics may not necessarily provide changes to immune system of healthy subjects. The mechanism for immunomodulation is not clearly understood. Translocation of small number of ingested bacteria via M cells to the Peyer's patches of the gut associated lymphoid tissue in the small intestine is claimed to be responsible for enhancing immunity. Ingestion of probiotic yogurt has been reported to stimulate cytokine production in blood cells and enhance the activities of macrophages.

## CONCLUSIONS

Probiotic products containing *Lb. acidophilus*, *Bifidobacterium* spp. and *Lb. casei* are becoming increasingly popular. Other probiotic organisms including

*Ent. faecium*, *Sacch. cerevisiae* Boulardii and *Propionibacterium* have a potential to be used in probiotic products. Several health benefits have been claimed for probiotic bacteria; however, not all probiotic bacteria are effective in providing health benefits. Proper strain selection and assessment of health benefits should be carried out before incorporating these strains for providing health benefits.

## REFERENCES

- Armuzzi A, Cremonini F, Bartolozzi F, Canducci F, Candelli M, Ojetti V, Cammarota G, Anti M, De Lorenzo A, Pola P, Gasbarrini G, Gasbarrini A. 2001. The effect of oral administration of *Lactobacillus* GG on antibiotic-associated gastrointestinal side-effects during *Helicobacter pylori* eradication therapy. *Aliment Pharmacol. Therapy* 15(2):163–169.
- Cats A, Kulpers EJ, Bosschaert MA, Pot RG, Vandenbroucke-Gauls CM, Kusters JG. 2003. Effect of frequent consumption of *Lactobacillus casei*—containing milk drink in *Helicobacter pylori*—colonised subjects. *Aliment. Pharmacol. Therapy* 17(3):429–35.
- Cenci G, Rossi J, Throtta F, Caldini G. 2002. Lactic acid bacteria isolated from dairy products inhibit genotoxic effect of 4-nitroquinoline-1—oxide in SOS-chromotest. *Syst. Appl. Microbiol.* 25(4): 483–90.
- Curry B, Crow V. 2003. *Lactobacillus* spp.: General characteristics. *Encyclopedia of Dairy Sciences*. Vol. 3. Academic Press, London, pp. 1479–1484.
- Dave R, Shah NP. 1996. Evaluation of media for selective enumeration of *S. thermophilus*, *L. delbrueckii* ssp. *bulgaricus*, *Lactobacillus acidophilus* and *Bifidobacterium* species. *J. Dairy Sci.* 79:1529–1536.
- Felley CP, Cortesy-Theulaz I, Rivero JL, Sipponen P, Kaufmann M, Bauerfeind P, Wiesel PH, Brassart D, Pfeifer A, Blum AL, Michetti P. 2001. Favourable effect of an acidified milk (LC-1) on *Helicobacter pylori* gastritis in man. *Eur. J. Gastroenterol. Hepatol.* 13:25–29.
- Fonden R, Mogensen G, Tanaka R, Salminen S. 2000. Effects of culture containing dairy products on intestinal microflora, human nutrition, and health—current knowledge and future perspective. *Bulletin of the International Dairy Federation*, No. 352. IDF, Brussels, Belgium.
- Gilliland SE. 1989. Acidophilus milk products: A review of potential benefits to consumers. *J. Dairy Sci.* 72:2483–2494.
- Gilliland SE. 1991. Therapeutic properties of yogurt. In: RK Robinson (Ed), *Therapeutic Properties of Fermented Milks*. Elsevier, London, pp. 65–80.
- Gilliland SE. 2003. Probiotics. *Encyclopedia of Food Science and Nutrition*, Vol. 8, Elsevier, London .
- Goldin BR, Gorbach SL. 1977. Alterations in faecal microflora enzymes related to diet, age, *Lactobacillus* supplement and dimethyl hydrazine. *Cancer* 40:2421–2426.
- Goldin BR, Gorbach SL. 1984. The effect of milk and *Lactobacillus* feeding on human intestinal bacterial enzyme activity. *Amer. J. Clin. Nutr.* 39:756–761.
- Gomes AMP, Malcata FX. 1999. *Bifidobacterium* spp. and *Lactobacillus acidophilus*: Biological, biochemical, technological and therapeutical properties relevant for use as probiotics. *Trends in Food Sci. Technol.* 10:139–157.
- Gopal PK. 2003. *Lactobacillus acidophilus*. *Encyclopedia of Dairy Sciences*, 3:1484–1488.
- Guandalini S, Pensabene L, Zikri MA, Dias JA, Casali LG, Hoekstra H, Kolacek S, Massar K, Micetic-Turk D, Papadopoulou A, de Sousa JS, Sandhu B, Szajewska H, Weizman Z. 2000. *Lactobacillus* GG administered in oral rehydration solution to children with acute diarrhoea: A multicenter European trial. *J. Pediatr. Gastroenterol. Nutr.* 30:54–60.
- Hilton E, Kolakowski P, Singer C, Smith M. 1997. Efficacy of *Lactobacillus* GG as a diarrhoeal preventive in Travellers. *J. Travel. Med.* 4:41–43.
- Holm F. 2003. Gut health and diet: The benefits of probiotic and prebiotics on human health. *The World of Ingredients.* 2:52–55.
- Klaver, FAM, Meer RVD. 1993. The assumed assimilation of cholesterol by lactobacilli and *Bifidobacterium bifidum* is due to their bile salt deconjugating activity. *Appl. Environ. Microbiol.* 59:1120–1124.
- Klein G, Pack A, Bonaparte C, Reuter G. 1998. Taxonomy and physiology of probiotic lactic acid bacteria. *Intern. J. Food Microbiol.* 41:103–125.
- Krishnakumar V, Gordon IR. 2001. Probiotics: Challenges and opportunities. *Dairy Ind. Inter.* 66(2):38–40.
- Kurmann JA, Rasic JL. 1991. The health potential of products containing bifidobacteria. In: RK Robinson (Ed), *Therapeutic Properties of Fermented Milks*. Elsevier Applied Science Publishers, London, pp. 117–157.
- Lankaputhra WEV, Shah NP. 1998. Antimutagenic properties of probiotic bacteria and of organic acids. *Mutation Research* 397:169–182.
- Lidbeck A, Geltner Allinger U, Orrhage KM, Ottova L, Brismar B, Gustaffson JAS, Rafter JJ, Nord CE. 1991. Impact of *L. acidophilus* supplements on the

- fecal microflora and soluble fecal bile acids in colon cancer patients. *Ecol. Health Dis.* 4:81–88.
- Mann GV, Spoerry A. 1974. Studies of a surfactant and cholesterolemia in the Massai. *Amer. J. Clin. Nutr.* 27:464–469.
- Marteau P, Vaerman JP, Bord JP, Brassart D, Pochart P, Desjeux JF, Rambaud JC. 1997. Effects of intrajejunal perfusion and chronic ingestion of *Lactobacillus johnsonii* strain LA1 on serum concentrations and jejunal secretions of immunoglobulins and serum proteins in healthy humans. *Gastroenterol. Clin. Biol.* 21:293–298.
- McDonough FE, Wong NP, Hitchens A, Bodwell CE. 1987. Alleviation of lactose malabsorption from sweet acidophilus milk. *Amer. J. Clin. Nutr.* 42:345–346.
- Mittal BJ, Garg SK. 1992. Acidophilus milk products: Manufacture and therapeutics. *Food Reviews Intern.* 8(3):347–389.
- Onwulata CI, Ramkishan Rao D, Vankineni P. 1989. Relative efficiency of yogurt, sweet acidophilus milk, hydrolysed-lactose milk, and a commercial lactase tablet in alleviating lactose maldigestion. *Amer. J. Clin. Nutr.* 49:1233–1237.
- Orrhage K, Sillerstrom E, Gustafsson JA, Nord CE, Rafter J. 1994. Binding of mutagenic heterocyclic amines by intestinal and lactic acid bacteria. *Mutation Research.* 311:239–248.
- Ouwehand AC, Kirjavainen PV, Shortt C, Salminen S. 1999. Probiotics: Mechanisms and established effects. *Intern. Dairy J.* 9:43–52.
- Playne MJ, Bennet LE, Smithers GW. 2003. Functional dairy foods and ingredients. *Aust. J. Dairy Technol.* 58(3):242–264.
- Saavedra JM, Bauman NA, Oung I, Perman JA, Yolken RH. 1994. Feeding of *Bifidobacterium bifidum* and *Streptococcus thermophilus* to infants in hospital for prevention of diarrhoea and shedding of rotavirus. *Lancet* 344:1046–1049.
- Sakamoto I, Igarashi M, Kimura T, Takagi A, Miwa T, Koga Y. 2001. *Helicobacter pylori* infections in humans. *J. Antimicrobiol. Chemother.* 47:709–710.
- Salminen S, Ouwehand AC. 2003. Probiotics, applications in dairy products. *Encyclopedia of Dairy Sciences*, Vol. 4, pp. 2315–2322.
- Savaiano DA, ElAnouar AA, Smith DJ, Levitt MD. 1984. Lactose malabsorption from yogurt, pasteurized yogurt, sweet acidophilus milk, and cultured milk in lactase-deficient individuals. *Amer. J. Clin. Nutr.* 40:1219–1223.
- Sgorbati B, Biavati B, Palenzona D. 1995. 'The genus *Bifidobacterium*'. In: *BJB Wood, Holzapfel (Eds), The Lactic Acid Bacteria*, Vol. 2: The genera of lactic acid bacteria. pp. 279–306, Blackie Academic, London.
- Shah NP. 1993. Effectiveness of dairy products in alleviation of lactose intolerance. *Food Aust.* 45:268–271.
- Shah NP. 1997. Bifidobacteria: Characteristics and potential for application in fermented milk products. *Milchwissenschaft* 52(1):16–21.
- Shah NP. 1999. Probiotic bacteria: Antimicrobial and antimutagenic properties. *Probiotica* 6:1–3.
- Shah NP. 2000a. Probiotic bacteria: Selective enumeration and survival in dairy foods. *J. Dairy Sci.* 83:894–907.
- Shah NP. 2000b. Some beneficial effects of probiotic bacteria. *Biosci. Micro.* 19(2):99–106.
- Shah NP. 2002. *Bifidobacterium* spp.: Applications in fermented milks. *Encyclopedia of Dairy Science*, Academic Press, London, pp. 147–151.
- Shah NP, Fedorak RN, Jelen P. 1992. Food consistency effects of quarg in lactose absorption by lactose intolerant individuals. *Intern. Dairy J.* 2:257–269.
- Shah NP, Lankaputhra WEV. 2002. *Bifidobacterium* spp.: Morphology and Physiology. *Encyclopedia of Dairy Science*, Academic Press, London, pp. 141–146.
- Singh J, Rivenson A, Tomita M, Shimamura S, Ishibashi N, Reddy BS. 1997. *Bifidobacterium longum* and *Lactobacillus acidophilus* producing intestinal bacteria inhibits colon cancer and modulates the intermediate biomarkers of colon carcinogenesis. *Carcinogenesis* 18(4):833–841.
- Stiles ME, Holzapfel WH. 1997. Lactic acid bacteria of foods and their current taxonomy. *Intern. J. Food Microbiol.* 36:1–29.
- Tharmaraj N, Shah NP. 2003. Selective enumeration of *Lactobacillus delbrueckii* ssp. *bulgaricus*, *Streptococcus thermophilus*, *Lactobacillus acidophilus*, bifidobacteria, *Lactobacillus casei*, *Lactobacillus rhamnosus* and Propionibacteria. *J. Dairy Sci.* 86:2288–2296.
- Vesa TH, Marteau P, Zidi S, Pochart P, Rambaud JC. 1996. Digestion and tolerance of lactose from yoghurt and different semi-solid fermented dairy products containing *L. acidophilus* and bifidobacteria in lactose maldigesters. Is Bacterial Lactase Important? *Eur. J. Clin. Nutr.* 50:730–733.
- Yoon H, Benamouzig R, Little J, Francois-Collange M, Tome D. 2000. Systematic review of epidemiological studies on meat, dairy products, and egg consumption and risk of colorectal adenomas. *Eur. J. Cancer Prev.* 9:151–164.

# Index

- acceptance testing, 126
  - “just right” scaling, 126
  - hedonic scale, 126
- Acetobacter* spp. 301
- acidity, 121. *See also* pH
  - apparent, 121
  - developed, 121
  - real, 121
  - titratable, 121, 182, 198,
  - total, 121
- acidophilus milk, 295, 296, 303, 304
  - history, 303
  - microbiology, 305
  - production of sweet acidophilus milk, 304
- acidulants for fruit preparations, 159
- adulteration, 14
- affective test, 268, 269
  - focus group, 269, 270
  - just right intensity, 274
  - nine-point hedonic scale, 270
- agitation, 15
- agitation of mix, 288
- analysis, 117
  - antimicrobial substances, 125
  - brilliant black reduction test, 125
  - delvotest, 125
  - immunoassays, 125
  - reference method, 125
- analytical tests, 268
- anticarcinogenesis, 322
- antimicrobial substances, 125
- aseptic packaging, 146–147
- Bacillus stearothermophilus*, 125
- bactofugation, 9, 10
- bacteriophages, 90
  - characteristics, 96
  - control of, 96–98
  - effect on cultured product, 90
  - resistance mechanisms, 97–98
  - starters, 90, 95
  - types of, 96
- balance tank, 20
- basic dairy processing principles, 73–88
- batch blending system, 8
- batch pasteurization, 8
- batch processes, 19
- beneficial microflora, 319
- bifidobacterium, 203, 344
  - isolation and enumeration, 344
- Bifidobacterium* spp. 296, 305
- bioactive dairy ingredients, 312
- bioactive peptides, 316, 317
- boiling point, 38
- booster pump, 21
- brix, 159, 160, 165
- buffering capacity, 32
- bulgarian milk/buttermilk, 296, 306
- buttermilk, 329
- buttermilk, cultured, 279–284
- buttermilk powder, 172
- buttermilk sales trend, 11
- Candida* spp. 301
- casein fractions, 23, 314
- caseinates, 174
- catalase, 89
- category scale, 270
- cavitation, 3
- centrifugal, 4
- chakka, 14
- chemical tests, 122
  - flavorful substances, 122
  - free fatty acids, 122
- cholesterol, 20
  - cirtate-fermenting bacteria, 125
- clarification, 9
- cleaning, 43, 45
- code dating, 68

- Code of Federal Regulations, 57
  - State preemption, 62
- Codex standards, 68
  - fermented milks, 68
    - additives, 70
    - composition, 69
    - cultures, 69
- cold separation, 18
- coliform bacteria, 124
- colligative properties, 38
  - boiling point, 38
  - freezing point, 38
  - osmotic pressure, 38
- color, milk, 31
- colors, 158, 165
- Committee on Sensory Evaluation of Dairy Products of ADSA, 127
- composition and specifications of dairy ingredients, 167–168
- compositional, 117
  - acidity, titratable, 121
  - fat, 118
  - lactose, 120
  - moisture, 119
  - protein, 120
  - solids, 119
- concurrent, 7
- condensed milk, 172, 181
- contents, v
- continuous mixing systems, 9
- continuous pasteurization, 19
- contributors, vii
- cooling, 6, 43, 44, 46, 286
- countercurrent, 7
- cream, 170
- cream separation, 9
- culture bacteria, 125
- culture containing milks, 295–310
- cultured buttermilk, 279–284, 329
  - key steps in manufacture, 280
    - breaking, cooling and distribution, 282
    - buttermilk starter culture, 281
    - flavor, body and texture, 283
    - milk supply, 280
    - processing of milk, 281
    - sensory evaluation, 283
- cultured cream sales trend, 11
- cultured/sour cream, 285–294, 330
  - body and texture, 289
  - early history, 285
  - filled sour cream, 291
  - flavor defects, 290
  - manufacturing procedure, 288
  - present standards, 287
  - problems and corrections, 289
  - sour cream products, 290
- curd tension, 37
- dahi, 7, 14, 90, 99, 295, 329
  - history, 297
  - microbiology, 299–300
  - production, 298
  - quality, 299
- dairy foods production, United States, 5
- dairy ingredients, 167, 179
  - composition, 167, 180
  - origin, 179
  - performance in yogurt formulation, 168
- dairy processing principles, 73–87
  - overview of dairy processing equipment, 73
    - centrifugal operations, 81
    - centrifugal pump, 74
    - from farm to factory, 78
    - heat transfer operations, 75
    - homogenization, 84–86
    - membrane technology, 86–87
    - microbial transformation, 78
    - mixing operations, 76
    - positive displacement pump, 74–75
    - separation, 77
    - storage, raw milk, 79–80
    - thermal processing systems, 82–84
- density, 36, 122
- dermatitis, 322
- descriptive, 269
  - flavor profile, 269
  - panelist selection, 269
  - quantitative, 269
  - scale usage, 269
  - spectrum technique, 269
  - texture profiling, 274
  - training, 269
- descriptive analysis, 126
  - quantitative, 127
- diacetyl, 92, 103–105
- diarrhea, prevention, 322
- difference, 269
  - attribute, 269
  - paired comparison, 269
  - ranking, 269
- direct acidification, 287
- discrimination tests, 268
  - duo-trio, 268
  - triangle, 268
- drinkable yogurt, 270
- dual-stage, 23
- dye-binding, 120
- electrical conductivity, 34
- electrochemical properties, 33
- Elliker's lactic agar, 125
- Enterobacteriaceae*, 124
- equipment, 51
  - 3A sanitary standards, 52
- exopolysaccharide, 96, 106

- farm requirements, 43
  - barns, 43
  - milking, 43
  - milking equipment, 43
- fat free sour cream, 291
- fat globule size, 24
- fat globules, 170
- fat, tests for,
  - Babcock, 118
  - ether extraction, 118
  - Gerber, 118
  - Mojonnier, 118
    - Roese-Gottlieb, 118
- fermentation, 10, 89
- fermentation vessels, 285–288
- fermented dairy packaging materials, 129–150
- fermented milks, 68, 271, 327, 295–310, 328
  - additives, 70
  - composition, 69
  - consumption, 8
  - culture containing milks, 295–310
  - cultures, 7, 9, 69, 329
  - forms, 7
  - middle east, 1, 331
  - origin, 332
  - packaging, 143–145
  - Russia/eastern europe, 13, 330
  - Scandinavia, 12, 330
  - South Asia, 13, 330
  - world production, 6, 7
- filled sour cream, 291
- flavor defects, 290
- flavor, milk, 31
- flavor profile, 127
- flavorful substances, 122
- flavoring, 58, 59, 60, 63, 68
- flavors
  - fruit, 158
    - preparation, 158
    - vanilla, 158
- flow controller, 20
- flow diversion valve, 21
- foaming, 37
- food additives, 62, 70
- Food and Drug Administration, 155, 159–160, 162, 190, 229, 230, 235, 247–248
- fortification, 323
- free-choice profile, 127
- free fatty acids, 122
- freezing point, 14, 38
- fruit preparation, 151–166
  - acidulants, 159
    - banana, 154
    - blueberries, 153
    - cherry, 154
    - flavors, 161
  - formulation, 154
    - high intensity sweeteners, 155
      - organic, 154, 160
    - packaging, 164
    - peaches, 153
    - pectin, 157
    - preservatives, 159
    - processing, 160
      - aseptic process, 163
      - hot kettle process, 162
    - quality checks, 165
    - raspberries, 153
    - raw materials, 152
    - specifications, 155
    - stabilizers, 156
    - strawberries, 153
    - sweeteners, 155
- functional foods/disease prevention, 311–326
  - beneficial microflora, 319
  - bioactive dairy ingredients, 312, 316
  - bioactive peptides, 317
  - casein fractions, 314
  - lactose, 317, 333
  - lactose malabsorption, 335
  - milk fat, 317, 334
  - milk proteins, 313, 333
    - nutritional value, 315
  - nutritional profile of yogurt, 314
  - physiological effects, 316, 336
  - probiotics, 318
    - anticarcinogenesis, 322, 336
    - calcium, 321
    - fortification, 323
    - health benefits, 319
    - immunomodulatory role, 322, 338
    - manufacture, 322
    - mode of action, 321
    - physiological effects, 336
    - physiologically active ingredients, 324
    - prevention of diarrhea, vaginitis, dermatitis, 322
      - production of enzymes and vitamins, 320
      - reduction in serum cholesterol, 337
    - whey proteins, 314
- functional properties of milk constituents, 316
  - gelatin, 190
  - Geotrichum candidum, 92, 301, 306
  - Grade “A” PMO, 42, 57
    - labeling, 48
    - standards, 49, 50, 51
  - grading, 265
    - USDA quality approval rating, 265, 266
- HACCP, 47
  - prerequisite program, 47
- Health Attributes of Yogurt and Fermented Milks, 327–340. *See also* health benefits



- health benefits, 309, 319, 331, 347, 311–354  
 anticarcinogenic, 351  
 antimutagenic, 350  
 beneficial effects, 333  
 bioyogurt, 339  
*Helicobacter pylori* infection, 352  
 immune system stimulation, 352  
 irritable bowel disease, 352  
 kefir, 338  
 lactose metabolism, 333, 350  
 nordic fermented milks, 338  
 nutritional value, 331  
 reduction in serum cholesterol, 351
- heat effects/stability, 34, 35  
 heat exchanger, 7  
 heating, 6  
 heterofermentative, 11  
 High Temperature Short Time Pasteurization (HTST),  
 19
- history and consumption trends, 3  
 holding tube, 21  
 homofermentative, 11  
 homogenization, 16, 171, 221, 287–289  
 homogenizer, 23  
 homogenizer valve, 24  
 HPLC method, 121
- imitation sour cream, 290  
 immunomodulatory role, 322  
 index, 355  
 infrared method, 118  
 ingredients, 179  
 acesulfame-K, 189  
 aspartame, 156, 188  
 condensed skim milk, 181  
 dairy, 167, 179  
 composition, 180  
 gelatin, 190  
 gums and pectins, 192  
 milk protein concentrate/ultrafiltered milk, 183  
 neotame, 189  
 nonfat dry milk, 181  
 saccharin, 189  
 stabilizers, 190, 191  
 starch, 191  
 sucralose, 189  
 sweeteners  
 corn, 184  
 high intensity, 156, 188  
 nutritive, 184  
 whey solids, 182  
 yogurt manufacture, 179–194
- in-line standardization, 18  
 international dairy federation, 119, 125  
 international standards, 68  
 interstate commerce, 62
- judging, 265, 266
- kefir, 9, 13, 92, 113, 295–296, 330  
 description, 301  
 grains, 296, 301–302  
 history, 300  
 microbiology, 301, 302  
 production, 298–300  
 quality, 301
- keldermilk, 12  
 kishk, 13  
 kosher, 67
- koumiss, 9, 13, 92, 93, 295–296, 330  
 description, 303  
 history, 302  
 microbiology, 303  
 production, 303  
 quality, 305
- laban, 331  
 laban rayeb, 13
- labeling, 62, 249  
 flavors, 63  
 information panel, 63  
 ingredients, 64  
 nomenclature, 58–61  
 nutrient claims, 251  
 nutrition, 65  
 daily reference values, 65, 250  
 format, 67  
 principal display panel, 62  
 serving size, 65  
 standard of identity, 63
- labneh, 7, 13, 270, 271
- laboratory analysis of fermented milks, 117–128
- lactic acid bacteria, 10  
 lactic acid bacteria, 125
- lactic acid bacteria, taxonomy, 341
- Lactobacillus*, 108, 125, 296, 301, 305, 344  
*acidophilus*, 109, 110, 296, 303, 304, 305  
*brevis*, 301  
*casei* subsp. *casei*, 99  
*delbrueckii* subsp. *bulgaricus*, 94, 99, 108,  
 109  
 subsp. *lactis*, 99  
*helveticus*, 99, 306  
*kefir*, 301  
*kefirifaciens*, 301
- Lactococcus*, 99, 121, 125, 301  
*lactis*, 92  
 subsp. *cremoris*, 94, 99, 307  
 subsp. *lactis*, 94, 99  
 subsp. *lactis* (Cit+), 92, 93, 99, 106
- lactose, 27, 28, 29, 317, 333  
 $\alpha$ -lactose, 28  
 $\beta$ -lactose, 28

- lactose, tests for, 120
  - HPLC method, 121
  - polarimetric method, 12
- langfil, 12
- lassi, 14
- Leuconostoc*, 106, 125, 301
- line scale, 270
- lipolysis, 15
- Listeria monocytogenes*, 94
- Long Time Low Temperature (LTLT), 19
- low fat sour cream, 290
  
- MacConkey glucose agar, 124
- manufacture of various types of yogurt, 211–236. *See also* yogurt, manufacture
- mastitis, 14
- membrane fouling, 26
- membrane technology, 25
- mesophilic microorganisms, 12
- microbiological tests, 124, 165. *See also* analysis
- microfiltration (MF), 25
- microorganisms, 10
- microscope view of cultures, 108, 109, 110,
  - bifidobacteria, 203
  - Lactobacillus acidophilus*, 110, 202
  - Lactobacillus delbrueckii* spp. *bulgaricus*, 109, 201
  - Streptococcus thermophilus*, 108, 200
  - yogurt culture, 109, 197
- milk, 2, 167
  - composition, 8, 18, 168, 170
    - breed, 170
    - camel, 8
    - constituents, 19
    - donkey, 8
    - genetic variant, 17
    - goat, 8
    - mare, 8
    - season, 170
    - sheep, 8
    - species, 168
    - yak, 8
  - composition, physical and processing characteristics, 17
  - definition, 17
  - functional properties, 316
  - minor constituents, 30
  - nutritional composition, 313
  - physical characteristics, 31
  - physical structure, 18–19
- milk and milk based dairy ingredients, 167–178
- milk enzymes, 26
  - alkaline phosphates, 26
  - lactoperoxidase, 26
  - lipoprotein lipase, 26
  - lysozyme, 26
  - plasmin, 26
  - protease, 26
- milk fat, 19, 317
  - fatty acid profile, 20
- milk fat globule, 20, 21
  - membrane, 21, 22
  - size distribution, 21
- milk powder, 167
  - composition, 167
  - high heat, 168
  - low heat, 168
  - medium heat, 168
  - whey protein nitrogen index, 167
- milk pricing, 52
  - classification, 54
  - component, 52
  - producer, 53
- milk production, 3
  - United States, 3, 4
  - world, 3, 4, 8
- milk protein concentrates, 172, 183
- milk proteins, 22, 23, 313, 314, 333, 334
  - biologically active, 26
  - caseins, 23, 313
  - composition, 23, 313
  - functional aspects, 27
  - isoelectric point, 24
  - nutritional value, 315
- milk safety, 41
  - history, 41
  - imports, 48
  - inspections, 42
    - check rating, 43
    - compliance ratings, 43
- milk transportation, 43, 47
  - delivery, 46
  - hauler, 43
  - shipping information, 43
  - trucks, 43
- minerals, 29, 318
  - partition in milk, 30
- mishti doi (dahi), 14
- mixing, 7
- Mycoderma* spp. 303
  
- nanofiltration (NF), 25
- National Conference on Interstate Milk Shipments, 42, 47, 49
- National Yogurt Association, 61, 67
- Newtonian fluids, 123
- nonfat dry milk, 181
  - composition, grade a, 182
  - heat treatment classification, 183
  - standards, 169, 182
- nonfat milk solids, 120
- nuclear magnetic resonance (NMR), 119

- nutritional function, 332
- nutritional profile of yogurt, 314
- nutritional value, 331, 333
  
- official methods of analysis, 119
- optical properties, 31
- organic, 160
- organoleptic, 165
- osmotic pressure, 38
- oxidation-reduction potential, 33
  
- package in product distribution, 139–140
- packaging, 45, 47, 62, 129–150
  - biodegradability, 143
  - definition, 130
  - distribution, 130
  - economics, 140
  - environment, 142
  - fundamentals, 130
  - future trends, 147–148
  - graphic design assessment, 140
  - graphics, 130
  - interactions with product, 137–139
  - primary, 130
  - recycling, 143
  - regulation, 141
  - secondary, 130
  - structural design, 130
  - technology, 130
- packaging for yogurt and fermented milks, 143
- packaging levels, 133
  - converters, 133
  - distributors, 134
  - equipment, 134
  - packagers, 134
  - packaging developments, 134–136
  - raw material suppliers, 133
  - resources available, 136–137
- packaging materials, 130
  - glass, 131
  - metal, 131
  - oxygen-barrier materials, 133
  - paper and paperboard, 131
  - plastic, 132, 212
  - polyester, 132
  - polyethylene, 132
- packaging sour cream, 286, 292
  - containers, 286, 288
  - hot packaging, 286
- paring disc, 17
- pasteurization, 19, 46, 59, 61
- Petrifilm®, 124
- pH, 32, 121, 196, 204–206, 222, 227, 228, 223, 231, 233, 234
  - indicator, 121
- phage infection protein, 97
- phage inhibitory media, 97
- phosphatase, 20
- phospholipids, 20
- physical properties of milk, 31, 122
  - acidity, titratable, 32
  - buffering capacity, 32
  - color, 31
  - density, 36, 122
  - electrical conductivity, 34
  - electrochemical, 33
  - flavor/off flavor, 31, 32, 33
  - oxidation-reduction potential, 33
  - refractivity, 31
  - rheological, 123
  - specific gravity, 122
  - tests, 122–124
  - thermal, 34
  - water-holding capacity, 123
- physiological effects, 309, 316, 336, 338, 351
  - anticancer effects, 336, 351
  - antimutagenic, 350
  - diarrhea, 320, 349
  - Helicobacter pylori* infection, 352
  - immune system stimulation, 338, 352
  - irritable bowel disease, 352
  - lactose metabolism, 350
  - reduction in serum cholesterol, 337, 351
- physiologically active ingredients, 324
- plasmids, 93–94
- plate heat exchangers, 12, 20
- Podoviridae*, 96
- polarimetric method, 121
- positive displacement, 4
- positive lobe, 5
- precipitation, 24
  - alcohol, 24
  - heat, 24
  - polyvalent ion, 24
- preface, ix
- preference mapping, 270
- preference testing, 126
- preservatives, 60, 62, 70, 159
- pressure differential meter, 22
- principles of yogurt processing, 195–210
- probiotic milks, 295, 305, 318, 341
  - history, 305
  - production, 305
  - quality, 305
- probiotics, 318, 319, 341, 343
  - health benefits, 319, 320, 347
  - manufacture, 322
  - mode of health benefits, 321
  - requirements for effective, 320
- probiotics and fermented milks, 341–354
  - beneficial effects of probiotics, 348. *See also* probiotics, health benefits

- anticarcinogenic, 351
  - antimicrobial activity, 348
  - antimutagenic, 350
  - diarrhea, effective against, 349
  - commercial probiotic strains, 347
  - genus bifidobacterium, 344–346
    - isolation and enumeration, 345
  - genus lactobacillus, 343, 346
    - isolation and enumeration, 344
  - immune system stimulation, 352
  - inflammatory bowel disease, 352
  - lactose intolerance, 350
  - Helicobacter pylori* infection, 352
  - physiological effects, 336
  - probiotic bacteria, 342
  - reduction in serum cholesterol, 351
  - selection criteria, 342–343
  - strains with peer reviewed clinical trials, 347
- processing plants, 44
  - construction, 44
  - equipment, 45
- processing principles, 2
- protein adsorption, 24
- protein tests, 120
  - dye-binding, 120
  - infrared analyzer, 120
  - Kjeldahl, 120
- proteins, minimum requirements, 315
  - nutritional values, 315
- Pseudomonas* spp. 93
- pumps, 3
- quality assurance, yogurt plant, 247
  - analytical tests, 254
  - daily reference values, 250
  - defects in yogurt and causes, 262–263
  - Food and Drug Administration, 247
  - food labeling, 249
  - nutrient claims, 251–253
  - nutrition facts label, 254
  - quality control programs, 255–256
    - compositional analysis, 258
    - criteria for live and active yogurt, NYA, 258–260
    - microbiological, 258
    - overrun, 258
    - quality tests, 257
    - sensory, 258
    - shelf life test, 258
    - viscosity, 258
  - regulatory obligations, 247
  - specification program, 260
    - process and product specification, 261
    - raw milk quality, 260
  - trouble shooting, 262–263
  - weight control, 263
- quality-based method, 267
- quality control, sensory tests for, 127
- raw milk, 6
- reagents
  - ammonium hydroxide, 118
  - ethanol, 118
  - isoamyl alcohol, 118
  - phenolphthalein, 121
  - sulfuric acid, 118
- Real Seal, 67
- reference method, 118
- reference samples/standards, 118, 120, 121, 127
- refractivity, 31
- refrigeration, 7, 21
- regulations for product standards and labeling, 57
- regulatory requirements for milk production, transportation and processing, 41
- rennet coagulation, 24
- rennet (use in sour cream), 285, 288
- representative sample, 13
- restriction-modification, 97
- reverse osmosis (RO), 25
- rheological tests, 123
  - apparent viscosity, 123
  - rupture stress, 123
  - stress/strain curve, 123
  - thixotropic fluids, 123
  - viscometer, 123
- sampling, 49
- sediment, 14
- sensory analysis of yogurt, 270
  - attributes and references, 272
  - judging criteria, 267
  - quality terms, 268
  - sensory analysis techniques, 265
  - sensory descriptors, 271
  - USDA quality guidelines, 266
- sensory evaluation, 265, 273
  - appearance, 267, 274
  - consistency, 267
  - flavor, 267, 273
  - odor, 273
  - taste, 273
  - texture, 274
- sensory tests, 126
  - acceptance testing, 126
  - basket's tables, 126
  - descriptive analysis, 126
  - flavor thresholds, 127
  - free-choice profiling, 127
  - in quality control, 127
  - preference testing, 126
  - procrustes analysis, 127

- separation, 9
- serum cholesterol reduction, 322
- shelf stable packaging, 145–146
  - aseptic packaging, 146
  - post-fill retorting, 145
- shrikhand, 7, 14
- silo, 15
- single service containers, 45, 48
- single-stage, 23
- Siphoviridae*, 96
- skyr, 7, 12, 297, 306, 331
- smoothing screen, 289
- solids, total, 119
  - forced-draft oven, 119
  - hot air oven, 119
  - infrared instrument, 119
  - microwave oven, 119
  - sand pan method, 119
- sour cream, 285–294
- sour cream cultures, 285, 287, 288
- sour cream history, 285, 286, 287
- soy milk yogurt, 273
- specific gravity, 36, 122
- spiral wound, 26
- stabilizers, 58, 60, 70, 190, 286, 287, 289
  - in yogurt, 191
  - pectin, 192
- Standard Methods for the Examination of Dairy Products, 118, 119, 120, 124, 125
- standardization, 16
- standards, 287, 290
- standards of identity, 57
  - cream, 58
  - cultured milk, 58
  - milk, 58
  - sour cream, 59
  - stayed provisions, 59
  - yogurt, 59
- starch, native/modified, 191
- starter culture
  - characteristics, 101, 102
  - definition of, 89
  - factors affecting, 90, 93–98
  - functions of, 90, 93, 100
  - miscellaneous, 113
  - production of, 112–113
  - types of, 96
  - yogurt and fermented milks, 89–116
- Stokes law, 21
- Streptococcus*, 106, 125
  - thermophilus, 94, 95, 106, 108
- surface activity, 37
- surface concentration of protein, 24
- sweet acidophilus milk
  - history, 303
  - microbiology, 305
  - production, 304
  - quality, 304
- sweeteners, 58, 59, 60, 184
  - high intensity, 188
    - acesulfame-K, 189
    - alitame, 190
    - aspartame, 188
    - cyclamates, 190
    - neotame, 189
    - saccharin, 189
    - stevia, 190
    - sucralose, 189
    - thaumatin, 190
  - nutritive, 184–188
    - corn sweeteners, 186–187
    - liquid sugar, 185
    - maltodextrins, 186
    - sucrose, 184
- tanker, 13
- temperature, 43, 44, 46, 50, 51
- testing body, 286
- tests, 118–127. *See also* analysis
- texture attributes, 271
  - nonoral viscosity, 271, 272
  - oral viscosity, 271, 273
- thermal processing, 19
- thermal properties, 34
- threshold, 269
- titratable acidity, 58, 59, 61, 121
- tubular, 26
- turbulence, 23
- ultrafiltered milk, 183
- ultrafiltration (UF), 25
- Universal Product Code, 68
- vaginitis, 322
- villi, 7, 12, 92, 93, 297, 331
  - history, 306
  - microbiology, 307
- violet red bile agar, 124
- viscometer, 123
- viscosity, 36, 123
- vitamins, 30, 318
- volumetric flow, 5
- volumetric flow meter, 15
- warm separation, 18
- water, 19
- water-holding capacity, 123
- whey, 51
  - solids, 182
- whey products, 173
  - microparticulated whey protein, 174

- whey powders, 173
- whey protein concentrates, 173
- whey proteins, 25, 314
  - bovine serum albumin, 25, 26, 314
  - denaturation, heat, 220
  - immunoglobulins, 25, 26, 314
  - $\alpha$ -lactalbumin, 25, 314
  - $\beta$ -lactoglobulin, 25, 314
  - proteose peptones, 25
- yakult, 330
  - yeast and mold counts, 124
- ymer, 7, 12, 331
- yogurt, 90, 270, 271, 274, 328
  - acidification, 167
  - bulk starter, 215
  - effect of processing on starter, 91
  - flavor, 167
  - formulation, 224
  - lactic agar, 125
  - manufacture, 149, 211–236
    - blended/swiss-style, 223
    - concentrated, greek, 232
    - custard, 226
    - drink/smoothies, 230, 231
    - french style, 226
    - frozen, 233
    - fruit-flavored, 223
    - heat-treated, 234, 235
    - light, 226
    - natural, 229
    - nutritional profile, 314
    - organic, 229, 230
    - plain, 223
    - plant cleaning and sanitizing, 237–246
    - sundae style/fruit on the bottom, 226, 227, 228
    - vanilla
    - whips/mousse, 231
  - yogurt: fruit preparations and flavoring materials, 151–166.
    - See also* fruit preparations
  - yogurt, manufacture of various types, 211–236
    - blended, 224
    - flow sheet diagram, 225
    - classification, 216
    - coagulation, 222
    - concentrated/strained yogurt, 232–233
    - cooling, 222
    - custard style, 226
    - french style, 226
    - frozen, 233–234
      - flow sheet diagram, 234
    - fruit flavored, 223
    - fruit on the bottom style, 228
    - general procedure for all yogurt types, 211
    - greek style, 232
    - light, 226
    - market, 214–219
    - natural yogurt, 229
    - organic, 229, 230
    - plain, 223
      - flow sheet diagram, 224
    - post culturing heat treatment, 234–235
    - processes, 220
    - pumping, 223
    - smoothies, drinks, 230–231
      - flow sheet diagram, 232
    - starter production, 212, 214
    - stirring, 223
    - styles and definitions, 214–217
    - sundae style, 226–227
    - vanilla flavored, 227
    - whips, mousse, 231
  - yogurt market, 10, 11
    - sales trends, 10, 218, 219
    - segmentation, 11
  - yogurt microstructure, 170, 176
    - fat globules, 170
  - yogurt packaging, 143–145, 212
  - yogurt: plant cleaning and sanitizing, 237–246
    - bacteriophage control, 244
    - CIP cleaning, 242
    - cleaning, 237
    - COP cleaning, 241
    - foam cleaning, 240
    - manual cleaning, 239
    - normal soils, 238
      - complex carbohydrates, 238
      - fat, 238
      - minerals, 239
      - proteins, 238
      - sugars, 238
    - phage control, 244
    - sanitizing, 243
    - special soils, 239
      - bacteriophage, 239
      - biofilms, 239
  - yogurt processing, principles of, 195–210
    - changes during processing, 206
      - carbohydrates, 206
      - cell mass, 207
      - flavor compounds, 206
      - lipids, 206
      - post-fermentation, 208
      - proteins, 206
      - vitamins, 207
    - coagulation, 222
    - cooling, 222
    - heat treatment, 195, 220
    - homogenization, 197, 221

- yogurt processing, principles of (*continued*)
  - mix preparation, 195
  - processing steps, 196, 220
  - starters for yogurt, 197–198
    - characteristics, 199
    - collaborative growth, 201
    - factors for growth, 198–199
    - inhibiting factors, 203
    - strain selection, 204
- yogurt properties, effect of milk
  - breed and genetic variants, 170
  - mammalian species, 168
  - milk powders, 171
  - seasonal variations in milk, 170
- yogurt: sensory analysis, 265
  - packaging, 211
  - statistics, 214, 215
  - styles and definition, 214, 216, 217
  - types of, 91, 13
- yogurt starters, production, 212
- yogurt texture, 167
  - homogenization, 171
- zabady, 13, 331