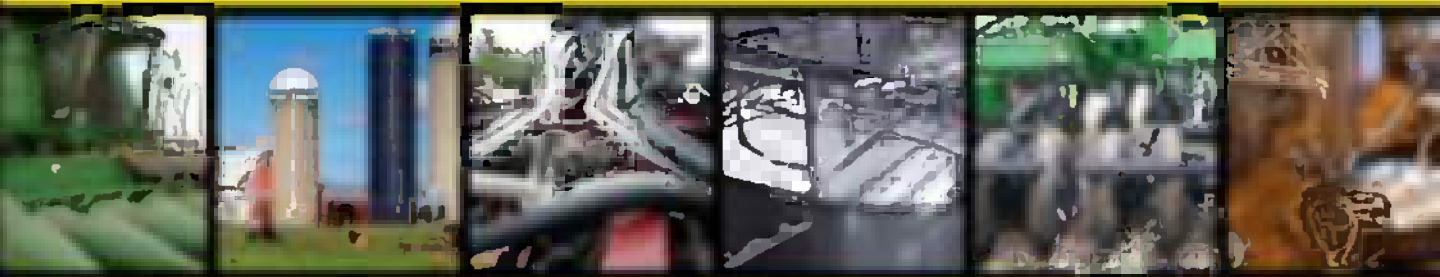




# **Handbook of Farm, Dairy and Food Machinery Engineering**

**Second Edition**



Edited by  
**Myer Kütz**



---

---

*Handbook of*  
**FARM, DAIRY AND  
FOOD MACHINERY  
ENGINEERING**

**SECOND EDITION**

---

This page intentionally left blank

---

---

*Handbook of*  
**FARM, DAIRY AND  
FOOD MACHINERY  
ENGINEERING**

**SECOND EDITION**

---

**MYER KUTZ**

*Myer Kutz Associates, Inc., Delmar, New York*



Amsterdam • Boston • Heidelberg • London • New York  
Oxford • Paris • San Diego • San Francisco  
Singapore • Sydney • Tokyo  
Academic Press is an imprint of Elsevier



Academic Press is an imprint of Elsevier  
32 Jamestown Road, London NW1 7BY, UK  
225 Wyman Street, Waltham, MA 02451, USA  
525 B Street, Suite 1800, San Diego, CA 92101-4495, USA

First edition 2010  
Second edition 2013

Copyright © 2013 Elsevier Inc. All rights reserved

No other part of this publication may be reproduced, stored in a retrieval system or transmitted in any form or by any means electronic, mechanical, photocopying, recording or otherwise without the prior written permission of the publisher

Permissions may be sought directly from Elsevier's Science & Technology Rights Department in Oxford, UK: phone (+44) (0) 1865 843830; fax (+44) (0) 1865 853333; email: [permissions@elsevier.com](mailto:permissions@elsevier.com). Alternatively, visit the Science and Technology Books website at [www.elsevierdirect.com/rights](http://www.elsevierdirect.com/rights) for further information

#### **Notice**

No responsibility is assumed by the publisher for any injury and/or damage to persons or property as a matter of products liability, negligence or otherwise, or from any use or operation of any methods, products, instructions or ideas contained in the material herein. Because of rapid advances in the medical sciences, in particular, independent verification of diagnoses and drug dosages should be made

#### **British Library Cataloguing-in-Publication Data**

A catalogue record for this book is available from the British Library

#### **Library of Congress Cataloging-in-Publication Data**

A catalog record for this book is available from the Library of Congress

ISBN: 978-0-12-385881-8

For information on all Academic Press publications  
visit our website at [elsevierdirect.com](http://elsevierdirect.com)

Typeset by MPS Limited, Chennai, India  
[www.adi-mps.com](http://www.adi-mps.com)

Printed in the United States of America

13 14 15 16 17 10 9 8 7 6 5 4 3 2 1



Working together  
to grow libraries in  
developing countries

[www.elsevier.com](http://www.elsevier.com) • [www.bookaid.org](http://www.bookaid.org)

*To Alan for all the good times at Ichiban*

This page intentionally left blank

# CONTENTS

<i>Preface to the Second Edition</i>	xv
<i>Preface to the First Edition</i>	xvii
<i>List of Contributors</i>	xxi
<b>1. The Food Engineer</b>	<b>1</b>
<b>Felix H. Barron</b>	
1. Nature of Work and Necessary Skills	1
2. Academic and Industry Preparation	2
3. Work Opportunities for a Food Engineer	5
4. Engineering Jobs	9
5. Future Opportunities	9
6. Conclusions	10
Reference	12
Further Reading	12
<b>2. Food Regulations</b>	<b>13</b>
<b>Kevin M. Keener</b>	
1. Background	13
2. Federal Register	14
3. Code of Federal Regulations	15
4. United States Code	15
5. State and Local Regulations	16
6. USDA—FSIS Sanitation Programs	16
7. FDA Sanitation Programs	18
8. Food Safety Modernization Act	20
9. Hazard Analyses and Critical Control Point Program (HACCP)	22
10. Meat Processing	24
11. Shell Eggs	26
12. Seafood Processing	27
13. Fruits, Vegetables, and Nuts	29
14. Beverages	30
15. Canned Foods	34
16. Food Service/Restaurants	35
17. Export Foods	35
18. Imported Foods	37
19. Conclusions	38
20. Acronyms	38
References	39



<b>3. Food Safety Engineering</b>	<b>43</b>
Raghupathy Ramaswamy, Juhee Ahn, V.M. Balasubramaniam, Luis Rodriguez Saona and Ahmed E. Yousef	
1. Introduction	43
2. Intervention Technologies	44
3. Control/Monitoring/Identification Techniques	52
4. Packaging Applications in Food Safety	57
5. Tracking and Traceability	58
6. Byproducts of Processing	59
7. Conclusions	61
Acknowledgment	61
References	61
<b>4. Farm Machinery Automation for Tillage, Planting Cultivation, and Harvesting</b>	<b>67</b>
Brian T. Adams	
1. Introduction	67
2. Vehicle Guidance	68
3. Implement Guidance Systems	75
4. Guidance Methods	75
5. Challenges Facing Autonomous Vehicles	81
6. Summary	83
References	84
Other Contacts	85
<b>5. Air Seeders for Conservation Tillage Crop Production</b>	<b>87</b>
John Nowatzki	
1. Opener Design Options	87
2. Managing Crop Residue	89
3. Soil Disturbance and Environmental Impacts	93
4. Seed/Fertilizer Placement, Row Spacing	94
5. Depth Control and Packing	97
6. Varying Conditions	98
7. Precision Agriculture	99
8. Energy Requirements	101
9. Commercial Options	101
Reference	101
Further Reading	101
<b>6. Grain Harvesting Machinery</b>	<b>103</b>
H. Mark Hanna and Graeme R. Quick	
1. General	103
2. History	103

3. Pre-Harvest Issues that Affect Machine Design	104
4. Performance Factors	105
5. Heads: Grain Platforms, Corn Heads, and Strippers	106
6. Feederhouse	109
7. Cylinder or Rotor and Concave	109
8. Separation: Straw Walkers or Rotary Separation	112
9. Cleaning Shoe	114
10. Elevators: Clean Grain and Tailings	116
11. Grain Bin and Unloading Auger	116
12. Other Attachments	118
13. Operator's Station, Adjustments, and Monitoring Systems	118
14. Field Performance	119
15. Grain Damage	120
16. Combine Trends	120
References	121
<b>7. Grain Storage Systems Design</b>	<b>123</b>
Ray Bucklin, Sid Thompson, Michael Montross and Ali Abdel-Hadi	
1. Materials	124
2. Drying	126
3. Structural Loads	132
4. Grain Handling	153
5. Testers for Measuring Flow Properties	165
References	171
<b>8. Milking Machines and Milking Parlors</b>	<b>177</b>
Douglas J. Reinemann	
1. Introduction	177
2. The Milking Machine	178
3. Milking Parlors	189
References	197
<b>9. Dairy Product Processing Equipment</b>	<b>199</b>
H. Douglas Goff	
1. Introduction	199
2. Clarification, Separation, and Standardization	200
3. Pasteurization	202
4. UHT Sterilization	208
5. Homogenization	209
6. Membrane Processing	211
7. Evaporation	212

8. Drying	213
9. Ice Cream Manufacturing Equipment	216
10. Butter Manufacturing Equipment	218
11. Cheese Manufacturing Equipment	219
References	220
<b>10. Grain Process Engineering</b>	<b>223</b>
Imran Ahmad and Athapol Noomhorm	
1. Drying	223
2. Pre-Storage Grain Treatments	228
3. Post-Harvest Value Addition	233
4. Cooking and Processing	239
5. Quality Evaluation	246
References	251
<b>11. Technology of Processing of Horticultural Crops</b>	<b>259</b>
Conrad O. Perera and Bronwen Smith	
1. Introduction	259
2. Properties of Fruits and Vegetables	261
3. Biological Deterioration and Control	269
4. Methods for Minimizing Deterioration	272
5. General Methods of Fruit and Vegetable Preservation	275
6. Some Important Methods of Processing of Fruits and Vegetables	282
7. Quality Control/Assurance	301
8. Fruit and Vegetable Processing Units	303
References	309
<b>12. Food Drying and Evaporation Processing Operations</b>	<b>317</b>
William L. Kerr	
1. Introduction	317
2. Water in Foods	317
3. Types of Water in Foods	319
4. Food Stability and Moisture Relationships	321
5. Drying: Describing the Process	323
6. Types of Dryers	329
7. Quality Changes During Drying	340
8. Evaporation	342
9. The Basic Evaporator	344
10. Tube Evaporators	345
11. Single Effect Evaporators	348
12. Multi-Effect Evaporators	350

13. Mechanical Vapor Recompression	351
14. Quality Changes During Evaporation	352
15. Conclusion	352
Further Reading	353
<b>13. Food Freezing Technology</b>	<b>355</b>
<b>Chenchaiiah Marella and Kasiviswanathan Muthukumarappan</b>	
1. Introduction	355
2. Freezing Point Depression	356
3. Freezing Process	356
4. Phase Change and Ice Crystal Formation	359
5. Product Heat Load	360
6. Freezing Time Estimations	361
7. Freezing Equipment	364
8. Effect of Freezing and Frozen Storage on Foods	372
9. Developments in Freezing Techniques	375
10. Energy Conservation in Freezing	376
11. Scope for Future Work	376
References	377
<b>14. Heat and Mass Transfer in Food Processing</b>	<b>379</b>
<b>Mohammed Farid</b>	
1. Basic Concepts of Heat and Mass Transfer	379
2. Case Study 1: Thermal Sterilization Using Computational Fluid Dynamics	384
3. Case Study 2: New Approach to the Analysis of Heat and Mass Transfer in Drying and Frying	389
4. Case Study 3: Microwave Thawing of Frozen Meat	393
Nomenclature	397
Greek Symbols	400
References	400
<b>15. Food Rheology</b>	<b>403</b>
<b>Qixin Zhong and Christopher R. Daubert</b>	
1. Introduction	403
2. Basic Concepts in Rheology	403
3. Rheology of Fluids	407
4. Rheology of Semi-Solid Materials	414
5. Interfacial Rheology	422
6. Conclusions	425
References	425

<b>16. Food Extruders</b>	<b>427</b>
Mian N. Riaz	
1. Role of an Extruder	429
2. Typical Components of an Extruder	430
3. Types of Extruders	431
4. Sources for More Information for Extrusion Technology	439
References	439
Further Reading	440
<b>17. Thermal Processing for Food Sterilization and Preservation</b>	<b>441</b>
Arthur A. Teixeira	
1. Introduction	441
2. Retort Systems	441
3. Automated Materials Handling Systems	454
4. Aseptic Process Equipment Systems	457
5. Low-Acid Canned Food Regulations	459
References	466
<b>18. Artificial Neural Network (ANN) Based Process Modeling</b>	<b>467</b>
Gauri Shankar Mittal	
1. Basics	467
2. Examples	468
3. Meatball Cooking Example in Detail	469
References	472
<b>19. Design of Food Process Controls Systems</b>	<b>475</b>
Mark T. Morgan and Timothy A. Haley	
1. Introduction	475
2. Benefits of Automation	475
3. Computer Integrated Manufacturing	476
4. Automation Components and Terminology	478
5. Control System Objectives	480
6. Controllers	493
7. Sensor Fundamentals	502
8. Actuators	531
Further Reading	540

<b>20. Ohmic Pasteurization of Meat and Meat Products</b>	<b>541</b>
James G. Lyng and Brian M. McKenna	
1. Introduction	541
2. Conventional Thermal Methods for the Preservation of Meats	543
3. Basic Principle of Ohmic Heating	544
4. Microbial Inactivation during Ohmic Heating	552
5. Quality of Ohmically Heated Meat Products	553
6. Economics of Ohmic Processing	557
7. Ohmic Heating for Commercial Scale Production of Cooked Meats	559
8. Conclusion and Future Work	564
Acknowledgements	564
Abbreviations	565
References	565
<b>21. Food Processing Facility Design</b>	<b>571</b>
Timothy J. Bowser	
1. Introduction	571
2. Background	571
3. Key Facility Issues	572
4. Project Phases	579
5. Conclusion	595
References	595
<b>22. Sanitary Pump Selection and Use</b>	<b>599</b>
Timothy J. Bowser	
1. Introduction	599
2. Sanitation Standards for Pumps	600
3. Sanitary Pump Classification	600
4. Selecting Sanitary Pump Type	604
5. Installation	614
6. Cleaning and Maintenance	615
7. Conclusion	617
References	617
<b>23. Agricultural Waste Management in Food Processing</b>	<b>619</b>
Conly L. Hansen and Dae Yeol Cheong	
1. Introduction	619
2. Common Unit Processes Employed in Food Waste Treatment	621

3. Characteristics of Wastes and Treatment Types	623
4. Physical-Chemical Treatment Process	628
5. Biological Treatment Process	639
6. Land Treatment of Waste	650
7. Bioprocess Technology from Waste	652
8. Conclusions	659
References	662
Further Reading	666
<b>24. Food Packaging Machinery</b>	<b>667</b>
Harold A. Hughes	
1. Introduction	667
2. Filling Machines	670
3. Volumetric Fillers	670
4. Weight Filling	673
5. In-Line or Rotary Fillers	676
6. Cap Application Machines	677
7. Induction Cap Sealing	680
8. Flexible Packaging	681
9. Form—Fill—Seal Equipment	681
10. Canning Machinery	684
11. Carton Filling and Closing Machinery	687
12. Metal Detectors	689
<b>25. Damage Reduction to Food Products During Transportation and Handling</b>	<b>691</b>
Jay Singh and S. Paul Singh	
1. Introduction	691
2. Functions of Packaging	691
3. Food Product Categories	696
4. Food Product Distribution Environment	702
5. Major Causes of Food Spoilage/Damage in Supply Chain	704
6. Packaging Materials	705
7. “Smart” Packaging	711
8. Trends in Protective Food Packaging of 2000 and Beyond	713
References	719
<i>Index</i>	721

## PREFACE TO THE SECOND EDITION

The Preface (reprinted here) to the First Edition of the **Handbook of Farm, Dairy, and Food Machinery**, published in 2007, made the case for the handbook's importance. The case remains as forceful now as it did then, so I will not update it in this Preface. Instead, I will focus on the changes made for the new edition.

While the changes are substantial, the overall arrangement of the Second Edition follows the arrangement of the First Edition.

As in the First Edition, the Second Edition begins with three introductory chapters – on The Food Engineer, Food Regulations, and Food Safety Engineering. The first two chapters have been updated, while the third remains unchanged.

The handbook's next section, on Farm Machinery Design, now has five chapters, one more than in the first edition. The new chapter covers Air Seed Openers for Proper Seed & Fertilizer Placement. Three chapters have been updated—Grain Harvesting Machinery Design, Grain Harvesting Machinery Design, and Milking Machines and Milking Parlors. One chapter remains unchanged—Farm Machinery Automation.

The handbook's third and by far largest section, on Food Processing Operating Systems and Machinery Design, has been expanded from 13 to 15 chapters. The two new chapters cover Food Extruders and Sanitary Pump Selection/Application. Ten chapters have been updated: Dairy Product Processing Equipment, Grain Processing Engineering, Technology of Processing of Horticultural Crops, Food Drying and Evaporation Processing Operations, Food Freezing Technology, Food Rheology, Thermal Processing for Food Sterilization and Preservation, Food Process Modeling, Simulation and Optimization, Ohmic Pasteurization of Meat and Meat Products, and Food Processing Facility Design. Just three chapters remain unchanged—Heat and Mass Transfer in Food Processing, Design of Food Processing Controls Systems, and Agricultural Waste Management in Food Processing.

The two chapters comprising the handbook's final section, Food Packaging Systems and Machinery Design, are unchanged.

I would like to thank all contributors to both editions of the handbook for their efforts. I know how busy their lives are, and it is a miracle that they could find the time to write their erudite and comprehensive chapters. I salute them.



Thanks also to my editor, Nancy Maragioglio, and to Carrie Bolger, the editorial project manager, for shepherding the new edition from concept through to publication. And to my wife, Arlene: thank you for keeping me healthy and hearty.

Myer Kutz  
Delmar, NY  
October, 2012

## PREFACE TO THE FIRST EDITION

The food industry, which includes farming and food production, packaging and distribution, and retail and catering, is enormous. *The Wikipedia* states that in the United States, consumers spend approximately US\$1 trillion annually for food, or nearly 10% of the Gross Domestic Product (GDP). Over 16.5 million people are employed in the food industry. In 2004, processed food sales worldwide were approximately US\$3.2 trillion. According to Reuters, “food processing is one of the largest manufacturing sectors in the United States, accounting for approximately 10% of all manufacturing shipments (by value). The processed food industry has grown by over 10% between 1998 and 2004, and in 2004, the value of processed food shipments was approximately \$470 billion. The largest sectors of the industry, in terms of value, are meat, dairy, fruit and vegetable preservation, and specialty foods. Other niche sectors include bakeries and tortilla manufacturing, grain and oilseed milling, sugar and confectionery, animal food manufacturing, and seafood products.”

The size of the machinery component of the food processing industry is hardly static, and it is an area where engineers can have a major effect. The U.S. Department of Labor, Bureau of Labor Statistics, states: “Fierce competition has led food manufacturing plants to invest in technologically advanced machinery to be more productive. The new machines have been applied to tasks as varied as packaging, inspection, and inventory control. . . . Computers also are being widely implemented throughout the industry. . . . Food manufacturing firms will be able to use this new automation to better meet the changing demands of a growing and increasingly diverse population. As convenience becomes more important, consumers increasingly demand highly-processed foods such as pre-marinated pork loins, peeled and cut carrots, microwaveable soups, or “ready-to-heat” dinners. Such a shift in consumption. . . will lead to the development of thousands of new processed foods. Domestic producers also will attempt to market these goods abroad as the volume of international trade continues to grow. The increasing size and diversity of the American population has driven demand for a greater variety of foods, including more ethnic foods. The combination of expanding export markets and shifting and increasing domestic consumption. . . will lead to significant changes throughout the food manufacturing industry.”

During 2004, according to data compiled by the U.S. Census Bureau, factory shipments of farm equipment and machinery, including parts and attachments, produced by original equipment manufacturers (OEM) totaled US\$6.9 billion. The total includes dairy, planting, seeding, fertilizing, harvesting, and haying machinery, among

other products. It seems safe to say that the farm machinery component of the food industry is in the same growth and development mode as the food processing component.

Clearly, these two components of the food industry—farm machinery and food processing machinery—are of great interest to engineers in a variety of disciplines, including food and agricultural, mechanical, chemical, materials, and computer engineering. At least four major technical publishers address food engineering, with as many as several dozen titles in their lists. But when my editor at William Andrew Publishing, Millicent Treloar, and I reviewed these lists, none of the titles appeared to us to take the broad approach that we were interested in—an approach that her informal market research at industry meetings seemed to justify. So one of the main ideas that drove development of the *Handbook of Farm, Dairy, and Food Machinery* to conform to the needs of engineers, was to provide coverage from farm to market. Our intent from the outset was to cover, in a single comprehensive volume, those aspects of the food industry of interest to engineers who design and build farm machinery, food storage facilities, food processing machinery, and food packaging machinery.

This is a handbook written for engineers by engineers. Most of the contributors are based in the United States. Of the handbook's 22 chapters, 16 are from U.S. Contributors. But over a quarter of the chapters are from contributors based elsewhere—two in Canada, one in Ireland, one in Thailand, and two in New Zealand. The targeted audience for the handbook is practising engineers. Because the handbook is not only practical, but is also instructive, students in upper-level undergraduate and graduate courses will also benefit. While some chapters deal with the design of farm and food processing machinery and facilities, other chapters provide the theoretical basis for determining and predicting the behavior of foods as they are handled and processed. In order for the handbook to be useful to engineers, coverage of each topic is comprehensive enough to serve as an overview of the most recent and relevant research and technology. Numerous references are included at the ends of most chapters.

Like any of my handbooks (I am also the editor of the *Mechanical Engineers' Handbook*, which is now in its third edition, the *Handbook of Materials Selection*, the *Standard Handbook of Biomedical Engineering and Design*, the *Transportation Engineers' Handbook*, and the *Handbook of Environmental Degradation of Materials*), the *Handbook of Farm, Dairy, and Food Machinery* is meant not only to be used as a print reference, but also to serve as the core of a knowledge spectrum. In this Internet age, a broad-based publication, such as this handbook, does not exist in isolation. Instead, each part of it—each sentence, paragraph, item of data, reference, etc.—may be linked to information on a multiplicity of web sites. So this handbook, with its own store of knowledge, is also a gateway to a wider world of knowledge about farm and food processing machinery and facilities.

The handbook opens with three introductory chapters—Felix Barron’s chapter about food engineering curricula; a chapter on food regulations by Kevin Keener; and a chapter on food safety engineering by V.M. (Bala) Balasubramaniam and colleagues Raghupathy Ramaswamy, Juhee Ahn, Luis Rodriguez Saona, and Ahmed E. Yousef. There are then four chapters about farm machinery, facilities, and processes, including Brian Adams’ chapter on automating planting machinery, Graeme Quick and Mark Hanna’s chapter on designing grain harvesting machinery, a chapter by Ray Bucklin and colleagues Sidney Thompson, Ali Abdel-Hadi, and Michael Montross on designing grain storage facilities, and a chapter by Conley Hansen and Dae-Yeol Cheong on managing agricultural waste.

The next section of the handbook deals with milk and dairy products. There are two chapters, the first on milking machines and milking parlors by Douglas Reinemann, and the second on dairy product processing equipment by Doug Goff, from Canada. (Unless otherwise noted, contributors are from the United States.)

The largest section of the handbook, with a dozen chapters, covers food processing. This section begins with a chapter on rice processing by Athapol Noomhorm and Imran Ahmad, both from Thailand. The next chapter, by Conrad Perera and Bronwen Smith, both from New Zealand, is an overview of food processing operations. These operations are covered in more detail in the next half-dozen chapters—food drying and evaporation by William Kerr; food freezing by Kasiviswanathan Muthukumarappan and Chenchaiiah Marella; heat and mass transfer by Mohammed Farid, from New Zealand; rheology by Qixin Zhong; thermal processing by Arthur Teixeira; and food process modeling, simulation, and optimization by Gauri Mittal, from Canada. The section continues with a chapter on designing food process controls by Mark Morgan; a forward-looking chapter on ohmic pasteurization of meat and meat products by James Lyng and Brian McKenna, both from Ireland; a chapter on food safety engineering by V.M. (Bala) Balasubramaniam and colleagues Raghupathy Ramaswamy, Juhee Ahn, Luis Rodriguez Saona, and Ahmed E. Yousef; and, finally, a chapter on food processing facilities design by Timothy Bowser.

The final section of the handbook contains two chapters on packaging, the first on packaging materials and processing by Jay Singh and Paul Singh (who are not related and are at different universities), and the second on packaging machinery by Harold Hughes.

While my own training as a mechanical engineer was crucial in conceiving the *Handbook of Farm, Dairy, and Food Machinery*, and while my publishing history with engineering handbooks in a wide variety of disciplines was certainly useful in bringing the handbook to fruition, it was the contributors who did the real heavy lifting. It is a miracle, as it is for any handbook with many contributors, that so many found the time and energy to create their scholarly and practical chapters.

Their professionalism is remarkable, and they have my utmost appreciation and admiration. My thanks also to my wife Arlene, whose love, encouragement, and patience help me immeasurably.

Myer Kutz  
Delmar, NY

# LIST OF CONTRIBUTORS

**Ali Abdel-Hadi**

Tuskegee University, AL, USA

**Brian T. Adams**

University of Missouri-Columbia, MO, USA

**Imran Ahmad**

Asian Institute of Technology, Thailand

**Juhee Ahn**

Ohio State University, OH, USA

**V.M. Balasubramaniam**

Ohio State University, OH, USA

**Felix H. Barron**

Clemson University, SC, USA

**Timothy J. Bowser**

Oklahoma State University, OK, USA

**Ray Bucklin**

University of Florida, FL, USA

**Christopher R. Daubert**

North Carolina State University, NC, USA

**Mohammed Farid**

University of Auckland, Auckland, New Zealand

**H. Douglas Goff**

University of Guelph, ON, Canada

**Timothy A. Haley**

Iowa State University, Ames, IA, USA

**H. Mark Hanna**

Iowa State University, IA, USA

**Conly L. Hansen**

Utah State University, UT, USA

**Harold A. Hughes**

Michigan State University, MI, USA

**Kevin M. Keener**

Purdue University, NY, USA

**William L. Kerr**

University of Georgia, GA, USA

**James G. Lyng**

University College Dublin, Ireland

**Chenchaiah Marella**

South Dakota State University, SD, USA

**Brian M. McKenna**

University College Dublin, Ireland

**Gauri Shankar Mittal**

University of Guelph, Ontario, Canada

**Michael Montross**

University of Kentucky, KY, USA

**Mark T. Morgan**

Purdue University, West Lafayette, IN, USA

**Kasiviswanathan Muthukumarappan**

South Dakota State University, SD, USA

**Athapol Noomhorm**

Asian Institute of Technology, Pathum Thani, Thailand

**John Nowatzki**

North Dakota State University, Fargo, ND, USA

**S. Paul Singh**

Michigan State University, MI USA

**Conrad O. Perera**

University of Auckland, Auckland, New Zealand

**Graeme R. Quick**

Fellow ASABE, Fellow IEAust., Peachester, Queensland, Australia

**Raghupathy Ramaswamy**

Ohio State University, OH, USA

**Douglas J. Reinemann**

University of Wisconsin, Madison, WI, USA

**Mian N. Riaz**

Texas A&M University College Station, TX, USA

**Luis Rodriguez Saona**

Ohio State University, OH, USA

**Jay Singh**

California Polytechnic State University, CA, USA

**Bronwen Smith**

University of Auckland, Auckland, New Zealand

**Arthur A. Teixeira**

University of Florida, FL, USA

**Sid Thompson**

University of Georgia, GA, USA

**Dae Yeol Cheong**

Utah State University, UT, USA

**Ahmed E. Yousef**

Ohio State University, OH, USA

**Qixin Zhong**

University of Tennessee, TN, USA



This page intentionally left blank

# The Food Engineer

**Felix H. Barron**

Clemson University, SC, USA

## 1. NATURE OF WORK AND NECESSARY SKILLS

Food engineering is considered a specialized engineering field. In general, engineers are trained in the application of science principles and mathematics in order to provide economical solutions to technical problems; usually fulfilling social, commercial, or similar needs.

Product design and development are typical activities that an engineer may be asked to perform. The engineer must specify the functional requirements of the product, design, and testing and final evaluation to check for overall efficiency, cost, safety, and reliability if necessary. Overall, these principles may be applied to product design, no matter what the product is, for example a machine, a food, or a chemical.

Engineers may also work in testing, production, or maintenance areas, supervising production in factories, determining the causes of component failure, and testing manufactured products to maintain quality. Costing and scheduling for project completion are other duties typical of an engineer. Some engineers may become managers or salespersons. A background in sales engineering gives an individual the knowledge and experience required to discuss technical aspects and assist in product planning, installation, and use of equipment. A supervising engineer is responsible for major components or entire projects.

Food engineers use computers extensively to produce and analyze products, processes, or plant designs; to simulate and test how a machine or food system operates; and to generate specifications for foods, machinery, or packaging. Food engineers may also use computers to monitor product quality, safety, and to control process efficiency. Food nanotechnology, which involves control or manipulation of a product on the atomic scale, is introducing innovative principles to product and process design.

Seventeen engineering related specialties are covered in the Federal Government's Standard Occupational Classification system. Food engineering is recognized by

professional societies such as the Institute of Food Technologists, the American Society of Agricultural Engineers, and the American Institute of Chemical Engineers.

## 2. ACADEMIC AND INDUSTRY PREPARATION

As a specialized professional, the food engineer obtains his/her skills mainly through a university degree or industrial experience. Several universities across the USA offer formal academic training in food engineering. Agricultural engineering departments are a common avenue to specialization in the engineering aspects of food processing; however, it is not uncommon for graduates in food science to pursue the engineering specialization also. In fact, it is a requirement that food science students take a course in the principles of food process engineering; however, food scientists generally lack rigorous training in applied mathematics such as the use of differential equations to solve heat and mass transfer problems, plant design, or simulation of systems.

Internationally, food engineering training may be obtained through colleges of agriculture, chemical engineering departments, or schools of applied sciences. International degrees obtained through engineering programs, which also offer traditional engineering degrees such as chemical or mechanical, likely are the most similar to the typical USA degree, especially with regards to mathematical training. [Table 1.1](#) shows a typical course work program to obtain an engineering degree specializing in food engineering. [Tables 1.2 and 1.3](#) show typical course work in chemical and mechanical engineering, respectively. Comparing the three programs, it can be concluded that the major academic preparation difference lies in the specialized topics or

**Table 1.1** A Typical List of Courses for an International B.S. Program in Food Engineering  
**Food Engineering B. S. Program: an International Example**

Mathematics I, II, III	Food Analysis
Physics I, II	Food Biotechnology
Chemistry	Heat Transfer
Organic Chemistry	Product Development
Computer Science	Milk and Milk Products
Thermodynamics for the Food Industry	Mass Transfer
Food Chemistry	Meat Processing
Transport Phenomena	Fruits and Vegetables Processing
Numerical Methods	Cereal Processing
Human Nutrition	Quality Assurance
Food Technology	Food Plant Design
Microbiology	Design of Experiments
Food Microbiology	Differential Equations
Other electives	Biochemistry
Probability and Statistics	Other Electives and Laboratories

**Table 1.2** Chemical Engineering; a Curriculum (USA) Example

<b>First Semester</b>	<b>Second Semester</b>
<b><i>Freshman Year</i></b>	
2–Engineering Disciplines and Skills	3–Chemical Engineering Tools
4–General Chemistry	4–General Chemistry
3–Accelerated Composition	3–Physics with Calculus I
4–Calculus of One Variable I	4–Calculus of One Variable II
3–Arts and Humanities Requirement <i>or</i> 3–Social Science Requirement	3–Arts and Humanities Requirement <i>or</i> 3–Social Science Requirement
Total: 16 hours	Total: 17 hours
<b><i>Sophomore Year</i></b>	
3–Organic Chemistry	3–Organic Chemistry
4–Intro. to Chemical Engineering	1–Organic Chemistry Lab
4–Calculus of Several Variables	4–Intro. to Ord. Diff. Equations
3–Physics with Calculus II	4–Fluids/Heat Transfer
3–Arts and Humanities Requirement	3–Chemical Engineering Thermodynamics I
Total: 17 hours	Total: 15 hours
<b><i>Junior Year</i></b>	
3–Molecular Biochemistry	3–Physical Chemistry
1–Physical Chemistry Lab	1–Physical Chemistry Lab
3–Unit Operations Lab I	4–Mass Transfer and Separation Processes
3–Engineering Materials	3–Chemical Engineering Thermodynamics II
2–Basic Electrical Engineering	3–Emphasis Area
1–Electrical Engineering Lab I	3–Arts and Humanities Requirement <i>or</i> 3–Social Science Requirement
3–Arts and Humanities Requirement <i>or</i> 3–Social Science Requirement	
Total: 16 hours	Total: 17 hours
<b><i>Senior Year</i></b>	
3–Unit Operations Lab II	3–Process Dynamics and Control
3–Process Development, Design, and Optimization of Chemical Engineering Systems I	3–Process Design II
1–Chemical Engineering Senior Seminar I	1–Chemical Engineering Senior Seminar II
3–Chemical Reaction Engineering	3–Industrial Microbiology
3–Emphasis Area	3–Emphasis Area
3–Arts and Humanities Requirement <i>or</i> 3–Social Science Requirement	
Total: 16 hours	Total: 13 hours

127 total semester hours.

**Table 1.3** Mechanical Engineering; a Curriculum (USA) Example

<b>First Semester</b>	<b>Second Semester</b>
<b><i>Freshman year</i></b>	
2—Engineering Disciplines and Skills	2—Engr. Graphics with Computer Appl.
3—General Chemistry	3—Programming and Problem Solving in Mechanical Engineering
3—Accelerated Composition	4—Calculus of One Variable II
4—Calculus of One Variable I	3—Physics with Calculus I
	1—Physics Lab. I
3—Humanities/Social Science Requirement or 3—Social Science Requirement	3—Humanities/Social Science Requirement or 3—Social Science Requirement
Total: 16 hours	Total: 16 hours
<b><i>Sophomore Year</i></b>	
5—Statics and Dynamics for Mech. Engr	2—Basic Electrical Engineering
2—Mechanical Engineering Lab. I	1—Electrical Engineering Lab. I
4—Calculus of Several Variables	3—Engineering Mechanics: Dynamics
3—Physics with Calculus II	3—Foundations of Thermal and Fluid Systems
3—5—Science Requirement	4—Intro. To Ord. Diff. Equations
	3—Numerical Analysis Requirement
Total: 17–19 hours	Total: 16 hours
<b><i>Junior Year</i></b>	
3—Mechanics of Materials	3—Heat Transfer
3—Thermodynamics	3—Fundamentals of Machine Design
3—Model. And Analysis of Dynamics Syst.	3—Manufacturing Proc. And Their Appl.
3—Fluid Mechanics	3—Advanced Writing Requirement
2—Mechanical Engineering Lab. II	3—Statistics Requirement
3—Arts and Humanities Requirement or 3—Social Science Requirement	
Total: 17 hours	Total: 15 hours
<b><i>Senior Year</i></b>	
3—Mechanical Engineering Design	1—Senior Seminar
3—Control and Integration of Multi-Domain Dynamic Systems	3—Internship in Engineering Design
2—Mechanical Engineering Lab. III	6—Arts and Humanities Requirement or 3—Social Science Requirement
6—Technical Requirement	3—Technical Requirement
Total: 14 hours	Total: 13 hours

124–126 total semester hours.

areas of fundamentals of food processing and food microbiology. Other areas such as food chemistry, applied mass and energy balances to foods, or food unit operations can be learned from a general engineering degree such as chemical engineering.

A mechanical or electrical engineer requires training in mass balances and unit operations for easier adaptation to the food engineering area.

Bachelor's degree programs in engineering typically are designed to last 4 years, but many students find that it takes between 4 and 5 years to complete their studies. In a typical 4-year college curriculum, the first 2 years are spent studying mathematics, basic sciences, introductory engineering, humanities, and social sciences. During the last 2 years, most courses are in engineering, usually with a concentration in one specialty, such as food engineering or biotechnology. Some programs offer a general engineering curriculum; students then specialize on the job or in graduate school.

Some 5-year or even 6-year cooperative plans combine classroom study and practical work, permitting students to gain valuable experience and to finance part of their education.

### **3. WORK OPPORTUNITIES FOR A FOOD ENGINEER**

All 50 US states and the District of Columbia require licensure for engineers who offer their services directly to the public. Engineers who are licensed are called professional engineers (PE). This licensure generally requires a degree from an Accreditation Board for Engineering and Technology (ABET) accredited engineering program, 4 years of relevant work experience, and successful completion of a state examination.

An informal collection of job descriptions for engineers gathered through the years (2009–2011) from various resources including: <http://www.engineers.com>, <http://www.indeed.com>, and <http://www.foodrecruiters.com> reveals some of the necessary skills companies, universities, or government agencies are looking for in a food engineer.

#### **3.1 Job Description Sample 1**

A Process Design Engineering Manager has engineering responsibility for root cause analysis and correcting “process issues” within a beverage, pharmaceutical, or food plant. This includes existing plant opportunities and new state of the art solutions to process packaging in a high speed plant. It is important that the candidate can demonstrate, with examples, his/her strength in visualizing complete projects at the conceptual stage.

Specific accountabilities include:

- Conducting fundamental research related to optimization of a process and product.
- Independently designing and performing laboratory testing directed at problem solving with commercial scale-up capability.
- Planning and executing medium-term research and development activities of moderate to complex scope.

- Demonstrating technical competence in several areas of food-related chemistry and engineering practice.  
Specific skills and qualifications include:
- Ph.D. in Food Science or Food Engineering.
- Expertise in areas of natural organic polymers, carbohydrate chemistry, physical science, food science, and food process engineering.
- The ability to apply scientific/engineering theory to the execution of projects related to process or product development.
- Sound problem solving and project leadership skills, with emphasis on designing or conducting laboratory testing and pilot scale simulations.
- The ability to conduct literature searches and compile comprehensive, clear summaries of findings.
- Working knowledge of applied statistics and statistical design of experiments.
- Good oral, written, technical, and general communication skills.

## **3.2 Job Description Sample 2**

### ***3.2.1 Essential Functions***

Develop written policies and procedures for the organized and profitable development of new meat products. Such procedures should have distinct mechanisms for the timely completion of: new product concept approval, development, shelf-life testing, package design, and final product approval.

Follow concepts identified by sales and marketing: work closely with sales, marketing, quality assurance, operations, finance, purchasing, and engineering to develop new meat products that meet internal and/or external specifications.

Develop and implement cost reduction products to improve operating efficiency and maximize profitability. Write project protocols, collect and analyze data, prepare reports.

## **3.3 Job Description Sample 3**

This position will manage the engineering functions needed to support manufacturing, R&D, quality assurance, and logistics.

The Project Engineer will manage contractors and in-plant personnel in the completion of capital projects, and also manage the capital plan.

## **3.4 Job Description Sample 4**

### ***3.4.1 Food Engineering Research***

This facility is a high-speed/high-volume, 24/7 operation, which is currently going through an expansion. This position will support the production of newly developed

products, and current production lines, purchase and install new equipment, upgrade existing equipment, and develop efficiency improvements.

Working in a team-based manufacturing environment, process engineers lead, develop, and execute solutions to improve process system performance and product quality. Serving as a dedicated technical system resource, process engineers also lead problem solving and problem prevention efforts directed at current and future processes and products, assure that new product and process tests and start-ups are designed and executed effectively, and develop and direct training in system operations.

### **3.4.2 Requirements**

B.S. in Engineering (Chemical, Mechanical, Electrical, or Food Engineering preferred), and 4–8 years of process or packaging engineering experience in a food, consumer products, pharmaceutical, chemical, or other continuous process manufacturing environment. Strong technical skills are required, including demonstrated understanding of unit operations, analytical methods, and statistical process control, as well as troubleshooting skills.

## **3.5 Job Description Sample 5**

Our client seeks a process improvement engineer with food manufacturing experience for their dynamic company. In this role, you will analyze new product formulations and pilot plant productions and provide recommendations for process flow modifications, equipment modifications, operations changes, and new equipment requirements. You will define issues, collect data, establish facts, and draw valid conclusions as well as manage teams to ensure effective transition from product conception to full-scale production.

The position requires a degree in engineering and 5 or more years of work experience. Of this work experience, 3 years must be within the food industry. Experience in product development is desired. Experience as a process engineer, production manager, production supervisor or research and development engineer is highly desirable. Up to 50% domestic travel is required.

Based on these job descriptions, the following engineering key words were found with major frequency in descending order: engineering, development, manage, design, analysis, concept, solving and scale.

These key words can be compared with knowledge and skills to be taught at universities offering engineering degree majors, including food engineering. Take for example the following:

- Students specializing in food engineering learn to apply engineering principles and concepts to handling, storing, processing, packaging, and distributing food and related products.



- Students specializing in agricultural engineering integrate engineering analysis and design with applied biology to solve problems in production, transportation, and processing of agricultural products. Agricultural engineers design machinery, processes, and systems for managing the environment, nutrients, and waste associated with productive plant and animal culture.

Figure 1.1 demonstrates a general flow diagram illustrating unit operations or processing steps typical of a food processing facility. The knowledge and skills of a food

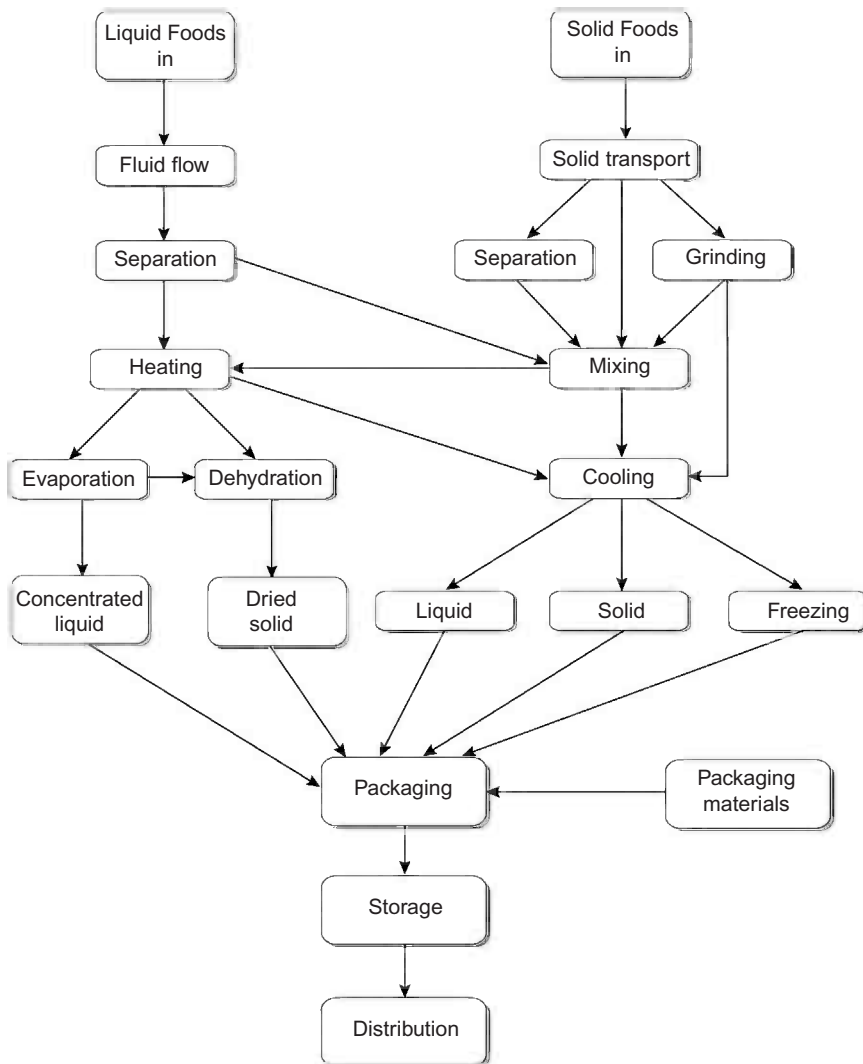


Figure 1.1 General flow in a food processing plant. (Adapted from Heldman and Singh, 1981)

engineer can be applied in an integrated approach or in a more specific way such as heat transfer in heating and cooling operations.

As food is received into the food processing plant, it may be in a liquid or solid form; if it is a liquid, one of the primary considerations may be its classification as a Newtonian or non-Newtonian liquid; therefore the field of rheology should be part of the knowledge base of the food engineer. Rheological studies could provide information necessary for the design of mixing machinery, piping, and even cleaning and sanitation of tubes and pipes used in transporting a fluid from one location to another.

Dehydration and evaporation of foods involve heat and mass transfer. The food engineer, with his/her knowledge in the theory of diffusion, mass and energy balances, would be capable of designing processes, equipment, and even costing in feasibility studies.

In addition to the heating and cooling section (Figure 1.1), the canning operation can be placed into the category of thermal processing. Thermal processing gives engineers and food scientists the opportunity to make significant contributions to the safety of processing canned products.

Typical engineering skills required by a thermal processor include knowledge of thermobacteriology and mathematical calculations in order to design a safe thermal-sterilization process. The thermal-sterilization process is industrially recognized as a commercial sterilization process.

A Process Authority is a federally recognized food professional who is typically responsible for creating a thermal process.

#### **4. ENGINEERING JOBS**

According to a 2008 survey distribution of employment by the Department of Labor (Table 1.4), engineers specialize within key industries, for example, 40% of agricultural engineers specialize in food manufacturing, and 29% of chemical engineers specialize in chemical manufacturing.

Overall, job opportunities for engineers are expected to increase (Table 1.5) over the next 5 years. Biomedical engineers should experience the highest growth by 2018, while electronics engineers, except computer engineers, should experience zero growth.

#### **5. FUTURE OPPORTUNITIES**

The food processing industry may be facing a challenge by consumers and health care government agencies to provide “healthy foods” that can contribute to a decrease in the obesity problem in the USA and around the world. In general, designing such

**Table 1.4** Percent Concentration of Engineering Specialty Employment in Key Industries, 2008

<b>Specialty</b>	<b>Industry</b>	<b>Percent</b>
Aerospace	Aerospace product and parts manufacturing	49
Agricultural	Food manufacturing and other engineering	40
Biomedical	Scientific research and development services	20
	Medical supplies	20
Chemical	Chemical manufacturing	29
	Architectural, engineering, and related services	15
Civil	Architectural, engineering, and related services	49
Computer hardware	Computer and electronic product manufacturing	41
	Computer systems design and related services	19
Electrical	Architectural, engineering, and related services	21
	Navigational, measuring, electromedical, and control instruments manufacturing	10
Electronics, except computer	Manufacturing	26
	Telecommunications	15
Environmental	Architectural, engineering, and related services	29
	State and local government	21
Health and safety, except mining safety	State and local government	10
Industrial	Machinery manufacturing	8
	Transportation equipment manufacturing	18
Marine engineers and naval architects	Architectural, engineering, and related services	29
Materials	Primary metal and semiconductor manufacturing	20
Mechanical	Architectural, engineering, and related services	22
	Machinery manufacturing	14
Mining and geological, including mining safety	Mining	58
Nuclear	Electric power generation, transmission and distribution	57
Petroleum	Oil and gas extraction	43

foods could become a critical factor for the food industry in order to expand markets and profitability. It may be necessary for food engineers to work more closely with molecular nutritionists in order to design so-called medical foods. Food biotechnology and food nanotechnology and their applications to food safety are areas in which food engineers may find new opportunities.

## 6. CONCLUSIONS

Overall, it appears that specialism in food engineering is becoming more common via on-the-job training in the food industry, rather than being an entry-level requirement

**Table 1.5** Projections Data from the National Employment Matrix

Occupational Title	SOC Code	Employment 2008	Project Employment 2018	Change 2008–2018	
				Number	Percent
Engineers	17–2000	1,571,900	1,750,300	178,300	11
Aerospace engineer	17–2011	71,600	79,100	7,400	10
Agricultural engineers	17–2021	2,700	3,000	300	12
Biomedical engineers	17–2031	16,000	27,600	11,600	72
Chemical engineers	17–2041	31,700	31,000	–600	–2
Civil engineers	17–2051	278,400	345,900	67,600	24
Computer hardware engineers	17–2061	74,700	77,500	2,800	4
Electrical and electronics engineers	17–2070	301,500	304,600	3,100	1
Electrical engineers	17–2071	157,800	160,500	2,700	2
Electronics engineers, except computer	17–2072	143,700	144,100	400	0
Environmental engineers	17–2081	54,300	70,900	16,600	31
Industrial engineers, including health and safety	17–2110	240,400	273,700	33,200	14
Marine engineers and naval architects	17–2121	8,500	9,000	500	6
Materials engineers	17–2131	24,400	26,600	2,300	9
Mechanical engineers	17–2141	238,700	253,100	14,400	6
Mining and geological engineers, including mining safety engineers	17–2151	7,100	8,200	1,100	15
Nuclear engineers	17–2161	16,900	18,800	1,900	11
Petroleum engineers	17–2171	21,900	25,900	4,000	18

(NOTE) Data in this table are rounded.

by food processing companies. This may be the reason some universities have modified their curricula by decreasing the number of food engineering-related courses and changing instead to areas considered “hot” such as biotechnology, bioengineering, or biomedical engineering.

Non-food engineers, such as mechanical, electrical, or chemical engineers who wish to work in the food processing industry can obtain the necessary training on-the-job or through professional development workshops, which are abundant. Many universities and consulting groups offer this type of training. Basic food microbiology, food safety, food quality, and food processing form a good knowledge base for non-food engineers.

## REFERENCE

Heldman, D.R., Singh, P.R., 1981. Food Process Engineering, second ed. Van Nostrand Reinhold, New York.

## FURTHER READING

Bureau of Labor Statistics, US Department of Labor, Occupational Outlook Handbook, 2008–2009 Edition, Engineers. <<http://www.bls.gov/oco/ocos027.htm/>> (Last accessed 28.03.12.).

Clemson University, on the internet at <<http://www.clemson.edu/>>.

Food and Drug Administration. <<http://fda.cfsan.gov/>>.

Institute of Food Technologists. <<http://ift.org/>>.

Instituto Tecnológico de Monterrey. <<http://cmportal.itesm.mx/wps/portal/>>.

# Food Regulations

Kevin M. Keener

Purdue University, NY, USA

## 1. BACKGROUND

In the USA an estimated 48 million illnesses (one in six), 128,000 hospitalizations, and 3,000 deaths are caused by foodborne disease. Three pathogenic bacteria *Salmonella*, *Listeria*, and *Toxoplasma* are responsible for approximately 30% of deaths (CDC, 2011). Foodborne illness and disease is a major cause of morbidity worldwide, resulting in substantial costs to individuals, food processors, national, and international economics. Thus, there is a need to ensure that food processing is conducted in a sanitary environment, performed in a sanitary manner, and every appropriate consideration given to produce safe food of high quality.

The purpose of this chapter is to provide process engineers with an understanding of food regulations in the USA. This chapter is by no means comprehensive, and regulations are constantly changing as a result of advances in science and changes in perceived threats. Therefore, it is recommended that individuals interested in producing food machinery, starting a food business, or producing a food product contact the appropriate regulatory agencies prior to commencing production. Food produced and sold without proper regulatory inspection is not in compliance with federal, state, and local laws, and may be deemed “adulterated.” Producing adulterated food is a serious crime and persons found guilty may be subject to civil and criminal penalties, including prison.

Food regulations in the USA are a patchwork of rules and regulations that have developed over time. For a single food, there are numerous government agencies that have inspection roles. At the federal level, the primary agencies with regulatory responsibilities are the Food and Drug Administration (FDA), an agency within the Department of Health and Human Services, and the Food Safety Inspection Service (FSIS) an agency within the United States Department of Agriculture. The FDA has responsibility to ensure safety of all foods under the Federal Food Drug and Cosmetic Act (FFDCA) of 1938 with the exceptions of meat, poultry, and egg products. The FFDCA Section 201(f) defines “food” as articles used for food or drink for man or other animals, chewing gum, and articles used for components of any such articles.

The FSIS has primary responsibility for meat, poultry, and egg products under the Meat Product Inspection Act (1906) (FSIS, 2011a), Poultry Product Inspection Act (1957) (FSIS, 2011b) and Egg Product Inspection Act (1970) (FSIS, 2010a). Other agencies have supporting roles in various commodities and provide grading and export inspection services. These will be identified in the proceeding commodity sections as appropriate.

Prior to producing any food it is recommended that one contact the local health department and/or state health department to ensure compliance with food regulations. FDA notification is required of any individuals producing low-acid or acidified canned foods. This notification is referred to as a “process filing”, which will contain a description of the food, packaging, and the proposed manufacturing process. FDA will review the submitted information and may respond with a letter asking additional questions. Historically, FDA has provided a “non-rejection” letter for filings. A “non-rejection” letter is where FDA acknowledges in writing that they have reviewed the proposed food manufacturing process including equipment, packaging, etc., and do not have any concerns (e.g. objection) at that point in time. Recent communications with FDA indicate that they no longer provide “non-rejection” letters except for new processes and equipment. If a food manufacturer needs documentation regarding outcome of a filing review they must contact FDA. Further details on process filings may be found on the FDA website (FDA, 2011a). Additionally, any company that produces or distributes foods must register with FDA as required in the Public Health Security and Bioterrorism Preparedness and Response Act of 2002 (the Bioterrorism Act) (FDA, 2010).

## **2. FEDERAL REGISTER**

The Federal Register is the daily newspaper of the US government. It publishes all proposed, interim, and final rules on federal regulations from all federal agencies (Federal Register, 2011). Development of new regulations starts with the US Congress. In general the US Congress passes a bill (Act), e.g. the Meat Product Inspection Act. The President agrees and signs this bill into a new law. This Act assigns regulatory responsibility to a specific person or department, e.g. the Secretary of the United States Department of Agriculture (USDA). The Secretary (USDA) then determines what federal agency within their department will oversee regulatory inspection, e.g. the FSIS. That agency is responsible for proposing rules (regulations) regarding the assigned regulatory responsibility. Initially, the designated agency will announce a proposed rule and a comment period, e.g. 30, 60, or 90 days, in which interested parties (consumers, processors, industry associations, etc.) will provide

feedback to the designated agency on the proposed rule. These comments will include both the technical merits and scientific merits. The federal agency will then respond, as required by law, to all comments received, and modify or abandon the proposed rule, or issue a final rule. Final rules usually have an implementation period after which enforcement will begin. It is very important that affected parties participate in this rule making process because non-response is treated as acceptance of the proposed rule.

### **3. CODE OF FEDERAL REGULATIONS**

Federal agencies compile and publish current regulatory requirements every year in the Code of Federal Regulations. This compendium of federal regulations is published and maintained by the United States Government Printing Office and can be purchased in hard copy or viewed in electronic form at their website ([CFR, 2011a](#)). This document contains 50 volumes (referred to as Titles) and includes all federal agencies. For example, USDA-Agricultural Marketing Service (AMS) Regulations are listed in Title 7; USDA-FSIS Animal and Animal Products Regulations are listed in Title 9; HHS-FDA Food and Drug Regulations are listed in Title 21; and US-Environmental Protection Agency (EPA) Protection of Environment Regulations are listed in Title 40.

### **4. UNITED STATES CODE**

The United States Code is the codification by subject matter of the general and permanent laws (Acts) of the USA. It is meant to be an organized, logical compilation of the laws passed by Congress. At its highest level, it divides the legislation into 50 topic areas called Titles. Each Title is further subdivided into any number of logical subtopics. The United States Code is published every 6 years, with the most recent being the 2006 version with annual updates added ([US Code, 2011a](#)). Any law or individual provisions within a law passed by Congress are classified in the Code. However, legislation often contains many unrelated provisions that collectively respond to a particular public need or problem. For example, a “Farm Bill”, might contain provisions that affect the tax status of farmers, their land management practices, and a system of price supports. Each of these individual provisions would belong to a different section in the Code. Thus, different parts of a law will be found within different Titles. Typically, an explanatory note will indicate how a particular law has been classified into the Code. It is usually found in the Note section attached to a relevant section of the Code, usually under a paragraph identified as the “Short Title”.



## 5. STATE AND LOCAL REGULATIONS

Many states have a department of agriculture and/or an environmental and natural resources departments that regulate many aspects of food processing facilities. Many states have an administrative code similar to the Code of Federal Regulations (usually adopted by reference) that states requirements for administrative responsibilities, inspection frequency, and permitting requirements for food processors operating in a particular state. In addition, some states allow local regulations/zoning requirements to be developed that can also impact food processing facilities. The local rules are not usually on-line, but can be located by contacting the county and/or city services department for the respective location of the food processing facility. These local rules often deal with waste discharges, noise, and odors, and other neighbor concerns.

## 6. USDA—FSIS SANITATION PROGRAMS

All meat, poultry, and egg processing plants are required to have a written sanitation program. Sanitation is the creation and maintenance of hygienic and healthful conditions in food processing plants. Sanitation involves an applied science that has the overall goal of providing a clean environment and preventing food product contamination during processing. The universal goal of sanitation is to protect the food supply. An effective sanitation program includes benefits such as:

1. Microbial and chemical monitoring.
2. Control of food spoilage and lower consumer complaints.
3. Increased storage life of the product.
4. Improved employee morale.
5. Reduced public health risks.

Specific sanitation requirements vary for each commodity. FSIS has sanitation requirements for meat poultry and egg products in Title 9 Part 416 of the Code of Federal Regulations ([CFR, 2011b](#)).

### 6.1 Sanitation

Sanitation requirements for meat, poultry and egg products are listed in Title 9 Part 416 and subdivided into two parts. Sections 416.1–416.6 are referred to as the Sanitation Performance Standards (SPS) and Sections 416.11–416.17 are referred to as the Sanitation Standard Operating Procedures (SSOPs). Note: There are no sections between 416.7 and 416.10.

#### 6.1.1 Sanitation Performance Standards

Sanitation performance standards describe specific areas evaluated by inspection personnel regarding sanitation performance. Establishments must comply with the

regulatory performance standards for sanitation cited below, but may do so by whatever means they determine to be appropriate. No specific sanitary practices are required; FSIS inspection personnel will verify that official establishments comply with the performance standards. Section 416.1 is known as the “General Rules” and requires that “each official establishment must be operated and maintained in a manner sufficient to prevent the creation of insanitary conditions and to ensure that product is not adulterated”. Section 416.2 describes specific concerns regarding buildings and grounds and pest control. The information on buildings and grounds includes criteria for construction, ventilation, lighting, plumbing, sewage disposal, and water. In addition, the facility must be designed to allow management of pests (flies, rodents, birds, etc.). It should be noted that pest control substances must be approved by EPA for use in food processing environments and be used in a manner that does not adulterate the product or create insanitation. Under the Federal Insecticide, Fungicide, and Rodenticide Act (FIFRA), EPA reviews pesticides, cleaners, sanitizers, antimicrobials, etc., formulations, intended use, and other information; registers all pesticides, sanitizers, antimicrobials, etc., for use in the USA; and prescribes labeling, use, and other regulatory requirements to prevent unreasonable adverse effects on the environment, including humans, wildlife, plants, and property. Any meat or poultry establishment using a pesticide, cleaner, sanitizer, antimicrobial, etc., must follow the FIFRA requirements. Section 416.3 describes the appropriate selection of equipment and utensils, and their respective installation and maintenance. Section 416.4 details the requirements for cleaning and sanitizing of food contact, non-food contact, and utensils. Section 416.5 describes the requirements for management of employee hygiene practices including the person and their respective practices to prevent product adulteration. If any equipment, utensils, rooms, or compartments are found to be insanitary, then the inspector (FSIS/state) will place a tag on the equipment (“US rejected”). The equipment, utensil, room, or compartment cannot be used until corrective action has taken place to produce sanitary conditions.

### **6.1.2 Sanitation Standard Operating Procedures (SSOPs)**

Minimum requirements for sanitation operating procedures are stated in Title 9 Sections 416.11–416.17 ([CFR, 2011b](#)). Each official establishment is required (shall) to develop, implement, and maintain written standard operating procedures for sanitation (Section 416.11). “The SSOPs shall describe all procedures an official establishment will conduct daily, before and during operations, sufficient to prevent direct contamination or adulteration of product(s)” (Section 416.12). The SSOPs cover the entire establishment and all shifts of operation. These procedures include at a minimum frequency of cleaning, cleaning procedures, and designated plant personnel. SSOPs must be signed and dated by the “overall authority” usually the owner or plant

manager. The FSIS also requires (shall) perform preoperational SSOPs prior to production and other SSOPs as written.

Monitoring procedures will be established by plant personnel to verify implementation of the SSOPs (Section 416.13). The written SSOPs must be routinely reviewed and effectiveness assessed. Revision is required (shall) as necessary to keep them effective and current with respect to changes in facilities, equipment, utensils, operations, or personnel (Section 416.14). The establishment must also maintain daily records sufficient to document the implementation and monitoring of the SSOPs and any corrective action taken (416.16). The establishment is required to maintain 6 months of written records, and they must be available to FSIS upon request, if within last 48 hours of plant operation, or within 24 hours.

It is the establishment's responsibility to implement the procedures as they are written in the SSOPs. If the establishment or FSIS determines that the SSOPs fail to prevent direct contamination or adulteration of product, the establishment must implement corrective actions that include the appropriate disposition of product, restoration of sanitary conditions, and measures to prevent recurrence. It is also required that SSOPs should describe the procedures that the establishment will take to prevent direct contamination or adulteration of product (Section 416.15).

FSIS has responsibility to verify that the establishment is conducting the SSOPs as written. Specifically they will verify the adequacy and effectiveness of the SSOPs and the procedures specified therein by determining that they meet the requirements of this part (416). Such verification may include:

1. Reviewing the SSOPs.
2. Reviewing the daily records documenting the implementation of the SSOPs and the procedures specified therein, and any corrective actions taken or required to be taken.
3. Direct observation of the implementation of the SSOPs and the procedures specified therein, and any corrective actions taken or required to be taken.
4. Direct observation or testing to assess the sanitary conditions in the establishment.

## **7. FDA SANITATION PROGRAMS**

For FDA inspected food processors (all foods excluding meat, poultry, and egg products) there are also sanitation requirements. These are detailed in the current Good Manufacturing Practices (cGMP). The cGMP regulations are printed in Title 21 Part 110 of the Code of Federal Regulations ([CFR, 2011c](#)). In addition, FDA has developed specific GMPs for some food processing such as bottled water, baby food, and seafood. These regulations are minimum sanitation requirements and many food processors exceed these requirements.

The cGMP regulations are general sanitation requirements that apply to all foods. They are subdivided into specific plant requirements. Within Title 21 CFR 110, definitions of food processes and products (Section 110.3) along with the specific definition of adulteration are stated. Specific requirements for plant personnel are found in Section 110.10, and plant and grounds in Section 110.20. In brief, these specific regulations dictate that plant personnel, plant (building) and grounds, must be constructed and managed in a sanitary manner so as not to lead to adulteration of food processed in the facility. Section 110.35 describes sanitary operation requirements for the facility such as required cleaning of food contact and non-food contact surfaces, cleaners, and sanitizers. Sanitary facilities and controls (Section 110.39) describes requirements for sanitary water, plumbing, toilet and hand washing station requirements, floor drain requirements, and placement of signs instructing employees in required hygiene practices. Design of equipment and utensils (Section 110.40) for food contact are required to be constructed of non-toxic, corrosive-resistant materials. “The design, construction, and use of equipment and utensils shall preclude the adulteration of food with lubricants, fuel, metal fragments, contaminated water, or any other contaminants.” Each freezer and cold storage cooler is required to have a thermometer with an automatic control system or alarm system if under manual operation. All instruments and controls must be designed and maintained so as to not adulterate food. Any gases (air, nitrogen, etc.) introduced into the food or used to clean food contact surfaces or equipment must be appropriately treated so as to not adulterate the food.

“All operations in the receiving, inspecting, transporting, segregating, preparing, manufacturing, packaging, and storing of food shall be conducted in accordance with adequate sanitation principles (Section 110.80). Appropriate quality control operations shall be employed to ensure that food is suitable for human consumption and that food-packaging materials are safe and suitable. Overall sanitation of the plant shall be under the supervision of one or more competent individuals assigned responsibility for this function. All reasonable precautions shall be taken to ensure that production procedures do not contribute contamination from any source. Chemical, microbial, or extraneous-material testing procedures shall be used where necessary to identify sanitation failures or possible food contamination.” (CFR, 2011c)

All food that has become contaminated to the extent that it is adulterated shall be rejected, or if permissible, treated or processed to eliminate the contamination. Finished food products should be stored and transported appropriately so as to protect against product adulteration or container damage (Section 110.93).

Some foods when processed under cGMP contain natural or unavoidable defects that are at low levels and are not hazardous to health. FDA establishes a maximum level of each defect in a food produced under cGMP that is called the defect action level (DAL) (Section 110.110). DALs are established as needed and change as new technology and processing practices become available. DALs do not excuse the food from

being adulterated by non-compliance with cGMP, even when their effects produce defects below the DAL. In addition, mixing of food exceeding a DAL with food below the DAL is not allowed; even if the final product does not exceed the DAL, it would be deemed adulterated (CFSAN, 2000). A complete list of current DALs for natural or unavoidable defects in food for human use that present no health hazard may be obtained upon request from the Center for Food Safety and Applied Nutrition, Food and Drug Administration, 5100 Paint Branch Pkwy., College Park, MD 20740.

Note that maximum levels for pesticide residues in raw agricultural products are determined by the EPA under FIFRA. FDA's DAL for pesticide residues follow EPA's limits, unless an allowance for a higher level is made. Many food processes concentrate food products, and thus pesticides may cause the product to be considered adulterated if the DAL of pesticide residue is exceeded in the finished product. In addition, if the product is a ready-to-eat product, it may not be blended to lower the pesticide residue. For example, the DAL for aflatoxin (a carcinogen produced by certain molds) in peanuts and peanut products is 20 ppb. A finished peanut or peanut product must contain less than 20 ppb aflatoxin if it is to be sold for human consumption. If the amount of aflatoxin exceeds 20 ppb in dry roasted peanuts, they cannot be sold for human consumption. Also, these dry roasted peanuts cannot be blended with dry roasted peanuts containing a lower level of aflatoxin to lower the overall level of aflatoxin. In addition, if peanuts containing less than 20 ppb aflatoxin were used to produce peanut butter and the peanut butter (finished product) had an aflatoxin level above 20 ppb then this product could not be sold for human consumption. Also, this peanut butter could not be blended with peanut butter containing less than 20 ppb aflatoxin to lower the overall concentration below 20 ppb.

## **8. FOOD SAFETY MODERNIZATION ACT**

The signing of the Food Safety Modernization Act by the President on January 4, 2011 provides increased regulatory authority to FDA. FDA is currently developing new regulations based on this increased authority. Although the complete scope of these new regulations and their impact on food safety is unknown, it is apparent that additional requirements on food manufacturers will result. Five key areas of emphasis in the FSMA include: prevention, inspection and compliance, response, imports, and enhanced partnerships (FDA, 2011b).

### **8.1 Prevention**

Under the FSMA, FDA has authority to mandate companies across the entire food supply to implement comprehensive, preventive control systems including establishing science-based, minimum standards for safe production and harvest of food. These standards will take into consideration naturally occurring hazards and those that may

be unintentionally or intentionally introduced. Factors such as soil contact, employee hygiene, packaging processes, temperature controls, water quality, and animal access to fields or growing areas will be considered.

Implementation of these preventive controls requires development of a (HACCP-like) written plan that includes the following:

1. Evaluation of hazards that could affect food safety in the processing plant.
2. Specific identification of preventive steps and/or controls that will be put in place to prevent or significantly reduce the hazards identified.
3. Indication of how the preventive steps and controls will be monitored to ensure effectiveness.
4. Routine record-keeping of previously identified monitoring procedures.
5. Detailed actions that will be taken to correct any problems that arise.

Additional regulations will be issued to establish mitigation strategies to prepare and protect the food supply for intentional adulteration of food at points of vulnerability in the supply chain.

## 8.2 Inspection and Compliance

Under the FSMA, FDA will be increasing inspection and monitoring using the following methods:

- Mandated inspection frequency—FDA will determine for each food facility (both domestic and foreign) an inspection frequency based on the food safety risk of all products handled or manufactured.
- Access to records—FDA will have access to all records related to the preventive controls system put in place.
- Accredited laboratory testing—FDA is working to establish a laboratory accreditation program.

## 8.3 Response

Under FSMA, FDA has the following new authorities:

- Mandatory recall—FDA has the authority to issue mandatory food safety recalls. Previously, FDA would strongly request that companies make voluntary recalls of products.
- Product detention—FDA has the authority to detain (prevent movement or shipment) products that are believed to be adulterated or misbranded for up to 30 days.
- Registration suspension—if FDA determines that a food product has reasonable probability of serious adverse health consequences or death, FDA has the authority to suspend the registration of a facility to prevent product distribution.
- Enhanced product traceability—FDA has the authority to develop and implement a food product traceability system to track and trace domestic and imported foods.

## 8.4 Imports

Under FSMA, FDA has the following new authorities for imported products:

- Importer accountability—verification of food importers' adequacy in preventive controls in their foreign suppliers and assurance of the safety of the imported product.
- Third party certification—FDA will establish a program to identify qualified third parties that will be able to certify compliance of foreign food facilities to US standards.
- Certification for high-risk foods—FDA has the authority to require all imported high-risk foods have certification by one of the identified third parties mentioned above as a requirement of entry to the USA.
- Authority to deny entry—FDA has the authority to deny entry of products from any foreign facility that denies FDA access to the facility or the country in which the facility is located.

It should be noted that until specific regulations are developed, vetted, and published by FDA as final rules in the Federal Register no specific guidance can be provided on compliance. In addition, there will likely be phased implementation over a number of years based on company size.

## 9. HAZARD ANALYSES AND CRITICAL CONTROL POINT PROGRAM (HACCP)

HACCP is a systematic approach to the identification, evaluation, and control of food safety hazards. It is a regulatory requirement for many areas of food processing including meat (FSIS), poultry (FSIS), egg products (FSIS), seafood (FDA), and juice processing (FDA). With the passage of the FSMA, HACCP or HACCP-like programs will likely be developed by FDA to cover all manufactured food. HACCP requirements are unique for each food process. The unique requirements are dictated by the responsible regulatory agency. From a scientific perspective, HACCP is a proactive approach to food safety and is based on seven principles:

Principle 1: Conduct a hazard analysis.

Principle 2: Determine the critical control points (CCP).

Principle 3: Establish critical limits.

Principle 4: Establish monitoring procedures.

Principle 5: Establish corrective action.

Principle 6: Establish verification procedures.

Principle 7: Establish record-keeping and documentation procedures.

When combined, these principles form a flexible food safety program that is adjustable as processing conditions change. The goal of HACCP is to eliminate, control, and/or prevent food safety hazards at the processing plant with an ultimate goal of protecting the consumer.

## 9.1 Prerequisite Programs

The production of safe food products requires that the HACCP system be built on a solid foundation of prerequisite programs. Prerequisite programs provide the basic environmental and operating conditions that are necessary for the production of safe, wholesome food. These programs include sanitation (GMPs), preventative maintenance, ingredient receiving, recall, biosecurity, etc. Many of the requirements for these programs are specified in federal, state, and local regulations and guidelines.

The HACCP program is built on the prerequisite programs. In developing a HACCP program, preliminary information on the products, processes, and prerequisite programs must be collected and a process flow diagram developed detailing specific practices within the food processing facility. The preliminary steps must be completed before development of the HACCP plan.

Principle 1: Conduct a hazard analysis.

Each process step is assessed for potential physical, chemical, and biological hazards. Hazards are defined as those things that cause injury or illness. Physical hazards may include broken glass, wood, or bone shards. Chemical hazards may include cleaner, sanitizer, and pesticide residues. Biological hazards include pathogenic bacteria such as *Salmonella enteritidis* (SE) or *E. coli* 0157:H7.

Principle 2: Determine the critical control points (CCP).

For each process step in which potential hazards exist there is an assessment of existing control measures. If control measures exist that prevent the introduction of a potential hazard (e.g. prerequisite programs), then no CCP is needed. But, when a potential hazard exists and no control measures are present, then a CCP must be implemented.

Principle 3: Establish critical limits.

Once a CCP has been identified then critical limits must be developed based on scientific evidence. The critical limits are the conditions under which one can control, reduce, or eliminate the potential hazard. For example, if it was determined that SE might be present in ready-to-eat (RTE) chicken breast and no existing control measures prevented its introduction, then a CCP might consist of specifying a minimum cooking time and temperature to eliminate any potential SE from RTE chicken breast.

Principle 4: Establish monitoring procedures.

Once a CCP has been established with appropriate critical limits, it is necessary to ensure proper operation. This requires establishment of monitoring procedures and generation of records that document that critical limits have been met. For example, if one were required to cook chicken breast for a minimum time and a minimum temperature to eliminate any potential SE present, then records would document oven temperature and cooking time for each batch of chicken breast.



Principle 5: Establish corrective action.

If a deviation (not meeting critical limit or monitoring procedures inadequate) has been found to occur in the CCP, corrective action must be taken. Corrective action requires an assessment of what went wrong, what to do with the suspect product (product produced when the deviation occurred), how to fix the problem, and how to prevent the problem happening again.

Principle 6: Establish verification procedures.

These are established practices periodically performed to ensure that the hazard analysis, established CCP, established critical limits, and established corrective actions are appropriate to ensure elimination, reduction, and/or control of all known hazards for the particular food product in question.

Principle 7: Establish record-keeping and documentation procedures.

Written records of all HACCP activities must be kept and provided as appropriate for regulatory inspection of the food processing facility.

Further details on HACCP requirements for particular food processing may be found in the Code of Federal Regulations and under the appropriate regulatory agency. Further information on the scientific approach of HACCP can be located in the National Advisory Committee Microbiological Criteria in Food Document ([NACMCF, 2009](#)).

## 10. MEAT PROCESSING

Meat processing includes animals such as beef, pork, chicken, turkey, goat, and other minor animal species. Responsibility of meat inspection is delegated to the Secretary of the USDA under the Meat Products Inspection Act (1906) and Poultry Products Inspection Act (1968). Within USDA, the enforcement of meat processing regulations is the sole responsibility of the FSIS. Many states also have (federal equivalent) state inspection programs that enforce federal food processing regulations (adopted by reference) for products produced and sold within a state. If a company ships product over state lines, it must be inspected by federal inspectors.

Federal regulations (FSIS) for all meat processors are listed under Title 9 of the Code of Federal Regulations ([CFR, 2011b](#)). Since 2000, all meat processing facilities are required to have a written sanitation program and a HACCP program. The goal of the sanitation and HACCP program is to prevent adulterated product from entering the food supply. A food is adulterated under Section 601(m) of the FMIA “If it bears or contains any poisonous or deleterious substance which may render it injurious to health; but in case the substance is not an added substance, such article shall not be considered adulterated under this clause if the quantity of such substance does not ordinarily render it injurious to health...”. There are a total of nine parts to this

definition. Adulteration under FDA inspection is similarly defined under Section 402 of the FFDCA.

Meat slaughter plants are required by regulation to have an FSIS/state inspector on-site during processing to ensure that the product is being produced in a sanitary manner and no unfit (diseased or contaminated) meat is being processed. Further meat processing facilities (ready-to-eat meat, hot dogs, hamburger, etc.) are required to have all processed meat products inspected to ensure the sanitary conditions of the facility and that only wholesome food products are being produced.

In addition to the required inspection, optional product grading may be requested. Grading of meat products is done by the USDA-AMS Meat Grading and Services Branch. The grading service is a voluntary, fee-based service, although is required for many customers including hospitals, schools, and public institutions. Product grading is a visual assessment of qualities such as tenderness, juiciness, and flavor. Quality grades for beef, veal, and lamb are word labels such as prime, choice, good, etc., and vary slightly for each product, although the grades are based on nationally uniform standards within a product category. Beef carcasses also are graded indicating the yield from the carcass. Pork is not graded. Poultry is graded A, B, or C, where B and C are usually used in further processed products. The mandatory inspections by FSIS have no relationship to the AMS voluntary meat grading service.

Product labels for meat products include the name of the product, ingredients, quantity, inspection insignia, the company's name and address, and qualifying phrases such as "cereal added" or "artificially colored". Product dating is voluntary, but if included must identify what the date means, stated as "sell by", "use by", "best if used before", or "expiration date". The Fair Packaging and Labeling act of 1967 makes it illegal to mislead or mislabel the product (FTC, 2011).

Standards of identity for meat products are prescribed by regulation (USDA) so that the common or usual name for a product can only be used for products of that standard. The FSIS and FDA collaborate on the standards for meat and meat products. Some are defined easily in a couple of sentences, whereas others are complicated by involved ingredients, formulations, or preparation processes. For example, the definition of a hotdog (skinless variety): "... have been stripped of their casings after cooking. Water or ice, or both, may be used to facilitate chopping or mixing or to dissolve curing ingredients. The finished products may not contain more than 30% fat or no more than 10% water, or a combination of 40% fat and added water. Up to 3.5% non-meat binders and extenders (such as non-fat dry milk, cereal or dried whole milk) or 2% isolated soy protein may be used, but must be shown in the ingredients statement on the product's label by its common name. Beef franks or pork franks are cooked and/or smoked sausage products made according to the specifications above, but with meat from a single species and do not include byproducts. Turkey franks or chicken franks can contain turkey or chicken and turkey or chicken skin and fat in

proportion to a turkey or chicken carcass.” Mechanically separated meat (beef, pork, turkey, or chicken) may be used in hotdogs, and must be so labeled. MSM is minced meat paste produced from meat scraps removed from bones (FSIS, 2010b).

## 11. SHELL EGGS

FDA and agencies of the USDA (FSIS, AMS, APHIS) carry out regulation, safety efforts, inspection, and grading of eggs in cooperation. FSIS and FDA share authority for egg safety. FDA has authority for shell egg production and processing facilities, and FSIS has responsibility for egg product inspection. FDA also has responsibility for restaurant and foodservice and is working to strengthen egg handling requirements in the Food Code (food service regulations) and encourage its adoption by states and local jurisdictions. FDA and FSIS work together on the Egg Safety Action Plan to identify the systems and practices that must be carried out to meet the goal of eliminating *Salmonella* illnesses associated with the consumption of eggs (FSIS, 2011c). USDA works to educate consumers on the safe handling of egg products. The Animal and Plant Health Inspection Service (APHIS) conducts activities to reduce the risk of disease in flocks of laying hens. APHIS administers the voluntary National Poultry Improvement Plan (NPIP) which certifies that poultry breeding stock and hatcheries are free of certain diseases. Participation is required for producers that ship interstate or internationally. The APHIS National Animal Health Monitoring System monitors the prevalence of *Salmonella* in layer flocks.

Egg production and egg processing facilities are inspected by FDA under the authority of the Secretary of Health and Human Services to inspect food manufacturing facilities. Inspections of premises (including farms), storage facilities, inventory, manufacturing operations, and required records are done as deemed appropriate. Shell egg packers are inspected at least once per calendar quarter. In addition, eggs must be packaged according to the Fair Packaging and Labeling Act.

AMS administers voluntary egg-quality grading programs for shell eggs paid for by processing plants. AMS is responsible for the shell egg surveillance program to assure that eggs in the marketplace are equal to the assigned grade by visiting egg handlers and hatcheries four times per year. A USDA shield on the egg carton means that the plant processed the eggs according to AMS sanitation requirements and that the eggs were graded for quality and weight. Sanitation regulations require that eggs be washed and sanitized, and the egg coated with a tasteless natural mineral oil to protect it (AMS, 2007).

State Departments of Agriculture monitor compliance with official US standards, grades, and weight classes by packers not using the voluntary AMS shell egg grading service. Eggs monitored by a state agency will not have the USDA shield, but will be marked with a grade. State and local regulations (quality, condition, weight, quantity

or grade, or labeling) are required to be at least equal to federal regulations, and often have increased requirements.

There are three shell egg grades: Grade AA have whites that are thick and firm; yolks that are high, round, and practically free from defects; clean unbroken shells; and Haugh unit measurement above 72. Grade A have the same characteristics as Grade AA except that the whites are “reasonably firm” and the Haugh unit measurement is above 60. Grade A is the quality most often sold in stores. Grade B eggs have whites that may be thinner and yolks that may be wider and flatter than eggs of higher grades. The shells must be unbroken, but may show slight stains. Grade B eggs are usually used to make liquid, frozen, and dried egg products. Eggs are weighed individually and grouped based on weight. Egg weights per dozen are identified on the package: Jumbo (30 oz/doz), Extra Large (27 oz/doz), Large (24 oz/doz), Medium (21 oz/doz), Small (18 oz/doz), and Peewee (15 oz/doz).

Shell Egg cartons with the USDA shield must display the pack date in a three digit code starting with January 1 as 001 through December 31 as 365. Eggs are labeled with a “sell by” or expiration date. Labels on egg cartons must state that refrigeration is required. Labels are not required to show origin of product, but individual states have the authority to require that name, address, and license number of processor or packer be included. In 2000, FDA ruled that shell eggs be stored and transported at refrigeration temperatures not greater than 45°F (FDA, 2000).

The US Department of Commerce under the Sanitary Food Transportation Act (1990) (FDA, 2009a) requires that all vehicles dedicated to transporting food must transport only food.

## 11.1 Egg Products

FSIS is responsible for enforcement of the 1970 Egg Product Inspection Act (EPIA) (FSIS, 2010a). Egg products are defined as eggs that have been removed from the shell for processing. EPIA requires that a federal inspector provide direct inspection of egg products and additional inspection prior to entering commerce. EPIA requires that all egg products be pasteurized.

## 12. SEAFOOD PROCESSING

The term “fish” includes all fresh or saltwater finfish, molluscan shellfish, crustaceans, and other forms of aquatic animal life. Birds are specifically excluded from the definition because commercial species of birds are either non-aquatic or, as in the case of aquatic birds such as ducks, regulated by USDA. Mammals are also specifically excluded because no aquatic mammals are processed or marketed commercially in this country.

Fishery products must comply with the Federal Food, Drug and Cosmetic Act as amended and the Fair Packaging and Labeling Act as well as the Low-Acid Canned Food (LACF) program and the Seafood HACCP regulations (CFSAN, 2011a). Seafood HACCP considerations include many and various concerns related to specific species, pathogens from harvest area, parasites, natural toxins, decomposition-related hazards (e.g. histamines), environmental contaminants, pathogen growth and formation due to inadequate processing, allergens, etc.

FDA provides in-plant inspections quarterly for most seafood processors to ensure compliance with Seafood HACCP and GMPs. FDA reviews also examine economic/fraud issues (CRS, 2011). FDA conducts risk assessments and, periodically, lab evaluations through the Center for Food Safety and Applied Nutrition. They analyze for a vast array of defects including chemical contaminants, decomposition, net weight, radionuclides, various microbial pathogens, food and color additives, drugs, pesticides, filth and marine toxins such as paralytic shellfish poison.

FDA has the authority to detain or temporarily hold food being imported into the USA while it determines whether a product is misbranded or adulterated. FDA has the authority to set tolerances for man-made contaminants, except for pesticides, which are set by EPA. FDA also regulates the use of food and color additives in seafood and feed additives and drugs in aquaculture. FDA has regulations for food plant sanitation (GMPs), standards of identity, and common or usual names for food products.

FDA conducts mandatory surveillance and enforcement inspections of domestic seafood harvesters, growers, wholesalers, warehouses, carriers, and processors. FDA provides financial support by contract to state regulatory agencies for the inspection of food plants, including seafood. FDA also provides technical assistance and training to the states through its State Training and Information branch, and conducts training through its Education and Training staff. The Center for Food Safety and Applied Nutrition provides assistance to industry and the consuming public. FDA provides extensive technical assistance in seafood safety and sanitation to foreign governments through the World Food and Agriculture Organization (FAO) and the UN.

There are two specific regulatory programs: the Salmon Control Plan and the National Shellfish Sanitation Program (NSSP) (CFSAN, 2011b) recently augmented by the Interstate Shellfish Sanitation Conference (ISSC). These are voluntary programs involving individual states and the industry. The Salmon Control Plan is a voluntary cooperative program among the industry, FDA and the Food Products Association (FPA). The plan is designed to eliminate over processing, improve plant sanitation, and to improve product quality in the salmon canning industry.

NSSP provides for the sanitary harvest and production of fresh and frozen molluscan shellfish. It is administered through FDA and participants include the 23 coastal shellfish producing states and nine foreign countries. The NSSP Manual of Operations covers things such as the proper evaluation and control of harvest waters and a system of product identification that enables trace back to harvest waters. Imported shellfish products into the USA are regulated by FDA. FDA negotiates Memorandums of Understanding (MOUs) with each foreign government to ensure that molluscan shellfish products exported to the USA are produced in an equivalent manner to US products.

### **13. FRUITS, VEGETABLES, AND NUTS**

USDA-AMS administers grading programs for fruits, vegetables, and nuts in cooperation with state regulatory agencies under the Agricultural Marketing Act of 1946 (AMS, 2011). Grading is voluntary, except when required by specific laws, regulations, or government contracts. Grading services provide buyers and sellers with an objective, third party evaluation of a product's quality and condition. Grading is performed according to US Grade Standards. Factors such as product color, maturity, sugar and acid content, size, and defects help to determine the grade of a product. More than 300 standards have been developed for fresh and processed fruits, vegetables, nuts, and related products. For example, the State of Texas has published its grading requirements for tomatoes and other fruit (State of Texas, 2011).

AMS also administers the Perishable Agricultural Commodities Act of 1930 (PACA), a law that prohibits unfair and fraudulent practices in the US produce industry. Most traders of fresh or frozen fruits and vegetables are required to maintain a valid PACA license, which is issued by AMS.

AMS oversees the operations of research and promotion boards by industry personnel to ensure that they work in the best interest of their grower and handler constituents. Research and promotion programs aim to expand markets for specific commodities on a national basis. Examples of existing programs include blueberries, honey, mushrooms, peanuts, popcorn, potatoes, and watermelons.

AMS also administers fruit and vegetable marketing orders, which allow growers of agricultural products the authority to work together to develop dependable markets for their products. These groups of growers have the ability to establish minimum quality standards to keep inferior products from depressing markets, using research and promotion projects and applying volume controls to stabilize the short-term rate of commodity shipments or allocate supplies between primary and secondary outlets. Currently, there are 35 marketing orders in effect for fruits, vegetables, and related crops – covering 31 commodities grown in 20 states.

## 14. BEVERAGES

### 14.1 Alcoholic Beverages

Beer, wine, liquors, and other alcoholic beverages are subject to the Federal Alcohol Administration Act (FAAA) of 1936 (title 27 chapter 8) ([US Code, 2011b](#)). The FAAA is administered by the Department of the Treasury Alcohol and Tobacco Tax and Trade Bureau (TTB) and the Department of Justice and the Bureau of Alcohol, Tobacco, Firearms and Explosives (ATF). The TTB collects taxes and helps to ensure that alcoholic beverages are produced, labeled, advertised, and marketed in compliance with federal law to protect the consumer and to protect revenue ([TTB, 2011](#)). The ATF regulates the qualification and operations of distilleries, wineries, and breweries, as well as importers and wholesalers. The ATF National Laboratory Center tests products to ensure that all regulated ingredients are within legal limits in order to protect consumers from identifiable health risks in accordance with FDA recommendations. The ATF Labeling and Formulation Division examines all label applications to ensure that labels do not contain misleading information and do adhere to all regulatory mandates. CFR Title 27 part 16 contains the Alcohol Beverage Health Warning Statement ([ATF, 2011a](#)).

Sanitation and deleterious substances in alcoholic beverages are under the jurisdiction of FDA. All cooking wines, diluted wine beverages, and cider beverages with less than 7% alcohol by volume are also under the jurisdiction of the FDA: Compliance Policy Guide (CPG) 7101.05 labeling diluted wines and cider with less than 7% alcohol; CPG 7101.04 labeling dealcoholized wine and malt beverages; and CPG 7120.10 use of synthetic alcohol in foods ([FDA, 2011c](#)).

### 14.2 Carbonated Beverages

Manufacture of carbonated beverages is covered under cGMP. In addition, the beverages must adhere to FDA regulations for ingredients, flavors, and colors (ingredients, flavors, and colors in soft drinks are used in other foods); water (soft drinks are at least 90% water); and labeling. The water used in soft drinks far exceeds FDA standards for water because the trace elements allowed in water can affect the taste of the soft drink, so manufacturers use sophisticated filtrations systems. It should be mentioned that in certain carbonated beverages where sodium benzoate and ascorbic acid (Vitamin C) are included, breakdown of sodium benzoate can occur and benzene can be created. Benzene is a known carcinogen. FDA currently does not have limits on benzene allowances in carbonated beverages, but EPA has a maximum contaminant level of 5 ppb in drinking water ([EPA, 2011](#)).

### 14.3 Bottled Water

Bottled water is regulated by FDA under the FFDCA as a food. FDA regulations include standards that meet all EPA regulations for potable water. Manufacturers are required to use cGMP and to follow specific bottled water GMP. Manufacturers are also responsible for producing safe, wholesome, and truthfully labeled products complying with all applicable food regulations. Specific regulations for bottled water are in Title 21 of the Code of Federal Regulations: 21 CFR 165.110a establishes standards of identity for spring water and mineral water; 21 CFR 165.110b allowable levels for contaminants that are as stringent as the EPA standards for public water supplies; 21 CFR 129 GMPs for processing and bottling drinking water; 21 CFR 101 labeling regulations; and 21 CFR 110 cGMP regulations for foods that also apply to bottled water.

Bottlers must have source approval, provide source protection, and do source monitoring on a continuing basis. Bottlers must submit annual samples for testing chemical, physical, and radiological parameters. Samples must be tested for bacteria at least weekly, although many bottlers do in-house tests daily including bacterial analysis, physical and chemical parameters, dissolved solids, pH, turbidity, color, and conductivity. The bottled water industry must also comply with state standards, and trade association standards for International Bottled Water Association (IBWA) members. IBWA standards are more stringent in some cases than the federal standards and IBWA works with FDA and state governments. Importers must meet standards of their own country as well as all US regulations.

If the source of the bottled water is a community or municipal water system, this must be stated on the label unless it is further subjected to distillation, deionization, or reverse osmosis. EPA regulates all community and municipal water systems.

GMP regulations for processing and bottling of drinking water (21 CFR 129) require that bottled water be safe and processed, bottled, held, and transported under sanitary conditions. Processing regulations include protection from contamination, sanitation of the facility, quality control, and sampling and testing of source and final product for microbiological, chemical, and radiological contaminants. Bottlers are required to maintain source approval and testing records for inspectors. FDA monitors and inspects bottled water products and processing plants under its general food safety program, not a specific bottled water program.

Standards of identity and quality in 21 CFR 165.110a describe “bottled water” and “drinking water” as water intended for human consumption sealed in containers with no added ingredients except safe and suitable antimicrobials and fluoride within limits set by FDA. FDA has also defined different types of bottled water including: “artesian water”, “artesian well water”, “ground water”, “mineral water”, “purified water”, “sparkling bottled water” and “spring water”.



## 14.4 Fruit and Vegetable Juices

After outbreaks in 1996 (*E. coli* in unpasteurized apple juice) and 1999 and 2000 (*Salmonella* in unpasteurized orange juice), FDA ruled that juice processors must use HACCP principles for juice processing. The Juice HACCP regulation applies to juice products sold as or used in beverages in both interstate and intrastate commerce. In addition, all juice processors must comply with cGMP. Processors are required to use processes that achieve a 5-log, or 100,000-fold, reduction in the numbers of the most resistant pathogen (e.g. *E. coli*, *Salmonella*, *Cryptosporidium parvum*) in their finished products compared to levels that may be present in untreated juice. Juice processors may use microbial reduction methods other than pasteurization, including approved alternative technologies (such as the recently approved UV irradiation technology) or a combination of techniques. Citrus processors may opt to apply the 5-log pathogen reduction on the surface of the fruit, in combination with microbial testing to assure that this process is effective. Processors making shelf-stable juices or concentrates that use a single thermal processing step are exempt from the microbial hazard requirements of the HACCP regulation. The guidance document on Juice HACCP is available on-line ([CFSAN, 2004](#)).

Juice used as an ingredient in foods other than beverages (e.g. fruit-flavored candy) does not have to comply with the HACCP regulations. Juice concentrates intended for uses such as flavors or sweeteners are not included because they are not used in beverages. Fruit and vegetable purees or pulp used as an ingredient in beverages must comply.

There is a retail exemption for providing directly to consumers. A retailer does not sell or distribute to other business entities, for example a juice bar or produce stand. Imports and exports must comply.

For more specific information see: Title 21 part 146 specific juices; Title 21 part 73.250 fruit juice color additives; and Title 21 part 110 cGMP.

## 14.5 Milk and Milk Products

One of FDA's responsibilities under the Federal Food, Drug and Cosmetic Act is the regulation of foods shipped in interstate commerce, including milk and milk products. The National Conference on Interstate Milk Shipments (NCIMS) is a voluntary organization directed and controlled by the member states, and open to all persons interested in its objective of promoting the availability of a high-quality milk supply. It is governed by an Executive Board whose members include representatives from state departments of health and agriculture, FDA, USDA, and industry. Through these collaborative efforts, the NCIMS have developed a cooperative, federal-state program (the Interstate Milk Shipper Program) to ensure the sanitary quality of milk and milk products shipped interstate. The program is operated

primarily by the states, with FDA providing varying degrees of scientific, technical, and inspection assistance as provided by FDA Publication No.72-2022, “Procedures Governing the Cooperative State-Public Health Service/Food and Drug Administration Program for Certification of Interstate Milk Shippers” (“Procedures Manual”).

The Interstate Milk Shipper Program relies upon the Grade “A” Pasteurized Milk Ordinance (PMO) and related technical documents referred to in the Procedures Manual for sanitary standards, requirements, and procedures to ensure the safety and wholesomeness of Grade A milk and milk products. The PMO is the basic standard used for the certification of interstate milk shipments in all 50 states. The PMO is incorporated by reference in federal specifications for procurement of milk and milk products, and is widely recognized as a national standard for milk sanitation. Grade A PMO is: “An ordinance to regulate the production, transportation, processing, handling, sampling, examination, labeling, and sale of Grade ‘A’ milk and milk products; the inspection of dairy farms, milk plants, receiving stations, transfer stations, milk tank truck cleaning facilities, milk tank trucks and bulk milk hauler/samplers; the issuing and revocation of permits to milk producers, bulk milk hauler/samplers, milk tank trucks, milk transportation companies, milk plants, receiving stations, transfer stations, milk tank truck cleaning facilities, haulers, and distributors; and the fixing of penalties” (FDA, 2009b).

Milk and milk products intended for interstate sale are subject to the Interstate Conveyance Sanitation regulations. State and local regulations vary regarding sale of milk products, such as who can purchase unpasteurized milk from a dairy farm. Sources of Grade A milk and milk products intended for use on interstate conveyances are subject to the Interstate Conveyance Sanitation regulations (21 CFR 1250). They are considered approved for purposes of 21 CFR 1250.26, if they have a state or local permit, are under the routine inspection of a state or local regulatory agency and meet the provisions of the Procedures Manual.

## 14.6 Pasteurization

The process of pasteurization was named after Louis Pasteur, who discovered that spoilage organisms could be inactivated in wine by applying heat at temperatures below its boiling point. Pasteurization has historically been defined only in certain foods such as milk, fruit juices, and liquid egg products, and treatment requirements vary between individual foods. Historically, the parameters for pasteurization in these designated products have been defined as heat treatments sufficient to remove specified pathogenic organisms. For example, minimum temperature and time requirements for milk pasteurization are based on thermal death time studies for *Coxelliae burnettii*, the most heat-resistant pathogen found in milk.

Therefore, time-temperature treatments approved for milk (pasteurized) produce a 5-log reduction in *Coxelliae burnettii* using an approved heat treatment. For fruit juice, “under the [Juice HACCP] rule, the 5-log reduction must be targeted to the ‘pertinent pathogen.’ The ‘pertinent pathogen’ is the most resistant microorganism of public health concern that may occur in the juice. The pertinent pathogen may vary with the type of juice and the type of treatment used, though typically it would be a *Salmonella* sp. or *Escherichia coli* O157:H7”.

With the passing of the 2002 Farm Bill (Farm Security and Rural Investment Act), FDA was required to review (by petition) alternative food processing technologies for their equivalence to pasteurization, and make a determination of the appropriateness of the “pasteurization” label. At this time, no additional guidance has been published by FDA regarding its planned expansion of the definition of pasteurization to include alternative, non-thermal technologies.

## 15. CANNED FOODS

Canned foods (hermetically sealed containers) have specific regulatory requirements, with the exception of alcoholic beverages and carbonated beverages. These requirements vary depending on the classification of the food product. Canned foods are classified into four categories depending on pH and water activity under the FFDCA: acid, acidified, low-acid, and exempt (FDA, 2009c). Water activity is the amount of free water available to support bacterial growth and ranges from 0 to 1.0. If the finished food has a water activity less than 0.85 the food is considered exempt from these acid regulations. Most common foods (meat, fruit, vegetables) have a water activity between 0.90 and 1.0. Adding salts and sugars can lower water activity. However, all foods must still be processed under cGMP and apply appropriate food labeling regulations. Every processing facility that processes low-acid or acidified food products must be registered with FDA (FDA, 2009d). The official process for each product container combination must also be filed (FDA Form 2541a) and signed by a process authority.

Low-acid canned foods (LACF) are those with a pH greater than 4.6 and a water activity greater than 0.85. Many foods (meats and vegetables) fit this category. Federal regulations require that processors register and file processing information with the FDA LACF Registration Coordinator and must comply with mandatory provisions of 21 CFR 108, 110, 113, and 114.

Acidified foods are defined as those low-acid foods which have had their pH reduced to 4.6 or below by the addition of acids or acid foods. Examples include pickles, relishes, pickled vegetables (beets, cauliflower, etc.), salsa, and barbecue sauces. Any product that uses a combination of vinegar or other acid, and acid foods (e.g. tomatoes, tropical fruits, peppers) is an acidified food. According to

21 CFR 114.80(a)(1) all acidified foods "... shall be thermally processed to an extent that is sufficient to destroy the vegetative cells of microorganisms of public health significance and those of non-health significance capable of reproducing in the food under the conditions in which food is stored, distributed, retailed, and held by the user". Official processes for acidified foods include maximum pH as well as thermal processes. The thermal processes methods are often described as "hot fill/hold" or "hot water bath/steam bath".

Acid foods are foods that have a natural pH of 4.6 or below. "Natural pH" means the pH prior to processing. However, if a processor receives an acid food (including fermented foods with a pH of 4.6 or below) and during processing allows the pH to rise above 4.6 (through washing, lye peeling, etc.) and then adds an acid or acid food to reduce the pH to 4.6 or below, that product would be considered an acidified food. Thus, it would need to meet 21 CFR 114.80, see above.

## 16. FOOD SERVICE/RESTAURANTS

Restaurants and food service establishments that only prepare and serve food (no manufacturing) directly to consumers are not considered food processors. They are regulated by FDA and are usually inspected by state and local authorities under Memorandums of Agreement with FDA. Many states and territories have used the Food Code as a basis for their regulations. An example of the requirements for restaurants and food service establishments can be found for the City of Austin, TX ([Austin-Travis County, TX, 2008](#)). FDA publishes the Food Code every 4 years, with 2009 being the most recent ([FDA, 2009e](#)). The Food Code is a model that assists food control jurisdictions at all levels of government by providing them with a scientifically sound technical and legal basis for regulating the retail and food service segment of the industry (restaurants, grocery stores, and institutions such as nursing homes). Local, state, tribal, and federal regulators use the FDA Food Code as a model to develop or update their own food safety rules and to be consistent with national food regulatory policy.

The Association of Food and Drug Officials (AFDO) reported in June 2005 that 48 of 56 states and territories have adopted food codes patterned after one of the five versions of the Food Code, beginning with the 1993 edition. Those 48 states and territories represent 79% of the US population.

## 17. EXPORT FOODS

The inspection process for imported foods has changed considerably in the last 5 years, with the passage of the Public Health Security and Bioterrorism Preparedness and Response Act of 2002. Inspection of imported foods into the USA became the

responsibility of the United States Customs and Border Protection (CBP) under the Department of Homeland Security in 2003. Memoranda of Agreements between FSIS, APHIS, AMS, FDA, and CBP explain who has inspection responsibility based on the type of food or animal being exported or imported, and tariff/duty fee collection.

Food imported or exported from the USA requires treaties between countries. In developing these treaties, FSIS and FDA representatives work with the Department of State, Department of Commerce, Department of Homeland Security, and Congress to ensure that adequate consideration is given to safety of food being imported or exported. Once treaties have been established, Memoranda of Agreements (MOAs) are created between FSIS or FDA and the food safety agency counterpart in the foreign country regarding inspection criteria for imported or exported products. For example, poultry products being exported to Russia must meet Russian export requirements (FSIS, 2011d). Russia and USDA-FSIS have agreed to these criteria and USDA-FSIS inspectors will inspect and certify (certificate of export) that poultry was produced according to Russian requirements. Russian requirements may be different from US requirements for poultry. These agreements are reviewed annually and renegotiated as appropriate.

USDA-APHIS Veterinary Services (VS) oversees the exportation of live animals and animal products, and issues health certificates on the condition of the original animal. USDA-AMS and FDA are the agencies primarily responsible for certification of dairy products exported for human consumption.

The US Department of Commerce, National Oceanic and Atmospheric Administration is the primary agency responsible for providing certification for fish meal, fish oil, and certain other seafood products. FDA also certifies seafood products, such as blocks of frozen fish. As a recognized authority for exports to European Community member countries, APHIS can provide export background information and certification endorsement for some types of aquacultured fish, shellfish or other products.

Food regulated by FDA requires a Certificate of Export indicating that FDA regulates the product and that the company is not under any enforcement action (FDA, 2009f). In addition, a shipper's export declaration form must be filed with the US Bureau of Customs and Border Protection. AMS has responsibility to provide organic certification for exported products, laboratory testing to certify products for export, and quality grading of exported food. USDA Grain Inspection, Packers and Stockyards Administration (GIPSA) administers the US Grain Standards Act and certifies all grain being exported or imported. In addition, they register all grain companies.

Alcoholic beverages imported or exported must meet the requirements of the FAAA. These federal requirements are enforced by ATF (ATF, 2011b).

## 18. IMPORTED FOODS

Cooperative agreements between CBP, FDA, and USDA ensure inspection of all food, plants, animals and their respective products entering the USA. Companies importing food into the USA must provide prior notice (excluding meat, poultry, and eggs) to FDA for shipment inspection before any food product enters the USA. FDA receives approximately 170,000 prior reviews each week. There is currently a Prior Notice of Imported Foods Website that provides further details ([FDA, 2011d](#)).

Specific information required in the prior notice includes ([FDA, 2011d](#)):

- The complete FDA product code.
- The common or usual name or market name.
- The trade or brand name, if different from the common or usual name, or market name.
- The quantity described from smallest package size to largest container.
- The lot or code numbers or other identifier of the food if applicable.
- The manufacturer.
- All growers, if known.
- The country from which the article originates.
- The shipper.
- The country from which the article of food was shipped.
- The anticipated arrival information.
- Information related to US Customs entry process.
- The importer, owner, and consignee.
- The carrier.

FSIS has the statutory authority to require countries/companies that produce meat and poultry products for import to the USA have equivalent food safety systems. Although foreign food regulatory systems need not be identical to the US system, they must employ equivalent sanitary measures that provide the same level of protection against food hazards as is achieved domestically. FSIS determines equivalency by performing records review, on-site inspection visits, and port-of-entry inspections. In addition, all meat, poultry, and eggs must meet FSIS labeling requirements. FSIS has responsibility for inspection of imported shell eggs from all countries. However, Memoranda of Understanding allow AMS to conduct these tasks on behalf of FSIS.

Under FSMA, FDA does have statutory authority to require that countries shipping food (excluding meat, poultry, and egg products) have equivalent food safety systems. Final regulations on these requirements are still under development. FDA periodically inspects individual producers of imported US foods during the year. FDA inspectors require that foods meet US food regulations (e.g. cGMP). In addition, all food companies importing acidified or low-acid food into the USA must obtain, prior to shipping, food canning establishment number and have an approved process on file with FDA ([FDA, 2009f](#)).

APHIS National Center of Import and Export has responsibility to monitor the health of animals presented at the border, and to regulate the import and export of animals, animal products, and biologics.

For further questions on importing or exporting foods contact the Foreign Agricultural Service (FAS). They assist companies in completing paperwork and direct them to appropriate regulatory agencies for permits, reviews, and certificates of export (FAS, 2011).

## 19. CONCLUSIONS

Food regulations in the USA are a patchwork of federal agencies based on 100 years of history. For the food process engineer, it is difficult to become an expert in food law, and detailed focus should be given to areas of greatest priority. Prior to initiating any formal work in building, testing, or evaluating a “new” piece of equipment, contact should be made with the appropriate federal agency(ies) depending on what food will be processed, handled, or packaged. This agency can provide guidance regarding what procedures need to be followed and designated responsibilities for the regulatory agency and equipment manufacturer. In closing, it should be stated that the existing US food safety system, although far from perfect, does provide for high-quality and safe foods to be enjoyed by the consumer. The open decision making process, based on scientific knowledge, is seen as a role model for many countries.

## 20. ACRONYMS

<b>AFDO</b>	Association of Food and Drug Officials
<b>AMS</b>	Agricultural Marketing Service
<b>APHIS</b>	Animal and Plant Health Inspection Service
<b>ARS</b>	Agricultural Research Service
<b>CBP</b>	Customs and Border Protection
<b>CCP</b>	Critical Control Points
<b>CFR</b>	Code of Federal Regulations
<b>cGMP</b>	Current Good Manufacturing Practices
<b>CRS</b>	Congressional Research Service
<b>DAL</b>	Defect Action Level
<b>DHHS</b>	Department of Health and Human Services
<b>EPA</b>	Environmental Protection Agency
<b>EPIA</b>	Egg Products Inspection Act
<b>FAS</b>	Foreign Agricultural Service
<b>FDA</b>	Food and Drug Administration
<b>FFDCA</b>	Federal Food Drug and Cosmetic Act
<b>FIFRA</b>	Federal Insecticide, Fungicide, Rodenticide Act
<b>FPA</b>	Food Products Association
<b>FR</b>	Federal Register
<b>FSIS</b>	Food Safety Inspection Service

<b>GIPSA</b>	Grain Inspection, Packers and Stockyards Administration
<b>GMP</b>	Good Manufacturing Practices
<b>HACCP</b>	Hazard Analysis of Critical Control Points
<b>ISSC</b>	Interstate Shellfish Sanitation Conference
<b>LACF</b>	Low-Acid Canned Food
<b>MOA</b>	Memorandum of Agreements
<b>MOU</b>	Memorandums of Understanding
<b>NACMCF</b>	National Advisory Committee Microbiological Criteria I Food Documentation
<b>NASS</b>	National Agricultural Statistics Service RTE Ready-to-eat
<b>NCFST</b>	National Center for Food Safety and Technology
<b>NCIMS</b>	National Conference on Interstate Milk Shipments
<b>NPIP</b>	National Poultry Improvement Plan
<b>NSSP</b>	National Shellfish Sanitation Program
<b>PACA</b>	Perishable Agricultural Commodities Act
<b>PMO</b>	Pasteurized Milk Ordinance
<b>SE</b>	<i>Salmonella enteritidis</i>
<b>SPS</b>	Sanitation Performance Standards
<b>SSOP</b>	Sanitation Standard Operating Procedures
<b>USDA</b>	United States Department of Agriculture
<b>VS</b>	Veterinary Service

## REFERENCES

- AMS, 2007. Shell Egg Grading and Certification. United States Department of Agriculture Agricultural Marketing Service, Washington, D.C. <<http://www.ams.usda.gov/AMSv1.0/ams.fetchTemplateData.do?template=TemplateN&navID=Grading&Standards&rightNav1=Grading&Standards&topNav=&leftNav=GradingCertificationandVerification&page=PYShellEggGradingandCertification3&resultType=&acct=poultrygrd>> (Last accessed 19.10.11.).
- AMS, 2011. Fruit and Vegetable Programs. United States Department of Agriculture Agricultural Marketing Service, Washington, D.C. <<http://www.ams.usda.gov/AMSv1.0/getfile?dDocName=STELPRDC5088062>> (Last accessed 19.10.11.).
- ATF, 2011a. Bureau of Alcohol, Tobacco, Firearms and Explosives. United States Department of Justice Bureau of Alcohol Tobacco, Firearms and Explosives, Washington, D.C. <<http://www.ttb.gov/other/regulations.shtml>> (Last accessed 21.10.11.).
- ATF, 2011b. Bureau of Alcohol, Tobacco, Firearms and Explosives. United States Department of Justice Bureau of Alcohol Tobacco, Firearms and Explosives, Washington, D.C. <<http://www.ttb.gov/importers/index.shtml>> (Last accessed 21.10.11.).
- Austin-Travis County, TX, 2008. Starting a Food Business. Environmental & Consumer Health Unit, Austin-Travis County Health and Human Services Department, Austin, TX. <<http://www.ci.austin.tx.us/sbdp/downloads/startfoodbus.pdf>> (Last accessed 21.10.11.).
- CDC, 2011. Estimates of Foodborne Illness in the United States. Center for Disease Control and Prevention. United States Department of Health and Human Services, Washington, D.C. <<http://www.cdc.gov/foodborneburden/>> (Last accessed 19.10.11.).
- CFR, 2011a. Code of Federal Regulations. National Archives and Records Administration Code of Federal Regulations, Government Printing Office, Washington, D.C. <<http://www.gpo.gov/fdsys/browse/collectionCfr.action?collectionCode=CFR>> (Last accessed 19.10.11.).
- CFR, 2011b. Title 9 Animals and Animal Products, Part 416 Sanitation. National Archives and Records Administration Code of Federal Regulations, Government Printing Office, Washington, D.C. <<http://www.gpo.gov/fdsys/pkg/CFR-2011-title9-vol2/pdf/CFR-2011-title9-vol2-part416.pdf>> (Last accessed 19.10.11.).



- CFR, 2011c. Title 21 Food and Drugs, Part 110 Current Good Manufacturing Practice in Manufacturing, Packing or Holding Human Food. National Archives and Records Administration Code of Federal Regulations, Government Printing Office, Washington, D.C. <<http://www.gpo.gov/fdsys/pkg/CFR-2011-title21-vol2/pdf/CFR-2011-title21-vol2-part110.pdf>> (Last accessed 19.10.11.).
- CFSAN, 2000. Guidance for Industry: Action Levels for Poisonous or Deleterious Substances in Human Food and Animal Feed. Center for Food Safety and Applied Nutrition, United States Department of Health and Human Services Food and Drug Administration, Rockville, MD. <<http://www.fda.gov/Food/GuidanceComplianceRegulatoryInformation/GuidanceDocuments/ChemicalContaminantsandPesticides/ucm077969.htm>> (Last accessed 19.10.11.).
- CFSAN, 2004. Center for Food Safety and Applied Nutrition. United States Department of Health and Human Services Food and Drug Administration, Rockville, MD. <<http://www.fda.gov/Food/GuidanceComplianceRegulatoryInformation/GuidanceDocuments/Juice/ucm072557.htm>> (Last accessed 21.10.11.).
- CFSAN, 2011a. Seafood HACCP Regulations. Center for Food Safety and Applied Nutrition, United States Department of Health and Human Services Food and Drug Administration, Rockville, MD. <<http://www.fda.gov/Food/FoodSafety/HazardAnalysisCriticalControlPointsHACCP/SeafoodHACCP/default.htm>> (Last accessed 21.10.11.).
- CFSAN, 2011b. National Shellfish Sanitation Program. Center for Food Safety and Applied Nutrition, United States Department of Health and Human Services Food and Drug Administration, Rockville, MD. <<http://www.fda.gov/Food/FoodSafety/Product-SpecificInformation/Seafood/FederalStatePrograms/NationalShellfishSanitationProgram/default.htm>> (Last accessed 21.10.11.).
- CRS, 2011. Seafood Marketing: Combating Fraud and Deception. Congressional Research Service. United States Congress, Washington, DC. <<http://www.nationalaglawcenter.org/assets/crs/RL34124.pdf>> (Last accessed 21.10.11.).
- EPA, 2011. Ground Water and Drinking Water. United States Environmental Protection Agency, Washington, D.C. <<http://water.epa.gov/drink/contaminants/index.cfm>> Last accessed 10/21/2011.
- FAS, 2011. Foreign Agricultural Service. Foreign Agricultural Service, United States Department of Agriculture, Washington, DC. <<http://www.fas.usda.gov/>> (Last accessed 21.10.11.).
- FDA, 2000. Final Rule: Food Labeling, Safe Handling Statements, Labeling of Shell Eggs; Refrigeration of Shell Eggs Held for Retail Distribution. United States Department of Health and Human Services Food and Drug Administration, Rockville, MD, Federal Register of December 5, 2000 (65 FR 76092). <<http://www.fda.gov/ohrms/dockets/dockets/06p0394/06p-0394-cp00001-37-Tab-34-FR-Rules-Regulations-vol1.pdf>> (Last accessed 21.10.11.).
- FDA, 2009a. Sanitary Food Transportation Act of 1990. United States Department of Health and Human Services Food and Drug Administration, Rockville, MD. <<http://www.fda.gov/regulatoryinformation/legislation/ucm148790.htm>> (Last accessed 19.10.11.).
- FDA, 2009b. Grade A Pasteurized Milk Ordinance 2009. Center for Food Safety and Applied Nutrition, United States Department of Health and Human Services Food and Drug Administration, Rockville, MD. <<http://www.fda.gov/downloads/Food/FoodSafety/Product-SpecificInformation/MilkSafety/NationalConferenceonInterstateMilkShipmentsNCIMSMModelDocuments/UCM209789.pdf>> (Last accessed 21.10.11.).
- FDA, 2009c. Federal Food Drug and Cosmetic Act Chapter IV: Food. Center for Food Safety and Applied Nutrition, United States Department of Health and Human Services Food and Drug Administration, Rockville, MD. <<http://www.fda.gov/RegulatoryInformation/Legislation/FederalFoodDrugandCosmeticActFDCAct/FDCActChapterIVFood/default.htm>> (Last accessed 21.10.11.).
- FDA, 2009d. Establishment Registration. United States Department of Health and Human Services Food and Drug Administration, Rockville, MD. <<http://www.fda.gov/Food/FoodSafety/Product-SpecificInformation/AcidifiedLow-AcidCannedFoods/EstablishmentRegistrationThermalProcessFiling/Instructions/ucm125590.htm>> (Last accessed 21.10.11.).

- FDA, 2009e. Food Code 2009. United States Department of Health and Human Services Food and Drug Administration, Rockville, MD. <<http://www.fda.gov/Food/FoodSafety/RetailFoodProtection/FoodCode/FoodCode2009/>> (Last accessed 21.10.11.).
- FDA, 2009f. Procedure for Obtaining Certificates for Export of Foods and Cosmetics. United States Department of Health and Human Services Food and Drug Administration, Rockville, MD. <<http://www.fda.gov/RegulatoryInformation/Guidances/ucm122048.htm>> (Last accessed 21.10.11.).
- FDA, 2010. Registration of Food Facilities. United States Department of Health and Human Services Food and Drug Administration, Rockville, MD. <<http://www.fda.gov/Food/GuidanceComplianceRegulatoryInformation/RegistrationofFoodFacilities/default.htm>> (Last accessed 19.10.11.).
- FDA, 2011a. Food and Drug Administration. United States Department of Health and Human Services Food and Drug Administration, Rockville, MD. <<http://www.fda.gov/Food/FoodSafety/Product-SpecificInformation/AcidifiedLow-AcidCannedFoods/EstablishmentRegistrationThermalProcessFiling/Instructions/ucm2007436.htm>> (Last accessed 19.10.11.).
- FDA, 2011b. Food Safety Modernization Act. United States Department of Health and Human Services Food and Drug Administration, Rockville, MD. <<http://www.fda.gov/food/foodsafety/fma/default.htm>> (Last accessed 19.10.11.).
- FDA, 2011c. Compliance Policy Guides: Beverages. United States Department of Health and Human Services Food and Drug Administration, Rockville, MD. <<http://www.fda.gov/ICECI/ComplianceManuals/CompliancePolicyGuidanceManual/ucm119194.htm>> (Last accessed 21.10.11.).
- FDA, 2011d. Prior Notice of Imported Foods. United States Department of Health and Human Services Food and Drug Administration, Rockville, MD. <<http://www.fda.gov/food/guidancecompliance-regulatoryinformation/priornoticeofimportedfoods/default.htm>> (Last accessed 21.10.11.).
- Federal Register, 2011. The Federal Register. National Archives and Records Administration Federal Register, Government Printing Office, Washington, D.C. <<http://www.gpo.gov/fdsys/browse/collection.action?collectionCode=FR>> (Last accessed 19.10.11.).
- FSIS, 2010a. Egg Product Inspection Act. United States Department of Agriculture Food Safety Inspection Service, Washington, D.C. <<http://www.fsis.usda.gov/regulations/EPIA/index.asp>> (Last accessed 19.10.11.).
- FSIS, 2010b. Focus on: Hot Dogs. United States Department of Agriculture Food Safety Inspection Service, Washington, D.C. <[http://www.fsis.usda.gov/Fact\\_Sheets/Hot\\_Dogs/](http://www.fsis.usda.gov/Fact_Sheets/Hot_Dogs/)> (Last accessed 19.10.11.).
- FSIS, 2011a. Meat Products Inspection Act. United States Department of Agriculture Food Safety Inspection Service, Washington, D.C. <[http://www.fsis.usda.gov/Regulations\\_& Policies/Federal\\_Meat\\_Inspection\\_Act/index.asp](http://www.fsis.usda.gov/Regulations_& Policies/Federal_Meat_Inspection_Act/index.asp)> (Last accessed 19.10.11.).
- FSIS, 2011b. Poultry Products Inspection Act. United States Department of Agriculture Food Safety Inspection Service, Washington, D.C. <[http://www.fsis.usda.gov/Regulations\\_& Policies/Poultry\\_Products\\_Inspection\\_Act/index.asp](http://www.fsis.usda.gov/Regulations_& Policies/Poultry_Products_Inspection_Act/index.asp)> (Last accessed 19.10.11.).
- FSIS, 2011c. Focus on Shell Eggs. United States Department of Agriculture Food Safety Inspection Service, Washington, D.C. <[http://www.fsis.usda.gov/Fact\\_Sheets/Focus\\_On\\_Shell\\_Eggs/index.asp](http://www.fsis.usda.gov/Fact_Sheets/Focus_On_Shell_Eggs/index.asp)> (Last accessed 19.10.11.).
- FSIS, 2011d. Export Requirements for Russia. United States Department of Agriculture Food Safety Inspection Service, Washington, D.C. <[http://www.fsis.usda.gov/Regulations\\_& Policies/Russia\\_Requirements/index.asp](http://www.fsis.usda.gov/Regulations_& Policies/Russia_Requirements/index.asp)> (Last accessed 21.10.11.).
- FTC, 2011. Fair Packaging and Labeling Act. Federal Trade Commission, Washington, D.C. <<http://www.ftc.gov/os/statutes/fplajump.html>> (Last accessed 19.10.11.).
- NACMCF, 2009. HACCP Principles and Application Guidelines. Center for Food Safety and Applied Nutrition, United States Department of Health and Human Services Food and Drug Administration, Rockville, MD. <<http://www.cfsan.fda.gov/~comm/nacmcfp.html>> (Last accessed 19.10.11.).
- State of Texas. 2011. Agriculture code subtitle c chapter 91. <<http://www.statutes.legis.state.tx.us/Docs/AG/htm/AG.91.htm>> (Last accessed 21.10.11.).

- TTB, 2011. Alcohol and Tobacco Tax and Trade Bureau. United States Department of Treasury, Alcohol and Tobacco Tax and Trade Bureau, Washington, D.C. <<http://www.ttb.gov/about/index.shtml>> (Last accessed 19.10.11.).
- US Code, 2011a. United States Code. National Archives and Records Administration United States Code, Government Printing Office, Washington, D.C. <<http://www.gpo.gov/fdsys/browse/collectionUSCode.action?collectionCode=USCODE>> (Last accessed 19.10.11.).
- US Code, 2011b. Title 27 Intoxication Liquors Chapter 8 Federal Alcohol Administration Act. National Archives and Records Administration United States Code, Government Printing Office, Washington, D.C. <<http://uscode.house.gov/download/pls/27C8.txt>> (Last accessed 21.10.11.).

# Food Safety Engineering

Raghupathy Ramaswamy, Juhee Ahn, V.M. Balasubramaniam, Luis Rodriguez

Saona and Ahmed E. Yousef

Ohio State University, OH, USA

## 1. INTRODUCTION

Over the past few decades, food safety has been a high priority for the US food industry, regulatory agencies, and the public. Providing a safe food product is a complex process requiring proper control throughout the entire food production and consumption chain (IFT, 2002; Jaykus *et al.*, 2004). The US food supply is among the safest in the world. However, despite great achievements in the area of microbiological food safety, much remains to be done (IFT, 2002). Everyone in the farm-to-fork system shares the responsibility for food safety. Increased awareness and concern regarding food safety have led to continuous development in novel processing technologies and detection methods. Advances in engineering, microbiology, chemistry, and other disciplines have brought tremendous improvements in food safety and quality. These advances, for example, raised the criteria for food safety, in relevance to toxicants, from parts per million to parts per billion levels. Food safety engineering is an emerging specialization involving the application of engineering principles to address microbial and chemical safety challenges. The principles can be applied in the development of intervention technologies for food decontamination and preservation. Engineering principles integrated with microbiology and chemistry concepts hold great potential in developing non-conventional solutions to imminent food safety problems. Safety breaches can develop during production, processing, storage, and distribution of food. Food safety engineering principles can be applied in:

- Control of microorganisms at the food source and in raw material selection.
- Product design and process control.
- Application of Good Hygienic/Manufacturing Practices (GHPs/GMPs).
- Implementation of the Hazard Analysis and Critical Control Point (HACCP) system throughout the food chain (FAO/WHO, 2001; ICMSE, 2002).

This chapter provides a review of the current status of various novel intervention and detection technologies, and highlights the importance of applying engineering principles to solve food safety problems. As a result of the multidisciplinary nature of food safety engineering and space constraints of the chapter, the intervention

technologies and detection methods discussed here should be considered as illustrative examples for food safety engineering and not necessarily a comprehensive review of the subject.

## 2. INTERVENTION TECHNOLOGIES

Conventional food processing methods relied on thermal treatment to kill/inactivate microbiological contaminants. Unfortunately, thermal processing induces physical and chemical changes in the food. Chemical preservatives and naturally occurring antimicrobial compounds also have been used extensively for food preservation (Brul and Coote, 1999). Over the last two decades, a number of alternative non-thermal intervention technologies have evolved, specifically to address microbial contamination and satisfy consumer demand for “fresh”, minimally processed foods.

### 2.1 Novel Non-Thermal Intervention Technologies

An expert panel, assembled by the Institute of Food Technologists (IFT), comprehensively reviewed a number of emerging alternative technologies (IFT, 2000). The panel recommended that researchers identify pathogens of public health concern that are most resistant to various technologies, and suggested ways to validate the effectiveness of these technologies against microbial contaminants. Many of these technologies are in transition from the pilot-plant research stage to the real world of commercial food processing, and are expected to play an increasing role in food processing in the future.

#### 2.1.1 High-Pressure Processing

High-pressure processing (HPP) is a method whereby food is subjected to elevated pressures (up to 700 MPa), with or without the addition of heat, to achieve microbial inactivation or to alter the food attributes in order to achieve consumer-desired qualities (Cheftel and Culioli, 1995; Farkas and Hoover, 2000; Ramaswamy *et al.*, 2004; Smelt, 1998). HPP retains food quality, maintains natural freshness, and extends the microbiological shelf-life of the food. The process is also known as high hydrostatic pressure processing (HHP) and ultra high-pressure processing (UHP). HPP can be used to process both liquid and solid foods. Foods with a high acid content are particularly good candidates for HPP technology. Examples of high-pressure processed products commercially available in the USA include fruit smoothies, guacamole, ready meals with meat and vegetables, oysters, ham, chicken strips, fruit juices, and salsa. Low-acid, shelf-stable products such as soups are not commercially available yet because of the limitations in killing spores with pressure treatment alone. This is a topic of current research.

Pressure acts equally at all points of the product, in contrast to the thermal treatment which is associated with large temperature gradients resulting in heat-induced changes such as, denaturation, browning, or film formation (Cheffel and Culioli, 1995). Pressure treatments, with pressures between 200 and 600 MPa, are effective in inactivating most of the vegetative microorganisms (Table 3.1). Microorganisms in exponential phase growth are more pressure sensitive than those in stationary phase and Gram-positive organisms are more resistant than Gram-negatives. Reports indicate that HPP can also be successfully used as an intervention against hepatitis A virus in oysters and noroviruses (Bricher, 2005a; Calci *et al.*, 2005). Studies on the efficacy of HPP on spore inactivation have shown that bacterial spore inactivation requires a combination of elevated pressures and moderate temperatures. To date, only a limited number of *Clostridium botulinum* strains have been tested. Non-proteolytic type B spores appear to be the most pressure resistant spore-forming pathogens found to date (Balasubramaniam, 2003; Okazaki, *et al.*, 2000; Reddy *et al.*, 2003). Among the endospore formers, *Bacillus amyloliquefaciens* produces the most pressure resistant foodborne spores found to date (Margosch *et al.*, 2004a; Rajan *et al.*, 2006a).

### 2.1.2 Pulsed Electric Field Processing

Destruction of microorganisms by pulsed electric field processing (PEF) is achieved by the application of short high-voltage pulses between a set of electrodes causing disruption of microbial cell membranes (Devlieghere *et al.*, 2004). PEF processing involves treating foods placed between electrodes with high voltage pulses in the order of 20–80 kV/cm (in the  $\mu\text{s}$  range). Zhang *et al.* (1995) detail the engineering aspects of pulsed electric field pasteurization. Currently the technology is primarily applicable for pumpable food products. Many vegetative cells of bacteria, molds, and yeasts are inactivated by the PEF technology. Bacterial spores, however, are not inactivated (Butz and Tauscher, 2002). Gram-positive bacteria tend to be more resistant to PEF than are Gram-negatives, whereas yeasts show a higher sensitivity than bacteria (Devlieghere *et al.*, 2004).

The short, high-voltage pulses break the cell membranes of vegetative microorganisms in liquid media by expanding existing pores (electroporation) or creating new ones (Heinz *et al.*, 2001; Vega-Mercado *et al.*, 1997). Pore formation is reversible or irreversible depending on factors such as the electric field intensity, the pulse duration, and number of pulses. The membranes of PEF-treated cells become permeable to small molecules, permeation causing swelling, and eventual rupture of the cell membrane. The numerous critical process factors, broad experimental conditions, and diversity of equipment make it difficult to define precisely the processing parameters essential for microbial inactivation. Wouters *et al.* (2001) lists the various information required to identify and compare the effectiveness of different PEF processes.

**Table 3.1** Application of High Pressure Processing for Microbial Inactivation in Different Foods

Microorganism	Treatment (pressure, MPa; temperature, °C; Log time, min.)	Reduction	Substrate	Reference
<b>Vegetative Bacteria</b>				
<i>Campylobacter jejuni</i>	300, 25, 10	6	Poultry	Patterson, 2004
<i>C. jejuni</i>	400, 25, 10	6	Pork	Shigehisa et al., 1991
<i>Escherichia coli</i> O157:H7	350, 40, 5	>8	Juices	Bayindirli et al., 2006
<i>E. coli</i> O157:H7	475, 40, 8	2	Alfalfa	Ariefdjohan et al., 2004
<i>Listeria innocua</i>	400, 20, 20	5	Beef	Carlez et al., 1993
<i>Salmonella enterica</i>	350, 40, 5	>8	Juices	Bayindirli et al., 2006
<i>Salmonella</i> Typhimurium	400, 25, 10	6	Pork	Shigehisa et al., 1991
<i>Staphylococcus aureus</i>	500, 50, 15	>4	Caviar	Fioretto et al., 2005
<i>Vibrio parahaemolyticus</i>	170, 23, 10	>5	Cheese	Patterson, 2004
<i>Yersinia enterocolitica</i>	400, 25, 10	6	Pork	Shigehisa et al., 1991
<b>Spore-Forming Bacteria</b>				
<i>Alicyclobacillus acidoterrestris</i>	621, 90, 1	6	Apple	Lee et al., 2002
<i>Bacillus cereus</i>	600, 60, 10	7	Milk	van Opstal et al., 2004
<i>Bacillus stearothermophilus</i>	600, 90, 40	>5	Cocoa	Ananta et al., 2001
<i>B. stearothermophilus</i>	600, 120, 20	>6	Broccoli	Ananta et al., 2001
<i>B. stearothermophilus</i>	700, 105, 5	>4	Egg patties	Rajan et al., 2006b
<i>Clostridium botulinum</i>	600, 80, 16	>4	Carrot	Margosch et al., 2004b
<i>C. botulinum</i>	827, 75, 20	3	Crabmeat	Reddy et al., 2003
<i>Clostridium sporogenes</i>	800, 90, 5	>5	Broth	Patterson, 2004
<b>Molds and Yeasts</b>				
<i>Candida utilis</i>	400, 25, 10	6	Pork	Shigehisa et al., 1991
<i>Penicillium roqueforti</i>	400, 20, 20	6	Cheese	O'Reilly et al., 2000
<i>Saccharomyces cerevisiae</i>	100, 47, 5	3	Juice	Patterson, 2004
<b>Virus</b>				
Calicivirus	275, 21, 5	7	Broth	Patterson, 2004
Hepatitis A virus	400, 9, 1	3	Oyster	Calci et al., 2005
Hepatitis A virus	375, 30, 5	>4	Strawberry	Kingsley et al., 2005
Hepatitis A virus	375, 30, 5	>4	Onion	Kingsley et al., 2005
Poliovirus	450, 21, 5	8	Broth	Patterson, 2004

### 2.1.3 Irradiation

In 1990, irradiation (ionizing radiation, referred to as “cold pasteurization”) was approved by the Food and Drug Administration (FDA) as a safe and effective microbial reduction method for specific foods, including, spices, poultry and eggs, red meats, seafood, sprouts, and fruits and vegetables (Farkas, 1998; Henkel, 1998). Ionizing radiation includes gamma rays (from Cobalt-60 or Cesium-137), beta rays generated by electron beam and X-rays (Thayer, 2003). These radiations supply the energy needed for removing electrons from atoms to form ions or free radicals, but this is not high enough to make the treated products radioactive. The freed electrons collide and break the chemical bonds in the microbial DNA molecules, destroying the microbe (Smith and Pillai, 2004). The level of microbial reduction is dependent on the dose (kGy) absorbed by the target food (Olson, 1998).

The key factors that control the resistance of microbial cells to ionizing radiation are the size of the organism (the smaller the target organism, the more resistant it is), type of organism, number and relative “age” of the cells in the food sample, and presence or absence of oxygen. The composition of the food also affects microbial responses to irradiation (Smith and Pillai, 2004). Radiation treatment at doses of 2–7 kGy (depending on condition of irradiation and the food) can effectively eliminate potentially pathogenic non-spore-forming bacteria, such as *Salmonella* spp., *Staphylococcus aureus*, *Campylobacter jejuni*, *Listeria monocytogenes*, and *Escherichia coli* O157:H7, without affecting sensory, nutritional, and technical qualities (Farkas, 1998). Irradiation can be used as a terminal treatment eliminating the possibility of post-process contamination.

FDA labeling requirements call for inclusion of the “radura” symbol and printing of the words “treated by irradiation” on the package (US GPO, 2003). The packaging material chosen for irradiation must satisfy appropriate food additive regulation (21 CFR 179.45), or have a generally recognized as safe (GRAS) status (Lee, 2004). Mittendorfer *et al.* (2002) discussed the status and prospects of applying electron beam irradiation in decontaminating food packaging materials. They reported that an electron beam treatment at a dose of 5–7 kGy is most effective against yeast and mold, which are mainly responsible for spoilage and short shelf-life of a variety of products.

### 2.1.4 Ultraviolet Disinfection

Shortwave ultraviolet light (UVC, 254 nm) can be applied to reduce the microbial load in air or on food contact surfaces free from food residues (Bintsis *et al.*, 2000). It can also eliminate pathogens from filtered potable water. Radiation in the range 250–260 nm is lethal to most of the microorganisms, including bacteria, viruses, protozoa, mycelial fungi, yeasts, and algae (Bintsis *et al.*, 2000). The damage inflicted by UVC involves specific target molecules, and a dose of 0.5–20 Jm<sup>-2</sup> leads to lethality by directly altering microbial DNA through dimer formation (Ferron *et al.*, 1972).



Once the DNA is damaged, the reproductive capability and hence the disease-causing ability of the microorganisms is eliminated. UVC treatment was reported to increase the resistance of carrot tissues to fungal pathogens by accumulation of an isocoumarin, phytoalexin 6-methoxymellein (Mercier *et al.*, 1994).

Longwave UV light (UVA, >320 nm) has limited microbial properties but this can be enhanced by the addition of photosensitive compounds (e.g. furocoumarins). Penetration of UVA into water is better than that of UVC (Bintsis *et al.*, 2000). Key factors that determine the efficacy of UV treatment include UV reactor design, fluid dynamic parameters, and absorptive properties. Suspended particles can negatively impact disinfection efficiency because of additional absorbance, scattering, and/or blocking of UV light (Liltved and Cripps, 1999). By maintaining a thin layer of flow or by creating turbulence within the UV reactor, the treatment effect can be increased (Koutchma *et al.*, 2004).

A combination of filters (suited to remove particles of size >0.1 µm in laminar flow air) and UV light has been recommended (Shah *et al.*, 1994) for provision of clean sterilized air in a sensitive food manufacturing facility. A combination of UV and ozone has a powerful oxidizing action and can reduce the organic content of water to extremely low levels (WHO, 1994). A technique using a combination of UVC radiation and heat for the production of high-quality raw meat has already been patented (Tanaka and Kawaguchi, 1991). Current FDA regulations (21 CFR 179) stipulate the use of turbulent flow systems in UV reactors in juice processing systems (US GPO, 2003). UV light absorbance is also used in the rapid detection of some microorganisms (Rodriguez *et al.*, 1992). However, exposure to UV light sometimes develops off-flavors (Stermer *et al.*, 1987). The UV radiation equipment is easy to use and relatively inexpensive.

## 2.2 Chemical Interventions

### 2.2.1 Ozone

Ozone was granted FDA GRAS status in 2001, for use as a direct food contact antimicrobial agent. Since then, ozone has been increasingly sought by food processors as an additional intervention to strengthen food safety programs, such as HACCP and GMPs, in and out of the processing plant. Ozone, which is an effective biocide against bacteria, viruses, fungi, and protozoa, has long been successfully used for no-rinse sanitation of food contact surfaces and in clean-in-place (CIP) systems in food plants. Relatively low concentrations of ozone and short contact time are sufficient to inactivate bacteria, molds, yeasts, parasites, and viruses (Kim *et al.*, 1999). Detailed reviews on the science behind ozone and its application in the food industry are available (Guzel-Seydim *et al.*, 2004; Kim *et al.*, 2003). Today, gaseous and aqueous ozone can be used for direct contact on fruit and vegetables, raw and ready-to-eat meat and poultry, fish, and shell egg, making this an intervention that can be used throughout

the entire food production chain. The primary benefit of ozone is that it inactivates microorganisms as effectively as chlorine without any residual chemicals. Research shows that bacterial spores are the most resistant and bacterial vegetative cells are the most sensitive to ozone (Kim *et al.*, 2003). In sanitation and other direct food equipment contact applications, ozone-enriched water was reported to provide a 6-log reduction of *Staphylococcus aureus*, *Salmonella choleraesuis*, and *Pseudomonas aeruginosa*; 5-log reduction of *Escherichia coli*, and a 4-log reduction of both *L. monocytogenes* and *Campylobacter jejuni* (Bricher, 2005a).

Ozone is suspected to kill spores by degrading the outer spore components and exposing the core to the action of the sanitizer. Among the spores resistance to ozone was highest for *Bacillus stearothermophilus* and lowest for *B. cereus*, hence *B. stearothermophilus* can be used as an indicator for testing the efficacy of ozone sanitization (Khadre and Yousef, 2001). These authors also reported that ozone is superior to hydrogen peroxide at killing bacterial spores. One patented ozone-based purification technology claims to be effective at disinfecting, inhibiting, or removing mold growth, reducing contamination and decay, and improving shelf-life (Bricher, 2005a). Ozone in its aqueous form, although compatible with ceramic, glass, silicone, Teflon, and stainless steel, is not suited for application to surfaces made with natural rubbers, polyurethane, or resin-based plastics.

Characteristics of the various intervention technologies are compared in Table 3.2. The efficacies of heat and non-thermal technologies in microbial spore (*Bacillus* spp.) inactivation are compared in Table 3.3.

### 2.2.2 Other Chemical Interventions

One of the most active areas of new technology development is chemical intervention systems, in the form of both direct food additives and secondary additives, or food contact surface treatments. Several antimicrobial chemical treatments recently have been recognized by USDA in its New Technology Information Table as suitable interventions for use in meat and poultry operations (USDA, 2006). Incorporation of antimicrobials into packaging materials has been successfully applied as an intervention technique for products such as meat, poultry and seafood, fresh fruits and vegetables, and for foods in transit or storage (Bricher, 2005a).

Chlorine dioxide (ClO<sub>2</sub>) is a strong oxidizing and sanitizing disinfectant and it has been used to treat drinking water. Compared with chlorine, this sanitizer causes less organoleptic change in treated products. In the food industry, ClO<sub>2</sub> has been of interest for sanitizing the surfaces of fruits and vegetables (Lee *et al.*, 2004). It effectively reduced foodborne pathogens (Rodgers *et al.*, 2004; Singh *et al.*, 2002), bacterial spores (Foegeding *et al.*, 1986; Lee *et al.*, 2004), and fecal contamination (Cutter and Dorsa, 1995). Peroxyacetic acid also has been investigated as a potential sanitizer in food applications (Rodgers *et al.*, 2004; Singh *et al.*, 2002).

**Table 3.2** Characteristics of Selected Intervention Technologies Used Currently to Ensure Food Safety

<b>Property</b>	<b>Thermal Processing</b>	<b>High-Pressure Processing</b>	<b>Pulsed Electric Field Processing</b>	<b>Irradiation</b>	<b>Ultraviolet Disinfection</b>	<b>Ozone Disinfection</b>
Operating mode	Batch, continuous	Batch, semi-continuous	Continuous	Batch	Batch, continuous	Batch, continuous
Applicability	Solid and liquid foods	Solid and liquid foods	Liquid and semi-liquid foods	Solid and liquid foods	Air, water, some liquid foods and food contact surfaces	Surface treatment of foods and food contact surfaces
Microbial inactivation	Vegetative	microorganisms, spores, protozoa, algae, viruses  microorganisms, spores, parasites	Vegetative microorganisms, some viruses and potentially spores (when combined with heat)  Vegetative microorganisms, protozoa, algae, viruses	Vegetative microorganisms  Vegetative microorganisms, spores, parasites, viruses	Vegetative	
Quality	Affects heat sensitive components (e.g. flavor, and nutrients); inactivate enzymes	Preserves natural quality; opportunity for formulating novel textural products; variable effect with enzyme inactivation	Causes minimal effect; variable effect with enzyme inactivation	Some off-flavors, some loss of vitamins and changes in texture	Develops some off-flavors in some foods	Excessive use may alter color, and flavor
Packaging requirement	In-package treatment or aseptic packaging after treatment	In-package treatment; high barrier packaging with at least one interface flexible enough to transfer pressure	Aseptic packaging after treatment	In-package treatment; radiation transmitting package needed	Aseptic packaging after treatment	Aseptic packaging after treatment

**Table 3.3** Comparison of Microbial Spore Inactivation by Heat and Non-Thermal Technologies

Treatment Technology	Treatment Conditions	Medium	Targeted Spores	Log Count Decreased
Heat <i>stearothermophilus</i>	140°C, 3 s 3	Milk	<i>Bacillus</i>	
Irradiation	12 kGy	Frozen yogurt	<i>Bacillus cereus</i>	3
High-pressure processing <i>stearothermophilus</i>	600 MPa, 105°C, 3 min 3	Egg patty mince	<i>B.</i>	
Pulsed electric field processing	22.4 kV/cm, 250 μs	Milk	<i>B. cereus</i>	0

(adapted from Lado and Yousef, 2002; Rajan *et al.*, 2006b).

### 2.3 Hurdle Approach

As in cases of thermal treatments, the lethality of any non-thermal methods can be increased by applying them in combination with other stressing factors, such as anti-microbial compounds (e.g. nisin and organic acids), reduced water activity, low pH, and mild heat treatments. When exposed to stresses (i.e. hurdles), microorganisms expend their energy in overcoming the hostile environment posed by the hurdles and thereby suffer metabolic exhaustion leading to their death (Leistner, 2000). The multi-target approach may also help to counter stress adaptation associated with sublethal treatments (Yousef, 2001). Nisin was reported to have a synergistic effect with PEF treatment, and an additive effect with HPP treatment (Hauben *et al.*, 1996; Pol *et al.*, 2000). Incorporation of nisin molecules through bacterial cell membrane may be facilitated during HPP and PEF treatments, causing higher numbers of permanent pores (Lado and Yousef, 2002).

The effect of HPP treatment was reported to be enhanced by the addition of sorbic and benzoic acids, enabling lower pressures and shorter treatment times to achieve microbial inactivation (Mozhaev *et al.*, 1994). Several reports have been published on enhancement of microbial inactivation using carbon dioxide (CO<sub>2</sub>) under relatively modest pressures (Balaban *et al.*, 2001; Haas *et al.*, 1989). Pressurized CO<sub>2</sub> penetrates bacterial cells relatively easily, causing a greater intracellular pH change than other acids. Ozone contributes to the breakdown of cells during mild PEF treatments (Ohshima *et al.*, 1997; Unal *et al.*, 2001). Combining two or more non-thermal processes can also enhance microbial inactivation and allow use of lower individual treatment intensities (Ross *et al.*, 2003). For intelligent selection of non-thermal processing combinations, target elements within cells, and the effects of treatments on those elements need to be determined.

### 3. CONTROL/MONITORING/IDENTIFICATION TECHNIQUES

Microbiological agents were associated with 38% of food products recalled by FDA in 2004, and 44% of USDA's Food Safety and Inspection Service (FSIS) recalls of meat and poultry products (Kennedy, 2005). Review of more than 5,000 product recalls by various federal agencies over the past 20 years showed *Salmonella* Typhimurium, *L. monocytogenes*, and *E. coli* O157:H7 as the leading pathogens implicated in a broad array of foods (Bricher, 2005b). This signifies the food industry's need for fast, efficient, and reliable detection and identification of pathogens on foods and in the plant.

Such rapid detection of pathogens and other microbial contaminants is critical for ensuring food safety. Conventional methods for the detection of foodborne pathogens are time-consuming and laborious, and require biochemical and serological confirmations. Completion of all phases requires at least 16–48 hours. Recent advances in technology make detection and identification faster, more convenient, more sensitive, and more specific than in conventional assays. Rapid methods are generally used as screening techniques, with negative results accepted as is, but positive results requiring confirmation by the appropriate official methods, which in many instances are culture-based. FDA recommends that the new, rapid techniques should be evaluated individually by user labs for their particular needs, and also collaboratively for possible adoption as official methods by the AOAC International (Andrews, 1996). Some of the advanced and rapid techniques and technologies associated with the detection of microorganisms are detailed below.

#### 3.1 Chromogenic Microbiological Media

One of the most notable advancements in microbiological techniques is the development of easy-to-use chromogenic media plates that can differentiate harmful pathogenic species from background flora and other bacterial species. These media plates utilize chromogenic substrates that produce colored colonies associated with the target pathogenic species when these substrates are hydrolyzed by species-specific enzymes. According to Bricher (2005b), the chromogenic plates are ready-to-use, strain-specific, and generally offer results 18–24 hours after incubation. This enables food companies to minimize expenses associated with the microbiological media and labor. Further, the test-and-hold time for product release of non-suspect lots is also reduced.

#### 3.2 Molecular and Immunological Assays Methods

Molecular technology, or DNA-based detection, is one of the fastest growing areas in rapid pathogen test system development. Immunological-based assays, such as enzyme-linked immunoassays (ELISAs), fluorescence-based sandwich immunoassays, western blots, and agglutination assays can be used to detect and identify microbial presence in foods (Blyn, 2006). Dipstick immunoassays are available for specific

organisms and are reliable, reproducible, and affordable. However, they are limited by their inability to detect low-level presence, varied sensitivity, and the possible requirement for single organism isolation using culture methods. A few of these detection techniques, which hold promise for the future, are covered in this section.

### **3.2.1 DNA Probe Methods**

Probe assays generally target ribosomal RNA genes (rDNA), taking advantage of the high copy number of these genes in bacterial cells, which provides a naturally amplified target and affords greater assay sensitivity (Fung, 2002). DNA-based assays for many foodborne pathogens, including *E. coli* O157:H7, *Salmonella* spp., and *L. monocytogenes*, have been developed (Bricher, 2005b).

### **3.2.2 Polymerase Chain Reaction Assays**

Polymerase chain reaction (PCR) assays utilize the basic principle of DNA hybridization, where short fragments of DNA primers are hybridized to a specific sequence or template, which is then enzymatically amplified by Taq polymerase using a thermocycler (Hill, 1996). Theoretically, PCR can amplify a single copy of DNA by a millionfold in less than 2 hours; hence its potential to eliminate or greatly reduce the need for cultural enrichment. The presence of inhibitors in foods and in many culture media can prevent primer binding and diminish amplification efficiency, so that the extreme sensitivity achievable by PCR with pure cultures is often reduced when testing foods. Therefore, some cultural enrichment is still required prior to analysis. Rapid detection of *Salmonella* Typhimurium, *L. monocytogenes*, and *E. coli* O157:H7 through automated PCR systems is well established (Bricher, 2005b). In 2005, two companies introduced PCR assays for the detection of *Campylobacter* strains. *Campylobacter* has been identified as the leading cause of foodborne illness and is found primarily in poultry, meat, and untreated water. PCR reactions are rapid (0.5–2.5 hours), and analysis of reaction products is usually done by gel electrophoresis. PCR products can also be analyzed in real-time (real-time PCR), using fluorescence-based detection methods (Blyn, 2006). PCR methods are very sensitive, fast, and can be performed on complex samples. They are limited by the need to have specific information about the target organisms and the inability to look at large numbers of organisms in complex mixtures simultaneously.

### **3.2.3 ELISA**

ELISA is a biochemical technique used mainly to detect an antibody or an antigen in a sample (Adams and Moss, 2003; Jay, 2003). It utilizes two antibodies, one of which is specific to the antigen and the other is coupled to an enzyme. This second antibody causes a chromogenic or fluorogenic substrate to produce a signal. Analyses using immuno-magnetic capturing technology were developed to lower the detection

threshold for the assay, resulting in shorter enrichment times and decreased time-to-result lag. Automatic interpretation and printing of data eliminates subjectivity of visual analysis and potential for recording errors. The primary use of the immunoassay-based method is to eliminate negative samples (e.g. food samples that are *Salmonella* negative) more rapidly than when using the conventional cultural method. Positive samples should be analyzed further using the cultural protocol (Yousef and Carlstrom, 2003).

### 3.3 Biosensors

Modern biosensors have evolved from the combination of biology and electronics. Biosensors are designed to detect harmful microorganisms and toxins. They use bioreceptors such as biocatalytic, bioaffinity, and hybrid receptors to recognize specific binding analytes (enzymes, antibodies, antigens, microbes, proteins, hormone, or nucleic acids) and immobilized-transducers convert signals into quantitative analytical information (Mello and Kubota, 2002). The principal of operation of a biosensor is outlined in Figure 3.1 and the common transducers used in biosensors with their detection principle are summarized in Table 3.4.

The selectivity of the biological sensing element offers the opportunity for development of highly specific devices for real-time analysis in complex mixtures, without the need for extensive sample pre-treatment or large sample volumes. Biosensors also promise highly sensitive, rapid, reproducible, and simple to operate analytical tools. Technical problems facing biosensor development include the interaction of compounds of food matrix, calibration, maintenance, sterilization, reproducible fabrication

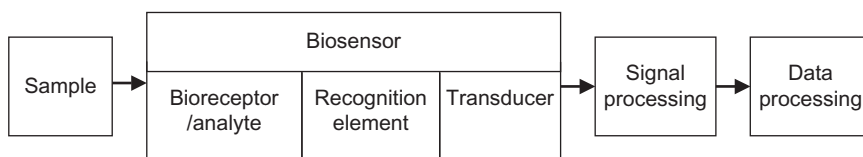


Figure 3.1 Principle of operation of a biosensor.

Table 3.4 Common Biosensor Transducers and their Detection Principles (Mello and Kubota, 2002)

Type of Transducer	Detection Principle
Electrochemical (amperometric, potentiometric, conductimetric) (Ivnitski <i>et al.</i> , 2000)	Electron tunneling, ion mobility, diffusion of electroactive or charged species
Thermal (Mosbach, 1995)	Temperature change or heat release
Optical (Rand <i>et al.</i> , 2002)	Absorption or emission of electromagnetic radiation
Piezoelectric (O'Sullivan <i>et al.</i> , 1999)	Mass and or microviscosity alterations of wave propagation

of sensors, and cost. Sensitivity is another issue that still requires improvement for direct detection of bacteria (Ivnitski *et al.*, 2000). However, it holds promise for on-line measurements of important food processing parameters and microbial detection.

A comparison of pathogen assay methods based on their detection time is given in Table 3.5. A recently developed biosensor system called Triangulation Identification for the Genetic Evaluation of Risks (TIGER) can potentially be used to detect and identify pathogens down to strain level (Hofstadler *et al.*, 2005). The system employs a high performance electrospray mass spectrometry time-of-flight (TOF) instrument to derive base compositions of PCR products. This system is reported to be able to detect and identify totally unknown organisms (Blyn, 2006). The advances in biosensor technology will lead to testing larger numbers of samples in a shorter period of time, and to detecting and characterizing unknown organisms.

### 3.4 Fourier Transform Infrared Spectrometry

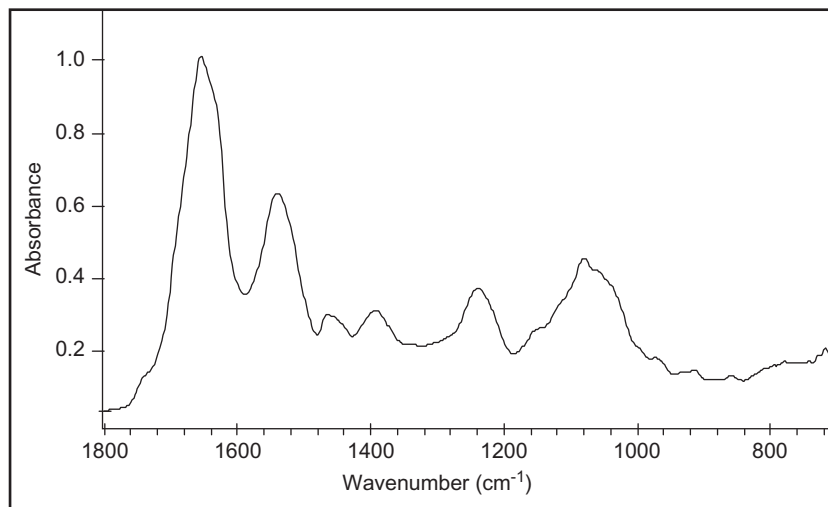
Fourier Transform infrared (FT-IR) spectrometry is a physicochemical method that discriminates intact microorganisms by producing complex biochemical spectra (Figure 3.2, Table 3.6), and hence can be used for characterization of microorganisms. The principal advantage of this technique is its rapidity and ease of use. Various FT-IR techniques, such as transmission, attenuated total reflection, and microspectroscopy, have been used to characterize bacteria, yeast, and other microorganisms (Mariey *et al.*, 2001). The FT-IR spectra of microorganisms have been described as fingerprint-like patterns, which are highly typical for different species and strains and it has been shown that Gram-positive and Gram-negative bacteria can be discriminated on the basis of their FT-IR spectra. The application of FT-IR spectroscopy has been reported for selected bacterial species of the genera *Staphylococcus*, *Streptococcus*, *Clostridium*, *Legionella*, *Lactobacillus*, *Listeria*, *Bacillus*, *Enterococcus*, and coryneform bacteria (Ngo-Thi *et al.*, 2003). Unknown species and strains could also be identified when included in an established hierarchical cluster analysis (HCA), principal component analysis (PCA), or artificial neural network (ANN). Detection, enumeration, and differentiation can be integrated in one single FT-IR apparatus and it is possible to get

**Table 3.5** Comparison of Pathogen Assay Methods by Time for Detection (Rand *et al.*, 2002)

Steps	Cultural	ELISA	PCR	Optical Biosensor
Enrichment	18–18 h	8–24 h	—	—
Plating	18–18 h	—	—	—
DNA extraction	—	—	0.5–1.5 h	—
Bio- and chemical test	5–24 h	—	—	—
Serology	4 h	—	—	—
Assay	—	2–4 h	3–4 h	0.5–2 h

ELISA, enzyme-linked immunosorbent assay; PCR, polymerase chain reaction.





**Figure 3.2** Fourier-Transform infrared absorption spectrum for *Salmonella enterica subsp. enterica serovar Typhimurium ODA 99389631* using attenuated total reflectance technique (Baldauf et al., 2006).

**Table 3.6** Frequencies ( $\text{cm}^{-1}$ ) and Assignments of Commonly Found Absorption Peaks in the Mid-IR Spectra of Microorganisms (Kansiz et al., 1999; Yu and Irudayaraj, 2005)

Wave Number ( $\text{cm}^{-1}$ )	Assignment
1740	C=O stretch, lipids
1690–1620	Amide I, proteins ( $\beta$ -sheets and $\alpha$ -helix structures)
1570–1530	Amide II, proteins (C–N stretch, N–H def)
1468	CH <sub>2</sub> sym deformation, lipids
1455	CH <sub>2</sub> /3 deformation modes (proteins)
1415	C–O–H in plane bending (carbohydrates, DNA/RNA backbone, proteins)
1397	–COO–sym stretch
1380	CH <sub>3</sub> sym deformation
1340–1240	Amide III, proteins
1235–1240	O–P=O asym stretch, DNA, RNA, phospholipids
1200–1000	C–O–C, C–O dominated by ring vibrations, carbohydrates
1150	C–O stretch, C–O–H bend, carbohydrates, mucin
1120	$\nu(\text{CC})$ skeletal <i>trans</i> conformation (DNA/RNA backbones)
1085	O–P=O sym stretch, DNA, RNA, phospholipids
1076	$\nu(\text{CC})$ skeletal <i>cis</i> conformation, DNA, RNA
900–800	C=C, C=N, C–H in ring structure, nucleotides

diagnostic results within a day. FT-IR microscopy can be used to characterize growth heterogeneity within microbial colonies, which in turn enables the detection of changes in molecular composition of cells within a complex microbial habitat. Because of its rapidity and reproducibility, FT-IR holds much promise in the identification of foodborne pathogens and could be useful in providing a rapid assessment of pathogen contamination, which is critical for monitoring food safety and regulation testing.

## 4. PACKAGING APPLICATIONS IN FOOD SAFETY

Packaging provides an improved margin of safety and quality, especially to minimally processed, easily prepared, and ready-to-eat “fresh” food products. Packaging technologies could play an active role in extending the shelf-life of foods and reduce the risk from pathogens. Some advancements in packaging catering toward food safety are presented here.

### 4.1 Active Packaging

Active packaging responds to changes in the packaging environment. These systems may absorb molecules such as oxygen, ethylene, or moisture, or release agents such as antimicrobials or flavors. Although commonly provided in sachets, there is a new trend in the food industry to incorporate active packaging technologies directly into the package walls.

Controlled-release packaging (CRP) is a new technology that relies on releasing active compounds (antimicrobials and antioxidants) at different controlled rates suitable for enhancing the quality and safety of a wide range of foods during extended storage (Cutter, 2002). These systems allow “slow addition” of antimicrobials to the food, as opposed to “instant addition” when the antimicrobials are added directly to the food formulation. A variety of active compounds that potentially can be used for CRP include nisin, tocopherols, potassium sorbate, sodium benzoate, zeolite, and others (Cutter, 2002; Han, 2000; Vermeiren *et al.*, 1999). Recently, advanced CRP films were made using smart blending (using two or more polymers and sometimes fillers) for better control over the release of active agents (LaCoste *et al.*, 2005). An exhaustive review of antimicrobial food packaging has been done by Appendini and Hotchkiss (2002).

For thermal control, double wall containers using molecular alloy phase change materials (MAPCM) were proposed as packages for thermal protection of liquid food products. This package was claimed to keep a drink between 6°C and 13°C over more than 3 hours when kept at an outside temperature of about 25°C (Espeau *et al.*, 1997).

## 4.2 Intelligent or “Smart” Packaging

Intelligent packaging systems have been designed (Yam, 2000) to carry a barcode, a portable data file (PDF) symbol, a time–temperature integrator (TTI), and/or a sensor. The system overcomes the problems associated with intrinsic properties of foods, difference in oven and packaging characteristics, and provides the consumer with high–quality ready–to–cook packaged foods. The system deals with food safety in many ways. It alerts the consumer to product recalls by food manufacturers, to food allergens, and integrated TTI helps in determining the quality and safety of food packages. A similar system is being evaluated for microwavable foods with ingredients having different dielectric and thermal properties and hence requiring different treatment levels (Louis, 1999). Applicability of smart labels in ease of identifying expiry of product sell–by–date is also being investigated.

## 4.3 Tamper Evident Packaging

Shrink bands and tamper–evident seals and tapes continue to play an important role for packages ranging from single–serving containers to shipping cases (Bertrand, 2005). Irreversible thermochromic or piezochromic materials could form the basis for closures that “bruise” during any attempt to open them, providing evidence of tampering prior to purchase (Goddard *et al.*, 1997). Radio frequency identification (RFID) has the potential to flag tampering. The working principle of RFID is explained in the next section on tracking and traceability. If a tagged object for some reason becomes unreadable, the failure may point to tampering, for example, an RFID mounted to the lid of a jar in such a way that unscrewing the jar would result in breakage of the connection between the tag’s chip and its antenna (Figure 3.3), thereby indicating tampering. Technologies currently used in pharmaceuticals, such as invisible inks, microscopic, or nanoprinting may find use in food packaging to reveal the marked package’s integrity.

## 5. TRACKING AND TRACEABILITY

Supply chain traceability plays an important role in ensuring food safety and brand protection. Automated traceability solutions are used to track product, streamline

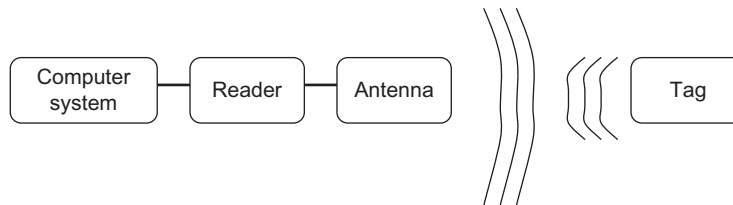


Figure 3.3 Schematic diagram of an RFID data acquisition system (Tulsian, 2005).

schedules, reduce operating costs, and improve customer service. The Public Health Security and Bioterrorism Preparedness Act of 2002 requires that records need to be maintained by the manufacturers, processors, packers, distributors, and importers of food in the USA to identify the immediate sources from which they receive food and the immediate recipients to whom food products are sent (one-up, one-back traceability) (McLeod, 2006). When the regulation is fully enacted, processors will be required to create these records at the time of processing. Also, the recent major food product recalls demonstrate the need to quickly trace, contain, and minimize food safety crises. Recently, the bovine spongiform encephalopathy crisis and debates about genetically modified soybeans have drawn new attention to supply chain traceability. The other traceability areas of contention are organic products, freshness of fish, special slaughtering method used, etc. (Moe, 1998).

Barcode scanning is the commonest operational system of record for automated entry of all inventory activities. Some of the other tracing and tracking technologies used in the food industries include microcircuit cards, voice recognition systems, bicoding technology, and chemical markers (Mousavi *et al.*, 2002). RFID is currently being used for the identification and tracking of packaged food products in the supply chain and of farm animals. RFID is a generic term for technologies that use radio waves to automatically identify and track objects. The most common way of identifying objects using RFID is to store a unique serial number that identifies a product, and perhaps other information, on a microchip that is attached to an antenna (the chip and the antenna together are called an RFID transponder or an RFID tag). The antenna enables the chip to transmit the identification information to a reader. The reader converts the radio waves returned from the RFID tag into a form that can then be passed to computers (Figure 3.3). The ability to read the tags without line-of-sight is the principal advantage of RFID systems over barcode systems; this enables the RFID readers to sense tags even when they are hidden (Sarma, 2004). The tags are very flexible in that microchips measuring less than a third of a millimeter wide can now store a wide range of unique product information. RFID can also allow only some of the data on the tag to be read and the tags can be updated after the original data has been loaded. They can be made virtually tamper proof (Jones *et al.*, 2005).

The limitations are that RFID can be interfered with by moisture, metal, and noise. Presently, cost of the tag prohibits its widespread adoption within the food industry. When combined with wireless sensors, the RFID system can record specific quality/safety attributes of food products along the chain. The deployment of RFID and wireless sensors in traceability systems is expected to be popular in the near future (Wang *et al.*, 2006).

## 6. BYPRODUCTS OF PROCESSING

Processing, particularly with heat, may lead to undesired changes in food, such as reduction of nutrients or the formation of hazardous substances, such as the

carcinogenic polycyclic aromatic hydrocarbons (PAH) or products like acrylamide and 3-monochloropropanediol (MCPD).

## 6.1 Acrylamide

In April 2002, acrylamide came to the attention of the food industry when scientists at the Swedish Food Administration first reported unexpectedly high levels in fried, baked, grilled, toasted, or microwaved carbohydrate-rich foods such as potato chips, roast potatoes, and bread (Tareke *et al.*, 2002). Acrylamide appears to form when foods, typically plant commodities high in carbohydrates and low in protein, are subjected to high temperature (120°C) during cooking or other thermal processing. The compound has been reported to cause cancer. Acrylamide is formed from Maillard reaction products, when the amino acid asparagine combines with reducing sugars, producing the highest levels of the carcinogen (Stadler *et al.*, 2002). Some studies (Vattem and Shetty, 2003) have shown that acrylamide formation is non-oxidative in nature and have reported reduced formation of acrylamide in high protein material. The Joint Expert Committee on Food Additives (JECFA) reported that the major contributing foods to total exposure for most countries were potato chips (16–30%), potato crisps (6–46%), coffee (13–39%), pastry and sweet biscuits (10–20%), and bread rolls/toasts (10–30%) (Anon, 2005). Other food items contributed less than 10% of the total exposure. Recent technological developments in food processing methods could significantly reduce acrylamide levels in some foods. These include, use of the enzyme asparaginase to selectively remove asparagines prior to heating, variety selection and plant breeding, control of growth and storage factors affecting sugar concentration in potatoes, and prolonging yeast fermentation time in bread making. The committee also recommends that acrylamide be re-evaluated when the results from ongoing toxicological studies are available and points to the need for additional information about acrylamide in foods to adequately consider potential human health concerns.

## 6.2 3-MCPD

Chlorinated propanols are formed during certain food manufacturing and domestic cooking processes. The compound 3-MCPD and, to a lesser extent, 1,3-dichloro-2-propanol (DCP) are the most abundant chloropropanols and they are considered to be carcinogens (Tritscher, 2004). Savory foods containing acid-hydrolyzed vegetable protein were found to be contaminated with 3-MCPD. The food groups identified as most likely to contain 3-MCPD are bread and biscuits (mainly toasted or roasted), and cooked/cured fish or meat. Although it is toxigenic only at high consumption levels, targeted actions are being taken to reduce the levels of 3-MCPD in soy sauce and related products.

## 7. CONCLUSIONS

Numerous health hazards are associated with food consumption, and these arise at different points in the food production chain. A multidisciplinary approach involving microbiology, chemistry, and engineering, is necessary to efficiently and innovatively address these potential hazards. Food safety engineering is a great manifestation of this multidisciplinary approach, with the goal of developing holistic solutions to chronic and emerging food safety problems. Researchers in this new branch of knowledge should be familiar with the microbiological and chemical risks in food, and be capable of integrating science and engineering to control or eliminate these risks. Intervention strategies built on the cooperation of microbiologists, chemists, and engineers provide the best solution to the multifaceted food safety problems.

## ACKNOWLEDGMENT

Salaries and support were provided in part by the Ohio Agricultural Research and Development Center (OARDC), and the Center for Advanced Processing and Packaging Studies (CAPPS). References to commercial products and trade names are made with the understanding that no discrimination and no endorsement by Ohio State University are implied.

## REFERENCES

- Adams, M.R., Moss, M.O., 2003. Food Microbiology, second ed. Panima Publishing Corporation, New Delhi, 388–399.
- Ananta, E., Heinz, V., Schlüter, O., Knorr, D., 2001. Kinetic studies on high-pressure inactivation of *Bacillus stearothermophilus* spores suspended in food matrices. *Inno. Food Sci. Emer. Technol.* 2, 261–272.
- Andrews, W.H., 1996. AOAC International's three validation programs for methods used in the microbiological analysis of foods. *Trends Food Sci. Technol.* 7, 147–151.
- Anon., 2005. Acrylamide report recommends improved food preparation technologies. *Food Saf. Mag.* 11, 8–10.
- Appendini, P., Hotchkiss, J.H., 2002. Review of antimicrobial food packaging. *Inno. Food Sci. Emer. Technol.* 3, 113–126.
- Ariefdjohan, M.W., Nelson, P.E., Singh, R.K., Bhunia, A.K., Balasubramaniam, V.M., Singh, N., 2004. Efficacy of high hydrostatic pressure treatment in reducing *Escherichia coli* O157:H7 and *Listeria monocytogenes* in alfalfa seeds. *J. Food Sci.* 69, M117–M120.
- Balaban, M.O., Kincal, D., Hill, S., Marshall, M.R., Wildasin, R., 2001. The synergistic use of carbon dioxide and pressure in nonthermal processing of juices. IFT Annual Meeting Book of Abstracts. Session 6–3. IFT Annual Meeting, June 15–19, 2001, New Orleans.
- Balasubramaniam, V.M., 2003. High pressure food preservation. In: Heldman, D.R. (Ed.), *Encyclopedia of Agricultural, Food and Biological Engineering*. Marcel Dekker, Inc., pp. 490–496.
- Baldauf, N., Rodriguez-Romo, L.A., Yousef, A.E., Rodriguez-Saona, L.E., 2006. Identification and differentiation of selected *Salmonella enterica* serovars by Fourier-transform mid-infrared spectroscopy. *Appl. Spectro.* 60, 592–598 (7).
- Bayindirli, A., Alpas, H., Bozoglu, F., Hizal, M., 2006. Efficacy of high pressure treatment on inactivation of pathogen microorganisms and enzymes in apple, orange, apricot and sour juices. *Food Cont.* 17, 52–58.
- Bertrand, K., 2005. Making tampering evident. *Food Proc.* 66, 38–41.

- Bintsis, T., Litopoulou-Tzanetaki, E., Robinson, R.K., 2000. Existing and potential applications of ultraviolet light in the food industry—a critical review. *J. Sci. Food Agric.* 80, 637–645.
- Blyn, L.B., 2006. Biosensors and food protection. *Food Technol.* 60, 36–41.
- Bricher, J.L., 2005a. Process control: innovation in microbial interventions. *Food Saf. Mag.* 11, 29–33.
- Bricher, J.L., 2005b. Technology round-up: new frontiers in pathogen testing. *Food Saf. Mag.* 11, 36–77.
- Brul, S., Coote, P., 1999. Preservative agents in foods—Mode of action and microbial resistance mechanisms. *Int. J. Food Microbiol.* 50, 1–17.
- Butz, P., Tauscher, B., 2002. Emerging technologies: chemical aspects. *Food Res. Int.* 35, 279–284.
- Calci, K.R., Meade, G.K., Tezloff, R.C., Kingsley, D.H., 2005. High-pressure inactivation of hepatitis A virus within oysters. *Appl. Environ. Microbiol.* 71, 339–343.
- Carlez, A., Rosec, J.P., Richard, N., Chafel, J.C., 1993. High pressure inactivation of *Citrobacter freundii*, *Pseudomonas fluorescens* and *Listeria innocua* in inoculated minced beef muscle. *Lebensm.-Wiss. u.-Technol.* 26, 357–363.
- Cheftel, J.C., Culioli, J., 1995. Review: high pressure, microbial inactivation and food preservation. *Food Sci. Technol. Int.* 1, 7590.
- Cutter, C.N., 2002. Microbial control by packaging: a review. *Crit. Rev. Food Sci. Nutr.* 42, 151–161.
- Cutter, C.N., Dorsa, W.J., 1995. Chlorine dioxide spray washes for reducing fecal contamination on beef. *J. Food Prot.* 58, 1294–1296.
- Devlieghere, F., Vermeiren, L., Debevere, J., 2004. New preservation technologies: possibilities and limitations. *Int. Dairy J.* 14, 273–285.
- Espeau, P., Mondieig, D., Haget, Y., Cuevas-Diarte, M.A., 1997. ‘Active’ package for thermal protection of food products. *Packag. Technol. Sci.* 10, 253–260.
- FAO/WHO, 2001. Principles for the Establishment and Application of Microbiological Criteria for Foods. General Requirements, CAC/GL 21-1997. Joint FAO/WHO Food Standards Programme, Codex Alimentarius Commission. Food and Agriculture Organization of the United Nations/World Health Organization, Rome, Italy.
- Farkas, J., 1998. Irradiation as a method for decontaminating food—A review. *Int. J. Food Microbiol.* 44, 189–204.
- Farkas, D., Hoover, D., 2000. High pressure processing. Kinetics of microbial inactivation for alternative food processing technologies. *J. Food Sci.(Suppl.)*, 47–64.
- Ferron, W.L., Eisenstark, A., Mackay, D., 1972. Distinction between far- and near-ultraviolet light killing of recombinationless (recA) *Salmonella typhimurium*. *Biochem. Biophys. Acta.* 277, 651–658 (Cited in Bintsis T., Litopoulou-Tzanetaki E., and Robinson R. K. 2000. Existing and potential applications of ultraviolet light in the food industry—a critical review. *J. Sci Food Agric.* 80, 637–645.).
- Fioletto, F., Cruz, C., Largeteau, A., Sarli, T.A., Demazeau, G., El Moueffak, A., 2005. Inactivation of *Staphylococcus aureus* and *Salmonella enteritidis* in tryptic soy broth and caviar samples by high pressure processing. *Braz. J. Med. Biol. Res.* 38, 1259–1265.
- Foegeding, P.M., Hemstapat, V., Giesbrecht, F.G., 1986. Chlorine dioxide inactivation of *Bacillus* and *Clostridium* spores. *J. Food Sci.* 51, 197–201.
- Fung, D.Y.C., 2002. Rapid methods and automation in microbiology. *Comprehen. Rev. Food Sci. Food Saf.* 1, 322.
- Goddard, N.D.R., Kemp, R.M.J., Lane, R., 1997. An overview of smart technology. *Packag. Technol. Sci.* 10, 129–143.
- Guzel-Seydim, Z.B., Greene, A.K., Seydim, A.C., 2004. Use of ozone in the food industry. *Lebensm.-Wiss. u.-Technol.* 37, 453–460.
- Haas, G.J., Prescott, H.E., Dudley, E., Dik, R., Hintlian, C., Keane, L., 1989. Inactivation of microorganisms by carbon dioxide under pressure. *J. Food Saf.* 9, 253–265.
- Han, J.H., 2000. Antimicrobial food packaging. *Food Technol.* 54, 56–65.
- Hauben, K.J.A., Wuytack, E.Y., Soontjens, C.C.F., Michiels, C.W., 1996. High-pressure transient sensitization of *Escherichia coli* to lysozyme and nisin by disruption of outer-membrane permeability. *J. Food Prot.* 59, 350–355.

- Heinz, V., Alvarez, I., Angersbach, A., Knorr, D., 2001. Preservation of liquid foods by high intensity pulsed electric fields-basic concepts for process design. *Trends Food Sci. Technol.* 12, 103–111.
- Henkel, J., 1998. Irradiation: a safe measure for safer food. *FDA Consum.* (Publication No. (FDA) 98-2320).
- Hill, W.E., 1996. The polymerase chain reaction: application for the detection of foodborne pathogens. *CRC Crit. Rev. Food Sci. Nutr.* 36, 123–173.
- Hofstadler, S.A., Samph, R., Blyn, L.B., et al., 2005. TIGER: the universal biosensor. *Intl. J. Mass Spectrom.* 242, 23–41.
- ICMSE, 2002. “Microorganisms in Foods 7”. International Commission on Microbiological Specifications for Foods. Kluwer Academic/Plenum Publishers, New York.
- IFT (Institute of Food Technologists), 2000. Kinetics of microbial inactivation for alternative food processing technologies. *J. Food Sci.* December (Suppl.).
- IFT (Institute of Food Technologists). 2002. IFT expert report on emerging microbiological food safety issues. Implications for control in the 21st century. <[http://members.ift.org/IFT/Research/IFTExpertReports/microsf\\_s\\_report.htm/](http://members.ift.org/IFT/Research/IFTExpertReports/microsf_s_report.htm/)> (Last accessed 12.03.06.).
- Ivniški, D., Abdel-Hamid, I., Atanasov, P., Wilkins, E., Stricker, S., 2000. Application of electrochemical biosensors for detection of food pathogenic bacteria. *Electroanal* 12, 317–325.
- Jay, J.M., 2003. *Modern Food Microbiology*, fourth ed. Chapman & Hall Inc., New York, p. 147.
- Jaykus, L.-A., Acuff, G.R., Busta, F., et al., 2004. Managing food safety: use of performance standards and other criteria in food inspection systems. An Authoritative Report of the Institute of Food Technologists. October.
- Jones, P., Clarke-Hill, C., Comfort, D., Hillier, D., Shears, P., 2005. Radio frequency identification and food retailing in the UK. *British Food J.* 107, 356–360.
- Kansiz, M., Heraud, P., Wood, B., Burden, F., Beardall, J., McNaughton, D., 1999. Fourier Transform Infrared microspectroscopy and chemometrics as a tool for the discrimination of cyanobacterial strains. *Phytochemistry* 52, 407–417.
- Kennedy, P., 2005. Review of U.S. food recall data illuminates safety trends. *Silliker’s e-bulletin* 3 (2), <<http://www.silliker.com/html/eResearch/vol3issue2.php#top>> (Last accessed 12.03.06.).
- Khadre, M.A., Yousef, A.E., 2001. Sporicidal action of ozone and hydrogen peroxide: a comparative study. *Int. J. Food Microbiol.* 71, 131–138.
- Kim, J.G., Yousef, A.E., Dave, S., 1999. Application of ozone for enhancing the microbiological safety and quality of foods: a review. *J. Food Prot.* 62, 1071–1087.
- Kim, J.G., Yousef, A.E., Khadre, M.A., 2003. Ozone and its current and future application in the food industry. *Adv. Food and Nutr. Res.* 45, 167–218.
- Kingsley, D.H., Guan, D., Hoover, D.G., 2005. Pressure inactivation of hepatitis A virus in strawberry puree and sliced green onions. *J. Food Prot.* 68, 1748–1751.
- Koutchma, T., Keller, S., Chirtel, S., Parisi, B., 2004. Ultraviolet disinfection of juice products in laminar and turbulent flow reactors. *Inno. Food Sci. Emer. Technol.* 5, 179–189.
- LaCoste, A., Schaich, K.M., Zumbrennen, D., Yam, K.L., 2005. Advancing controlled release packaging through smart blending. *Packag. Technol. Sci.* 18, 77–87.
- Lado, B.H., Yousef, A.E., 2002. Alternative food-preservation technologies: efficacy and mechanisms. *Microb. Infec.* 4, 433–440.
- Lee, S.-Y., 2004. Irradiation as a method of decontaminating food. *Int. J. Food Saf.* 3, 32–35.
- Lee, S.-Y., Dougherty, R.H., Kang, D.-H., 2002. Inhibitory effects of high pressure and heat on *Alicyclobacillus acidoterrestris* spores in apple juice. *Appl. Env. Microbiol.* 68, 4158–4161.
- Lee, S.Y., Gray, P.M., Dougherty, R.H., Kang, D.H., 2004. The use of chlorine dioxide to control *Alicyclobacillus acidoterrestris* spores in aqueous suspension and on apples. *Int. J. Food Microbiol.* 92, 121–127.
- Leistner, L., 2000. Basic aspects of food preservation by hurdle technology. *Int. J. Food Microbiol.* 55, 181–186.
- Liltved, H., Cripps, S.J., 1999. Removal of particle-associated bacteria by prefiltration and ultraviolet irradiation. *Aquaculture Res.* 30, 445–450.
- Louis, P.J., 1999. Review paper-Food packaging in the next millennium. *Packag. Technol. Sci.* 12, 1–7.



- Margosch, D., Gazle, M.G., Ehrmann, M.A., Vogel, R.F., 2004a. Pressure inactivation of *Bacillus* endospores. *Appl. Env. Microbiol.* 70, 7321–7328.
- Margosch, D., Ehrmann, M.A., Gazle, M.G., Vogel, R.F., 2004b. Comparison of pressure and heat resistance of *Clostridium botulinum* and other endospores in mashed carrots. *J. Food Prot.* 67, 2530–2537.
- Mariey, L., Signolle, J.P., Amiel, C., Travert, J., 2001. Discrimination, classification, identification of microorganisms using FTIR spectroscopy and chemometrics. *Vib. Spectrosc.* 26, 151–159.
- McLeod, S., 2006. Ensuring food safety and brand protection through supply chain traceability. *Food Saf. Mag.* <http://www.foodsafetymagazine.com/signature/signature.htm> (Last accessed 23.03.06.).
- Mello, L.D., Kubota, L.T., 2002. Review of the use of biosensors as analytical tools in the food and drink industries. *Food Chem.* 77, 237–256.
- Mercier, J., Arul, J., Julien, C., 1994. Effect of food preparation on the isocoumarin, 6-methoxymellein, content of UV-treated carrots. *Food Res. Int.* 27, 401–404.
- Mittendorfer, J., Bierbaumer, H.P., Gratzl, F., Kellauer, E., 2002. Decontamination of food packaging using electron beam-status and prospects. *Radiation Chem.* 63, 833–836.
- Moe, T., 1998. Perspectives on traceability in food manufacture. *Trends Food Sci. Technol.* 9, 211–214.
- Mosbach, K., 1995. Thermal biosensors. *Biosen. Bioelectron.* 6, 179–182.
- Mousavi, A., Sarhadi, M., Lenk, A., Fawcett, S., 2002. Tracking and traceability in the meat processing industry: a solution. *British Food J.* 104, 7–19.
- Mozhaev, V.V., Heremans, K., Frank, J., Masson, P., Balny, C., 1994. Exploiting the effects of high hydrostatic pressure in biotechnological applications. *Trends Biotechnol.* 12, 493–501.
- Ngo-Thi, N.A., Kirchner, C., Naumann, D., 2003. Characterization and identification of microorganisms by FT-IR microspectrometry. *J. Mol. Struct.* 661–662, 371–380.
- Ohshima, T., Sato, K., Terauchi, H., Sato, M., 1997. Physical and chemical modifications of high-voltage pulse sterilization. *J. Electrostat.* 42, 159–166.
- Okazaki, T., Kakugawa, K., Yoneda, T., Suzuki, K., 2000. Inactivation behavior of heat-resistant bacterial spores by thermal treatments combined with high hydrostatic pressure. *Food Sci. Technol. Res.* 6, 204–207.
- Olson, D.G., 1998. Irradiation of food. *Food Technol.* 52, 56–62.
- O'Reilly, C.E., O'Connor, P.M., Kelly, A.L., Beresford, T., Murphy, P.M., 2000. Use of hydrostatic pressure for inactivation of microbial contamination in cheese. *Appl. Environ. Microbiol.* 66, 4890–4896.
- O'Sullivan, C.K., Vaughan, R., Guilbault, G.G., 1999. Piezoelectric immunosensors-theory and applications. *Anal. Lett.* 32, 2352–2377.
- Patterson, M., 2004. Under pressure: a novel technology to kill microorganisms in foods. *Culture* 25, 2–5.
- Pol, I.E., Mastwijk, H.C., Bartels, P.V., Smid, E.J., 2000. Pulsed-electric field treatment enhances the bactericidal action of Nisin against *Bacillus cereus*. *Appl. Environ. Microbiol.* 60, 4174–4177.
- Rajan, S., Ahn, J., Balasubramaniam, V.M., Yousef, A.E., 2006a. Combined pressure-thermal inactivation kinetics of *Bacillus amyloliquefaciens* spores in egg patty mince. *J. Food Prot.* 69, 853–860.
- Rajan, S., Balasubramaniam, V.M., Yousef, A.E., 2006b. Inactivation of *Bacillus stearothermophilus* spores in egg patties by pressure-assisted thermal processing. *Lebensm.-Wiss. u.-Technol.* 39, 844–851.
- Ramaswamy, R., Balasubramaniam, V.M., Kaletunc, G., 2004. High Pressure Processing: Fact Sheet for Food Processors. FST-1–04. Ohio State University Extension, Columbus, OH, <http://ohi-online.osu.edu/fse-fact/0001.html>. (Last accessed 12.03.06.).
- Rand, A.G., Ye, J., Brown, C.W., Letcher, S.V., 2002. Optical biosensors for food pathogen detection. *Food Technol.* 56, 32–39.
- Reddy, N.R., Solomon, H.M., Tetzloff, R.C., Rhodehamel, E.J., 2003. Inactivation of *Clostridium botulinum* Type A spores by high-pressure processing at elevated temperature. *J. Food Prot.* 66, 1402–1407.
- Rodgers, S.L., Cash, J.N., Siddig, M., 2004. A comparison of different chemical sanitizers for inactivating *Escherichia coli* O157:H7 and *Listeria monocytogenes* in solution and on apples, lettuce, strawberries, and cantaloupe. *J. Food Prot.* 67, 721–731.

- Rodriguez, G.G., Phipps, D., Ishiguro, K., Fidgway, H.F., 1992. Use of a fluorescent redox probe for direct visualization of actively respiring bacteria. *Appl. Environ Microbiol.* 58, 1801–1808.
- Ross, A.I.V., Griffiths, M.W., Mittal, G.S., Deeth, H.C., 2003. Combining non-thermal technologies to control foodborne microorganisms. *Int. J. Food Microbiol.* 89, 125–138.
- Sarma, S., 2004. Integrating RFID. *Queue Oct.*, 50–57.
- Shah, P.B., Shah, U.S., Siripurapu, S.C.B., 1994. Ultraviolet irradiation and laminar air flow systems for clean air in dairy plants. *Indian Dairyman* 46, 757–759.
- Shigehisa, T., Ohmori, T., Saito, A., Taji, S., Hayashi, R., 1991. Effects of high hydrostatic pressure on characteristics of pork slurries and inactivation of microorganisms associated with meat and meat products. *Int. J. Food Microbiol.* 12, 207–216.
- Singh, N., Singh, R.K., Bhunia, A.K., Stroshine, R.L., 2002. Effect of inoculation and washing methods on the efficacy of different sanitizers against *Escherichia coli* O157:H7 on lettuce. *Food Microbiol.* 19, 183–193.
- Smelt, J.P.P.M., 1998. Recent advances in the microbiology of high pressure processing. *Trends Food Sci. Technol.* 9, 152–158.
- Smith, J.S., Pillai, S., 2004. Irradiation and food safety. *Food Technol.* 58, 48–55.
- Stadler, R.H., Blank, I., Varga, N., et al., 2002. Acrylamide from Maillard reaction products. *Nature* 419, 449–450.
- Stermer, R.A., Lasater-Smith, M., Brasington, C.F., 1987. Ultraviolet radiation—an effective bactericide for fresh meat. *J. Food Prot.* 50, 108–111.
- Tanaka, Y., Kawaguchi, K., 1991. Sterilization of vacuum packaged raw meat. U.S. patent 4983411.
- Tareke, E., Rydberg, P., Karlsson, P., Eriksson, S., Tornqvist, M., 2002. Analysis of acrylamide, a carcinogen formed in heated foodstuffs. *J. Agric. Food Chem.* 50, 4998–5006.
- Thayer, D.W., 2003. Ionizing irradiation, treatment of food. In: Heldman, D.R. (Ed.), *Encyclopedia of Agricultural, Food and Biological Engineering*. Marcel Dekker, Inc., pp. 536–539.
- Tritscher, A.M., 2004. Human risk assessment of processing-related compounds in food. *Toxicol. Lett.* 149, 177–186.
- Tulsian, P., 2005. Electrical Conductivity of Multi-Component Systems and their Resident Time Distribution. The Ohio State University, Columbus, Ohio (Unpublished MS Thesis).
- Unal, R., Kim, J.G., Yousef, A.E., 2001. Inactivation of *Escherichia coli* O157:H7, *Listeria monocytogenes* and *Lactobacillus leichmannii* by combinations of ozone and pulsed electric field. *J. Food Prot.* 64, 777–782.
- US GPO (U.S. Government Printing Office). 2003. Code of federal regulations, 21CFR179. <<http://www.access.gpo.gov/cgi-bin/cfrassemble.cgi?title=200321/>> (Last accessed 26.03.06.).
- USDA. 2006. Food safety and inspection service new technology information table. <[http://www.fsis.usda.gov/Regulations\\_and\\_Policies/New\\_Technology\\_Table/index.asp/](http://www.fsis.usda.gov/Regulations_and_Policies/New_Technology_Table/index.asp/)> (Last accessed 12.03.06.).
- van Opstal, I., Bagamboula, C.F., Vanmuysen, S.C.M., Wuytack, E.Y., Michiels, C.W., 2004. Inactivation of *Bacillus cereus* spores in milk by mild pressure and heat treatments. *Int. J. Food Microbiol.* 92, 227–234.
- Vattem, D.A., Shetty, K., 2003. Acrylamide in food: a model for mechanism of formation and its reduction. *Inno. Food Sci. Emer. Technol.* 4, 331–338.
- Vega-Mercado, H., Martin-Belloso, O., Qin, B.-L., et al., 1997. Non-thermal food preservation: pulsed electric fields. *Trends in Food Sci. Technol.* 8, 151–157.
- Vermeiren, L., Devlieghere, F., van Beest, M., de Kruijf, N., Debevere, J., 1999. Developments in the active packaging of foods. *Trends Food Sci. Technol.* 10, 77–86.
- Wang, N., Zhang, N., Wang, M., 2006. Wireless sensors in agriculture and food industry—Recent development and future perspective. *Computers Electron. Agric.* 50, 1–14.
- WHO (World Health Organization). 1994. Ultraviolet radiation. *Environmental Health Criteria.* 160, Vammala.
- Wouters, P.C., Alvarez, I., Raso, J., 2001. Critical factors determining inactivation kinetics by pulsed electric field food processing. *Trends in Food Sci. Technol.* 12, 112–121.
- Yam, K.L., 2000. Intelligent packaging for the future smart kitchen. *Packag. Technol. Sci.* 13, 83–85.

- Yousef, A.E., 2001. Efficacy and limitations of non-thermal preservation technologies. IFT Annual Meeting Book of Abstracts, Session 9-1. IFT Annual Meeting, June 15–19, 2001, New Orleans.
- Yousef, A.E., Carlstrom, C., 2003. *Food Microbiology: A Laboratory Manual*. John Wiley and Sons, Inc., Hoboken, New Jersey.
- Yu, C., Irudayaraj, J., 2005. Spectroscopic characterization of microorganisms by Fourier Transform Infrared microspectroscopy. *Biopolymers* 77, 368–377.
- Zhang, Q., Barbosa-Canovas, G.V., Swanson, B.G., 1995. Engineering aspects of pulses electric field pasteurization. *J. Food Eng.* 25, 261–281.

# Farm Machinery Automation for Tillage, Planting Cultivation, and Harvesting

**Brian T. Adams**

University of Missouri-Columbia, MO, USA

## 1. INTRODUCTION

The shifting from hunting and gathering societies to agrarian societies allowed people to stay in one place and grow their food. Until the industrial revolution, most people had to grow their own food, using their own labor. As the economies shifted toward an industrial society, people moved away from rural agricultural areas and populations became concentrated in cities. Agricultural producers were called upon to produce more food with less labor to feed a larger number of people in urban areas. As a result, agricultural mechanization started with the development and use of the steam engine for threshing and has led to the development of prototype fully autonomous farm machinery today.

Most agricultural mechanization occurred in the late nineteenth and early twentieth centuries. The development of the steam engine in the late nineteenth century was an enabling technology for the development of agricultural automation. The steam engine, a relatively portable power source, allowed automation of threshing, formerly performed by hand. Steam engines were large and expensive, so only the large, wealthy agricultural producers could afford them. In the 1920s and 1930s, smaller tractors with internal combustion engines that ran on gasoline were mass-produced at low cost and more farmers could afford them. This, in turn, led to increased farm machinery automation, as the machines were readily available. Farmers, often mechanical by nature, invented attachments and machinery that was driven by the tractor to automate tasks that were previously performed by hand.

Other developments, including mobile hydraulics and electronics, have allowed the automation of more complex tasks in agricultural machinery. Mobile hydraulics allowed large forces to be generated using hydraulic cylinders. In addition, hydraulics allowed remote power with hydraulic motors without the need of a mechanical

driveline. Electronic control units (ECU) can control hydraulic valves to regulate the flow of hydraulic fluid to the actuators. The ECU can use information from sensors to control the operation of the systems on a vehicle, such as the hitch, power-take-off (PTO), transmission, and steering systems. Advances in hydraulics and electronics have led to the development of more complex machines.

Development of guidance systems and autonomous vehicles is current state-of-the-art in agricultural mechanization. Since the late nineteenth century, farmers have been devising methods of making a tractor follow a plow furrow by using a feeler. In the later part of the twentieth century, the combination of hydraulics and electronics allowed for more sophisticated guidance strategies. These strategies include low force feelers that can guide the tractor or implement based on the position or rows, and guiding the tractor based on the position of the vehicle from the Global Positioning System (GPS).

## 2. VEHICLE GUIDANCE

Farmers spend many hours operating machinery in the field to perform tillage, planting, cultivation, and harvesting. Although farmers are usually very good machinery operators, it is not possible to maintain the correct path all the time. If the machine should veer from the correct path, production losses will occur due to crop damage or harvest losses, depending on the operation. If less skilled operators are used, the problem becomes worse. To reduce losses due to operator error, guidance systems can be used to help the operator steer the vehicle, particularly in ambiguous situations where the path is difficult for the operator to see or follow, such as when spraying or planting. In situations where maintaining the proper position is even more critical, such as cultivation or harvesting, the guidance system can steer the vehicle directly using electronics and hydraulic controls. Such guidance systems are used to steer machinery across the field, usually in parallel swaths or following the rows of plants.

Using a guidance system for agricultural machinery is not a new concept. One of the earliest guidance systems used a wheel to steer a steam-powered traction engine along a plow furrow. A small steel wheel was designed to run in a plow furrow next to the tractor. The guidance wheel was attached to the front wheels of the tractor and held up against the furrow using a spring. As the tractor veered left or right, the guidance wheel in the furrow would steer the tractor in the opposite direction, keeping it on track parallel to the plow furrow. One of the drawings from the patent is shown in [Figure 4.1](#).

Depending on the situation, different guidance strategies or groups of guidance strategies may be needed to achieve the best outcome. Each strategy uses or combines

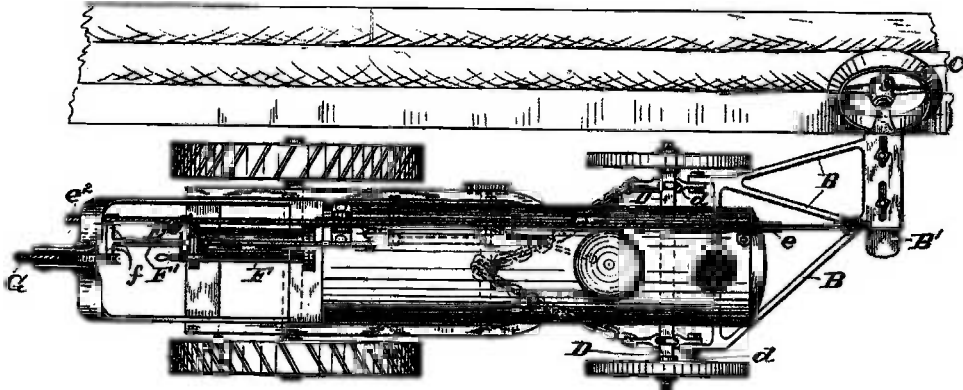


Figure 4.1 An early furrow following guidance system installed on a steam-powered traction engine (Snyder, 1884).

various technologies to guide the vehicle. For example, consider a tractor cultivating a row crop, such as cotton. A sensor with feelers can locate the row accurately, and ensure that the vehicle follows the row. However, there is no assurance that the tractor is cultivating the correct set of rows. The GPS system can locate the tractor on the proper set of rows, but the accuracy may not be precise enough to cultivate between the rows without damaging the crop. The two systems may be combined to provide a better solution. The ECU can use the GPS portion of the guidance system to ensure that the tractor is cultivating the correct set of rows then switch to the feeler guidance system to ensure that the cultivator is accurately operating between the rows, minimizing the damage to the crops.

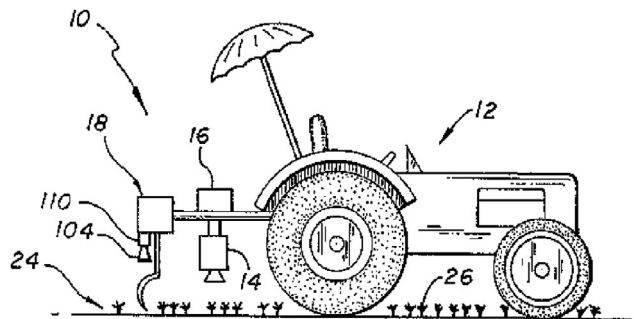


Figure 4.2 An implement guidance system (Slaughter et al., 1995).

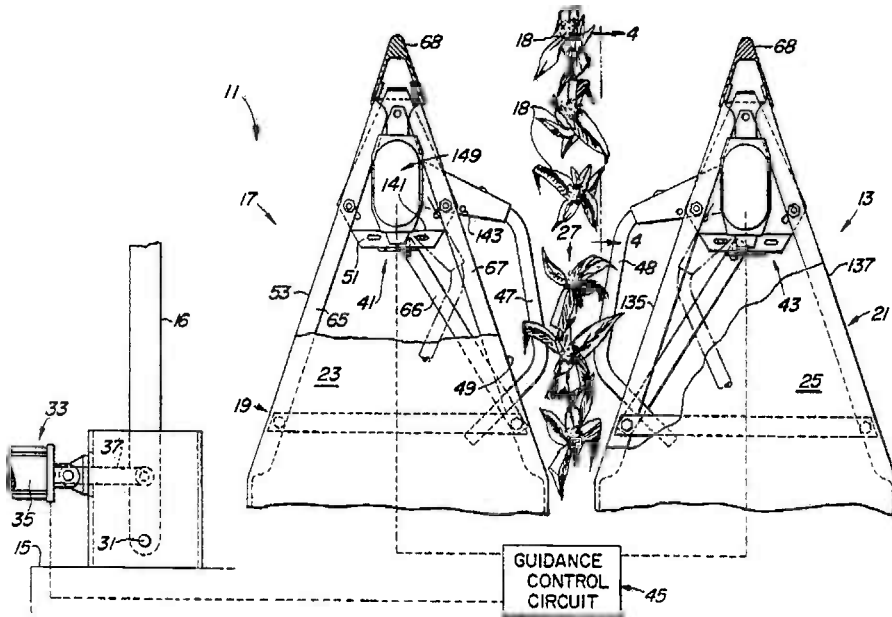


Figure 4.3 A guidance system that uses crop feelers (Williams, 1985).

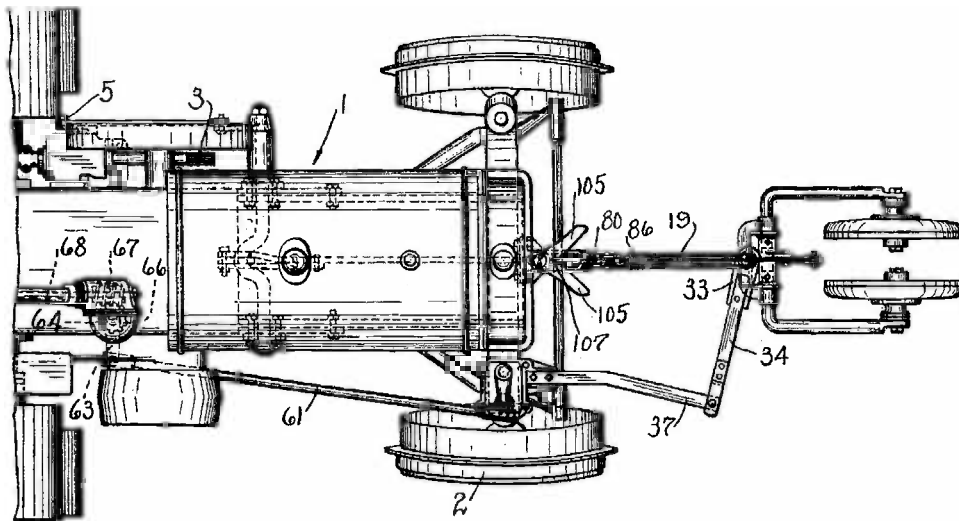


Figure 4.4 Early guidance system that follows furrows (Silver, 1930).

## 2.1 Guidance Strategies

There are four different strategies for guiding vehicles:

1. Manual—an operator steers the vehicle based on their observations of the surroundings.
2. Operator assisted—an operator steers the vehicle based on a signal from the guidance system.
3. Semi-autonomous—the guidance system steers the vehicle, but an operator is present to ensure the system is working properly and perform other vehicle functions that are not automated.
4. Fully autonomous—no operator required! The benefits and challenges of each strategy are identified in [Table 4.1](#) and discussed in more detail below.

### 2.1.1 Manual Vehicle Guidance

When a person drives an automobile, or a farmer operates a tractor, these are examples of manual guidance systems. A manual vehicle guidance system uses an operator to steer the vehicle based on their understanding of the surroundings. Some might argue that this is not a guidance system at all. However, it is a real and viable alternative to other types of guidance systems and must be considered when evaluating the economics of guidance systems. As most vehicles are operated in this manner, manual guidance systems might be considered the most economically viable guidance system. Unfortunately, it is also one of the most complex systems. Not all operators behave in the same way, and their physical conditions can have an effect on their ability to operate a vehicle. Operators can focus only on a limited part of their surroundings at one time. Operator judgment of distance is poor, particularly if there are no references on which to base a distance. Therefore, they may judge the position of the vehicle incorrectly, causing excessive overlap, skips, or damage to the crop.

Operators need to have more overlap than is required with other types of guidance systems, to ensure they do not have skips in planting or pesticide application. Often, operators overlap subsequent passes across the field by 5% to 10%, leading to a corresponding decrease in field efficiency and field capacity.

In other situations, such as cotton harvesting or row crop cultivating, ensuring that the vehicle is centered on the rows reduces damage to the crops. Although most operators can keep the vehicle centered on the rows for a short time, after hours and days of operation, the operators tend to experience some fatigue, and it becomes more difficult to keep the vehicle centered on the rows. For the cotton picker, picking efficiency will be reduced with drift, and more cotton will be left on the plants in the field. The cultivator, on the other hand, damages the crops during growth, reducing the yield.



**Table 4.1** Benefits and Challenges Associated with Different Guidance Strategies

<b>Guidance Strategy</b>	<b>Advantages</b>	<b>Disadvantages</b>
Manual	<ul style="list-style-type: none"> <li>Requires no machinery modifications or special equipment</li> </ul>	<ul style="list-style-type: none"> <li>Operators can become fatigued and cause damage to crops or inefficient operation</li> <li>More overlap is required to compensate for operator variability</li> </ul>
Operator-assisted	<ul style="list-style-type: none"> <li>Can help operator reduce overlap in situations where the markers are difficult to see or follow</li> <li>Easy to install compared with systems that steer the tractor</li> <li>Lower cost than semi-autonomous or autonomous systems</li> </ul>	<ul style="list-style-type: none"> <li>Operator must still steer the vehicle</li> <li>Difficult to steer on curved rows</li> <li>More overlap is required than for systems that steer the vehicle</li> </ul>
Semi-autonomous	<ul style="list-style-type: none"> <li>An operator is present to ensure the vehicle is operating properly and safely</li> <li>Less overlap and fewer skips than systems steered by an operator</li> </ul>	<ul style="list-style-type: none"> <li>Moderate cost</li> <li>Systems require additional training for the operator</li> </ul>
Fully autonomous	<ul style="list-style-type: none"> <li>No operator required—reduced labor costs</li> <li>Less overlap and fewer skips than systems steered by an operator</li> </ul>	<ul style="list-style-type: none"> <li>High cost</li> <li>Enormous liability</li> <li>Limited awareness</li> <li>Systems require additional training for the producer</li> </ul>
Implement	<ul style="list-style-type: none"> <li>Ensures that the implement stays centered on the row</li> <li>The system requires little or no modification to the tractor</li> </ul>	<ul style="list-style-type: none"> <li>Operator still must steer the tractor</li> <li>Complex mechanism must be added to allow the implement to move relative to the tractor</li> </ul>

However, one of the largest benefits of operators is that they can identify situations of danger or concern to bystanders or the machinery and take corrective actions or stop the vehicle. One “rural legend” describes a situation in which a fatigued operator on a cotton picker napped as the picker moved across the field, as the guidance system would keep the picker on the rows. However, he did not wake up in time to turn at the end of the field and the cotton picker sank to the bottom of the irrigation canal. There is value in having alert operators on machines.

### **2.1.2 Operator-Assisted Vehicle Guidance**

To overcome the inefficiencies associated with an operator’s poor judgment of distance, operator-assisted systems aid the operator in determining in which direction to steer the tractor. The most common operator-assisted system is the light bar. Light

bars were first used for aerial pesticide application, to provide the airplane pilot with an indication of whether they should steer right or left to stay on a parallel swath to their previous path. This is particularly important for pilots as they cannot physically see the last path they sprayed. The light bar was adapted to large sprayers with long booms as the foam markers are 60 feet away on a 120-foot boom. The foam markers are difficult for the operator to see and judge if they are on a parallel course with no overlap. Operator-assisted guidance systems usually use a GPS receiver to track the vehicle position.

Originally, operator-assisted guidance systems were developed for airplanes for use with parallel swathing in straight lines. In many parts of the world, crops are planted on contours to reduce soil loss. New guidance systems incorporate parallel swathing on curved rows. Unfortunately, it is more difficult for operators to steer the vehicle on a curved row using a light-bar system. Curved parallel swathing works much better when implemented as a semi-autonomous guidance system.

A common problem is controlling the position of the cultivator (or other implement) and wheels of the vehicle to ensure crops do not get crushed or damaged as the vehicle turns for the curves. The damage to crops can be reduced by using a vehicle that steers both the front and back axles or articulates. Additionally, separate guidance systems can be used to shift the implement to keep it centered on the row. Implement guidance systems are discussed in more detail below.

Light-bar guidance systems have several benefits. They are relatively inexpensive, easy to install, and reduce overlap and skips. Generally, light-bar guidance systems use lower accuracy GPS systems as the operator cannot control the vehicle to the higher accuracy of the more expensive guidance systems. In addition, as light-bar guidance systems do not steer the vehicle, the hydraulic and electronic components of the system are not needed, making them much less expensive than semi-autonomous or autonomous guidance systems. Similarly, as the only components that need to be installed on the vehicle are the light bar and the GPS receiver, they are much less difficult to install than systems that require modification to the vehicle.

The light-bar guidance systems reduce input costs and increase yields by reducing overlap and skips. If overlap is reduced compared to an operator, the producer will save on input costs (seed or chemicals). If the number of skips is reduced, particularly with chemical applications, crop yields will increase due to reduced weed pressure on the crop.

### **2.1.3 Semi-Autonomous Vehicle Guidance**

In operator-assisted guidance systems, the operator steers the vehicle, based on an input from the guidance system. The response of the operator is delayed, and variability is introduced by their response. This can be taken a step further so that the guidance system actually steers the vehicle itself. The main advantage of semi-autonomous

guidance systems is that the system can guide the vehicle in a more consistent and repeatable manner than an operator steering the vehicle manually or using an operator-assisted guidance system.

Semi-autonomous guidance systems take on a wide variety of shapes and sizes. Some consist of simple feelers that guide the vehicle closely to the row, whereas others use GPS to steer the vehicle in parallel paths, similarly to the operator-assisted systems. The feeler-style guidance systems tend to work best in row crops where there is a furrow to follow or plants, such as corn or cotton, that the feelers will not damage. The GPS-based guidance systems tend to provide the most benefit when trying to plant or spray parallel swaths or contours of crops, when it is difficult for the operator to determine where to steer the vehicle. Semi-autonomous systems have an advantage over operator-assisted guidance systems working on contours, as it is difficult for an operator to steer the vehicle along a contour using a light bar as a steering aid.

Retaining the operator on the vehicle also helps to relieve the agricultural producer and the machinery manufacturers from the liability associated with autonomous vehicles. The operator has the responsibility to ensure that the vehicle operates safely in a controlled manner. Without the operator, the agricultural producer would be responsible for any mistakes in programming the system, and the machinery manufacturer would be responsible for any errors caused by the design or manufacture of the guidance system. If an operator is on the vehicle, in situations that pose a danger to the vehicle or environment, the operator can override the system and take control of the vehicle.

### ***2.1.4 Fully Autonomous Vehicle Guidance***

A fully autonomous vehicle expands on the concept of the semi-autonomous guidance system by adding control of all vehicle functions, eliminating the need for an operator. Good examples of such autonomous vehicles are seen in the Defense Agency Research and Procurement Administration (DARPA) Grand Challenge. In the Grand Challenge, fully autonomous vehicles race through the Mojave Desert in California over a 131.2-mile course competing for a \$2,000,000 prize. On October 8, 2005, Stanford University's Stanley won the competition by traversing the course in 6 hours and 53 minutes. In the Grand Challenge, the creators of the vehicles are not allowed to have any contact with the vehicle after the start of the race. A predetermined route is delivered to the contestants to enter into the vehicle's guidance system 2 hours before the start of the race. This is similar to how fully autonomous vehicles operate in agricultural applications. However, the producer should have contact with the vehicle wirelessly to ensure that it is operating properly.

Fully autonomous vehicles tend to use GPS as a primary source of location, and an array of secondary sensors for location relative to the crop and safety. The GPS receiver is used to locate the vehicle in the field. If higher-grade GPS (1 cm accuracy)

is used, it may be accurate enough to guide the vehicle in operations such as cultivation, but these systems are very expensive. Lower-grade GPS receivers (10 cm accuracy) can be used to get the vehicle to the correct position on the rows, then a local sensor system, such as feelers or a vision guidance system, can be used to steer the vehicle accurately with respect to the rows so crop damage is minimized. The GPS can also be used to tell the vehicle when to turn at the end of the field, or automate functions throughout the field to vary tillage, planting, or other operations.

The disadvantage to autonomous vehicles is that liability associated with their use could fall back to the manufacturer, rather than the operator. This is why semi-autonomous vehicles are more appealing in agricultural markets. However, there may be some situations in which the liability of using an autonomous vehicle is less than the liability of sending an operator into a hazardous situation. Good examples include spraying chemicals that are hazardous to the operator, disaster areas, and minefields.

### **3. IMPLEMENT GUIDANCE SYSTEMS**

An alternative to guiding the whole vehicle is to guide just the implement with respect to the rows. On implement guidance systems, an operator steers the tractor down the rows. The hitch on the implement is designed to allow the implement to translate side-to-side. An electronic control system measures the row position relative to the implement with feelers or other sensors then controls the position of the hitch with hydraulics to keep the implement centered on the row.

If the implement is fixed with respect to the tractor, the operator will often run over the crop on curved rows to keep the implement centered in the row. As the implement is guided to be centered on the rows, the operator can focus on steering the tractor in the optimum direction to reduce damage.

The cost of implementing a guidance system on an implement can still be substantial because a hitch with a hydraulic actuator needs to be constructed in order to use the ECU and sensors to control the position of the implement. One cost advantage that implement guidance systems have over vehicle guidance systems is they can be used on most tractors without modification if they are designed properly.

### **4. GUIDANCE METHODS**

Over the last century, many different guidance systems have been researched, patented, and implemented. The most simple guidance systems, such as factory robots, may follow a line of yellow paint on the floor. These systems can operate safely in a controlled environment where there are no obstacles or unknown features. However, in agriculture, the outdoor environment presents a unique set of challenges that often require more than

**Table 4.2** A Comparison of Various Technologies Used for Vehicle Guidance

<b>Technology</b>	<b>Advantages</b>	<b>Disadvantages</b>
Global Positioning System (GPS)	<ul style="list-style-type: none"> <li>• Readily available for free</li> <li>• Provides relatively accurate signal most of the time</li> <li>• Provides signal anywhere</li> <li>• Does not typically need any extra equipment set up</li> </ul>	<ul style="list-style-type: none"> <li>• Can require expense, depending on the accuracy required</li> <li>• RTK-GPS systems require a base station to be used</li> <li>• Can experience temporary degradation or loss of signal under some conditions</li> <li>• Some differential correction services require subscription fees</li> </ul>
Machine vision	<ul style="list-style-type: none"> <li>• Images can provide lots of information, including crop health, weed pressure, and obstacle detection</li> <li>• Senses crop and guides relative to the crop</li> </ul>	<ul style="list-style-type: none"> <li>• Information can be difficult to extract from the image</li> <li>• Costs can be quite high, but are decreasing rapidly</li> <li>• Processing speed can be slow, but technology is improving</li> <li>• Often temperamental because of natural lighting and environmental conditions</li> </ul>
Dead reckoning	<ul style="list-style-type: none"> <li>• Very low cost</li> <li>• Easy to implement</li> </ul>	<ul style="list-style-type: none"> <li>• Any biases are integrated and the position error becomes large in a short period of time</li> </ul>
Inertial	<ul style="list-style-type: none"> <li>• Very reliable</li> <li>• Errors are lower than dead reckoning</li> <li>• Can be used to improve the GPS position signal by correcting for the vehicle dynamics</li> </ul>	<ul style="list-style-type: none"> <li>• Any biases are integrated and the position error becomes large</li> <li>• Errors are related to the quality of the sensor, but are typically lower than dead reckoning</li> <li>• High-quality inertial sensors are expensive</li> </ul>
Crop feelers	<ul style="list-style-type: none"> <li>• Low cost</li> <li>• Very accurate</li> </ul>	<ul style="list-style-type: none"> <li>• Require a woody plant with a stiff stalk to actuate the sensor and avoid plant damage</li> </ul>
Furrow followers	<ul style="list-style-type: none"> <li>• Low cost</li> <li>• Moderately accurate</li> </ul>	<ul style="list-style-type: none"> <li>• Require a furrow to follow</li> <li>• Poorly designed systems can self destruct if the vehicle backs up</li> </ul>

one type of technology to be used to guide vehicles. [Table 4.2](#) provides a comparison of some of the more common technologies used for vehicle guidance systems.

## 4.1 GPS

Most vehicle guidance systems in agriculture use GPS to determine the position, speed, and heading of the vehicle, and to steer the vehicle in the proper direction.

The GPS system uses signals emitted from a constellation of 24 satellites orbiting the Earth to determine the geographic position of the receiver. The satellites emit signals in two frequency bands, referred to as L1 and L2, to improve the accuracy of the position signals. The nominal accuracy of GPS systems is 10–20 m with single-band receivers and 5–10 m with dual-band receivers. The accuracy of the GPS signal is affected by atmospheric conditions, obstructions, reflections, and the visibility of satellites. When the receiver has a clear view of the horizon and can see many satellites, the quality of the position fix is good and the receiver can accurately determine its position. However, if the weather is bad, and there are obstructions that block the signal or cause reflections, such as trees and buildings, the position signal becomes much less reliable. Similarly, if there are few satellites in view, or if they are low on the horizon, the position signal also becomes less reliable and has larger error.

There are some techniques that can be used to minimize some of the errors in the positioning signal. Differential GPS (DGPS) receivers use an existing GPS receiver at a known static location on the ground, called a base station, to correct for errors in the position of the mobile receiver. The difference between the actual location of the static receiver and the measured location of the static receiver (the error) is calculated and broadcast on a radio to the mobile GPS receiver. The mobile receiver then subtracts the error from the measured location of the mobile receiver, correcting for errors caused by the visibility of the satellites and the atmospheric conditions. As the distance from the base station increases, the accuracy of the differential correction decreases, as the signals at the base station will be slightly different from the signals seen by the mobile GPS receiver.

Setting up a local base station for differential correction doubles the cost of the GPS system and poses additional hassle for the user. Several systems have been set up to provide differential correction signals without requiring a local base station. In North America, the most common forms of differential correction are the Coast Guard Beacon, fee-based satellite correction, and the Wide Area Augmentation System (WAAS). The Coast Guard Beacon was developed by the United States Coast Guard to improve the accuracy of GPS receivers used to guide ships through navigable waterways. Although the Coast Guard Beacon signal is freely available, it is only available near navigable waterways, and the accuracy of the signal degrades as distance from the waterway increases. Several subscription-based differential correction services are available from providers, including Omnistar. The subscription-based services are widely available and have good accuracy, but they do require an annual fee. Another system used for differential correction in North America (WAAS) was developed by the Federal Aviation Administration to provide accurate and reliable differential correction to aircraft using GPS to aid in guiding the aircraft and landing. WAAS operates similarly to the fee-based satellite correction systems, but requires no subscription fees. Similar systems are being developed in other parts of the world, for example, the

Euro Geostationary Navigation Overlay Service (EGNOS) in Europe and the Multi-Functional Satellite Augmentation System (MSAS) in Asia. Typical accuracies for DGPS systems are less than 1 m.

Other types of GPS systems used for highly accurate navigation are Real-Time Kinematic (RTK) GPS systems. With RTK-GPS systems, a base station must be used with a radio to transmit the data to the GPS receiver. The RTK-GPS receivers monitor the carrier phase of the GPS signals to help improve the accuracy. The accuracy of RTK-GPS systems is typically within 1 cm, provided that the mobile receiver is within several miles of the base station. Unfortunately, RTK-GPS receivers do require a base station and they are expensive.

In addition to position, GPS receivers can also give accurate information on heading and speed. GPS receivers can output heading and velocity information that is much more accurate than what can be calculated based on the difference between the last two positions. Most overlook the usefulness of the heading and speed information, but this is helpful in developing guidance systems for vehicles.

If multiple antennas are used on the vehicle, additional information can be determined with regard to the pitch, roll, and yaw angles of the vehicle. These systems, called vector GPS systems, are often used on aircraft. Stanford has also used a vector GPS system to guide a John Deere tractor. As the vector systems provide pitch, roll, and yaw information, they can be used to compensate for the error in vehicle position occurring as a result of the tilt of the vehicle. Although these systems give additional useful information, they are more expensive as they require additional antennas.

If only one antenna is used, inertial sensors or tilt sensors can be used to correct for the position of the antenna when the vehicle is operating through uneven terrain. Tilt sensors use accelerometers to measure the tilt angle of the vehicle by measuring the change in direction of the pull of gravity on the vehicle. Once the pitch and roll of the vehicle are known, the GPS location can be transformed into the vehicle coordinate system to determine the exact location of the vehicle.

GPS systems vary in accuracy and cost when used with different guidance strategies, from operator-assisted guidance systems, such as light bars, to completely autonomous vehicle systems. GPS systems that use freely available differential correction signals are accurate enough to use with the operator-assisted guidance systems. The fee-based differential correction signals provide enough accuracy to guide semi-autonomous vehicles for planting and spraying applications. However, RTK-GPS systems are often required when centimeter-level accuracy is needed for such operations as cultivation.

## 4.2 Machine Vision

Machine vision can be used for several aspects of guidance, including line following, row following, and safety. Often, material handling robots in factories follow lines

painted on the floor. The factory robots use a vision sensor to look at the line painted on the floor that has substantial contrast to the floor. A camera constantly monitors the line by comparing the intensity of the line to the intensity of the floor. Based on the location of the line in the image, the ECU steers the robot left or right as it moves through the factory along the line.

In row crops, machine vision can be used to identify the location of the crop and guide the vehicle relative to the rows for cultivation or spraying operations. Typically, near infrared (NIR) cameras are used to detect the plants, as the chlorophyll in plants is highly reflective in the NIR range. Different image processing techniques are used to separate the plants from the soil and to determine the location of the rows in the image. The ECU converts the row location into the tractor coordinate system and steers the tractor to minimize crop damage. The vision guidance systems often look ahead of the vehicle to determine any curvature or change in the path of the rows. The ECU can then position the vehicle to enter the corner in a position that will reduce crop damage beyond what can be done if the rows were sensed closer to the vehicle.

In addition, the machine vision system can also be used to determine other information, such as crop health and weed infestation. Plants reflect light differently, depending on their health. This is often related to nitrogen or other deficiencies in the soil nutrients. If plants are detected between the rows, they are usually weeds. The density of the weeds between the rows can be used to identify locations in the field where pesticides need to be applied to the crops to reduce weed pressure and improve yield when nutrient deficiencies are identified. The producer can then return to the area in the field, take soil samples to determine the problem, and apply fertilizer or chemicals to correct the deficiency. Some researchers have developed systems that automatically vary the rate of fertilizer or chemical application, as areas of poor crop health or weed infestation are identified as the vehicle travels across the field.

Another type of machine vision system that can provide 3-D information on the surroundings is a stereovision system. A stereovision system works similarly to human depth perception. Two cameras are placed at a known distance apart. When a point in the image is detected at one position in the first camera, and another position in the second camera, triangulation can be used to determine the distance of the point from the cameras. The 3-D information can be used to help identify the location of the rows with respect to the vehicle, as the 3-D image of the crop height makes the rows easier to locate when they are difficult to segment into rows and soil in a conventional 2-D image.

### **4.3 Dead Reckoning**

Imagine turning off the light at night and walking toward the bed when you are unable to see—this is dead reckoning. As dead reckoning is used to traverse longer distances, the likelihood of arriving at the desired destination is reduced. It might be



easy to go from the light switch to the bed, but it is more difficult to go from one end of the house to the other without bumping into anything.

Dead reckoning is not a good form of guidance, but it can be used for short spans of time when other sensors fail. Dead reckoning typically uses the vehicle speed and steered wheel position to determine where the vehicle is heading. When other sensors are lost, the speed and direction can be integrated to estimate the current vehicle position. Unfortunately, any error in the sensors is also integrated, creating a larger error as time increases.

#### **4.4 Inertial**

Inertial sensors can also be used to dead reckon. However, they require double integration of the linear and angular acceleration, leading to large position errors over time, depending on the accuracy of the sensors. There are some gyroscopes (ring laser gyroscopes) that are very accurate and stable over time, which are used to guide aircraft and submarines; however, they are very expensive. Lower-cost gyroscopes (fiber optic gyroscopes) still have good accuracy to supplement a sensor such as GPS, but they cannot be used to guide a vehicle over long distances.

One of the earlier guidance systems, patented for use on tractors, used a mechanical gyroscope to keep the tractor moving in a straight line. Unfortunately, mechanical gyroscopes have friction in the rotating parts that cause drift over time, and they have never proved to be a commercial success for guidance systems on agricultural vehicles.

#### **4.5 Crop Feelers**

In some situations, feelers can be used to detect the row and guide the vehicle down the row. Feelers are most effective when used with mature, woody crops such as cotton or corn because the feelers can firmly maintain contact with the stalks without breaking them. Using crop feelers to ensure that the cotton picker stays centered on the row for optimum picking efficiency is commercially successful and is offered as an option on new equipment from the manufacturers.

Most crop feelers use wands on opposite sides of a row that are spring loaded and deflected as a plant comes near. A sensor is mounted to the wand to determine the position of the wand, and thus the position of the row of plants. The ECU looks at the position of the sensors on both sides of a row and steers the cotton picker to keep the drums centered on the row. Feelers are also used to guide cultivators and other implements in standing crops by similar means.

#### **4.6 Furrow Following**

The earliest tractor guidance systems used a wheel or feeler to guide the vehicle along a plow furrow. A wheel follows the edge of the furrow and steers the

tractor to keep it parallel to the furrow. Over the years, furrow following guidance systems have been adapted to work using furrows from planter markers and bedded crops. Many patents have been granted on furrow following guidance systems for agricultural vehicles.

Modern furrow following systems use techniques similar to crop feelers to guide the vehicle. The wheel or sled that runs in the furrow is attached to an arm that pivots about a point on the tractor. As the arm moves to the right or left of the center position, the ECU steers the tractor to keep the implement centered on the rows.

## **5. CHALLENGES FACING AUTONOMOUS VEHICLES**

There are several obstacles preventing the adoption of autonomous vehicles, the most notable being safety and liability. The safety of the environment, including human bystanders, and the machinery itself is the most serious shortfall of current autonomous vehicles. Some sensors can be used to detect people and the surrounding environment, but they still cannot compare with the awareness of a human operator. Because of this reduced awareness, liability associated with the failure of the autonomous vehicle system falls back on the manufacturer of the vehicle. Needless to say, manufacturers are not willing to risk the liability to produce fully autonomous vehicles because the costs of the vehicle would be too high to cover the costs of the liability, with the present state of the technology.

### **5.1 Safety**

Safety is the most important aspect of autonomous vehicles. There are two types of safety associated with autonomous vehicles: the safety of the environment from the autonomous vehicle, and the safety of the vehicle from damaging itself. In order to operate safely in an environment, the autonomous vehicle must be able to recognize an obstacle, including bystanders, and take action to avoid the obstacle or cease operation until the obstacle is removed. The vehicle must also be able to operate without damaging itself, by evaluating its own health, and recognizing the limits of its capabilities. Many of the sensors and systems for monitoring health are already built into the electronic controllers on current vehicles. Other sensors must be added to evaluate the environment and assess the vehicle capabilities.

There are many safety sensors that can be installed on a vehicle to allow it to be more aware of its environment so it can operate safely. These sensors are used to detect changes in terrain, detection of obstacles, human presence detection, and vehicle capability assessment. Typical safety sensors used include, but are not limited to, machine vision systems, GPS, Radio Detection and Ranging (RADAR), Light Detection and Ranging (LIDAR), ultrasonic sensors, microwave sensors, and tactile (feeler) sensors.

Several different forms of machine vision systems can be used to detect obstacles near autonomous vehicles. The vision systems for guidance discussed earlier can also be used to detect obstacles. However, the obstacles must be taller than the crop, and they must have features that allow them to be differentiated from the crop. Detection systems for human presence often use infrared (IR) cameras that can sense the heat from the human body and segment the human (or other animal) from the background based on the temperature. Obviously, an IR system will have some limitations as the ambient temperature of the environment nears that of the human body.

GPS can be used to impose safety boundaries on vehicles. The ECU of the guidance can monitor the position of the vehicle and stop the vehicle if it ever crosses a boundary set by the operator. This limits the damage the vehicle can do to the environment within the boundary, such as a field, and reduces the risk that the vehicle poses to the environment. The GPS system can also be used to locate an obstacle before the vehicle even enters an environment, and ensure that the vehicle recognizes the obstacle and takes appropriate measures to avoid it.

3-D LIDAR sensors can be used to make a 3-D map of the terrain in front of the vehicle. This 3-D map can be used to identify changes in contour, such as ditches or steep slopes, which may upset the vehicle or cause the vehicle to become stuck. In addition, LIDAR sensors can detect 3-D obstacles that may be in the path of the vehicle. LIDAR sweeps a laser in a 2-D pattern across the area and records the distance to each point. As a discrete number of points are observed, LIDAR may not reliably detect porous or transparent objects, such as fences. The resolution of LIDAR can be increased to detect smaller objects. However, the update rate of the sensor slows down and the amount of data to be analyzed increases, both decreasing the utility of the system. RADAR systems emit radio signals instead of light pulses and measure the time that is required for them to bounce off objects and reflect back to the sensor. As RADAR is less focused than LIDAR, it can often see small objects that LIDAR might not detect, particularly at longer distances, depending on the resolution of the LIDAR.

Ultrasonic sensors, microwave sensors, and tactile sensors are typically used to detect obstacles, human presence in particular, very close to the vehicle. These sensors often only have a range of a few feet, except the tactile sensors that require physical contact. These sensors are useful close to the vehicle because of their versatility and low cost, which the other sensors cannot detect because of their range, versatility, and low cost. A disadvantage in agriculture with these sensors is that they often give false positive detections due to the crop, causing the vehicle to stop unnecessarily.

If the vehicle has an operator on board, the operator is able to take control of the vehicle at any time. This adds an enormous amount of safety to the vehicle, as human operators have an unparalleled ability to look at the surroundings and identify hazards. When the human operator perceives a hazard, the vehicle guidance system can be

disabled and the operator can stop the vehicle or take action to avoid the hazard. Until autonomous vehicles can identify hazards with human-like perception, human operators will still be used on vehicles with semi-autonomous guidance systems to ensure the safety of the environment and the vehicle, unless the situation poses a substantial risk to the operator.

## 5.2 Liability

If there is no operator on the vehicle, all of the liability will fall on the manufacturer. In tightly controlled factory environments, safety sensors can be installed on autonomous vehicles to allow relatively small vehicles to operate safely in a factory or office environment. However, agricultural vehicles operating in the field are subject to unknown conditions that increase the risk of damage to the environment and the vehicle.

The size of the vehicles increases the liability as the vehicle can do more damage to property. A small factory robot that weighs several hundred pounds and has very little power and a very slow speed can still do some damage to the environment. However, the amount of damage that can be caused by a 25-ton agricultural vehicle with 500 horsepower capable of traveling at higher speeds is much more substantial—there is not much that could stop it.

In some situations, the liability of the autonomous vehicle might be outweighed by the liability of exposing a vehicle operator to a dangerous situation, such as clearing minefields. Minefields are often cleared by hand, where a specially trained person slowly locates and tediously diffuses the mine. An alternative is to mechanically explode the mine. Special machines have been designed to travel across minefields and explode the mines using large blades or flails. These machines would be a good possibility for a fully autonomous vehicle. Unless the situation poses a great risk to the operator, there will still be operators on the vehicles to help ensure the safety of the vehicle and environment and reduce the liability to the manufacturer and producer.

## 6. SUMMARY

The shifting of society to an agrarian system, then to an industrial society with populations mainly located in urban areas, has reduced the availability of agricultural labor and caused an increase in the mechanization of agricultural machinery. Agricultural mechanization started with the steam powered reapers and traction engine, then advanced with the invention of mobile hydraulics and electronic control systems that are used in modern machinery today. These systems can be combined with various sensor systems, including GPS, to help guide and automate the vehicles to improve their efficiency, reduce crop damage, and improve crop yields through better cultural practices.

The four different classifications of vehicle guidance systems are manual, operator-assisted, semi-autonomous, and fully autonomous. Manual systems use an operator to steer the machinery based on their perception of the environment. Operator-assisted guidance systems use a sensor such as GPS to determine the location of the vehicle and display a visual cue such as a light bar, indicating that the operator should steer the vehicle left or right based on the measured position of the vehicle. Semi-autonomous guidance systems expand on the operator-assisted systems by generating a signal that actually steers the wheels of the vehicle. The operator is still present to ensure the vehicle is functioning properly and safely. A fully autonomous vehicle integrates all aspects of vehicle monitoring and control into a single, autonomous system. The vehicle must interact with its surroundings to ensure that it does not damage itself, the environment, or bystanders.

Several different technologies can be used or combined to provide reliable guidance systems for mobile vehicles. The most common guidance systems use GPS to find the location of the vehicle and provide input to the operator or steering system to guide the vehicle along a desired path. Dead reckoning or inertial guidance systems can be used to improve the GPS signal or to allow the vehicle to continue operating for a small amount of time if a temporary loss of signal occurs. However, they cannot be used for extended periods as any bias in the system causes errors to grow over time. Some forms of guidance systems focus on guiding the vehicle relative to the crop. Machine vision, crop feelers, and furrow followers identify the row or furrow and steer the vehicle to follow the row or furrow, or a parallel path. Many technologies have been developed to aid in guidance systems for agricultural environments, and some are commercially available to agricultural producers.

There are, however, several challenges facing the use of autonomous vehicles. Safety is the largest challenge as present systems cannot compare with human operators in their perception and understanding of the environment around the vehicle. As an autonomous vehicle cannot match the perception of a human operator, the machinery manufacturer and the agricultural producer would face a large amount of liability for any failures in the vehicle. For these reasons, operators will be used in agricultural vehicles until the perception systems improve, except in situations such as removal of land mines, which pose a danger to the operator.

## REFERENCES

- Silver, W.H., 1930. Tractor guide. U.S. Patent No. 1,900,525.  
Slaughter, D.C., Curley, R.G., Chen, P., Giles, D.K., 1995. Robotic cultivator. U.S. Patent No. 5,442,552.  
Snyder, W.H., 1884. Traction engine. U.S. Patent No. 314,072.  
Williams, T.A., 1985. Sensing unit for row crop harvester guidance system. U.S. Patent No. 4,528,804.

## OTHER CONTACTS

AGCO. <[www.agcocorp.com](http://www.agcocorp.com)>.

AgGuide. <[www.agguide.com.au/rowguide.htm](http://www.agguide.com.au/rowguide.htm)>.

AgLeader. <[www.agleader.com/products.php?Product=guidance](http://www.agleader.com/products.php?Product=guidance)>.

Automatic Agriculture. <[www.automaticag.com/guidance/guidance.html](http://www.automaticag.com/guidance/guidance.html)>.

Carnegie Mellon Robotics Institute. <[www.ri.cmu.edu](http://www.ri.cmu.edu)>.

CaseIH. <[www.caseih.com](http://www.caseih.com)>.

DARPA Grand Challenge. <[www.darpa.mil/grandchallenge](http://www.darpa.mil/grandchallenge)>.

John Deere. <[www.deere.com](http://www.deere.com)>.

National Centre for Engineering in Agriculture, University of Southern Queensland. <[www.ncea.org.au](http://www.ncea.org.au)>.

New Holland. <[www.newholland.com](http://www.newholland.com)>.

Novariant. <<http://www.novariant.com/agriculture/index.cfm>>.

Orthman. <[www.orthman.com](http://www.orthman.com)>.

Stanford University Racing Team. <[www.stanfordracing.com](http://www.stanfordracing.com)>.

Sukup. <[www.sukup.com/guid.htm](http://www.sukup.com/guid.htm)>.

Trimble Navigation. <[www.trimble.com](http://www.trimble.com)>.

University of Illinois at Urbana-Champaign. <[www.age.uiuc.edu/oree](http://www.age.uiuc.edu/oree)>.

This page intentionally left blank

# Air Seeders for Conservation Tillage Crop Production

John Nowatzki

North Dakota State University, Fargo, ND, USA

## 1. OPENER DESIGN OPTIONS

The performance of the openers on air seeders determines the effectiveness of the planting operation. The basic type of openers affects seed and fertilizer placement in the soil, seedling development and crop yields. Various opener designs can impact short-term and long-term soil conditions and the field and surrounding environment.

The two basic opener designs used on air seeders are disc and hoe openers. “Hybrids” of these two opener designs incorporate some of the features of both. Disc openers can be single or double disc, with gauge wheels mounted beside and in contact with the disc opener, or with a trailing packer wheel functioning as a gauge wheel. [Figure 5.1](#) illustrates a typical disc opener mounted on an air seeder. Disc openers cut a narrow channel in the soil and insert seeds and fertilizer.

Hoe openers are available in various widths from less than 1 in. wide spikes to sweeps several inches wide. Hoe openers can be mounted on flexible, rigid, or jointed shanks. [Figure 5.2](#) shows an example of an air seeder equipped with narrow hoe openers that cut narrow trenches in the soil. Seeds are dropped into the trenches directly behind the openers before the soil can fall back to cover the trenches. [Figure 5.3](#) shows an example of a narrow hoe opener mounted behind a fluted coulter that cuts through residue remaining from the previous year’s crop. The discs mounted on each side of the hoe opener push soil to cover the seeds and close the trench made by the opener.

Crop producers choose opener types based on specific management goals and local cropping conditions. In choosing an opener, producers need to consider the amount and type of crop residue, the crop being planted, fertilizer placement, and soil type and conditions. Air seeder opener designs also influence the amount of residue maintained on the soil surface and the position of the residue after planting.

Disc openers leave most of the existing residue on the soil surface or standing after planting, which impacts soil temperature and moisture. Planting with disc





**Figure 5.1** *Disc opener.*



**Figure 5.2** *Hoe opener.*

openers in fields with thick residue lying on the soil surface can result in seed placed in residue rather than placed directly in soil. Crop producers refer to this as hair-pinning. [Figure 5.4](#) illustrates pieces of residue pressed into the seed channel. This is a common problem occurring while using disc openers when the surface residue is wet or damp.

Disc openers generally disturb soil less than hoe openers, maintaining moisture in the seed zone. However, this may slow soil warming after planting. Hoe openers cause more soil disturbance resulting in more of the residue mixed into the soil. Hoe openers push residue aside to place seed into tilled soil, which can promote both soil warming and drying.



**Figure 5.3** *Hoe opener with cutting coulter and closing discs.*



**Figure 5.4** *Hair pinning.*

## **2. MANAGING CROP RESIDUE**

Crop residue is a resource to conserve and use. Crop residue is a food source for beneficial fungi, bacteria, and insects, limits evaporation from the soil surface, and maintains water vapor in the soil.

Crop producers manage crop residue based on several factors including the crop being planted, soil type, annual precipitation, crop rotations, the amount of residue present in fields, and their overall tillage system. Generally, seedlings of larger seeds can emerge through more residue than smaller seeds. Areas with greater annual

precipitation generally produce higher yielding crops resulting in more crop residue. Some crops such as canola, soybeans, and dry beans produce much less crop residue than corn and small grain crops. No till systems result in more crop residue left standing or on the soil surface compared with more intensive tillage systems.

No till cropping systems also affect annual crop nutrient availability. North Dakota State University extension service wheat nitrogen fertilizer recommendations include a 20 lbs per acre negative credit for fields that have been no tilled for less than 5 years, and a 50 lbs per acre positive credit for fields that have been no tilled for more than 5 years (Franzen, 2009). Soil scientists suggest that this increase in nitrogen efficiency in long-term no till may occur because organic compounds are formed by soil organisms shortly after fertilizer application, creating, in effect, a slow release fertilizer. Air seeder openers that preclude a no till system impact the nitrogen fertilizer recommendations, although single, annual passes with hoe openers that are operated 3' or less in the ground would not negate the no till nitrogen credit. Figure 5.5 shows wheat stubble after harvest grown. Corn stalks on the soil surface with the wheat stubble are from the previous year's corn crop, indicating successful no till crop production after a high residue crop.

Strip till used with no till in years when row crops are rotated with solid-seeded crops does not negate the increased nitrogen efficiency because areas between the tilled strips continue the organic matter buildup over time. Figure 5.6 shows 8 in. wide strips tilled in wheat stubble. The soil in the tilled strips warms faster than the untilled stubble between the strips during the spring season. Warmer soil allows crop producers to plant earlier in the season.

Managing crop residue at harvest time impacts the planting operation during the next crop season. Crop residue should be spread uniformly during the harvest operation. Uniform distribution of crop straw and chaff facilitates uniform seed placement during seeding. Spreading straw and chaff after harvest is difficult and ineffective. Straw chopper/spreaders and chaff spreaders work best spreading crop residue over the width of the combine header. During harvesting, combines should continue to move until all crop residue is cleared from the machines. Stopping combines before all of the straw and chaff has been cleared results in residue piles in the field that can interfere with seeders.

Disc openers function better in standing residue rather than where the residue is cutoff and laying on the soil surface; hoe openers generally function better in these conditions. However, hoe openers may cause bunching if the residue is wet or unevenly spread. Wider distances between seed rows and more vertical clearance of the seeder help prevent bunching. Combines can be equipped with stripper headers that remove only the grain heads, leaving all the grain stalk standing. Disc openers function best in this very tall stubble. Figure 5.7 is an image of wheat stubble following harvesting by a combine equipped with a stripper header. The tall stubble can be advantageous for crop production in drier climates because the tall stubble prevents the wind from blowing snow off fields, increasing soil moisture.



**Figure 5.5** *Wheat stubble with corn stalks.*

The height of standing stubble from the previous crop has little impact on soil temperature but does affect soil moisture the following spring. The NDSU Residue Management Project<sub>2</sub> monitors soil moisture and temperature under various residue management conditions in western, central and eastern North Dakota. Data from this project show that winter and spring soil temperatures are not influenced by stubble height; however, the shorter stubble does dry faster in the spring of the year prior to planting, and holds less moisture in the fall after harvest. The project information and data are available on the internet at: <http://www.ageng.ndsu.nodak.edu/farmmonitor/index.php>.

Row cleaners, usually spoked wheels mounted in front of disc openers, can be used to facilitate planting fields with high residue. Row cleaners push some residue to



**Figure 5.6** *Strip till.*



**Figure 5.7** *Tall stubble, harvested with stripper header.*

the side, allowing the opener to penetrate the soil. Spoke-type row cleaners can become plugged in corn or sunflower residue, with the spokes acting like a trash collector. One solution to this problem is to use smooth discs for row cleaners to push residue aside. Another solution is to plant between the previous year's crop rows without using any row cleaner. One spoked wheel operated at 15–20° from the disc opener operating plane, rather than two spoked wheels, may function better on equipment used to plant in narrow rows with higher crop residue. [Figure 5.8](#) shows spiked disc wheels mounted in front of soil opening coulters. The row cleaners function to move thick residue aside allowing the opener to operate more efficiently.

Hitch guidance technology assists operators with planting between the previous year's crop rows. [Figure 5.9](#) is an image of two metal discs that operate on either side of the opener furrow. If one disc drops lower than the other, then an electric signal triggers two hydraulic rams to push or pull the air seeder hitch, keeping the disc openers between the stubble rows of the previous crop.



**Figure 5.8** *Row cleaner.*



**Figure 5.9** *Row sensor.*

Crop rotations can be used to effectively manage crop residue. Low residue-producing crops, such as peas, soybeans, lentils, flax, safflowers, and sunflowers, can be alternated with high residue-producing crops, such as wheat, barley, and corn.

### **3. SOIL DISTURBANCE AND ENVIRONMENTAL IMPACTS**

The Natural Resource Conservation Service (NRCS) has developed a tillage rating system that can be used for openers called the Soil Tillage Intensity Rating (STIR). This system assigns a numerical value to openers based on operating speed of the

seeder, opener type, depth of operation, and the percent of soil surface area disturbed. Lower numbers indicate less overall disturbance to the soil. Values can range from 0 to 200, with lower numbers indicating a preferable rating. STIR values reflect the type and severity of soil disturbance caused by openers.

Reduced tillage over time increases soil organic matter. Soil organic matter impacts the biological, physical, and chemical properties of the soil. The cation exchange capacity of soil increases with increased organic matter, resulting in an increased ability to hold positively charged plant nutrients, and a decreased leaching potential.

Soil organic matter affects soil structure, resulting in larger and more stable aggregates and reducing the potential for soil compaction. Higher amounts of soil organic matter increase the pore space in soil, which increases the water infiltration rate and the water holding capacity of soil.

Tillage contributes to loss of carbon from the soil. Maintaining carbon in the soil provides a source of microbial nutrients and reduces the amount of carbon dioxide released into the atmosphere.

Soil organic matter increases over time in agricultural soils when crop residue is left on the soil surface. Air seeder opener construction affects soil disturbance, which impacts soil properties and the environment. Research conducted in Minnesota showed that intensive tillage reduced soil organic matter significantly more than minimum or no till. Wide sweep hoe openers cause significant soil tillage resulting in carbon loss from the soil.

#### **4. SEED/FERTILIZER PLACEMENT, ROW SPACING**

Minimum till, one-pass, and no-till seeding with fertilizer application, including injecting anhydrous ammonia at planting time, are common in the northern Great Plains. However, most grain crops require more nitrogen fertilizer than can be placed safely in a narrow seed row.

There is variation in the primary factors affecting the amount of nitrogen fertilizer that can be applied with the seed, depending on the distance between rows and the distribution of both the seed and fertilizer within the row. More fertilizer can be applied with the seed when the seeds and fertilizer are spread over a wider area. Hoe openers generally have greater seedbed utilization than disc openers. Other factors influencing the amount of nitrogen fertilizer that can be placed close to crop seeds include soil texture, soil pH, soil water, precipitation, fertilizer placement, fertilizer form, fertilizer material, and the type of crop. [Figure 5.10](#) illustrates an example of an opener that spreads seeds and fertilizer over an 8 in. strip, which allows for high amounts of nitrogen fertilizer to be placed directly with the crop seeds.

More nitrogen fertilizer can be applied with the crop seeds when a greater amount of soil is disturbed during the planting operation. This means that, in general, more



**Figure 5.10** *Wide disc opener.*

nitrogen can be applied with the seed when planting with hoe openers than with disc openers unless the disc opener design places the seed and fertilizer in separate rows.

The separation of fertilizer from the seeds needs to be greater in some soil conditions, such as in dry, cloddy soils. The risk of stand reduction is greater from nitrogen toxicity in sandier soils than in clayey soils. More than 20–30 pounds per acre of nitrogen fertilizer placed with seeds can result in reduced germination, low seedling emergence, and poor stands, with subsequent yield loss.

Separate fertilizer delivery systems can be used to place fertilizer in a band to the side and below the seed. With disc openers, a separate disc can be mounted between two seed rows to place fertilizer in a band shared by two seed rows. This is called mid-row banding. Mid-row bands deliver nitrogen products safely if there is sufficient space between the seed and fertilizer rows. [Figure 5.11](#) shows a mid-row bander which is a separate soil opener used only to inject fertilizer into the soil. Mid-row banders are mounted on air seeders between the seed openers.

However, mid-row banding places phosphorus materials too far away from the plants to deliver a “starter” effect to young plants. A separate system to deliver phosphorus in or near the seed row is required to achieve “starter” phosphorus effects. Some hoe seeders are designed with a fertilizer tube next to the seed tube that places fertilizer below and to the side of the seed row. This is referred to as double-shooting. Low-draft, double-shooting openers place seeds and fertilizer at the same depth, which is designed to reduce the power required to pull the seeder.

Paired-row opener designs on air seeders plant the seeds in two closely placed rows separated by a wider space between the next two pair-rows. Separate fertilizer openers place the fertilizer in the wider space between the sets of paired-rows. The



fertilizer band is placed below seed depth allowing the downward growth angle of the seminal roots on cereal plants to contact the fertilizer.

The air seed delivery system must deliver enough air to move the correct amount of seed to the farthest ends of the seeder but not blow seeds out of the seed slot or cause damage to the seeds.

This is accomplished by incorporating an air dissipation system into the air delivery system prior to the seed discharge into the opener. [Figure 5.12](#) shows the pipes and



**Figure 5.11** *Mid-row bander.*



**Figure 5.12** *Air delivery system.*

hoses used to move seeds from the air seeder grain tanks to the soil openers. Air seeders are equipped with air blowers to move seeds through the hoses.

## 5. DEPTH CONTROL AND PACKING

Uniform depth placement of both seed and fertilizer influences seedling emergence and, ultimately, crop yield. Seed–soil contact may not be as important for transfer of water from soil to seed as commonly thought. Recent research demonstrated that seeds are capable of germinating without contact with moist soil, because water absorbed by seeds can be directly attributed to vapor. Placing seed at the desirable depth near moist soil is important, but pressing seed firmly into soil is required only to maintain high relative humidity near the seed. Seed germinates just as quickly in loose moist soil as in firm moist soil if it is covered to protect it from the drying effects of wind and sun.

Factors influencing uniformity of seeding depth include independent pressure on each opener assembly, gauge wheels, shank linkage, and caster wheels. Depth control wheels and packer wheels on seeders improve uniform seed depth placement. Packer/gauge wheels mounted close to the point of seed release will place seed more consistently at the proper depth, compared with wheels mounted farther behind or in front of the release point. [Figure 5.13](#) shows air seeder packer wheels mounted behind each soil opener.

Gauge wheels either behind or beside the disc opener allow significant down pressure on the opener to penetrate firm soil and cut residue while maintaining the proper



**Figure 5.13** *Packer wheels.*



**Figure 5.14** Gauge wheel.

uniform seeding depth. [Figure 5.14](#) shows a wheel mounted adjacent to an opener disc that can be adjusted to regulate the depth at which seeds are placed in the soil.

Some degree of packing almost always results in better crop emergence. Trailing press wheels are available in various widths. Narrow press wheels (1.5–2 in. wide) may produce a narrow furrow in loose soil conditions. This can create a problem if rainfall occurs before the seedling emerges because rain can wash the soil between the furrows into the seed row, causing the plant to be covered too deeply. Wider press wheels reduce this problem.

An advantage to the use of narrow press wheels is that the furrow offers protection to the emerging seedling from strong winds. Seeding into a previous crop residue and maintaining residue on the soil surface also provides protection for the emerging seedling. Usually, the press wheel should be about as wide as the seed strip. Wide press wheels can flatten the crop residue, exposing emerging seedlings to wind damage.

Seeders with the ability to monitor and alter pressure independently on openers and packer wheels function better to both place seed at uniform depth and accomplish even packing on seed rows. These systems detect contact of the opener assembly with the soil surface and automatically adjust hydraulic pressure applied to the openers to maintain the desired constant degree of contact with the soil, as soil conditions vary throughout the field.

## **6. VARYING CONDITIONS**

Soil type and soil conditions influence how well openers operate. Neither hoe nor disc openers work as well in wet soils as in drier soils. Seeding or tilling wet soils



**Figure 5.15** *Parallel linkage.*

packs the soil, damaging the rooting environment, which results in reduced crop growth and yield. Clay soils pack well but can become hard when they dry. Clay can build up on packer wheels, changing the seeding depth. Openers can create a “glazed” furrow sidewall in wet conditions, which slows germination.

Seeders need to be flexible to function properly on irregular soil surfaces and sloping fields. Seeders with rigid frame sections larger than 12–14 ft generally do not follow the soil contour on sloping fields and when crossing drainage ditches, resulting in seed being placed too shallowly or unevenly on the soil surface. Parallel linkage has been used on row-crop planters for a number of years, and only recently has this innovation been applied to drills. Parallel linkage on individual openers operating independently of each other allow the opener to track soil surface more accurately, giving a more uniform placement of seed at the desired depth. [Figure 5.15](#) is an example of an opener assembly that insures both the seed and fertilizer are placed at the same depth in the soil. The linkage functions to raise and lower the seed and fertilizer openers simultaneously and by the same amount.

## **7. PRECISION AGRICULTURE**

Air seeders can be used to implement various precision agriculture management practices. Air seeder carts can be constructed with more than one compartment. These compartments can be used for both seed and fertilizers. Clutches automatically vary the seed and fertilizer output regulated by GPS-equipped controllers in the tractor. Variable rate technology allows crop producers to manage fields by productivity zones, applying specific rates of both fertilizer and seed in each zone. [Figure 5.16](#) shows an air cart which includes grain and fertilizer storage tanks, regulators, rate adjustment technology, and the seed air delivery system equipment.



Figure 5.16 Air cart.



Figure 5.17 Computer controller.

Section control technology can provide significant seed savings on wide air seeders, particularly on irregularly shaped fields. This technology uses GPS-equipped controllers to stop seed and fertilizer application when the equipment travels over areas that have already been planted. Air seeders can be manufactured to control various widths of sections. Figure 5.17 shows a computer controller display used in tractors to interact with the air seeder control technology. The computer controller can also be used to record a planting map.

## 8. ENERGY REQUIREMENTS

Fuel consumption is an operation expense that also should be considered in opener selection. Various research studies indicate that the energy requirements to operate air seeders with disc openers are nearly half the energy requirements of similar seeders with hoe openers. The width of the hoe opener, depth of operation, and the unique soil and field conditions affect the energy requirements of each planting operation.

## 9. COMMERCIAL OPTIONS

The main categories of seed openers include single-disc, double-disc, offset double-disc, disc-shoe, hoe and sweep, and wide shovel, which progressively disturb more soil at the time of seeding. Several air seeder manufacturers provide seeders with various opener options. The list of manufacturers included here is not complete, but includes many of the companies that market air seeders in the Great Plains area of the USA.

Amity Technology <http://www.amitytech.com>

Bourgault Industries <http://www.bourgault.com>

Case IH <http://www.caseih.com>

Cross Slot <http://www.crossslot.com>

Great Plains <http://www.greatplainsmfg.com>

Horsch Anderson <http://www.horschanderson.com>

John Deere <http://www.deere.com>

K-Hart Industries <http://www.khartindustries.com>

Morris Industries <http://www.morris-industries.com>

Salford Machinery <http://www.salfordmachine.com>

Seed Hawk <http://www.seedhawk.com>

SeedMaster <http://www.seedmaster.ca>

Sunflower <http://www.sunflowermfg.com>

## REFERENCE

Franzen, D.W., 2009. Fertilizing Hard Red Spring Wheat and Durum. NDSU Ext. Pub. SF-712 (Revised), Fargo, ND.

## FURTHER READING

ASABE D497.7. 2011. Agricultural Machinery Management Data. ASABE Standards. ASABE, 2950 Niles Road, St. Joseph, MI.

Deibert, E.J., 1994. Fertilizer Application with Small Grain Seed at Planting. NDSU Ext. Pub. EB-62. NDSU Extension Serv., Fargo, ND.

Lazarus, W.L., 2009. Machinery Cost Estimates. University of Minnesota Extension, St Paul, MN.

Nowatzki, J.F., Ashley, R., 2010–2012. NDSU Residue Management Project. <<http://www.ageng.ndsu.nodak.edu/farmmonitor/index.php/>>.

Overstreet, L.F., DeJong-Huges, J., 2009. The Importance of Soil Organic Matter in Cropping Systems of the Northern Great Plains. University of Minnesota Extension, St Paul, MN.

This page intentionally left blank

# Grain Harvesting Machinery

H. Mark Hanna\* and Graeme R. Quick\*\*

\*Iowa State University, IA, USA

\*\*Fellow ASABE, Fellow IEAust., Peachester, Queensland, Australia

## 1. GENERAL

Seeds are life. Seeds come in an infinite variety of shapes and sizes that present challenges at harvest. Small grains include wheat and rice as well as small and slippery oilseeds such as flax, poppy, and canola. Large seeds include grain corn with seed on ears, soybeans and beans in pods. Plant height varies from ground-hugging peas to elevated ears on tall cornstalks. Such wide variations create unique demands for harvesting machinery. All these crops from oilseeds, grass, and clover seeds through to large fava beans are mechanically harvested with combines and mechanical threshers. The term “grain” will be used here to include all types of seeds.

## 2. HISTORY

Until the nineteenth century, most grain was harvested by cutting with a sickle or scythe, manually flailed or beaten to break the bond of the grain with the stalk, then winnowed to separate the grain from material other than grain (MOG). In the developing world, these practices or the use of small stationary threshers are still in use for rice and other grain harvesting. Stationary threshers emerged at the time of the Industrial Revolution. The design generally used a tangentially fed rotating cylinder to beat material and break the bond between grain and stalk, followed by a screen or sieve that allowed smaller grain pieces to pass through and separate grain from MOG. Those threshers were powered by human, animal, or water power, and later by engine.

During the nineteenth century, mechanical reapers and binders were developed to mow and collect windrowed grain for field drying. The sheaves were then hauled to stationary threshers. Around the start of the twentieth century animal-drawn machines, “combines”, were developed that integrated cutting, threshing, and separating wheat and small grains. The shortage of manpower during the Second World War hastened the adoption of self-propelled combines.



Corn was initially harvested by hand-picking ears after drying in the field. Manual corn harvest was labor intensive. Early in the twentieth century, Grandpa Sallee hand-picked about 0.4 acre/day. The important job of harvest was a family affair (Grandma Sallee would get a kiss if she found a rare ear of corn with red grain during hand picking).

Mechanical ear corn pickers were commercialized in the USA during the 1930s and had been widely adopted by the time of the Second World War when labor was scarce. Prior to the Second World War, the processing components on small grain combines was not yet rugged enough to thresh corn. Corn pickers were either pulled by the tractor or tractor mounted. Snapping stalk rolls that pulled down cornstalks and snapped off ears were necessarily aggressive but not shielded. Many farmers lost an arm or hand or worse caught in the rolls while trying to unplug stalks with the picker still running. Snapping rolls were later shielded by stripper or deck plates. Ear corn was commonly stored and further dried by natural air in a crib with gaps between side boards. Corn was fed locally to livestock or threshed by a stationary thresher before entering the commercial grain trade. Although seed corn is still commonly mechanically harvested by ear followed by carefully controlled storage then stationary threshing of seeds from the ear at a central location, handling the full ear doubles the amount of material that must be stored and handled. Advances in artificial corn grain drying and more rugged threshing and separation components in combines transformed corn harvest from ears to field-shelled grain in the 1960s.

### **3. PRE-HARVEST ISSUES THAT AFFECT MACHINE DESIGN**

Harvest equipment design criteria and operation are affected not only by the type of crop but also by the limited time available for harvest and cultural practices associated with the crop. Grain and oilseeds rapidly mature in just days before harvest. Grain moisture content drops rapidly as the plant matures. Unless the grain is artificially dried, harvest is delayed until moisture content is low enough to avoid spoilage during the time the grain will be in storage. If seeds and plants are left in the field too long, however, pre-harvest field losses occur from storms lodging plants or grain falling on the ground. Also, growers are financially penalized for selling grain if moisture content is less than that of official market grain grades. Re-wetting by rain in some crops also can create storage and/or quality problems. Optimal field harvest conditions are governed by weather. This creates considerable pressure to complete harvest in a short time period before crop is lost in the field or spoilage occurs. For rice, that optimum period may be just 3 days.

Cultural practices affect harvest conditions. Stalk strength (small grains, corn) or seed placement on the plant (beans) differs with variety or hybrid. The date of planting and approximate days to plant maturity affect how quickly a crop will be ready to

harvest. Densely planted populations may promote stalk lodging. Row spacing determines corn head geometry. If weed management strategies have not been effective, large green weeds can overload and plug harvest equipment. Machine design has to cater for all these conditions.

Grain end-user requirements also influence harvesting equipment design and settings. Grain may be used for livestock feed, human food, fuel (e.g. ethanol production), seed, industrial, or other purposes. Grain damage occurs during threshing, separating, and handling. Unless grain is used immediately for livestock feed, most grain buyers want damage limited to a prescribed standard. Besides a general market standard, the buyer may require a lower damage level for particular uses. Grain may also need to be segregated or “identity-preserved” for some uses (e.g. seed, food, higher value industrial uses) and that demands a thorough clean-out of the combine before harvesting another crop.

#### **4. PERFORMANCE FACTORS**

Aside from cost, grain harvesting machinery is rated by the following five performance factors: throughput capacity, losses, grain quality, ease of operator use, and timeliness. Throughput is the time rate of plant material processed by the equipment, usually measured in either tons of grain or MOG per hour. Loss is the percentage of grain processed that exits the machine without being captured as harvested grain. As throughput increases to high levels, loss increases due to inefficiencies in collection or separation. The American Society of Agricultural and Biological Engineers (ASABE) defines combine capacity as throughput at a specific processor grain loss level (e.g. 1% corn loss, 3% rice loss; [ASABE, 2010](#)).

Grain damage may be defined by grain grading standards (such as amounts of foreign material and cracked or broken grain) or also include visible damage to the seed coat. Field efficiency, the percentage of time the combine is actually harvesting in the field, is used along with combine width and speed to determine acres per hour of field capacity. Operator performance is affected by machine comfort, controls, noise, visibility, ease of settings, etc. Finally, economic factors such as the cost of capital, repair/maintenance, and fuel costs are used to estimate total operating costs.

Functional components of a combine include the crop gathering system, conveyors, thresher, and separator (often integrated) to separate threshed grain from stems and stalks, cleaning shoe to remove small/light material, and storage bin to hold clean grain until it is unloaded onto a transport vehicle to be moved from the field. Material handling equipment (conveyors) is required to move crop material throughout the machine. Engine power is required for all these functions as well as significant amounts for the ground drive system, straw chopper, unloading auger, and cab air conditioner ([Kutzbach and Quick, 1999](#)).

## 5. HEADS: GRAIN PLATFORMS, CORN HEADS, AND STRIPPERS

Gathering head capacity determines overall combine throughput. Because threshing, separating, and cleaning mechanisms must operate at constant speeds, travel speed is adjusted by a variable speed drive matched to the crop intake capacity of the head while the engine throttle is fixed by requirements of the separator and shoe. The head must gather all grain into the combine and enough other plant material to cushion the grain during threshing.

Direct cutting grain platforms consist of a cutterbar, reel, and platform auger (Figure 6.1). The cutterbar has a series of knife sections oscillating back-and-forth through knife guards. Standard knife and guard sections are usually 3 in. wide, with each knife oscillating from directly under one guard to directly under an adjacent guard (i.e. knives are “in register”). If the cutterbar is not linearly adjusted so that the knife sections stop directly under guards, it is out of register and rough cutting of plant stems will occur. A variation is the Kwik-cut style of cutterbar using 1.5 in. knives and guards with a 3 in. stroke for double cutting.

Cutterbar height affects the amount of plant material entering the combine. Small grain cutterbars are fixed on the grain platform and the operator endeavors to cut the crop just under the plant heads. For soybean harvest with pods of beans close to the ground, a floating cutterbar is used with height control to sense ground position and flexibility to follow ground contours on wider heads. Forward travel speed can be limited by cutterbar speed as the cutterbar must oscillate more quickly to cut plant stems as the head moves forward at faster ground speeds.

The reel controls feeding of the upper part of plants into the grain platform. Bats on the reel push the top of plants over the cutterbar to aid cutting and sweep the material across the platform. For soybean or rice crops, pick-up fingers are often



Figure 6.1 Grain platform with cutterbar, reel, and platform auger.

added to the reel to help lift and pick up lodged crop. The center of the reel is slightly ahead of the cutterbar. If pick-up fingers are used, the reel should be positioned so that fingers clear the cutterbar by at least 1 in. for all conditions (also in the uppermost flexed position of flexible cutterbars).

Reel peripheral speed should be slightly faster than ground speed in good harvesting conditions. The dimensionless ratio of peripheral reel speed to ground speed is reel index. An average setting is about 1.25, but reel speed controllers should have the ability to vary reel index from about 1.1 to 2.0 with faster speeds being used to more aggressively gather lodged crop into the head.

The platform auger takes cut crop material away from the cutterbar and moves it into the feederhouse for feeding into the threshing area. Retractable fingers in the center alternately pull crop into the center and retract for release to the feeder. Ability to adjust auger position can help feeding. The auger should be low enough to efficiently move crop material without plugging. Too low a position, however, may damage grain pinched between the platform and steel auger flights. Moving the auger slightly forward may be beneficial in short crops to aggressively pull material away from the cutterbar area.

A windrow pick-up header using conveying belts may be used in crops that have been previously cut and windrowed for additional drying before threshing. Draper platforms (using rubberized belts to cross convey instead of an auger) are popular for small grains as they increase capacity by smoother heads-first feeding. Draper use is also more common on platforms exceeding about 40 ft in width to increase conveying capacity compared with an auger.

Stripper heads are sometimes used for rice and small grains. The stripper rotor has a set of combing teeth which literally comb grain heads from stems. The rotor is covered by a hood to prevent grain flying away from the head. A platform auger gathers material into the feederhouse to the threshing area. The advantage of the stripper head is that it greatly reduces MOG entering the combine. This allows greater throughput and forward speed.

A corn head has individual row units designed to strip the ear from the stalk and gather it into the machine (Figure 6.2). Six-, eight-, and twelve-row corn heads are common, but larger and smaller heads are also made. The head should be matched to row spacing (commonly 30 in.) to avoid machine losses during gathering. Cornstalks are pulled down by stalk rolls and the ears are snapped off as they strike stripper plates (also called deck or snapping plates) that shield the stalk rolls (Figure 6.3). Gathering chains on top of the stripper plates pull the snapped ears to the platform cross auger with the auger feeding ears into the feederhouse. Snouts of lightweight plastic or sheet metal divide crop rows and cover operating parts. Gear boxes under the platform drive individual snapping rolls and gathering chains.



**Figure 6.2** *Corn head.*



**Figure 6.3** *Gathering chains and stripper plates over stalk rolls (middle snout is raised).*

Several adjustments and options affect corn head operation. Stripper plates should be adjusted to cover enough of stalk rolls to avoid butt-shelling of kernels from ears but not so close as to pinch and break off upper portions of corn stalks. Stalk roll speed should be adjusted to travel speed so that ears are stripped about halfway up the stripper plates. Gathering chain speed should match ground speed to bring stalks uniformly into the head. The leading edges of the head, or snouts, should operate a few inches above the ground unless lodged corn requires them to float on the surface for dividing crop. Newer equipment offers in-cab controls for many of these manual adjustments and one manufacturer makes spring-loaded stripper plates that automatically compensate for stalk size on-the-go.

Options available with many heads include variable speed operation (to match crop gathering with travel speed), a head reverser to help dislodge or unplug crop, slip clutches, and other various safety and/or functional features. Automated steering helps to increase field efficiency when using wider heads, in dusty conditions, or to stay centered on the row. Row-crop heads to harvest individual plant rows similar to a corn head also have been used to harvest soybeans and grain sorghum. Because of the toughness and size of corn stalks, stalk shredders are sometimes used under the corn head. Shredding is done by separate rotary knife units or limited additional shredding may be done by knife-type stalk rolls. An after-market reel is occasionally mounted above the corn head in lodged crop conditions.

## 6. FEEDERHOUSE

The feederhouse or “feeder” (Figure 6.4) transports grain from the head to the threshing area. Large chains with cross slats fastened to them pull material along the bottom of the feederhouse housing into the threshing area. Chain position, tension, and speed should be adjusted to uniformly take material from the head. The height position of the front drum around which the feeder chains operate should be adjustable to accommodate different crop sizes (e.g. wheat versus corn) and crop volumes due to yield or the amount of plant material moved through the combine. Many combines have a rock trap in the feederhouse or close to the top end of the feederhouse.

## 7. CYLINDER OR ROTOR AND CONCAVE

Action in the threshing area both detaches (threshes) grain from other plant material by impact and rubbing, and separates the detached free grain from other crop material.



Figure 6.4 Feederhouse connecting head to combine threshing area.

Both major styles of threshing mechanism move crop between the surface of a rotating cylinder and an open-mesh concave. Cylinder threshing (Figure 6.5) was originally termed conventional threshing as it is used on all types of crops, and early forms of the design were used in the first stationary mechanical threshers. Crop is tangentially fed between the underside of a rotating cylinder and a crescent-shaped, open-mesh concave surface wrapped around the cylinder underside (Figure 6.6). Cylinder axis is perpendicular to crop flow. Grain is rapidly threshed near the entry point and partially separates from straw (i.e. other plant material) as it progresses along the concave path. In good conditions 70–90% of the grain may be separated at the concave. The rate of separation decreases near the rear sections of the concave as considerable amounts of free grain have already been separated. A rotating beater strips material flow above the rear of the concave to prevent back feeding of the cylinder. This material falls onto straw walkers

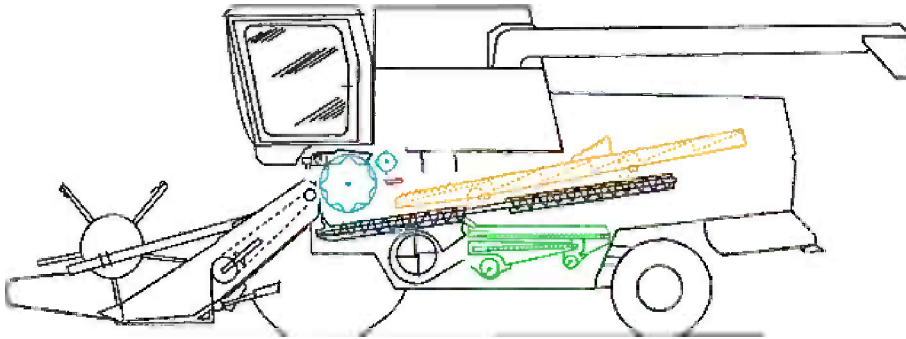


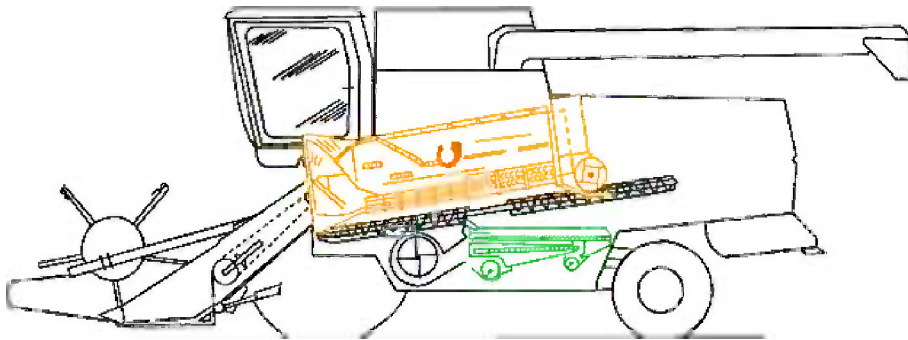
Figure 6.5 *Cylinder-type of combine threshing.*



Figure 6.6 *Rear of concave underneath cylinder (note clean grain augers underneath in foreground).*

for further separation. In some variants, multiple cylinders are used in place of straw walkers for separation and threshing of unthreshed heads.

Rotary threshing uses a larger diameter rotor surrounded by an open-mesh concave (Figures 6.7 and 6.8). Crop material travels in a spiral path (usually guided by fixed helical vanes in the concave) several times around the rotor during processing. Most rotor designs are axially fed with the rotor axis parallel to main crop flow. Transitioning crop flow from the feeder chain into the entry of the axial flow rotor is often aided by some means to re-direct flow path into the rotating spiral (e.g. guiding vanes, rotor extensions, or a beater). Variations are to use two rotors or to feed the single rotor tangentially with rotor axis perpendicular to crop flow path at the rotor entry point. Centrifugal action during a longer flow path is used to separate grain after



**Figure 6.7** Rotary-type of combine threshing.



**Figure 6.8** Concave around rotor with clean grain augers underneath.



threshing. The front section of the rotor is used for threshing, whereas the middle and rear sections perform centrifugal separation.

On the cylinder surface or on the front threshing section of the rotor, a series of rasp bars are mounted to strike and feed the crop material. In tougher, greener stem harvest conditions, spiked tooth rasp bars (or specialty rotor sections) are commonly used, for example in rice, to move material through the threshing area between rotor/cylinder and concave. Threshing occurs by impact of grain at high speed with metal surfaces and by rubbing of grain against other grain and crop material. Grain damaged is reduced when this “grain-on-grain” or other crop material threshing occurs rather than grain being struck by metal.

Major factors affecting grain damage are rotor or cylinder speed and concave clearance settings. Appropriate peripheral thresher tip speed varies for different crops and field conditions. Typical peripheral speeds are 50 ft/s for corn or soybeans and 100 ft/s for small grains such as wheat and oats. A general recommendation is to increase cylinder or rotor speed to just below the point where grain quality is adversely affected. Concave clearance should be narrowed to just the point where threshing is satisfactory without adversely impacting grain damage. Although threshing increases with increased rotor/cylinder speed and decreased concave clearance, grain damage greatly increases in order to thresh the most resistant grain heads. Grain damage increases with the square of rotor/cylinder speed. To quickly adjust speeds a variable speed drive (e.g. belt or hydrostatic transmission) is used.

Rotary type threshing mechanisms have been widely adopted since the 1980s on corn, soybean, and rice, crops that are susceptible to grain damage and may be less affected across a somewhat wider range of rotor speeds (Newberry *et al.*, 1980; Paulsen and Nave, 1980). Lower centrifugal force can be used with a larger diameter rotor and longer concave. Cylinder-type threshers have been more frequently used over a wide range of crops and conditions (e.g. small grains with damp, long straw). Cylinder width is limited by road travel requirements of the combine chassis to about 5.5 ft. Both types of threshing mechanisms have advantages and limitations depending on the harvest situation. Threshing performance criteria include throughput, separation, grain damage, threshing loss and straw break-up.

## **8. SEPARATION: STRAW WALKERS OR ROTARY SEPARATION**

Although much of the grain has been separated from other crop material in the threshing zone, MOG leaving the threshing area still must be processed to remove further grain in order to reach the performance criteria expected by the customer (e.g. 1% or 3% processor grain loss). There are two separation processes commonly used: gravity-dependent straw walkers or rotary separation.

Straw walkers (Figure 6.9) are sieve sections that oscillate in two planes (up and down, forward and back) to literally shake remaining grain from the mat of MOG. Each section may be about 10–14 in. wide and 25–45 in. long with a rake of teeth projecting above each side to help keep larger straw above the mesh sieve. MOG enters the straw walkers from the beater stripping the threshing cylinder. MOG then passes over four to eight oscillating perforated sections over a distance of up to 16 or 18 ft before exiting the rear of the combine. The number of sections across the width of the straw walkers or along the length of the straw walkers is limited by the chassis size of the combine, which in turn is limited by road transport width and length.

Grain is separated from MOG in the straw walkers by gravity as the individual shakers oscillate on crankshafts at about 200 rpm with a throw of 2–3 in. Larger straw, stems, and other material “walk” toward the rear exit of the combine, whereas heavier grain falls through the sieves. This grain is routed to the cleaning shoe by augers or a stationary, sloped grain pan underneath the straw walkers.

Rotary separation is commonly used in conjunction with rotary threshing and accomplished in the mid- and rear sections of the rotor or rotor pair as MOG continues to spiral between rotor and concave. Rotary action results in centrifugal separation as heavier grain flies through the concave. Forces can be 50–100 g or more, orders of magnitude higher than for straw walkers. Rotary separators use helical transport vanes fixed to the concave to guide MOG in spiral movement. Directed flow by the vanes helps to avoid plugging and adjustable vanes may be used to increase or decrease the number of spirals or amount of time MOG spends traveling around the rotor.

Rotary separators require more power than straw walkers as they grind away or chew on the straw, but grain damage may be acceptable over a wider range of speeds

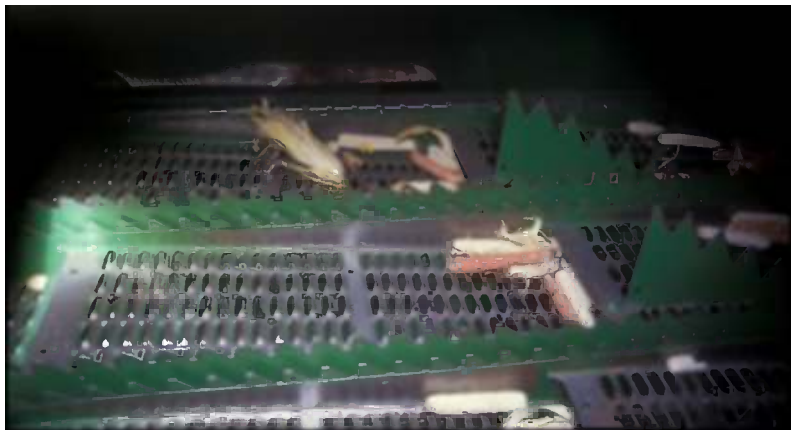


Figure 6.9 *Straw walkers.*

and separation forces are greater. The greater propensity for straw breakage in rotary separators is usually not a problem in corn, soybeans, or rice, but for this reason a rotary separator may not be as versatile in some other small grain conditions with drier straw (e.g. wheat, oats, barley) when excessive straw break-up can overload the cleaning shoe. Compared with straw walkers, rotary separators have high separation capacity within a smaller machine chassis, reduced moving parts and drives, lower vibration, and lower combine weight. The high moment of inertia of a large rotor can help if crop flow becomes non-uniform with “slugs”, but if a rotor becomes plugged with crop material it can be more tedious to unplug and clean than straw walkers unless a powered rotor reversing system is incorporated.

## 9. CLEANING SHOE

Grain from the threshing or separating areas still contains smaller pieces of broken straw, chaff, weed seeds, and dirt. To further clean grain by separating it from these smaller pieces of foreign material it is processed by the cleaning shoe. The cleaning shoe consists of a grain pan or bed of clean grain augers, fan, two or three oscillating screens or sieves (Figure 6.10), and a tailings return system. Grain is conveyed (either by a bed of augers or shaking conveyor) by the grain pan under the thresher into an air stream generated by the fan and onto the top sieve (chaffer).

Grain is separated from chaff and other materials by a combination of pneumatic and mechanical forces. Cleaning makes use of the greater density and terminal velocity of grain than chaffy materials. Air flow from the fan should be greatest near the front of the chaffer screen and reduce as it reaches the rear of the sieves. Air flow is directed by a wind board. Newer cleaning shoes have split air streams so that an initial



Figure 6.10 *Top sieve (chaffer) in cleaning shoe as viewed from rear of combine.*

higher velocity air stream is channeled in a pre-winnowing process to the front of the chaffer to help fluidize the mat of grain entering the sieves.

Air flow is critical and should be increased as crop flow increases to fluidize the crop mat allowing grain to work its way downward through the mat to the sieve openings. Air flow that is too high allows grain to be blown out over the rear of the shoe. Air speed that is too low does not allow chaff to separate but keeps it embedded with grain in bulk flow of the crop mat.

Heavier grain falls through the top chaffer sieve and lower sieve to a clean grain cross auger at the bottom of the combine. Heavy particles that have not been blown out the rear of the shoe but that fall through an extended sieve at the rear end of the chaffer, drop into the tailings return cross auger for re-threshing. Tailings material should be primarily unthreshed grain with minimal whole grain present otherwise threshed grain is subjected to additional damage.

Proper setting adjustments for the cleaning shoe involve fan air flow and direction as well as adjustments in sieve openings. Setting air flow is key and should normally be the first adjustment. Reduce air speed from a relatively high level to the point at which grain is not blown out the rear of the shoe. Next reduce the opening of the chaffer sieve until further closing would cause excessive grain in the tailings return. Finally set the lower sieve opening in the same manner as the chaffer sieve. Air velocity at the fan may be 20–25 ft/s. Air flow is more effective for separation with increasing vertical angle, although machine envelope limitations limit this angle. Air flow should be uniform across the width of the shoe. Sieve openings are adjustable either manually from the rear or by automatic control. Sieve opening is measured between the faces of adjacent vanes or louvers. Openings of both sieves should be related to grain size with the chaffer having a slightly larger opening.

Typical values for sieve oscillations are 4–6 Hz with an amplitude of 0.75–1.5 in. The fluidized crop mat should evenly diffuse grain and chaff. As the mat is subjected to upward air flow and oscillating sieves, heavier grain moves to the sieve openings in a convection-like process. A separation theory in the cleaning shoe by diffusion and convection has been developed ([Kutzbach and Quick, 1999](#)).

When the combine is operated on sideslopes, the crop mat tends to gravitate to and overload the lower side. Separation ability is reduced as thickness of the crop mat affects air flow and the distance grain must fall to sieve openings. In thin mats, excess air flow can blow grain out the rear of the shoe before it drops through the sieves. In thick mats, air flow is reduced and the crop mat ceases to be fluid but instead becomes bulk flow over the top chaffer sieve with little separation and a resulting overload on the tailings return system. Combine leveling systems on hillside combines, self-leveling cleaning shoes, and dividers can be used on sloping ground to correct this problem.

## 10. ELEVATORS: CLEAN GRAIN AND TAILINGS

From the cleaning shoe area, clean grain is transported horizontally by auger to one side of the combine chassis and then up to a clean grain storage tank (Figure 6.11) at the top of the combine by an elevator chain with paddle attachments. Grain falling into the tailings return system at the rear of the cleaning shoe is delivered back to the front of the thresher for re-threshing usually by horizontal auger to one side of the combine then back to the threshing area.

## 11. GRAIN BIN AND UNLOADING AUGER

Ever increasing crop yields have resulted in larger clean grain tanks (i.e. the mobile storage bin) on combines. Grain tanks hold at least 150 bushels, but may hold over 400 bushels (Figure 6.12) depending on the combine class. Panels (extensions or hungry boards) attached to the top edges of the grain tank are often used to increase grain tank capacity and the distance the combine may be driven before unloading. Some extensions are designed to be folded down to prevent rain wetting the grain or when not in use. A loaded grain tank adds considerable weight to the combine, almost all of which is carried over the powered front axle. This impacts structural and drive requirements and size of the undercarriage as well as size of tires and wheels. Tires are overloaded and for that reason a combine should never be operated in road gear speed with a full grain tank. Wide, floatation-type tires or dual tires “straddling” rows or even rubber tracks may be used to avoid excessive soil compaction in wet conditions and field damage that adversely affects subsequent crops.

A high-capacity unloading auger (Figure 6.13) is required to quickly empty the grain tank. If field conditions allow unloading “on-the-go” into an accompanying



Figure 6.11 Clean grain tank.

truck or grain cart traveling alongside, field efficiency is greatly enhanced. As combine threshing and separation capacity has increased, wider gathering heads are needed to keep the combine fully loaded. To allow clearance for grain transport vehicles alongside combines, the auger must reach somewhat beyond the edge of the head when extended for unloading. Unloading auger lengths now commonly exceed 20 ft. For safety and road transport the auger must pivot to fold alongside the combine when not unloading.



**Figure 6.12** *Large capacity grain tank with extensions on upper perimeter.*



**Figure 6.13** *Unloading auger extending and moving grain to transport cart.*



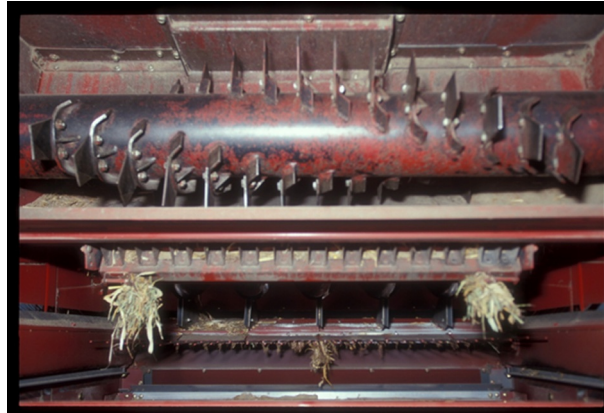
**Figure 6.14** *Rotary stalk spreaders on rear of combine. (Courtesy of CaselH)*

## 12. OTHER ATTACHMENTS

Several attachment options are commonly used in different crop situations. For wider heads and heavier crop material (e.g. cornstalks), a stalk spreader (Figure 6.14) with rotating vanes or fingers is used to more evenly spread MOG across the soil surface. If straw will not be picked up or baled, but instead is to decompose on the surface, a straw chopper (Figure 6.15) with rotating knives at the rear of the combine shreds and sizes stems. A lodged crop with downed stems in the field is more difficult to get underneath with the grain platform cutterbar. In such cases sloping extensions called crop lifters may be periodically mounted along the cutterbar to help lift stems. A pneumatic device known as an air reel uses directed air near the front of the grain platform to blow small grain material onto the platform. Wet field conditions, particularly common with rice harvest, reduce tractive ability of combine drive wheels. Specialized “rice” tires may improve traction in wet, plastic soil conditions. To add to floatation and traction in muddier soil, tracks are an option.

## 13. OPERATOR’S STATION, ADJUSTMENTS, AND MONITORING SYSTEMS

Numerous control and monitoring systems are used nowadays to facilitate a safe efficient grain harvest and to maintain grain quality. Electronic systems control hydraulic or mechanically actuated adjustments. A microprocessor within the system can be used to both control settings and direct information to archival storage. In some cases archived information may be used to store successful machine settings so that they may be used later in an operator or even machine learning process. Touch-screens



**Figure 6.15** *Rotary straw chopper in rear of combine.*

used in some combines can be customized to display a subset of 40 or more operating parameters so that they can be conveniently monitored and adjusted.

Adjustments of head functions are often combined into a single operator joystick. Cutterbar height may be controlled by mechanical or ultrasonic sensors below the cutterbar. Automated or “hands-free” steering for wide grain platforms or to stay centered on corn rows reduces operator fatigue, allows faster overall speed, and reduces overlapping. Grain loss sensors at the rear of the cleaning shoe convert grain impact on sensor pads to electrical signals showing relative grain loss. Audible or visual warnings may be set to accommodate operation within a defined range for critical sensors.

Grain yield is commonly sensed electronically near the top of the clean grain elevator by the force of grain striking an impact plate. A speed sensor and a head width sensor can be used to calculate area harvested. Global Positioning System (GPS) equipment can record field position and also sense speed. Data storage can hold information on grain yield, moisture content, and field position to create yield maps useful to the grower for crop management decisions.

## **14. FIELD PERFORMANCE**

Desirable performance of grain harvesting equipment is usually evaluated in terms of least machine losses, lower grain damage, maximizing crop throughput, and optimal economy. Unfortunately, these are conflicting goals. Optimal machine performance involves trading off acceptable machine grain loss levels in the adjustment of threshing and separating equipment while maintaining grain quality for customer specifications. For specific crop conditions there is often a “sweet spot” of combine throughput, with enough crop material being processed by the combine so that crop-on-crop



threshing minimizes grain damage, but not so much material that separation efficiency is sacrificed and crop is lost (Quick and Hanna, 2004).

Theoretical combine rate of work or field capacity (acres/h) can be estimated by harvested head width and combine travel speed, but actual field capacity is often 60–70% of this because of time spent unloading, turning on ends, operator delays, etc. A narrow time window for optimal harvest puts a premium on high combine field capacity and machine reliability. High combine field capacities with large combines may be limited not by the combine but by the transport capacity of trucks and wagons available to remove grain from the field. For corn, artificial drying capacity if the crop is harvested at a moisture content much higher than needed for storage may limit harvesting rate.

## 15. GRAIN DAMAGE

In the industrialized world, grain damage is most frequently assessed against government market or trade (e.g. popcorn) standards. There are specific end-uses and end-use customers (e.g. food processors) who have other requirements. Within bulk commodity market channels, regulated by government standards, the presence of both larger stems and unthreshed grain, and smaller material at levels above standards dock grain grade and quality. Grain protein levels are another criterion for quality. Extremely small material that is not easily identified (broken grain pieces, dirt, weed seed) is lumped into a category of foreign material. Besides large residue and foreign material, for some grain varieties smaller pieces of identifiable broken or misshapen grain comprise one or more other categories (e.g. split soybean seeds).

Government commodity grain standards assess damage by segregating different sizes of particles with sieves or laboratory cleaning machines. Damage to the seed coat or invisible internal grain damage is more difficult to quickly assess, but is particularly important to some customers (e.g. the seed industry and food-grade processors). Significant machine grain damage and loss also occurs when extremely small particles of ground up grain dust are blown from the rear of the combine. Such loss is invisible to standard measuring techniques. It may be approximated, however, by comparing hand-harvested yield to machine yield plus visible machine losses.

## 16. COMBINE TRENDS

Modern combines continue to increase in size and power. Class 9 combines are now marketed with engines approaching 600 HP to meet harvest timeliness demands, custom contractor requirements, and increasing farm sizes.

## REFERENCES

- ASABE, 2010. Terminology for combines and grain harvesting (S343.3). ASABE Standards. American Society of Agricultural and Biological Engineers, St. Joseph, MI.
- Kutzbach, H.D., Quick, G.R., 1999. Harvesters and threshers – grain, CIGR Handbook of Agricultural Engineering, vol. 3. American Society of Agricultural and Biological Engineers, St. Joseph, MI.
- Newberry, R.S., Paulsen, M.R., Nave, W.R., 1980. Soybean quality with rotary and conventional threshing. *Trans. ASAE* 23, 303–308.
- Paulsen, M.R., Nave, W.R., 1980. Corn damage from conventional and rotary combines. *Trans. ASAE* 23, 1110–1116.
- Quick, G.R., Hanna, H.M., 2004. Correlating combine harvested yield with grain damage and losses. International Quality Grains Conference Proceedings. July 19–22, 2004, Indianapolis, IN, Purdue Extension Service CD-GQ1.

This page intentionally left blank

# Grain Storage Systems Design

Ray Bucklin\*, Sid Thompson\*\*, Michael Montross<sup>†</sup> and Ali Abdel-Hadi<sup>‡</sup>

\*University of Florida, FL, USA

\*\*University of Georgia, GA, USA

<sup>†</sup>University of Kentucky, KY, USA

<sup>‡</sup>Tuskegee University, AL, USA

As agriculture developed in the Middle East and other places, farmers learned to produce crops in quantities larger than the amounts needed for their immediate use and the need for storage and handling methods arose. Grains and oil seeds provide large quantities of carbohydrates and significant amounts of oils for human consumption and use. Some grains can be consumed shortly after harvest and require little processing beyond separation of the grain from other plant material. However, as agriculture grew in scale, the need for methods to store and transport large quantities of grain developed. Today, the grain consumed in industrialized countries is produced by only a small fraction of the overall population by highly mechanized farming operations.

Agricultural grains including the cereal grains such as wheat, corn, and rice, and oil seeds such as soybeans and canola are alive and interact with their immediate environment. They must be stored, transported, and conveyed using methods that preserve their quality as seeds, food stuffs, or raw materials. Storage can be for varying lengths of time ranging from short-term storage on farm for drying, to waiting some period after drying for advantageous market conditions, to long-term storage for strategic reserves. Storage can occur on farm or at large commercial facilities.

On-farm storage is usually on a smaller scale than at commercial facilities. Grain on farm is typically stored in cylindrical metal bins. Most of these bins are fabricated from curved corrugated sheets that are bolted together. The size of on-farm bins grew over the last part of the twentieth century, and today some on-farm bins are over 100 ft in diameter and some also exceed 100 ft in height, overlapping with the sizes of bins seen on commercial operations. Flat storage of grain in warehouses is also often seen on farms for temporary storage.

Commercial bins are typically much larger than bins used on farms. They are used at central drying facilities located in grain producing areas, at mills and other processing facilities, and at grain handling terminals located at railroad centers and ports. The larger bins used commercially are usually reinforced concrete cylinders. Some use of flat storage is also seen, particularly at ports for short-term storage.

## 1. MATERIALS

Agricultural grains are free flowing bulk materials, and cohesion between grains is usually not taken into account in structural designs. Grains can develop cohesion when improperly stored or handled, particularly under high moisture conditions when mold develops. A properly designed and operated grain handling system will maintain grain in a free flowing state, and grain bins and hoppers are usually not designed to handle cohesive materials. Bulk materials are semi-fluids that share characteristics with both solids and liquids. Bulk materials conform to the shapes of containers and display flow behavior in manners similar to fluids, but they also resist shear deformation in a manner similar to solids. When sizes of grain harvests grew in response to the mechanization of agriculture in the second half of the nineteenth century, large grain bins were constructed based on designs that treated grains as fluids (Ketchum, 1907). Structural failures of several of the first large grain bins led Janssen (Janssen, 1895) to develop a satisfactory method of analyzing pressures in large grain bins.

Corn, wheat and soybeans are the major grain and oilseed crops grown and stored in the United States. Significant quantities of rice, oats, barley, rye, sorghum, millet, sunflower and canola are also grown and stored in bins. Wheat is generally considered to impose the largest structural loads on bins and since it is impossible to predict what crops will be stored in a bin over its lifetime, it is recommended that bins be designed for the structural loads imposed by wheat (ASAE, 2012a).

### 1.1 Physical Properties of Agricultural Grains

The physical properties needed to predict grain pressures, packing behavior, and flow behavior include the bulk density of the grain ( $W$ ), the ratio of lateral to vertical pressure ( $k$ ), the internal angle of friction ( $\varphi$ ), and the coefficient of friction of grain on the bin wall ( $\mu$ ). Agricultural grains are handled and stored as bulk materials and the analysis of their behavior overlaps many aspects of soil mechanics which also treats soil as a bulk material. The major differences between the two materials are produced by the much smaller particle size of soils and the cohesion produced by interaction of small soil particles with moisture. Agricultural grains are larger than soil particles and are stored and handled at low moisture contents.

Janssen's equation (Janssen, 1895) is a model of the actual behavior of bulk materials. Janssen's equation is based on analysis of simplified slices of bulk material and assumes that all material properties are constants. In reality, bulk density varies with depth and the coefficient of wall friction ( $\mu$ ) and the ratio of horizontal to vertical pressures ( $k$ ) vary throughout a bin. The values of  $k$  and  $\mu$  used in Janssen's equation are based on both measured values and on experience. The values given in EP433 (ASAE, 2012a) were selected to produce conservative designs for bins that could be used to store a variety of grains.

The coefficient of friction is measured by a wide variety of devices that measure the ratio between normal force and the horizontal force required to produce movement of a wall sample through or over a sample of grain. As noted above, the coefficient of friction is typically taken as a constant for design, but it varies to some extent with normal pressure and velocity (Bucklin *et al.*, 1989; Thompson and Ross, 1983; Thompson *et al.*, 1988). The coefficient of friction of grain on corrugated wall material varies between values approaching grain on grain for low normal pressures to values approaching grain on metal for high normal pressures (Molenda *et al.*, 2002). At certain combinations of friction coefficient, normal pressure, and velocity, grain exhibits stick-slip behavior and bins sometimes produce noises referred to as singing or honking (Bucklin *et al.*, 1996).

The ratio of horizontal to vertical pressures varies most of the parameters assumed to be constants in Janssen's equation. The  $k$  value varies across a bin cross-section and with depth. In addition, under flow conditions, the directions of the principal axes can vary. The  $k$  value is sometimes estimated from the angle of internal friction based on methods from soil mechanics. The angle of internal friction can be measured using the same methods as used by soil mechanics but caution should be used to make sure that testing devices are large enough to contain sufficient particle numbers to eliminate edge effects. Because of difficulties obtaining appropriate test devices to measure the angle of internal friction, the angle of repose is often used as an estimate of the angle of internal friction of free flowing grains. The angle of repose is a valid estimate of the angle of internal friction of bulk materials if cohesion can be neglected and the particles are all in the same size range as is the case with free flowing grains.

The bulk density of bulk materials increases as normal pressure increases. The Winchester Bushel Test (USDA, 1977) is the standard method used to determine uncompacted bulk density. The test consists of using a device to drop a known volume of material from a fixed height and measuring the mass of the volume. These values are used for inputs to Janssen's equation and also as the basis for calculations of bin capacity based on the amount of packing in bins (ASAE, 2012e). Grain volume is often expressed in bushels. A bushel is a volume of grain equal to 1.25 ft<sup>3</sup>. Physical properties of many agricultural grains can be found in ASAE, 2012f; Boac *et al.*, 2010; CEMA, 2009, Horabik and Weiner, 1998; Mohsenin, 1986; Moya *et al.*, 2002; and Moya *et al.*, 2006.

## 1.2 Management Factors

Storage and handling facilities for agricultural grains are designed based on the assumption that grain will be free flowing. Agricultural grains are free flowing if they have been dried to safe storage moisture contents. The proper operation of harvesting, cleaning, and drying processes is essential to maintaining grain in a free flowing

condition. Once grain is dried to the desired storage moisture content and is placed in long-term storage, grain moisture content must continue to be managed. Unavoidable thermal gradients within the grain mass will, over time, produce moisture concentrations that provide suitable conditions for the growth of molds, insects, and other decay organisms. Because of this phenomenon, grain in storage must be periodically moved or aerated to reestablish proper storage conditions.

Particle attrition causes all bulk materials to generate dust as they are handled. The dust produced by agricultural grains consists of starch particles that when suspended in air under low humidity conditions are explosive. Wheat, corn, and soybean dust are dangerously explosive under dry conditions. Proper wiring to avoid sparks and, in some cases, the use of brass tools to avoid sparks are important factors in the design of grain storage facilities.

### 1.3 Codes

The loads imposed by grains on agricultural bins can be estimated using the methods outlined by ASAE EP433, Loads exerted by free-flowing grain on bins (ASAE, 2012a). The provisions of EP433 are most applicable to bolted steel bins, but can be applied to concrete bins. Design of bolted steel bins is based on the AISI Cold-Formed Steel Design Manual (AISI, 2008) and AISC Steel Construction Manual (AISC, 2011) as appropriate. The larger concrete bins typical of commercial facilities are often designed based on ACI 313, ACI313-97/313R-97: Standard Practice for Design and Construction of Concrete Silos and Stacking Tubes for Storing Granular Materials (ACI, 1997; Safarian and Harris, 1985).

Grain bins are large structures and often must comply with the provisions of the International Building Code (ICC, 2009) and local zoning ordinances. Commercial grain bins designed for the international market are designed for international codes such as the German Code, DIN 1055, Design loads for buildings—loads in silos (DIN, 1987), the European Code, ENV1991-4 Basis of Design and Actions on Structures. Part 4: Actions in Silo and Tanks (ECCS, 1996), or the Australian Code, AS 3774 (Standards Australia, 1996).

## 2. DRYING

### 2.1 Purpose of Drying

Grain is often harvested at a moisture content that is too high for safe storage. Drying is the most common post-harvest process performed for the long-term preservation of grain (Boumans, 1985; Brooker *et al.*, 1992; Loewer *et al.*, 1994; MWPS, 1988; Ross *et al.*, 1973). Microflora and insects typically will not grow at equilibrium relative humidities below 65% (Christensen and Kaufmann, 1974), so high moisture content

**Table 7.1** Equilibrium Moisture Content (% wet basis) of Various Grains  
**Equilibrium Relative Humidity (%)**

Grain	Equilibrium Relative Humidity (%)		
	60	65	70
Corn, shelled	12.4	13.2	14.0
Soybeans	10.5	11.5	12.5
Rough rice	12.0	12.6	13.2
Wheat, hard	12.9	13.6	14.4
Wheat, soft	11.8	12.3	13.0

(adapted from [ASAE \(2012b\)](#) based on a temperature of 77°F).

grain is artificially dried to a moisture content that will result in an equilibrium relative humidity within the stored grain mass lower than 65% ([Navarro and Noyes, 2002](#)). Although the exact equilibrium relative humidity required for safe storage is a function of grain temperature, kernel damage, risk level of the stored grain manager, and numerous other factors. [Table 7.1](#) summarizes the equilibrium moisture content at three levels of equilibrium relative humidity and a temperature of 25°C. Shelled corn in sound condition should be dried to a moisture content below 14% for safe storage. Soybeans require a storage moisture content less than 12.5% for safe storage.

## 2.2 Classification of Dryer Types

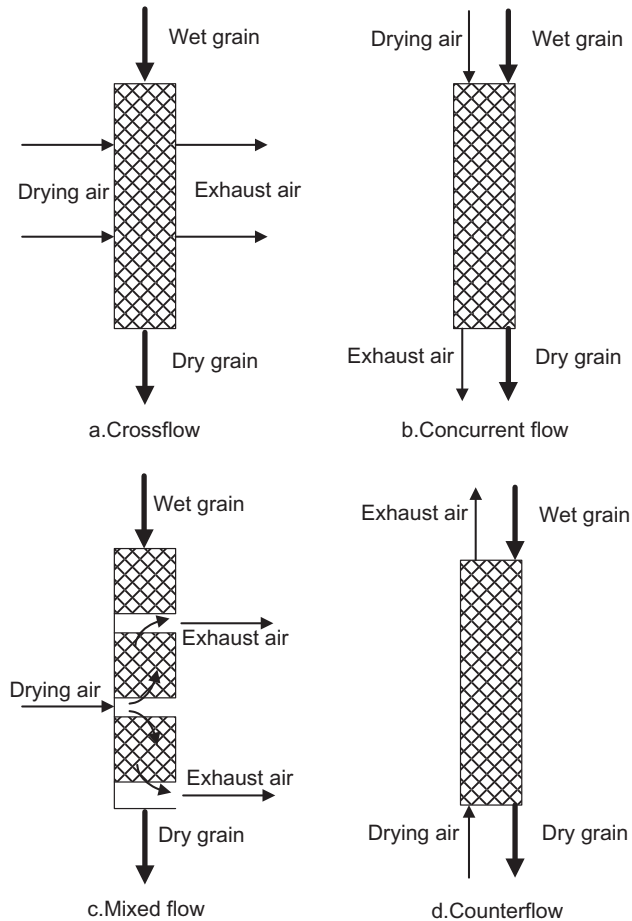
Grain dryers can be subdivided into numerous categories ([Brooker et al., 1992](#)):

1. On-farm or off-farm.
2. High temperature or low temperature.
3. Continuous flow or batch.

Most off-farm dryers are high capacity (between 700 and 5,000 bu/h when drying corn from 25% to 15% moisture content), continuous flow systems that utilize high drying air temperatures between 140°F and 220°F and high airflow rates (between 50 and 100 ft<sup>3</sup>/min per bushel). They are further categorized based on the grain flow and air flow patterns through the dryer ([Figure 7.1](#)). Most high temperature, high capacity grain drying systems in the USA are based on the crossflow design ([Figure 7.1a](#)), although mixed flow dryers are more common outside of the USA ([Figure 7.1c](#)). Typically the grain is cooled at high rates within the dryer prior to transfer to storage.

Grain quality is significantly affected by the drying process and type of dryer. Two of the most significant variables that have a deleterious effect on grain quality are maximum kernel temperature and drying rate. For example, the head yield from rough rice is significantly affected by the drying rate and kernel temperature. However, corn and wheat are less sensitive to high kernel temperatures and the maximum temperature allowed is a function of end-use. Maximum kernel temperatures





**Figure 7.1** *Types of continuous flow grain dryers.*

occur with crossflow dryers because of the extended exposure of the kernels on the hot, dry air inlet side of the dryer. Very little drying occurs where the air is exhausted from the dryer. Concurrent flow dryers are not very common. However, they result in excellent grain quality as the hot, dry air is introduced with the cold, wet grain. A high rate of evaporative cooling occurs near the air and grain inlet that minimizes the kernel temperature. Mixed flow dryers result in kernel temperatures, and hence grain quality, between crossflow and concurrent flow dryer designs.

High temperature, continuous flow dryers are also common on US farms, although with lower drying capacities than typically found at commercial facilities. On-farm high temperature dryers sometimes utilize delayed cooling systems (dryeration) where the grain is dried to within a couple of percentage points of the final desired moisture content, tempered, and cooled within storage or

tempering bins. This results in higher dryer capacity and higher quality grain (McKenzie *et al.*, 1967).

In-bin drying systems with ambient or heated air (temperature rise between 5°F and 50°F) are often found on farm. There are numerous strategies and types of processes that can be accomplished with in-bin drying. Simple natural air drying systems employ fans with airflow rates between 0.5 and 3.0 ft<sup>3</sup>/min per bushel and result in the highest grain quality, lowest specific energy consumption, and lowest drying capacities. In-bin stirrers can be used to increase moisture content uniformity, drying temperature, and drying rate. Some in-bin dryers continually move the corn from the bottom of the bin simulating the performance of a counterflow dryer.

### 2.3 Theory and Simulation of Drying

Various numerical models have been developed to simulate the drying process (Brooker, *et al.*, 1992; Liu *et al.*, 1997; Marks *et al.*, 1993; Mittal and Otten, 1980; Moreira and Bakker-Arkema, 1990; Morey *et al.*, 1979; and Thompson *et al.*, 1969). Broadly speaking, two types of models are commonly applied: heat and mass balances or systems of differential equations. Heat and mass balance models are typically used to simulate deep bed grain drying systems. They are most appropriate with systems with low drying air temperatures and low airflow rates that result in slow drying rates. Systems of differential equations are used when the air and grain temperature are not at equilibrium and are typically used to simulate dryers with high drying air temperatures and high airflow rates.

Deep-bed grain drying models are based on heat and mass balances developed over thin layers of grain. Equilibrium conditions are assumed to exist between the grain and the drying air over discrete periods of time and thin layers of grain. Time steps between 1 and 24 hours have been assumed and equilibrium moisture content models are used to predict drying or rewetting. The assumptions and methods only work under conditions of low temperature, low airflow in-bin drying. Numerous modifications and models have been developed to improve the accuracy of heat and mass balance models.

Differential equation models of drying are most appropriate with predicting the performance of high capacity, high temperature dryers. The assumptions of equal grain and air temperatures are not appropriate with high temperature dryers. Numerous assumptions were made in the development of the differential equation drying models:

1. Volume shrinkage during drying is negligible.
2. Temperature gradients within individual kernels are negligible.
3. Kernel to kernel conduction is negligible.
4. Air and grainflow are plug type and uniform.

5. Air temperature and air humidity ratio changes with respect to time are negligible relative to the air temperature and air humidity ratio changes with respect to position within the grain bed.
6. Bin walls are adiabatic with no heat capacity.
7. Heat capacities of air and grain are constant during short time periods.
8. Thin layer drying equations and moisture equilibrium content equations are accurate.
9. Moisture evaporation takes place at the drying air temperature.

Energy and mass balances are written on a differential volume of grain. The resulting equations for a fixed bed and batch column dryer are given in [equations 7.1–7.4](#):

$$\frac{\partial T}{\partial x} = \frac{-ha}{G_a c_a + G_a c_v W} (T - \Theta) \quad [7.1]$$

$$\frac{\partial \Theta}{\partial t} = \frac{-ha}{\rho_p c_p + \rho_p c_w M} (T - \Theta) + \frac{h_{fg} + c_v (T - \Theta)}{\rho_p c_p + \rho_p c_w M} G_a \frac{\partial W}{\partial x} \quad [7.2]$$

$$\frac{\partial W}{\partial x} = - \frac{\rho_p}{G_a} \frac{\partial M}{\partial t} \quad [7.3]$$

$$\frac{\partial M}{\partial t} = \text{thin layer drying equation} \quad [7.4]$$

where:

a = particle surface area per unit bed volume (ft<sup>2</sup>/ft<sup>-3</sup>)

c = specific heat (Btu lb<sup>-1</sup> °F<sup>-1</sup>)

h = convective heat transfer coefficient (Btu ft<sup>-2</sup> °F<sup>-1</sup> h<sup>-1</sup>)

h<sub>fg</sub> = heat of evaporation (Btu lb<sup>-1</sup>)

x = bed coordinate (ft)

y = bed coordinate (ft)

G = flow rate (lb dry mass hr<sup>-1</sup> ft<sup>-2</sup>)

M = moisture content (decimal dry basis)

T = air temperature (°F)

W = humidity ratio (lb/lb)

θ = product temperature (°F)

with subscripts

a = air

p = product

v = water vapor

w = water (within grain).

A continuous-flow column dryer is similar to a fixed bed dryer. If no shrinkage occurs during drying, time and position along the height of the grain column ( $y$ -axis) are equivalent. Therefore, the equations for a crossflow dryer are:

$$\frac{\partial T}{\partial x} = \frac{-ha}{G_a c_a + G_a c_v W} (T - \Theta) \quad [7.5]$$

$$\frac{\partial \Theta}{\partial y} = \frac{-ha}{G_p c_p + G_p c_w M} (T - \Theta) + \frac{h_{fg} + c_v (T - \Theta)}{G_p c_p + G_p c_w M} G_a \frac{\partial W}{\partial x} \quad [7.6]$$

$$\frac{\partial W}{\partial x} = -\frac{G_p}{G_a} \frac{\partial M}{\partial y} \quad [7.7]$$

$$\frac{\partial M}{\partial t} = \text{thin layer drying equation} \quad [7.8]$$

Mixed flow, concurrent flow, and counterflow models are not as common, but are available in the literature. Thermal properties can be found in [Brooker \*et al.\* \(1992\)](#) or the ASAE D243 Thermal Properties of Grain and Grain Products ([ASAE, 2012c](#)).

Differential equation-based models of drying require expressions for the thin layer drying of the grain. A thin layer of grain is a layer of grain no more than a few grains thick. The ratio of the mass of drying air to the mass of the grain is high enough that there is only a small change in temperature and relative humidity of the air as it exits the grain. Thin layer drying processes are broken up into constant rate drying periods and falling rate drying periods. The drying rate is constant when free moisture is present on the grain surface. It is generally assumed that during falling rate periods, moisture within a grain moves by diffusion and is analogous to heat transfer in a solid. However, there is disagreement about whether moisture movement is by liquid diffusion, by vapor diffusion, or by a combination of both. Most materials exhibit more than one falling rate period, but practical grain drying is generally assumed to occur in the first falling rate period. If the surface resistance to moisture transfer is small compared with resistance within the material, Fick's laws of diffusion govern moisture movement within a grain kernel. Fick's second law of diffusion states that:

$$\partial M / \partial t = D \nabla^2 M \quad [7.9]$$

where:

M = Moisture Content, dry basis

D = Hygroscopic diffusivity,  $\text{ft}^2/\text{s}$

t = time, s.

Newman (1931) and others solved these equations for various conditions. Newman's solutions take the form of rapidly converging infinite series. The series converge rapidly and after a period of time can be represented by the first term or:

$$M_R = Ae^{-kt} \quad [7.10]$$

where:

$M_R = (M - M_E)/(M_I - M_E)$  = Moisture ratio

A = Dimensionless shape factor

t = Time, s

k = Drying constant,  $s^{-1}$

and:

$$\partial M/\partial t = -k(M - M_E) \quad [7.11]$$

It is generally agreed that the drying constant increases with the temperature of the drying air. There is disagreement over the exact relationship. Henderson and Pabis (1961) found that the drying constant varies with temperature according to an Arrhenius relationship:

$$k = k_0 e^{-c/T} \quad [7.12]$$

where:

k = drying constant,  $s^{-1}$

$k_0$  = material constant,  $s^{-1}$

c = material constant, °R

T = Absolute temperature, °R

For example, Henderson and Pabis (1961) give k for corn as:

$$k_{\text{corn}} = 0.54 e^{-5023/T} \quad [7.13]$$

Several other factors have been hypothesized to affect the drying constant including the temperature of the drying air, velocity and relative humidity of the air, and the shape of the particle being dried. It may also vary with the moisture content of the grain, but drying air temperature is the dominant effect for most materials.

### 3. STRUCTURAL LOADS

Like all structures, grain bins and buildings storing agricultural grains are designed to resist various combinations of loads without exceeding the appropriate limit states of the materials of construction (Blight, 2006; Brown and Nielson, 1998; Gaylord and Gaylord, 1984; ICC, 2009; Rotter, 2001; Safarian and Harris, 1985). The loads that

occur in and on grain storage structures can be classified according to their type and duration. In general, the loads can be separated into: 1. dead loads; 2. those caused by the grain stored within the structure; and 3. those loads that are a function of external environmental effects.

The structure's dead load includes the weight of all materials used in the structure for construction as well as the weight of any equipment permanently attached to the structure. Dead loads are normally associated with those things which are permanently part of the structure. The dead load can be determined by looking at the plans of the structure and then applying known weights of materials.

The loads caused by the grain stored within a grain bin or storage building can be characterized as either a dead or live load depending on how they act within the structure. The variation in load type (dead or live) is caused by the emptying and filling of the structure which creates uncertainty in the magnitudes of these loads. Grain loads caused only by the weight of the grain are normally considered to be a dead load. An example of this would be the total vertical load transmitted by the weight of the grain to the foundation. However, design codes and standards note that because of the uncertainties in the lateral pressures caused by granular materials that lateral pressures are considered live loads and ultimately have a higher load factor applied to them.

Loads caused by external environmental effects are those loads caused by wind, snow, rain, and earthquake. The normal design factors dictated by the design codes and standards which take into account these environmental load effects also apply to grain bins and grain storage buildings. However, because many grain bins are tall, thin circular structures containing large amounts of material, some elevated off the ground, design coefficients and design techniques unique to these shapes and types of structures must be applied.

Basic load combinations which include factors associated with grain bin loads are shown below. In those four equations, the terms F and H are associated with loads caused by grain. F is combined with the structure dead load and is used when it is the dominant load. H is associated with the lateral pressures created by the bulk materials. ASCE 7 (ASCE, 2005) indicates that load combinations shall also be investigated where H shall be set equal to zero in those load combinations (3 or 4) in which H may counteract the effects of either wind or earthquake. Therefore, design load combinations not only take into account the effects of the structure filled with grain but also when the structure is empty and could be just as susceptible or more susceptible to wind or earthquake conditions.

1.  $1.4 (D + F)$ .
2.  $1.2 (D + F + T) + 1.6 (L + H) + 0.5 (L_r \text{ or } S \text{ or } R)$ .
3.  $0.9D + 1.6 W + 1.6 H$ .
4.  $0.9D + 1.0 E + 1.6 H$ .

### 3.1 Loads Caused by the Grain

While agricultural grains are considered free flowing, and thus can flow out of bins through an orifice like a fluid, these materials do not have all the same characteristics as those of a fluid. Like a fluid, grain transmits vertical pressures to the floor of the bin because of the overbearing grain and lateral pressures to the walls of the bin. However, unlike a fluid, grain also exhibits friction between particles and can thus sustain shear forces within the material. Because these materials can sustain shear forces, grains also transmit a vertical friction force which is carried by the walls of the structure.

Grains transmit different fluctuating loads to the structure during filling and emptying. When describing grain loads, the terms static and dynamic are often used to describe these two different types of loads. Static grain loads are often described as those loads that occur during filling and/or quiescent storage of the grain, whereas dynamic loads are those loads that occur during emptying of the bin. Depending on the bin geometry and the type of flow created during emptying of a bin, the dynamic bin loads are oftentimes much larger than the static bin loads.

Three generalized flow patterns can occur when discharging grain from storage bins; funnel flow, plug flow, or mass flow (Figure 7.2). In funnel flow, the grain exhibits a last-in, first-out flow regime in which all grain movement occurs through a central core or funnel with no movement of the grain occurring down the bin walls. In this type of flow, the uppermost grain in the bin flows through the center flow channel formed by the grain and is discharged first. Funnel flow can occur in either flat-bottomed or hopper bottom bins equipped with funnel flow hoppers. A funnel flow hopper is a hopper in which the flow channel occurs within the stagnant grain and not along the sloping hopper walls. Funnel flow normally occurs in bins when the height-to-diameter ratio of the grain is less than 1.5–2.0. Because of the manner in

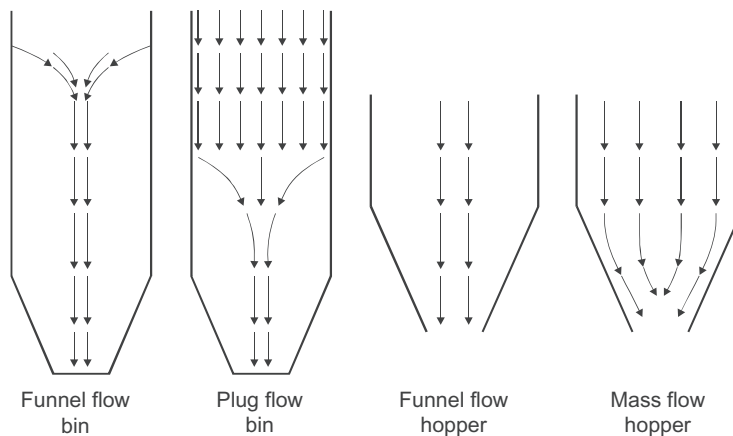


Figure 7.2 *Bin flow patterns.*

which the grain discharges, the wall loads during funnel flow discharge are not thought to be any larger than those which occur during filling. In both plug flow and mass flow discharge, material movement occurs along the bin walls. In a bin discharging in plug flow, two different flow regimes exist at once. In the upper part of the bin the grain mass moves as a unit or plug along the bin walls, whereas in the lower portion of the bin funnel flow occurs, in which grain is discharged through a central flow channel surrounded by stationary material along the bin walls. Plug flow normally occurs in bins when the height-to-diameter ratio of the grain is greater than 1.5–2.0. Plug flow can occur in either flat-bottomed or hopper bottomed bins equipped with funnel flow hoppers. In mass flow bins all of the material stored in the bin moves at once. This flow regime is sometimes described as last-in, last-out flow. Mass flow does not occur in flat-bottomed storage bins and will only occur in hopper bottomed bins in which the bin is equipped with a mass flow hopper in which all of the grain within the hopper moves at the same time. A mass flow hopper has a much steeper wall angle than a funnel flow hopper. This allows all of the grain within the bin to move at once. In both plug flow and mass flow, grain pressures in excess of those found during filling occur on the walls of the bin. When discharging from a central orifice, the flow pattern at any depth in a grain bin is assumed not to vary across the cross-section of the bin.

### 3.2 Eccentric Discharging of Grain from a Bin

In some cases, discharging of grain through the side of a bin simplifies grain movement within a storage facility. However, discharge from bins through eccentrically located orifices in bin floors or bin walls creates uneven overpressures around the circumference of the bin which are much larger than those in center unloaded bins. Eccentric unloading has the effect of forming an off-center funnel of grain flowing towards the eccentric outlet. The exact magnitude and distribution of these overpressures from eccentric unloading is not known. However, because of these unequal pressures, horizontal overturning moments are created in the direction of the discharge gate. In experiments conducted by [Horabik \*et al.\* \(1993\)](#) in a model grain bin, tests have shown that the largest overturning moments were not created when using a discharge orifice located adjacent to or in the bin wall, but rather at a radial distance of approximately  $2r/3$  from the center of bin. Structural failures of bolted bins have been documented in which grain managers eccentrically unloaded bins, either by accident or on purpose. [Blight \(1988\)](#) documented failure of a full-scale bin in which only a very small quantity of grain had been discharged from the eccentric outlet. Most grain bins are not normally designed for a non-symmetrical pressure distribution and off-center unloading of a bin is highly discouraged by most design codes and standards.



### 3.3 Flumes

Off-center unloading can be accomplished by the use of a wall flume. A wall flume is a vertical conduit attached to the walls of a bin through which grain can flow. Discharge outlets from the flume can be placed in the floor of the bin wall or at any location along its vertical line. When using a wall flume, the bin unloads in funnel flow in which the grain sloughs off the top surface of the grain and through the vertical conduit. The top surface of the grain is sloped towards the wall flume with flow occurring only through the topmost exposed opening in the flume. The purpose of the wall flume is to alter the flow within the bin while reducing the dynamic loads and moments associated with plug flow and eccentric unloading. In tests done in a model grain bin [Thompson et al. \(1998\)](#) showed that over most of the flow regime, a wall flume negated the normal vertical wall overpressures found during plug flow discharge. However, in these tests overturning moments were measured in the direction of the wall flume because of the uneven pressures created by the flow pattern. Although these moments were much less than those caused by eccentric unloading, these moments were large enough to potentially cause the bins to become egg-shaped. Because of this, stiffer rings were attached to bin walls.

### 3.4 Stresses in Granular Materials

In a grain bin, two different states of stress are assumed to occur during storage of granular materials, an active and a passive stress state ([Gaylord and Gaylord, 1984](#); [Horabik and Weiner, 1998](#); [Schulze, 2008](#); [Thomson, 1984](#)). These terms are commonly used in soil mechanics to describe the stress of material contained by a retaining wall. An active pressure state occurs during filling of a bin in which the material contracts vertically under the overbearing material with very little horizontal deformation. On a differential element, the largest principle stress is assumed to be aligned along the vertical direction of the bin and forms what is known as an active stress field. In the active pressure state the ratio of horizontal pressure to lateral pressure is less than one. This stress ratio is often called  $K_{\text{active}}$ . When the orifice is opened in a bin and flow starts, the grain forms a flow channel that converges downward toward the outlet. As flow forms, the granular material expands in the vertical direction while contracting in the lateral direction. This causes the stress field to realign within the bin with the largest principle stress now occurring in the horizontal direction. In the passive stress state, the ratio of horizontal pressure to lateral pressure is greater than one. This stress ratio is often called  $K_{\text{passive}}$ . These stress states are also called peaked and arched pressures states ([Jenike et al., 1973a](#)). In discharging grain from a bin, the change in wall loads from static to dynamic occur almost instantaneously with the opening of the discharge orifice. However, once a bin discharges grain and the flow is

stopped, the passive stress state remains. The stress field will not revert back to an active stress state unless the bin is completely emptied and then refilled.

### 3.5 Temperature Cables

One of the most popular methods of determining potential locations of spoilage in stored grains is through constant monitoring of the internal temperatures of the grain mass. A common method of monitoring temperatures in grain utilizes thermocouples attached at regular intervals to high-strength steel cables. These cables are typically suspended from a grain bin roof in a standard pattern so that they form a three-dimensional matrix of temperature monitoring points. Temperature sensing cables are available from many commercial companies, many with differing surface materials, size, and cross-sectional shapes. These cables are subject to vertical frictional loading during filling, storage, and emptying operations. The loads imposed by temperature cables have caused localized roof failures in bins (Wickstrom, 1980). The vertical loads on temperature cables can be estimated by integrating the pressures which act over the surface of the cable (Schwab *et al.*, 1991; Schwab *et al.*, 1992). However, in order to do this, the coefficient of friction of the grain on the cable material must be known. Schwab *et al.* (1991) developed a prediction equation for the vertical frictional load on a temperature cable as:

$$\text{Load} = \frac{1.4\pi\mu_{tc}D_{tc}R_h\gamma}{\mu} \left[ y + \frac{R_h}{\mu k} \left\{ \exp\left(-\frac{\mu k y}{R_h}\right) - 1 \right\} \right] \quad [7.14]$$

where:

$D_{tc}$  = equivalent diameter of the temperature cable =  $\sqrt{4\text{area}/\pi}$

$R_h$  = hydraulic radius of the bin (cross-sectional area/perimeter)

$k$  = ratio of lateral-to-vertical grain pressure

$y$  = depth of grain covering the cable

$\mu$  = coefficient of friction of grain on the bin walls

$\mu_{tc}$  = coefficient of friction of grain on the cable

$\gamma$  = uncompacted bulk density of the grain.

The 1.4 value included in the above equation is not an overpressure factor but rather a multiplication factor which was used to fit the above equation to data collected. Values of the coefficient of wheat on temperature cables are shown in Table 7.2. These values were determined in laboratory testing described in Schwab *et al.* (1991).

In tests of temperature cables, Schwab *et al.* (1991) determined that the radial position of cables within the bin as well as the surface material of the cable had a significant effect on the magnitudes of the vertical cable loads. It was also determined during testing (Thompson *et al.*, 1991) that by restraining the cables from lateral

**Table 7.2** Dimensions and Surface Materials for Temperature Cables

Shape	Dimension (in)	Surface Material	$\mu_{tc}$
Oval	0.46 by 0.42	Nylon	0.242
Oval	0.31 by 0.19	Vinyl	0.335
Round	0.64	HDLE	0.284
		Polyethylene	
Oval	0.58 by 0.37	Nylon	0.293
Round	0.34	Vinyl	0.614

movement larger vertical loads can be applied to the cable because of the flow profile within the bin. Many bin designers suggest that the strength of the connection of the cable to the roof structure of the bin be some fraction of the breaking strength of the cable. Therefore, the cable will not cause failure of the roof structure.

### 3.6 Thermal Loads and Moisture Induced Loads

Additional stresses are induced into restrained structural members when they are subjected to a temperature decrease (ASAE, 2012; Buzek, 1989; Thompson and Ross, 1984). Failure of steel grain bins have been documented during rapid drops in temperature under severe winter conditions. In a grain bin thermal cycling can cause the bin walls to either expand and contract based on temperature increases or decreases. This contraction can cause an increase in wall stresses in the bin as the bin walls shrink back around the stored grain. The increase in wall stresses is thought to be not only a function of the total reduction in ambient temperature but also the rate at which this reduction occurred. At temperatures not far below freezing, many steels can become brittle. This loss of ductility can lead to failures if thermal stresses also produce increased stresses. Welds with minor defects that do not cause problems at normal temperatures can fail when temperatures drop below freezing. Although Blight (1985) proposed qualitative results of the effect of thermal stresses on full-scale bins, quantitative results of these thermal stresses needed for the design of grain bins are not currently available.

Stored grains are hygroscopic and have the ability to absorb moisture from liquid sources or the atmosphere. When grains adsorb moisture they expand. In a structure such as a grain bin this expansion is restrained by the walls of the bin, resulting in changes in wall loads. In model bin studies, lateral wall forces were observed to increase while vertical up-lift forces were observed for grain re-wetted during storage (Kebeli *et al.*, 2000). Data associated with the effects of moisture induced loads are limited. However, it is recommended that grain storage systems be designed to prevent the moisture content of grain from increasing more than 1% or 2% during storage to prevent these increases in loading.

### 3.7 Conical Grain Bins

Almost all bins in the USA which store grains are constructed with vertical cylindrical walls. However, both [Moysey and Landine \(1982\)](#) and [Ross \*et al.\* \(1987\)](#) performed tests on model bins in which the walls were conical shaped. Tests were performed in which the walls within the main cylinder of the bin either diverged from top to bottom or converged from top to bottom. For a wall angle of  $84^\circ$  (walls diverged from top to bottom), [Ross \*et al.\*](#), measured a 36% reduction in total vertical walls load compared to that of a  $90^\circ$  wall. For a wall angle of  $92^\circ$  (walls converged from top to bottom), an increase in total wall loads of 12% over that of a vertical wall was measured. [Moysey and Landine](#) observed similar results for both diverging and converging walls in bins. This idea has not been adopted by bin designers or manufacturers, probably because of the additional costs associated with both fabrications and construction of non-vertical walls, which may offset any advantages gained by the use of lighter materials because of the reduction in wall pressures.

### 3.8 Flat Storage

Circular bins are the most common type of storage structure currently used for storing agricultural products in bulk. However, other types of structures, both permanent and temporary, i.e. flat storage buildings and rectangular or round temporary piles, are used in the storage of grain products. Flat-storage systems are either multipurpose or dedicated rectangular structures in which grain is stored. If the grain is stacked against the wall of a metal building then the walls must be strengthened to carry these loads. Therefore, light-weight metal storage buildings which are used for flat grain storage are normally equipped with internal grain liners. Although large amounts of material can be stored in these facilities, they are harder to fill and unload than circular bins, the stored grain must be dry prior to being placed in the structure because the grain is more difficult to aerate, and insect and rodent control is more difficult than in circular structures because these pests have more access to the stored grain ([Loewer \*et al.\*, 1994](#)). Round temporary piles are often used for temporary storage in which a central tower auger is used ([Waller and Riskowski, 1989](#)). In some cases short side-walls arranged in a circular pattern are used to not only contain the pile within a given area but also to allow for greater storage capacity. Grain is piled against these side-walls and they must be designed to carry the lateral forces acting against them.

Flat-storage and temporary storage piles are normally classified as shallow grain storage structures. Shallow grain storage structures are defined as grain storage structures with a square, round, or rectangular floor plan in which the width or diameter of the building is more than double the equivalent height of grain at the wall. For these type structures, [Janssen's](#) equation is normally not used to predict storage pressures. Rather, these type facilities are designed using techniques similar to those used

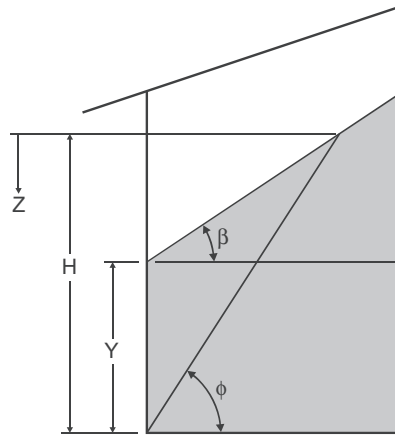


Figure 7.3 Flat storage geometry.

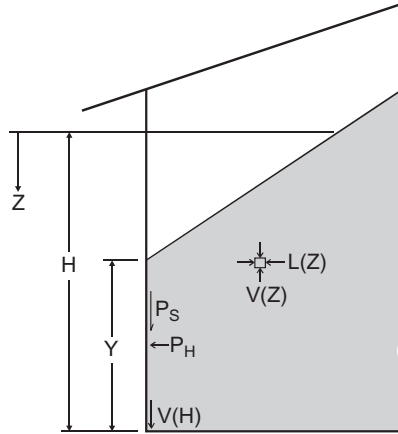
Table 7.3 Coefficient  $\alpha$  to Determine the Total Equivalent Grain Height  $H$

Internal angle of friction, $\varphi$ (°)	Angle of Repose, $\beta$ (°)							
	16	18	20	22	24	26	28	30
24	1.15	1.17	1.19	1.22	1.25			
26	1.16	1.19	1.22	1.25	1.28	1.31		
28	1.18	1.21	1.24	1.27	1.31	1.35	1.39	
30	1.20	1.23	1.27	1.30	1.35	1.39	1.44	1.50

to design retaining walls. [ASAE Standard EP545 \(2012d\)](#) outlines a technique for predicting the loads exerted by free flowing grains on shallow storage structures. In this standard, vertical pressures are influenced only by the overbearing grain, while the walls of the structure are assumed to support those forces produced by a wedge of material acting against the wall. The wedge is bounded by the wall, the sloping backfill condition of top surface of the grain and the plane defined by the angle of internal friction (see [Figure 7.3](#)). In order to predict the lateral pressures acting on the walls of the structure, the bulk density of the stored material, the internal angle of friction, the angle of repose, and the total equivalent grain height must be estimated.

To design the walls, the equivalent grain height,  $H$ , at the wall must be determined ([Table 7.3](#)). The equivalent grain height is defined as where the sloping backfill of the top surface of grain intersects the plane defined by the internal angle of friction. The equivalent height of the grain can be calculated as:

$$H = Y\alpha = Y + Y \left[ \frac{\sin\varphi\sin\beta}{\cos(\varphi + \beta)} \right] \quad [7.15]$$



**Figure 7.4 Stresses on a flat storage structure and within the grain.**

where:

H = equivalent height of grain

Y = height of grain on the wall

$\varphi$  = internal angle of friction for grain, ( $^{\circ}$ )

$\beta$  = angle of repose of the grain, ( $^{\circ}$ ).

A value of  $27^{\circ}$  was suggested for the internal angle of friction for both corn and wheat, while for soybeans an angle of  $29^{\circ}$  was suggested. For free flowing grains, the angle of repose can be assumed to be equal to that of the angle of internal friction.

The vertical pressure at any point within the structure (Figure 7.4) is predicted by multiplying the design density by the height of overbearing grain.

$$V(z) = Wz \quad [7.16]$$

where:

W = bulk density of the stored grain

z = equivalent grain depth at a discrete point (ft).

It is suggested that for design purposes a bulk density of  $52 \text{ lb/ft}^3$  be used, which corresponds to that of wheat modified by an 8% pack factor. Thompson *et al.* (1990) gives methods for calculating packing factors for flat storage. The vertical pressure on the floor of the structure can be estimated by using H in place of z in equation 7.16.

The lateral pressures at any point within the structure (Figure 7.4) can be predicted by:

$$L(z) = kV(z) \quad [7.17]$$

k = ratio of lateral-to-vertical pressure in the grain.

The suggested value of k is 0.5. The maximum lateral pressure at the base of the wall can be estimated by using H in place of z in equation 7.17.

**Table 7.4** Static Coefficients of Friction for Selected Grains on Various Wall Surfaces

Grain	Wall Surface			
	Steel	Concrete	Corrugated Steel	Plywood
Corn	0.25	0.35	0.50	0.44
Wheat	0.25	0.35	0.50	0.50
Soybeans	0.25	0.35	0.55	0.38

Knowing these values, the resultant lateral force per unit length of wall can be determined as:

$$P_H = L(H) H/2 \quad [7.18]$$

where:

$P_H$  = resultant lateral force acting on the wall.

Shear forces acting parallel to the face of the wall can be determined by:

$$P_s = \mu P_H \quad [7.19]$$

where:

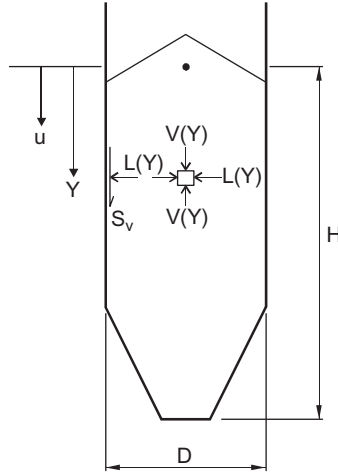
$P_s$  = resultant shear force acting on the wall.

Values of the static coefficient of friction  $\mu$  are shown in [Table 7.4](#) for various materials and all conditions.

In shallow structures, dynamic effects do not occur. Therefore, the pressures estimated during loading and unloading are equal. Increased loads can be caused by unbalanced loading conditions, moisture, and by vibration induced pressures. However, the magnitude of these increases is not known. Factors of safety should be increased if the possibility of these types of loads exists.

### 3.9 Janssen's Equation

In 1895, H. A. Janssen conducted experiments on small square model bins to determine the pressures on the walls of grain bins ([Janssen, 1895](#)). The bin walls of his models were supported on four screws, which could be raised above a scale bed which supported the floor of the model bin. Following filling of the model to a given height, measurements of the bottom loads which were supported by scales were recorded. The test bin was then raised by the screw system and again the bottom pressures recorded on the scales. In raising the walls of the bin, friction forces occurred between the grain and bin walls which relieved some of the loads occurring on the floor of the model. From this series of experiments, Janssen was able to develop a formula for the prediction of loads in bins. Janssen's approach was to sum the vertical forces acting on a differential element of thickness  $dy$ , at a depth  $y$ , from the surface of the grain (see [Figure 7.5](#)). Janssen's equation was based on the hydraulic radius of the bin, the bulk



**Figure 7.5 Janssen's model.**

density of the grain, the coefficient of friction of the grain on the bin walls, and the ratio of lateral to vertical pressure,  $k$ . In his derivation Janssen assumed that the material properties of the grain did not vary throughout the bin.

Using Janssen's equation the static vertical pressures within the grain can be predicted:

$$V(Y) = \frac{WR}{\mu k} \left[ 1 - e^{-\mu k Y / R} \right] \quad [7.20]$$

where:

$R$  = hydraulic radius of the bin = cross-sectional area/perimeter

$V(Y)$  = vertical pressure of grain at depth,  $Y$

$W$  = bulk density of the grain

$Y$  = equivalent grain depth

$k$  = ratio of lateral to vertical pressure

$\mu$  = coefficient of friction of grain on the bin wall.

For the condition in which a surcharge cone of grain exists on the top surface of the grain,  $Y$  is measured from the center of the surcharge cone at  $1/3$  of its height. The top surface of the grain is normally assumed to stack at the grains' angle of repose. For free flowing agricultural grains, this angle is assumed to be approximately  $28^\circ$ .

To estimate the static lateral pressure,  $L(Y)$  in a bin at depth  $Y$ :

$$L(Y) = kV(Y) \quad [7.21]$$

To estimate the shear stress,  $S_v$ , between the vertical wall and grain at depth  $Y$ :

$$S_v = \mu L(Y) \quad [7.22]$$



To determine the floor pressures on the bin, the equivalent height,  $H$ , must be determined. This value is defined as the distance from the lowest point of discharge to 1/3 of the height of the surcharge cone, if present. For flat-bottomed bins,  $H$  would be defined from the floor surface, whereas for hopper bottom bins,  $H$  would be defined from the discharge orifice in the hopper.

To calculate the vertical wall load,  $P_v$ , at depth,  $Y$ :

$$P_v = [WY - V(Y)] R = \int_0^Y \mu L(u) du \quad [7.23]$$

where:

$u$  = integration variable measured from the top of the grain to the point in question.

After Janssen performed his work, other scientists and engineers also worked on developing equations to predict the pressures in grain bins. However, Janssen's equation was adopted by most bin designers and was made popular because of the work by Ketchum who wrote a book on the "The Design of Bins, Walls and Grain Elevators" (Ketchum, 1907) which included a review of Janssen's work. While Janssen had derived his equation for square bins, Ketchum modified Janssen's equation to be used in circular bins when he incorporated the use of the hydraulic radius,  $R$ , (Roberts, 1995) into the equation. Janssen's equation performed well for a period of time until the size of grain bins increased with the proportional need for increased storage space. With larger diameter and taller bins appearing on the market, reports of structural problems began to arise. One major weakness associated with Janssen's equation is that it did not take into account the effect of different discharge flow patterns. Much of the renewed interest in grain bin design and prediction of side-wall pressures occurred in France and Russia beginning in the 1940s. Much of this work was associated with trying to learn more about the effects of flow on bin pressures. Although other bin equations were developed, Janssen's equation is still the basis by which almost all design standards predict grain bin pressures. To take into account the dynamic effects which occur during bin unloading, overpressures factors are used that multiply the static bin loads suggested by Janssen's equation by a factor based on design criteria suggested by the standard.

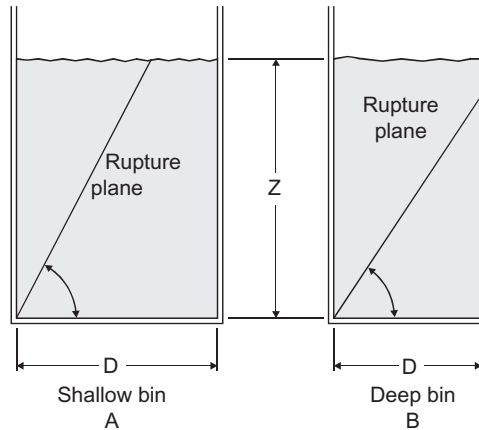
### 3.10 Flat Storage, Shallow and Deep Bins

Structures storing granular materials can be classified into two general classifications, flat storage buildings or bins. These general classifications are based not on the shape of the structure, but rather if during loading the stored grain creates bin-effects or earth-pressure effects on the walls of the structure. In an earth-pressure situation very little interaction occurs between the opposite walls of the structure and analysis

**Table 7.5** Classification of Bins Proposed by ASAE Standard EP433

	Flat Storage	Shallow Bin	Deep Bin
Height-to-Diameter Ratio	0.5*	2.0	> 2.0

\*For square or rectangular structures flat storage is defined as a structure in which the height of grain on the wall of the structure is less than 0.5 times the width of the building.

**Figure 7.6** Rupture planes in a shallow bin (A) and in a deep bin (B).

techniques normally used for retaining wall design would be used. In bin-effect situations interaction occurs between the walls based on internal loading of the structure and analysis techniques for bins would be used. EP433 (ASAE, 2012a) a grain bin design standard suggests the following classifications (see Table 7.5). Those structures classified as bins are further sub-divided into either shallow or deep bins. In shallow bins, the grain pressures on the walls during emptying are the same as those during filling. Whereas in deep bins, the grain pressures on the walls during emptying are larger than those during filling. Shallow bins are normally thought to unload only in funnel flow, whereas deep bins unload in either plug or mass flow. Nelson *et al.* (1988) defined a shallow bin as one in which the rupture plane intersecting the floor-wall intersection slopes upward at an angle of  $45 + \varphi/2$  from the horizontal. If this rupture plane intersects the grain surface prior to intersecting the opposite wall then it would be considered a shallow bin, whereas in a deep bin the rupture plane intersects the opposite bin wall prior to intersecting the grain surface (see Figure 7.6). For most free flowing grains, the internal angle of friction is approximately  $28^\circ$ . Using this criterion, shallow bins would have a height-to-diameter of less than 1.66, whereas deep bins would be classified as those with a height-to-diameter of greater than 1.66. In experiments conducted in grain storage structures, these authors have viewed funnel flow occurring at a height-to-diameter between 1.5 and 2.0.

### 3.11 Loads on Hoppers

Hoppers are the sloping part of a bin which is used to aid gravity discharge through an orifice (ASAE EP433, 2012a) (Figure 7.7). Hoppers can discharge in either mass flow or funnel flow depending on the material stored, the geometry of the bin, the hopper angle, and the coefficient of friction between the grain and the hopper surface. A mass flow hopper is a hopper in which all the grain within the hopper is moving when grain is withdrawn, whereas in a funnel flow hopper grain movement occurs through a flow channel formed in the stagnant grain. AS3774 (Standards Australia, 1996) provides a graph for conical hoppers which predicts when funnel flow or mass flow will occur. For a coefficient of friction of 0.3, which EP433 suggests is the coefficient of friction for grain on smooth steel, a conical hopper with a hopper angle,  $\alpha$ , less than  $45^\circ$  would be considered a funnel flow hopper, whereas a conical hopper with a hopper angle,  $\alpha$ , greater than  $68^\circ$  would be considered a mass flow hopper. AS3774 suggests that hopper angle,  $\alpha$ , in between these two angles would have an unstable flow zone which would be difficult to predict. While it is important to understand the type of flow that exists in a hopper, the use of a hopper is also to aid in clean-out and ensure that all of the contents of the bin are gravity discharged. If the hopper angle,  $\alpha$ , is very small, then grain will remain in the bin even after emptying has been completed. Jenike *et al.* (1973c) suggest that for self cleaning of hopper walls the hopper angle,  $\alpha$ , must be greater than  $\varphi^\circ + 25^\circ$ ; whereas other designers suggest that the hopper angle,  $\alpha$ , be greater than  $1.5 \tan \varphi$ , where  $\varphi$  is the angle of friction between the stored material and the hopper surface (ACI, 1997).

In a hopper just as in the cylinder of the bin, vertical and lateral grain pressures occur within the grain. On the walls of the hopper, forces perpendicular and parallel to the hopper walls are normally calculated. Forces perpendicular to the hopper wall can be calculated as:

$$V_n = V(Y)\cos^2\alpha + L(Y)\sin^2\alpha \quad [7.24]$$

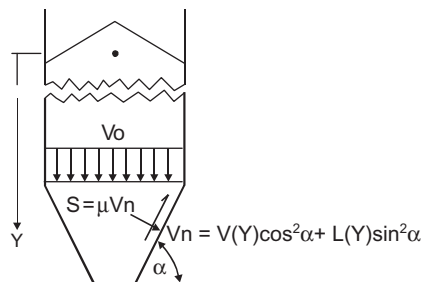


Figure 7.7 Hopper stresses.

The force tangential to the hopper wall surface can be calculated as:

$$S = \mu V_n \quad [7.25]$$

where:

$L(Y)$  = lateral pressure at grain depth,  $Y$

$V(Y)$  = vertical pressure at grain depth,  $Y$

$S$  = shear stress acting on the hopper wall surface

$Y$  = equivalent grain depth, measured from the centroid of the surcharge cone to the discrete point within the grain mass

$\alpha$  = angle from the horizontal to inclined surface of the hopper

$\mu$  = coefficient of friction between the grain on structural surfaces.

$V(Y)$  and  $L(Y)$  in [equation 7.24](#) are calculated using Janssen's equation for vertical and lateral grain pressures. To calculate  $V(Y)$  in [equation 7.24](#), a value of  $R$ , the hydraulic radius must be used. In most design standards, it is suggested that the value of  $R$  is calculated based on the geometry of the bin at the junction of the cylinder and hopper. To calculate the pressures normal to the hopper wall some bin design standards use the following technique:

$$V(Y) = V_0 + Wh_y \quad [7.26]$$

where:

$V_0$  = vertical pressure in the grain at the top of the hopper

$W$  = bulk density of the stored grain

$h_y$  = depth measured from the top of the hopper to the discrete point in question.

In this technique, the vertical weight of the grain contained within the hopper is superimposed on the vertical pressure at the top of the hopper,  $V_0$ .  $L(Y)$  would then be calculated by multiplying  $V(Y)$  by a value of  $k$ , the lateral-to-vertical pressure ratio in the grain. Other design standards use the value of  $Y$  ([Figure 7.7](#)) as defined at the discrete location in the bin, to calculate  $V(Y)$  and  $L(Y)$ .

Based on the design standard being used, bin height and bin diameter overpressures may need to be applied to values of  $V(Y)$  and  $L(Y)$ . EP433 (ASAE, 2005a) only applies to funnel flow hoppers and indicates that overpressure factors should be applied to loads acting at the top of the hopper. However, to predict pressures in the hopper, EP433 allows the overpressure factor to be linearly reduced from a value of 1.4 at the junction of the hopper and bin cylinder to a value of 1.0 at the hopper discharge point. ACI 313 (1997) indicates that for funnel flow hoppers the design pressure,  $V_0$ , be multiplied by an overpressure factor of 1.5 for steel hoppers. However, the vertical design pressure at the top of the hopper does not need to exceed  $W Y$ .

[Jenike et al. \(1973b\)](#) and [Van Zanten et al. \(1977\)](#) identified a zone of high pressure at the point where the hopper meets the wall of the cylinder. However, the exact magnitudes of these high pressures have not been quantified. Great caution should be

exercised because of these high loads in the design of the connection where the hopper meets the cylinder of the bin.

In the design of a hopper, not only must the hopper be designed but also the ring beam (Moysey, 1989; Rotter, 1988). The ring beam supports the bin cylinder as well as the hopper and is a means whereby the support legs are attached to the bin. The ring beam must be able to support the vertical forces transferred from the cylinder of the beam as well as vertical and lateral forces which are transmitted from the hopper. Because of the manner in which loads are transferred from the hopper to the ring beam, not only must the ring beam be able to carry bending moments but also torsional moments. In addition, these moments are then transferred from the ring beam to the support legs.

### 3.12 Snow and Wind Loads

Grain structures must be designed for both snow and wind loads. Techniques for calculating these type loads are described in either ASCE 7-05 (ACSE, 2005) or the International Building Code (ICC, 2009).

When calculating snow loads, the design snow loads are assumed to act on the horizontal projection of the roof surface. These snow loads are calculated using equation 7.27:

$$p_f = 0.7C_e C_t I p_g \quad [7.27]$$

where:

$p_f$  = roof snow load

$C_e$  = exposure factor

$C_t$  = thermal roof factor

$I$  = importance factor

$p_g$  = ground snow load, value obtained from snow load maps taking into consideration any localized snow effects.

Many grain bins have conical roofs with roof slopes only slightly larger than 28°, the angle of repose of the storage grain. The bins are unheated and are normally made out of galvanized steel, which would be considered a slippery surface. Using these general criteria, the roof snow loads for these type structures are approximately 75–80% that of the ground snow load. In many cases, bins are grouped together or ordered in a closely arranged line. In this case the bins are not exposed to the wind and then consideration should be given to snow standing on these roofs in different patterns than of those bins exposed directly to the wind. Also, unbalanced loading of the bin roof could also occur because of the shading of one bin from another. However, in many regions of the southern USA, the ground snow load is very small and then other criteria, such as the minimum roof live load or even ice loads might be the governing design criteria. In many bins the grain is aerated, i.e. air is moved

up through the grain from the bottom of the mass to the top and then discharged through vents in the bin roof. This air, although not heated, can be warmed slightly by the grain, and when exhausted could have a temperature greater than freezing. If so, this would cause melting of the snow on the bin roof. However, once aeration ceases, this water could refreeze on the bin roof and then ice build-up could occur. So, some caution should be taken when considering ice loads on bin roofs as well as snow loads.

As for all other structures, when calculating winds on grain bins, consideration should be given to how the wind moves around the body of the structure as well as over the roof of the structure. In the case of a grain bin, the body of the structure is normally cylindrical in shape whereas in many cases the roof of the structure is conical. In a thin-walled metal grain bin, when full, the bin contents actually stiffen the wall and aid the structure in withstanding high winds. However, when empty these types of structures are very susceptible to wind loads and denting of the walls can occur if wind rings are not placed in the walls of the bin to help withstand these type loads.

The basic velocity pressure based on the design wind speed at the equivalent height  $z$  on the structure is calculated as:

$$q_z = 0.00256K_zK_{zt}K_dV^2I \quad [7.28]$$

where:

$q_z$  = wind velocity pressure evaluated at height  $z$

$K_z$  = velocity pressure exposure coefficient, this takes into account the height above ground level,  $z$ , the effect of surrounding structures, and ground surface irregularities

$K_{zt}$  = topographic factor, this factor takes into account the topography of the land surrounding the structure

$K_d$  = wind directionality factor, for bins  $K_d = 0.9$  for square bins, 0.95 for hexagonal or round bins

$I$  = Importance factor; this accounts for degree of hazard to human life as well as damage to property. Agricultural facilities are classified as Category IV structures and an importance factor of 0.87 is specified. However, for elevated grain structures an importance factor of 1.0 (Category I) should be considered because of the potential that these structures have for damage to property as well as the hazard they pose to human life

$V$  = design wind speed.

For grain bins, the design wind force can be calculated based on the area of the structure projected on a plane normal to the wind direction. This force is assumed to act in a direction parallel to the wind and can be calculated as:

$$F = q_zGC_fA_f \quad [7.29]$$

**Table 7.6**  $C_f$  Values for Round Grain Bins

Cross-Section	Type of Surface	H/D = 1	H/D = 7
Round $D\sqrt{q_z}/2.5$	Moderately smooth	0.5	0.6
	Rough $D'/D = 0.02$	0.7	0.8
	Very Rough $D'/D = 0.08$	0.8	1.0
Round $D\sqrt{q_z}/2.5$	All	0.7	0.8

**Table 7.7** Pressure Coefficients,  $C_p$  for Components and Cladding

Angle $\beta$ , (°)	$C_p$	Angle $\beta$ , (°)	$C_p$
0	1.0	105	- 1.5
15	0.8	120	- 0.8
30	0.1	135	- 0.6
45	- 0.8	150 to 180	- 0.5
60	- 1.5		
75	- 1.9		
90	- 1.9		

A negative value indicates that the force is acting away from the structure and a positive value indicates that the force is acting in the direction of the structure.

where:

$F$  = design wind force

$q_z$  = wind velocity pressure calculated using [equation 7.28](#)

$G$  = gust factor, a conservative value of 0.85 can be used

$A_f$  = project area normal to the wind

$C_f$  = force coefficient.

For round bins, the value of  $C_f$  can be determined by taking into account the surface roughness of the bin as well as the height-to-diameter (H/D) of the structure. Values of  $C_f$  are shown in [Table 7.6](#).

The minimum wind speed used in design should not be less than 10 lb/ft<sup>2</sup> multiplied by the area of the projected structure. For grain bins, it is important to take into account the effect of wind loads on these type of structures when empty of all contents as well as when full.

Wind tunnel tests have been performed on model bins which looked at localized pressure coefficients around the bin wall. It was determined that the circumferential wind pressure distributions were symmetrical about the windward line ([Kebeli et al., 2001](#)). The highest negative pressures were observed at 90° on the cylindrical wall. [MacDonald et al. \(1988\)](#) determined that the roof configuration had little effect on the distribution of pressures on the walls of the cylinder. [Table 7.7](#) shows localized pressure coefficients,  $C_p$ , for a round grain bin with an H/d < 5. The  $\beta$  angle is

**Table 7.8** Pressure Coefficients  $C_p$  for Conical Bin Roofs

Roof Zone	Pressure Coefficients $C_p$
Windward roof side	− 0.8
Leeward roof side	− 0.5
Localized pressure zones	− 1.0

measured with respect to the wind direction. A  $\beta$  angle of zero degrees would be a point directly in line with the wind.

For bin roofs, the wind pressure coefficients are more complex. The pressure coefficients,  $C_p$ , were found to vary with respect to roof angle and roof roughness (Kebeli *et al.*, 2001). In AS1170.2 (Standards Australia, 1989), roof pressure coefficients are given for bin roofs in which different pressure coefficients are used for different zones of the roof. The pressure coefficients for the roof are shown in Table 7.8.

Two localized zones of pressure exist on bin roofs:

1. On the windward edge of the roof is a high pressure zone. This localized zone extends over a zone  $45^\circ$  in either direction from the direction of the wind and has a depth of 0.1 times the bin diameter.
2. At the roof peak a second localized pressure zone occurs. This zone has dimensions of 0.2 D by 0.5 D, where D is the diameter of the bin. The long side of this zone is perpendicular to the wind.

When bins are placed in groups in close proximity to each other, significant pressure changes can occur both on the bin walls and bin roof. Kebeli *et al.* (2001) tested three different bin configurations and determined that the configuration as well as the spacing of the bins had an effect on the external pressure coefficients.

### 3.13 Seismic Loads

In seismic design, grain bins are considered non-building structures. Non-building structures must have sufficient strength, stiffness, and ductility to resist the effects of ground motion caused by earthquakes. Seismic design varies according to how the bin is supported. The design techniques for above-grade elevated bins which are supported on supports structures are different from those in which the bins are at-grade level and supported by the ground. For non-building structures the fundamental period of the structure is determined using the Rational method and by;

$$T_a = C_T h_n^{0.75} \quad [7.30]$$

where:

$h_n$  = height above the based to the highest level of the structure

$C_T$  = building period coefficient.



The Structural/Seismic Design Manual (SSA, 2001) provides an example for a tank supported on the ground by a foundation in which the period of vibration is calculated for a thin-walled cantilevered cylinder in which:

$$T = 7.65 \times 10^{-6} \left( \frac{L}{D} \right)^2 \left( \frac{wD}{t} \right)^{0.5} \quad [7.31]$$

where:

D = bin diameter

L = height of the bin

w = weight per foot of the bin = total weight including bin contents/height of the bin

t = wall thickness.

Using this equation, many thin-walled metal bins would be considered flexible structures and the design base shear would be calculated as:

$$V = C_s W \quad [7.32]$$

where:

$C_s$  = seismic response factor

W = weight of the bin and its contents.

The seismic response factor,  $C_s$ , is calculated based on the earthquake importance factor, spectral response factor, and the spectral response acceleration factor, all of which are site specific factors indicated in either ASCE 7-05(2005) or the IBC (ICC, 2009). The weight, W, for non-building structures shall include the dead load of the structure as well as the bin contents. ACI313 (1997) suggests that the effective weight of the stored material be taken as 80% of the actual weight. Although ACI assumes that the silo is full, the weight W, which would be used to calculate the lateral seismic force, is reduced because of energy losses through intergranular movement and particle-to-particle friction of the stored material. The importance factor I and seismic use group are based on both the relative hazard of the bin contents and its function. For grain bins, an argument could be made that the importance factor could be based on a hazard classification of H-1, which is for biological products with low fire or low physical hazard, and H-1, which is any non-building structure not considered essential in an emergency. Using this idea, a grain bin would have an importance factor of  $I = 1.0$ .

The vertical distribution of shear forces must then be determined as well as the overturning moments caused by the lateral shear forces. The vertical distribution of shear forces is then calculated by:

$$F = C_{vx} V \quad [7.33]$$

where:

$C_{vx}$  = vertical distribution factor

F is assumed to be applied at 2/3 of the height of the bin at the centroid of a triangular distribution.

For above-grade bins supported on a support structure, the attachments, supports, and the tank must be designed to meet the requirements of the loads caused by earthquakes. The techniques used for this type of structure are more complex because of the hazards posed by the massive weight of the structure being supported above the ground.

#### 4. GRAIN HANDLING

The principles of sizing grain handling components are (Loewer *et al.*, 1994):

1. At least one component of the grain handling system will always be the limiting factor for system capacity.
2. The limiting component should have sufficient capacity to handle the maximum desired flow rate of the system.
3. Each grain handling component must be able to handle the flow of grain into it from all other equipment components that operate simultaneously and feed it directly.
4. There should be safeguards against accidental overloading of handling components that are located “downstream” from larger capacity equipment.
5. Selection of a component should be based on its ability to handle the grain at the least possible cost per unit of material processed.

The first step in designing a grain handling system is to specify the desired processing rate between delivery and receiving stations. At least one component in the materials handling system will always be limiting. The key to optimizing the design is to select the materials handling component with the smallest capacity that is sufficient to meet or exceed the design specifications.

Materials handling equipment may be placed in series or parallel. A certain amount of “surge” capacity must exist at each junction between conveyors or between conveyors and receiving or delivery points. The sizing of these surge capacities is primarily dependent on economics. It is preferable to size the downstream conveyor in serial systems slightly larger than the upstream conveyor in order to minimize the surge capacity between the two conveyors. Theoretically, no surge is needed in serial systems if the flow rates from one conveyor to another are the same, or if all conveyors are operating at less than maximum capacity. In the latter case, the excess capacity serves to alleviate surges in the system flow.

One method of regulating flow of granular materials through the handling system is to place control valves or gates at the exit point of each surge capacity. The set

points for these devices must insure that the downstream conveyor will not be overloaded while, at the same time, keeping the surge capacity from being exceeded and causing an eventual stoppage of the upstream conveyor.

The designer should consider that some material handling components will have different capacities depending on the type and condition of the material being handled. For example, the same screw conveyor will convey different quantities of grain depending on the grain type (i.e. corn or soybeans), moisture content (higher capacities at lower grain moistures), and degree of cleanliness (lower capacities with trashy grain). Designs of conveyors in series should be based on the maximum expected capacity and include control valves for further flow regulation.

Another consideration is the starting of the material handling system. The order of starting should begin with the most downstream conveyor, working back to the receiving point. This insures that the entire pathway is clean and able to convey material without overloading the surge capacities or, in some cases, exceeding the starting current needed for electrical motors.

Conveyors have multiple uses in most handling systems for bulk materials, especially those at the farm level. For example, the same bucket elevator may be used to receive wet grain and convey it to the wet holding bin, receive dry grain from the dryers and convey it to storage, and receive grain from storage and convey it to trucks for delivery to market. The bucket elevator should be of sufficient capacity to satisfy each of the situations recognizing that it may be oversized for some of its applications. The design procedure is to trace each flow pattern to insure each conveyor in series is of sufficient capacity to handle the incoming material.

CEMA (Conveyor Equipment Manufacturers Association, [www.cemanet.org](http://www.cemanet.org)) and the ASABE (American Society of Agricultural and Biological engineers, [www.asabe.org](http://www.asabe.org)) are useful sources of technical material and material classifications for design and use of conveying equipment for bulk materials.

## 4.1 Screw Conveyors

A screw conveyor or auger system is composed of several parts. The screw conveyor is composed of a pipe with a welded steel strip that is formed into a continuous helix. The helix is referred to as the flighting. The distance along the pipe from one point on the flighting to the next similar point is called the “pitch”. Couplings and shafts refer to the mechanisms by which two screw conveyors are joined. Hangers are used to provide support and maintain alignment of the screw conveyor. The screw conveyor may be housed in a “tube” or “trough”. The tube is a hollow cylinder, whereas the trough has a “U” shape, hence the term “U-trough” augers.

The theoretical capacity of a full screw conveyor is:

$$C_{\text{cap}} = \frac{(D^2 - d^2)PN}{36.6} \quad [7.34]$$

where:

$C_{\text{cap}}$  = volumetric capacity of full screw conveyor,  $\text{ft}^3/\text{h}$

$D$  = diameter of screw, (in.)

$d$  = diameter of shaft, (in.)

$P$  = pitch of the auger (usually the pitch is equal to  $D$ ), (in.)

$N$  = revolutions per minute of the shaft.

The actual capacity of the screw conveyor may be one-third to one-half of the theoretical capacity because of material characteristics, screw-housing clearance, and the degree of elevation.

Horsepower requirements are difficult to determine because of the variations between different augers and materials. The following equation estimates the horsepower required for an auger operating in the horizontal positioning ([Henderson and Perry, 1976](#)):

$$C_{\text{hp}} = \frac{C_{\text{cap}} \text{LWF}}{33000} \quad [7.35]$$

where:

$C_{\text{hp}}$  = computed horsepower

$C_{\text{cap}}$  = volumetric conveyor capacity,  $\text{ft}^3/\text{min}$

$L$  = conveyor length, ft

$W$  = bulk weight of material,  $\text{lb}/\text{ft}^3$

$F$  = material factor.

The horsepower in [equation 7.35](#) must be adjusted for horsepower under 5.0 hp:

If  $C_{\text{hp}} < 1$ ,  $\text{hp} = 2.0C_{\text{hp}}$

If  $1 = < C_{\text{hp}} < 2$ ,  $\text{hp} = 1.5C_{\text{hp}}$

If  $2 = < C_{\text{hp}} < 4$ ,  $\text{hp} = 1.25C_{\text{hp}}$

If  $4 = < C_{\text{hp}} < 5$ ,  $\text{hp} = 1.1C_{\text{hp}}$

If  $C_{\text{hp}} \geq 5$ ,  $\text{hp} = C_{\text{hp}}$

where hp = horsepower of horizontal auger.

Screw conveyors become less efficient when they are used to convey material vertically. Capacity decreases with inclination about 30% for a  $15^\circ$  inclination and about 55% for a  $25^\circ$  inclination.

Tube and U-trough screw conveyors are the two most common conveyors of grain. Generally, U-trough screw conveyors operate at a lower speed than tube screw

conveyors. Their screw diameters are usually larger, giving them greater capacity per revolution. Because of their lower speed, the U-trough screw conveyors are generally considered to cause less grain damage than tube screw conveyors. However, tube screw conveyors are less expensive and meet the needs of most grain handling situations.

Portable screw conveyors are used extensively for transferring grain into and out of storage. Diameters typically range from 6 to 12 in., with maximum capacities near 5500 ft<sup>3</sup>/h. Portable screw conveyors range in length from around 6 to 100 ft. Moving grain with this type of screw conveyor at angles exceeding 45° is considered impractical.

## 4.2 Belt Conveyors

The belt conveyor is an endless belt moving between two or more pulleys. The belt and its load may ride over a stationary flat surface, but to reduce friction, the belt and its load are usually supported by rollers referred to as idlers. Sets of three idlers are typically used, with the two side idlers tilted at angles up to 45° to form a trough.

Belt conveyors are a very efficient but relatively expensive means of transporting bulk material. Grain damage is relatively low so this type of conveyor is often used in seed processing and conditioning systems. Belt conveyors are often used in large commercial operations because conveying capacities can be high and they can transport grain long distances. A belt in Africa used to transport phosphates is 60 miles long. They are limited in their angle of elevation for agricultural grain to below 15–20°, although greater angles can be used if the belt is equipped with cups or ribs. Belt conveyors can also be used as feeders.

The capacity of a belt conveyor is the belt speed times the cross-sectional area of the bulk material belt speed. The cross-sectional area profile is determined by the type of roller. Typically, three rollers are used, the center one being horizontal with the other two cupped inward at angles ranging from 20° to 45° (Figure 7.8). Flat belts may be used but at much reduced capacities.

The power requirements for a belt elevator are driven by the need to:

1. Overcome the frictional forces associated with the movement of the belt.
2. Accelerate the materials being conveyed.
3. Lift the material to higher elevations.

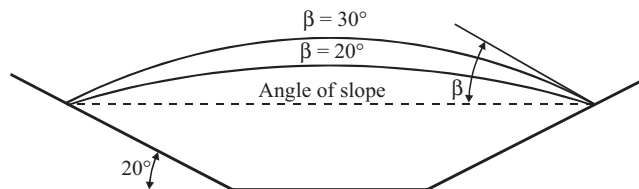


Figure 7.8 Belt cross-section.

The acceleration and lifting power requirements can be calculated from the basic methods of dynamics. However, the frictional requirements are highly system dependent. Empirical relationships are typically used to estimate the power required to drive belts.

The drive is located on the discharge end. The drive pulley must be large enough to ensure sufficient contact area to insure a positive drive. Idlers are often used to increase wrap contact area. Stitched canvas and solid woven rubber belts are commonly used. Belt conveyors are typically equipped with drive tension or take up devices. Grain is fed onto the belt by a chute or feeder and is discharged over the end of the belt or can be discharged at right angles to the belt by using a tripper consisting of two idler pulleys that cause the belt to take the shape of an “S” (Figure 7.9). Grain is discharged over the top idler and is caught by a chute that diverts the grain to the side. Grain can be blown or shaken off at high belt speeds, particularly if flat belts are used. Belt capacity can be estimated from Table 7.9.

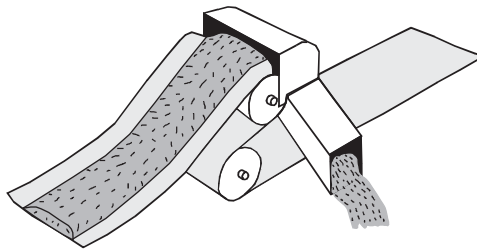


Figure 7.9 Belt tripper – side discharge.

Table 7.9 Belt Load Cross-Sectional Areas and Maximum Belt Speeds

Belt Width (in.)	Margin Width (in.)	Total Cross-Section Area for Surcharge Angle $\beta$ (ft <sup>2</sup> )			Maximum Speed (ft/min)
		$\beta = 10^\circ$	$\beta = 20^\circ$	$\beta = 30^\circ$	
14	1.7	0.07	0.10	0.12	400
16	1.8	0.10	0.13	0.16	450
18	1.9	0.13	0.17	0.21	450
20	2.0	0.17	0.22	0.27	500
24	2.2	0.26	0.33	0.41	600
30	2.5	0.42	0.54	0.67	700
36	2.8	0.62	0.80	0.99	800
42	3.1	0.86	1.12	1.37	800
48	3.4	1.16	1.48	1.83	800
54	3.7	1.45	1.90	2.33	800
60	4.0	1.83	2.36	2.91	800

The horsepower required to drive a belt conveyor can be calculated by adding the power required to accelerate grain to the belt velocity and elevate grain on inclined belts to the power required to overcome the frictional resistance of the belt and the frictional resistance of idlers and unloading devices. The frictional constants are variable depending on the grain being handled and operating conditions, so most belt conveyor components are sized based on empirical data.

### 4.3 Bucket Elevators

Bucket elevators are one of the more commonly used conveyors of grain between different elevations. The typical bucket elevator (often referred to as a “leg”) conveys grain vertically using buckets attached along a belt. The grain exits the bucket elevator by gravity or by centrifugal force as the buckets begin their downward movement. From the top of the bucket elevator, grain is directed through a chute to either a bin or another conveyor such as an auger or belt. The base of a bucket elevator is referred to as the “boot”, the vertical housings for the belts are referred to as “legs” and the top of a bucket elevator is the “head”. Chutes leading from the bucket elevator head downward to bins or other conveyors are referred to as “downspouts”.

Bucket elevators are very efficient to operate because there is little sliding of the granular material along exposed surfaces, thus significantly reducing frictional losses. They occupy relatively little horizontal area, and can be purchased in a wide range of capacities. In addition, bucket elevators can be operated at less than full capacity without damaging the material as much as most other conveyors. Bucket elevators are relatively quiet, have long lives, and are relatively free of maintenance. They require little labor to operate.

The primary disadvantage of bucket elevators is the comparatively high purchase and installation costs. Other considerations relate to where maintenance and repair will be conducted. The motor for a bucket elevator is located high above ground in the head of the conveyor. Similarly, chutes are suspended high above the ground. The bases of most bucket elevators are located in pits in order to be fed by gravity from a receiving pit. This can increase problems associated with clean-out of the conveyor, especially if water collects around the elevator boot. Bucket elevators are not portable, although additional downspouts may be added to serve other locations. There is potential for mixing of material as a result of accidentally directing material to the wrong location because the operator often cannot directly see where the material is being transferred.

The design of bucket elevators begins with determining the through-put capacity and discharge height followed by selection of auxiliary components to the system. The discharge height is determined by identifying the elevation above ground where the granular material is to be delivered as referenced by the location of the bucket

elevator. The angle of the downspouting must be sufficiently steep so that the material will easily flow to the desired delivery point. The following minimum angles, referenced to ground level, are recommended for downspouting common grains within “normal” ranges of moisture:

Dry grain  $37^\circ$

Wet grain  $45^\circ$

Feed material  $60^\circ$

Other design considerations include determining how the product will be fed into the boot. Grain can be fed from either side of the boot, but it is usually desirable to feed grain from the front so that buckets are not required to fill by dragging through the grain in the bottom of the boot. A wide range of vendors supply belt and bucket materials. Only 2/3 of the bucket’s capacity are used to calculate capacities.

Belts will stretch after a period of time and unless there is a method to take-up the belt stretch, the belt will eventually start slipping on the drive pulley. The take-up device moves one pulley further away from the other. The pulley to be moved can be either the top or bottom pulley. Easily accessible clean-out doors are needed at the back and front of the boot.

Dust is generated within the elevator by the bucket loading process. Dust can be extracted from the bucket elevator by dust collection systems where necessary. Many grains produce dust that is explosive under dry conditions. The installation of bursting panels and possibly pressure and temperature sensing instrumentation to detect high-risk conditions should be considered. The selection of materials suitable for an explosive environment and equipment to control static charge build-up reduces hazards.

The bucket spacing times the number of buckets per second determines the required belt speed. The speed of centrifugal bucket elevators is usually in the range 5–6 ft/s. A simplifying assumption is made that the grain is thrown at the top of the head pulley (Figure 7.10). At this point, centrifugal force and gravity force are balanced.

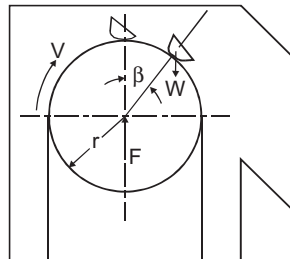


Figure 7.10 *Bucket elevator head pulley.*



$$\text{Centrifugal force} = \frac{wv^2 \cos(\beta)}{3600 \text{ gr}} \quad [7.36]$$

where:

$w$  = weight of grain, (lb)

$v$  = tangential belt velocity, (ft/min)

$\beta$  = angle from top dead center

$r$  = pulley radius, (ft)

CF = centrifugal force (lb)

$N$  = revolutions per minute.

Equating forces and substituting  $\cos(\beta) = 1.0$  at top dead center gives:

$$r = \frac{v^2}{3600 \text{ g}} \quad [7.37]$$

and for  $v = 2\pi Nr$ :

$$r = \frac{(2\pi Nr)^2}{3600 \text{ g}} \quad [7.38]$$

and

$$N = \left( \frac{3600 \text{ g}}{4\pi^2 r} \right)^{0.5} = \frac{54.19}{r^{0.5}} \quad [7.39]$$

If the elevator empties into a chute, the trajectory to determine chute placement is calculated from:

$$s_v = 0.5 \text{ gt}^2 \quad [7.40]$$

$$s_h = v_o t \quad [7.41]$$

where:

$s_v$  = vertical displacement (ft)

$s_h$  = horizontal displacement (ft)

$v_o$  = initial velocity (ft/s)

$g$  = acceleration from gravity = 32.2 ft/s<sup>2</sup>

$t$  = time (s).

The distance of the chute from the vertical center of the head pulley must be sufficient to allow the buckets to clear the wall of the elevator on the downward leg. The differential velocity of the inner and outer lips of the bucket must not be large, or the product at the outer lip may discharge too early and hit the top of the head and fall back to the boot.

The power to operate a bucket elevator can be estimated from:

$$P_{\text{hp}} = \frac{QH}{33000} \quad [7.42]$$

where:

$P_{\text{hp}}$  = horsepower, (hp)

$Q$  = amount of material handled, (lb/min)

$H$  = lift, (ft).

This value should be increased by 10% to 15% to account for friction losses and the power required to move buckets through stationary grain and to accelerate the grain.

#### 4.4 Pneumatic Conveyors

Pneumatic conveyors use air to transport materials through a closed duct or tube. As the only moving parts are fans and feeders, they are mechanically reliable. The conveying path is not fixed and pneumatic systems can branch. The basic types of pneumatic conveyors are dilute phase and dense phase conveyors, which differ by pressure and air speed. Dense phase conveyors are run by compression, and are used for conveying mainly heavier material loadings. Because of this, these convey at a slower rate than dilute phase conveyors, which convey by creating a vacuum. This method is used to convey smaller, lighter materials. Low pressure systems are usually powered by centrifugal fans. High pressure systems typically use positive displacement blowers. Vacuum systems are well suited for unloading when the location is not fixed. Pressure systems are more efficient than vacuum systems and are best suited for stationary applications. In vacuum units, the blower pulls both grain and air through the receiving tube. Before the grain reaches the blower, a cyclone separator is used to separate the grain and the air.

An advantage of pneumatic conveyors is their ability to reach out of the way locations that would otherwise require several augers connected in series. Pneumatic conveyors are especially suited for flat storage systems because this type of storage is much more difficult to unload using augers than conventional grain bins. Dust and shoveling are minimized and a single worker can operate the unit during unloading. Mechanical parts are at ground level and easy to maintain. The units are self-cleaning and relatively safe in that moving parts are not exposed (Hellevang, 1985). They are much safer than portable augers. Working near the intake nozzle in a confined area can be virtually dust-free; however, working near the discharge can be extremely dusty. The use of ear protection is recommended because of the excessive noise at the discharge.

Pneumatic conveyors have a major disadvantage in that considerably more energy is required per unit of grain transported than many other grain handling systems. For similar capacities, much larger power requirements are needed, and often on-farm

units are powered through tractor driven PTOs. Grain damage and dust associated with pneumatic conveying are similar to that of bucket elevators and drag conveyors where velocities are 4000 ft/min or less. However, damage increases exponentially for higher velocities.

Some low cost systems feed grain through the fan, but grain damage is high for these systems and damage to the fan is also a problem. Grain handling systems should utilize feeders. Separation devices such as cyclones are used at the exit end to separate grain from air. Conveying air, after it has been separated from the grain in the separator cyclone, is filtered or passed through a screen before entering the blower.

Movement of grain through a pneumatic system is driven by air velocity. Henderson and Perry (1976) give an air rate of 15–50 ft<sup>3</sup>/lb for most grain applications. The required air velocity depends largely on the bulk density of the material being conveyed. A range of 60–100 ft/s is generally recommended for most farm conveying applications. The air velocity in turn determines the airflow rate (ft<sup>3</sup>/s) and the diameter of the piping. The air velocity also determines the type of grain flow pattern within the pipe. Grain in conveyor tubes will flow in varying patterns depending on velocities and tube dimensions:

1. Grain totally suspended in the air mass.
2. Grain settling out, forming dunes and then moving along the bottom of the pipe.
3. Grain settling out, forming blockages and moving out in slugs when the pressure builds up.

The capacity of a pneumatic conveyor depends on the ability of the blower to provide adequate suction and discharge pressures to overcome losses:

1. Air friction losses at the intake entrance.
2. Air friction losses in the pipe. These losses depend on pipe length, diameter, type and bends in the pipe network.
3. Losses produced by grain on wall friction and grain on grain friction of grain moving in horizontal pipes and around bends.
4. Losses caused by energy required to accelerate grain.
5. Losses caused by the energy required to lift grain through elevation differences in the system.
6. Air friction losses in separation devices such as cyclones. Cyclones dissipate the energy of the air and grain mixture which causes the grain to separate from the air.

Systems that use a series of elbows soon after the airlock can have capacity problems because the grain is not allowed to get up to speed before making a turn. At least 10 ft of straight tube is required at the airlock transition outlet before the first elbow is installed. Keep at least 8 ft of straight length between elbows to maintain conveying velocity.

Relationships based on fluid mechanics theory are available and describe the qualitative behavior of pneumatic conveying systems, but pressures predicted by theory are currently not accurate enough for design purposes, so practical systems are designed based on empirical relationships.

## 4.5 Chutes

When suitable elevation differences exist, granular materials can be transported using chutes by means of gravity (Figure 7.11). Chutes are low cost, but must have sufficient slope to reliably start operating and not to clog with damp material or trash. Chutes should not converge because changes in chute cross-section area can stop grain from sliding. For agricultural grains and most biomass, chutes require a slope of at least  $30^\circ$  from horizontal. In general, the chute slope should exceed the angle of repose of the material. As chute slope increases, the elevation difference between origin and end point increases, resulting in increased structural costs. As slope increases, particle velocities increase and greater particle damage occurs. Grain seed coats are often abrasive and, over time, moving grain can cause significant wear and will often cut through steel at impact points. The best chute design is a compromise between construction costs, reliability, and particle damage.

## 4.6 Grain Cleaning

Cleaning is the removal of foreign material from grain. Combines separate straw and large foreign items from grain, but large quantities of short straw segments, chaff, and other foreign material remain mixed with grain when it arrives for drying or storage. Grain quality is based in part on absence of trash and trash interferes with flow of grain in conveying devices and with heat and mass transfer during drying. Trash usually contains weed seeds that are undesirable when grain is to be used for seed.

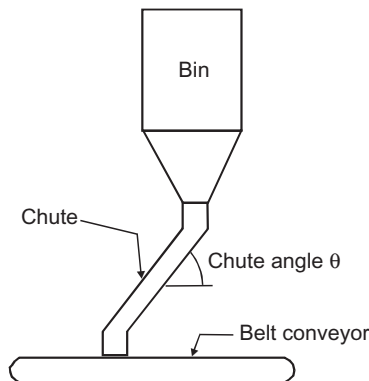


Figure 7.11 Chute emptying bin onto belt conveyor.

Cleaning is based on differences in physical properties between grain and undesirable material. Grain can also be sorted into grades by cleaning devices. Some properties that can be used to clean or sort grain include (Hall, 1963; Henderson and Perry, 1976; Vaughan *et al.*, 1968):

1. Size.
2. Shape.
3. Density.
4. Coefficient of friction.
5. Surface characteristics.
6. Optical properties – reflectivity and color.
7. Electrical characteristics.

The most commonly used property is size and the most common sorting device is the screen or sieve. Screening refers to the separation of material into two or more size fractions. When only a few large particles are removed in an initial process, the process is known as scalping. Screens combined with an air blast can effectively clean grain for most purposes. Screens are suspended so that they can be oscillated in both horizontal and vertical directions. The combined oscillations cause the grain to stir the grain as it moves down a screen. A fanning mill as shown in Figure 7.12 is a type of cleaner that combines screening with air separation. Air separation is based on differences in density between grain and trash as governed by:

$$CRe^2 = \frac{2 gwd^2\gamma(\gamma_p - \gamma)}{\mu^2 A\gamma_p} \quad [7.43]$$

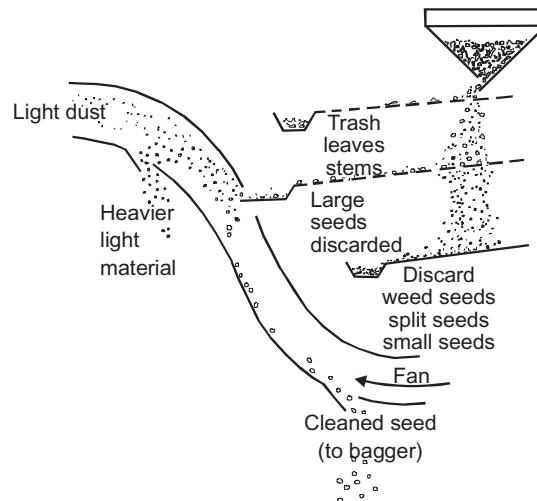


Figure 7.12 *Fanning mill.*

where:

- A = projected area of particle, (ft<sup>2</sup>)
- $\gamma$  = fluid specific density, (lb/ft<sup>3</sup>)
- $\gamma_p$  = particle specific weight, (lb/ft<sup>3</sup>)
- C = particle drag coefficient
- Re = Reynold's number
- g = acceleration of gravity, (ft/s<sup>2</sup>)
- d = average particle diameter, (ft)
- $\mu$  = fluid viscosity, (lb/ft-s).

Spiral separators and disc separators are widely used to grade seed. Spiral separators separate material based on shape. They consist of a helix shaped trough. Material is introduced at the top and as round particles accelerate, they roll over the edge of the helix. The round particles are caught in an outer trough and are collected. Spiral separators are very useful for separating round grains such as soybeans, canola, or mustard from similar sized trash.

Disc separators separate grain based on grain length. The disc is mounted on a rotating horizontal shaft. The side of the disc facing the moving grain is notched with pockets just smaller than the size of the desired grain. As material moves past a disc, short grain and trash are picked up and clean grain continues past the disc. A series of discs mounted on the shaft can be used to sort for several sizes of seed in sequence.

### 5. TESTERS FOR MEASURING FLOW PROPERTIES

There are many testers for measuring flow properties of particulate systems. These testers are generally called granular flow testers or granular shear testers. Most of these testers have been adopted from civil engineers who have been using them for over a century. Some of the testers which are shown for completeness in [Figure 7.13](#) are not

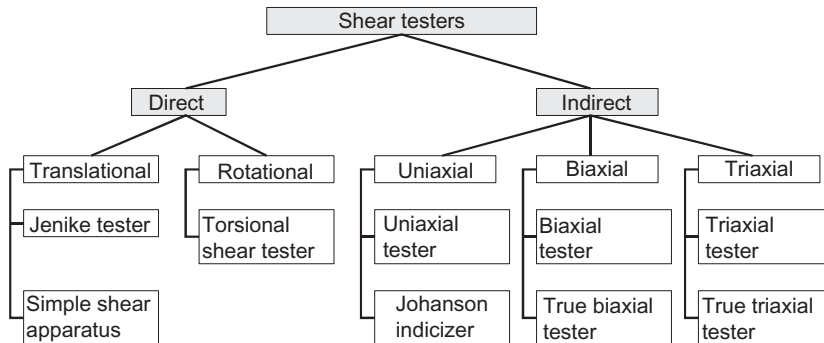


Figure 7.13 Classification of shear testers.

suitable for free flowing granular materials because the principle of their operation only supports cohesive materials, these are the uniaxial tester and Johanson indicizer. It must also be pointed out that some of the testers cannot be used in their existing form for free flowing granular materials such as grains because of particle size effects on the measurements. A larger version of the testers is necessary for such measurements. For example a 4.0 in. diameter and 8.0 in. high cylindrical specimen can be used in a triaxial test instead of 2.8 in. diameter and 5.6 in. high cylindrical specimens. The rule of thumb to minimize particle size effects is to have the diameter of the specimen to be at least six times larger than the diameter of the largest particle,  $D_{\text{spec}}/D_{\text{particle}} > 6.0$ . A ratio of  $D_{\text{spec}}/D_{\text{particle}} > 10.0$  is even better if there are no size restrictions in modifying the device.

## 5.1 Classification of Flow Testers

Testers fall into the two main categories of direct or indirect shear testers as shown in Figure 7.13. In direct shear testers, the location of the shear zone or shear plane is determined by the design of the tester; whereas, in indirect shear testers, the powder develops its own shear plane or shear zone before failure due to the state of stress.

## 5.2 Examples of Flow Testers

Many different kinds of flow testers are commercially available that allow the determination of some measure of flowability. Examples are, but not limited to, translational shear testers like the Jenike's shear cell (Figure 7.14), rotational shear testers like Schulze ring shear tester (Figure 7.15), the Walker ring shear tester and Peschl rotational shear tester (Figure 7.16), and the uniaxial testers. There are a few other flow testers that are used for research purposes and are owned by a handful of research institutions worldwide, such as the biaxial tester and true triaxial tester. These testers are extremely complicated to build and to operate and they have not been developed to a stage of practical utility. A true triaxial tester can cost over half a million dollars. The Jenike shear tester is probably one of the most popular shear testers and is widely used in industry. All of these testers provide some information on flowability. Also,

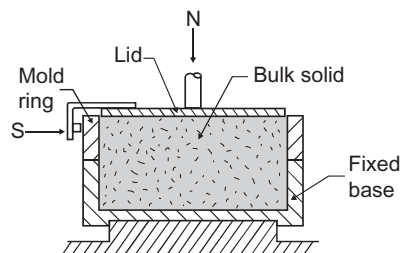


Figure 7.14 Jenike shear tester.

they can be used in any situation where two granular materials are to be compared for flowability. They can also be used for quality control. They provide the major principal stress at steady flow,  $\sigma_1$ , also called the major consolidation stress and provide the unconfined yield strength,  $\sigma_c$ . These can be plotted on Mohr's circle and then the yield locus and effective yield locus can be plotted. Each preconsolidation load yields one yield locus and this preconsolidation corresponds to a certain bulk density,  $\rho_b$ . A plot of the unconfined yield strength,  $\sigma_c$ , versus the major principle stress at steady flow,  $\sigma_1$ , yields what is defined as the flow function,  $\sigma_c = f(\sigma_{1,c})$ . The flow function is an indicator of flowability. Many of the commercially available devices are empirical in nature and the flow parameters obtained are based on assumptions to some extent. They do not provide enough information for the formulation of a general 3-D constitutive model. In addition, most of these devices evaluate whether granular materials

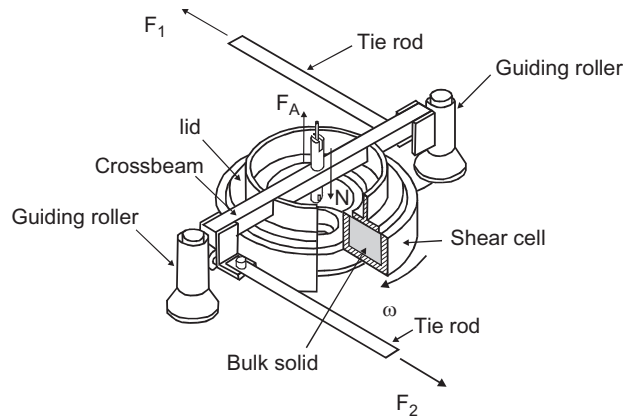


Figure 7.15 Ring shear tester of Schulze.

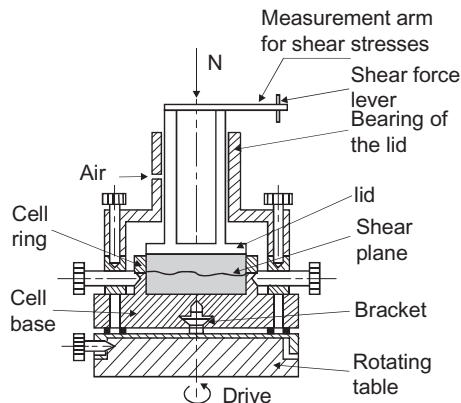
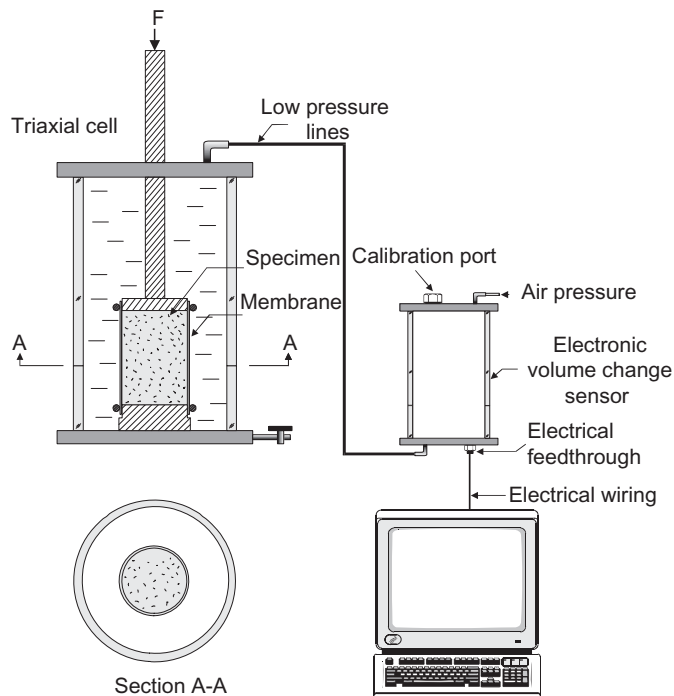


Figure 7.16 Rotational shear tester of Peschl.



flow or not but are unable to predict conditions when the powder is partially flowing and partially stationary. An extensive review of these testers can be found in [van der Kraan \(1996\)](#) and [Schweddes \(1999\)](#). The triaxial tester is another tester that could be potentially useful as a granular flow tester; however, in its currently available form, is not suitable for the study of dry free flowing granular materials. Enhancements of the triaxial cell, which is an indirect shear tester, are available ([Abdel-Hadi, 2000, 2002a, 2002b](#); [Haaker and Rademacker, 1982](#)). One type of enhanced triaxial cell is shown in [Figure 7.17](#) ([Abdel-Hadi, 2000](#)). The classical triaxial cell was invented about a century ago with the purpose of characterizing soil behavior over a range of pressures of interest in civil engineering and mining applications. Most of these triaxial shear testing devices use the specimen in a wetted or saturated form; however, this might interfere with, or change, the inherent properties of free flowing granular material. In addition, they were designed to operate under elevated pressures that are applicable to geomechanics. This motivated the development of enhanced triaxial cells that can operate at low confining pressures. A new volume change device has also been developed applicable to low confining pressures. Accurate volume changes can be used to obtain the volumetric strain, which combined with the axial strain, can be



**Figure 7.17** *New setup for performing triaxial tests under very low confining pressures and a new method for volume change measurement.*

used to obtain the volumetric strain, which combined with the axial strain, can be used to calculate the lateral strain (Abdel-Hadi *et al.*, 2000, 2002; Abdel-Hadi and Cristescu, 2002).

### 5.3 Modeling of Granular Materials

This section focuses on methods for solving boundary value problems using both analytical and computational techniques for granular materials. The analytical approach involves the use of classical continuum mechanics to develop continuum constitutive equations that describe the stress-strain relationships. The prediction of stresses in static and flowing granular materials in either a shear cell or a bin and hopper or a process requires complex constitutive models. The determination of the mechanical properties of granular materials plays a major role in developing constitutive models that lead to the understanding and solving problems associated with storage, flow, transportation, and handling of granular materials. Compaction, rat-hole formation, funnel flow, bridging and arching are examples of problems encountered in storage facilities. The currently available design procedures for bins and hoppers are based on semi-empirical analyses developed by Jenike (1961, 1964, and 1967), Jenike *et al.* (1973a), and Johanson (1965, 1968). In many cases, robust constitutive equations are not available, and if they exist sometimes are of limited use and reliability. Developing these constitutive equations is not an easy task. Robust and reliable constitutive equations are needed to model the complex behavior of particulate materials; however, these equations are only as good as the extent to which the physical phenomena are understood and simulated. Therefore, for a constitutive model to be successful, two criteria have to be fulfilled.

First, if the material exhibits instantaneous (elastic) behavior, the response must be determined. In this case, the relevant elastic parameters have to be identified and experimentally determined as precisely as possible following an experimental procedure insuring that just “the elastic parameters” are measured. This task is generally not easy and it requires intuition and insight into the problem. The main reason is that the deformation of granular materials is strongly time dependent and it is not easy to distinguish by test between the elastic and the time dependent deformations. Secondly, the functional relationships between the parameters have to be established. Some of these parameters are coupled, e.g. creep and dilatancy, dilatancy and creep failure, dilatancy and permeability.

Presently, there is no generally acknowledged theory of particulate matter based on first principles. As opposed to solids, gases, and liquids where such theories exist, only fragments of a theory are available. In other words, there are no general constitutive equations that describe the behavior of all particulate materials. There is not even a general constitutive equation for one material. Each constitutive model is only good for a given material for a specific preconsolidation and for particles of specific shapes

and specific mean size and size distribution. Even if the mean size is the same for two samples, but the distribution is different, different constitutive equations describe their behavior.

One way to finetune the model is by the accurate determination of the relevant elastic parameters. Thus, the main objective in developing constitutive models is to develop or implement advanced measurement techniques, using high precision instruments and improved experimental methodologies.

The ultimate goal is to develop constitutive models that describe the complex rheology of granular materials. Such models have to reproduce the principal features of the mechanical response of granular materials. This response is essentially non-linear and depends on both the loading and time histories.

As for soils, granular materials tend to change in volume under shear load, but their volumetric changes are different from those of soils. Soils always exhibit both compressibility and dilatancy. The volumetric behavior of granular materials strongly depends on the particle size and cannot be eliminated by homogeneity.

Certain similarities in the mechanical behavior of soils and granular materials have resulted in the adaptation of models from soil mechanics and geomechanics to granular mechanics. Usually, the models are based on the experimental data obtained in hydrostatic and triaxial compression tests, and differ by the hardening rules, yield surfaces and visco/plastic potentials (Cristescu and Hunsche, 1998). Naturally, the choice of a model is defined by the mechanical behavior of the material observed in the experiments as well as by the needs of the follow-up applications of the model.

Computer simulations are ideal for observing granular structures both under static and dynamic loading conditions that are currently not possible even with sophisticated experimental techniques. They are also ideal when constitutive equations are not available and when they are questionable. They give an insight into the behavior of a system of particles as a bulk and also an insight on the particulate level. A recent review by Savage (1998) on modeling both analytical and computational for solving boundary value problems in granular materials critically examines such approaches. With the advent of new computer technology and the availability of powerful desktop computers, the computational techniques for simulating static and dynamic granular behavior are getting faster and cheaper.

Finite element and finite difference approaches can be used to solve the constitutive equations mentioned above when they cannot be solved by analytical means. One of the commercially available packages that can be implemented for granular materials is ABAQUS (ABAQUS<sup>®</sup> is a registered trademark or trademark of ABAQUS, Inc). It contains an extensive library that covers linear, non-linear, isotropic, and anisotropic materials. It also contains constitutive models for a wide range of materials, it also allows your own material model to be written and run with ABAQUS.

Molecular dynamics is one of the best numerical methods for the simulation of granular systems. Initially, molecular dynamics was developed for the numerical simulation of gases and fluids on the molecular level. Later molecular dynamics was adopted for granular systems. The simulations are limited to about 20,000 particles on a personal computer. Models can run over real time for some seconds to some minutes. A good modern reference for the subject is [Pöschel and Schwager \(2005\)](#). It contains models and readily usable algorithms, and serves as an introduction to the application of molecular dynamics. Early work in the subject has been done by [Cundall and Strack \(1979\)](#), [Haff and Werner \(1986\)](#), [Gallas \*et al.\* \(1992\)](#), [Walton and Braun \(1986\)](#), and others.

Discrete element simulation (DES) methods are the offspring of molecular dynamics ([Herrmann, 1995](#); [Walton, 1993](#)). These simulations are limited to  $10^4$ – $10^5$  particles. The complexity of the particle interaction laws used in DES determines the intensity of the computer simulations and thus the limitation on the number of particles that can be practically simulated. If the particle interaction laws are relaxed, a larger number of particles can be simulated but at the expensive of less realistic simulations. The relaxation of these laws will eventually lead to models of hundreds of thousands of particles that would provide qualitative rather than quantitative results. A number of 2-D simulations have been performed using discs rather than spheres for 3-D simulations, but again the results are qualitative and are only suitable to accurately model a few industrial processes. DES uses the constitutive development described above or continuum finite element and finite difference computations for the bulk, and consequently simple particle interaction laws must be deduced that are needed for DES codes. DES is a powerful tool that can be used to satisfy two objectives: i) direct simulation, and ii) develop constitutive equations for cases where the constitutive equations are difficult to be developed by experimental means ([Boac \*et al.\*, 2010](#); [González-Montellano \*et al.\*, 2010](#)).

Cellular automata (CA) is a simple form of molecular dynamics. The particles are allowed to interact in a rather simplified and limited way. CA was originally developed to increase computational efficiency. Care must be taken that assumptions are not oversimplified, or erroneous results can occur. On the other hand, if the complexity of particle–particle interaction rules is increased then it evolves to the DES approach described above. This method is favored more for its qualitative rather than quantitative results ([Savage 1993](#)).

## REFERENCES

- [Abdel-Hadi, A.I., Cristescu, N.D., 2002. A new experimental setup for the characterization of bulk mechanical properties of aerated particulate systems. Part. Sci. Technol. 20 \(3\), 197–207.](#)  
[Abdel-Hadi, A.I., Cristescu, N.D., Cazacu, O., Bucklin, R., 2000. Development of a New Technique for Measuring Volume Change of Dry Particulate Systems under Very Low Confining Pressures.](#)

- IMECE: Recent Trends in Constitutive Modeling of Advanced Materials, AMD-Vol. 239, pp.65–77, November 5–10. (Orlando, Florida, USA).
- Abdel-Hadi, A.I., Zhupanska, O.I., Cristescu, N.D., 2002. Mechanical properties of microcrystalline cellulose. Part I. Experimental results. *Mech. Mater.* 34 (7), 373–390.
- ACI, 1997. ACI313-97 / 313R-97: Standard Practice for Design and Construction of Concrete Silos and Stacking Tubes for Storing Granular Materials and Commentary. American Concrete Institute, Detroit, MI.
- AISC, 2011. Steel Construction Manual, fourteenth ed. American Institute of Steel Construction, Chicago, IL.
- AISI, 2008. Cold-Formed Steel Design Manual. American Iron and Steel Institute, Washington, DC.
- ASAE, 2012a. Loads Exerted by Free-Flowing Grain on Bins. ANSI/ASAE EP433. ANSI/ASAE EP545. American Society of Agricultural and Biological Engineers, St Joseph, MI.
- ASAE, 2012b. Moisture Relationships of Plant-Based Agricultural Products. ASAE D245.5. American Society of Agricultural and Biological Engineers, St Joseph, MI.
- ASAE, 2012c. Thermal Properties of Grain and Grain Products. ASAE D243. American Society of Agricultural and Biological Engineers, St Joseph, MI.
- ASAE, 2012d. Loads Exerted by Free-Flowing Grains on Shallow Storage Structures. ANSI/ASAE EP545, St. Joseph, Mi. 49085.
- ASAE, 2012e. Procedure for Establishing Volumetric Capacities of Cylindrical Grain Bins. ASAE S413, St. Joseph, Mi. 49085.
- ASAE, 2012f. Density, Specific Gravity, and Mass-Moisture Relationships of Grain for Storage. ANSI/ASAE D241.4, St. Joseph, Mi. 49085.
- ASCE, 2005. ASCE 7-05. Minimum Design Loads for Buildings and Other Structures. ASCE, Reston, Va, 20191-4400.
- Boac, J.M., Casada, M.E., Maghirang, R.G., Harner III, J.P., 2010. Material and interaction properties of selected grains and oilseeds for modeling discrete particles. Citation: *Trans. ASABE* 53 (4), 1201–1216.
- Blight, G.E., 1985. Temperature changes effect pressures in steel bins. *Int. J. Bulk Solids Storage Silos* 1 (3), 1–7.
- Blight, G.E., 1988. Design loads for grain silos-intention and reality. ASAE Paper No. 88-4024. St. Joseph, MI. 49085.
- Blight, G., 2006. *Assessing Loads on Silos and Other Bulk Storage Structures: Research Applied to Practice*. Taylor & Francis.
- Boumans, G., 1985. *Grain Handling and Storage*. Elsevier, Amsterdam.
- Brooker, D.B., Bakker-Arkema, F.W., Hall, C.W., 1992. *Drying and Storage of Grains and Oilseeds*. An AVI book, Van Nostrand Reinhold, New York.
- Brown, C.J., Nielson, J., 1998. *Silos, Fundamentals of Theory, Behavior and Design*. E & F N Spon, London.
- Bucklin, R.A., Thompson, S.A., Ross, I.J., Biggs, R.H., 1989. Apparent coefficient of wheat on bin wall material. *Trans. ASAE* 32 (5), 1769–1773.
- Bucklin, R.A., Molenda, M., Bridges, T.C., Ross, I.J., 1996. Slip-stick frictional behavior of wheat on galvanized steel. *Trans. ASAE* 39 (2), 649–653.
- Buzek, J.R., 1989. *Useful Information on the Design of Steel Bins and Silos*. American Iron and Steel Institute, Washington, D. C..
- CEMA, 2009. *Classification and Definitions of Bulk Materials*, CEMA/ANSI 550. Conveyor Equipment Manufacturers Association, Naples, FL, [www.cemanet.org](http://www.cemanet.org).
- Christensen, C.M., Kaufmann, H.H., 1974. Microflora. In: Christensen, C.M. (Ed.), *Storage of Cereal Grains and Their Products*, second ed. Amer. Assoc. of Cereal Chemists, St. Paul, MN.
- Cristescu, N.D., Hunsche, U., 1998. Time Effects in Rock Mechanics. John Wiley, Chichester, p. 342.
- Cundall, P.A., Strack, O.D.L., 1979. A discrete numerical model for granular assemblies. *Géotechnique* 29, 47.
- DIN, 1987. Lastannahmen für bauten-lasten in silozellen (Design loads for buildings-loads in silos). DIN 1055, Teil 6. Deutsche Normen, Berlin.

- ECCS, 1996. Eurocode 1 (ENV1991-4) Basis of Design and Actions on Structures. Part 4: Actions in Silo and Tanks. European Committee for Standardization, Brussels.
- Gallas, J.A.C., Herrman, H.J., Sokolowski, S., 1992. Convection cells in vibrating granular media. *Phys. Rev. Lett.* 69, 1371.
- Gaylord Jr., E.H., Gaylord, C.N., 1984. Design of Steel Bins for Storage of Bulk Solids. Prentice-Hall, Inc., Englewood Cliffs, N.J.
- González-Montellano, C., Ramírez, A., Gallego, E., Fuentes, J.M., Ayuga, F., 2010. Discrete element modeling of a 3D scale silo with hopper. ASABE Paper No. 10-09676. St. Joseph, MI. 49085.
- Haaker, G., Rademacker, F.J.C., 1982. Direct measurement of the flow properties of bulk solids by a modified triaxial tester. Second European Symposium Storage and Flow of Particulate Solids, Working Party on the Mechanics of Particulate Solids. March 18–19, Braunschweig.
- Haff, P.K., Werner, B.T., 1986. Computer simulation of the mechanical sorting of grains. *Powder Technol.* 48, 239.
- Hall, C.W., 1963. Processing Equipment for Agricultural Products. AVI Publishing Co., Westport, CT.
- Hellevang, K.J., 1985. Pneumatic Grain Conveyors. North Dakota State University, Fargo, ND, Extension Publication AE850.
- Henderson, S.M., Pabis, S., 1961. Grain drying theory I. Temperature effect on drying coefficient. *J. Agric. Eng. Res.* 6 (3), 169–174.
- Henderson, S.M., Perry, R.L., 1976. Agricultural Process Engineering. AVI Publishing Co., Westport, CT.
- Herrmann, H., 1995. Simulating moving granular media. In: Guazzelli, E., Oger, L. (Eds.), *Mobile Particulate Systems*. Kluwer Academic Publishers, Dordrecht, pp. 281–304.
- Horabik, J., Molenda, M., Thompson, S.A., Ross, I.J., 1993. Asymmetry of bin loads induced by eccentric discharge. *Trans. ASAE* 36 (2), 577–582.
- Horabik, J., Weiner, W., 1998. Operations on Granular Materials Institute of Agrophysics. Polish Academy of Sciences, Lublin, Poland.
- ICC, 2009. International Building Code. International Code Council, Falls Church, VA.
- Janssen, H.A., 1895. Versuche über getreidedruck in silozellen. *Zeitschrift, Verein Deutscher Ingenieure* 39, 1045–1049.
- Jenike, A.W., 1961. Gravity Flow of Bulk Solids. Utah Engineering Experimental Station, University of Utah, Bulletin 108.
- Jenike, A.W., 1964. Storage and Flow of Solids. Utah Engineering Experimental Station, University of Utah, Bulletin 123.
- Jenike, A.W., 1967. Quantitative design of mass flow bins. *Powder Technol.* 1, 237.
- Jenike, A.W., Johanson, J.R., Carson, J.W., 1973a. Bin loads – Part 2: Concepts. *Trans. ASME, Ser. B* 95 (1), 1–5.
- Jenike, A.W., Johanson, J.R., Carson, J.W., 1973b. Bin loads – Part 3: Mass flow bins. *Trans. ASME, Ser. B* 95 (1), 6–12.
- Jenike, A.W., Johanson, J.R., Carson, J.W., 1973c. Bin loads – Part 4: Funnel-flow bins. *Trans. ASME, Ser. B* 95 (1), 13–16.
- Johanson, J.R., 1965. Method of calculating rate of discharge from hoppers and bins. *Trans. Soci. Min. Eng.* 232, 69–80.
- Johanson, J.R., 1968. The placement of inserts to correct flow in bins. *Powder Technol.* 1, 328–333.
- Kebeli, H.V., Bucklin, R.A., Ellifritt, D.S., Chau, K.V., 2000. Moisture induced pressures and loads in grain bins. *Trans. ASAE* 43 (5), 1211–1221.
- Kebeli, H.V., Bucklin, R.A., Reinhold, T., Gurley, K.R., 2001. Wind tunnel test to establish pressure coefficient for grain bins. ASAE Paper No. 01-4017.
- Ketchum, M.S., 1907. *The Design of Walls, Bins and Grain Elevators*. McGraw-Hill, New York, New York.
- Liu, Q., Cao, C., Bakker-Arkema, F.W., 1997. Modeling and analysis of mixed-flow grain dryer. *Trans. ASAE* 40 (4), 1099–1106.
- Loewer, O.J., Bridges, T.C., Bucklin, R.A., 1994. On-Farm Drying and Storage Systems. American Society of Agricultural Engineers, St Joseph, MI 49085.

- Macdonald, P.A., Kwok, K.C.S., Holmes, J.D., 1988. Wind loads on circular storage bins, silos and tanks: I. Point pressure measurements on isolated structures. *J. Wind Eng. Ind. Aerodyn.* 31, 165–188.
- Marks, B.P., Maier, D.E., Bakker-Arkema, F.W., 1993. Optimization of a new in-bin counterflow corn drying system. *Trans. ASAE* 36 (2), 529–534.
- McKenzie, B.A., Foster, G.H., DeForest, S.S., 1967. *Dryeration and Bin Cooling Systems for Grain*. AE-107, Cooperative Extension Service, Purdue University, W. Lafayette, IN.
- Mittal, G.S., Otten, L., 1980. Simulation of Low-Temperature Drying of Corn for Ontario Conditions. ASAE, St. Joseph, MI, Paper No. 80-3519.
- Mohsenin, N.N., 1986. *Physical Properties of Plant and Animal Materials*. Gordon and Breach Publishers, New York.
- Molenda, M., Horabik, J., Ross, I.J., Montross, M.D., 2002. Friction Of Wheat: Grain—on Grain and on Corrugated Steel. *Trans. ASAE* 45 (2), 415–420.
- Moreira, R.G., Bakker-Arkema, F.W., 1990. Unsteady state simulation of a multistage concurrent-flow maize dryer. *Drying Tech.* 8 (1), 61–75.
- Morey, R.V., Cloud, H.A., Gustafson, R.J., Petersen, D.W., 1979. Evaluation of the feasibility of solar energy grain drying. *Trans. ASAE* 22, 409–417.
- Moya, M., Ayuga, F., Guaita, M., Aguado, P., 2002. Mechanical properties of granular agricultural materials. *Trans. ASAE* 45 (5), 1569–1577.
- Moya, M., Guaita, M., Aguado, P., Ayuga, F., 2006. Mechanical properties of granular agricultural materials, Part 2. *Trans. ASABE* 49 (2), 479–489.
- Moysey, E.B., 1989. Design and development of hopper-bottomed grain storages. In: Doald, V.A., Grace, P.M. *Proceeding of the Eleventh International Conference on Agricultural Engineering*, September, Dublin.
- Moysey, E.B., Landine, P.G., 1982. Effect of Change in Bin Cross-Section on Wall Stresses. ASAE, St. Joseph, MI. 49085, ASAE Paper No. 82-4073.
- MWPS, 1988. *Grain Drying, Handling and Storage Handbook*, MWPS-13. Midwest Plan Service, Ames, IA.
- Navarro, S., Noyes, R. (Eds.), 2002. *The Mechanics and Physics of Modern Grain Aeration Management*. CRC Press, Boca Raton, FL.
- Nelson, G.L., Manbeck, H.B., Meador, N.E., 1988. *Light Agricultural and Industrial Structures*. Van Nostrand Reinhold Company, Inc., New York, New York.
- Newman, A.B., 1931. The drying of porous solids: diffusion calculations. *Trans. Am. Inst. Chem. Eng.* 16 (3), 310–333.
- Pöschel, T., Schwager, T., 2005. *Computational Granular Dynamics*. Springer.
- Roberts, A.W., 1995. 100 years of Janssen. *Bulk Solids Handling* 15 (3), 369–383, July–Sept.
- Ross, I., Hamilton, J.H.E., White, G.M., 1973. *Principles of Grain Storage*. AEN-20. University of Kentucky, Lexington, KY, [http://www.bae.uky.edu/Publications/GrainStorage\\_pubs.asp](http://www.bae.uky.edu/Publications/GrainStorage_pubs.asp).
- Ross, I.J., Bridges, T.C., Schwab, C.V., 1987. Vertical wall loads on conical grain bins. *Trans. ASAE* 30 (3), 753–760.
- Rotter, J.M., 1988. Structural design of light-gauge silo hoppers. *ASCE: J. Struct. Eng.* 116 (7), 1907–1922, ASCE, Reston, VA.
- Rotter, J.M., 2001. *Guide for the Economic Design of Circular Metal Silos*. Spon Press.
- Safarian, S.S., Harris, E.C., 1985. *Design and Construction of Silos and Bunkers*. Van Nostrand Reinhold, New York, New York.
- Savage, S.B., 1993. Disorder, diffusion and structure formation in granular flow. In: *Disorder and Granular Media*, North Holland Amsterdam, pp. 255–285.
- Savage, S.B., 1998. Modeling and granular material boundary value problems. In: Herrmann, H.J., et al., (Eds.), *Physics of Dry Granular Media*. Kluwer Academic Publishers, pp. 25–96.
- Schulze, D., 2008. *Powders and Bulk Solids: Behavior, Characterization, Storage and Flow*. Springer.
- Schwab, C.V., Curtis, R.A., Thompson, S.A., Ross, I.J., 1991. Vertical loading of temperature cables. *Trans. ASAE* 34 (1), 269–274.
- Schwab, C.V., Thompson, S.A., Williams, R.A., Ross, I.J., 1992. Temperature cable load comparison between model and full-scale grain bins. *Trans. ASAE* 35 (1), 297–302.

- Schwedes, J., 1999. Testers for measuring flow properties of particulate solids. Proceedings Reliable Flow of Particulate Solids III. August 11–13, 1999, Porsgrunn, Norway, pages 3–40.
- SSA, 2001. Structural/Seismic Design Manual - Volume 1. Code Application Examples. Structural Engineers Association of California, Sacramento, CA.
- Standards Australia, 1989. Minimum Design Loads On Structures: Australian Wind Loading Code. The Crescent, Homebush, NSW, Australia, AS1170.2.
- Standards Australia, 1996. Loads on Bulk Solids Containers. Standards Australia, Homebush, NSW, Australia, AS 3774-1996.
- Thomson, F.R., Fayed, M.E., Otten, L. (Eds.), 1984. Handbook of Powder Science. Van Nostrand, Reinhold, New York.
- Thompson, S.A., Ross, I.J., 1983. Compressibility and frictional coefficients of wheat. Trans. ASAE 26 (4), 1171–1176.
- Thompson, S.A., Ross, I.J., 1984. Thermal stresses in steel grain bins using the tangent modulus of grain. Trans. ASAE 27 (1), 165–168.
- Thompson, S.A., Bucklin, R.A., Batich, C.D., Ross, I.J., 1988. Variation in the apparent coefficient friction of wheat on galvanized steel. Trans. ASAE 31 (5), 1518–1524.
- Thompson, S.A., McNeill, S.G., Ross, I.J., Bridges, T.C., 1990. Computer model for predicting the packing factors of whole grains in flat storage structures. Appl. Eng. Agric. 6 (4), 465–470.
- Thompson, S.A., Schwab, C.V., Ross, I.J., 1991. Forces on temperature cables in a model bin under restrained conditions. Trans. ASAE 34 (5), 2187–2192.
- Thompson, S.A., Molenda, M., Ross, I.J., Bucklin, R.A., 1998. Loads caused by bottom unloading wall flumes in a model grain bin. Trans. ASAE 41 (6), 1807–1815.
- Thompson, T.L., Foster, G.H., Peart, R.M., 1969. Comparison of Concurrent-Flow, Crossflow, and Counterflow Grain Drying Methods. USDA, Washington, DC, Market Research Report 341.
- USDA. 1977. Grain inspection manual. United States Federal Grain Inspection Service. 3.19.
- van der Kraan, M., 1996. Techniques for the Measurement of Flow Properties of Cohesive Powders. Master's Thesis. Copy Print 2000, Enschede.
- Van Zanten, D.C., Richards, P.C., Mooj, A., 1977. Bunker Design, Part 3: wall pressures and flow patterns in funnel flow. Trans. ASME, Ser. B, 819–823.
- Vaughan, C.E., Gates, B.R., DeLouche, J.C., 1968. Seed Processing and Handling. Seed Technology Laboratory. Mississippi State University, Mississippi State, MS.
- Waller, R.G., Riskowski, G.L., 1989. Analysis of large temporary grain structures. ASAE Paper No. 89-4536. St. Joseph, Mi. 49085.
- Walton, O.R., 1993. Numerical simulation of inelastic, frictional particle particle interactions. In: Rocco, M.C. (Ed.), Particulate Two-Phase Flows. Butterworth Heinemann, Boston, pp. 844–911.
- Walton, O.R., Braun, R.L., 1986. Viscosity, granular temperature, and stress calculations for shearing assemblies of inelastic, frictional disks. J. Rheol. 30, 949.
- Wickstrom, L., 1980. Loads applied to grain bin roofs. ASAE Paper No. 80-4505. St. Joseph, MI.



This page intentionally left blank

# Milking Machines and Milking Parlors

**Douglas J. Reinemann**

University of Wisconsin, Madison, Wisconsin, USA

## 1. INTRODUCTION

A milking machine is a device composed of several parts that, when properly assembled and supplied with a source of energy, will remove milk from an animal's udder and transport milk to a storage vessel. A well-designed system will harvest milk quickly and gently, make efficient use of labor, maintain animal udder health, and will be easy to clean and sanitize. Milking systems have specific requirements regarding slope of pipelines and physical relationships between animals and machines. Other physical relationships, although not absolutely required, will greatly improve the performance of the milking system. The milking machine is typically fitted into a milking parlor, a specialized building where cows are brought to be milked and then returned to their housing areas. A milking parlor facilitates the efficient use of milking labor by providing for cow movement and handling equipment and by positioning cows in way to make the milking process easier. The purpose of this chapter is to explain how a milking machine works, describe each of the components, identify key criteria for milking machine design, discuss special aspects of fitting a milking machine into a milking parlor, and describe various options for milking parlor design.

The success of the milking process is a collaborative effort between the cow, the operator, and the milking facilities. Good milking starts with a clean, healthy, properly prepared cow. Cleanliness is important to avoid transfer of mastitis-causing organisms from the environment to cows' udders and from cow to cow during milking. The ease and speed of cleaning teats is directly related to the cleanliness of cows when they enter the parlor. The animal housing environment thus has direct impact on the efficiency of the milking process. Stimulation prepares cows to release their milk and is important to reduce the time required to harvest milk. Reducing the time that milking units are attached to the cow will improve milking parlor efficiency and reduce teat tissue stress and associated mastitis risk. An effective and efficient milking process is as follows:

- Provide a clean, low stress housing environment for cows.
- Maintain a consistent operating routine for bringing cows to the milking parlor and during the milking process.
- Check foremilk and udder for mastitis.
- Apply an effective pre-milking sanitizer to teats.
- Remove debris and dry teats completely with an individual towel.
- Attach milking unit from 1 to 4 min after the start of stimulation.
- Adjust units as necessary for proper alignment.
- Shut off vacuum when milk flow rate has dropped to a minimal level and remove milking units.
- Apply a post-milking germicide to teats.

Some of these procedures may be automated. None should be eliminated if mastitis prevention and quality milk production are your goals. Pre-milking procedures should be performed in the same manner and order of operation for every milking. The order in which cows are milked can have an impact on controlling the spread of mastitis. By milking mastitis-free first lactation cows first, second and later lactation cows with low somatic cell counts second, cows with high somatic cell counts third, and cows with clinical mastitis last, the chance of spreading mastitis organisms from cow to cow is reduced. The milking parlor should be designed so that the various steps in the milking routine can be performed efficiently and easily, providing cow handling and positioning facilities and convenient locations for the equipment used for cow preparation such as towel dispensers, teat dip cups, or permanently mounted power dipping cups.

## **2. THE MILKING MACHINE**

The milking machine is the most important piece of equipment on a dairy farm. The milk harvesting, cooling, and storage system is used more hours per year than any other equipment on a farm. Proper design, construction, maintenance, and operation of this equipment are essential to harvest and deliver a high-quality product in the most efficient way. The success of any milking machine design depends on an understanding of its function.

The design of the modern milking system is the result of a combination of field experience, trial and error, and controlled research. As milking systems become more complex, particularly in automated milking parlors, there is increasing need for engineering information about milking system design and troubleshooting. The selection, design, and installation of a milk handling system must also consider local, state, and federal health requirements. Milking systems are commonly custom designed for the specific application. However, many of the basic functions and components will be

the same. All types of milking machines have the following basic components and functions:

- A system for vacuum production and control.
- A pulsation system.
- One or more milking units to withdraw milk from the udder.
- An arrangement for transporting milk from the milking unit to a storage facility.
- Milk cooling and storage equipment.
- Additional equipment for cleaning and sanitizing the milking machine after milking.

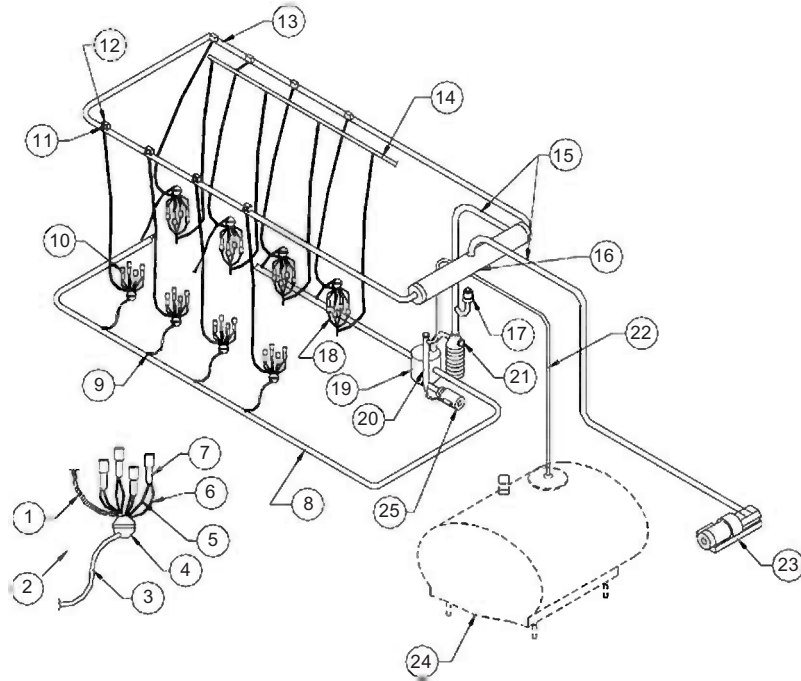
A simplified diagram of a milking system (Figure 8.1) illustrates the flow paths for milk and air through a typical milking system. Note: In this chapter pipes or lines refer to rigid pipes permanently mounted in the milking facility, whereas tubes or hoses refer to flexible tubes that are not permanently fixed to any structure but connect different parts of the milking machine and are movable during the milking operation. Air is continuously removed from the system by the vacuum pump, creating a partial vacuum within the system and the force to withdraw milk from the udder. The air removed by the vacuum pump enters the system at various locations.

Milk enters the milking unit through the teatcups and flows through the short milk tubes to the claw. Air is admitted into the milking unit through an air bleed in the claw or through air vents near the bottom of each teatcup. “Unplanned” air admission occurs through the teatcups as they are attached or removed, or whenever they slip or fall off the cow. A mixture of milk and air moves from each claw, through the long milk tubes, through the milking line to the receiver. In the receiver milk and air are separated and the milk is pumped to the storage tank. Air moves from the receiver, through the sanitary trap and distribution tank toward the vacuum pump in the main airline.

Air enters each pulsator airline in short, regular bursts to create the opening and closing action of the liners. This pulsated air moves through the pulsator airlines to the distribution tank and on to the vacuum pump where it is discharged to the atmosphere. Other unplanned air admission enters as leaks in the pipelines, joints, and fittings. The regulator controls the vacuum level either by adjusting the amount of air admitted into the system (with a constant rate of air removal by the vacuum pump), or by adjusting the capacity of the vacuum pump to match the amount of air admitted into the system.

## 2.1 Milking Unit

The milking unit is the portion of a milking machine for removing milk from an udder. It is made up of a claw, four teatcups, a long milk tube, a long pulsator tube,

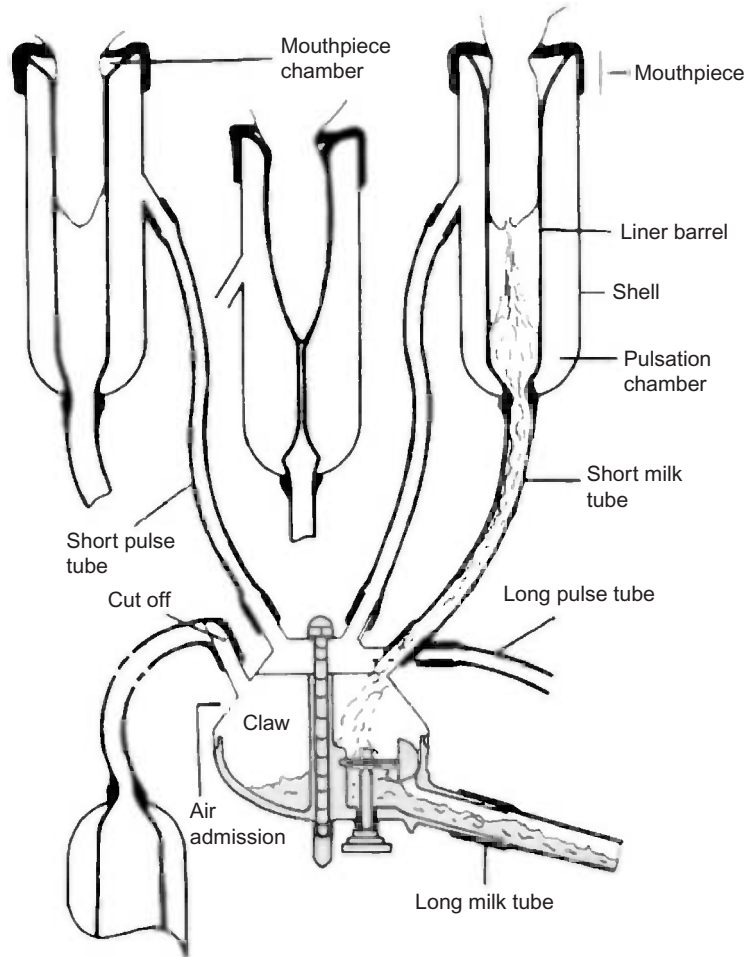


Pipeline milking system

- |                               |                                   |
|-------------------------------|-----------------------------------|
| 1. Long pulse tube            | 14. Washline                      |
| 2. Milking unit               | 15. Main airline                  |
| 3. Long milk tube (Milk hose) | 16. Distribution tank             |
| 4. Claw                       | 17. Regulator (Controller)        |
| 5. Short milk tube            | 18. Teatcup jetter                |
| 6. Short pulse tube           | 19. Receiver                      |
| 7. Teatcup shell              | 20. Milk filter                   |
| 8. Milcline                   | 21. Sanitary trap                 |
| 9. Milk inlet                 | 22. Milk delivery (Transfer) line |
| 10. Milking units             | 23. Vacuum pump                   |
| 11. Stallcock                 | 24. Milk cooling and holding tank |
| 12. Pulsator                  | 25. Milk pump                     |
| 13. Pulsator airline          |                                   |

**Figure 8.1** A simplified diagram of a milking system.

and a pulsator (Figure 8.2). The claw is a manifold which connects the short pulse tubes and short milk tubes from the teatcups to the long pulse tubes and long milk tubes. Claws are commonly made of stainless steel or plastic. Teatcups are composed of a rigid outer shell (stainless steel or plastic), which holds a soft inner liner. Transparent sections in the shell may allow viewing of liner collapse and milk flow. The liner is the only part of the milking system that comes into contact with the cow's teat. Thus, anything that affects the cow must be transmitted by the vacuum in the liner or by the liner itself. The annular space between the shell and liner is referred to as the pulsation chamber.



**Figure 8.2** *The milking unit.*

Vacuum is applied continuously to the inside of the soft liner to withdraw milk from the teat and help keep the machine attached to the cow. The four streams of milk from the teatcups are usually combined in the claw and transported to the milk-line in a single milk hose. Some milking units, called quarter-milkers, keep the four milk streams separated to avoid cross-contamination between teatcups.

Pulse tubes connect the four pulsation chambers of the teatcups to the pulsator. The pulsator is an air valve that alternately introduces air under vacuum and air at atmospheric pressure to the pulsation chamber. When the pulsation chamber is under vacuum, the liner is open and milk can flow. When the chamber is at atmospheric pressure, the liner closes (because pressure outside the liner is greater than the pressure inside the liner), and the teat end is compressed. Liner compression massages the teat

to reduce congestion and edema that is caused by the continuously applied milking vacuum.

One pulsator is usually placed at each stall for each milking machine. Atmospheric air may be supplied to the pulsator through a separate, filtered supply pipe or the pulsators may open directly to the atmosphere. Pulsation timing signals may be generated within the pulsator itself or in a central timing device located in the utility room or other remote location. Pulsators can be timed to operate simultaneously—all four pulsation chambers are either under vacuum or at atmospheric pressure at the same time, or alternating—the two front pulsation chambers are under vacuum while the two rear chambers are at atmospheric pressure and vice versa. Most systems installed today are operated in the alternating mode.

All modern milking systems include a manual or automatic method for releasing the vacuum in the claw prior to removal of the unit from the udder. In addition, some claws are fitted with automatic vacuum shutoff valves that activate when unplanned air is admitted to the claw, such as when a milking unit falls off a cow.

## **2.2 Pipe Systems**

One of the major distinctions between the various pipe systems in the milking machine is whether or not they are part of the “sanitary” part of the machine. Sanitary pipes are those that come into contact with milk and must be constructed and cleaned in a way to maintain sanitary conditions. Sanitary pipes are typically constructed of stainless steel. Some sanitary fittings such as elbows, valves, and other milking machine components are made of various types of plastic that are approved for sanitary applications. Non-sanitary lines are typically constructed of PVC plastic. Synthetic rubber or silicone that has been approved for sanitary applications is used for tube and hoses that come into contact with milk.

Undersized or overly restrictive pipes will result in larger vacuum differences across the system during steady flow conditions and larger vacuum fluctuations under dynamic conditions. Proper pipe dimensions will help limit vacuum fluctuations in the claw during milking and will satisfy both milking and cleaning functions of the system. Fittings and restrictions can cause a major portion of the vacuum drop across the system. In systems with excessive bends, tees, and other fittings, vacuum loss caused by fittings can exceed the loss in straight pipes. Minimizing pipe length and fittings will not only reduce the cost of the system, but also reduce vacuum drop and fluctuation and ease vacuum control and cleaning.

### **2.2.1 Milklines**

Pipeline milking systems are most common, but some milking installations still use weigh jar systems. Weigh jar systems have become less common because of advances in milk metering technology. Modern milk meters are installed between each unit

and the common milkline, and the milking machine operates as a dual-purpose pipeline system. The flow path of milk and air are somewhat different in these two systems. In pipeline systems milk and air from the milking unit are transported to the receiver in milklines and have dual functions of milk transport and vacuum supply. In weigh jar systems milk transfer lines transport only milk from weigh jars to the receiver while vacuum lines transport only air from weigh jars to the sanitary trap. The design and sizing of milk transfer lines is less complex and demanding than for milklines, as milk transfer lines carry only milk and do not have the dual function of supplying a controlled vacuum level.

In weigh jar systems the milk moves from each weigh jar through the sanitary milk transfer line by the pressure difference created by the vacuum in the receiver and atmospheric pressure at the weigh jar (a valve is opened to atmosphere at the end of each cow-milking). Separate sanitary airlines supply milking vacuum to the weigh jar during milking and also transport water to the weigh jar during cleaning. Weigh jars are usually located at the same level or somewhat below the cow's udder. The size of milk transfer lines in weigh jar systems will have no direct effect on milking performance as they act only to empty weigh jars when milking is complete. Looping of milk transfer lines is not required, although looping may facilitate cleaning and speed emptying of weigh jars. Milk transfer lines also carry cleaning water from the weigh jar or milk meter and the milking units to the receiver. Cleaning water capacity is generally the limiting factor when sizing these lines. They should be at least as large as the line supplying wash water to the weigh jars and milk meters.

In dual-purpose pipeline systems milk moves through the milkline to the receiver under the influence of gravity, thus the size and slope of these lines are key design criteria. Low-level pipeline systems, which locate the milk pipeline below the cow's udder, are most common in modern milking parlors. High-level and mid-level pipeline systems, which locate the milk pipeline above the cow's udder (usually 2–7 ft) are also used in milking parlors and in round-the-barn milking systems. Round-the-barn milking systems are facilities in which the milking operation takes place in the same area as the animals are housed (tie-stall or stanchion barns). Milkline vacuum stability in pipeline systems is influenced by milkline diameter, slope, expected maximum milk flow rate, and steady and transient air admission. The performance standard for dual purpose milklines is that the vacuum in the milk-line should not fall more than 2 kPa (0.6" Hg) below the vacuum in the receiver for 99% of normal milking operations (excluding milking unit falloffs). The slope of dual purpose milklines must be maintained within strict tolerances. Milklines must be sloped at least 0.5% (0.8% in the USA and Canada) and preferably between 1% and 2% toward the receiver jar. All other rigid lines must also be sloped to a drain point. This slope requirement may cause clearance problems, especially if the cow platform and parlor pit floor slope in the opposite direction to the milkline.



Consideration of slopes and clearances are especially important if a parlor is built to be expanded later.

Undersized or under-sloped milklines will experience greater vacuum fluctuation if slugging occurs. On the other hand, oversized milklines will not improve milking performance and will require excessive hot water, chemicals, and vacuum pump capacity during washing. Oversized milklines also complicate the cleaning task because of the difficulty of producing slug flow in larger diameter lines and because of the greater surface area to be cleaned. Thus, the cost of going to the next larger size milkline is not limited to the cost of the pipe itself. It is also likely that a larger vacuum pump and water heater will be required, and that higher costs for vacuum pump electricity, hot water, and cleaning chemicals will result.

The expected maximum milk flow rate in a pipeline is determined by the peak milk flow rate and its duration for individual animals, and the rate at which milking units are attached. Steady airflow is introduced by claw or liner air vents. Transient airflows are introduced by liner slip, unit attachment, and unit falloff. The maximum expected transient air admission level will depend on the care taken by an operator when attaching units, the total restriction of airflow for the type of milking unit used, and whether automatic air shutoff valves are installed on the claw. ISO standard 5707 provides design guidelines for milklines in milking parlors for four different levels of peak flow rates from cows (Table 8.1). The lowest peak flow rate, 2.5 kg/min, is meant to apply to low producing cross-bred and dual purpose cows whereas the highest peak flow rate, 5 kg/min, is applicable for very high producing Holstein cows. The lowest level of transient air admission is intended to apply to milking units with small diameter short milk tubes and operators that take care not to admit excess air during unit attachment. The highest level of transient air admission is meant to apply to milking units with large diameter short milk tubes and with operators who may not limit air admission during unit attachment.

The limiting factor for the amount of milk a line can move, or its carrying capacity, has been taken as the combination of milk and airflows for which slugging of milk occurs under normal operating conditions. Slugging will block air pathways and produce vacuum fluctuations in excess of 2 kPa (0.6" Hg) during milking. Occasional slugging will not adversely affect milking performance. Frequent slugging will lower average milking vacuum and may result in slower milking and more liner slips. The amount of milk that can travel through a milkline increases with slope. No adverse effects have been observed on factors affecting vacuum stability with milkline slopes up to 2%.

The slopes of the sections of milkline nearest the receiver are generally the limiting factor in milk carrying capacity. The highest milk flow rate and the majority of bends and fittings occur near the receiver. Thus, if clearance problems limit the total slope of a milkline, increasing milkline slope near the receiver will increase effective

**Table 8.1** Maximum Number of Units per Slope for Milklines in Milking Parlors with a Unit Attachment Rate of 10 s. (ISO, 2007)

Peak milk flow (kg/min)	Inner dia. (mm)	50 l/min Transient Air per Slope				100 l/min Transient Air per Slope				200 l/min Transient Air per Slope			
		Slope %				Slope %				Slope %			
		0.5	1	1.5	2	0.5	1	1.5	2	0.5	1	1.5	2
2.5	38	1	3	4	5	1	2	3	3	0	1	1	2
	48.5	4	8	10	12	3	6	8	10	1	3	5	7
	60	10	16	22	28	8	13	19	23	5	10	13	17
	73	20	34	*	*	17	30	*	*	12	22	33	*
	98	*	*	*	*	*	*	*	*	*	*	*	*
3	38	1	2	3	4	1	1	2	3	0	1	1	1
	48.5	3	6	8	10	2	5	6	8	1	3	4	6
	60	8	13	18	22	6	11	15	19	4	8	11	14
	73	16	30	*	*	15	26	*	*	11	20	31	*
	98	*	*	*	*	*	*	*	*	*	*	*	*
4	48.5	3	6	7	9	2	4	6	7	1	2	4	5
	60	7	11	15	19	5	9	12	16	3	6	9	11
	73	14	26	*(25)	*(31)	11	21	*(25)	*(31)	8	15	23	*(25)
	98	*(33)	*(*)	*(*)	*(*)	*(30)	*(60)	*(*)	*(*)	*(24)	*(45)	*(*)	*(*)
	5	48.5	3	4	6	7	2	3	4	5	1	2	3
60		6	9	11	15	4	7	10	12	3	5	7	9
73		10	19	*(20)	*(23)	9	16	25	*(21)	6	11	17	25
98		*(25)	*(48)	*(*)	*(*)	*(22)	*(43)	*(*)	*(*)	30	*(34)	*(58)	*(*)

\*Indicates an unlimited number of milking units per slope and numbers in parentheses are for a 5 s attachment rate for these conditions.

carrying capacity. Careful building and milking system layout to minimize bends, fittings, and length of milklines and wash lines will improve system performance.

### **2.2.2 Pulsator Airlines**

Pulsator airlines transport only air from pulsation chambers (see 2.1 Milking unit) and pulsator hoses to the distribution tank or main airline and may also transport air used from various vacuum-operated devices such as automatic detachers. These non-sanitary lines can become contaminated with milk and moisture due to system malfunctions. These lines should therefore be corrosion resistant, sloped to a drain point, and fitted with openings for inspection and cleaning. The design of the pulsator airline is more complex than the main vacuum airline because of intermittent airflow and variation with regard to pulsation patterns. Pulsator airlines are typically 48 mm (2 in.) diameter for smaller milking systems (up to about 12 milking units) and 73 mm (3 in.) diameter for larger systems. Air capacity requirements for pulsation vary with respect to pulsation phase pulsators operated in synchronization (all pulsators at once) or out of synchronization (each pulsator operated individually or in small groups). System configuration as well as pulsator airline diameter affects vacuum fluctuations caused by pulsation. Vacuum fluctuations caused by pulsators can be reduced by:

- Sequencing pulsators so they operate in small groups or individually rather than all at once.
- Running separate airlines from the vacuum pump to the pulsator and regulator rather than a single line.
- Restricting the pulsator airline where it joins the main airline.

### **2.2.3 Main Airline**

Main airlines transport only air from the sanitary trap to the vacuum pump. These non-sanitary lines must carry all air entering the system to the vacuum pump with minimal vacuum drop. The maximum airflow rate through the main airline normally occurs from the vacuum regulator to the pump. The vacuum drop across the main airline will not exceed 2 kPa (0.6" Hg) between the receiver and vacuum pump during the maximum airflow condition of one milking unit falloff.

### **2.2.4 Distribution Tank or Interceptor**

The main purpose of a distribution tank is to act as a manifold for the connection of airlines. There are currently no standards for distribution tank size. The extra volume supplied by the distribution tank has little effect on vacuum stability of modern milking systems. An interceptor tank may be included in addition to or instead of a distribution tank. The purpose of an interceptor tank is to reduce debris and liquid flow (milk or wash water) through the vacuum pump and they are usually mounted on the main airline near the vacuum pump. Interceptor tanks often contain internal filters

that should be inspected regularly and cleaned when necessary. Both distribution and interceptor tanks should be fitted with drain valves that automatically actuate when the vacuum pump is turned off.

## 2.3 Vacuum Production and Control

### 2.3.1 Vacuum Pumps

A vacuum pump removes air from the milking system. There are two main types of vacuum pumps used for milking machines:

1. Rotating vane pumps with oil cooling and lubrication are the oldest types of pumps still being used for milking systems. The discharge from vane pumps contains some oil vapor and droplets. An oil recovery system should be fitted to the exhaust to capture and reuse the lubrication oil. Even with an oil reclaimer, care should be exercised in choosing a location for discharge and extra means of capturing oil are desirable.
2. Blower or lobe pumps rely on extremely small clearance between the pump lobes to create a vacuum seal so that oil is not added to the air stream and there are no contaminants in the exhaust air stream. They have similar energy efficiency to oil vane pumps (typically 420 lpm of air movement per kW). Heat for water or space heating can be recovered from the exhaust air of these pumps.

Larger systems may be fitted with more than one vacuum pump. This allows the milking system to be operated if one vacuum pump fails. A backup vacuum pump is also desirable if the anticipated response time of service personnel is an issue. Install a shutoff valve so that each vacuum pump can be isolated from the milking machine. A test port (to measure vacuum pump capacity) and safety vacuum relief valve should be installed between the shutoff valve and the vacuum pump. Vacuum pumps should be installed in a well-ventilated area to prevent overheating. Provide easy access to the vacuum pump for maintenance. Always install pumps with safety guards in place and replace guards after maintenance. An electrical disconnect switch should be located within reach of the pump in the event of an emergency and for use during pump maintenance.

Historically, vacuum pumps have been oversized in milking systems, because increasing vacuum pump capacity was thought to improve vacuum stability and to be required for cleaning. However, with a properly designed and located vacuum regulator and an efficient system design, vacuum pumps can be sized more conservatively with improved vacuum stability. Proper system design and control will allow adequate cleaning with the same or less airflow than the minimum required for milking and result in significant energy savings.

The pump must be capable of moving air from the normal operation of milking units and other vacuum-operated equipment, plus additional air from system leaks, unit attachment, liner slips, and unit falloff. Milking systems fitted with automatic

vacuum shutoff valves greatly reduce the vacuum requirements of the system. Vacuum pumps should be sized so they have sufficient effective reserve capacity to limit the vacuum drop in or near the receiver to within 2 kPa (0.6" Hg) during normal milking. The minimum effective reserve recommended in ISO Standard 5707 is:

- $200 + 30n$  l/min of free air for pipeline milking systems with up to 10 milking units.
- $500 + 10(n - 10)$  l/min of free air for pipeline milking systems with more than 10 milking units.

For installations without automatic shutoff valves, these recommended effective reserves should be increased by 200 l/min. Additional capacity may be required for pumps operated at high altitudes.

### **2.3.2 Vacuum Regulation**

The vacuum level in the milking machine is controlled by the vacuum regulation system. In a well-designed and efficiently controlled system, average receiver vacuum should not fall more than 2 kPa, or 0.6 in. of mercury (0.6" Hg) below the desired set point.

A conventional vacuum regulator maintains a steady vacuum level in the system by admitting air into the system to balance incoming air (through unattached milking units, intentional air leaks, or other means) with the amount of air being removed by the vacuum pump. When more air is entering the system than being removed, the vacuum level drops and the regulator closes. If more air is being removed than entering, the vacuum level rises, and the regulator opens to admit air. The ability of the regulator to respond to vacuum fluctuations depends on the characteristics of the regulator as well as where it is located in the milking system. A test of the response of the regulator to vacuum fluctuations is part of a thorough system analysis performed by a service technician.

Another method of vacuum regulation is to control the speed (and thereby the airflow removal rate) of the vacuum pump. Pump speed is adjusted to match the continuously changing airflow requirements of the system: when more air is admitted pump speed is increased, when less air is admitted pump speed is reduced. This regulation technology results in a significant reduction compared to a conventional vacuum regulation system (with constant speed and capacity speed pump).

### **2.3.3 Vacuum Gauge**

Every milking system should be fitted with at least one accurate vacuum gauge. The gauge should be visible by the operators during milking. It is also helpful to locate a vacuum gauge near the vacuum regulator. On-farm vacuum gauges should be checked for accuracy as part of routine milking system maintenance. Mercury manometers can be used to calibrate service technician's gauges but because of the risk of

mercury loss, mercury manometers should not be permanently mounted on a milking system and should not be carried in the field.

## 2.4 Receiver Group and Milk Transfer Line

Milk flows in the milking line to the receiver primarily by the force of gravity. The location of the receiver establishes the clearances required for the milking line and, consequently, the required slope and elevation of the floor of the operator's area and cow platform and the relative location of the milk and utility rooms. Therefore, the receiver location should be determined before proceeding with building design.

The receiver group includes the receiver, sanitary trap, and control panel and milk pump. It is usually located in or near the operator's area to minimize the length of milking lines. The purpose of the sanitary trap is to prevent milk from being drawn into non-sanitary parts of the milking system in case of milk pump failure. The milk pump provides the energy to move milk through the milk transfer line from the receiver, which is under vacuum, to the milk storage tank, which is at atmospheric pressure. The milk transfer path will contain a milk filter to remove particulates from milk and may also include an in-line milk cooler or pre-cooler.

## 3. MILKING PARLORS

A milking parlor is part of a building where cows are milked on a dairy farm. Cows are brought to the milking parlor to be milked and are then returned to a feeding and/or resting area. This section presents an overview of the major types and components of contemporary milking parlors, and common forms of milking parlor automation are described.

The area where cows are milked (milking parlor) is usually part of a larger complex known as the milking center, which contains supporting structures and equipment for the parlor. A milking center typically contains the following use areas:

- Holding area—a pen for collecting cows before milking.
- Milking parlor—the location containing the milking equipment, milking stalls, cow platform, and operator's work area.
- Milk room—a room housing equipment for cooling and storing milk and for cleaning and sanitizing the milking and milk storage equipment.
- Utility room—a room that houses equipment such as vacuum pumps, refrigeration compressors, and water heaters.
- Supply area—a room or area for storing chemicals, drugs, towels, milk filters, and other supplies necessary for the milking operation.

As the size of the farm increases, it is common to incorporate other work areas and animal treatment areas into the milking center. Milking centers may also contain these additional use areas:

- Office—a room that houses computer-based monitoring and control systems for the milking parlor. In many cases, office facilities for the entire farm operation are maintained at the milking parlor.
- Worker comfort areas—areas for workers to wash, eat, relax, etc.
- Wash/drip pens—areas where the underside of a group of cows may be washed with floor mounted sprinklers and then allowed to drip dry before entering the holding area and/or milking area. Wash pens are used only in very dry climates.
- Herd health facilities—a central area for herd health needs on the farm to restrain animals for treatment or breeding, and to store of veterinary and breeding supplies and equipment. Simple restraint facilities might be included in the milking parlor return lane if the milking parlor is not in use for extended periods.
- Hospital area—an area for isolation and convalescence of cows that cannot be kept with the milking herd.
- Maternity area—a housing area for cows ready for calving and a clean, isolated area for calving. In hot climates the maternity area is usually separate from the milking parlor complex.
- Calf area—an area or room with hot and cold water for mixing calf rations. In hot climates the calf area is usually separate from the milking parlor complex.
- Animal loading facilities—a ramp or dock for loading and unloading animal trucks or trailers.

The milking parlor and milking center house equipment for harvesting, cooling, and storing milk and must be designed to accommodate the special needs of this equipment. The most important of these design criteria is that the milklines must be sloped toward a central receiver jar. The location of the milkline and dimensions of ancillary equipment, such as milk meters and pulsators, determine the required clearances between the floor of the operator's area and the cow platform. As a general rule, the total length of pipe and number of fittings in the milking machine should be kept to a minimum to reduce the cost of the system as well as to improve milking and washing performance.

A well-designed milking parlor also allows easy and efficient disposal of waste milk and wastewater. Floors should be sloped with drains located to eliminate standing water that can create slippery or icy surfaces. The milking center is often the focus of activities on a dairy farm and the first stop for visitors to the farm. The location and layout of the milking parlor and milking center should facilitate desired activities and discourage its use of milking and milk handling areas except when necessary. Layouts that regularly require animals, vehicles, and people to occupy the same place or cross paths should be avoided. Seemingly minor design details, like floor plans that use a milk room for the main entrance to the milking center, can result in the accumulation of manure, debris, and items left behind by people not involved in milking and milk handling tasks.

### 3.1 Milking Parlor Construction Methods

The various parts of the milking center require special construction materials and methods for ease of cleaning, moisture protection, ventilation, heating, fire protection, noise control, and illumination. An understanding of the activities performed in the various use areas is required to specify the building materials and methods used for each.

Proper design, selection, and installation of electrical systems for milking parlors are crucial to using electricity safely and efficiently. Inferior wiring and equipment cause hazardous conditions for humans and livestock and often result in higher insurance premiums, increased maintenance costs, and greater risk of fire. Milking parlor equipment is washed regularly with chemicals, creating a wet and corrosive atmosphere. Corrosive gases, moisture, and dust hasten deterioration of electrical components. Wiring methods and materials that minimize this deterioration and maintain electrical safety and equipment function under these conditions are necessary for milking parlors. Consult relevant local codes and standards for the specific requirements for electrical equipment and materials suitable for use in the wet and corrosive environment found in milking parlors.

A basement can be built under the operator's area or milking areas to house milk-lines, pulsator airlines, milk meters, pulsators, receiver, and other equipment. This design can be used with herringbone, parallel or side-open stall types. Milking equipment is protected from mechanical damage as well as excessive dirt and moisture. The operator's area is less cluttered, easier to keep clean, and quieter. This option generally increases building cost.

It is important to clean the exterior surfaces of milking and milk handling equipment to avoid contaminating milk during milk harvest and transport. Parlor equipment should be cleaned after every milking and at least three times per day in large parlors milking around the clock. A milking parlor should be fitted with equipment to easily clean exterior surfaces of milking and milk handling equipment. This is typically accomplished with a combination of manual cleaning with a brush and cleaning solution and a rinse with water under medium or high pressure. The walls and floors are typically cleaned using a combination of manual scraping or brushing and then rinsed using hoses with water under medium or high pressure. This system minimizes the amount of water required to clean the parlor.

Some parlors are also fitted with devices to automatically clean the floor of the parlor and/or holding area during milking. This may be accomplished by periodic application of water under pressure or by a flush system in which a large volume of water is released to create a wave of water on floor surfaces that will carry manure and urine to a collection pit. Care must be taken in the design of flushing systems so that flush water does not contaminate milking units.



## 3.2 Environmental Control

Environmental control is an important but often neglected component in milking parlor design and operation. Demands on the environmental control systems differ for the various areas of the milking center. Control of temperature, humidity, and odors can be accomplished through ventilation, heating, and cooling systems that are properly designed, installed, and managed for each area. Ventilation systems must remove moisture, odors, and excessive heat from the milking parlor and holding area. Mechanical ventilation is typically used in parlors and milk rooms, while natural ventilation is common in holding areas. In cold regions some type of heating system will be required in the milking parlor and offices. It is also common to have separate ventilation systems in the milking parlor for cold weather (to remove moisture and add heat) and hot weather (primarily to remove excess heat).

## 3.3 Milking Parlor Types

Milking parlors are classified by whether the cows are elevated above the person doing the milking (flat parlor versus elevated parlor), the type of stall used to confine cows during milking, and cow entry and exit methods. Descriptions of the main parlor types follow.

### 3.3.1 Herringbone

In herringbone (or fishbone) parlors, cows stand on elevated platforms on either side and at an angle of about  $45^\circ$  to the edge of the operator's area (Figure 8.3). This orientation allows the operator access to the side of the udder for cow preparation and unit attachment. In larger parlors the two rows of stalls may be arranged in a wedge or "V" configuration, resulting in a wider operator area on the end away from the parlor animal entrance. This improves the visibility of units and cows from the other side of the operator area. Cows enter the milking stalls in groups according to the

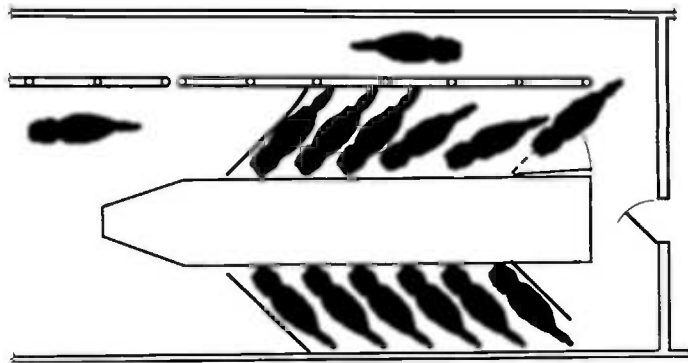


Figure 8.3 Herringbone or fishbone milking parlor with standard exit and single return lane.

number of milking stalls on each side of the parlor. The rear portion of a herringbone stall is usually shaped in an “S” pattern to position the rear end of the cow in close proximity to the milking unit. The front end of herringbone stalls can be stationary or fitted with indexing stalls and can use either standard or rapid exit. In small herringbone parlors it is common for cows on one side of the parlor to cross over to a common exit lane on the other side of the milking area. In larger parlors an exit lane is provided for each side of the parlor (dual return).

### 3.3.2 Parallel

In parallel or side-by-side parlors, cows stand on elevated platforms at a 90° angle to the operator area (Figure 8.4). Access to the udder for cow preparation and unit attachment is between the cows' rear legs. The cow platform is shorter but wider than for a herringbone parlor. It is not possible to fit parallel stalls with arm type cluster removers because of the limited access to the udder. Head chutes at the front end of the stall are used to position cows. Parallel stalls are commonly fitted with indexing front ends, and rapid exit with dual return lanes. When compared to herringbone parlor types, the parallel configuration results in a shorter operator's area, which reduces the distance walked by operators.

### 3.3.3 Para-Bone/Swing-Over

The swing or swing-over configuration can be used on herringbone or parallel parlors but is most common with the para-bone stall configuration (Figure 8.5). Stalls on either side of the operator's area share milking units. When milking is completed on one side of the parlor the milking units are removed and “swung” to the stall immediately across the operator's area. This configuration reduces the number of milking units required to reduce the initial cost of the parlor. Swing parlors usually milk slightly fewer cows per hour per stall but more cows per hour per milking unit

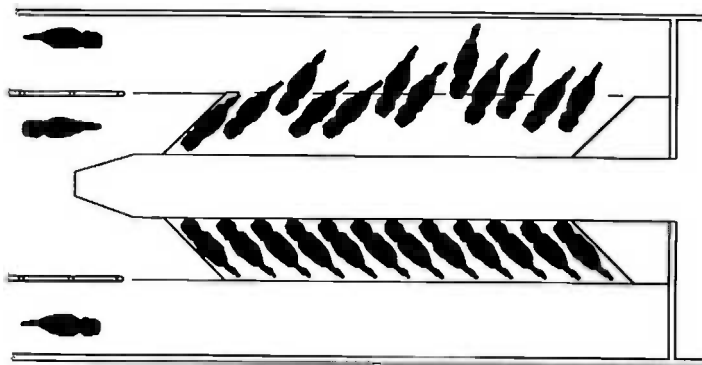
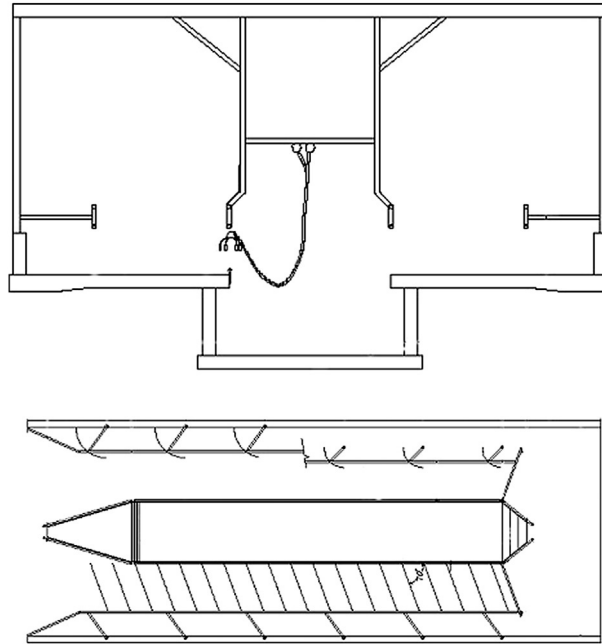


Figure 8.4 Parallel or side-by-side milking parlor with rapid exit stalls and dual return lanes.



**Figure 8.5** *Swing-over parlor cross-section and plan view of para-bone stalls.*

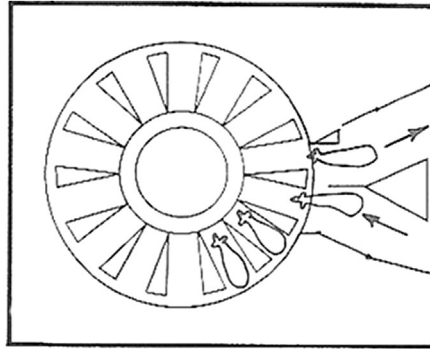
compared to parlors with one milking unit per stall. Para-bone stalls place the cow at an angle of about  $70^\circ$  to the operator area. The entrance and exit features and positioning method of this stall design are similar to the herringbone type. The sharper cow angle makes the operator's area shorter, and units are commonly attached between the cow's back legs as in a parallel stall.

### **3.3.4 Rotary or Carousel**

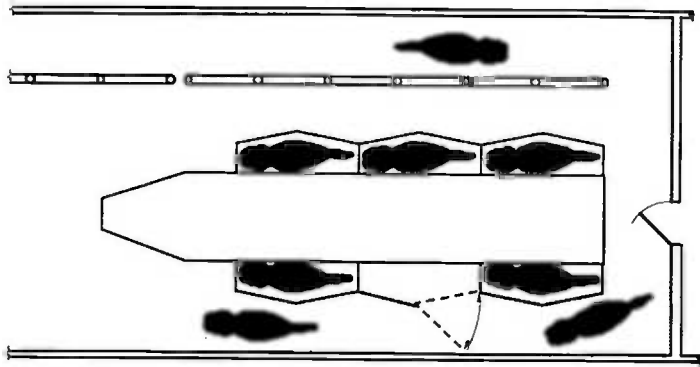
In rotary (or carousel) parlors, cows walk on to a rotating milking platform one at a time (Figure 8.6). The cows move past an operator where cow preparation and unit attachment is performed. A second operator is positioned near the exit to remove milking units if detachers are not used and to apply post-milking teat sanitizer. A third operator may be employed to tend to unit slips and falloffs and other special cow needs during milking. The number of stalls in rotary parlors can range from 10 to 80 or more. Rotary parlors facilitate an orderly and consistent milking routine in large parlors.

### **3.3.5 Side Open or Tandem**

In side opening or tandem stalls, cows stand in an end-to-end configuration during milking, and units are attached from the side (Figure 8.7). This parlor type is less



**Figure 8.6** *Rotary or carousel milking parlor.*



**Figure 8.7** *Side open or tandem milking parlor.*

affected by variations in individual cow milking times than in herringbone or parallel parlors, as cows are moved one at a time rather than in groups. This parlor type also gives the maximum view of, and access to, cows by the operator during milking. It is ideally suited to situations in which individual cow care may be done in the milking parlor.

### **3.3.6 Flat**

In flat parlors the milking area and the operator's area are at the same or similar elevation (Figure 8.8). Various stall designs are used, from simple stanchions in which the cow must back out of the stall after milking to more complicated gates that cows walk through after milking. Flat parlors can be inexpensively fitted into existing stanchion or tie-stall barns with highline milking equipment as a method to improve labor efficiency. They are not, however, as labor efficient or worker-friendly as elevated parlors.

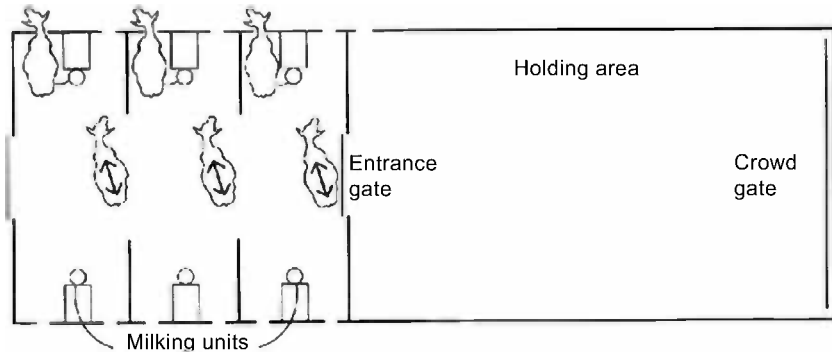


Figure 8.8 *Flat-barn milking parlor.*

### 3.4 Other Milking Parlor Design Elements and Support Equipment

#### 3.4.1 Entrance/Exit Gates

Entrance and exit gates to milking stalls may be manually operated or powered by pneumatic cylinders. Controls for both entrance and exit gates should be located at both ends of the operator's area and in intermediate locations in large parlors. The standard exit configuration for herringbone stalls is a single exit gate located at the exit end of the stall row. In these configurations the group of cows walks out of the milking stalls in single file. Rapid exit stalls allow for all cows to exit the front end of each stall simultaneously. Methods used include raising, lowering, or rotating the entire stall front or opening a series of gates in front of each cow simultaneously. Rapid exit stalls require a wider exit area on the milking platform and a return lane on each side of the parlor. Rapid exit stalls improve performance in parlors with more than eight to ten stalls per side.

#### 3.4.2 Indexing Stalls

Herringbone, parallel, and para-bone parlors may be fitted with movable or indexing stall fronts. The stall front is moved forward as cows enter to widen the stall area and facilitate rapid cow movement. When milking is ready to commence, the stall front is moved rearward to position the cows as close as possible to the milking unit and operator. This reduces the reaching distance required to prepare cows and attach units, and also reduces cow movement during milking.

#### 3.4.3 Automatic Cluster Removers

Automatic cluster removers (ACR) or automatic detachers sense the end of milk flow and then shut off the vacuum to the claw and remove the milking unit from under the cow. ACRs improve labor efficiency primarily by removing the need for operators

to observe the end of milking for each cow and, secondarily, by eliminating the detachment task, allowing one operator to handle more milking units. ACR typically reduce milking time by reducing the amount of over-milking. ACR may be incorporated with a retractable arm that supports the milking unit and hoses during milking and while it is being retracted after milking. With arm units the milking unit is attached to a retractable arm that removes the unit from under the cow at completion of milking. Simpler ACR use a rope or chain to retract the milking unit and lift it away from the cow after milking is completed. Arm type units are more ergonomically friendly, offer superior support for the long milk and pulse tubes, resulting in better balance of the milking unit on the udder, and prevent the milking unit from lying on the platform in the event of a cluster falloff.

#### **3.4.4 Crowd Gates**

Power-driven crowd gates reduce the size of the holding pen as cows move into milking stalls. A bell or other signal device can be fitted to the crowd gate to alert cows to the movement of the gate. Crowd gates can also be fitted with controls to stop the drive unit automatically when the gate senses a cow. Some gates can be raised over a group of cows in the holding pen to return to their starting position, thus allowing a new group to be loaded in the holding pen while milking of the earlier group is being completed. Electrically charged wires on any crowd gate make cows nervous and are not recommended. The proper use of a crowd gate improves labor efficiency by eliminating the need for operators to leave the operator area during milking in order to encourage cows to enter the milking stalls.

#### **3.4.5 Animal Identification and Data Collection/Records Systems**

Automatic animal identification systems read information from a transponder affixed to individual cows. Additional systems are available to automatically collect a variety of data for the identified animal including milk yield, milking time, milk conductivity, activity level, and weight. These data are sent to a central collection point where they are organized, analyzed, and stored by a computer-based records system. Records systems will help to identify animal health problems and determine reproductive status. Cow identification and performance data can also be used to automatically sort animals as they enter or leave parlors equipped with automatic sorting gates and pens and to control automatic animal feeding systems.

## **REFERENCES**

- ISO, 2007. Milking Machine Installations—Construction and Performance. International Standard ISO 5707:2007(E). third ed. 2007-02-15, 2007, the International Organization for Standardization, Geneva Switzerland.

This page intentionally left blank

# Dairy Product Processing Equipment

H. Douglas Goff

University of Guelph, ON, Canada

## 1. INTRODUCTION

Milk as produced on farm is transformed into a vast array of dairy products: fluid milks and creams, evaporated and dried products, yogurt and fermented milk products, butter, ice cream, and cheese. The machinery involved in all of these transformations is as varied as the products themselves. This chapter will provide a description of the equipment used for the main processes involved in the manufacture of many dairy products: separation of cream from milk, pasteurization, and homogenization. It will also briefly describe the type of equipment used in the manufacture of specific milk products: membrane separation, evaporation, dehydration, ice cream freezers, butter churns, and cheese vats. It is not possible within the context of a handbook on food machinery to describe in detail the intricacies of all of this equipment, rather to present an overview such that readers unfamiliar with dairy processing can gain an appreciation of equipment requirements for dairy products. Readers are referred to [Britz and Robinson \(2008\)](#); [Bylund \(1995\)](#); [Caudill \(1993\)](#); [Gilmore and Shell \(1993\)](#); [Walstra \*et al.\* \(2005\)](#), or the websites of the many multinational and local fabricators of dairy processing equipment for more information.

Modern dairy plants are fully equipped to move raw materials in and finished goods out with little or no handling. It is not uncommon to find dairy plants processing in excess of 1,000,000 l of milk per day, thus automation of every aspect of the process is vital. The fact that the principal raw ingredient, milk, is a liquid suggests that fluid handling methods, storage and mixing tanks, pipes, centrifugal and positive displacement pumps, liquid metering systems, manual and automated valves to direct flow, etc., are commonplace. Stainless steel (304, 18% chromium, 8% nickel, #4 polished finish) is the most common alloy used in fabrication of product-contact equipment. Most equipment is designed to be cleaned-in-place, through the use of high velocity circulating solutions of alkaline and acid cleaners and sanitizers, so pipelines connecting tanks and equipment are frequently welded (via high-pressure, tungsten inert gas welding) in the desired configuration.



Milk is a perishable product and refrigeration is the principal means of increasing its shelf-life prior to preservation processes and also post-processing for those products that are not sterilized. Thus refrigeration methods are also commonplace, both the use of primary refrigerants in mechanical vapor recompression systems and secondary cooling through the use of circulating chilled media such as brine or propylene glycol. All dairy products are heated during processing, either pasteurized or, in a few cases, heat treated at either sub-pasteurization temperatures (e.g. milk for aged cheeses) or sterilization temperatures. As a result liquid heating systems, such as continuous heat exchangers or jacketed tanks, are also commonplace and typically heated by steam or steam-heated water, implying that steam generation boilers are found in almost all dairy processing plants. Packaging equipment and material handling equipment (conveyors, palletizers, etc.) of all types can also be found in most, if not all, dairy processing plants. However, this chapter will not discuss further any of this secondary processing equipment.

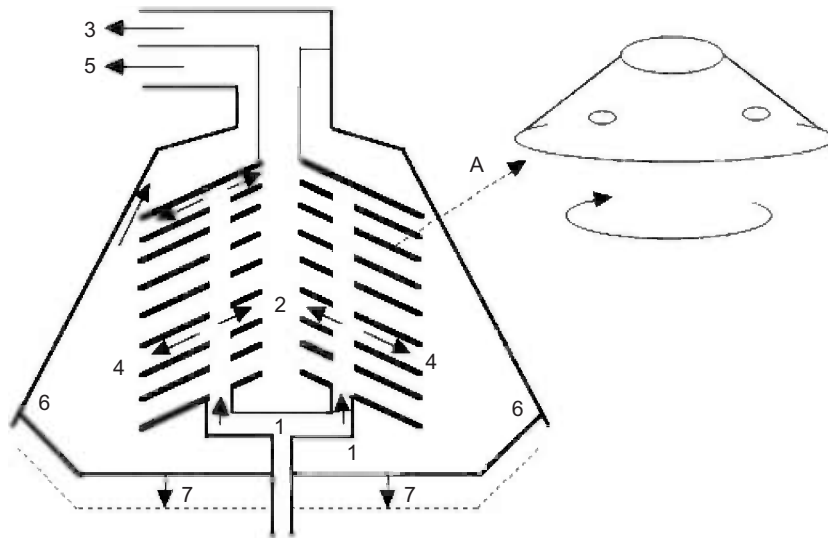
Raw milk coming from the farm can easily be contaminated with pathogenic bacteria (several surveys have suggested that about 5% of raw milk tank loads from modern dairy farms contain pathogens). It is always contaminated with spoilage bacteria, and counts of  $>100,000/g$  are not unusual for pooled milk that is 2 or 3 days old. As milk provides an ideal growth medium for microorganisms, much attention needs to be paid to sanitation and hygienic conditions of processing. Dairy equipment has, for years, been designed with cleaning and sanitary operation as a primary concern. [3-A Sanitary Standards, Inc.](#) produces sanitary standards and accepted practices for the design, operation, and maintenance of dairy processing equipment. These standards are carefully prepared by committees composed of sanitarians, inspectors, fabricators of equipment, and dairy processors. If equipment meets these standards, approval is given to fabricators for the use of the 3-A seal of approval on equipment. This is a guarantee of sanitary design for processors.

## 2. CLARIFICATION, SEPARATION, AND STANDARDIZATION

One of the first unit operations in the processing of fluid milk is the separation of cream from skim. Raw milk contains approximately 4% fat, in the form of microscopic globules of diameter  $1-4\ \mu\text{m}$ , surrounded and partially stabilized by a membrane. The other milk constituents are dispersed (e.g. casein micelles, 2.5% by wt of milk) or dissolved (e.g. lactose, 4.6% by wt of raw milk, whey proteins, 0.8%) in the aqueous phase, with water (87–88% by weight of raw milk) as the solvent, and this aqueous phase is, as produced commercially, skim milk. Separation essentially produces a fraction of the aqueous phase devoid of fat globules (skim) and a fraction of the aqueous phase enriched in fat globules (“cream”, of varying fat content). Other uses of centrifugal separation in the dairy industry include clarification (removal of

solid impurities from milk prior to pasteurization), cheese whey separation to defat whey prior to further processing, resulting in a whey cream fraction, bactofuge treatment (centrifugation of bacteria from milk), separation of quarg curd from whey, and butter oil purification (separation of a residual aqueous phase from anhydrous milk fat).

Centrifugation is based on Stokes' Law. The particle sedimentation velocity increases with increasing particle diameter, increasing difference in density between the discrete and continuous phases, increasing rotational velocity of the centrifuge, and decreasing viscosity of the continuous phase. Continuous-flow separating milk centrifuges (or separators) consist of up to 120 discs stacked together at a 45–60° angle and separated by a 0.4–2.0 mm gap or separation channel (Figure 9.1). The stack of discs has vertically aligned distribution holes into which the milk is introduced



- A Conical disk, from stack, showing top opening and milk distribution channels. Disk stack is rotating in separator.
- 1 Whole milk enters the disk distribution channel, from below.
  - 2 Fat globules move inward, carried by some skim milk to form the cream.
  - 3 Cream outlet port.
  - 4 Skim milk devoid of fat globules moves outward and upward, over the soiled disk at the top.
  - 5 Skim outlet port.
  - 6 Sediment collects.
  - 7 Momentary periodic release of bowl pressure causes sediment cavity (6) to open, releasing sediment.

**Figure 9.1** Schematic diagram of the centrifugal milk separator, showing the stack of rotating conical discs and the milk flow through the disc stack to produce the cream and skim milk streams.

at the bottom, either from an inlet at the bottom of the centrifuge or from a milk inlet at the top of the centrifuge which passes downwards through the center to the bottom where it enters the distribution channels. Under the influence of centrifugal force the fat globules, which are less dense than the skim milk, move inwards through the separation channels toward the axis of rotation. They are carried out in a portion of the aqueous phase (the “skim” portion of the cream). The fat content of the cream is controlled by a throttling valve that is set to allow a variable portion of skim to escape through the cream side. The defatted skim milk will move outwards through the discs and leaves through a separate outlet.

Separation and clarification can be done at the same time in one centrifuge. Particles that are more dense than the aqueous phase are thrown outwards to the inside perimeter of the centrifuge bowl. The solids that collect in the centrifuge consist of epithelial cells and leucocytes from the mammary gland (somatic cells), bacteria, sediment, and other small bits of debris. The amount of solids that collects will vary; however, this must be removed from the centrifuge. Modern centrifuges are self-cleaning, allowing a continuous separation/clarification process. This type of centrifuge consists of a specially constructed bowl with peripheral discharge slots. These slots are kept closed under pressure. With a momentary release of pressure, for about 0.15 s, the contents of the sediment space are evacuated. This can mean anywhere from 8 to 25 l are ejected at intervals of 60 min.

The streams of skim and cream after separation must be recombined to a specified fat content to make liquid retail milk products (varying in fat content from 1% to 35%). This can be accomplished by mixing a portion of the cream stream from the separator back into the skim stream through a controllable mixing valve located after the separator. With this type of direct standardization, on-line fat analysis can be performed downstream of the mixing valve and the cream line can be automatically adjusted to provide the desired fat content.

### **3. PASTEURIZATION**

The process of pasteurization was named after Louis Pasteur who discovered that spoilage organisms could be inactivated in wine by applying heat at temperatures below its boiling point. The process was later applied to milk and remains the most important operation in the processing of milk. Milk pasteurization is defined as the heating of every particle of milk or milk product to a specific temperature for a specified period of time without allowing recontamination of that milk or milk product during the heat treatment process. There are two distinct purposes for the process of milk pasteurization:

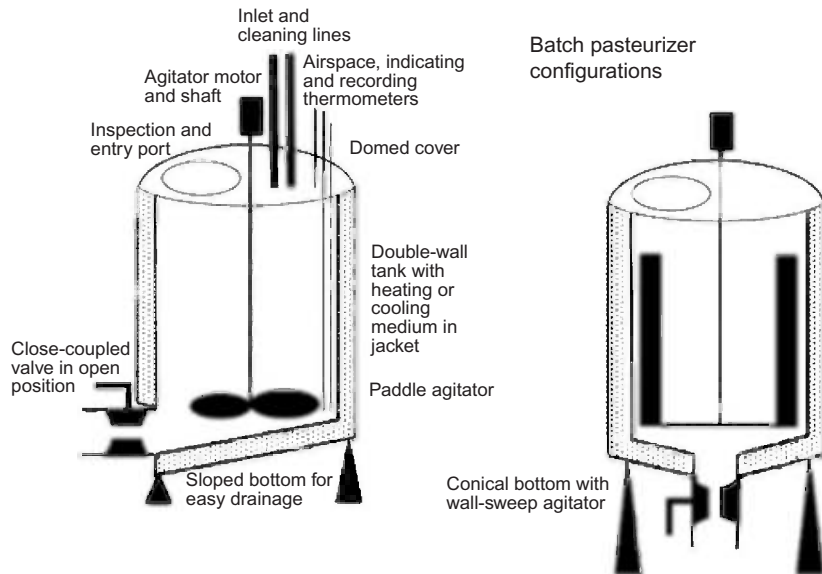
1. Public health aspect—to make milk and milk products safe for human consumption by destroying all bacteria that may be harmful to health (pathogens).

## 2. Keeping quality aspect—to improve the shelf-life of milk and milk products.

Pasteurization inactivates some undesirable enzymes and reduces numbers of many spoilage bacteria. Shelf-life can be 7, 10, 14 or up to 16 days, depending on time and temperature combinations, post-processing recontamination (although this should be minimized in hygienic processing operations) and refrigerated storage conditions post processing.

The extent of microorganism inactivation depends on the combination of temperature and holding time. Minimum temperature and time requirements for milk pasteurization are based on thermal death time studies for the most heat-resistant pathogen found in milk, *Coxelliae burnettii*. Thermal lethality determinations are conducted based on thermal destruction kinetics (D and Z values) of the heat-resistant organisms present. To ensure destruction of all pathogenic microorganisms, time and temperature combinations of the pasteurization process are highly regulated, for example 63°C for not less than 30 min, or 72°C for not less than 16 s. Products with higher fat (creams), added sugar (flavored milks), or added stabilizer (ice cream mixes) generally have higher pasteurization standards.

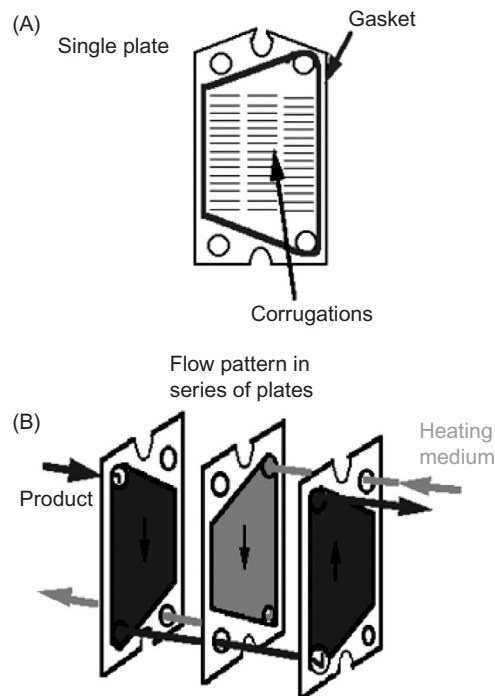
There are two basic pasteurization methods, batch or continuous. The batch method uses a vat pasteurizer, which consists of a jacketed vat surrounded by either circulating water, steam, or heating coils of water or steam (Figure 9.2). The vat is typically a conical-bottom, enclosed dome-top tank with agitation. In the vat the milk is heated and held throughout the holding period while being agitated. The



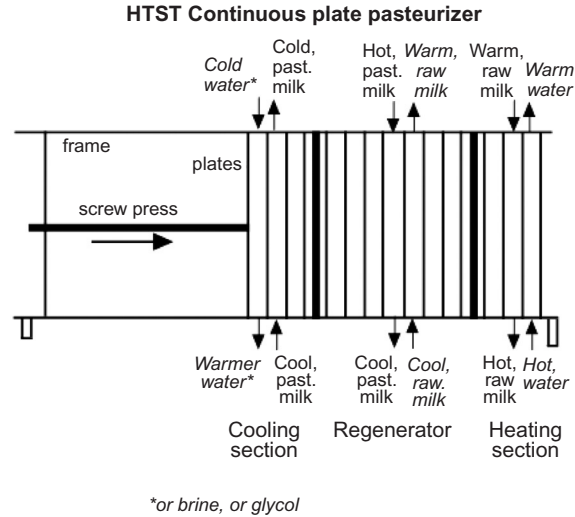
**Figure 9.2** Schematic diagram showing the requirements for and configurations of a batch pasteurizer.

milk may be cooled in the vat or removed hot after the holding time is completed for every particle. As a modification, the milk may be partially heated in a tubular or plate heater before entering the vat. This method has very little use for milk but some use for low-volume milk by-products (e.g. creams, flavored milks) and special batches. The vat pasteurizer is used extensively, however, in the ice cream industry for ingredient dispersion and mix quality reasons other than microbial. There are many legal requirements around the batch pasteurizer to ensure adequate operation for food safety, such as close-coupled outlet valves to prevent mixing of milk that might be trapped in the valve stem, headspace heaters to ensure foam temperature exceeds pasteurization temperature, indicating, recording, and headspace thermometers, and many other requirements.

The continuous process method has several advantages over the vat method, the most important being time and energy saving. For most continuous processing, a high temperature short time (HTST) plate pasteurizer is used. The heat treatment is accomplished using a plate heat exchanger (Figures 9.3 and 9.4). This piece of equipment consists of a stack of corrugated (for greater strength, improved



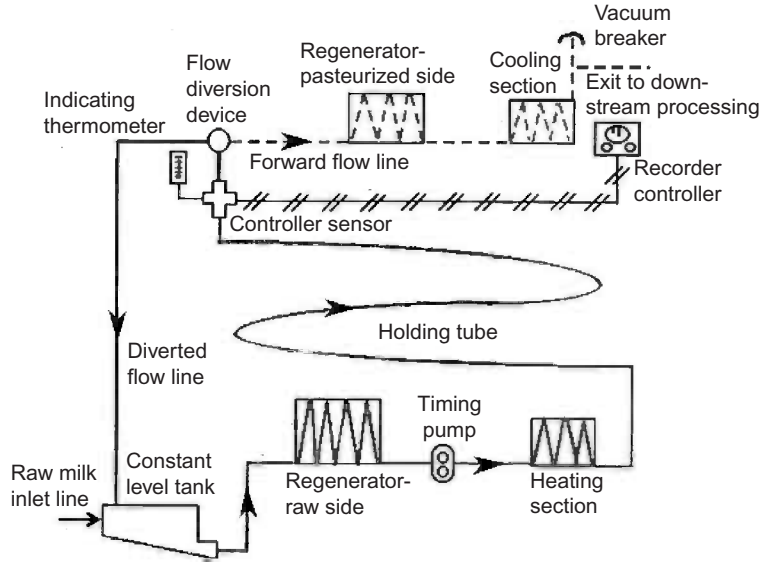
**Figure 9.3** Schematic diagram of a plate heat exchanger. (A) An individual plate. (B) The configuration of and product flow through multiple plates of the heat exchanger.



**Figure 9.4** Schematic diagram of a plate heat exchanger used for HTST pasteurization of milk, showing the different plate sections and the fluids flowing through each.

fluid flow and increased surface area) stainless steel plates clamped together in a frame. There are several flow patterns that can be designed. Gaskets are used to define the boundaries of the channels and to prevent leakage. The heating medium is typically hot water, preheated by steam. Modern units can process up to 200,000 l/h.

Milk flow in a continuous system is shown in [Figures 9.4 and 9.5](#). Cold raw milk at 4°C in a constant level tank is drawn into the regenerator section of pasteurizer. Here it is warmed to approximately 57–68°C by heat given up by hot pasteurized milk flowing in a counter current direction on the opposite side of thin, stainless steel plates. The raw milk, still under suction, passes through a timing pump, which delivers it under positive pressure through the rest of the HTST system. The timing pump governs the rate of flow through the holding tube. It is usually a positive displacement pump equipped with variable speed drive that can be legally sealed at the maximum rate to give minimum holding time in holding tubes. A centrifugal pump with magnetic flow meter and controller may also be used in some legal jurisdictions. The raw milk is forced through the heater section where hot water on opposite sides of the plates heat milk to a temperature of at least 72°C. The milk, at pasteurization temperature and under pressure, flows through the holding tube where it is held for at least 16 s. The maximum velocity is governed by the speed of the timing pump, diameter and length of the holding tube, and surface friction. The holding tube must slope upwards 2 cm/m in the direction of flow to eliminate air entrapment so nothing flows faster at air pocket restrictions.



**Figure 9.5** Flow diagram of a simple system for continuous flow pasteurization of milk.

Temperature sensors of an indicating thermometer (the “official” thermometer) and a recorder-controller (Safety Thermal Limit Recorder, STLR) are located at the end of the holding tube. Milk then passes into the Flow Diversion Device (FDD). The FDD assumes a forward-flow position if the milk passes the recorder-controller at the preset cut-in temperature ( $> 72^{\circ}\text{C}$ ). The FDD remains in normal (fail-safe) position, which is in diverted flow, if milk has not achieved a preset cut-in temperature. The STLR monitors, controls and records the position of the flow diversion device (FDD) and supplies power to the FDD during forward flow. There are both pneumatic and electronic types of STLR controllers. It is important to note that the FDD operates on the measured temperature, not time, at the end of the holding period. Holding time can only be ensured by measuring the flow rate of the pump based on the length of the holding tube. There are two types of FDDs, a single stem, old-style valve system that has the disadvantage that it cannot be cleaned-in-place, and a dual stem system, which consists of two valves in series for additional fail-safe protection. This FDD can be cleaned-in-place and is more suited for automation. Improperly heated milk flows through the diverted flow line of the FDD back to the raw milk constant level tank. Properly heated milk flows through the forward flow part of the FDD to the pasteurized milk regenerator section where it gives up heat to the raw product and in turn is cooled approximately  $32\text{--}9^{\circ}\text{C}$ . The warm milk passes through the cooling section where it is cooled to  $4^{\circ}\text{C}$  or below by coolant on the opposite sides of the thin, stainless steel plates. The cold, pasteurized milk passes through a vacuum breaker at least 30 cm above the highest raw

milk in the HTST system, to break any downstream vacuum that might affect the pressure differential in the regenerator, then on to a storage tank or directly to a packaging line.

For continuous pasteurizing, it is important to maintain a higher pressure on the pasteurized side of the heat exchanger. By keeping the pasteurized milk at least 7 kPa higher than raw milk in regenerator, it prevents contamination of pasteurized milk with raw milk in the event that a pin-hole leak develops in the thin stainless steel plates. This pressure differential is maintained using a timing pump in simple systems, and using differential pressure controllers and back pressure flow regulators at the chilled pasteurization outlet in more complex systems. The position of the timing pump is crucial so that there is suction on the raw side of the regenerator and milk is pushed under pressure through the pasteurized side of the regenerator. In addition, there are several other factors involved in maintaining the pressure differential:

- The balance tank overflow level must be less than the level of lowest milk passage in the regenerator, so that no head pressure can act on the raw side of the regenerator.
- A properly installed booster pump is all that is permitted between the balance tank and the raw side of the regenerator.
- No pump is permitted after the pasteurized milk outlet and before the vacuum breaker.
- There must be greater than a 30 cm vertical rise to the vacuum breaker.
- The raw regenerator must drain freely to the balance tank at shut-down.

The balance tank, or constant level tank, provides a constant supply of milk. It is equipped with a float valve assembly that holds the liquid level nearly constant ensuring uniform head pressure on the product leaving the tank. The overflow level must always be below the level of lowest milk passage in the regenerator. This helps to maintain a higher pressure on the pasteurized side of the heat exchanger. The balance tank also prevents air from entering the pasteurizer by placing the top of the outlet pipe lower than the lowest point in the tank and creating downward slopes of at least 2%. The balance tank also provides a means for recirculation of diverted milk or pasteurized milk, should there be an interruption in downstream flow (e.g. a full storage tank).

Heating and cooling energy can be saved by using a regenerator, which is one of the main design elements of the plate heat exchanger system. The regenerator utilizes the heat content of the pasteurized milk to warm the incoming cold raw milk and likewise the cooling capacity of the cold raw milk to cool the hot pasteurized milk. Its efficiency may be calculated as follows:

$$\% \text{ regeneration} = \text{temperature increase due to regenerator} / \text{total temperature increase}$$



For example: Cold milk entering the system at 4°C, after regeneration at 65°C, and final temperature of 72°C would have an 89.7% regeneration:

$$(65 - 4)/(72 - 4) \times 100\% = 89.7\%$$

Larger systems may operate a booster pump, a centrifugal “stuffing” pump which supplies raw milk to the raw regenerator for the balance tank. It must be used in conjunction with a pressure differential controlling device and operates only when the timing pump is operating, proper pressures are achieved in the regenerator, and the system is in forward flow.

Homogenizers (see below) are frequently incorporated into the flow of the continuous pasteurizer. The homogenizer may be used as timing pump, as it is a positive pressure pump. If it is used in addition to a timing pump, then it cannot supplement flow. Free circulation from outlet to inlet is required and the speed of the homogenizer must be greater than the rate of flow of the timing pump.

#### 4. UHT STERILIZATION

Although pasteurization conditions effectively eliminate potential pathogenic microorganisms, they are insufficient to inactivate the thermo-resistant spores in milk. The term sterilization refers to the complete elimination of all spoilage microorganisms. Milk can be made commercially sterile by subjecting it to temperatures in excess of 100°C, and packaging it in air-tight containers. The basis of ultra-high temperature (UHT) processing is the continuous-flow sterilization of food before packaging, then filling into pre-sterilized containers in a sterile atmosphere. Milk that is processed in this way uses temperatures exceeding 135°C and a holding time of 1–5 s, resulting in sterilization but preservation of many of the quality attributes of the milk compared to retort (canning) sterilization.

There are two principal methods of UHT treatment, via direct or indirect heating. With direct heating systems, the product is heated by direct contact with steam of potable or culinary quality. The main advantage of direct heating is that the product is held at the elevated temperature for a shorter period of time. For a heat-sensitive product such as milk, this means less quality deterioration. Direct heating can be accomplished with injection or infusion heaters. With injection, high-pressure/high-temperature steam is injected into pre-heated liquid by a steam injector, leading to a rapid rise in temperature. After holding, the product is flash-cooled in a vacuum to remove water equivalent to the amount of steam that condensed into the product. This method allows fast heating and cooling but is only suitable for some products. It is energy intensive and because the product comes in contact with hot equipment, there is potential for flavor damage. Infusion heaters operate by pumping the liquid product stream through a distributing nozzle into a chamber of high-pressure steam.

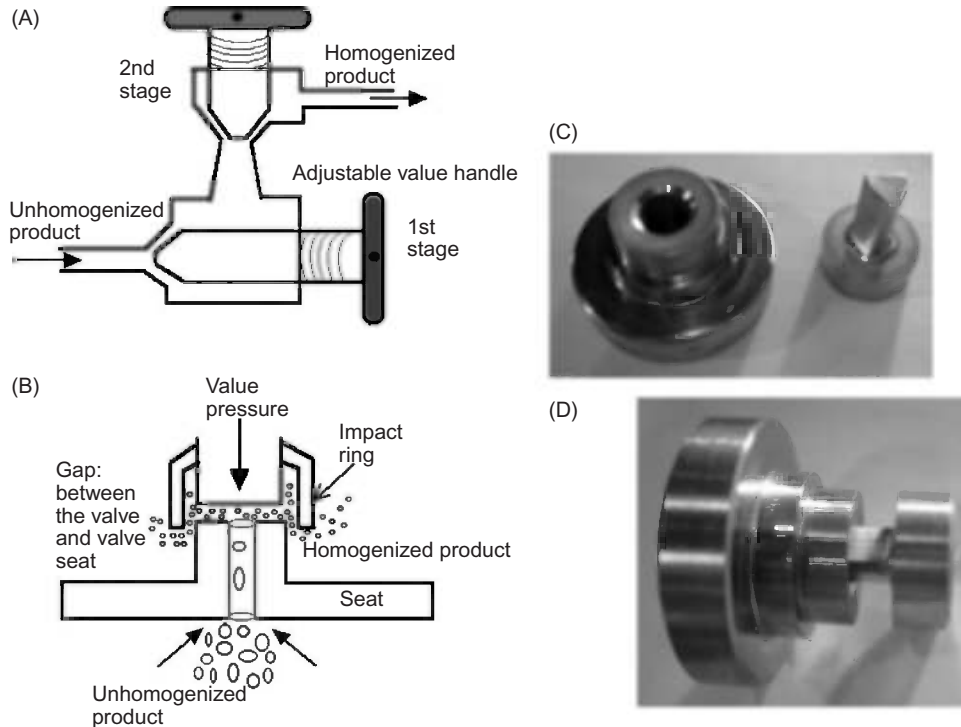
This system is characterized by a large steam volume and a small product volume, distributed into a large surface area of product. Product temperature is accurately controlled via pressure. Flash cooling in a vacuum chamber follows, leading to instantaneous heating and rapid cooling, with no localized overheating.

In indirect heating systems, the heating medium and product are not in direct contact, but separated by equipment contact surfaces. Several types of heat exchangers can be used, but plate and tubular systems are most common in the dairy industry. Plate heat exchangers are similar to those used in HTST systems but operating pressures are limited by gaskets. Liquid velocities are low, which could lead to uneven heating and burn-on. This method is economical in floor space, easily inspected, and allows for potential regeneration. Tubular heat exchangers, e.g. shell and tube, shell and coil or double tube, have fewer seals involved than with plates. This allows for higher pressures, thus higher flow rates and higher temperatures. The heating is more uniform but surfaces are difficult to inspect.

## 5. HOMOGENIZATION

Milk is an oil-in-water emulsion, with the fat globules dispersed in a continuous skim milk phase. If cold raw milk were left to stand, however, the fat would rise and form a cream layer. Homogenization is a mechanical treatment of the fat globules in milk that is brought about by passing hot milk (so the fat is melted) under high pressure through a tiny orifice, which results in a decrease in the average diameter and an increase in number and surface area of the fat globules. The net result, from a practical view, is a greatly reduced tendency for creaming of fat globules. Three factors contribute to this enhanced stability of homogenized milk: a decrease in the mean diameter of the fat globules (a factor in Stokes' Law, see 2. Clarification, separation, and standardization), a decrease in the size distribution of the fat globules (causing the speed of rise to be similar for the majority of globules such that they do not tend to cluster during creaming), and an increase in density of the globules (bringing them closer to the density of the continuous phase) due to the adsorption of a protein membrane. In addition, heat pasteurization inactivates the cryo-globulin complex, which tends to cluster fat globules causing them to rise.

The homogenizer consists of a three-cylinder positive displacement piston pump and the homogenizing valve (Figure 9.6). Capacities may be in the range of 20,000 L/h. Operating pressures are approximately 12–16 MPa. The large-capacity pump is required to drive milk through the tiny orifice of the homogenizing valve, which creates a very large flow restriction. An odd number of pistons (almost always three) ensures constant outlet flow rate. Liquid velocity across the homogenizing valve increases from about 4 to 6 m/s to 120 m/s in about 0.2 ms. The liquid then moves across the face of the valve seat, where the fat globule disruption actually occurs, and



**Figure 9.6 Homogenizing valve for dairy products.** (A) Flow of product through the valve assembly, showing incoming unhomogenized product from the pump passing through the first and second stages before exiting. (B) Schematic diagram of the homogenizing valve. (C and D) Pictures of homogenizing valve depicted in B.

exits in about 50  $\mu\text{s}$ . It is most likely that a combination of turbulence and cavitation explains the reduction in size of the fat globules during the homogenization process. Energy dissipating in the liquid going through the homogenizer valve generates intense turbulent eddies of the same size as the average globule diameter. Globules are thus torn apart by these eddy currents reducing their average size. There is also a considerable pressure drop with the change of velocity of the milk. Liquid cavitates because its vapor pressure is attained. Cavitation generates further eddies that would produce disruption of the fat globules. The product may then pass through a second stage valve similar to the first stage. Although most of the fat globule reduction takes place in the first stage, there is a tendency for clumping or clustering of the reduced fat globules (due to incomplete surface coverage of protein). The second stage valve permits the separation of those clusters into individual fat globules. Typical pressures in the second stage are 3–4 MPa.

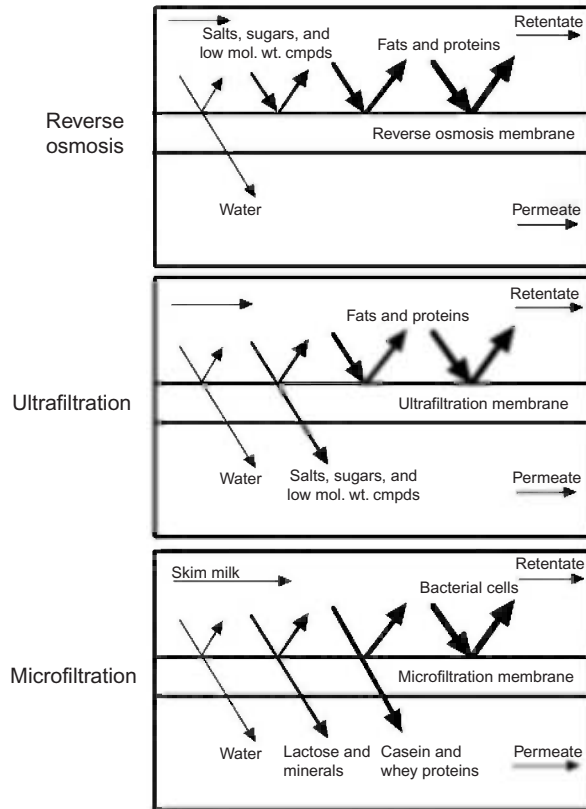
Variables affecting the success of homogenization include: type of valve, operating pressure, single or two-stage configuration, fat content and original fat globule size of

the product being homogenized, the presence of surfactant, viscosity of the product, and homogenizing temperature. The milk fat globule has a native membrane from the time of secretion. During homogenization, there is a tremendous increase in surface area, which the native milk fat globule membrane is insufficient to cover. However, there are many amphiphilic molecules present from the milk plasma that readily adsorb: casein micelles (partly spread) and whey proteins. The interfacial tension of raw milk is 1–2 mN/m, immediately after homogenization it is unstable at 15 mN/m, and shortly after becomes stable (3–4 mN/m) as a result of the adsorption of protein. Adsorbed protein content is typically 10 mg/m<sup>2</sup> at a thickness of approximately 15 nm.

## 6. MEMBRANE PROCESSING

Membrane processing is a technique that permits concentration and separation of components in milk without the use of heat. Particles are separated on the basis of their molecular size and shape with the use of pressure and specially designed semi-permeable membranes. Membrane configurations include tubular (shell and tube), spiral wound, and plate and frame types of equipment. In larger-scale operations, multiple membrane cartridges are placed in series for sufficient volume throughput. In the dairy industry, membrane processing is being used, for example, to concentrate milk prior to transportation or drying (reverse osmosis), to separate proteins from milk whey for the production of milk or whey protein concentrate (ultrafiltration), and to remove bacteria from milk without the use of heat (microfiltration) (Figure 9.7). Skim milk is generally processed through membrane systems rather than whole milk, as the fat results in high levels of fouling of the membranes.

The pore size of a reverse osmosis (RO) membrane is very small, such that only water passes through. With the use of sufficiently high pressure, to overcome osmotic pressure of the solutes, water can be driven from the other components. Ultrafiltration (UF) employs membranes of larger pore size, e.g. 10 or 20 kDa molecular weight cut-off (although actual separation is based on hydrated molecular volume), that enable efficient separation at low pressure of low molecular weight solutes (e.g. lactose) from high molecular weight solutes (e.g. proteins). Diafiltration is a specialized type of ultrafiltration process in which the retentate is diluted with water and re-ultrafiltered, to reduce the concentration of soluble permeate components and increase further the concentration of retained components. Microfiltration (MF) is similar to UF but with even larger membrane pore size, allowing particles in the range of 0.2–2 µm to pass through. MF is used in the dairy industry for making low-heat sterile milk as proteins may pass through the membrane but bacteria do not. Thus, bacteria can be concentrated in a small volume of milk, which needs to be sterilized, while permeate from an MF system is essentially bacteria-free but contains all the



**Figure 9.7** Passage of components through different types of membranes used in milk and dairy product processing.

solutes present in milk at the original concentrations. Microfiltered milk for retail sale can have a shelf-life of 28 days or more, depending on packaging and storage conditions.

## 7. EVAPORATION

Evaporation refers to the process of heating liquid to the boiling point to remove water as vapor. The concentrated dairy product may be the desired end-product, or evaporation may be employed as a pre-concentration step prior to spray-drying. Because milk is heat sensitive, heat damage can be minimized by evaporation under vacuum to reduce the boiling point. The basic components of an evaporator consist of a heat-exchanger, a vacuum source, a product-vapor separator, and a condenser for the vapors. The heat exchanger (calandria) transfers heat from the heating medium, usually low-pressure steam, to the product via indirect contact surfaces (coils or tubes).

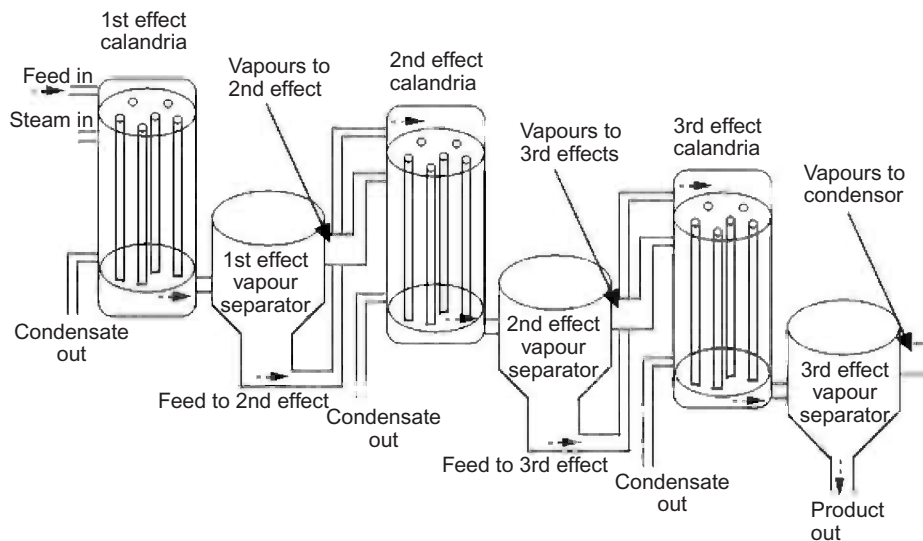
The vacuum keeps the product temperature low and the temperature difference ( $\Delta T$ ) between the heating medium and the evaporating product high. The driving force for heat transfer is the  $\Delta T$  between the steam and the product. Product temperature is a function of operating vacuum, but the boiling point varies with solute concentration and increases as evaporation proceeds. The vapor separator removes the vapors from the concentrated liquid.

Heat exchangers can be of rising-film, falling-film, plate, or scraped-surface configurations, with falling-film being preferred for most modern milk evaporation installations. Rising-film evaporators consist of a heat exchanger of 10–15 m long tubes in a tube chest, which is heated with steam. The liquid rises by percolation from the vapors formed near the bottom of the heating tubes. The thin liquid film moves rapidly upwards. The product may be recycled if necessary to arrive at the desired final concentration. In falling-film evaporators the thin liquid film moves downward under gravity in the tubes. Specially designed nozzles or spray distributors at the feed inlet ensure complete wetting of heat transfer surfaces. The residence time through the tube is 20–30 s as opposed to 3–4 min in the rising film type. The vapor separator is at the bottom, which decreases the product hold-up during shut down. Tubes are 8–12 m long and 30–50 mm in diameter.

Two or more evaporator units can be run in sequence to produce a multiple-effect evaporator (Figure 9.8). Each effect consists of a heat transfer surface and a vapor separator, in addition to the vacuum source and condenser for the entire unit. The vapors from the preceding effect are used as the heat source in the next effect. As such, multiple-effect evaporators are more energy efficient and can evaporate more water per kg steam by re-using vapors as heat sources in subsequent effects. Each effect operates at a lower pressure and temperature than the effect preceding it, so as to maintain a  $\Delta T$  and continue the evaporation procedure. The vapors are removed from the preceding effect at the boiling temperature of the product at that effect so that no  $\Delta T$  would exist if the vacuum were not increased. The operating costs of evaporation are relative to the number of effects and the temperature at which they operate. Systems that compress vapors, either by steam jet thermo-compression or by mechanical vapor recompression, are an alternative to (or can be used in combination with) multiple-effect evaporators for energy efficiency.

## 8. DRYING

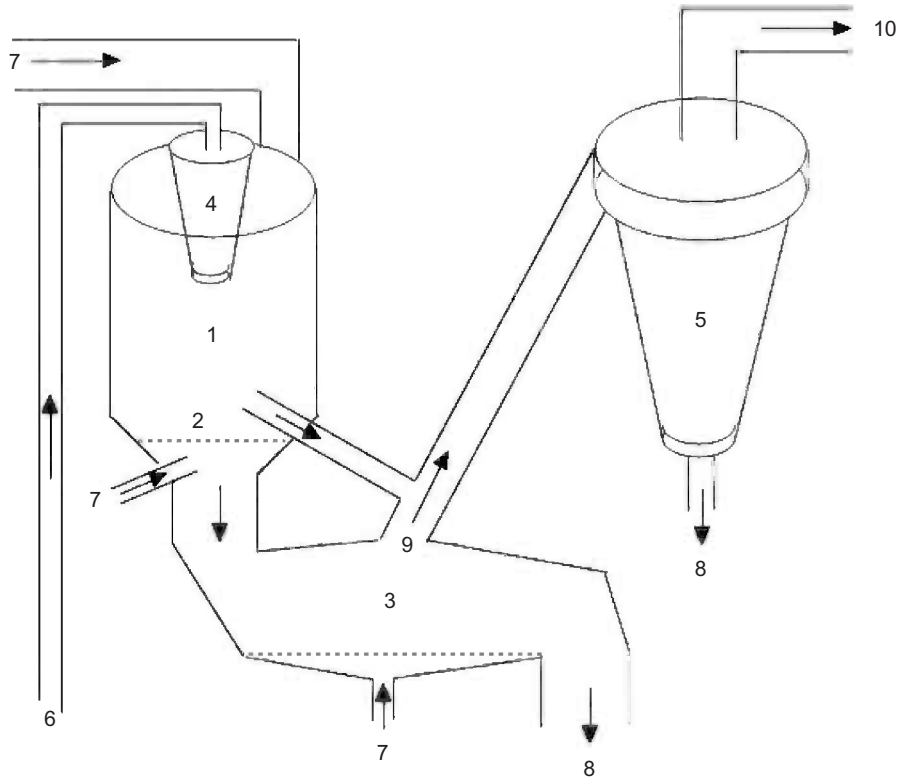
Dehydration by spray-drying is another very important process in the dairy industry. Spray-drying is the method of choice as the feed streams in the dairy industry are always liquid, capable of being atomized in the dryer. After pre-concentration by evaporation to economically reduce the water content of the feed stream and reduce vapor volume, the concentrate is introduced as a fine spray or mist into a drying tower



**Figure 9.8** Flow diagram of product and vapors through a three-effect tubular falling film vacuum evaporator.

or chamber with heated air (Figure 9.9). Atomization greatly increases the surface air exposed to warm air for drying. As the small droplets make intimate contact with the heated air, they flash off their moisture, become small particles, drop to the bottom of the tower and are removed. Spray-drying can be accomplished with a low heat and short time combination, which leads to a high-quality product. Spray-dryers consist of: a high pressure pump for introducing liquid into the tower, a device for atomizing the feed stream, a heated air source with blower, a secondary collection vessel for removing the dried food from the air stream and a means for exhausting the moist air. Instantizing of powders involves a partial re-wetting of powder and re-drying, to allow for agglomeration of the powder to improve wetting and solubility.

It is essential for both economic and environmental reasons that as much powder as possible be recovered from the air stream. In most modern operations, wet scrubbers usually act as a secondary collection system following a cyclone powder separator, but bag filters are still employed in many older-style dryers. Bag filters are very efficient (99.9%), but not as popular due to labor costs, sanitation, and possible heat damage because of the long residence time. Cyclone powder separators are not as efficient (99.5%) as bag filters but several can be placed in series. Air enters at tangent at high velocity into a cylinder or cone, which has a much larger cross-section. Air velocity is decreased in the cone permitting settling of solids by gravity. Wet scrubbers are the most economical outlet air cleaner. The principle of a wet scrubber is to dissolve any dust powder left in the air stream into either water or the feed stream by spraying the wash stream through the air. This also recovers heat from the exiting air and



- 1 1st stage: spray-drying chamber
- 2 2nd stage: integrated fluid bed
- 3 3rd stage: external fluid bed
- 4 Rotary atomizer
- 5 Cyclone air-powder separator
- 6 Feed inlet
- 7 Air inlet
- 8 Powder outlet
- 9 Moist air to cyclone
- 10 Moist air outlet

**Figure 9.9** Schematic diagram of a two-stage spray-dryer showing feed, product dry inlet air, and moisture outlet air streams.

evaporates some of the water in the feed stream (if used as the wash water). Wet scrubbers not only recover most of what would be lost product, but also recover approximately 90% of the potential drying energy normally lost in exit air. Wet scrubbers are designed for a secondary air cleaning system in conjunction with a cyclone.

In standard, single-stage spray-drying, the rate of evaporation is particularly high in the first part of the process, and it gradually decreases because of the falling moisture content of the particle surfaces. In order to complete the drying in one stage, a relatively high outlet temperature is required during the final drying phase, which is



reflective of the particle temperature and thus heat damage. In a two-stage spray-dryer, moist powder can be removed from the drying chamber and final drying takes place in an external fluid bed dryer where the residence time of the product is longer and the temperature of the drying air lower than in the spray dryer. A three-stage spray-dryer has as its second stage a fluid bed integrated into the cone of the first-stage spray-drying chamber (Figure 9.9). Thus it is possible to achieve even higher moisture content in the first drying stage and a lower outlet air temperature from the spray-dryer. The inlet air temperature can be raised, resulting in a larger temperature difference and improved efficiency in the drying process. The third stage is again an external fluid bed, which can be static or vibrating, for final drying and/or cooling of the powder. Multiple-stage spray-drying results in higher quality powders with much better rehydrating properties directly from the drier, lower energy consumption, and an increased range of products that can be spray-dried, e.g. processed cheeses for cheese powders.

## 9. ICE CREAM MANUFACTURING EQUIPMENT

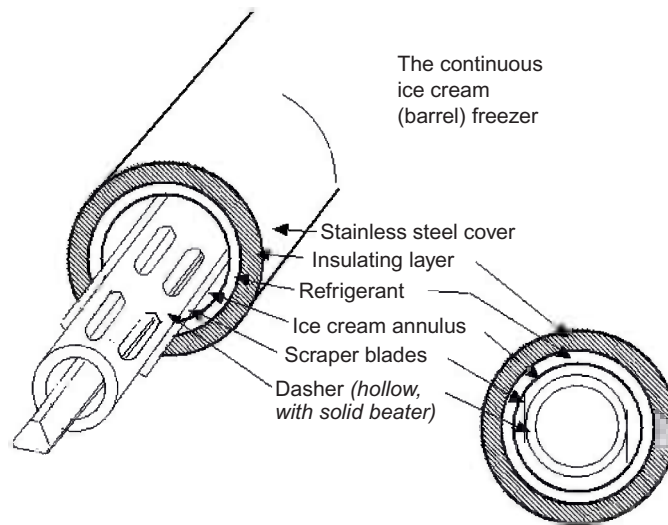
Ice cream processing operations can be divided into two distinct stages, mix manufacture and freezing operations. Ice cream mix manufacture consists of the following unit operations: combination and blending of ingredients, batch or continuous pasteurization, homogenization, and mix aging. Ingredients are usually preblended prior to pasteurization, regardless of the type of pasteurization system used. Blending of ingredients is relatively simple if all ingredients are in the liquid form, as automated metering pumps or tanks on load cells can be used. When dry ingredients are used, powders are added through either a pumping system under high velocity or through a high-shear blender (liquifier), a small chamber with rotating knife blades that chops all ingredients as they are mixed with the liquid that is passing through the chamber via a large centrifugal pump. Both batch and continuous (HTST) systems are in common use for ice cream mix pasteurization. Batch pasteurization systems allow for blending of the proper ingredient amounts in the vat. Following pasteurization, the mix is homogenized and then is passed across some type of heat exchanger (plate heat exchanger or double or triple tube heat exchanger) for the purpose of cooling the mix to refrigerated temperatures (4°C). Continuous pasteurization is usually performed in an HTST heat exchanger following the blending of ingredients in a large feed tank. Some preheating, to 30°C to 40°C, may be necessary for solubilization of the components. This has the effect on the pasteurizer of reducing regeneration capacity and creating a need for larger cooling sections. An aging time of 4 h or greater is recommended following mix processing prior to freezing, primarily to allow for crystallization of the fat globules. Aging is performed in insulated or refrigerated

storage tanks or silos. Mix temperature should be maintained as low as possible (at or below  $5^{\circ}\text{C}$ ) without freezing.

Ice cream freezing also consists of two distinct stages:

1. Passing mix through a swept-surface heat exchanger under high shear conditions to promote extensive ice crystal nucleation and air incorporation.
2. Freezing the packaged ice cream under conditions that promote rapid freezing and small ice crystal sizes. Ice cream texture is largely dependent on having small ice crystal size after manufacture.

Continuous freezers (Figure 9.10) dominate the ice cream industry. Modern freezers are available with capacities up to 4000 l/h. Larger-scale operations would employ multiple freezing units. In this type of process, mix is drawn from the flavoring tank into a swept surface heat exchanger, which is jacketed with a liquid, boiling refrigerant (usually ammonia in larger scale freezers). Incorporation of air into ice cream, termed the overrun, is a necessity to produce desirable body and texture. Overrun is carefully controlled as it greatly affects both texture and yield. In modern systems, filtered compressed air is injected into the mix at controllable rates and is dispersed in the ice cream during the freezing/whipping process. Rotating knife blades and dashers keep the product agitated and prevent freezing on the side of the barrel. Residence time for mix through the annulus of the freezer varies from 0.4 to 2 min, freezing rates can vary from  $5^{\circ}\text{C}$  to  $27^{\circ}\text{C}$  per min, and draw temperatures of  $-6^{\circ}\text{C}$  can easily be achieved. Batch freezing processes differ slightly from the continuous systems just



**Figure 9.10** Schematic diagram of an ice cream continuous freezer. Mix enters at the rear and freezes and incorporates air bubbles as it passes through the ice cream annulus while being agitated and scraped from the wall.

described. The barrel of a batch swept surface heat exchanger is jacketed with refrigerant and contains a set of dashers and scraper blades inside the barrel. It is filled to about one-half volume with the liquid mix. Barrel volumes usually range from 2 to 12 l. The freezing unit and agitators are then activated and the product remains in the barrel for sufficient time to achieve the desired degree of overrun and stiffness. Batch freezers are used in smaller operations where it is desirable to run individual flavored mixes on a small scale or to retain an element of the “homemade”-style manufacturing process. They are also operated in a semi-continuous mode for the production of soft-serve type desserts. A hopper containing the mix feeds the barrel as product is removed.

Flavoring and coloring can be added as desired to the mix prior to passing through the barrel freezer, and particulate flavoring ingredients, such as nuts, fruits, candy pieces, or ripple sauces, can be added to the semi-frozen product at the exit from the barrel freezer prior to packaging and hardening. Centrifugal pumps are employed to pump variegate sauces through a rippling nozzle into semi-frozen ice cream. Ingredient feeders are designed to allow a controllable flow of particulates (fruits, nuts, etc.) to be mixed with semi-frozen ice cream. The flow of particulates can be tied automatically to the flow rate of ice cream from the continuous freezer. For larger particulates (e.g. candy or bakery pieces), a shaker table can be used, rather than a hopper with auger configuration, to prevent break-up of the delicate particulate ingredients.

Following dynamic freezing, ingredient addition, and packaging, the ice cream packages are immediately transferred to a hardening chamber ( $-30^{\circ}\text{C}$  or colder, either forced air convection, spiral tunnel configuration or plate-type conduction freezers) where the majority of the remaining water freezes. Rapid hardening is necessary to keep ice crystal sizes small. Following rapid hardening, ice cream storage should occur at low, constant temperatures, usually  $-25^{\circ}\text{C}$ .

A new development in ice cream processing involves low-temperature extrusion. Ice cream from the continuous freezer at  $-5^{\circ}\text{C}$  travels through a refrigerated single- or twin-screw extruder for the purpose of extracting more latent heat and cooling the product to temperatures of  $-12$  to  $-14^{\circ}\text{C}$  under more energy-efficient conditions than normal hardening. Ice crystal sizes and air bubble sizes are smaller as a result of this process compared to normal hardening, so ice cream quality can also be improved.

More complete descriptions of ice cream making equipment can be found in [Marshall \*et al.\*, 2003](#).

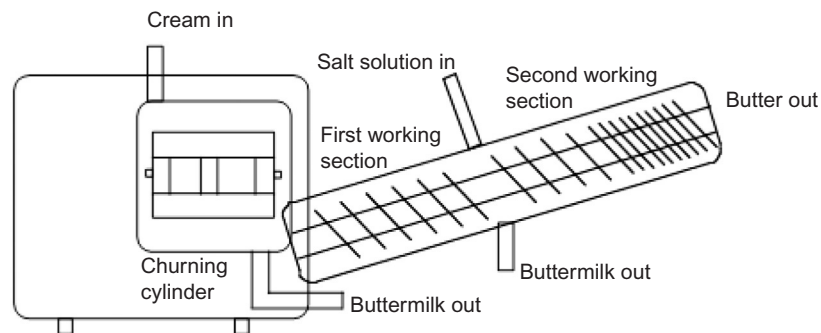
## 10. BUTTER MANUFACTURING EQUIPMENT

The buttermaking process involves quite a number of stages. Cream can be either supplied by a fluid milk dairy or separated from whole milk by the butter manufacturer. If cream is separated by the butter manufacturer, skim milk from the separator is usually destined for concentration and drying. Cream is pasteurized at a temperature of

95°C or more, to destroy enzymes and microorganisms that would impair the keeping quality of the butter. Cold-aging of cream ensures that the appropriate fat crystalline structure is obtained for optimum churning. From the aging tank, the cream is pumped to the churn (Figure 9.11) via a plate heat exchanger, which brings it to the required temperature. In the churning process the cream is agitated to cause clumping of the fat globules and production of the butter grains, while the fat content of the remaining liquid, the buttermilk, decreases. Modern continuous churns are capable of processing up to 10,000 kg/h. The cream is first fed into a churning cylinder fitted with beaters that are driven by a variable speed motor. Rapid inversion of the fat globules takes place in the cylinder and, when finished, the butter grains and buttermilk pass on to a draining section. After draining the buttermilk, the butter is worked to a continuous fat phase containing a finely dispersed water phase. During working, fat moves from globular to free fat. Water droplets decrease in size during working and should not be visible in properly worked butter. The working of the butter commences in the draining section by means of a screw, which also conveys it to the next stage. On leaving the working section the butter passes through a conical channel to remove any remaining buttermilk. Following this stage, salt may be added through a high-pressure injector. The third section in the working cylinder may be connected to a vacuum pump, to reduce the air content of the butter. In the final or mixing section the butter passes a series of perforated discs and star wheels. There is also an injector for final adjustment of the water content. The finished butter is discharged into the packaging unit, and packaged butter moves on to cold storage.

## 11. CHEESE MANUFACTURING EQUIPMENT

Despite the wide variety that exists in cheeses, there are a number of common steps to the cheesemaking process. These include coagulation of the milk, cutting of the



Continuous Butter Churn

**Figure 9.11** Schematic diagram of a continuous butter churn.

curd, cooking, whey draining, placing curd in cheese molds, and pressing the molds. The cheese vat is central to the first five of these. Following clarification/standardization of milk and sub-pasteurization heat treatment or pasteurization, milk is pumped into jacketed, temperature-controllable vats. Conventional vats are usually rectangular and open top. Manual manipulation of milk gel (e.g. setting, cutting) and milk curd (e.g. draining, cheddaring) takes place over the side of the shallow vat. Sizes may vary from 500 to 20,000 l. Milk is coagulated in the vat via bacterial fermentation and addition of rennet. Following gelation, the milk gel is cut into cubes of  $\sim 0.5$  cm, using a series of horizontal and vertical wire-strung knives. Whey is expelled from the cubes, producing curds, which continue to shrink and expel whey (synerese) with cooking. Once cooking is complete, depending on the cheese variety and desired moisture content of the curd, whey is drained. Curds are allowed to sit together and knit into a structure at warm temperature. This solid curd can then be milled (cut into slices as in cheddar processing), salted, melted and stretched in water, collected into molds (hoops), etc., depending on the cheese variety. Hoops are normally pressed under pressure to complete curd knitting and create cud blocks and to expel further whey from the cheese block.

Modern cheese plants have automated extensively compared to manual vat operations. Performing the cheesemaking operations in stages in setting and finishing vats reduces processing time. Enclosed, cylindrical vats allow for improved automation and control of the various unit operations while improving hygiene and energy efficiency. Dual-agitators combine both stirring (with one direction of rotation and blunt ends of the knife/agitator) and gel cutting (with the other direction of rotation where sharpened ends of the agitators produce cutting of the gel). Curd fines recovery from whey has been greatly improved, for enhanced yield. Pneumatic curd conveying to curd handling operations reduces curd damage. Draining-matting conveyors with porous belts are employed for continuous operation. In the manufacture of cheddar, milling of curd for salting occurs in-line in the continuous belt system. Automatic block forming, e.g. cheddaring towers, can also be utilized. The weight of gravity of the curd in the tower as well as the application of vacuum ensures that a tight, uniform block is produced at the bottom. Blocks of 18–20 kg are cut from the bottom in such continuous block-forming units. Modern continuous lines for cheddar can produce up to 12,000 kg/h.

## REFERENCES

- 3A Sanitary Standards Inc., Mclean, Virginia, USA. <[www.3-a.org](http://www.3-a.org)>.  
Britz, T.J., Robinson, R.K. (Eds.), 2008. *Advanced Dairy Science and Technology*. Blackwell, Publishing, Oxford, UK.  
Bylund, G., 1995. *Dairy Processing Handbook*. TetraPak Processing Systems AB, Lund, Sweden.

- Caudill, V., 1993. Engineering: plant design, processing and packaging. In: Hui, Y.H. (Ed.), Dairy Science and Technology Handbook, Vol. 3, Applications Science, Technology and Engineering. VCH Publishers, New York, pp. 295–329. (Chap. 5).
- Gilmore, T., Shell, J., 1993. Dairy equipment and supplies. In: Hui, Y.H. (Ed.), Dairy Science and Technology Handbook, Vol. 3, Applications Science, Technology and Engineering. VCH Publishers, New York, pp. 155–294. (Chap. 4).
- Marshall, R.T., Goff, H.D., Hartel, R.W., 2003. Ice Cream, sixth ed. Kluwer Academic, New York.
- Walstra, P., Wouters, J., Guerts, T., 2005. Dairy Science and Technology, second ed. CRC Press/Taylor and Francis, Boca Raton, FL.

This page intentionally left blank

# Grain Process Engineering

Imran Ahmad and Athapol Noomhorm

Asian Institute of Technology, Thailand

## 1. DRYING

There are several methods available for drying grains. Shrinkage, bulk density, particle density and bed porosity are the major physical property changes taking place during the drying process. These properties vary during drying because of moisture removal, structural shrinkage, and internal collapse. Among several drying techniques commonly used for particulate materials, fluidized bed drying has garnered attention because of its potential advantage over fixed bed drying. Lower shrinkage is observed in fluidized bed drying compared to fixed bed drying, probably as a result of case hardening at high temperature and changes in visco-elastic properties. Moreover, because fluidized bed drying is rapid, it can be considered an economical drying method compared with other drying techniques.

Considerable work has been done on development of fluidized bed dryers, which is reviewed in this chapter. However, there have also been several novel approaches to dry paddy to a reasonably safe storage levels immediately after harvesting at farms. This became necessary because of poor infrastructure of transportation and storage facilities. The purpose of such small-scale dryers is to boost profit margins for farmers by removing moisture by up to 2–4%.

### 1.1 On-Farm Drying

A rice combine harvester usually performs with less loss of paddy; however, the potential shortcoming is that the paddy must be harvested at high moisture content, i.e. ranging from 20% to 28%. The high moisture content of harvested paddy is conducive to rapid deterioration in quality such as discoloration, yellowing, germinating, and damage to milling quality.

The only practical means of preventing grain quality deterioration is immediate drying of high moisture paddy, because sun drying, the conventional method, is inadequate to guarantee the quality and quantity of the produce. Thus, there is a high demand for mechanical drying facilities.



Most mechanical dryers available are suitable for rice millers and farm cooperatives that handle thousands of tons of paddy. Small-scale dryers were developed for farm use, such as a fixed bed dryer and solar rice dryer (Exell and Kornsakoo, 1977); however, those were not widely accepted because of the potential inconvenience in loading/unloading of paddy and unequal drying.

Jindal and Obaldo (1986) and Puechkamutr (1988) worked on accelerated drying of high moisture paddy using conduction heating for a rotary dryer. Their studies demonstrated the potential of high temperature for quick drying of paddy without significant damage to the grain. This technique is promising from an energy consumption point of view.

Puechkamutr (1985) developed a rotary dryer for paddy based on conduction and natural convection heating. Paddy was effectively dried from moisture content of 23% to 16% (w.b.) using a pipe heat exchanger at surface temperatures of 170°C to 200°C with a residence time of 30–70 seconds. Rapid drying and good milling quality of the paddy could be achieved with such a dryer.

A combination conduction–convection heating type rotary dryer was developed for on farm drying as a first stage. It consisted of double cylinders: the external cylinder with 500 mm diameter, attached to an inside surface with straight flight; and an inner cylinder, hexagonal in shape with an outer tray and firing device installed inside as a part of the inlet cylinder. The grain cascaded inside the external cylinder with a concurrent flow of air. Experimental results showed that about 3% of moisture content could be removed with single pass with a small reduction in milling quality (Likitrattanaporn, 1996).

Another study of a combined conduction–convection type rotary drum dryer was made by Regalado and Madamba (1997) on thermal efficiency. The fresh ambient air forced inside the drum in a counter flow direction of grain brought evaporative cooling of the hot grain as shown by the increase in moisture reduction whenever air velocity was increased.

A further improved prototype of a combined conduction–convection type rotary drum dryer used ambient air which was forced inside the drum in counter flow to the direction of the cascading grains. The grain was heated by conduction heating as drying proceeded and followed by convection heating as cooling occurred of the heated grain. The results showed that its partial drying capacity was approximately double that of the pre-dryer developed by the International Rice Research Institute (IRRI) requiring only a single pass operation. Neither drum surface temperature nor ambient air velocity and their interaction influenced total milling recovery and head rice recovery.

### **1.1.1 Combined Conduction–Convection Heating Rotary Dryer**

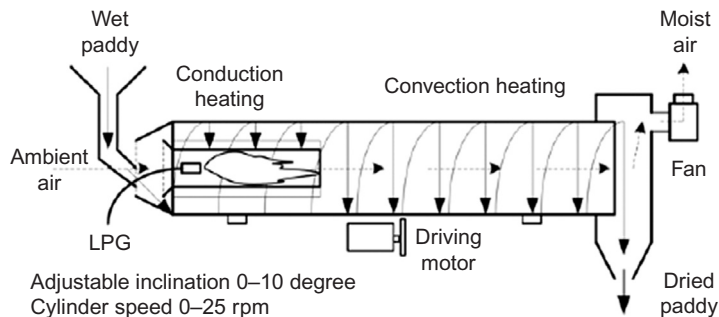
Likitrattanaporn *et al.* (2003) designed and developed a combined conduction and convection heating rotary dryer for 0.5 ton hr<sup>-1</sup> capacity using liquefied petroleum

gas (LPG) as the heat source, in order to dry high moisture paddy under farm conditions. The main aim was to find an affordable way of drying field paddy on the day of harvesting to facilitate handling and for higher returns of produce for the farmer. Emphasis was placed on operating conditions in which up to 3% moisture could be removed in a short time while grain quality should be closed to fresh paddy. Performance of the rotary dryer in terms of moisture removal, residence time, energy consumption, and milling quality were evaluated.

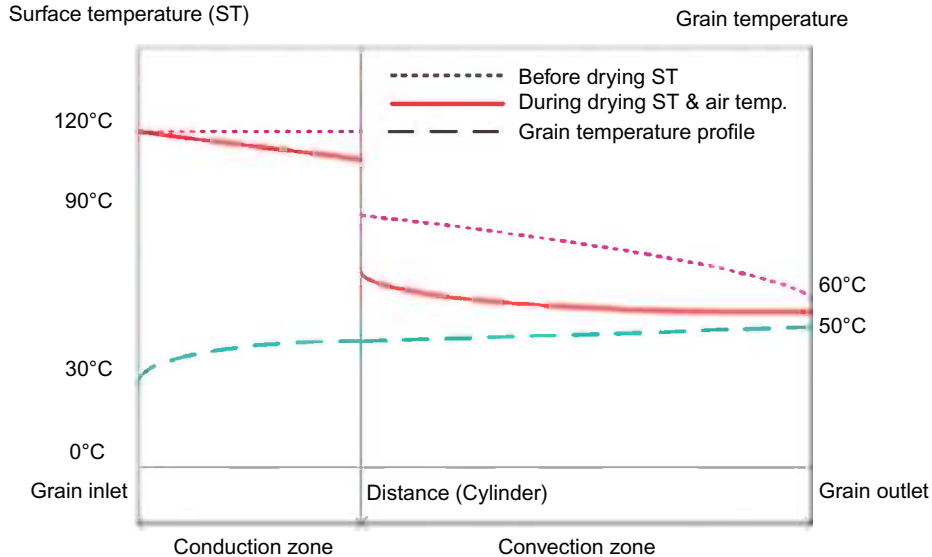
An experimental rotary dryer designed with concurrent flow system comprising two primary parts; a double cylinder and a discharge cover is shown in Figure 10.1. Forward movement of paddy takes place by inclination angle and rotary motion of the cylinder, while air is blown through the cylinder by the suction fan located on top of the discharge cover. A one horse power motor with 1:60 reduction gear was used for driving the rotary dryer. The LPG lamp on the entry end heats the air and heated air moves to other end by suction fan. During forward motion, paddy first contacts the outer surface of the inner cylinder where conduction heating takes place followed by a cascading action along the inside of the external cylinder resulting in convection heating. After this the paddy falls into the discharge cover and out of the dryer, while the suction fan sucks the moist air.

Relatively less moisture was removed during the last (third) pass at temperatures of 100°C and 110°C, i.e. 1.5% and 1.7%, respectively. At 120°C temperature, moisture content of 2.1% could be removed. Clearly, this is because there was less free water available at the third pass of drying.

The conduction and convection zones are shown in Figure 10.2, along with the inlet and outlet temperatures of grain and the hot air. It can be seen that high temperature in the conduction zone can remove a higher amount of water than in the convection zone which is, in turn, sucked out by hot moist air. It can also be observed that outlet grain temperature was dropped to the safe range (max. 52°C) within a very short time (2–3 min).



**Figure 10.1** A schematic drawing of combined conduction and convection type rotary dryer. (Courtesy: Likitrattanaporn et al., 2003)



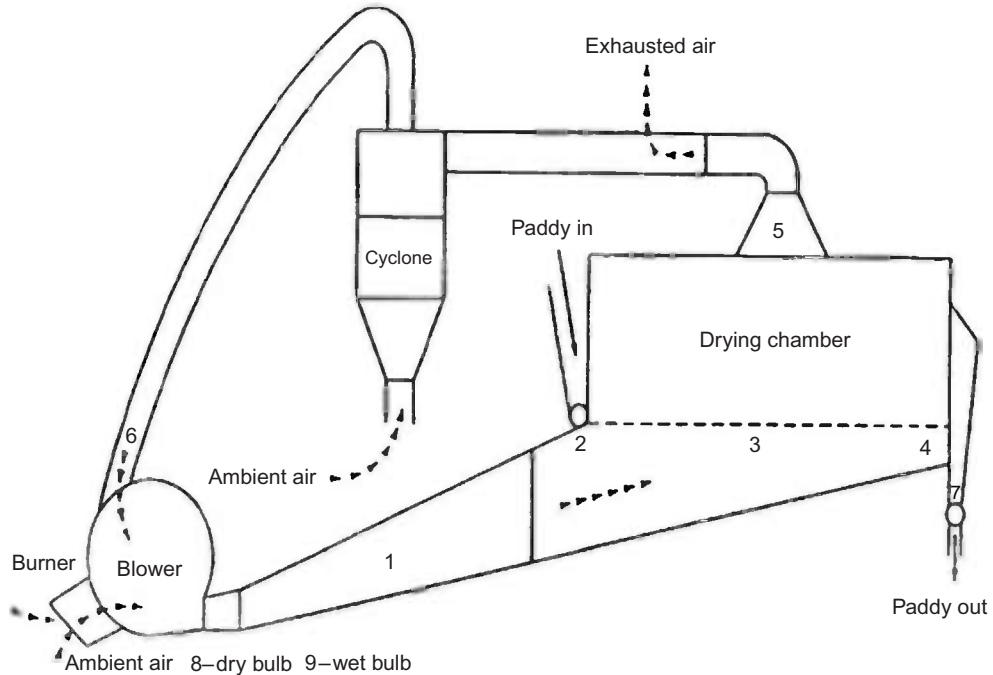
**Figure 10.2** Temperature profile during conduction and convection.

To demonstrate the dryer's heat exchange efficiency, comparison of the effects of conduction heating and convection heating on moisture removal showed that the major moisture content of paddy was removed by the conduction heating for all temperatures, whereas the convection heating could remove moisture less than 0.4%.

Being designed as a mobile unit for drying paddy in the field, energy consumption is one of the most important aspects of consideration. The difference in weight before and after running a pass was recorded. A statistically insignificant difference was found in weight of LPG consumed at all temperatures. The average power consumption was, however, 0.6 KWh and power of 0.46 kg/hr LPG. It was estimated that the operating cost of removing up to 1% of the moisture content of 1 tonne of paddy was 0.23\$ in the first pass. The cost would increase up to 0.33\$ in the second pass, and subsequently increase in the third pass depending on the availability of free moisture.

## 1.2 Fluidized Bed Dryers

The fluidized bed grain dryer is now fully commercialized in several countries. Its potential is great especially for high moisture grains such as paddy, parboiled rice, maize, and soybean. Its drying rate is very fast compared to conventional grain dryers. Consequently, the size of drying unit is very compact relative to its capacity. Its energy consumption is relatively low while grain quality is maintained. A comprehensive review on fluidized bed dryers has been done by [Soponronnarit \(2003\)](#), with the emphasis on research and development efforts on fluidized bed grain drying especially



**Figure 10.3** Schematic diagram of fluidized bed dryer for paddy. (Courtesy: [Soponronnarit 2003](#))

in Thailand, starting with an experimental batch dryer and culminating with a commercial continuous-flow dryer. A mathematical model of the fluidized bed grain drying system including a series of drying, tempering, and ambient air ventilation is also described. A typical fluidized bed is depicted in [Figure 10.3](#).

The fluidized bed paddy dryer is competitive to conventional hot air dryers especially at high moisture level, i.e. low energy consumption, low cost, and acceptable paddy quality. Important operating parameters are: drying air temperature of 140–150°C, fraction of air recycled of 0.8, air velocity around 2.0–2.3 m/s and bed thickness of 10–15 cm. Under proper conditions such as high initial moisture content of paddy (higher than 30%) and high air temperature (140–150°C), head yield can be increased up to 50% compared to ambient air drying. For consumer acceptance, tested rice with fluidized bed drying is not significantly different from that dried by ambient air. For other grains, the fluidized bed dryer has great potential for commercialization. Many units have been used in parboiled rice mills, a few for the maize and soybean industries. Experimental results obtained from commercial fluidized bed dryers show good performance and good product quality with a significant spin-off that urease activity in soybean kernel could be reduced to a level acceptable to the animal feed industry.

## 2. PRE-STORAGE GRAIN TREATMENTS

### 2.1 Grain Damage from Insects

In Southeast Asia, post-harvest losses are around 10–37%, out of which 2–6% losses occurring during rice storage have been reported as mainly due to insects. An increase in insect numbers results into reduction in grain weight, heating and spoilage of grain, reduction in seed germination, and contamination with insect fragments, feces, webbing, ill-smelling metabolic products inducing stinking odor. An increase of insects correlates with increase in grain weight loss, decrease in grain moisture content, increase in temperature because of increased respiration and increase in damage to kernels (Osman, 1984; Sidik and Pedersen, 1984). Insect infestation also causes a deterioration in grain quality. Nutritional value in terms of thiamin content decreased in infested wheat (Venkatrao *et al.*, 1960) together with changes in physiochemical properties including weight, density, increased uric acid and fat acidity, increased moisture content and changes in crude fat, calorific value, true proteins, ash, crude proteins, crude fiber and non-proteins (Samuels and Modgil, 1999). Rheological parameters of infested flour were also changed (Lorenz and Meredith, 1988). Bread made from infested wheat flour had poor properties because gluten was brittle and darkening of the crumb and occurrence of distinct offensive taste and odor was observed (Smith *et al.*, 1971; Venkatrao *et al.*, 1960). Some types of insects, e.g. weevils, feed on endosperm so carbohydrate was removed (Irabagon, 1959), whereas protein, ash and lipid content in corn increased (Barney *et al.*, 1991). Increased loss of starch in gruel during cooking and an increase in free fatty acid were observed in infested milled rice with weevils but thiamine content decreased (Pingale *et al.*, 1957; Swamy *et al.*, 1993). A decrease in pasting viscosity and increase in swelling ability were observed in infested rice starch (Kongseree *et al.*, 1985).

The extent of insect damage varies according to insect population. Environmental conditions in grain storehouses play an important role in insect growth and increase of the population. High relative humidity in the storage warehouse increases moisture content of stored milled rice, which favors the development of high infestations of rough rice (Breese, 1960). Relative humidity ranging from 40% to 85% and temperature from 20°C to 40°C are optimum conditions for growth of stored product insects for rice such as rice weevils, maize weevils, red flour beetles and lesser grain borers (Dobie *et al.*, 1984). Besides population, severity of insect damage depends on the grain resistance to insects. In rice, presence of tight hull, degree of milling, grain hardness, amylose content, gelatinization temperature, alkali spreading value and grain moisture content all contribute to differences in grain resistance to insects (Bhatia, 1976; Juliano, 1981; Rout *et al.*, 1976; Russell and Cogburn, 1977).

A brief description of several insect control operations is given below.

### 2.1.1 Chemical Fumigation

Bags of milled rice are stacked and covered with gas proof sheets to which fumigants are then added for elimination of insects. The most common fumigants are phosphine and methyl bromide. However, chemical fumigation has an uncertain future because of limitations in terms of insect resistance, toxicological findings, and consumer concerns on health and environment (Banks, 1987). Methyl bromide was phased out by 2001, and phosphine is not a preferred medium for millers because of the long time required for fumigation. For fumigation, at more than 25°C, phosphine takes a minimum of 7 days to be effective against all stages of all stored product pests (Winks *et al.*, 1980).

Susceptibility to phosphine varies by life stages (Howe, 1973) and insect species (Hole *et al.*, 1976). Phosphine efficiency at killing insects depends on exposure time rather than phosphine concentration (Reynolds *et al.*, 1967; Soekarma, 1985). ACIAR (1989) recommended an application dosage rate of 1.5 (g/m<sup>3</sup>) or 2 g/tonne rice with minimum exposure periods of 7 days (above 25°C) and 10 days (15–25°C) for complete kill of insects.

Fumigants can have unwanted and adverse effects on treated commodities in terms of germination, taste, odor, appearance, texture of grains, processing parameters, mold growth, and mycotoxin formation (ACIAR, 1989). Extensive effects of chemical fumigation on wheat, flour, and bread properties have been revealed (Calderon *et al.* 1970; Matthews *et al.*, 1970; Polansky and Toepfer, 1971). Response to fumigants may be dependent on commodity type and variety, water activity, temperature, gas concentration, and exposure time (Annis and Graver, 1991).

### 2.1.2 Heat Treatment

Heat disinfestation systems can be designed and developed to preserve a balance between heat dose, insect mortality, and deterioration of grain quality. Many types of heat source have been introduced to kill insects. Hot air convection heating using a fluidized bed dryer was applied to disinfest wheat (Dermott and Evans, 1978). Exposure times of 12, 6 and 4 minutes at air temperatures of 60°C, 70°C, and 80°C, respectively, were sufficient to induce complete disinfestation. Using a spouted bed dryer, an increase in air temperature from 80°C to 100°C, and decrease in exposure time, was required to obtain a given mortality of *R. dominica* (Beckett and Morton, 2003). Many published works have presented successful use of radiant heating such as infrared, microwave, and dielectric heating to disinfest stored grain and cereal products (Boulanger *et al.*, 1971; Kirkpatrick *et al.*, 1972; Nelson, 1972). However, use might be limited when applied doses induce an increase in temperature to a level that deteriorates grain quality.

### 2.1.3 Gamma Irradiation

Gamma irradiation can be an effective alternative technology because of its ability to kill and sterilize insects in infested rice grains. Successful application of irradiation to control stored product insects has been reported (Aldryhim and Adam, 1999; Loaharanu *et al.*, 1971). Doses of 0.1–5 kGy may give complete kills within a few hours to weeks. Although immediate kills are required to reduce grain loss, use of irradiation is limited by its effect on grain quality. Irradiation caused changes in rough and brown rice in terms of color, amylose content, water absorption, loss of solids during cooking, paste viscosity, cooked rice hardness, and oxidative rancidity (Hayashi *et al.*, 1998; Roy *et al.*, 1991; Sabularse *et al.*, 1991, 1992; Wang *et al.*, 1983; Wootton *et al.*, 1988). Similar effects were reported when milled rice was irradiated (Bao *et al.*, 2001; Chaudhry and Glew, 1973). Consumer acceptance is very important and optimum doses should be determined. Various doses have been reported to maintain sensory quality of irradiated rice. An acceptable limit below 3.0 kGy was recommended for Taiwanese rice (Wang *et al.*, 1983) and up to 5 kGy for Indian rice (Roy *et al.*, 1991). Bao *et al.* (2001) also concluded that irradiation of milled rice for human consumption should be limited to a maximum dose of 2–4 kGy because of its negative effect on rice color and aroma. However, doses of 1 kGy and under were suggested for Australian rice and ordinary Thai rice (Loaharanu *et al.*, 1971; Wootton *et al.*, 1988).

Aromatic rice is an important export commodity for Asian countries. Economically, it occupies a special position in the international market because of its pronounced, pleasant, and fragrant odor and satisfying soft texture after cooking. Sirisoontaralak and Noomhorm (2005) reported changes in physicochemical properties of packaged aromatic rice (KDML-105) when using gamma irradiation at dosages of 0.2–2.0 kGy. In addition to an increase in lipid oxidation (TBA numbers) after irradiation, volatile compounds (ACPY, 2-acetyl-1-pyrroline) decreased. These affected sensory perception. Therefore, maximum doses of less than 1.0 kGy should be used to disinfest aromatic rice, although, when considered strictly on aroma, less than 0.5 kGy would be more suitable.

### 2.1.4 Modified Atmosphere

Modified atmosphere involves alteration of the concentration of the normal atmospheric air, which contains about 21% oxygen and 0.03% carbon dioxide, present in storage to produce insecticidal effects and prevent quality deterioration. Two ways of generating modified atmosphere are reduction of oxygen concentration or increase in carbon dioxide concentration.

#### 2.1.4.1 Low Oxygen Atmosphere

A low oxygen atmosphere can be obtained by storing grain in sealed enclosures or in airtight storage and allowing the occurrence of natural biological processes from

infested insects and grain, known as hermetic storage. Insects of various species were killed by depletion of oxygen rather than accumulation of carbon dioxide (Bailey, 1965). Adults were more resistant than immature stages. A lethal oxygen level to all life stages of insects at <3% was obtained depending on density of insect population (Moreno-Martinez *et al.*, 2000; Oxley and Wickenden, 1962) and rate of oxygen re-entry into storage containers (Hyde *et al.*, 1962). Besides hermetic storage, oxygen can be reduced by removing air from storage containers to create a vacuum in which lower pressure than atmospheric pressure is shown. The exposure time required to kill insects using low pressure condition varies because of insect species, insect life stage, and pressure level. When a pressure below 100 mm Hg was applied, exposure time ranged from 7 to 120 h (Calderon *et al.*, 1966; Finkelman *et al.*, 2003, 2004). Eggs seemed to be more tolerant than pupae and adults. Immature stages of some insects developing within the grain kernel were more resistant than those outside the kernel. *S. oryzae* was considered to be more resistant than other insect species. When using pressure above 100 mm Hg, insects had shortened life and oviposition was reduced (Navarro and Calderon, 1972). With the advent of modern plastic materials, airtight laminated food pouches made from low gas permeability plastic films were introduced to control insects (Cline and Highland, 1978) by restricting oxygen and carbon dioxide transfer and creating an atmosphere lethal to insects. Vacuum packaging was also efficiently proved to control insects during storage of milled rice (Kongseree *et al.*, 1985). Similar to vacuum packaging, Mitsuda *et al.* (1972) introduced skin packaging or the carbon dioxide exchange method (CEM), in which cereal grains were packed in low gas permeability plastic bags and carbon dioxide was added. Grains can absorb gas so this appeared tightly packed. Rice packed using the CEM technique can be maintained at better conditions, particularly in term of water-soluble acidity, free fatty acid content, amylography, and volatile carbonyls from cooked rice (Mitsuda and Yamamoto, 1980).

#### 2.1.4.2 High Carbon Dioxide

Carbon dioxide has some level of toxicity to insects but also deprives the insects of oxygen and kills by suffocation. Depletion of oxygen is more important than an increase in carbon dioxide in control of insect populations. However, when carbon dioxide is present oxygen is used up more quickly and adult insects die at relatively higher concentrations. More effective control could be expected when reduction of oxygen is accompanied by a corresponding increase in carbon dioxide (Spratt, 1975).

Exposure time needed to kill insects in a high carbon dioxide atmosphere depends on insect species, life stages, and carbon dioxide concentration. Most stored product insects are killed in an atmosphere of <3% O<sub>2</sub> or >40% CO<sub>2</sub> (Bailey, 1965). To obtain a complete kill of insects, several days of carbon dioxide fumigation were required for different species of insects at different growth stages. Annis (1987)



identified that *Sitophilus oryzae* (rice weevil) was among the most tolerant stored product insects to a carbon dioxide rich atmosphere. The proposed exposure time for *S. oryzae* when using >40% carbon dioxide at 25°C was 15 days, therefore this should be adequate for all other species. To obtain acute mortality for this kind of insect, a high concentration of carbon dioxide was recommended (Lindgren and Vincent, 1970) but with nil oxygen less effectiveness was shown. Even at potent carbon dioxide concentration of 95%, a long exposure time was required to kill all developmental stages of *S. oryzae* shown as  $LT_{99}$  at 1.26–15 days (Annis and Morton, 1997). Among weevil types, *S. oryzae* was more tolerant to carbon dioxide than the granary weevil *S. granarius* (Lindgren and Vincent, 1970). For different insect species, adults of *Tribolium castaneum* (Herbst) seemed to be more tolerant than *S. oryzae* (Taskeen Aliniyazee, 1971) at carbon dioxide 45–80%. In contrast, at 100% carbon dioxide, Press and Harein (1967) reported a comparatively shorter exposure time than that of *S. oryzae* to obtain complete mortality of all developmental stages of *Tribolium castaneum* at 2.5 days. Four live stages of insects responded differently to carbon dioxide. Conclusively, for almost all stored product insects, pupae seemed to be the most resistant stage, whereas adults were the most susceptible stage.

#### 2.1.4.3 Modified Atmosphere at Increased Temperature

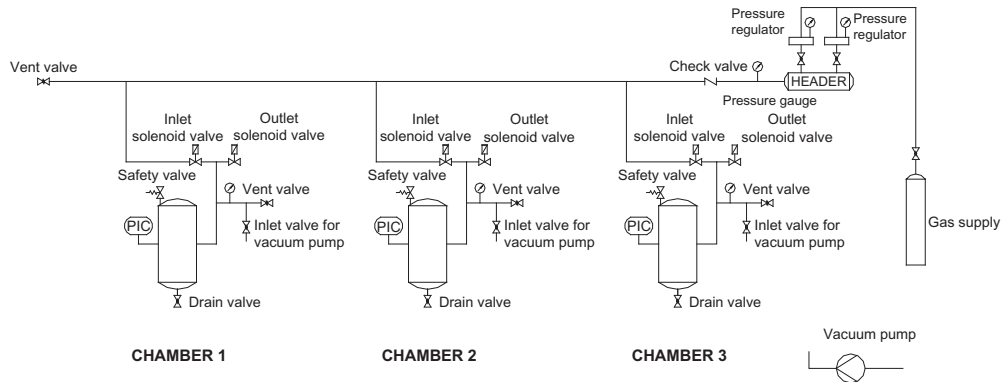
Increasing temperature resulted in increased insect mortality when insects were exposed to high carbon dioxide (Taskeen Aliniyazee, 1971). A combination of temperature >38°C with carbon dioxide enriched or oxygen deficient atmospheres increased mortality of *T. castaneum* (Herbst) larvae (Soderstrom *et al.*, 1992). This was confirmed when using a combination of low oxygen concentration and increased temperature (26–35°C) (Donahaye *et al.*, 1996). Higher temperatures (20–40°C) also reduced exposure time required to obtain mortality of all live stages of many stored product insects in packaged rice under reduced pressure (Locatelli and Daolio, 1993).

#### 2.1.4.4 Modified Atmosphere at Low Temperature

Low temperature can be applied to low oxygen atmospheres to preserve stored grain. Most successful works focused on maintaining qualities of grain such as wheat (Pixton *et al.*, 1975) and bean (Berrios *et al.*, 1999). Shelf-life of packaged brown and milled rice in a low oxygen or high carbon dioxide atmosphere was longer when stored under cool temperature (Mitsuda *et al.*, 1972; Ory *et al.*, 1980; Sowbhagya and Bhattacharya, 1976) compared to those stored under ambient temperature.

#### 2.1.5 Pressurized Carbon Dioxide

In a high carbon dioxide atmosphere, even at high concentration, exposure time to obtain complete mortality of insects was longer compared to chemical fumigation. This limits the use of carbon dioxide. To reduce exposure time, Nakakita and Kawashima



**Figure 10.4** System used for CO<sub>2</sub> application under pressure.

(1994) introduced the use of carbon dioxide under pressure (5–30 bars) followed by sudden loss of pressure. With carbon dioxide at 20 bar, an exposure time of 5 minutes was sufficient to kill all adults of *S. zeamais*, *R. dominica*, *T. castaneum* and *L. serricornis*. But eggs of *S. zeamais* required treatment at 30 bars for 5 minutes for complete kill. In comparison, application of helium had no effect on adult mortality even at 70 bars.

From a commercial point of view, application of carbon dioxide gas at high level is restricted by costly equipment and difficulties in control. Noomhorm *et al.* (2005) suggested application of pressurized carbon dioxide at lower level (4–8 bars) to kill *S. zeamais* in milled rice using a specially designed pressure chamber (Figure 10.4). Carbon dioxide at pressures of 4, 6, and 8 bars could shorten exposure time to obtain a complete kill of *S. zeamais* adults from 21 h at atmospheric pressure to 6, 2, and 2 h, respectively. A few survivors of immature insects were observed when exposed for 5 h at 6 and 8 bars. The adult stage was the most susceptible, whereas larvae and pupae were relatively more tolerant. After the pressurized treatments, milled rice qualities in terms of cooked rice hardness and pasting properties slightly changed; however, panelists could not observe any difference between non-treated and treated rice when sensory qualities were evaluated.

### 3. POST-HARVEST VALUE ADDITION

#### 3.1 Artificial Aging

Aging is usually done at temperatures above 15°C. The price of rice increases considerably due to aging, as costs are incurred because of storage of rice for longer periods. The practice of accelerated aging is the storage of rice at higher temperature than the usual storage temperature but lower than normal drying temperatures, so that the rice kernels are not damaged. The accelerated aging process could be treated with either

dry or wet heat treatment. Wet heat treatment or steam treatment of fresh paddy has been done to bring about partial gelatinization of starch.

The extended rate of changes during aging varies with storage temperature and moisture content. The changes are increased with higher temperature; they will occur in the same pattern but differ in quantity among varieties. The aging process is less effective in cold storage, but it is accelerated by storage at high temperature and also to some extent by exposure to light.

Cured rice resembles naturally aged rice in cooked behavior and taste panel scores, but differs from parboiled rice in that starch granules are not gelatinized. Similar results are obtained with brown rice, where heating has also increased reducing sugars and amylograph viscosity but reduced the acidity of water extract (due to volatilization), without a change in fat acidity.

Aging of the grain may be accelerated with dry or wet heat treatment, heating rough rice up to 110°C in sealed containers without loss of moisture to avoid grain cracking. In South India freshly harvested paddy is kept in heaps of straw for several days to cure. Domestic curing methods are also used, e.g. after soaking, uncooked paddy is immediately steam-cooked for about 10 minutes and then allowed standing heat for an hour. It is then dried slowly. The rice thus cured is opaque and has the appearance of raw rice, but with the cooking qualities of old stored rice.

Storage temperature influences the textural characteristics for samples stored at various temperatures (4°C, 21°C, and 38°C). Clumpiness and glueyness significantly decrease as storage temperature increases from 4°C to 38°C. No significant decrease in glueyness is observed between samples stored at 21°C and 38°C. Cooked kernel hardness is significantly greater in rice stored at 38°C. Cohesiveness of mass significantly decreases with increasing storage temperatures.

Fan (1999) studied the effects of rough rice drying, and storage treatments on gelatinization and retrogradation properties of long-grain rice (cv. Cypress) were studied via differential scanning calorimetry (DSC). The newly harvested rough rice at 20.5% moisture content, was treated using subsequent post-harvest variables including two pre-drying conditions (immediate or delayed by 86 h), followed by two drying conditions of high-temperature (54.3°C, 21.9% RH, for 45 min) and low-temperature (33°C, 67.8% RH, for 45 min), which corresponded to equilibrium moisture content of 6.4% and 12.5%, respectively. After drying, all the rough rice was placed in layers in a chamber controlled at 33°C and 67.8% RH in four storage treatments (no storage and storage at 4°C, 21°C or 38°C for 20 weeks).

As storage temperature increased from 4°C to 38°C, gelatinization enthalpy also increased. The endothermic peaks of retrogradation ranged from 46°C to 63°C, with peak temperature of approximately 55°C. The enthalpy for retrograded rice gels varied from 5.1 to 6.7 J/g, which was about 60% to 70% of the gelatinization enthalpy.

Chrastil (1990) studied the chemical and physicochemical changes in rice grains of three typical North American rice varieties during storage at different temperatures, 4°C, 25°C and 37°C, respectively. It was found that the swelling of rice grains stored at 4°C increased by only 5–7%, but the swelling of rice grains stored at 37°C increased much more, by 18–68%. Another breakdown during cooking after long storage at higher temperature was low in all varieties studied.

Changes in gelatinization and retrogradation properties of two rice cultivars, Bengal with initial moisture contents at 18% (w.b.) and Kaybonnet with initial moisture content at 18.3 % (w.b.), have been reported. The rough rice was subjected to a 20 min drying treatment in thin-layer with drying air controlled at 60°C and 16.9% RH, which corresponded to an equilibrium of 5.8 % (M.C.). Upon removal from the drier, the samples were immediately transferred to a conditioning chamber controlled at 21°C and 50% RH and equilibrated until reaching the target moisture contents of 12% or 14% (<1 week). After that the rough rice was stored at one of three storage temperatures, 4°C, 21°C, or 38°C, and then samples removed from each bucket at 0, 3, 9, and 16 weeks (Fan 1999). The gelatinization enthalpy increased as the rough rice storage duration increased. Gelatinization temperature also varied with duration. Both rice cultivars exhibited similar retrogradation peak temperatures of around 55°C, but Kaybonnet gave higher retrogradation enthalpy than Bengal rice. The greater degree of retrogradation with Kaybonnet was largely because of its higher amylose content (Fan, 1999).

Inprasit and Noomhorm (1999) studied the effect of rice aging by drying paddy in a fluidized bed dryer at 150°C, tempered for 12 hours. After that the paddy was dried in shade. The head rice yield was found to be higher than the yield of shade dry. The gradual reduction in grain temperature during tempering caused partial gelatinization of grain which showed results similar to accelerated aging of rice, hence the increase in head rice yield, hardness, and b-value (yellowness) but the decreased water absorption.

The approach of production of aged rice from steam treatment simulates the parboiled process, but the quality of aged rice should not be completely parboiled. Suitable conditions for steam treatment in terms of pressure, temperature, and relation linear need to be investigated in the accelerated aging process of rice.

### 3.2 Design and Development of the Steam Chamber

A schematic diagram of the steam chamber unit used in this experiment is presented in Figure 10.5.

The structure consists mainly of a steam chamber (1), designed to connect with the boiler (2) and control the pressure using a release valve (3). The boiler can be adjusted to maximum pressure at 4.0 kg/cm<sup>2</sup>. At the bottom of the steam chamber is

a pressure gauge (4) and a safety valve (5). There are two types of container for holding the sample, a cylindrical container and a conical container. The cylindrical container is used in the air steam system and the conical container in the steam submerged system.

In this study, two steaming systems were used: an open tank system and a pressurized tank system. The steam chamber was connected to the boiler to produce the air steam. The paddy samples were put into either the cylindrical or conical container and then inserted into the steam chamber before opening the valve of air steam. For the open system, the release valve was opened and steam temperature was controlled by adjusting the ball valve (3). For the pressurized tank system, the release valve was

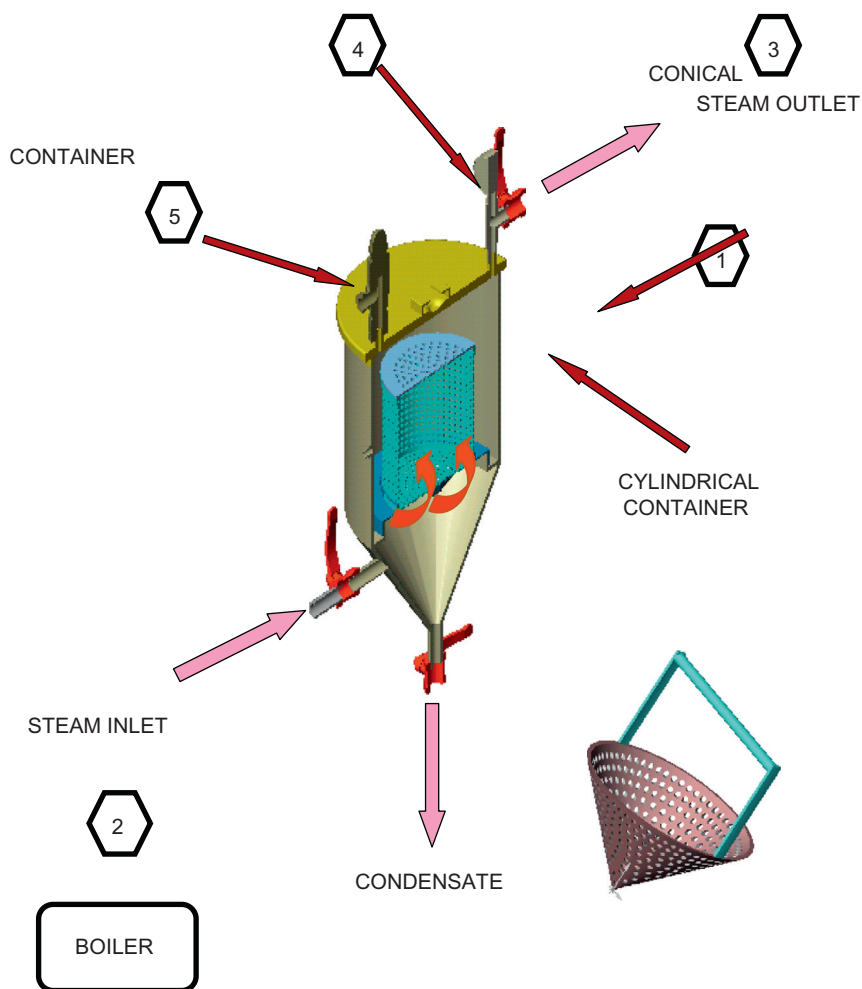


Figure 10.5 Schematic diagram of the steam chamber heating unit.

closed and pressure was controlled by adjusting the ball valve. The temperature and pressure were manually controlled.

Accelerated aging of high moisture rough rice in a closed container induced increase of head rice yield due to gelatinization of starch during heating. At the optimum conditions for accelerated aging of high moisture rough rice, b-value of milled rice was increased to the level of natural aging but hardness and water absorption of cooked rice were lower than those of naturally aged rice.

When low moisture rough, brown, and milled rice was heated in a closed container, even at optimum heating condition, cooking and eating qualities did not change to level of naturally aged rice whereas b-value reached the same level as in naturally aged rice. For rough and brown rice, head rice yield decreased because of a low level of moisture in grain to gelatinize. However, heating low moisture rough rice with an accelerated aging unit at equilibrium moisture content at 60°C for 4 days, did not change head rice yield. However, hardness of cooked rice, b-value, and water absorption of cooked rice was changed to a state similar to naturally aged rice.

Intermittent heating of low moisture rough rice with controlled grain temperature at 60°C decreased head rice yield and other qualities changed similar to those of naturally aged rice. Energy consumption was reduced after heating at 60°C of grain temperature for 5 days when compared with continuous heating at equilibrium moisture content (60°C) for 4 days.

### 3.3 Aroma Enhancement of Milled Rice

The compound 2-acetyl-1-pyrroline (ACPY) is a heterocyclic compound and a major component in the flavor of cooked rice (Buttery *et al.*, 1982), which contributes to a popcorn-like aroma in several Asian aromatic rice varieties. The term popcorn-like aroma is used by non-Asians, and pandan-like aroma by Asians (Paule and Powers, 1989). ACPY has been confirmed as chiefly responsible for the characteristic odor of aromatic rice varieties (Lin *et al.*, 1990; Tanchotikul and Hsieh, 1991).

#### 3.3.1 Production of ACPY

ACPY has been isolated and identified from many food sources such as pandan leaves (Buttery *et al.*, 1982, 1983; Laksanalamai and Ilangantileke, 1993), crust of wheat and rye breads (Schieberle and Grosch, 1985, 1987; Schieberle, 1989, 1991), popcorn (Schieberle, 1991), and some sweet corn products (Buttery *et al.*, 1994). Laohakunjit and Noomhorm (2004a) extracted ACPY from pandan (*Pandanus amaryllifolius* Roxb.) leaves by supercritical fluid extraction with CO<sub>2</sub> (SC-CO<sub>2</sub>), simultaneous steam distillation/extraction (SDE), and ethanol extraction. There is a potential for high yield of ACPY by SC-CO<sub>2</sub> at 200 bar, 50°C and 20 min. The SDE-ether extract yielded a small amount of ACPY and an undesirable odor, whereas the dark green ethanol

extract gave the highest ACPY yield as well as 3-methyl-2(5 H)-furanone. At least 34 new volatile components were discovered from the three extraction methods.

ACPY can be chemically synthesized using 2-acetylpyrrole as the starting material (Buttery *et al.*, 1983) or boiling the amino acids, L-ornithine or proline in phosphate buffer containing 2-oxopropanol at backflush for 2 hours (Schieberle, 1990). It can also be produced by non-thermal microbiological synthesis (Romanczyk *et al.*, 1995) using *Bacillus cereus* strains isolated from cocoa fermentation boxes. Rangardthong and Noomhorm (2005) synthesized ACPY about 2.08 and 1.11 mg/l by two fungi, *Acremonium nigricans* and *Aspergillus awamori*, respectively. Physical and chemical factors affected ACPY production such as aeration in shake flask fermentation, rotation speed, temperature, and production medium. However, scaling up of production decreased ACPY content and liquid forms of ACPY have low stability. Apintanapong and Noomhorm (2003) studied the production of ACPY by the fungi *Acremonium nigricans* in a scaled up 5l bioreactor. The effect of chemical parameters (media composition and inorganic nitrogen source) and physical parameters (such as aeration rate, agitation speed, and pH control) on ACPY production was presented in shake flask fermentation.

### 3.3.2 Aroma Enhancement of Milled Rice

ACPY decreased with storage time (Laksanalamai and Ilangantileke, 1993). Adding ACPY will improve aroma quality of aged rice. Liquid forms of ACPY from microbial fermentation had low stability, therefore, encapsulation can be applied to produce flavoring materials in a dry form. This process is coating or entrapping one material or a mixture of materials within another material or system (Risch and Reineccius, 1995). The polymers used as encapsulating materials must be chemically inert, non-toxic, non-allergic, and biodegradable. Apintanapong and Noomhorm (2003) encapsulated ACPY using spray drying and freeze drying techniques. Spray dried powders of 70:30 gum acacia–maltodextrin gave a minimum reduction of ACPY (27.7%) after 72 days of storage. Freeze dried powders from 70:30, 60:40, and 0:100 gum acacia–maltodextrin mixtures had no loss of ACPY within 60 days of storage. Under the scanning electron microscope, the surfaces in all samples had no cracks or pores. Freeze dried powders had complex forms and larger particles than spray dried powders. When powders were exposed to high relative humidity, moisture content increased and structure changed. Capsules were completely destroyed while freeze dried powders were easily contaminated with microorganisms. Encapsulated ACPY from partially purified culture broth was added to milled rice. Higher odor score was obtained in samples with encapsulated ACPY. Encapsulating materials, however, affected overall acceptability of the panelists. Apart from encapsulation, Laohakunjit and Noomhorm (2004b) studied the binding of ACPY to rice starch films. The effect of plasticizers such as glycerol, sorbitol, and poly(ethyleneglycol) 400 (PEG 400) on

mechanical and barrier properties of rice starch film was also investigated. Because of its higher tensile strength and lower oxygen transmission rate and water vapor transmission rate, 30% sorbitol-plasticized film bound with ACPY was selected for coating non-aromatic rice kernel (variety RD 23, Supanburi 1, and Supanburi 90). Odor retention was compared to three varieties of Thai aromatic rices (Khao Dawk Mali 105, Klong-Luang, and Patumthani 1). Scanning electron microscopy showed more homogeneous, clearer, and smoother surface of coated rice. ACPY decreased during storage for 6 months; however, ACPY content of ACPY coated non-aromatic rice did not significantly differ from that of aromatic rice. Likewise barrier properties of film to oxygen induced lower oxidative rancidity shown by low *n*-hexanal, free fatty acid, and thiobarbituric acid (TBA) number in coated non-aromatic rice.

## 4. COOKING AND PROCESSING

### 4.1 Retort Packaging

Flexible packaging for thermo-processed foods as an alternative to metal cans and glass jars has been explored since at least the middle 1950s. The packaged foods are heat sterilized in retorts and the sterility maintained by the inherent material impermeability and the hermetic seals of the pouches.

Mermelstein (1978) studied various benefits of the retort pouch, and found it had many advantages over canned and frozen food packages for the food processor, distributor, retailer, and consumer. Because the pouch had a thinner profile than cans or jars, it took about 30–50% less time to reach sterilizing temperature at the center of the food in the pouches than in cans or jars. In addition, because the product near the surface was not overcooked as it might be with cans and jars, the product quality was maintained. Thus, the product was truer in color, firmer in texture, and fresher in flavor, and there was most likely less nutrient loss. It was recommended that the pouch was especially beneficial for delicate products such as entrees where color and texture are important.

Energy saving is a feature of the retortable pouch that made it a promising alternative packaging method for sterilized shelf-stable products. The emergence of the retort pouch was a response to changes in consumer tests and buying habits, as consumers demanded quality, taste, and convenience in foods. This improvement led to marketing competition (Fox, 1989). Furthermore, the pouched product was commercially sterile, not requiring refrigeration or freezing, and was shelf-stable at room temperature for at least as long as canned foods.

Stand-up flexible pouches, which stand erect without external support when they are filled with their intended contents, now extend their origins in fruit beverage packaging into confections, snacks, and other products. The triangular-shaped flexible pouch with a unitary flat base appears in the mainstream. The pouches are relatively



easy to fill and seal on perform/fill/seal equipment and convenient to handle. Over the past decade, the number of flexible pouches have increased five times globally. The trend is likely to continue in developed and emerging markets alike for many years to come.

#### **4.1.1 Packaging Material of Flexible Pouch**

The most common form of pouch consists of a 3-ply laminated material. Generally it is polyolefin/aluminum foil/polyester where the polyolefin is polyethylene, polypropylene, or a co-polymer of the two, and the polyester is one of several branded materials e.g. Myglar, Melinex, etc. The aluminum ply ensures shelf-life of at least 2 years by providing the best gas, water, and light barriers. The polyolefin ply forming the inner wall of the pouch provides the best sealing medium while the outer polyester ply affords further atmospheric barrier properties as well as mechanical strength. Variations in construction are available including pouches which contain no aluminum foil.

The basic requirement for selection of packaging materials is heat resistance because of the high temperature processing they will undergo. In addition, in the selection of package composition and package shape, consideration must be given to the nature of food to be packaged, required shelf-life, and package cost. The material for pouches must not only provide superior barrier properties for a long shelf-life, seal integrity, toughness, and puncture resistance, but must also withstand the rigors of thermal processing.

#### **4.1.2 Soaking Process**

[Velupillai \(1994\)](#) proposed that the most important objective of the soak process was the increase of moisture content to a level and distribution (within the kernel) whereby the subsequent cook stage would ensure complete and uniform gelatinization of the starch in the rice kernel. Conventional processes have determined that when the grain total moisture was approximately 30% (wet loss), then the moisture at the innermost parts of the kernel was sufficient to fully gelatinize the entire kernel during the subsequent steam heat treatment stage. The soaking temperature and its uniformity throughout the grain mass during the soaking period were additional factors that determined grain quality and production cost.

#### **4.1.3 Boiling Process**

During this stage, the starch granules in the endosperm, which have absorbed water during the soak stage, are changed in structure from a crystalline to an amorphous form. This is an irreversible process referred to as gelatinization. The key criteria are the presence of sufficient moisture and the transfer of heat at or above the gelatinization temperature for the variety of rice under treatment ([Velupillai, 1994](#)).

Suzuki *et al.* (1976) investigated two different mechanisms related during the cooking process. One was the diffusion of water needed for cooking from the surface to the core of rice grain, and the other comprised the chemical and physical changes of the components in rice.

The cooking time was influenced by the amount of water subsequently added. Following cooking, the rice was washed thoroughly with cold water in order to remove surface starch and stop the heat process for dry pack of canned rice products.

#### **4.1.4 Filling and Closing Processes**

A high vacuum level is required to prevent oxidative browning of the products. If a vacuum of 26 in. of mercury or less is used in can, the rice acquires a light brown color and an objectionable odor and flavor. Little improvement is obtained by replacing the air in the cans with nitrogen. However, when rice is packed and sealed at 28 in. of vacuum, the product remains very white after processing and has an excellent texture, flavor, and separation of grains.

Application of high vacuum reduces the moisture content of the partially cooked grains by a small amount, about 1–3% which was not undesirable. The reliability of the closure seal is directly affected by the ability of the filling operation to leave the opposing seal surfaces free of product contamination. The seal requirements for retort pouches must stand 121°C (250°F) or higher thermo-process temperature (Lampi, 1979).

Filling systems range from manual to automatic with variations and combinations of both. The essential requirement is that the pouch seal be kept free from contamination with product as this could impair sterility, either by spoilage or resultant leakage at the seam. Upon investigation, removal of air from the filled pouch is normally affected on an automatic line and is necessary to ensure produce stability, avoid pouch bursting during retorting, assist uniform heat transfer, allow detection of spoilage (swelling), and facilitate cartoning.

#### **4.1.5 Retorting System**

The features of retorting equipment for retort foods depend significantly on the characteristics of containers used. In particular, to achieve a hermetic seal by heat sealing requires careful pressure control compared with canned or bottled items. The retorting equipment can be classified into steam–air type and hot water type by the heating medium in use, or into static type, circulating type, and rotary type by product behavior in the retort. These types are similar in performance, and selection is made taking into account food properties, and shape and packaging forms.

A steam–air mixture or hot water is used as the heating medium, and it has been established that these two media are practically equivalent in terms of thermal

characteristics that are associated with heat transfer efficiency. However, different heating media require different attentions in operation.

Mermelstein (1978) suggested that, because of their flexible nature and limited seal strength, retortable pouches were unable to support internal pressure developed by expansion of headspace gases at thermal processing temperatures. Therefore, the pouches were sterilized in an environment where the external pressure in the retort was equal to or greater than the internal pressure of the pouches during heating and cooling cycles of the process. Hot water (heating medium) under overriding air pressure was achieved to equalize the internal and external pressures of the pouches undergoing sterilization. However, this reduced the value of surface thermal conductance ( $h$ ) to a finite value as opposed to a very large value achieved using steam.

#### **4.1.6 Sterilization of Food in Retort Pouches**

Flexible packages (pouches) for shelf-stable liquid or semi-liquid food products are new compared to glass and metal containers; however, it is normal that as flexible packages become more refined they will be used as containers for high-moisture, heat-preserved shelf-stable foods. Processes for foods in flexible packages may be designed with the same procedures used in determining processes for foods in metal or glass containers. The same basic criteria exist regarding the requirements for commercial sterility of the product, regardless of the material from which the hermetic container is made. Processes for food in flexible packages will be calculated by conventional methods from heating characteristics obtained by heat penetration tests and the sterilizing ( $F_0$ ) values known to be adequate for specific products.

For the purpose of thermal processing, canned foods may be divided into two groups on the basis of their pH. Acid foods, with a pH less than 4.5, are sterilized by bringing the temperature of the slowest heating point in the can to about 90°C. Acid foods are usually processed in boiling water or in steam at low pressure, and in some cases a process of hot filling, closing, holding, and cooling is used. Low acid foods with a pH above 4.5 require more severe heat processes. Thus, canned foods are usually processed at temperatures of 116°C or 121°C for a time which is determined by the temperature history at the slowest heating point in the can and the resistance of possible contaminating microorganisms to inactivation by heat.

## **4.2 Quick Cooking Brown Rice**

Quick cooking rice (QCR) is precooked and gelatinized to some extent in water, steam, or both. Then the cooked or partially cooked rice is dried in a manner to retain the porous structure to facilitate rapid penetration of rehydrated water (Luh *et al.*, 1980).

Raw quick cooking brown rice (QCBR) should be dry, free flowing without substantial clumping, have acceptable color and flavor, have no considerable kernel breakage with bulk density around 0.4–0.5 g/ml (Roberts *et al.*, 1979).

Reconstituted QCBR should have flavor, texture, taste, and appearance very similar to ideally cooked conventional rice without mutilation of the rice grain to minimize losses of starch and nutrients (Smith *et al.*, 1985).

#### 4.2.1 Quick Cooking Rice Process

A number of quick cooking processes have been developed in recent years to produce quick cooking products. Such processes mainly comprise soak–cook–dry methods, stepwise hydration–cook–dry methods, expanded and pregelatinized rice, rolling treatments, dry heat treatments, freeze–thaw process, gun puffing, freeze drying, chemical treatments (Luh *et al.*, 1980; Roberts, 1972), and gamma irradiation (Sabularse *et al.*, 1991).

It has been stated that gun puffing, freeze–thaw process, and freeze drying are uneconomic because of the costs of machine investment (Monphakdee, 1990). Smith *et al.* (1985) pointed out the disadvantage of freeze–thaw process of producing a more sticky and pasty QCR final product as the result of rehydration of the starch during thawing and the resultant collapsing of the starch granule. They also recommended the combination of freeze drying followed by convective air drying to get a less sticky and better free flowing product. On the contrary, such a combination was reported by Azanza *et al.* (1998) as resulting in grain susceptible to disintegration because of a relatively longer time for freeze drying. This was attributed to unfavorable physical properties and gel-bound water of rice, which sequester the free water and therefore make freezing difficult.

Expanded and pregelatinized rice is particularly suitable for parboiled rice which is able to withstand the high temperature treatment in the process. The other methods are usually conducted in combination; such as the combination of soak–cook–dry methods and dry heat treatments, or stepwise hydration–cook–dry methods accompanied by dry heat treatments. The latter combination was said to be complicated and suitable only for rice which is able to resist the rigorous treatment such as parboiled rice (Monphakdee, 1990).

Selected processes for QCBR in particular are described herein, including the dry heat treatment of Bardet and Giesse (1961); the soak–multiple cook–dry method of Miller (1963); the preheat–soak–multiple cook–dry method of Gorozpe (1964); the alternate soak–bake method of McCabe (1976); the soak–cook–CFB (centrifugal fluidized bed)–dry method of Roberts *et al.* (1979); the multiple cook–dry method of Baz *et al.* (1992); and the fluidized cook–dry method of Hyllstam *et al.* (1998).

Bardet and Giesse (1961) described a dry heat treatment at very high temperature (230–315°C) by agitating raw brown rice at heated air temperature of 272°C with

velocity of 762 m/min for 17.5 s to fracture the bran layer, followed by immediate and rapid air cooling. Such QCBR, which could be cooked three times faster than normal brown rice, has been marketed in the western states for several years. The toast or 'nut-like' flavor is claimed to be desirable, but the kernels are somewhat chalky and are checked or fissured (Roberts *et al.*, 1979).

Miller (1963) disclosed a process for preparing a quick cooking dehydrated brown rice product, which was said to be gelatinized uniformly. Raw brown rice was hydrated in water at a temperature of about 75–100°C to increase the moisture content of the rice 20–50% to split the bran coat partially. The hydrated rice then alternately was steamed at a temperature of 100°C or greater for gelatinizing the rice, and sprayed with water to increase the moisture content of the rice about 3–5% during each addition of water, until the rice was completely gelatinized and had a moisture content above 65%. The cooked rice was then dried in a manner in which moisture was removed from the surface of the rice faster than water can diffuse from the interior of the rice to the surface of the rice grain so the rice retained a puffed and porous condition. It was claimed to be rehydrated in 5 min, being less pasty, fluffier, and softer than similar product, and substantially devoid of tough, chewy centers.

Goroze (1964) described a QCBR process of fissuring, hydrating, multiple soaking and steaming, and drying. Brown rice was hot air treated at 50–120°C and hydrated in water below the gelatinization temperature, briefly immersed in boiling water and treated with steam in several stages, cooled by a blast of cold air, and finally dried.

QCBR boiled to rehydrate in 5 min was produced by the process of McCabe (1976), where brown rice was subjected to alternate soaking at room temperature for 2–3 h and baking at 149–177°C for 40 min.

The application of CFB drying was extended to QCBR by Roberts *et al.* (1979). The process consisted of soaking the raw brown rice at ambient temperature for 16 h, boiling for 20–25 min to reach about 60% moisture, CFB drying with 3000 fpm air at 133°C for 5 min, with a rotation speed of 270 rpm to achieve 7–10% moisture QCBR. The high heat transfer rate yielded a relatively porous QCBR which could be prepared for serving by simmering for 10–15 min, about one-quarter that required for raw brown rice.

The process of Baz *et al.* (1992) is particularly advantageous for parboiled rice but is also applicable to brown rice. First, the rice was water cooked at a temperature of about 90–100°C for about 1–10 min exclusive of heating up time for partially hydrating the rice grains, which thereby provides uniform moisture distribution in the grains. Next, steam pressure cooking was carried out at pressures of between 250 and 2,000 mm Hg above atmospheric pressure for a duration of about 1.5–30 min. The drying was carried out in two steps. The first drying step occurred under stationary conditions in a conventional belt dryer or on a high air velocity belt dryer having

means, such as nozzle tubes, to direct hot air at the rice. In a second drying step, the partially dried rice grains were dried under agitated conditions in a vibrating dryer such as a vibrating fluid bed dryer or by a high velocity belt dryer as in the first drying step. The product can be prepared for consumption by simmering for 8–10 min.

Hyllstam *et al.* (1998) developed a process which is applicable for brown rice. The process involves fluidizing the rice by recirculating saturated steam at 100°C during cooking, injecting saturated steam into the recirculation to replace the condensed steam, spraying water at approximately 100°C onto fluidized rice during cooking to gelatinize starch, and air drying.

#### **4.2.2 Important Factors Affecting the Process of Quick Cooking Brown Rice**

The soak–cook–dry combined with dry heat treatment was chosen in this study because of its economy, simplicity, and available facility. The process is primarily composed of preheating, soaking, water cooking, steaming, pre-drying, and final drying.

##### **4.2.2.1 Preheating**

The preheating of the raw rice grain to partially split the bran and develop the numerous small fissures throughout the kernel is believed to facilitate moisture penetration into the grain (Daniels, 1970). Thus, the soaking time and the boiling or steaming time are decreased with a consequent increase in yield. Moreover, the dry volume of the finished product is increased and the product requires less time to prepare for serving (Luh *et al.*, 1980). The appropriate amount of preheating to achieve fissuring is empirical and must be determined experimentally. Generally, preheating may be done by means of forced air or hot air with temperature 50–350°C for 2–15 min (Goroze, 1964; Monphakdee, 1990).

##### **4.2.2.2 Soaking**

The objective of soaking is to saturate the grain with moisture sufficient for gelatinization in the subsequent cooking step. Moreover, it reduces the tendency of grain mutilation from the osmotic pressure during cooking. In addition, soaking also creates the fissures in the kernel. Thus the time of precooking is decreased. Preheated brown rice is soaked in approximately two to three parts water per part rice at room temperature for a period of 1–16 h to raise its moisture content to 30–40%. The time can be reduced somewhat by using warm water, but hot water causes undesirable stickiness and mushiness. Despite the aforementioned advantages of soaking, a long time of soaking results in loss of water-soluble vitamins, minerals, and flavor (Carlson *et al.*, 1979; McCabe, 1976; Roberts *et al.*, 1979).

#### 4.2.2.3 Cooking

This step is carried out for gelatinizing starch. Basically, it is conducted by raising the temperature to gelatinization temperature or higher by means of boiling, steaming, or both. The important problem is the inability to control sufficient and uniform gelatinization, thus resulting in mutilation and stickiness of the grain. This problem is solved by controlling the moisture penetration and time for starch gelatinization. Consequently, the cooking procedure in this study is accomplished by two steps to attain the desired level of gelatinization.

### 4.3 Germinated Brown Rice

Germinated brown rice (GBR) is a functional food. GBR is easier to cook, tastier, softer, and higher in nutrients than brown rice. In a conventional GBR process, brown rice is soaked in warm water (30–40°C) for 20 h or longer to induce germination and is then dried. During germination, the main nutrients including phenolic compounds,  $\gamma$ -oryzanol, essential amino acids and especially  $\gamma$ -aminobutyric acid (GABA) increase considerably and accumulate in GBR. [Cheevitsopon and Noomhorm \(2011\)](#) studied the changes in physicochemical properties of GBR and parboiled germinated brown rice (PGBR) dried in a fluidized bed dryer at 110–150°C. Results indicated that parboiling altered the properties of GBR owing to starch gelatinization. The moisture content, yellowness, peak viscosity and hardness of PGBR increased, but internal fissured kernel, cooking time, water absorption, and total solids loss decreased when compared to GBR. GABA content in GBR was 23.31 mg per 100 g and was reduced to 17.91 mg per 100 g in PGBR. The drying times required to reduce the moisture content of GBR and PGBR to 16% d.b. were 4.01–7.65 min and 5.11–9.50 min, respectively. Final moisture content, which is optimum to prevent internal fissures of dried GBR and PGBR, was 27–29% and 25–28% d.b., respectively. The same trend was observed in the physicochemical properties of GBR and PGBR when increasing drying temperature and time.

## 5. QUALITY EVALUATION

### 5.1 Image Analysis

Image analysis techniques have long been developed and commercially used for determining the quality attributes of cereals and grains linked with their size, shape, and appearance. Production of edible rice requires several processing operations such as milling, soaking, and cooking during which significant changes occur in kernel dimensions and appearance. However, little information is available in published literature on the applications of image analysis techniques for monitoring the dimensional changes in rice kernels during processing in relation to the varietal differences

manifested by the physicochemical properties. This study aimed to investigate the changes in the dimensions of rice kernels and appearance by image analysis during milling, soaking, and cooking. In milling, the emphasis was on the estimation of head rice yield (HRY) defined as the proportion by weight of milled kernels with three-quarters or more of their original length along with kernel whiteness in terms of degree of milling (DOM). Further, the changes in kernel dimensions during soaking and cooking of milled rice were investigated in relation to their physicochemical properties. Finally, interrelationships among dimensional changes, water uptake, and physicochemical properties of milled rice kernels during soaking and cooking were developed.

Yadav (2004) developed a simple and robust scheme for image analysis consisting of a personal computer, frame grabber, and a color CCD camera used for measurement of kernel dimensions and gray level distribution in two-dimensional images with ImageTool 2.0 software (available in the public domain). Ten Thai rice varieties ranging from low to high amylose content (16–28% d.b.) were selected for the study. A total of 50 samples, five for each variety, of rough rice weighing 200 g each was dehusked using a Satake dehusker and milled for 0.5–2.5 min at an interval of 0.5 min with a Satake polisher to obtain various levels of AHRY and DOM. A representative sample of milled rice comprising head and broken kernels, weighing about 12 g, was placed under the CCD camera manually for imaging with kernels not touching each other. Bulk samples of milled rice, which had been subjected to different degrees of milling, were imaged for determining the gray level distribution. Well-milled whole kernel rice was conditioned at three initial moisture contents ( $M_0$ ) of about 8, 12, and 16% (d.b.) for soaking and cooking experiments. A total of 105 kernels were imaged at each time interval to monitor the dimensional features such as length (L), width (W), perimeter (P), and projected area ( $A_p$ ) during soaking, whereas a total of 32 kernels were imaged during cooking for each variety at the selected  $M_0$ . Water uptake by 2 g rice kernels during soaking and cooking was determined and expressed in terms of change in their moisture contents. The physicochemical properties, namely, amylose content (AC), gel consistency (GC), alkali spreading value (AS), and protein content (PC) of milled rice of different varieties were determined by standard methods.

## 5.2 Texture Evaluation of Cooked Rice

The sensory texture characteristics of cooked rice determined by the panelists have been found to vary widely (Champagne *et al.*, 1998; Meullenet *et al.*, 1998; 1999; 2000a, b; Sitakalin and Meullenet, 2000). Also it was reported by Del Mundo (1979) that consumer panels gave scores similar to those of laboratory panels when assessing the eating quality of cooked rice.



There are several problems associated with sensory evaluation of cooked rice texture. Firstly, the method is time and labor consuming. Secondly, it is usually a major problem during the evaluation scheme to determine skillfully the number of samples that can be handled in a short period of time as the texture of cooked rice changes quickly with time and temperature. Thirdly, it is practically impossible to maintain the same laboratory panel members throughout the complete duration of a study. Lastly, a standard or uniform testing procedure for sensory evaluation of rice quality has not yet been adopted. Also, rice has a bland flavor, which usually increases the difficulty in determination of textural properties.

### **5.2.1 Objective Measurement of Cooked Rice Texture**

The texture of cooked rice has been frequently evaluated using compression, texture profile analysis, and extrusion testing with devices such as the Instron food tester and Texture Analyzer. In uniaxial compression, the sample is compressed to a predetermined degree to find its hardness (Sitakalin and Meullenet, 2000). A compresshold-pull-back (CHPB) test has been proposed for evaluating cooked rice stickiness using an Instron food tester by several researchers (Hamaker *et al.*, 1991). The area under the resulting force–time curve represented the stickiness in work units. Double compression testing with the Texturometer has also been used for the evaluation of cooked rice texture (Juliano, 1982; Kawamura *et al.*, 1997; Suzuki, 1979). However, the definitions of the terms such as adhesiveness, cohesiveness, and springiness are not identical. Other researchers who have employed the texture profile analysis include Champagne *et al.* (1998) and Windham *et al.* (1997).

In extrusion tests, the food sample is compressed until it flows through one or more slots in the test cell. The maximum force required to accomplish extrusion is used as an index of texture quality (Bourne, 1982). Several test cells such as the Ottawa texture measuring system (OTMS) cell and back extrusion cell have been proposed for evaluating cooked rice texture with an Instron food tester or Texture Analyzer. OTMS cells have been used for determining hardness (Lee and Singh, 1991; Lima and Singh, 1993, Limphanudom, 1997) and stickiness (Lee and Singh, 1991; Lima and Singh, 1993). Extensive use of back extrusion test cells has been reported by numerous researchers (Banjong, 1986; Limpisut, 2002; Meullenet *et al.*, 1998; Sitakalin and Meullenet, 2000) for evaluating cooked rice texture.

Attention to non-destructive quality evaluation techniques is increasing. Their advantages are safe chemicals, quick measurement, repeatability of sample use, and suitability in process control. Recently, near infrared (NIR) spectroscopy has been proposed as a promising technique for grain quality evaluation.

NIR spectroscopy is based on absorption of electromagnetic radiation at wavelengths in the range of 780–2,500 nm. The NIR spectrum originates from radiation energy transferred to mechanical energy associated with the motions of atoms held by

chemical bonds in a molecule. The chemical bonds vibrate and the approximations of these vibrations behave as a simple harmonic motion. The motion of each atom is independent vibration. When the frequency of the radiation matches that of the vibrating molecules, a net transfer of energy occurs from the radiation to the molecule. This can be measured as a plot of energy and wavelength, which is called a spectrum. The vibration spectrum of a molecule is a unique physical property and is characteristic of the molecule. The infrared spectrum can be used as a fingerprint for identification by comparing an unknown spectrum with the reference.

#### 5.2.1.1 Application of NIR Spectroscopy on Grain Quality

NIR spectroscopy was used to measure intrinsic properties in terms of protein content and hardness, and classified hard red winter and spring wheat (Delwiche and Norris, 1993). NIR spectra had potential in varietal identification of hard red winter wheats when measured wheats varied widely in protein content and breadmaking potential (Rubenthaler and Pomeranz, 1987). Approach to NIR measurement of apparent amylase content of ground wheat was presented (Wesley *et al.*, 2003). Maghirang and Dowell (2003) measured hardness of bulk wheat with NIR spectroscopy and correlated with those from single kernel visible. Hardness prediction was the best at 550–1,690 nm spectra ( $R^2 = 0.91$ ). The ability of the model to predict hardness was related to protein, starch, and color differences. Predicting protein composition, biochemical properties, and dough handling properties of hard red winter wheat flour was sufficiently accurate using NIR (Delwiche *et al.*, 1998).

NIR spectroscopy has been used to quantitatively predict rice constituents such as apparent amylase content, protein content, and moisture content (Delwiche *et al.*, 1995, 1996; Sohn *et al.*, 2003). NIR spectroscopy was reasonably accurate at predicting rice and rice starch quality in terms of pasting properties obtained from Rapid Visco Analyzer (RVA), gel consistency, cool paste viscosity, gelatinization onset temperature, and textural properties (Bao *et al.*, 2001). The possibility of NIR spectroscopy being used to monitor the change in starch structure during the gelatinization process or degree of gelatinization was reported (Onda *et al.*, 1994). Severity of the parboiling process was successfully assessed using NIR spectroscopy. A high correlation was observed with RVA maximum viscosity of gelatinized rice paste prepared from parboiled rice (Kimura *et al.*, 1995). However, a conflicting finding of poor correlation of NIR spectroscopy and RVA pasting properties of rice has also been reported (Meadows and Barton, 2002). Sensory texture attributes in terms of hardness, initial starchy coating, mass cohesiveness, slickness and stickiness of cooked rice were successfully predicted by NIR spectroscopy (Champagne *et al.*, 2001; Meullenet *et al.*, 2002).

NIR was also an accurate technique for measuring color values of grain and grain products (Black and Panozzo, 2004). A visible NIR instrument was calibrated with

colorimeter values ( $L^*$ ,  $a^*$ ,  $b^*$ ) as defined by CIE for measuring color of flour, barley, and lentils.

In conclusion, it is realized that several methods based on the physicochemical and pasting properties of milled rice as well as instrumental measurements of cooked rice could be used for indirect assessment of the eating quality of cooked rice in terms of sensory hardness, stickiness, and overall acceptability. However, such indirect methods still need further improvement in view of conflicting reports about their accuracy and the selection of independent variables with possible inclusion of water-to-rice ratio used in the cooking of rice. Several studies carried out in the past have clearly indicated that rice cooking method along with the quantity of water used affect the texture of cooked rice in a direct and significant way. Although storage time and temperature influence physicochemical and pasting properties of milled rice as well as the texture of cooked rice, it is difficult to quantify the effects of these factors on the eating quality of cooked rice. Therefore, indirect and rapid assessment of sensory textural attributes of cooked rice based on simple instrumental measurements of milled and cooked rice properties constitute an interesting area of research.

#### 5.2.1.2 Rapid Variety Identification of Rough Rice by NIR Spectroscopy

Fourier-transform NIR (FT-NIR) spectroscopy is an efficient method exposing all wavelengths in a desired region to a sample over all scanning times. It provides greater benefits in accuracy and sensitivity because of its improved speed, resolution, and noise ratio. [Attaviroj et al. \(2011\)](#) published results on the authentication of rough rice by this technique.

In this study, the overall results strongly supported that FT-NIR spectroscopy has potential as an alternative method of identifying wholegrain rough rice varieties, which had moisture contents of 13.09–27.78% w.b. It sorted the samples into groups according to variety with very high accuracy (99%) in a few minutes through applying PLSDA to MSC combined with Savitzky-Golay second derivative spectral data in the entire wavelength region of 9,088–4,000  $\text{cm}^{-1}$ . Data omitting the water band also produced high accuracy (98%) following the PLSDA technique with PLS2, whereas the SIMCA technique resulted in 74% accuracy. The spectra asserted the presence of differences in components, such as carbohydrates and proteins, which promoted successful identification performance of calibration algorithms. In rice production, varietal identification of grain received from farmers is a critical procedure facilitating quality control systems. Therefore, FT-NIR spectroscopy as a state-of-the-art technology possibly allows for successful screening of rough rice varieties quickly ( $\approx 3$  min), compared with the traditional methods, chemical and DNA analysis, which generally require 1–2 days. Moreover, this identification can be done as soon as the dried or undried materials are offered, because of the calibration models. It is also worthwhile mentioning that this approach, although it applies directly to the variety prediction of

pure whole grain, is capable of development regarding identifying single kernels to aid further work, such as to facilitate a breeding program, and it probably can expand the approach to measuring varietal contamination to support an efficient quality control system.

## REFERENCES

- ACIAR-AFHB, 1989. Suggested Recommendations for the Fumigation of Grain in the ASEAN Region. ASEAN Food Handling Bureau, Kuala Lumpur, Malaysia, and Australian Center for International Agricultural Research, Canberra, Australia.
- Aldryhim, Y.N., Adam, E.E., 1999. Efficacy of gamma irradiation against *Sitophilus granarius* L. Coleoptera: Curculionidae. *J. Stored Prod. Res.* 35, 225–232.
- Annis, P.C., 1987. Towards rational controlled atmosphere dosage schedules: A review of current knowledge. In: Donahaye, E., Navarro, S. (Eds.), *Proceedings of the Fourth International Working Conference on Stored Products Protection*. Maor-Wallach Press, Tel Aviv, Israel, pp. 128–148.
- Annis, P.C., Morton, R., 1997. The acute mortality effects of carbon dioxide on various life stages of *Sitophilus oryzae*. *J. Stored. Prod. Res.* 332, 115–124.
- Annis, P.C., Graver, J.E., van, S., 1991. Fumigation and controlled atmospheres in the 90 s and beyond. *Proceedings of the Fourteenth ASEAN Seminar on Grain Post Harvest Technology*. ASEAN Crops Post-Harvest Programme, Manila, Philippines.
- Apintanapong, M., Noomhorm, A., 2003. Microencapsulation of 2-acetyl-1-pyrroline, a major flavor component of aromatic rice by spray drying technique. *Int. J. Food Sci. Technol.* 38, 95–102.
- Attaviroj, N., Kasemsurran, S., Noomhorm, A., 2011. Rapid variety identification of pure rough rice by Fourier-transform near-infrared spectroscopy. *Cereal Chem.* 885, 490–496.
- Azanza, P.V., Basman, C.V., Maceda, G.A., 1998. Quick-cooking rice processes for Philippine rice cultivars. *Philipp. Technol. J.* 232, 87–100.
- Bailey, S.W., 1965. Air-tight storage of grain; its effect on insect pests-IV *Rhyzopertha dominica* F. and some other Coleoptera that infested stored grain. *J. Stored Prod. Res.* 1, 25–33.
- Banjong, K., 1986. A back extrusion test for evaluating cooked rice texture. Thesis No AE-86–20. AIT. Bangkok.
- Banks, H.J., 1987. Research and development opportunities for fumigation in the ASEAN region as a component of integrated commodity management. *Grain Postharvest Systems, Proceedings of the Tenth ASEAN Technical Seminar on Grain Post Harvest Technology*. ASEAN Crops Post-Harvest Programme, Bangkok, Thailand.
- Bao, J., Shu, Q., Xia, Y., Bergman, C., McClung, A., 2001. Effects of gamma irradiation on aspects of milled rice *Oryza sativa* end-use quality. *J. Food Qual.* 24, 327–336.
- Bao, J.S., Cai, Y.Z., Corke, H., 2001. Prediction of rice starch quality parameters by near-infrared reflectance spectroscopy. *J. Food Sci.* 667, 936–939.
- Bardet, G.V., Giesse, R.C., 1961. Processing of brown rice. U.S. Patent 2,992,921.
- Barney, R.J., Sedlacek, J.D., Siddiqui, M., Price, B.D., 1991. Quality of stored corn maize as influenced by *Sitophilus zeamais* Motsch. and several management practices. *J. Stored Prod. Res.* 274, 225–237.
- Baz, A.A., Hsu, J.Y., Scoville, E., 1992. Preparation of quick cooking rice. U.S. Patent 5,089,281.
- Beckett, S.J., Morton, R., 2003. Mortality of *Rhyzopertha dominica* F. Coleoptera: Bostrychidae at grain temperatures ranging from 50 °C and 60 °C obtained at different rates of heating in a spouted bed. *J. Stored Prod. Res.* 393, 313–332.
- Berrios, J.D.J., Swanson, B.G., Cheong, W.A., 1999. Physico-chemical characterization of stored black beans *Phaseolus vulgaris* L. *Food Res. Int.* 32, 669–676.
- Bhatia, S.K., 1976. Resistance to insects in stored grains. *Trop. Stored Prod. Inf.* 31, 21–35.
- Black, C.K., Panozzo, J.F., 2004. Accurate technique for measuring color values of grain and grain products using a visible-NIR instrument. *Cereal Chem.* 814, 469–474.

- Boulanger, R.L., Boerner, W.M., Hamid, M.A.K., 1971. Microwave and dielectric heating systems. *Milling* 153 (2), 18–21, 24–28.
- Bourne, M.C., 1982. *Food Texture and Viscosity: Concept and Measurement*. Academic Press, Inc., London.
- Breese, M.H., 1960. The infestability of stored paddy by *Sitophilus sasaki* (Tak.) and *Rhizopertha dominica* (F.). *Bull. Ent. Res.* 57, 599–630.
- Buttery, R.G., Juliano, B.O., Ling, L.C., 1982. Identification of rice aroma compound 2-acetyl-1-pyrroline in pandan leaves. *Chem. Ind. London* 23, 958–959.
- Buttery, R.G., Ling, L.C., Juliano, B.O., Turnbaugh, J.G., 1983. Cooked rice aroma and 2-acetyl-1-pyrroline. *J. Agric. Food Chem.* 31, 823–826.
- Buttery, R.G., Stern, D.J., Ling, L.C., 1994. Studies on flavor volatiles of some sweet corn products. *J. Agric. Food Chem.* 42, 791–795.
- Calderon, M., Navarro, S., Donahaye, E., 1966. The effect of low pressure on the mortality of six stored product insect species. *J. Stored Prod. Res.* 2, 135–140.
- Calderon, M., Navarro, S., Lindner, Z., 1970. Effect of common fumigants on the baking qualities of wheat. *Cereal Chem.* 47, 422–428.
- Carlson, R.A., Roberts, R.L., Farkas, D.F., 1979. Process for preparing quick-cooking rice U. S. Patent 4,133,898.
- Champagne, E.T., Lyon, B.G., Min, B.K., Vinyard, B.T., Bett, K.L., Barton II, F.E., et al., 1998. Effect of postharvest processing on texture profile analysis of cooked rice. *Cereal Chem.* 75, 181–186.
- Champagne, E.T., Karen, L.B., Grimm, C.C., McClung, A.M., Moldenhauer, K.A., Linscombe, S., et al., 2001. Near-infrared reflectance analysis for prediction cooked rice texture. *Cereal Chem.* 78, 358–362.
- Chaudhry, M.A., Glew, G., 1973. The effect of ionizing radiations on some physical and chemical properties of Pakistani rice. *J. Food Technol.* 8, 295–303.
- Cheevitsopon, E., Noomhorm, A., 2011. Effects of parboiling and fluidized bed drying on the physico-chemical properties of germinated brown rice. *IJFST*.
- Chrastil, J., 1990. Chemical and physicochemical changes of rice during storage at different temperature. *J. Cereal Sci.* 111, 71–85.
- Cline, L.D., Highland, H.A., 1978. Survival of four species of stored-product insects in airtight laminated food pouches. *J. Econ. Entomol.* 71, 66–68.
- Daniels, R., 1970. *Rice and Bulgur Quick-Cooking Processes*. Noyes Data Corporation, New Jersey.
- Del Mundo, A.M., 1979. Sensory assessment of cooked milled rice. *Proceedings Workshop on Chemical Aspects of Rice Grain Quality*. Int. Rice Res. Inst., Los Bahos, Laguna, Philippines, pp. 313–325.
- Delwiche, S.R., Norris, K.H., 1993. Classification of hard red wheat by near-infrared diffuse reflectance spectroscopy. *Cereal Chem.* 70, 29–35.
- Delwiche, S.R., Bean, M.M., Miller, R.E., Webb, B.D., Williams, P.C., 1995. Apparent amylose content of milled rice by near-infrared reflectance spectrophotometry. *Cereal Chem.* 72, 182–187.
- Delwiche, S.R., McKenzie, K.S., Webb, B.D., 1996. Quality characteristics in rice by near infrared reflectance analysis of whole grain milled samples. *Cereal Chem.* 73, 257–263.
- Delwiche, S.R., Graybosch, R.A., Peterson, C.J., 1998. Predicting protein composition, biochemical properties, and dough handling properties of hard red winter wheat flour by near-infrared reflectance. *Cereal Chem.* 75, 412–416.
- Dermott, T., Evans, D.E., 1978. An evaluation of fluidized bed heating as a means of disinfesting wheat. *J. Stored Prod. Res.* 14, 1–12.
- Dobie, P., Haines, C.P., Hodges, R.J., Prevett, P.F., 1984. *Insect and Arachnids of Tropical Stored Products: Their Biology and Identification a Training Manual*. Tropical Development and Research Institute, Slough, England.
- Donahaye, E.J., Navarro, S., Rindner, M., Azrieli, A., 1996. The combined influence of temperature and modified atmospheres on *Tribolium castaneum* Herbst Coleoptera: Tenebrionidae. *J. Stored Prod. Res.* 32, 225–232.
- Exell, R.H.B., Kornsakoo, S., 1977. *A Low Cost Solar Rice Dryer*. Asian Institute of Technology, Research Report, Bangkok, Thailand.

- Fan, J., 1999. Effect of postharvest operations on the gelatinization and retrogradation properties of long-grain rice. *Trans. ASAE* 423, 727–731.
- Finkelmann, S., Navarro, S., Rindner, M., Dias, R., Azrieli, A., 2003. Effect of low pressure on the survival of cocoa pest at 18°C. *J. Stored Prod. Res.* 39, 423–431.
- Finkelmann, S., Navarro, S., Rindner, M., Dias, R., Azrieli, A., 2004. Effect of low pressure on the survival of three cocoa pests at 30°C. *J. Stored Prod. Res.* 40, 499–506.
- Fox, R.A., 1989. Plastic packaging—the consumer preference of tomorrow. *Food Technol.* 43, 84–85.
- Gorozpe, R.D., 1964. Method for preparing quick-cooking rice. U.S. Patent 3,157,514.
- Hamaker, B.R., Griffin, V.K., Moldenhauer, K.A.K., 1991. Potential influence of a starch granule-associated protein on cooked rice stickiness. *J. Food Sci.* 565, 1327–1329, 1346.
- Hayashi, T., Okadome, H., Toyoshima, H., Todoriki, S., Ohtsubo, K., 1998. Rheological properties and lipid oxidation of rice decontaminated with low-energy electrons. *J. Food Prot.* 61 (1), 73–77.
- Hole, B.D., Bell, C.H., Mills, K.A., Goodship, G., 1976. The toxicity of phosphine to all developmental stages of thirteen species of stored product beetles. *J. Stored Prod. Res.* 12, 235–244.
- Howe, R.W., 1973. The susceptibility of the immature and adult stages of *Sitophilus granarius* to phosphine. *J. Stored Prod. Res.* 8, 241–262.
- Hyde, M.B., 1962. Airtight storage of grain. *Ann. Appl. Biol.* 50, 362–364.
- Hyllstam, M., Norberg, M., Sten, P., 1998. Method of processing rice to provide a quick-cooking rice. U.S. Patent 5,820,909.
- Inprasit, C., Noomhorm, A., 1999. Effect of drying air temperature and grain temperature of different types of dryer and operation on rice quality. Research of agricultural and food engineering program, School of Environmental, Resources and Development. Asian Institute of Technology, Thailand.
- Irabagon, T.A., 1959. Rice weevil damage to stored corn. *J. Econ. Entomol.* 52 (6), 1130–1136.
- Jindal, V.K., Obaldo L.G., 1986. Rice Husk-fired rotary dryer for disinfestation and rapid drying of paddy. Proceedings of Ninth ASEAN Technical Seminar on Grain Postharvest Technology, Singapore, 26–29 August 1986. Bangkok: ASEAN Crops Post-harvest Programme, pp. 408.
- Juliano, B.O., 1981. Rice grain properties and resistance to storage insects: A review. *IRRI. Res. Pap. Ser.* 56, 1–9.
- Juliano, B.O. 1982. An international survey of methods used for evaluation of the cooking and eating qualities of milled rice. *IRRI Research Paper Series No 77.*
- Kawamura, S., Natsuga, M., Itoh, K., 1997. Visual and near infrared reflectance spectroscopy for rice taste evaluation. *Trans. ASAE.* 406, 1755–1759.
- Kimura, T., Shimizu, N., Shimohara, T., Warashina, J., 1995. Trials of quality evaluation for parboiled and other rice by means of near infrared spectroscopy and the rapid visco analyzer. *J. Soc. Agric. Struct. Japan* 254, 175–182.
- Kirkpatrick, R.L., Brower, J.H., Tilton, E.W., 1972. A comparison of microwave and infra-red radiation to control rice weevil *Coleoptera: Curculionidae* in wheat. *J. Kans. Ent. Soc.* 45, 434–438.
- Kongseree, N., Khowchaimaha, L., Natesomranh, K., 1985. Changes in cooking and eating qualities of rice during long-term storage. In: Semple, R.L., Frio, A.S. (Eds.), *Research and Development Systems and Linkages for a Viable Grain. Post-Harvest Industry in the Humid Tropics*, Proceedings of the Eighth ASEAN Technical Seminar on Grain Post Harvest Technology. ASEAN Crops Post-Harvest Programme, Manila, Philippines, pp. 165–187.
- Laksanalamai, V., Ilgantileke, S., 1993. Comparison of aroma compound 2-acetyl-1-pyrroline in leaves from pandan *Pandanus amaryllifolius* and Thai fragrant rice *Khao Dawk Mali-105*. *Cereal Chem.* 704, 381–384.
- Lampi, R.A., 1979. Flexible packaging for thermoprocessed foods. In: Jackson, J.M., Shinn, B.M. (Eds.), *Fundamentals of Food Canning Technology*. AVI Publishing Co., Inc., Westport, Connecticut.
- Laohakunjit, N., Noomhorm, A., 2004a. Supercritical carbon dioxide extraction of 2-acetyl-1-pyrroline and volatile components from pandan leaves. *Flavour. Frag. J.* 19, 251–259.
- Laohakunjit, N., Noomhorm, A., 2004b. Effect of plasticizers on mechanical and barrier properties of rice starch film. *Starch* 56 (8), 348–356.
- Lee, S.J., Singh, R.P., 1991. Influence of parboiling and freezing condition on textural properties of California cooked rice. *J. Food Qual.* 14, 407–423.

- Likitrattanaporn, C., 1996. Design of rotary dryer with combined conduction and convection heating. Proceedings of Agricultural Engineering Annual Meeting, 21 November 1996, Bangkok, Thailand.
- Likitrattanaporn C., Ahmad, I., Sirisoontaralak, P., Noomhorm, A., 2003. Performance evaluation of a mobile rotary dryer for high moisture paddy. Proceedings of the Third Asia-Pacific Drying Conference 1–3 September 2003 Asian Institute of Technology, Bangkok, Thailand, pp. 199–207.
- Lima, I., Singh, R.P., 1993. Objective measurement of retrogradation in cooked rice during storage. *J. Food Qual.* 16, 321–337.
- Limphanudom, P., 1997. Textural characterization of cooked rice. AIT Dissertation no. AE-97–4. Asian Institute of Technology, Bangkok, Thailand.
- Limpisut, P., 2002. Indirect assessment of cooked rice eating quality. Dissertation No. PH-02–1, Asian Institute of Technology, Bangkok, Thailand.
- Lin, C.F., Hsien, T.C.Y., Hoff, B.J., 1990. Identification and quantification of the popcorn-like aroma in Louisiana Aromatic Delta rice *Oryza sativa* L. *J. Food Sci.* 55, 1466–1467.
- Lindgren, D.L., Vincent, L.E., 1970. Effects of atmospheric gases alone or in combination on the mortality of granary and rice weevils. *J. Econ. Entomol.* 63, 1926–1929.
- Loaharanu, S., Sutantawong, M., Ungsunantawiwat, A., 1971. Sensory acceptability evaluation of irradiated rice, *Oryza sativa indica*. Technical report THAI AEC-50. Bangkok, Thailand, OAEF.
- Locatelli, D.P., Daolio, E., 1993. Effectiveness of carbon dioxide under reduced pressure against some insects infesting packaged rice. *J. Stored Prod. Res.* 29, 81–87.
- Lorenz, K., Meredith, P., 1988. Insect-damaged wheat: history of the problem, effects on baking quality, remedies. *Lebensm. Wiss. U. Technol.* 21, 183–187.
- Luh, B.S., Roberts, R.L., Li, C.F., 1980. Quick cooking rice. *Rice Production and Utilization*. AVI publishing Co., Westport, CT, 566–588.
- Maghirang, E.B., Dowell, F.E., 2003. Hardness measurement of bulk wheat by single-kernel visible and near-infrared reflectance spectroscopy. *Cereal Chem.* 803, 316–322.
- Matthews, R.H., Fifield, C.C., Hartsing, 1970. Effects of fumigation on wheat in storage. II. Physical and eating qualities of breads and rolls. *Cereal Chem.* 47, 587–591.
- McCabe, D., 1976. Process for preparing quick-cooking brown rice and the resulting product. U.S. Patent 3,959,515.
- Meadows, F., Barton, F., 2002. Determination of rapid visco analyzer parameters in rice by near infrared spectroscopy. *Cereal Chem.* 794, 563–566.
- Mermelstein, N.H., 1978. Retort Pouch Earns. 1978. Food technology industrial achievement award. *Food Technol.* 326, 22–33.
- Meullenet, J.F., Gross, J., Marks, B.P., Danials, M., 1998. Sensory descriptive texture analyses of cooked rice and its correlation to instrumental parameters using an extrusion cell. *Cereal Chem* 755, 714–720.
- Meullenet, J.F., Marks, B.P., Griffin, K., Danials, M.J., 1999. Effects of rough rice drying and storage conditions on sensory profiles of cooked rice. *Cereal Chem.* 764, 483–486.
- Meullenet, J.F., Marks, B.P., Hankins, J., Griffin, V.K., Danials, M.J., 2000a. Sensory quality of cooked rice as affected by rough rice moisture content, storage temperature, and storage duration. *Cereal Chem.* 772, 259–263.
- Meullenet, J.F., Champagne, E.T., Bett, K.L., McClung, A.M., Kauffmann, D., 2000b. Instrument assessment of cooked rice texture characteristics: A method for breeders. *Cereal Chem.* 774, 512–517.
- Meullenet, J.F., Mauromoustakos, A., Horner, T.B., Marks, B.P., 2002. Prediction of texture of cooked white rice by near-infrared reflectance analysis of whole grain milled samples. *Cereal Chem.* 791, 52–57.
- Miller, F.J., 1963. Process for preparing a quick-cooking brown rice. U.S. Patent 3,086,867.
- Mitsuda, H., Yamamoto, A., 1980. Advances in grain storage in a CO<sub>2</sub> atmosphere in Japan. In: Shejbal, J. (Ed.), *Developments in Agricultural Engineering, 1 Controlled Atmosphere Storage of Grains*. Elsevier, Amsterdam, pp. 235–246.
- Mitsuda, H., Kawai, F., Yamamoto, A., 1972. Underwater & underground storage of cereal grains. *Food Technol.* 26, 50–56.

- Monphakdee, K., 1990. Important factors affecting the process of quick-cooking rice. Thesis, Chulalongkorn University, Bangkok.
- Moreno-Martinez, E., Jimenez, S., Vazquez, M.E., 2000. Effect of *Sitophilus zeamais* and *Aspergillus chevalieri* on the oxygen level in maize stored hermetically. *J. Stored Prod. Res.* 36, 25–36.
- Nakakita, H., Kawashima, K., 1994. A new method to control stored-product insects using carbon dioxide with high pressure followed by sudden pressure loss. In: Highley, E., Wright, E.J., Banks, H.J., Champ, B.R. (Eds.), *Stored-Product Protection: Proceedings of the Sixth International Working Conference on Stored-Product Protection*. CAB International, Oxon, pp. 126–129.
- Navarro, S., Calderon, M., 1972. Exposure of *Ephestia cautella* Wlk. Lepidoptera, Phycitidae to low pressures: Effects on adults. *J. Stored Prod. Res.* 8, 209–212.
- Nelson, S.O., 1972. Possibility to controlling stored-grain insects with RF energy. *J. Microw. Power* 7, 231–239.
- Noomhorm, A., Sirisoontarak, P., Uraichoen, C., Ahmad, I., 2005. Control of insect infestation in milled rice using low pressure carbon dioxide. *Proceedings of the International Conference on Innovations in Food Processing Technology and Engineering*. AIT, Pathumthani, pp. 600–608.
- Onda, Y., Abe, H., Komiymato, Y., Kawano, S., 1994. *Nippon Nogeik. Kaishi* 73, 33.
- Ory, R.L., Delucca II, A.J., Angelo St., A.J., Dupuy, H.P., 1980. Storage quality of brown rice as affected by packaging with and without carbondioxide. *J. Food Prot.* 43 (12), 929–932.
- Osman, N., 1984. Assessment of damage by the rice moth *Corcyra Cephalonica* St. on different grains at four levels of moisture content. *Health and Ecology in Grain Post-Harvest Technology, Proceedings of the Seventh ASEAN Technical Seminar on Grain Post-Harvest Technology*. ASEAN Crops Post-Harvest Programme, Kuala Lumpur, Malaysia.
- Oxley, T.A., Wickenden, G., 1962. The effect of restricted air supply on some insects which infest grain. *Ann. Appl. Biol.* 51, 313–324.
- Paule, C.M., Powers, J., 1989. Sensory and chemical examination of aromatic and non aromatic rices. *J. Food Sci.* 54, 343–347.
- Pingale, S.V., Kadkol, S.B., Narayana Rao, M., Swaminathan, M., Subrahmanyam, V., 1957. Effect of insect infestation on stored grain. II. Studies on husked, hand-pounded and milled raw rice, and parboiled milled rice. *J. Sci. Food Agric.* 8, 512–516.
- Pixton, S.W., Warburton, S., Hill, S.T., 1975. Long-term storage of wheat-III: Some changes in the quality of wheat observed during 16 years of storage. *J. Stored Prod. Res.* 11, 177–185.
- Polansky, M.M., Toepfer, E.W., 1971. Effect of fumigation on wheat in storage. III. Vitamin B-6 Components of wheat and wheat products. *Cereal Chem.* 48, 392–396.
- Press Jr., A.F., Harein, P.K., 1967. Mortality of *Tribolium castaneum* Herbst Coleoptera, Tenebrionidae in simulated peanut storage purged with carbon dioxide and nitrogen. *J. Stored Prod. Res.* 3, 91–96.
- Puechkamutr, Y., 1985. Design and development of a natural convection rotary dryer for paddy. M.Eng Thesis No. AE-85–18, AIT, Bangkok, Thailand.
- Puechkamutr, Y., 1988. Accelerated drying of paddy in rotary conduction heating units. Ph.D. Dissertation No. AE-88, AIT, Bangkok, Thailand.
- Rangsardthong, V., Noomhorm, A., 2005. Identification and some properties of 2-acetyl-1-pyrroline, the principal aromatic rice flavor compound, from *Acremonium nigrkans*. *Flavour Frag. J.* In submission.
- Regalado, M.J.C., Madamba, P.S., 1997. Design and testing of a conduction-convection type rotary drum dryer. *Philipp. Agric. Mech. Bull.* 4, 27–41.
- Reynolds, E.M., Robinson, J.M., Howells, C., 1967. The effect of *Sitophilus granarius* of exposure to low concentrations of phosphine. *J. Stored Prod. Res.* 2, 177–186.
- Risch, S.J., Reineccius, G.A., 1995. Encapsulation and controlled release of fod ingredients. American Chemical Society, Washington, DC.
- Roberts, R.L., 1972. Quick cooking rice. *Rice Chemistry and Technology*. American Association of Cereal Chemists, Inc., pp. 381–399.
- Roberts, R.L., Carlson, R.A., Farkas, D.F., 1979. Application of a continuous centrifugal fluidized bed drier to the preparation of quick-cooking rice products. *J. of Food Sci.* 44, 248–250.



- Romanczyk Jr, L.J., McClelland, C.A., Post, L.S., Aitken, W.H., 1995. Formation of 2-acetyl-1-pyrroline by several *Bacillus cereus* strains isolated from cocoa fermentation boxes. *J. Agric. Chem.* 43, 469–475.
- Rout, G., Senapati, G., Ahmed, T., 1976. Studies on relative susceptibility of some high yielding varieties of rice to the rice weevil, *Sitophilus oryzae* L. *Bull. Grain. Technol.* 14, 34–38.
- Roy, M.K., Ghosh, S.K., Chatterjee, S.R., 1991. Gamma irradiation of rice grains. *J. Food Sci. Technol.* 28 (6), 337–340.
- Rubenthaler, G.L., Pomeranz, Y., 1987. Near-infrared reflectance spectra of hard red winter wheats varying widely in protein content and breadmaking potential. *Cereal Chem.* 64, 407–411.
- Russell, M.P., Cogburn, R.R., 1977. World collection rice varieties: resistance to seed penetration by *Sitotroga cerealella* Oliv. *J. Stored Prod. Res.* 13, 103–108.
- Sabulase, V.C., Liuzzo, J.A., Rao, R.M., Grodner, R.M., 1991. Cooking quality of brown rice as influenced by gamma irradiation, variety and storage. *J. Food Sci.* 56 (1), 96–98, 108.
- Sabulase, V.C., Liuzzo, J.A., Rao, R.M., Grodner, R.M., 1992. Physicochemical characteristics of brown rice as influenced by gamma irradiation. *J. Food Sci.* 57 (1), 143–145.
- Samuels, R., Modgil, R., 1999. Physico-chemical changes in insect infested wheat stored in different storage structures. *J. Food Sci. Technol. India* 36 (5), 479–482.
- Schieberle, P., 1989. Thermal generation of aromas. In: Parliament, T.H., McGorin, R.J., Ho, C.-T. (Eds.), ACS Symposium Series, 409. American Chemical Society, Washington, DC, pp. 268–275.
- Schieberle, P., 1990. The role of free amino acids present in yeast as precursors of the odorants 2-acetyl-1-pyrroline and 2-acetyl tetrahydropyridine in wheat bread crust. *Z. Lebensm. Unters. Forsch.* 191, 206–209.
- Schieberle, P., 1991. Primary odorants of popcorn. *J. Agric. Food Chem.* 39, 1141–1144.
- Schieberle, P., Grosch, W., 1985. Identification of volatile flavor compounds of wheat bread crust-comparison with rye bread crust. *Z. Lebensm. Unters. Forsch.* 180, 474–478.
- Schieberle, P., Grosch, W., 1987. Quantitative analysis of aroma compounds in wheat and rye bread crusts using a stable isotope dilution assay. *J. Agric. Food Chem.* 35, 252–257.
- Sidik, M., Pedersen, J.R., 1984. The extent of damage to stored milled rice due to insect infestation. Health and Ecology in Grain Post-Harvest Technology, Proceedings of the Seventh ASEAN Technical Seminar on Grain Post-Harvest Technology. ASEAN Crops Post-Harvest Programme, Kuala Lumpur, Malaysia.
- Sirisoontarak, P., Noomhorm, A., 2005. Changes to physicochemical properties and aroma of irradiated rice. *J. Stored Prod. Res.* Article in press.
- Sitakalin, C., Meullenet, J.F., 2000. Prediction of cooked rice texture using extrusion and compression tests in conjunction with spectral stress strain analysis. *Cereal Chem.* 774, 501–506.
- Smith, D.A., Rao, R.M., Liuzzo, J.A., Champagne, E., 1985. Chemical treatment and processes modification for producing improved quick-cooking rice. *J. Food Sci.* 50, 926–931.
- Smith, L.W., Pratt Jr., J.J., Nii Jr., I., Umina, A.P., 1971. Baking and taste properties of bread made from hard wheat flour infested with species of *Tribolium*, *Tenebrio*, *Trogoderma* and *Oryzaephilus*. *J. Stored Prod. Res.* 6, 307–316.
- Soderstrom, E.L., Brand, D.G., Mackey, B., 1992. High temperature combined with carbon dioxide enriched or reduced oxygen atmospheres for control of *Tribolium castaneum* Herbst (Coleoptera: Tenebrionidae). *J. Stored Prod. Res.* 284, 235–238.
- Soekarna, D., 1985. A review of post-harvest pest management practices in Indonesia. Research and Development Systems and Linkages for a Viable Grain Post-Harvest Industry in the Humid Tropics, Proceedings of the Eighth ASEAN Technical Seminar on Grain Post-Harvest Technology. ASEAN Crops Post-Harvest Programme, Manila, Philippines.
- Sohn, M., Barton, F.E., McClung, A.M., Champagne, E.T., 2003. Near-infrared spectroscopy for determination of protein and amylase in rice flour through use of derivatives. *Cereal Chem.* 813, 341–344.
- Soponronnarit, S., 2003. Fluidized bed grain drying. Proceedings of the Third Asia-Pacific Drying Conference 1–3 September 2003. Asian Institute of Technology, Bangkok, Thailand, pp. 56–71.
- Sowbhagya, C.M., Bhattacharya, K.R., 1976. Lipid autoxidation in rice. *J. Food Sci.* 41, 1018–1023.

- Spratt, E.C., 1975. Some effects of the carbon dioxide absorbency of humidity controlled solutions on the results of life history experiments with stored product insects. *J. Stored Prod. Res.* 2, 127–134.
- Suzuki, H., 1979. Use of Texturometer for measuring the texture of cooked rice. *Proceedings of the Workshop on Chemical Aspects of Rice Grains Quality*. IRRI, Los Banos, Laguna, Philippines, pp. 327–341.
- Suzuki, K., Kubota, K., Omichi, M., Hosaka, H., 1976. Kinetic studies on cooking of rice. *J. Food Sci.* 41, 1180–1183.
- Swamy, I.Y.M., Unnikrishnan, K.R., Narasimhan, K.S., 1993. Changes in free fatty acids and insect infestation during storage of brown rice obtained by shelling paddy in rubber roll and disc shellers. *J. Food Sci. Technol. India* 305, 324–330.
- Tanchotikul, U., Hsieh, T.C.Y., 1991. An improved method for quantification of 2-acetyl-1-pyrroline, a popcorn-like aroma in aromatic rice by high-resolution gas chromatography/mass spectrometry/selective ion monitoring. *J. Agric. Food Chem.* 39, 944–947.
- Taskeen Aliniyazee, M., 1971. The effects of carbon dioxide gas alone or in combinations on the mortality of *Tribolium castaneum* Herbst and *T. confusum* du Val Coleoptera, Tenebrionidae. *J. Stored Prod. Res.* 7, 243–252.
- Velupillai, L., 1994. Parboiling Rice with Microwave Energy. In W.E. Marshall and J.I.
- Venkatrao, S., Nuggehalli, N., Pingale, S.V., Swaminathan, M., Subrahmanyam, V., 1960. The effect of infestation by *Tribolium castaneum* Duv. on the quality of wheat flour. *Cereal Chem.* 37, 97–103.
- Wang, U.P., Lee, C.Y., Chang, Y.L., Yet, C.L., 1983. Gamma radiation effects on Taiwan produced rice grains. *Agric. Biol. Chem.* 47, 461–472.
- Wesley, I.J., Osborne, B.G., Anderssen, R.S., Delwiche, S.R., Graybosch, R.A., 2003. Chemometric localization approach to NIR measurement of apparent amylase content of ground wheat. *Cereal Chem.* 804, 462–467.
- Windham, W.R., Lyon, B.G., Champagne, E.T., Barton, F.E., Webb, B.D., McClung, A.M., et al., 1997. Prediction of cooked rice texture quality using near-infrared reflectance analysis of whole grain milled samples. *Cereal Chem.* 745, 623–626.
- Winks, R.G., Banks, H.J., Williams, P., Bengston, M., Greening, H.G., 1980. Dosage recommendations for the fumigation of grain with phosphine. SCA Tech. Rep. Ser. No. 8.
- Wootton, M., Djojonegoro, H., Driscoll, R., 1988. The effect of gamma irradiation on the quality of Australian rice. *J. Cereal Sci.* 7, 309–315.
- Yadav B.K., 2004. Study of dimensional changes in rice kernels during milling, soaking and cooking using image analysis. AIT Dissertation Asian Institute of Technology, Bangkok, Thailand.

This page intentionally left blank

# Technology of Processing of Horticultural Crops

Conrad O. Perera and Bronwen Smith

University of Auckland, Auckland, New Zealand

## 1. INTRODUCTION

### 1.1 General Background

Fruits and vegetables are living “organs” of plants and are subject to damage by physical, physiological, and microbiological processes leading to rapid deterioration. Poor harvesting practices, lack of sorting to eliminate defects before storage, and the use of inadequate packaging materials further add to the problem. In general, minimizing physical bruising, sorting to remove damaged and diseased products, and effective temperature management will help considerably in maintaining product quality and reducing storage losses. If the temperature during the post-harvest period is kept as close to the optimum as possible for a given commodity, storage life could be enhanced considerably.

Thus, in order to obtain produce of optimum quality for processing, good pre-harvest and post-harvest technology practices are essential. In this chapter, we will discuss the general properties of fruits and vegetables, how deterioration may occur and ways of controlling it, general methods of preservation, some important methods of processing, quality assurance, and general requirements for processing operations.

### 1.2 Importance of Fruit and Vegetables

Fruits and vegetables have received widespread emphasis in recent years from nutritionists and health professionals, because of the increasing discoveries of their nutritional and functional health enhancing components. They are the main source of fiber, vitamins, minerals, and other minute trace elements, but increasingly important functional components.

Certain functional components such as carotenoids, especially lycopene, lutein, zeaxanthin, and beta carotenes, are known to have increased bio-accessibility and better absorption when they are processed rather than in their unprocessed state.

Therefore, certain fruits and vegetables may be better for being processed rather than in their unprocessed state. Processing is also an efficient and cost-effective way to preserve some fruits and vegetables, especially those only available seasonally.

### **1.3 Fruits and Vegetable Suitable for Processing**

Most fruits and vegetables can be processed, in one form or another. However, the important considerations that determine whether processing is worthwhile, are whether there is a demand for the processed products, whether the raw material would stand the processing conditions, and whether the products are seasonal or available throughout the year. Although a fruit may be excellent to eat fresh, it may not be necessarily good for processing. Processing generally requires frequent handling, peeling, slicing, high temperature and pressure, which can lead to adverse physical, chemical, and biological changes, which in turn may result in undesirable texture, flavor, and color changes.

A regular supply and availability of produce is a major determinant when planning to establish a processing center, to function as an economically viable entity. Growing, harvesting, collection, and transport of the raw materials to the factory site are important logistical considerations for an efficient and economic processing operation.

### **1.4 Location of Processing Operation**

The location of the processing operation is another important consideration. Choosing a location that minimizes the average production cost, including transport and handling, will not only add to the profits, but also have a significant effect on the quality of the products processed. It is an advantage to locate the processing operation near a fresh raw material supply. It allows perishable raw materials to be transported with the least risk of injury and damage to quality.

An adequate supply of good water, availability of manpower, proximity to rail or road transport facilities, and adequate markets are other important requirements.

### **1.5 Processing Systems**

Fruit and vegetable processing systems can be broadly categorized into three classes, based on the scale of processing.

#### ***1.5.1 Small-Scale Processing***

This is done at the cottage industry level by small-scale farmers for personal subsistence or for sale in nearby markets. Such processing requires little investment but it is time consuming and tedious. Small-scale processing satisfies the needs of rural communities in some less developed countries. However, with the increase in population

and greater tendency toward urbanization, there is a need for more processed and diversified types of food.

### ***1.5.2 Intermediate-Scale Processing***

In this scale of processing, a group of small-scale processors pool their resources. This can also be done by individuals. Processing is based on the technology used by small-scale processors with differences in the type and capacity of equipment used. The raw materials are usually grown by the processors themselves or are purchased on contract from other farmers. Intermediate-scale processing can provide quantities of processed products to urban areas.

### ***1.5.3 Large-Scale Processing***

Processing in this system is highly mechanized and requires a substantial supply of raw materials for economical operation. This system requires a large capital investment, high technical and managerial skills, and adequate quantities of regular supplies of raw materials.

All three types of processing systems have a place in different countries to different extents to complement crop production to meet food demand. However, historically, small- and intermediate-scale processing have proven to be more successful than large-scale processing in the developing countries. The choice of processing system depends entirely on the type of industry and the extent of infrastructure for growing, transport, manpower, technology, and other resources available in different countries, as well as the marketing opportunities for the products processed.

## **2. PROPERTIES OF FRUITS AND VEGETABLES**

### **2.1 General Background**

Fruits and vegetables are living entities that continue to respire after harvest. Moreover, some may photosynthesize and importantly and particularly for fruit, continue to undergo major structural and compositional changes associated with development, including ripening and senescence. Fruits and vegetables are highly perishable and their shelf-lives are influenced by a range of factors. These include genetic factors, environmental conditions during growth and at harvest, as well as the extent of care taken with handling, transport, and storage conditions.

Further, each species of fruit and each individual fruit within a species has different biological characteristics (biological variation) and may respond differently to a given set of conditions. Therefore, different strategies have to be adopted for each species and for some procedures (e.g. controlled atmosphere storage), for each cultivar in order to maintain fruits and vegetables in excellent condition. Thus, to solve problems

associated with the processing of fruits and vegetables, it is critical to understand their individual biologies.

## 2.2 Fruit Development

Fruit development follows three phases (Gillaspy *et al.*, 1993), including:

1. Ovary development, fertilization, and fruit set.
2. Growth by cell division, seed formation, and ovary development.
3. Cell expansion and embryo maturation.

Bud initiation, which may have occurred during the previous season or may be a continual process in tropical areas, is followed by floral differentiation, which involves rapid cell division and differentiation into a flower or inflorescence (anthesis), pollination, and fertilization. Each flower contains a gynoecium, which may contain one or more carpels comprising an ovary containing an ovule(s) attached to the ovary wall by a placenta together with a style and stigma. Following fertilization and seed formation, the fruit develops from these parts of the gynoecium together with other floral tissues, including the receptacle, bracts, and calyx.

As there is great variation in floral layout among the taxa, the resultant fruit also vary widely in their structure.

Each part of the mature fruit therefore carries a heritage of its biological responsibilities in the flower and undergoes differentiation into new parts with an overall new purpose of seed dispersal. The wall of the ovary develops into the pericarp, which comprises three regions, the endocarp, mesocarp, and exocarp. Fruit set describes the point where the floral parts have withered and a small potential fruit has appeared. This may be followed by a “drop”, when some of the fruitlets abscise. In general, fruit expand initially by cell division, for example, apples, and this occurs in the first 4–6 weeks, and then by cell expansion.

Fruits that humans eat display a variety of forms depending on the potential of the floral tissue. Some floral tissues (e.g. receptacle, calyx, bracts, floral tube) develop into the edible parts of the mature fruit (e.g. strawberry, apples, pears, pineapple). Carpellary tissue itself can give rise to a variety of simple forms, such as peaches, as well as more complex structures, such as oranges. Mechanisms that control fruit development are poorly understood and complicated by the wide variety of forms but in avocado, isoprenoid and carbohydrate metabolism appear to have central roles together with plant growth regulators (Cowan *et al.*, 2001). Irrespective of the type of fruit, all the ripening mechanisms are directed toward seed dispersal.

Other forms of plant material we eat include ground vegetables derived from roots (e.g. sweet potatoes, carrots), modified stems (e.g. potatoes (tuber), taro (corm)), and modified buds (onions and garlic bulbs). Herbage vegetables include leaves (e.g. cabbage, spinach, lettuce), petioles (e.g. celery, rhubarb), flower buds (e.g. cauliflower,

broccoli), and sprouts and shoots (e.g. asparagus, bamboo shoots). Vegetables that are botanically fruits include legumes (e.g. peas, green beans), cereals (e.g. sweet corn), vines (e.g. squash, cucumber), berries (e.g. tomatoes), and trees (e.g. avocado). Many of this latter group of vegetables need to be managed as fruit.

## 2.3 Chemical Composition

### 2.3.1 Water

Water comprises 70–90% fresh wt of most fruits and vegetables. It is held in the vacuoles, cytoplasm, and cell walls. Cells are highly hydrated entities in which the aqueous environment allows movement of organelles and metabolites within the cells and between cells of tissues through the apoplastic space. Fully turgid cells together with tissue morphology and cell wall integrity are responsible for the texture of plant foods (Harker *et al.*, 1997, 2003). Freshness is associated with crispness and fully turgid cells, whereas age and poor handling are indicated by limp and withered material. Freezing and formation of ice crystals causes rupture of membranes and loss of cellular integrity. Drying and removal of water may cause irreversible cellular changes (Bai *et al.*, 2002) and make rehydration difficult.

### 2.3.2 Sugars

Sugars found in fruits are predominantly sucrose, fructose, and glucose. Sugar alcohols, such as sorbitol, may be found in apples and some other fruit. Sugars are largely respiratory substrates and a source of carbohydrate post harvest. In some fruit, sugars may accumulate prior to ripening and these fruits can be harvested green, for example, tomatoes. Sugars make up a substantial proportion of the soluble solids component of plant tissue and can easily be measured in the field by hand held refractometers to give an indication of the stage of ripeness of a crop. This method is practical when making comparative measurements year to year from the same stock. More accurate measurement can be achieved analytically by HPLC (Reed *et al.*, 2004). Regardless of the method of measurement, differences may occur in the amount of analyte in fruit, depending on the position of the tissues from which the sample is taken (Hopkirk *et al.*, 1986) and the age of the fruit (Snelgar *et al.*, 1993).

### 2.3.3 Organic Acids

Organic acids provide acidity and contribute to flavor. The relative proportion in fruit usually declines as it ripens and sugars increase. Malic acid is commonly found in apples, pears, plums, and bananas, and citric acid is common in oranges, lemons, and bananas.

Chlorogenic acid is common in young apples, pears, peaches, and plums. Quinic acid may also be found in apples, apricots, peaches, and banana. Oxalic acid is present as insoluble calcium oxalate crystals, for example, in rhubarb petioles. Succinic acid is



found in small amounts in several fruit. Malate, citrate, and succinate are substrates in respiratory pathways. Measurement of organic acids is more difficult than soluble solids and usually requires laboratory facilities. A crude measure of total acidity can be obtained by titratable acidity, and individual organic acids can be identified by HPLC (Freidrich, 2002).

#### **2.3.4 Starch**

Starch is a carbohydrate source for plants and is usually located in the amyloplasts in cells. Starch comprises two polysaccharides, amylose and amylopectin, in varying proportions, which contribute different properties and functions. The structure, chemistry, gelatinization, and rheology characteristics have been well documented (Thomas and Atwell, 1999). When required as a respiratory substrate, starch may be degraded by amylases to maltose and glucose. Starch is present in many unripe fruit (apples, bananas, tomatoes) and is metabolized during development. Starch may also be present in ripe fruit, such as mangoes.

Some starch may be found in leafy vegetables, often in association with chloroplasts and as a storage carbohydrate in cereal grains and root vegetables (e.g. taro, sweet potato, cassava). Starch can easily be detected by examining the tissues microscopically after applying a solution of iodine in potassium iodide, which stains the intact granules blue-black (Jensen, 1962). As starch granules are crystalline, they birefringe under polarized light exhibiting the “Maltose Cross” characteristic. The extent of gelatinization of starch can therefore be monitored microscopically by loss of birefringence and staining.

#### **2.3.5 Phenolic Components**

Phenolic components in plant foods have been reviewed (Naczki and Shahidi, 2004). Phenolics are known to be synthesized by plants during normal growth as well as in response to a variety of stimuli, including pathogen invasion, wounding, and UV light (Schreiner, 2005). Phenolics may be present in different forms and concentrations among the various tissues, and contribute bitterness and astringency to flavor (e.g. green bananas, red wine), as well as to the oxidative stability of products. Some, such as chlorogenic acid, also act as substrates for the polyphenol oxidase group of enzymes, which are responsible for the browning reaction in cut and damaged fruits and vegetables (Whitaker and Lee, 1995).

Phenolic components are frequently found in polymeric form as tannins. Tannins are notoriously difficult to deal with analytically to determine their monomeric composition (Naczki and Shahidi, 2004). The Folin-Ciocalteu method (Waterhouse, 2002) is commonly used to measure total phenolics but is susceptible to interference from ascorbic acid and other reducing agents (Naczki and Shahidi, 2004). HPLC

incorporating diode array detection is necessary for separation and identification (Naczki and Shahidi, 2004).

In some fruit and vegetables, ferulic acid and other low molecular weight phenolic acids are linked to polysaccharides in the cell wall (Harris *et al.*, 1997; Parker *et al.*, 2003; Parker and Waldron, 1995; Rodriguez-Arcos *et al.*, 2004; Smith and Harris, 2001; Waldron *et al.*, 1997a; Wende *et al.*, 2000) and may cross-link the polysaccharides contributing to the wall architecture (Ishii and Hiroi, 1990). In Chinese water chestnut these are thought to contribute to the crispness of the texture, which remains after cooking (Parker and Waldron, 1995).

### **2.3.6 Flavor Volatiles**

The flavor and aroma of fruits and vegetables arise from complex mixtures of numerous compounds, which are present in differing amounts among species. Chemicals contributing to flavor are predominantly esters, aldehydes, and alcohols. The characteristic flavor of a fruit arises from combinations of the various compounds but often one or a few components provide the distinctive flavor for that fruit, for example, over 130 for pineapple and the major compounds being methyl butanoate and methyl 2-methylbutanoate (Elss *et al.*, 2005), and over 100 for papaya with linalool and benzyl isothiocyanate predominating (Flath *et al.*, 1990). Vegetables also have characteristic aromas. Cabbage (*Brassica oleracea* var *capitata*) contains sulfur compounds, which when heated during cooking release hydrogen sulfide and methanethiol that smell like rotten eggs (Chin and Lindsay, 1993).

### **2.3.7 Plant Pigments**

Chlorophyll is the green lipid-soluble photosynthetic pigment located in the thylakoid membranes of chloroplasts and is present in two main forms, chlorophyll *a* and *b*. Chlorophyll is well described by Papageorgiou and Govindjee (2004). Basically, the chemical structure is that of a porphyrin ring with magnesium as the prosthetic group. Phytol alcohol is ester-linked to one of the pyrrole groups and methyl alcohol to another. The amount of chlorophyll in plants varies dependent on species and organ, for example, fruit or leaves. In both the amount can change with environment, soil conditions, and fruit ripening but not always, for example, Granny Smith apples remain green-skinned when ripe. When present in large amounts (e.g. spinach, silver beet leaves) it can cause a bitter flavor. Chlorophyll is degraded during the development of most fruits and loss of chlorophyll is often an indicator of ripeness, for example, bananas. Chlorophyll fluorescence techniques have been used to assess quality of broccoli (DeEll and Toivonen, 2000). Loss of fluorescence might be a useful non-destructive method to complement other ripening indicators and has been demonstrated for guava (Bron *et al.*, 2005) and papaya (Bron *et al.*, 2004), where it was probably due both to membrane damage as well as chlorophyll degradation.

Chlorophyll is also degraded by heat and acid forming pheophytin, which results in a change of color to an olive green. Chlorophyll may also be degraded enzymatically by chlorophyllase, which cleaves the phytol group forming chlorophyllide. Action of the enzyme together with heat and acid causing loss of magnesium can result in formation of pheophorbide, resulting in a gray-green colored material.

Carotenoids range in color and include  $\beta$ -carotene (orange), lycopene (red), and xanthophylls (yellow). Carotenoids are fat-soluble pigments and are found in plastids of cells where they are frequently masked by chlorophyll. Carotenoids function as accessories to chlorophyll in the capture of light energy and have antioxidant capacity within the cell in the prevention of damage from free radicals. Their fat-solubility derives from long carbon side chains, and enables them to partition into the fatty regions of membranes but also makes them susceptible to oxidation.  $\beta$ -Carotene is a vitamin A precursor and is very sensitive to oxidation, especially in the presence of sulfites (Wedzicha and Lamikanra, 1983). The carotenoid composition of fruits may be associated with the aroma profile of fruit. Carotenoids can degrade through a number of complex pathways, giving rise to volatile aroma compounds (Lewinsohn *et al.*, 2005a,b). One example is lycopene in tomatoes and watermelon, which on degradation appears to give rise to terpenoid aromas, including the lemon aroma of geranial found in these fruits (Lewinsohn *et al.*, 2005b). Under some storage conditions the carotenoid content of some fruit may increase (Kalt, 2005).

Anthocyanins are water-soluble pigments located in plastids and found in a broad group of plants. They are responsible for the blue, purple, red, and orange colors of many fruits and vegetables (e.g. strawberries, blueberries, cherries, plums, grapes, and red cabbage). Anthocyanins belong to a class of compounds called flavonoids, and have structures derived from the 2-phenylbenzopyrylium (flavylium) salt. Anthocyanins exist as glycosides of polyhydroxy, and/or methoxy derivatives of the flavylium salt. The color intensity of anthocyanin pigments is strongly dependent on pH. At pH 1.0, anthocyanins exist in the red-colored flavylium form, and absorb light strongly at wavelengths around 510 nm ( $\lambda$ -max varies slightly with solvent and pH). At pH 4.5, the colorless carbinol pseudo-base is the dominant structural form. Thus, the color intensity of a solution containing anthocyanin pigments decreases sharply as the pH is increased from 1 to 5. The process may be reversed by acidification. The type and their function may be varied, depending on the organ of origin (Stintzing and Carle, 2004). Red anthocyanins can react with metal ions causing loss of color (Wehrer *et al.*, 1984) requiring the use of coating on cans. The color of flavonoids is inclined to deepen if the material is cooked at alkaline pH, for example, cooked apples.

Betalains are red and water soluble pigments found in 13 families of the order Caryophyllales, which includes beetroot, where they replace the anthocyanins (Stintzing and Carle, 2004). As they are found in different organs of the plant, they

may have multiple functions, including pathogen resistance, animal deterrence, and osmolysis (Stintzing and Carle, 2004). Betalains are less susceptible to degradation from processing than carotenoids (Tesoriere *et al.*, 2005) and generally maintain their color characteristics between pH 3 and 7 (Jackman and Smith, 1996), although some degradation from light, enzymes, and temperature may be experienced, depending on the type and particularly for extracted betalains (Stintzing and Carle, 2004 and references therein). The antioxidant capacity of betalains is variable and dependent on structure but the physiological role of betalains in humans is not well understood (Stintzing and Carle, 2004).

### **2.3.8 Amino Acids**

Fruits and vegetables are not considered to be important sources of protein as they usually contain less than 1% by weight of the raw material. However, proteins from legumes, seeds, nuts, and grains are likely to contain a higher level of protein and a greater range of amino acids, although they may not contain all the essential amino acids. Legumes are generally rich in the essential amino acids isoleucine and lysine, whereas cereal grains usually contain more methionine and tryptophan and are deficient in the other essential amino acids. Small amounts of amino acids are present in fruits, for example, apples contain asparagine and aspartic acid. In processing of foods, free amino acids can participate in fermentation as nutrients for yeast and in the Maillard reaction.

### **2.3.9 Proteins**

These include nuclear and cytoplasmic structures, such as mRNAs synthesized during ripening and enzymes and structural proteins. Enzymes of interest in processing include the polyphenol oxidases, peroxidase, and invertase. The action of these can sometimes be overwhelming and difficult to control, because of extensive loss of compartmentation through crushing of tissues and unchecked mixing of the enzymes with substrates. This results in changes in color and flavor, and with invertase causes degradation of sucrose to fructose and glucose. A number of plant proteases exist that have pharmaceutical uses as well as use in the food industry, primarily as meat tenderizers (e.g. bromelase (pineapple), papain (papaya), actinidin (kiwifruit), and ficin (figs)).

### **2.3.10 Vitamins**

Vitamin C or ascorbic acid is widespread in fruits and vegetables but the amount in each species and cultivar is highly variable (Kalt, 2005). For example, citrus, raspberries, and strawberries all contain large amounts of vitamin C but in strawberries the amount ranged from 32–99 mg/100 g fresh weight (Maas *et al.*, 1995). Wide variation also occurs among apple cultivars (Lachman *et al.*, 2000). Leafy green vegetables, including spinach and related species, contain large amounts of vitamin C. Large

amounts are also present in members of the Cruciferae (e.g. broccoli) and some other less well-known species (e.g. *Lepidium oleraceum* (Cook's scurvy grass) and *Cochlearia officinalis* (scurvy grass)), which were used in historic sea voyages to prevent scurvy. Vitamin C is very susceptible to degradation by heat during blanching and processing and its water solubility means it can be easily lost into the processing water (Kalt, 2005). Vitamin C content also diminishes on storage of fresh vegetables.

### 2.3.11 Minerals

Fruits and vegetables are good sources of minerals, especially K, Mg, P, and calcium. Most fruits and vegetables are rich in potassium, in particular avocado, kiwifruit, banana, plums, prunes, broccoli, pumpkin, and potato, and button mushrooms are known to contain the highest levels of potassium ranging from 350–490 mg/100 g of edible portion (Cunningham *et al.*, 2002). These same fruits and vegetables are also rich in magnesium. When there is not enough fluid in the human body, an electrolyte imbalance occurs resulting in too much or too little of one or more electrolytes in the body. The typical western diet contains plenty of sodium but foods rich in potassium and magnesium (found in fruits, vegetables, legumes, and nuts) are often not eaten in sufficient quantities. Therefore for a healthy diet, consumption of fruits and vegetables is very important.

### 2.3.12 Fat

Some fruits are rich sources of oil. For example, palm, olive, and avocado may contain as much as 15–25% oil. African pear (*Dacryodes edulis*) pulp contains about 63% oil and is rich in palmitic, oleic, and linoleic acids (Kapseu and Tchiegang, 1996). Fat is enclosed in elaeoplasts and is present in large amounts in these fruits and some seeds as well as the germ of cereal grains. In general, the variations in fat and fatty acid composition during maturation of fruits are useful to understand the source of flavor of fruits when ripened (Ayaz and Kadioglu, 2000).

### 2.3.13 Other Components

Glucosinolates, which are found in varying types, amounts, and in different parts of cruciferous vegetables (e.g. broccoli, turnips, Pak choi, Chinese broccoli) may have some cancer protecting activities (Schreiner 2005 and references therein). Other important component are phytosterols, for example,  $\beta$ -sitosterol, which can lead to a lowering of serum cholesterol (Gylling and Miettinen, 2005). Several compounds extracted from plants, such as carrots (Babic *et al.*, 1994), garlic (Benkeblia, 2004), and chili (Leuschner and Ielsch, 2003), have been shown to have some antibacterial and antimicrobial activity, which may find future application, such as in coatings.

## 2.4 Structural Features

Plant cells are bounded by cell wall external to the plasma membrane and contain a large central vacuole, plastids, including chloroplasts, chromoplasts, leucoplasts (amyloplasts, elaioplasts), and other inclusions, including crystals and raphides composed of calcium oxalate, as well as the important organelles such as the nucleus, Golgi apparatus, and endoplasmic reticulum.

The plant foods we eat usually consist of mainly parenchyma tissue together with small amounts of tissues such as collenchyma in celery (Sturcova *et al.*, 2004) and sclerenchyma fibers in asparagus (Waldron and Selvendran, 1990). The cells of parenchyma have thin primary cell walls comprising complex polysaccharides, including cellulose microfibrils, pectic polysaccharides, and xyloglucans, with smaller amounts of heteroxylans, glucomannans, proteins, and glycoproteins (Bacic *et al.*, 1988). Cell wall polysaccharides exhibit microheterogeneity in their composition, which changes in response to the changing needs of the organ. Polysaccharides are held together in the walls by a mixture of covalent bonds, non-covalent (interaction between calcium and pectin), and hydrogen bonds to form a 3-D network.

Cell walls are strong. They provide structural support for the plant tissue and resist the turgor pressure of cells. Cell walls are also a major component of dietary fiber and together with turgor, contribute texture to food. Thus the structure of an organ arises from contributions from the molecular organization of the cell walls, the size and arrangement of cells in a tissue to fit the overall biological purpose, and development of an organ (Waldron *et al.*, 1997b). Control of the cell wall is poorly understood but the concept of a continuum involving the nucleus, the cytoskeleton, wall-associated proteins, and other components is favored (Baskin, 2001; Wyatt and Carpita, 1993).

## 3. BIOLOGICAL DETERIORATION AND CONTROL

Fruit undergo complex changes during development in response to their inherent genetic composition, controlling production of growth regulators, such as ethylene, enzymes, together with environmental influences. Changes include loss of chlorophyll, formation of colored pigments, tissue softening, and changes in composition. “Fully ripe” is thus a point in development at which time the fruit is considered to be suitable for eating. At some point in development, senescence begins and the fruit abscises from the plant in readiness for release of seeds.

Climacteric fruit show a peak in respiration and a burst in ethylene with ripening. In contrast, non-climacteric fruit continue to respire at the same rate and ethylene production does not increase. Tomato (a climacteric fruit) (Giovannoni, 2004) and strawberry (non-climacteric fruit) (Manning, 1998) have both been used extensively to study ripening, but the genetic determinants of climacteric and non-climacteric are

not well understood and closely related species, such as melon, may be climacteric or non-climacteric (Giovannoni, 2004).

Consideration of biology is also helpful in managing other non-fruit crops. Leafy vegetables and root vegetables have different biological purposes and therefore different care in handling and storage is required compared with that of fruit. However, leafy vegetables are highly perishable as their biological purpose is rapid vegetative growth and photosynthesis.

In any fully hydrated tissue the vacuole is enlarged and the cytoplasmic contents, held by membrane, are pushed against the cell wall. When vegetables are harvested they are cut off from their water supply and are susceptible to dehydration and often wilt, which may be exacerbated by increased respiration and transpiration as a result of wounding stress. Most of the cell's water is held in large vacuoles together with sugars, pigments, acids, vitamins, and minerals.

Cooking and freezing damage the membranes and cell walls of cells causing a loss of cellular integrity. Osmotic pressure cannot be maintained and tissues become soft and wilted. Vegetables, such as cauliflower and broccoli, are flowering stems and require strategies to prevent full development of the flower, which would lead to a decline in consumer acceptance and loss of crop value. Precise timing of harvest as well as treatments, such as the application of crushed ice to broccoli heads, is required to prevent the flowers maturing.

Softening of the tissues also characterizes ripening. The most worrying aspects of fruit becoming softer is their increased susceptibility to physical damage from handling, pathogenic invasion, and crush injury from inappropriate packaging and storage, all of which shorten shelf-life. Softening is also due in part to changes in cell turgor associated with changes in solute concentration and metabolism of starch. Softening represents considerable changes in the chemistry of the components as well as the molecular architecture of the plant cell walls. Polysaccharides that are affected the most are the pectic polysaccharides and to some extent xyloglucans. Most fruits and vegetables have a cell wall polysaccharide composition that at first seems broadly similar.

Fruits and vegetables have compositions, which contain cellulose together with pectic polysaccharides and xyloglucans as their major polysaccharides. Examples in this group include most of the plant foods we eat (e.g. potatoes, taro, beans, peaches, mangoes, melons, and apples).

Pineapple fruit is an exception to the above as the cell walls do not contain large amounts of pectic polysaccharides, rather these walls contain mainly cellulose, heteroxylans, and xyloglucans as well as large amounts of ferulic acid ester-linked to heteroxylans (Smith and Harris, 1995, 2001). Vegetables that contain large amounts of ferulic acid include members of the family Caryophyllales (spinach, Chinese water chestnut (Cyperaceae)) but in these cell walls ferulic acid is linked to pectic

polysaccharides (Fry, 1982, 1983; Ishii and Tobita, 1993; Parker *et al.*, 2003; Parr *et al.*, 1996).

Mechanisms for changes among the polysaccharides have not been fully elucidated but are complex and coordinated, reflecting the inherent differences in cell wall composition among species as well as the rate and timing of softening, which also differ among species from temperate and tropical origins (Alexander and Grierson, 2002; Ali *et al.*, 2004; Brummell and Harpster, 2001; Cosgrove, 2000; Giovannoni, 2004). However, such is the complexity of the pectic polysaccharides and their interactions with other polymers that a full understanding is ongoing (Knox and Seymour, 2002; Voragen *et al.*, 2003), together with that of the complex compositional changes that occur during development, ripening, and storage (Ratnayake *et al.*, 2003; Wakabayashi, 2000) and as a result of enzymic action (Knox and Seymour, 2002; Voragen *et al.*, 2003).

The activities of the various enzymes and components that result in fruit softening seem to have most affect at the region of the middle lamella causing cell separation (Redgwell *et al.*, 1997a) and swelling of the wall (Redgwell *et al.*, 1997b). However, dissolution of the middle lamella may be limited in regions of the wall that are rich in calcium (Roy *et al.*, 1992).

Cooking softens tissues and causes solubilization of pectic polysaccharides from the cell walls (Ng and Waldron, 1997; Quach *et al.*, 2001). In tissues which contain starch, for example, potatoes, further pressure is placed on walls from swelling of the starch granules during gelatinization (Binner *et al.*, 2000). The incorporation of a pre-cooking step at temperatures below 100°C during processing may also activate pectin methyl esterases and cause a reduction in the extent of methyl esterification, allowing calcium complexes of galacturonans to form instead (Jarvis *et al.*, 2003). Further, specific cultivars may be more or less susceptible to cell separations, depending on their composition and processing conditions (Jarvis *et al.*, 2003).

Mealiness is a textural attribute and associated with cell separation. Processing fruits with mealy flesh causes problems when crushing fruit for juicing, as the cells are difficult to disrupt and contents are not released. Chilling injury can also disrupt normal ripening patterns and cell wall changes, resulting in mealiness of the fruit, for example, peaches (Brummell *et al.*, 2004).

Other components which appear to have a role in softening include the expansins, which are a group of proteins that cause changes in extensibility of plant cell walls (Kende *et al.*, 2004; Li *et al.*, 2003; McQueen-Mason *et al.*, 1992), including softening of tomato fruits (Brummell and Harpster, 2001; Kalamaki *et al.*, 2003). Ethylene also appears to have a role in modulation of cell wall changes during ripening (Alexander and Grierson, 2002).

Ethylene production is complex and involves several pathways under the regulation of several genes (Giovannoni, 2001, 2004) but the plant must also be capable of



responding to its influence (Lelievre *et al.*, 1997). The biosynthesis of ethylene in fruit results from the metabolism of methionine through a series of rate limiting steps encoded by multigene families, including the conversion of S-adenosyl-l-methionine to 1-aminocyclopropane-1-carboxylic acid (1-ACC) via ACC synthase (ACS), followed by metabolism of 1-ACC to ethylene by ACC oxidase (ACO) (Kende, 1993). Ripening in tomatoes has been examined and ethylene synthesis or a defect in synthesis does seem to be a factor (Perin *et al.*, 2002).

Fruit also respond to endogenous ethylene and exogenous (applied) ethylene. Wounding increases the rate of endogenous ethylene production and respiration. Wounding caused by harvesting can result in a rapid increase in respiration rate and concomitant increase in ethylene. Ethylene seems to be involved in normal responses in tissues of both climacteric and non-climacteric fruit in a highly complex manner and a number of genes have been identified as being important in this control (Alexander and Grierson, 2002).

## 4. METHODS FOR MINIMIZING DETERIORATION

### 4.1 Physical Methods of Reducing Deterioration

The amount of time in which crops are at the peak of their quality is often short. This means that the time of harvest must be carefully controlled to obtain the highest quality products. Unfortunately, the time of harvest and subsequent quality of product is influenced by factors, such as rainfall and temperature, availability of harvesting equipment and labor force, factory scheduling, and withholding periods associated with spray regimes. Season to season variations, which affect crop maturation, may be compounding factors.

Harvested vegetables are highly perishable and need careful handling and storage conditions to maintain quality. Quality can be lost quickly as a result of wilting from loss of water by evapotranspiration and excision of the plant parts from the roots. Stress on the crop associated with wounding from harvest can cause evolution of heat because of an increase in respiration. This can result in extensive heat damage and increased spoilage from microorganisms.

Cooling of the crop immediately after harvest can delay deterioration by lowering the respiration rate. However, cooling conditions have to be precisely controlled as this in itself can cause damage, especially to membranes of cells, resulting in chilling injury responses.

There may also be a loss of sweetness because of metabolism of sugars, conversion of sugar to starch, and formation of fibrous tissue. Some vegetables have undergone rapid growth just before harvest. These are highly perishable and have a limited shelf-life (e.g. asparagus, cauliflower, broccoli, lettuce). Fruits often undergo rapid respiration and metabolism limiting their shelf-life (e.g. capsicums, tomatoes, cucumbers,

squash). Storage organs often go through dormancy but may start to metabolize starch and form shoots during storage, thus limiting the storage life (e.g. onions, carrots, potatoes, beetroot).

Careless handling of harvested material can result in wounding and introduces pathogens and causes post-harvest decay. Leaves, stems, and flowers are rapidly growing organs and are often not well protected by a cuticle or thick epidermal layers as found in fruits. Therefore, there is little protection against water loss and fungal infection. The decline in quality induced by harvesting procedures can be mitigated through attention to post-harvest conditions. Lowering the temperature of the storage room and being able to transfer crops as rapidly as possible to such storage is important and will help to delay death. Moreover, the closer the cool storage facilities are to point of harvest the better.

Cool storage will also help reduce water loss as a result of a reduction in evaporation and transpiration, but control of relative humidity is also necessary. A moist atmosphere close to the surface helps reduce evaporation but care must be taken to prevent condensation of moisture onto the plant material, which would encourage microbial growth. In conjunction with lowering of temperature and maintaining a relatively high humidity, it may be desirable to modify and control the atmosphere by reducing the oxygen and increasing the carbon dioxide to predetermined levels specific for the crop. It is critical that precise conditions are developed and maintained for each crop, to minimize losses from inappropriate conditions.

A number of injuries and biochemical changes can result from inappropriate storage conditions of both temperature and gases and in fruit may not be detected until the fruit is cut open if the injury is internal. Some treatments can help, such as diphenylamine to prevent superficial scald in apples.

Mechanical injury from picking (fingernails), dropping into bags and bins (bruises), abrasions from poorly maintained bins, and compression injuries from overloading bins, should be minimized. Injuries allow pathogen invasions especially fungi, and fungi grow well in confined spaces where humidity is high.

Many fruit can be stored at temperatures just above the temperature at which the tissues will freeze. The freezing point is dependent on the soluble solids (mainly sugar) content. The higher the solids content the lower the freezing point. However, most fruit will freeze at or below  $-1^{\circ}\text{C}$ . For practical purposes storage temperatures are usually above zero. Storage temperature is defined by research for each variety of fruit. Storage below the optimum for a species or cultivar will cause chill injury. Chill injury is often not visible from the exterior of the fruit. Tropical fruit must be kept at much higher temperatures to prevent chill injury, for example, bananas at  $14^{\circ}\text{C}$ .

Storage life can be increased by changing the atmosphere of the store from the normal atmosphere ratios of 79% nitrogen, 21% oxygen, and 0.03% carbon dioxide to predetermined concentrations in which the level of oxygen is reduced and carbon

dioxide is increased. This is known as controlled atmosphere storage and must be carefully determined for each species and cultivar. This technique also involves lowering the temperature of the storage room together with high relative humidity.

## 4.2 Methods for Preserving Fresh Fruit and Vegetables

### 4.2.1 Modified Atmosphere

A modified atmosphere involves changing the normal mix of oxygen/nitrogen/carbon dioxide found in air to something else. This usually means a reduction in oxygen to less than 5% and increase in carbon dioxide as determined by research for a product together with low temperature storage. The objective of modified atmosphere is to slow the rate of respiration in the tissues and thereby slow the metabolic rate and slow down the degradative processes. This involves some sort of packaging, either a film coat, sealable bag, or an edible coating. Back flushing of bags may be useful for extending the shelf-life of minimally processed fruits and vegetables because of the short handling period. The atmosphere may slowly change during storage because of continued respiration and permeability of packaging. Edible coatings can provide a barrier to pathogens, reduce moisture loss, act as a carrier for antioxidants, and create a modified atmosphere around a product.

### 4.2.2 Disinfestation Treatments

The most common means of post-harvest disinfestation has been methyl bromide (MeBr), which has been used for fumigating fresh produce for over 70 years (Taylor, 1994). MeBr is an excellent fumigant with efficacy against a wide range of pests such as insects, nematodes, weeds and soilborne pathogens including fungi, virus, and bacteria (Taylor, 1994).

However, MeBr has significant ozone-depleting properties and therefore, industrialized countries that were assignees to the Montreal protocol, have been slowly and consistently phasing out its use since 1 January 2005 (Gullino *et al.*, 2005; Taylor, 1994). In addition to this restriction, the cost of using MeBr as a fumigant has also increased (Wang *et al.*, 2006).

Metabolic-stress disinfection and disinfestation (MSDD) is an alternative to MeBr disinfestation technology that utilizes the combination of pressure change, hypercarbia, hypoxia, and ethanol treatments. The insecticidal efficacy of MSDD against various insect pests; longtailed mealybug (*Pseudococcus longispinus*), 5th instar light brown apple moth (LBAM) larvae (*Epiphyas postvittana*) and 5th instar codling moth larvae (*Cydia pomonella*) has been studied by Lagunas-Solar *et al.* (2006) and Zuhlendri *et al.* (2012a,b). MSDD consists of two phases, namely a physical phase and a chemical phase. The physical phase is characterized by cycles of pressure changes (90–110 kPa) carried out by drawing air from the treatment chamber and replacing it with ballast gases (CO<sub>2</sub> or N<sub>2</sub>). The physical phase usually lasts for 30 min. At the end of the

physical phase, the chemical phase is initiated by drawing the pressure down to 10 kPa and ethanol is introduced into the chamber (held for 60 min). This 90 min MSDD treatment protocol was shown to be effective in controlling surface pests.

Microorganisms can easily be transferred into a processing unit from contaminated raw products. If there is no sterilization step from heat, then live organisms may be present in any fresh-cut foods. Fresh-cuts are generally rinsed in 50–200 ppm chlorine solution but the wash does not eliminate all microorganisms (Torriani and Massa, 1994; Watada *et al.*, 1996). The advantage of chlorine is that it is cheap but the chlorine concentration must be monitored to ensure efficacy.

Hydrogen peroxide and hydrogen peroxide vapor have been considered as sterilizing agents for raw material and packaging (Sapers and Simmons, 1998; Sapers *et al.*, 1999, 2000; Ukuku *et al.*, 2004) or in combination with other treatments such as nisin (Ukuku *et al.*, 2005), but bacteria often form a close association with the surface of the produce and are difficult to destroy (Sapers *et al.*, 2003).

Mild heat treatment can be considered but this may affect the respiration rate and subsequently accelerate degradation or cause formation of phenolic components. However, changes in mango composition were shown to be associated with subsequent low temperature storage rather than the heat treatment (Talcott *et al.*, 2005).

Ultraviolet light is sometimes used as an alternative to chemical treatments to reduce microbial load on fresh-cut pieces. Respiration rate and lipase activity may be reduced, leading to an overall improvement in shelf-life. However, the treatment may induce unwanted reactions as well, including stimulation of plant defense mechanisms (Lamikanra *et al.*, 2005).

Irradiation may be useful for pest control, but the cost of plant set-up and regulatory aspects of respective countries may limit its use. Other treatments that may prove to be useful in the future involve the use of antimicrobial components already found in some plant materials. For example, carrot has been shown to have some antilisterial capacity (Babic *et al.*, 1994). However, identification of the efficacious compounds has proved difficult.

Combining methods to enhance preservation and minimize infection may be desirable in some instances and UV light is one technique that could be considered. However, changes in endogenous compounds of the plant material may occur together with lowering of microbial load (Lamikanra *et al.*, 2005).

## 5. GENERAL METHODS OF FRUIT AND VEGETABLE PRESERVATION

### 5.1 Storage of Fresh Produce

In most developed countries, extension of shelf-life of fresh produce is carried out to overcome the seasonal nature of most fruits, by controlled atmosphere and modified atmosphere-packaging techniques. However, some fruits and vegetables do not store

well for long periods of time under these conditions. Therefore, the most common methods of processing of some of these products are drying, freezing, pickling, fermentation, juicing, preserves, canning, and many other preservation techniques, including minimal processing. These processes will be discussed in greater detail in the ensuing sections.

## 5.2 Preservation by Manipulation of Water Activity

This is probably one of the oldest methods of processing of horticultural crops. Most of the grains, legumes, and oil-seeds are processed by this method, in which the water is removed from the product to almost equilibrium moisture content, when the products seem to have the longest shelf-life. At low water activity levels of below 0.65, all microbiological and most chemical and oxidative deterioration reactions will be inhibited, giving the dehydrate products their stability (Rahman and Labuza, 1999).

## 5.3 Chemical Preservation

Most of the deteriorative reactions in food are brought about by microbiological, chemical, and oxidative reactions. Chemicals added to food that prevent or retard the deterioration of the food are known as preservatives. Chemical preservatives, such as those acting on microorganisms to inhibit their growth or reduce their numbers and those acting as antioxidants to reduce oxidative degradation, act as good preservatives to extend the shelf-life of horticultural products. The most commonly used chemical preservatives are sulfur dioxide or sulfites, and some organic acids such as benzoic acid, sorbic acid and their salts, and p-hydroxybenzoic acid esters, known as parabens.

### 5.3.1 Sulfur Dioxide ( $SO_2$ )

Sulfur dioxide is a gas and is not convenient to handle in most food applications (Gould and Russell, 2003). However, the most commonly used form in food preservation is as sulfites, mainly as sodium or potassium meta-bisulfite ( $Na_2S_2O_5$ ). Other useful  $SO_2$  generating compounds are sodium sulfite ( $Na_2SO_3$ ) and sodium hydrogen sulfite ( $NaHSO_3$ ).  $SO_2$  is a powerful antioxidant and readily undergoes oxidation, thereby protecting other important chemicals such as vitamin C (ascorbic acid), vitamin A, and pro-vitamin A in food from undergoing oxidation. However, the water-soluble vitamin thiamine is totally destroyed by sulfites. Dried fruits may contain a maximum of 2,000 ppm  $SO_2$ . The most effective pH range for  $SO_2$  is 2.5–5.0. Sulfur dioxide has the added advantage of acting as an antibrowning agent in both enzymatic and non-enzymatic reactions. It is also active against insect pests such as weevils.

### 5.3.2 Benzoates

Benzoate was first used as a food preservative in the 1900s. Solubility of benzoic acid is only 2.9 g/l of water at 20°C. However, the salt, sodium, and potassium benzoates have a solubility of 556/l of water at 20°C. It occurs naturally in cranberries, prunes, plums, cinnamon, and cloves. Many microorganisms may acquire resistance to benzoate, for example, *Saccharomyces bailii*. It has a pKa of 4.19 and its normal use level in food is at 0.1% or less. The most effective pH range is 2.5–4.5 (Stratford and Eklund, 2003).

### 5.3.3 Sorbates

Sorbates were isolated from rowanberries and first used in foods in the 1940s (Larsen *et al.*, 2003). Sorbic acid has a pKa value of 4.75, and solubility is 0.16 g/100 ml at 20°C. However, potassium sorbate has a solubility of 58.20 g/100 ml at 20°C. It is used primarily to control yeasts and molds at concentrations of 0.05–0.3%. They are most effective at a pH range of 3.0–4.5.

### 5.3.4 Parabens

Parabens were first used in foods in the 1920s. They include a group of methyl, ethyl, and propyl esters of p-hydroxybenzoic acid (Larsen *et al.*, 2003). Solubility of methyl ester is 0.25 g/100 ml water at 25°C, whereas ethyl ester is 0.11 g/100 ml water at 25°C, and propyl ester is 0.05 g/100 ml water at 25°C. They are effective at pH values between 3 and 9 and are considered GRAS at levels of 0.1%. They are normally used in combinations of methyl and propyl esters in the ratio of 2:1. Disadvantages are high cost and a numbing sensation in the mouth.

## 5.4 Preservation by Acidification

Preservation can also be brought about by fermentation whereby lactic acid produced by the fermenting bacteria (usually lactic acid bacteria), would inhibit the growth of other microorganisms, leading to preservation. Sauerkraut, “kimchi”, and pickled gherkins are some examples of lactic acid fermented products. By definition, sauerkraut is “acidic cabbage”. It is the result of a natural fermentation by bacteria indigenous to cabbage in the presence of 2–3% salt. The fermentation yields lactic acid as the major product. This lactic acid, along with other minor products of fermentation, gives sauerkraut its characteristic flavor and texture. Kimchi, the Korean fermented cabbage, includes a number of other vegetables and condiments such as chili powder to give it a characteristic flavor, but it is basically sauerkraut.

In production of sauerkraut, mature cabbage heads are washed and shredded (Dauthy, 1995). The salt is mixed with the shredded cabbage to a final concentration of about 2.5%. The salted cabbage is then tightly packed into a jar or crock. The cabbage is protected from air (oxygen) in a manner that will permit gases produced

during the fermentation to escape. A temperature of about 21°C is preferred for the fermentation. The fermentation is complete within about 2–3 weeks.

The salting of the cabbage serves two major purposes. First, it causes an osmotic imbalance, which results in the release of water and nutrients from the cabbage leaves. The fluid expelled is an excellent growth medium for the microorganisms involved in the fermentation. It is rich in sugar and growth factors. Second, the salt concentration used inhibits the growth of many spoilage organisms and pathogens. It does not, obviously, inhibit the desired floral succession. Even distribution of the salt is critical. Pockets of high or low salt would result in spoilage and/or lack of the desired fermentation. Throughout the fermentation, it is critical that oxygen be excluded. The presence of oxygen would permit the growth of some spoilage organisms, particularly acid-loving molds and yeasts.

As no starter cultures are added to the system, this is referred to as a wild fermentation (John, 1998). The normal flora of the cabbage leaves is relied on to include the organisms responsible for a desirable fermentation, one that will enhance preservation and organoleptic acceptability. The floral succession is governed mainly by the pH of the growth medium. Initially, coliforms start the fermentation. Coliforms, which have contributed to lab-made sauerkraut include, *Klebsiella pneumoniae*, *K. oxytoca*, and *Enterobacter cloacae*. As acid is produced, an environment more favorable for *Leuconostoc* is quickly formed. The coliform population declines as the population of a strain of *Leuconostoc* builds. As *Leuconostoc* is a heterofermentative lactic acid bacterium, much gas (carbon dioxide) accompanies acid production during this stage. The pH continues to drop, and a strain of *Lactobacillus* succeeds the *Leuconostoc*. Occasionally, a strain of *Pediococcus* arises instead of *Lactobacillus*. The complete fermentation then involves a succession of three major groups or genera of bacteria, a succession governed by the decreasing pH.

Pickling is an age-old process for preservation of fruits and vegetables. Vegetables, especially cucumber (gherkin) are brined and allowed to ferment over a long period of time before they are prepared for retail (Raab, 2000). In preservation of cucumbers for brining, the fermentable sugars preferably should be utilized primarily by homo-fermentative lactic acid bacteria with the exclusion of microorganisms, which cause quality defects in the product. However, in practice, heterogeneous microbial activity leads to a wide variation of product quality as a result of spoilage and deterioration of the brined stock.

Quality defects of brined cucumbers are:

- Bloaters (formation of international cavities as a result of excessive gas formation).
- Flat, shriveled, and distorted stock (as a result of gas pressure).
- Loss of texture and firmness.
- External and internal bleaching and off-color.
- Unclean or offensive odor and taste.

The brining treatments, environmental conditions, and initial microbial population are primary factors that will affect the microbial activity. Brining is usually done

in wooden tanks or barrels. The raw material should be thoroughly washed in chlorinated water in washing tanks with the help of scrubbers or brushes to remove surface soil, dirt, and other foreign matter. This step also helps to reduce the initial microbial load of the product. More recently “Aqua Plus”, a food approved sanitizing agent, has been used (Han *et al.*, 2000). The active ingredient of Aqua Plus is chlorine dioxide, which is a powerful oxidizing agent, but does not have the same adverse effects as chlorine (chlorine can form chloramines with organic matter, some known to be carcinogenic), which is normally used as a sanitizer for washing/cleaning purposes.

The washed cucumbers are immersed in a brine solution of a suitable concentration. The salt level in the brine should be checked from time to time as it may be diluted by the moisture content of the cucumbers due to osmosis. Usually 20–30° Salometer range (5–8% NaCl content) is used for brining. A Salometer reading of 100° corresponds to a salt concentration of 26.4% at 15.5°C. During brining lactic acid fermentation will occur, giving rise to an increase in titratable acidity and consequent decrease in pH. It has been found that low brine content will produce high lactic acid content.

Microorganisms that cause fermentation come chiefly from the cucumbers and any adhering soil particles. They consist of various groups of bacteria, yeasts, and molds. Their numbers and proportions can vary, depending on the washing techniques as well as storage and handling practices used. In general, the bacterial groups found in pickle brines would include, aerobe, anaerobes, coliforms, and acid formers.

At low salt concentrations, coliform bacteria will become established; however, at high salt concentrations the halophilic species of the genus *Aerobacter* may actively become established, especially if the lactic acid bacteria have not been established by then. Although lactic acid bacteria are initially present in low numbers, after initial coliforma, fermentation sets the stage for the lactic acid bacteria to grow. The most common lactic acid bacteria found in cucumber fermentation are *Lactobacillus plantarum* and *Pediococcus cerevisiae*.

The two groups of yeasts active in natural cucumber fermentation are the sub-surface type and the film types found on the surface. The sub-surface fermentative yeasts will utilize sugars from within the cucumber and produce CO<sub>2</sub> gas, leading to a serious defect called “bloaters”. They form hollow centers in cucumbers and float to the surface. The principle species of sub-surface yeasts are:

- *Brettanomyces versatilis*.
- *Hansenula subpelliculosa*.
- *Torulopsis caroliniana*.

However, other film-forming yeasts oxidize the lactic acid causing a rise in the pH, and also may support the growth of molds. The principle surface growing yeasts are:

- *Debromyces membranaefaciens*.
- *Zygosaccharomyces halomembranis*.



Mould contamination of pickles during brining would lead to softening of the pickled cucumbers due to the activity of pectinase and cellulase enzymes. Thus, if this defect is to be controlled the action of these enzymes should be controlled. This can be done by the use of certain plant extracts. One of the most effective inhibitors of these two groups of enzymes is an extract obtained from the noxious weed crop *Sericea lespedeza*.

Usually a small amount of lime (CaO) is added to the brine to improve the firmness of the finished products. The chemical reactions taking place in the firming of the cucumber tissue occur as a result of formation of calcium bridges between pectin molecules as shown in Figure 11.1.

Vinegar pickles are another form of products preserved by acidification, where usually vinegar is used as the preserving agent.

## 5.5 Preservation with Sugar

Fruit and vegetable candy, jams, jellies, and preserves are another category of products where sugar is used as a preservative agent. The products are usually cooked with sugar to a high Brix value to bring about the preservative action of sugar. In jams, jellies, and preserves, sugar is present at over 65% as a concentrated solution, which prevents microbial growth as a result of removal of water from microbial cells by osmosis.

## 5.6 Preservation by Heat

Addition and removal of heat are useful methods of preservation of food. These include blanching, pasteurization, and sterilization, where the products are heated to different degrees to bring about preservation, or refrigeration and freezing, where heat is removed from the product to different degrees to bring about preservation. These methods are commonly used in large-scale processing of horticultural crops. Proteins found in microorganisms are denatured during heating, which brings about the destruction of microorganisms, resulting in the stability of the products. The denaturation of proteins, and thus the destruction of the microorganisms are brought about to different degrees at different

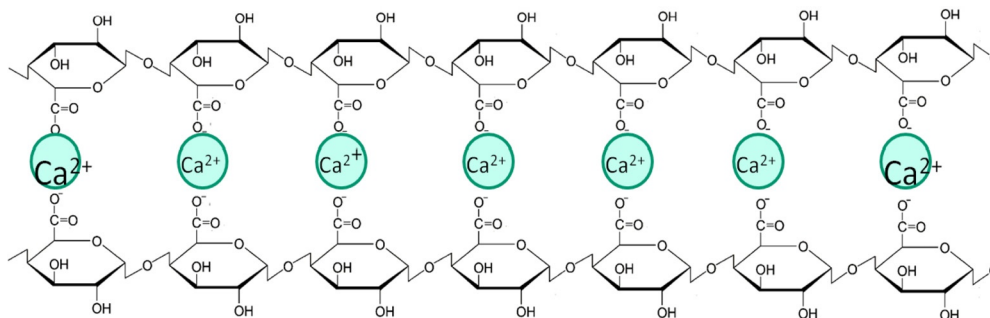


Figure 11.1 Formation of calcium bridges between pectate molecules and calcium ions.

degrees of heating. Whereas some products require only pasteurization to destroy human pathogens, others will require sterilization at very high temperatures (121°C) to destroy more heat resistant bacteria, such as *Clostridium botulinum*.

However, removal of heat from food products by refrigeration brings about preservation by retarding the rate of growth of the microorganisms. Thus, refrigerated foods could be stored for a relatively longer period of time than non-refrigerated foods left at room temperature. In the case of freezing, the conversion of free moisture to ice depletes the microorganisms of water required for their growth, and food products are preserved for much longer periods of time compared to refrigerated food products.

## 5.7 Food Irradiation

Food irradiation is a process whereby the food is briefly exposed to a radiant energy source such as gamma rays or electron beams within a shielded facility. Irradiation is not a substitute for proper food manufacturing and handling procedures, but the process, especially when used to treat meat and poultry products, can kill harmful bacteria, greatly reducing potential hazards.

The Food and Drug Administration has approved irradiation of fresh fruits and vegetables as a phytosanitary treatment ([Code of Federal Register, 2002](#)). The agency determined that the process is safe and effective in providing protection against fruit flies and the mango seed weevil. Irradiation also reduces spoilage bacteria, insects, and parasites, and in certain fruits and vegetables it inhibits sprouting and delays ripening. For example, irradiated strawberries stay unspoiled for up to 3 weeks, versus 3–5 days for untreated berries.

A dose of irradiation is the quantity of radiation energy absorbed by food as it passes through the radiation field during processing. Dose is generally measured in Grays (G) or kiloGrays (kGy), where 1 Gray = 0.001 kGy = 1 joule of energy absorbed per kilogram of food irradiated. Dose can also be measured in Rads (100 Rads = 1 Gray).

Insect pests and some parasites (*Cyclospora*, *Cryptosporidium*, etc.) have a relatively large amount of water and DNA in their cells, and so are easily killed by irradiation.

D-values for gamma irradiation of 0.1 kGy are typical. Thus, a dosage of 0.5 kGy would give a 5-log reduction. Bacteria (*E. coli*, *Salmonella*, *Listeria*, etc.) have smaller DNA and so are more resistant to irradiation. D-values of 0.3–0.7 kGy are typical, depending on the bacterium. Thus, it would require 1.5–3.5 kGy to achieve a 5-log reduction of bacteria. At this time, the maximum allowable dosage for treating fruits and vegetables is 1.0 kGy.

Different dosages are used to produce different effects in foods. Some of these include:

- Extension of shelf-life of fresh fruits (0.5–1.5 kGy).
- Delay of ripening (0.5–2.0 kGy).

- Inhibition of sprouting (0.05–0.15 kGy).
- Control of insects, parasites and micro-organisms (0.15–1.0 kGy).
- Control of bacteria in fresh meat and poultry (1.5–4.5 kGy).

Food irradiation is allowed in nearly 40 countries and is endorsed by the World Health Organization, the American Medical Association, and many other organizations ([Food Irradiation Information website, 2011](#)).

## 6. SOME IMPORTANT METHODS OF PROCESSING OF FRUITS AND VEGETABLES

### 6.1 Canning

Canning is an important method of preservation of food in general, and fruits and vegetables in particular, because of the extension of shelf-life it lends to products. It involves a heating process much more severe than blanching or pasteurization. The process is designed to destroy all microorganisms, including their spores. This process also requires an airtight container in which to store the product, which will prevent the entry of microorganisms to re-contaminate the food. The product may be processed inside a container such as in a can, pouch, or bottle, or packed in a sterile environment immediately following processing.

Temperatures required for sterilization depend on the pH of the food. As the aim in food processing is to inactivate the most heat stable pathogen, *Clostridium botulinum*, and it does not grow below a pH of 4.6, we can divide food into two main categories, namely acid and low acid foods.

Acid foods (any food having pH of less than 4.6) require only waterbath temperatures (98–100°C) for sterilization. As most fruits are acidic in nature and those with high pH like papaya, banana, and persimmon, which generally have pH values of over 4.6, are acidified with citric acid to bring the pH level below 4.6 before canning. Thus fruits that have a pH below 4.6 or those acidified to pH below 4.6, require only a boiling water bath temperature for sterilization.

Low acid canned foods, to which most vegetables belong, are regulated by the Code of [Federal Register-21CFR113 \(2001\)](#). These foods have a pH of greater than 4.6 and a water activity of over 0.85. They require a temperature of at least 121°C for sterilization. As water boils at 100°C, this can only be achieved under pressure (steam pressure of 1 atmosphere or absolute pressure of 2 atmospheres). Generally vegetables, with the exception of rhubarb, have a high pH and they need to be sterilized at these high temperatures for commercial sterilization. At such high temperatures, a number of chemical reactions may take place, which affect the color, flavor, texture, and nutritional value of the food. Some of these chemical reactions include:

- Caramelization of sugars.
- Maillard reaction between a reducing sugar and amino acids.

- Breakdown of carbohydrate polymers and proteins.
- Denaturation of proteins.
- Hydrolysis of esters.
- Oxidation of ascorbic acid.

There are two methods of producing sterilized liquid food products:

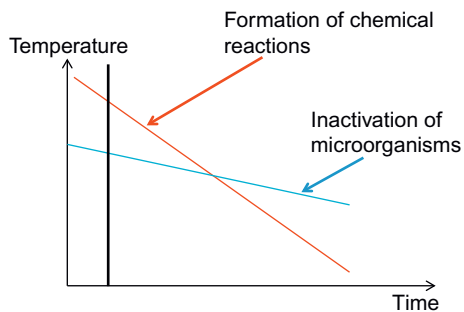
1. In-container process.
2. Continuous flow method.

The in-container process involves filling bottles, cans or pouches with the pre-heated product, hermetically sealing them, and autoclaving at 121°C for a required length of time, depending on the characteristics of the product (viscosity, particle size), size and shape of the container. The product is cooled and stored in a cool dry place.

The continuous flow process involves sterilizing in a pressurized heat exchanger and then filling aseptically into sterile containers and hermetically sealing them. Ultra High Temperature (UHT) Treatment involves heating liquid foods to a very high temperature, usually 135–145°C for a very short time, usually 2–3 s and then aseptically packing into pre-sterilized containers and hermetically sealing them. Such products have several months' shelf-life without refrigeration. The effect of time/temperature on the development of chemical reactions and inactivation of microorganisms is shown by the graph in [Figure 11.2](#).

## 6.2 Dehydration

The produce used for drying are first washed, peeled, or trimmed as required and then cut into appropriate sizes. Apples are usually peeled, cored, and cut into 1 cm cubes or approximately 2 mm slices. They are then dipped in a solution of 1–2% metabisulfite for a short period of time, drained, and then air dried or vacuum dried until a moisture content of about 3–5% is reached. The dried products are cooled in a room maintained at low relative humidity and vacuum packed or packed in pouches



**Figure 11.2** Time/temperature effect on chemical reactions and inactivation of microorganisms.

and nitrogen-flushed to maintain long shelf-life. Apple slices are usually vacuum dried and packed in nitrogen-flushed laminated aluminum pouches and are used as snack products. Dried apple cubes and powders are used as industrial ingredients for further manufacture of bakery products.

The maximum permitted level of sulfur dioxide in dried fruits in the USA and the UK is 2,000 ppm ([Code of Federal Register, 1991](#)). Dried fruits that contain sulfur dioxide are apples, golden apricots, pears, peaches, mango, papaya, pineapple, golden raisins, and crystallized ginger. Dried fruits that generally do not contain any sulfur dioxide are blueberries, cranberries, currants, dates, black mission figs, prunes, and black raisins.

Another method of dehydration is by frying. Usually fried products imbibe 30–40% of the oil in which they are fried. Therefore vacuum frying is used as an effective method of dehydration without the high levels of imbibed frying oil. The usual level of oil uptake in vacuum frying is only about 5–8% of the total weight of the finished product. Apple, banana, kiwifruit, and other fruits, as well as vegetables, have been successfully processed and marketed in South and East Asia using this processing technology.

### 6.3 Freezing

Freezing is an important method of preservation of fruits and vegetables. Most vegetables and some berries are preserved by this method. Freezing vegetables is simple and easy. Freezing costs more than canning or drying, but preserves more nutrients and a fresher flavor if done properly. Freezing does not completely destroy bacteria, molds, and yeasts but does retard their growth. Once food is thawed, microorganisms may continue to grow. Many natural enzymes in vegetables cause changes in flavor, color, texture, and nutritive value. Therefore, most vegetables that undergo freezing are subjected to blanching treatment to inactivate the enzymes that cause some of these deteriorative changes. In addition, blanching destroys the semipermeability of cell membranes, destroys cell turgor, removes intercellular air, filling these spaces with water, and establishes a continuous aqueous phase, as a result of which ice crystallization could occur through the entire matrix of food material without interruption during the freezing process ([Rahman, 1999](#)).

### 6.4 Semi-Processing

Semi-processing is a very valuable option for processing of horticultural crops at the village level and is an important processing technique in developing countries. Semi-processing of horticultural products stabilizes the product for a certain length of time, so that it can be sent to large-scale manufacturers to produce a number of different end products.

Generally, fruits are inspected, washed, pulped, and sulfur dioxide (up to a maximum of about 2,000 ppm) is added as sodium or potassium metabisulfite to stabilize the product (Dauthy, 1995). They are filled into plastic lined drums or food-grade plastic drums, sealed, and transported to central industrial sites for further manufacturing. The high sulfur dioxide levels will usually be reduced to acceptable and permitted levels during the subsequent processing. Adherence to Good Manufacturing Practices (GMP) and cleanliness of personnel, premises, and utensils will greatly reduce the maximum preservative requirement to maintain products from spoilage.

In some less developed countries, semi-processing offers great advantages to rural farmers to add value to their crops that cannot be absorbed by the local markets because of seasonal production glut. The key factor is to supply the semi-processed products to the downstream processor, who has an advantage in terms of price and convenience. Some products that can be processed using this method are apple, tomato, orange, mandarin, banana, mango, guava, etc.

## 6.5 Sugar Preserved Products

Sugar preserved products include jams, jellies, preserves, conserves, marmalades, fruit butters, honeys, and syrups. They are fruit products that are jellied or thickened. All are preserved by sugar. Their individual characteristics depend on the kind of fruit used and the way it is prepared, the proportions of different ingredients in the mixture, and the method of cooking.

Jellies are made by cooking fruit juice with sugar. However, some are made without cooking using special uncooked jelly recipes. A good jelly is clear and firm enough to hold its shape when taken out of the container. Jelly should have a flavorful, fresh, fruity taste. Pectin in the fruit (or added pectin) plays a major role in the quality of jams and jellies. Jelly quality depends on the amount of pectin present in the fruit, acidity, and sugar content (Löfgren, 2000). One of the most important quality criteria for jellies is jelly strength. Gel-strength is affected by the continuity of structure, which is dependent on the amount of pectin used.

For jellies, pectin is used in the range from 0.5% to 1.5%, but about 1% of pectin is optimal. Gel-strength is also dependent on the rigidity of the gel structure, which is dependent on the amount of sugar and acid used. Sugar content of 64% gives a weak gel, whereas that at 70% gives a crystallized structure. Therefore a sugar concentration of 67.5% is optimal. Similarly acidity of pH 2.5 results in very hard gels, whereas that over 3.7 results in a softer gel. Therefore the optimum pH is about 3.2.

Jams are thick sweet spreads made by cooking crushed or chopped fruits with sugar. Jams are generally less firm than jelly. Preserves are small, whole fruit, or uniform size pieces in clear, slightly gelled syrup. The fruit should be tender and plump.

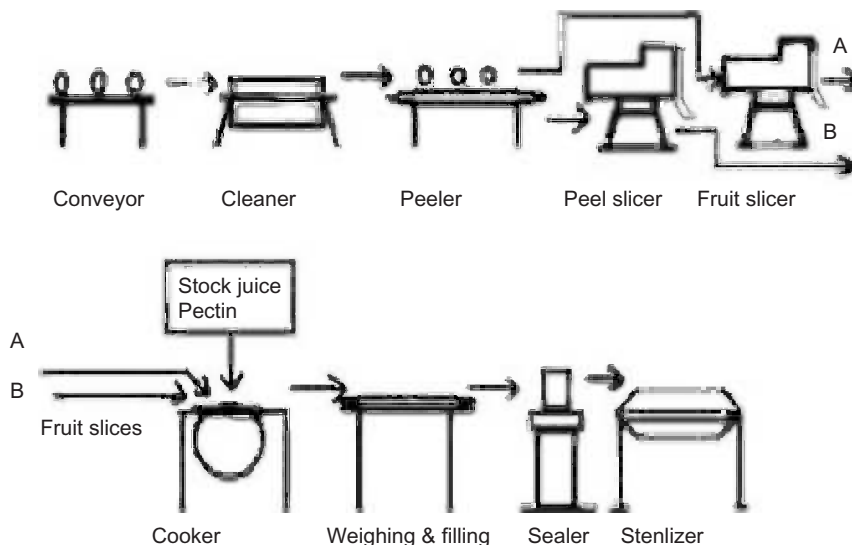
Conserves are jam-like products that may be made with a combination of fruits. They may also contain nuts or raisins. Jam and marmalade are also made in drinks factories, and many processes follow complicated paths. Marmalades are soft fruit jellies containing small pieces of fruit or peel evenly suspended in the transparent jelly. They often contain citrus peel. A schematic flow diagram for marmalade manufacture is shown in [Figure 11.3](#).

Other fruit products that are preserved by sugar but not jellied include butters, honeys, and syrups. Fruit butters are sweet spreads made by cooking fruit pulp with sugar to a thick consistency. Spices are often added. Honeys and syrups are made by cooking fruit juice or pulp with sugar to the consistency of honey or syrup.

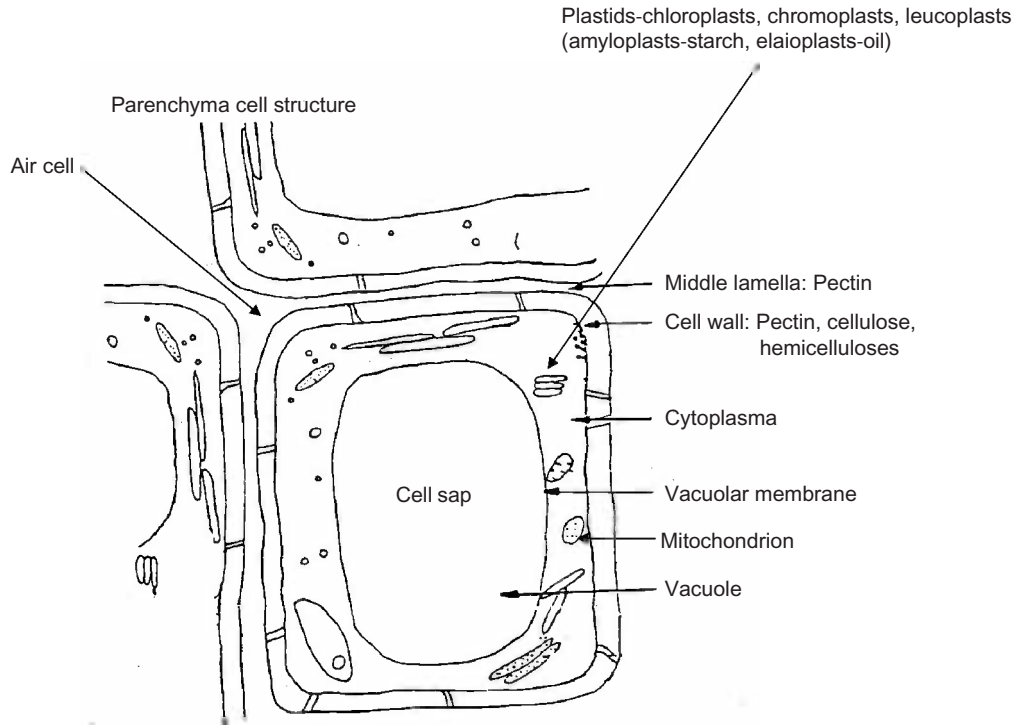
## 6.6 Juice Processing

Juice is one of the most commonly consumed processed horticultural products. It is the expressed liquid from fruits or vegetables. Fruit and vegetables consist of parenchymatic cells, which consist of vacuoles, and cytoplasm, and other cell components surrounded by cell walls. [Figure 11.4](#) is a schematic diagram of a cell of parenchymatic plant tissue.

The vacuoles contain all the water-soluble components and their precursors such as sugars, acids, salts, etc. The vacuole is enclosed in a semi-permeable membrane system consisting of lipoproteins that allows transport of only the water molecules. This



**Figure 11.3** Schematic flow diagram of a marmalade processing line.



**Figure 11.4 Schematic diagram of a parenchymetic cell and some of its components.**

is how osmotic pressure is created, which presses the membranes against the cytoplasm and cell wall giving turgor pressure (indicated by firmness and freshness).

The cell walls are also permeable. They are rigid structures consisting of pectin, cellulose, and hemicellulose. Pectin is the main constituent of middle lamella, which glues the cells together. Enzymes are located in mitochondria found in the cytoplasm. Juice is really the cell sap, which can only be obtained by destroying the membrane.

This can be done by any one of the following ways:

- Mechanical cell disruption.
- Exposing the vacuoles when the restraining cell walls are enzymatically removed.
- Denaturing the membranes in diffusion processes with hot water or alcohol.

### **6.6.1 Mechanical Pressing**

The traditional way of making fruit juice is by pressing. It is essentially a process of cell disruption with mechanical separation. Different techniques are used for clear and cloudy juices. Cell disruption means that the compartmentalization of the tissue is destroyed.

As a consequence of cell disruption, many chemical, biochemical, and physical changes may occur. Pectin is important in juicing, because a fraction of the pectin is



found in the soluble form in the cell wall. It becomes dissolved in the liquid phase during grinding and pressing.

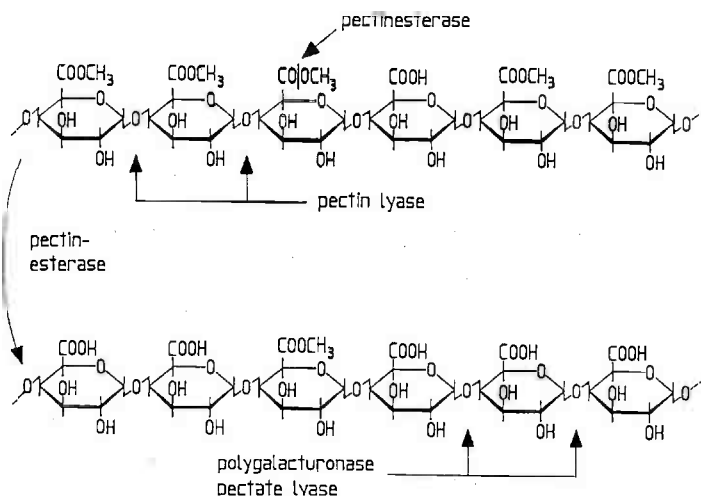
Pectin in the juice can cause the following changes:

- Cause the juice to become viscous.
- Stabilize the cloud particles.
- Cause gelling of concentrates.
- Cause formation of flocks during storage.

Therefore, clarification treatments include enzymatic degradation of pectin using commercial fungal enzymes with strong pectolytic activity.

Pectin is mostly a chain of 1–4 linked galacturonic acids, part of which is esterified with methanol. The points of attack of the pectolytic activities are illustrated on the galactouronan part of a pectin molecule as shown in [Figure 11.5](#).

Pectin lyases depolymerize highly esterified pectin by splitting glycosidic linkages next to methylesterified carboxyl groups through a  $\beta$ -elimination process. Another depolymerization pathway is by the combination of pectin esterase (PE), also known as pectin methylsterase (PME) and polygalacturonase (PG). PE or PME splits off methanol from highly esterified pectin, transforming it into low ester pectin, which is hydrolyzed by PG attacking glycosidic linkages next to a free carboxyl group. PE and PG are also found as naturally occurring endogenous enzymes in fruits and vegetables ([Pilnik and Voragen 1989](#)). Pectate lyase (PAL) also attacks glycosidic links next to a free carboxyl group, so that PE also prepares a substrate for this enzyme. PAL is a bacterial enzyme and is not found in fruits and vegetables or enzyme extracts from fungal preparations. It has a high pH optimum and is unsuitable for fruit processing.



**Figure 11.5** Schematic diagram of a pectin molecule and the points of attack by pectinase enzymes ([Pilnik and Voragen, 1989](#)).

### 6.6.2 Clarification of Juice

For clarification of juice, only the pectolytic activities are necessary. Raw pressed juice is a viscous liquid with a persistent cloud of cell wall fragments and complexes of such fragments with cytoplasmic protein.

Addition of pectinase lowers the viscosity and causes the cloud particles to aggregate (Figure 11.6) and sediment, and can be easily centrifuged off.

This mechanism was first proposed by Yamasaki *et al.* (1964). The cloud particles have a protein nucleus with a positive surface charge, coated by negatively charged pectin molecules. Partial degradation of these pectin molecules by PG enzymes results in the aggregation of oppositely charged particles.

The reduction in viscosity of raw juice is also brought about by the action of pectinase enzymes (PG and PE). This same effect is also brought about by pectin lyase (PL), which is found in small amounts in commercial enzyme preparations.

Enzyme clarified juices are filtered and often treated with fining agents such as:

- Gelatin, and polyvinylpolypyrrolidone (PVPP) to bind to phenolics to prevent haze formation and to reduce astringency.
- Then treated with bentonite (montmorillonite, a volcanic clay) or silica sol (colloidal solution of silicic acid and silicon dioxide) to bind excess protein (gelatin and enzymes).

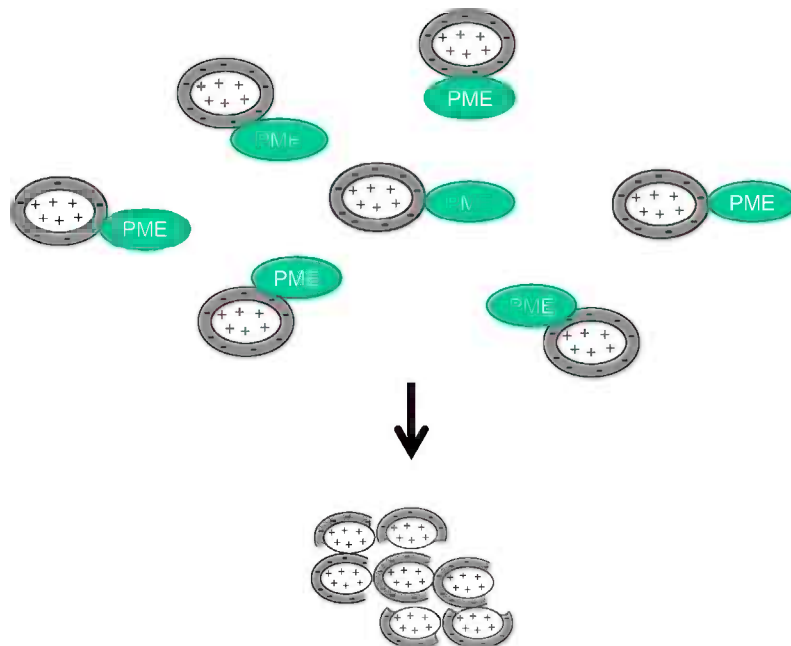


Figure 11.6 Sedimentation due to aggregation of partially hydrolyzed pectin molecules to form large molecules. (Adapted from Yamasaki *et al.*, 1964)

Pectin degradation is also important in the manufacture of high Brix concentrates to avoid gelling and the development of haze. Clarification also includes starch degradation by amylase in cases where starch is present and has had the chance to gelatinize. Ultrafiltration is increasingly used instead of fining with chemicals. Some low molecular compounds pass through the membrane and are able to polymerize in the course of time in the acidic medium of the juice. This may lead to haze formation. Treatment with PVPP is therefore recommended.

New approaches to juice clarification include the use of fungal PPO to initiate oxidation of phenolics before membrane filtration. Ultrafiltration allows continuous operation, produces a sterile product, and saves enzymes by retaining them in the active form.

### **6.6.3 Pulp Enzyming**

Certain fruits do not press well after storage or if they are over-ripe, for example apples, plums, nectarines, etc. They develop a mealy texture, which does not give rise to good juice extraction. This is because of large fractions of pectin that have been solubilized, so that the viscous juice adheres to the pulp. Use of pressing aids such as cellulose fiber or rice hulls can improve this situation.

Pectolytic enzymes can also be used for juicing of soft fruits. Breakdown of pectin releases thin free flowing juice, so that at high pressures a thin juice can be extracted. Prevention of the inactivation of added enzymes by polyphenols is an important aspect of the process.

In the case of apples, endogenous PPO is encouraged to oxidize the phenols by aeration and polymerize. The polymerized phenols are thus unable to combine with the added enzymes. An alternative is to add PVPP to bind the phenols. Enzyme preparations that work well with juice clarification are also suitable for enzyme treatment of pulp. In the case of apples, any combination of enzymes that depolymerize highly esterified pectin can be successfully used. A better release of anthocyanins of fruits into the juice is also achieved by cell wall destruction by pectinase enzymes. This is also a distinct advantage in red wine making.

### **6.6.4 Enzyme Liquefaction**

Fruits and vegetables can be transformed into juice by the use of liquefaction enzymes. Combinations of pectinase and cellulase enzymes are generally referred to as liquefaction enzymes.

Commercial preparations of cellulase obtained from *Trichoderma* species became available in the 1970s. Degradation of crystalline cellulose requires a particular set of enzymes. With respect to hydrolysis, cellulases can be divided into endo- and exo-acting enzymes. The presence of exo- $\beta$ -glucanase (C1 cellulase or cellibiohydrolase) is

typical of cellulose preparations, which are able to degrade highly ordered cellulose to form cellobiose.

Degradation of crystalline cellulose is believed to occur at the surface of the cellulose fibril by endo- $\beta$ -glucanase, followed by exo- $\beta$ -glucanase. Cellulose, is a competitive inhibitor of cellulases that is hydrolyzed by cellobiase to glucose. A combination of cellulase and pectinase act synergistically, shown by the dramatic decrease in viscosity of the product. The low viscosity values reached correspond to complete liquefaction shown by the disappearance of cell walls under a microscope.

Enzyme liquefied papaya and cucumber are almost clear, whereas apples and peaches are somewhat cloudy and carrots are pulpy. Enzyme liquefied products can be clarified further by the usual techniques of PVPP and bentonite treatments discussed earlier. Enzyme liquefaction increases the soluble solid content in the juices. Thus high yields of juice and soluble solids are obtained. Enzyme liquefaction is important in the manufacture of fruit and vegetable juices, which yield no juices on pressing, for example, mango, guava, banana, durian, etc. No presses have been developed for extracting juices from such products. Therefore there is good potential for using enzyme liquefaction techniques to manufacture juices from such tropical fruits.

Care has to be taken in selecting commercial enzymes used for enzyme liquefaction. Most commercial enzymes have a number of side activities other than the major activities. Thus some of the fruity esters may be hydrolyzed and the finished product may give rise to bland/reduced flavor intensities. The high degree of hydrolysis obtained in liquefaction results in higher uronide content. This means an increase in titratable acidity and hence enhances the acid taste. Free methanol from pectinesterase is also present from about 60–450 mg/l of the juice. The presence of these high levels of MeOH is of concern to consumers, as MeOH is regarded as a poison. Juices extracted by the enzyme liquefaction process generally tend to have somewhat different composition, thus may not conform to standard juice specifications. Therefore, for juice such as orange, apple, pineapple, etc, where standards exist, the liquefaction process cannot be used.

### **6.6.5 Diffusion Treatment**

The traditional processes of juice extraction involve the destruction (mechanical pressing) or dissolution of the cell wall (enzyme treatment), or a combination of the two processes. In the diffusion process, the cell wall membranes are heat denatured to make the cell walls permeable and allow diffusion of cell sap constituents from the vacuole into the extractant medium. It uses the counter current principle, in which hot water is used as the medium of extraction.

Apple juices extracted by this process have similar characteristics to pressed juices, but counter-current extracted juices tend to have a higher level of phenolics, which can be removed by refining. They also contain a higher level of pectin, which can be

broken down by pectinase enzymes. A certain amount of dilution will happen because of the use of hot water. Therefore the diffusion process is not suitable for freshly squeezed juices, but suitable for juices meant for concentration.

## 6.7 Cacao Processing

### 6.7.1 The Cacao Tree

Cacao beans are the fruit of the cacao tree. The scientific name is *Theobroma cacao*. Chocolate is made from cacao beans. *Theobroma* in Greek means “food of the gods” (theo = god and broma = food), and that is exactly what chocolate has been known as for centuries.

### 6.7.2 The Fruit

Fruits grow direct on the trunk and on larger branches. The color of ripe cacao fruits varies from yellowish brown to almost red. It takes 4–8 months for the fruit to ripen. Each fruit contains about 30 oval shaped seeds (beans) surrounded by a sweet–sour fruity pulp. There is a long and thorough process to turn the beans into the precious luxury product called chocolate. Each tree produces only 50–60 fruits every year, or only about 7–9 kg of dry beans per tree every year.

### 6.7.3 Composition of Dried Cacao Bean

- 54% coco butter.
- 11.5% protein.
- 9% starch.
- About 5% water.
- Plus hundreds of other elements including theobromine, caffeine, and aromatic oils (Figure 11.7).

All belong to a class of compounds called alkaloids (methylxanthines). Theobromine affects human organisms in ways similar to that of caffeine. This is why chocolate should be consumed in moderation, especially by children.

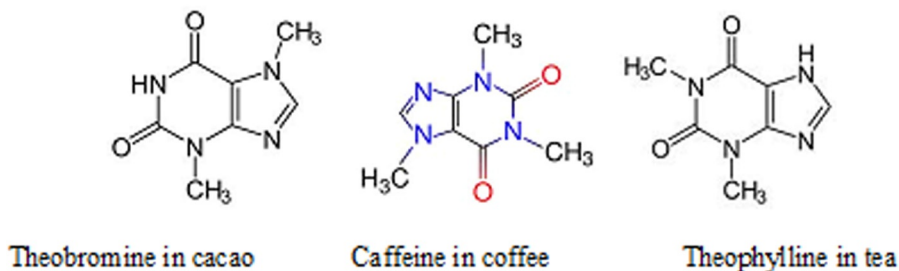


Figure 11.7 Common alkaloids in cacao, coffee, and tea.

### 6.7.4 Cacao Cultivars

There are three types of cacao beans suitable for human consumption:

- The Criollo (native).
- The Forasteros (wild).
- The Trinitario (hybrid).

Criollo means “native” in Spanish. These beans were originally discovered by Christopher Columbus on the island of Guanaja in 1502. Found throughout South America in areas where the climate is mild and the soil is rich, the Criollo is recognized as the King of cacao beans. It has an extremely fine aroma with very low acid levels. It is also the rarest and most expensive of all cacao beans.

### 6.7.5 Harvest

The cacao is harvested throughout the year, but the main seasons are November to January and May to July. It is harvested by hand, cutting the cacao fruit with sharp machetes. It is impossible to use machines for harvesting, because of differing fruit maturity and as the cacao is continuously producing new flowers and fruit. Harvested fruits are opened and the seeds (beans) with their surrounding pulp are extracted.

### 6.7.6 Fermentation

The beans with pulp are placed in fermentation boxes or between banana leaves. They will stay there for 5–6 days during which the sugar from the beans will be turned into alcohol. The pulp will become a liquid and will drain out.

During this phase, some essential chemical and physical transformations take place:

1. The bean is inactivated to prevent germination.
2. The beans are freed from the sugary pulp, which tend to swell and take on a brown color.
3. The “flavor precursors” are formed inside the beans.

The cocoa beans are mixed frequently to aerate them and keep the fermentation process uniform. The fermentation phase must be as short as possible. Fermentation is an essential phase to develop the aromatic qualities of the cocoa. It is during the fermentation that the cacao bean develops the brown color of typical cacao.

When one organism starts growing, it alters the environment and inhibits its own growth but the new conditions are favorable for another species. This is called microbial or ecological succession (Figure 11.8). The pulp contains mostly water with about 10–15% sugar. (Table 11.1). The high sugar content in the pulp favors the growth of yeasts, which ferment sugars to ethyl alcohol in the anaerobic heap. During the first 24 h, the seeds germinate and plant enzymes hydrolyze the sucrose to glucose and fructose.

Eleven different species of yeasts have been isolated but the most abundant are:

- *Saccharomyces cerevisiae*.
- *Candida rugosa*.
- *Kluyveromyces marxianus*.

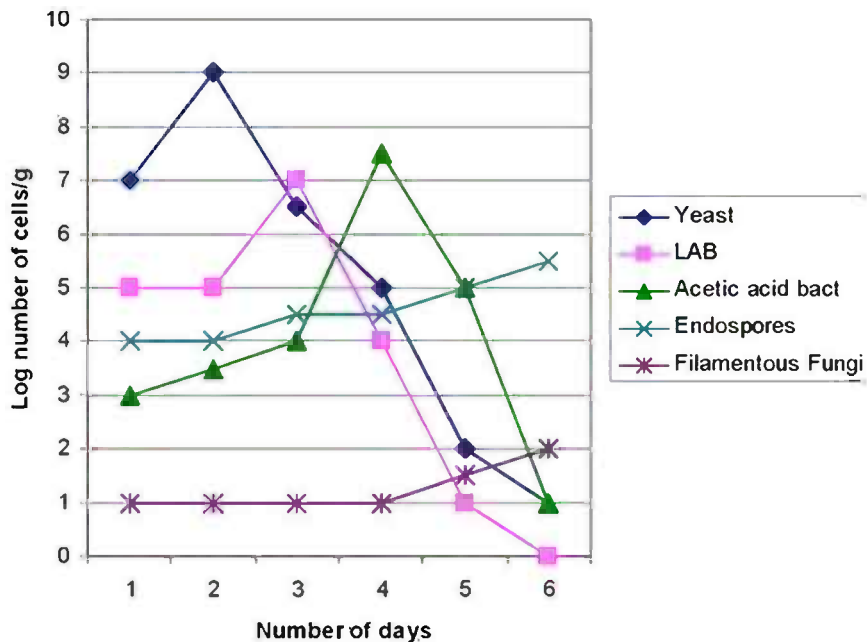


Figure 11.8 *Microbial ecology of cacao fermentation.*

Table 11.1 Pulp Composition

	Before Fermentation	After Fermentation
Sucrose	10–15%	0%
Citric acid	1–3%	0.5%
Pectin	1–1.5%	0
pH	3.7	6.5%
Ethyl alcohol	-	0.5%

In addition to producing ethyl alcohol, the yeasts hydrolyze the pectin that covers the seeds. As microbes grow using the sugars, they produce heat which is trapped by the cover on the heap. The temperature in the fermentation heap reaches 40–50°C, which kills the plant embryo.

Experimental fermentations indicate that *S. cerevisiae* decreases the bitterness of the final product. Without pectin, the bitter alkaloids may leach out of the seed or be altered by alcohol that can now enter the seeds. The yeasts are killed by the alcohol they produce and, as the temperature rises, lactic acid bacteria (LAB) such as *Lactobacillus* and *Streptococcus* grow.

The pulp is stirred and drained to aerate it. The presence of oxygen and the lower pH now favor the growth of acetic acid bacteria such as *Acetobacter* and *Gluconobacter*.

After 5 days, the fermented mass contains up to  $10^8$  microbes per gram. The beans are then dried and as they dry, molds including *Geotrichium* may grow. *Geotrichium* oxidizes the lactic acid to acetic acid and succinic acid. If fermentation is allowed to continue beyond 5 days, microbes may start growing on the beans instead of on the pulp. Off-tastes result when *Bacillus* and filamentous fungi, including *Aspergillus*, *Penicillium*, and *Mucor*, hydrolyze lipids in the beans to produce fatty acids. As the pH approaches 7, *Pseudomonas*, *Enterobacter*, or *Escherichia* may grow and produce off-tastes and odors.

#### **6.7.7 Drying of Cacao Beans**

After the fermentation, the beans will have to be dried. Before drying, the moisture content of the seeds is about 60% and it will have to be lowered to 5–7% before the beans can be traded and stored. In most places the drying is done in the sun. The beans are spread out in 2" thick layers and are dried for about 14 days. Industrial producers use hot air dryers to dry the beans.

#### **6.7.8 Roasting/Winning**

The next step in the preparation of chocolate is the roasting. The roasting, which involves temperatures of 98°C, lasts for anything between 10 and 115 min. The roasting is necessary for the development of the unique cacao flavor and aroma (Figure 11.9). It is a very critical process that must be closely monitored at all times. If the beans are roasted at low temperature and for a short time, the fruitiness of the cacao bean will be well preserved. If the beans are of poor quality they will need to be roasted longer and at higher temperatures. Roasting longer will increase the bitterness. If the beans are over-roasted they are completely useless. Roasting is followed, by winnowing, a process in which the cacao bean shells are removed.

#### **6.7.9 Grinding**

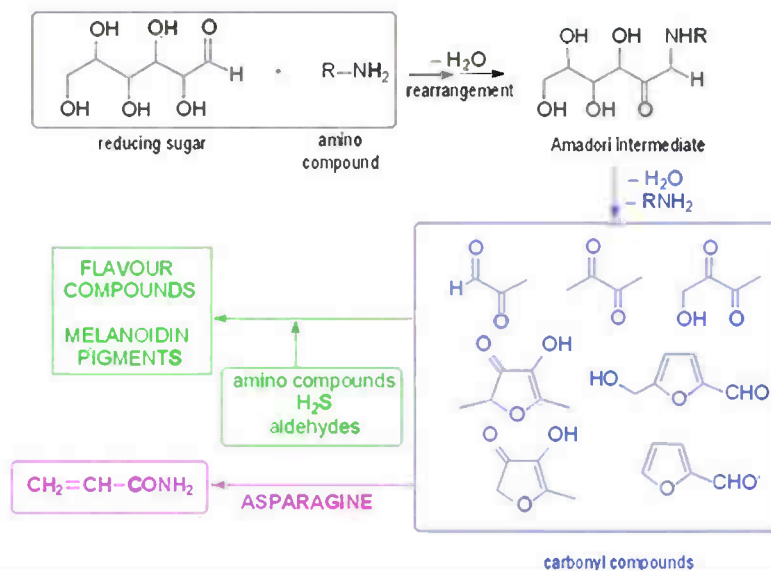
There are two stages of the grinding process. In the first stage, the beans are ground to about 100  $\mu\text{m}$  size particles. This stage will produce a liquid mass called cacao liquor. The cacao liquor is pressed into coco butter and coco powder, or the liquor is processed into Chocolate directly. The solids left after the cocoa butter has been expressed resemble a dry cake, which is then ground into cocoa powder.

#### **6.7.10 Chocolate**

To produce chocolate another grinding takes place to avoid “grainy” texture in the finished product. This time the particle size is reduced to about 18  $\mu\text{m}$ . To make eating chocolate, additional cocoa butter and sugar are added to the chocolate liquor. The best chocolates also have added vanilla, and lecithin, a natural stabilizing agent. The higher the percentage of cacao used, the darker will be the finished chocolate.



# Maillard Reaction (Mottram, Univ. of Reading)



## Typical Heterocyclic Compounds and Their Characteristic Flavor


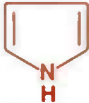



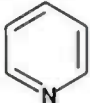


Desirable compounds				Undesirable compounds
<b>Furan</b>  Sweet Caramel-like	<b>Pyrrole</b>  Sweet Ethereal; Burnt	<b>Thiophene</b>  Onion-Like Sulfurous		<b>Imidazole</b>  Pungent Off-flavor
<b>Thiazole</b>  Cooked-meat Sulfurous	<b>Pyridine</b>  Pungent Smokey Fishy	<b>Pyrazine</b>  Roasted Toasted Cooked	<b>Oxazole</b>  Sweet Roasted	(Acrylamide ?)

Figure 11.9 Maillard reaction products. (Adapted from Lineback, 2005)

Conversely, the more sugar you add, the sweeter, and less chocolaty, the chocolate will be.

### **6.7.11 Milk Chocolate**

To make milk chocolate, powdered milk is added to the mixture, a technique developed in 1876 by Swiss partners Henri Nestlé and Daniel Peter. The quality of milk chocolate depends on the ratio of chocolate liquor to sugar and milk, the quality of the milk, and the quality of the chocolate liquor itself. The best chocolate makers rely on the best raw ingredients. However, lower-grade chocolate makers substitute vegetable fats for authentic cocoa butter, use artificial vanillin instead of real vanilla, load up on the lecithin (which leaves a waxy texture), and use a high percentage of sugar, all in an effort to keep costs down.

### **6.7.12 Conching**

During conching, the chocolate liquid mass is stirred and mixed at a temperature of about 82°C. Friction between the sugar and the cacao particles occurs. This causes further “polishing” of the cacao particles, thus contributing to the smooth texture of the finished chocolate. After all, good chocolate should melt in your mouth without a “grainy” feeling being left on your tongue.

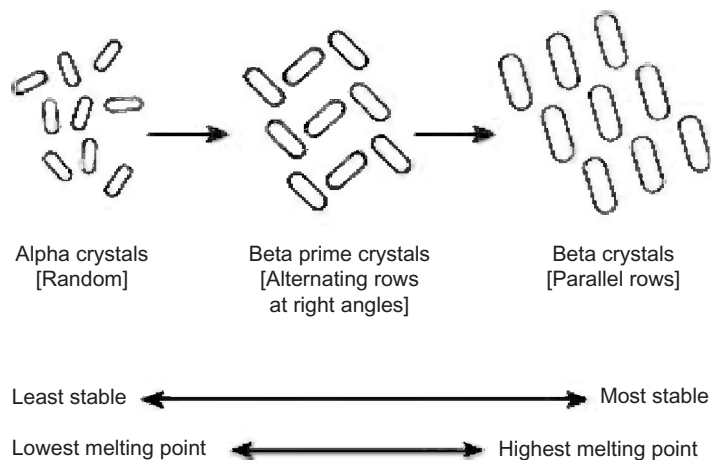
### **6.7.13 Tempering**

Tempering is a technique for controlling crystallization. Six different crystal structures of cocoa butter are known, and these polymorphic forms are denoted from I to VI (Figure 11.10). Each polymorph has a different melting point, from 17.3°C (Form I, alpha crystals) to 36.6°C (Form VI, beta crystals). Form V (beta prime crystals) has the ideal melting point of 33.8°C, above normal room temperature and just below body temperature.

The most stable polymorph of cocoa butter is Form V melting between 30.7°C and 34.3°C. Although lower polymorphic forms are formed more readily, they are less stable. Higher melting polymorphs have closely packed crystals in the fat and hence lower volume. Tempering ensures that cocoa butter crystallizes in the most stable form. When the lower melting polymorphic form of cocoa butter (fat) melts and is then allowed to re-crystallize, it re-crystallizes in the thermodynamically stable higher melting point form, which gives rise to white patches on the surface known as “fat blooming”.

### **6.7.14 Tempering Process**

Tempering is a crucial stage of chocolate manufacture, which ensures that the fat in the chocolate crystallizes in a thermodynamically stable crystal form. The process generally involves cooling the molten chocolate (held at about 45°C) to a temperature



**Figure 11.10** Polymorphic forms of fat crystals.

(about 27°C) that induces crystallization in both stable and unstable crystal forms (polymorphs). Raising the temperature slightly (to about 30°C) then melts out the unstable crystal forms leaving only the stable crystals to seed the crystallization of the bulk chocolate in a stable polymorphic form. To help crystals to grow, the chocolate is usually stirred as it is cooled using scraping and mixing blades. The temperatures needed to temper a chocolate depend on the composition of its fat phase.

## 6.8 New Trends—Including Minimal Processing

### 6.8.1 Minimal Processing

Changes in consumer lifestyles have led to an increased desire for ready-to-eat or ready-to-use products. Therefore, interest in a new area of food preservation is being promoted, that is, minimally or lightly processed products. Other terms used to refer to minimally processed products are lightly processed, partially processed, fresh processed fresh-cut, and pre-prepared. Minimally processed products are important to the food service industry such as restaurant and catering companies, as they offer many advantages over traditional products, with respect to convenience, expense, labor, and hygiene.

Despite their popularity, the production of minimal processed products is limited because of rapid deterioration and senescence (natural aging leading to death of the tissue). Hence, minimally processed foods are more perishable than their unprocessed raw materials (Bolin and Huxsoll, 1989).

Minimal processing of fruits and vegetables generally involves washing, peeling, slicing, or shredding before packaging and storage at low temperature. All these steps have an effect on the nutrients, shelf-life, and quality of the prepared product

(Barry-Ryan and O'Beirne, 1999; McCarthy and Mathews, 1994). Examples of these products already on the market include packaged shredded lettuce/cabbage/carrots, cut fruit and vegetable salads and peeled/sliced potatoes/carrots, broccoli and cauliflower florets, and many more (Perera and Baldwin, 2001).

Minimal processing of raw fruits and vegetables has two purposes. First, it is important to keep the product fresh, but convenient without losing its nutritional quality. Second, the product should have a shelf-life sufficient to make distribution feasible within the region of consumption. The microbiological, sensory, and nutritional shelf-life of minimally processed vegetables or fruits should be at least 4–7 days, but preferably even longer.

Minimally processed foods are highly perishable because partial processing increases perishability and shortens shelf-life compared with that of the intact equivalent. The process includes washing, shredding, dicing, trimming, pre-treatments, possibly low level irradiation, handling and packaging, including modified atmosphere packaging and temperature control, but lacks any real step that ensures complete sterilization and preservation as found with canning. Minimal processing requires a high level of hygiene and a sanitization step, sharp knives, and an understanding of the post-harvest physiology of all the species used. These foods are characterized by being living tissues, with cut surfaces.

As the external protection (skin) is lost, tissues which are not normally exposed to the atmosphere are now exposed to air, microbes, and further handling damage. Further, cell contents, especially soluble sugars, coat the tissues and provide nutrients for the microbes. In response to wounding, there is active metabolism of tissues resulting from an increased rate of respiration and ethylene production increase within minutes, leading to increased rates of other biochemical reactions, such as browning, changes in flavor and texture, and loss of vitamins. The more the tissue is cut the greater the wound response.

Understanding the biological processes involved and manipulation of these processes to slow down tissue death is central to prolonging shelf-life. It is important to consider the biological purpose of the intact product, its shelf-life and how it responds to cutting in order to derive systems or treatments that can slow down degradation. Cells adjacent to those that have been damaged respond to the trauma of cutting by dying through endogenously controlled tissue death. This results in loss of lipid structure, which results in loss of membrane integrity as the lipid bilayer breaks down. Free fatty acids can cause lysis of organelles and bind to and inactivate proteins. Fatty acids can be broken down to hydroperoxides by enzymic action. Hydroperoxides are unstable and cytotoxic and their production can lead to the formation of free radicals and volatile end products, which are responsible for food spoilage. Free radicals act randomly with other compounds through hydrogen removal, causing chemical damage to proteins and lipids. This leads to leakage of cell contents and wounding of adjacent cells.

Applications of chemical preservatives, such as sorbic, benzoic acids, or sulfites, might be helpful in prolonging shelf-life but are strictly controlled in their use. Safer additives, such as citric and ascorbic acid alone, or in combination with other treatments and conditions, have been shown to improve the shelf-life of fresh-cuts (Butt and Abbott, 2000; Dong *et al.*, 2000; Soliva-Fortuny *et al.*, 2002, 2004).

Fruits and vegetables are living organisms that continue to change after harvest. Plant tissues incur damage during processing and, in addition, remain raw and living after processing. The physiology of minimally processed fruits and vegetables is essentially the physiology of wounded tissue. This type of processing, involving abrasion, peeling, slicing, chopping, or shredding, differs from traditional thermal processing in that the tissue remains viable (or “fresh”) during subsequent handling. Thus, the behavior of the tissue is generally typical of that observed in plant tissues that have been wounded or exposed to stress conditions (Brecht, 1995).

Within minutes of undergoing minimal processing of fresh produce, the rate of respiration and ethylene production markedly increase (Brecht, 1995) and essentially a “wound response” is initiated. Both respiration and ethylene production will result in shorter shelf-life of the product. The ethylene will accelerate ripening, as softening and senescence (Philosoph-Hadas *et al.*, 1991), which leads to membrane damage, while the respiration will use up energy reserves. Other consequences of wounding are chemical and physical in nature, such as oxidative browning reactions and lipid oxidation or enhanced water loss (Brecht, 1995).

Injury stresses caused by minimal processing result in mechanical rupture of tissues, and cellular decompartmentation leading to delocalization and intermixing of enzymes and substrates. One such enzyme system is the ascorbic acid oxidase, which oxidizes ascorbic acid to dehydroascorbic acid, which can then further degrade to other compounds leading to browning. Thus nutritional quality such as vitamin C is lost (Abe and Watada, 1991). Therefore, wound-induced physiological and biochemical changes take place more rapidly than in intact raw commodities, and microbial proliferation may be accelerated.

There is little information about the physiology and chemistry affecting minimal processing of tropical fruit and vegetable products. Such information is vital for the extension of both the fresh and minimally processed products. Novel ethylene receptor inhibitors such as 1-methylcyclopropene (1-MCP) that retard C<sub>2</sub>H<sub>4</sub> biosynthesis have been tested on temperate fruits to extend the shelf-life (Bai *et al.*, 2004; Perera *et al.*, 2003; Tay and Perera, 2004). 1-MCP is a cyclic olefin, analogous to the photo-decomposition product of DACP (70) and, to date, is the most useful compound among recently developed inhibitors of the ethylene response. 1-MCP is a gas at room temperature, has no obvious odor at required concentration levels, and is non-toxic. It is relatively stable in dilute gas phase for several months (Hopf *et al.*, 1995), but is unstable in the liquid phase, polymerizing even at low refrigerator temperatures (Sisler *et al.*, 1996).

There are various detrimental effects of ethylene on fruits and vegetables. The  $C_2H_4$  can cause yellowing of green stem and leafy vegetables (Saltveit, 1999). Ethylene from either endogenous production, or exogenous applications stimulates chlorophyll loss and the yellowing of harvested broccoli florets (Tian *et al.*, 1994). Russet spotting is a post-harvest disorder of lettuce in which small brown sunken lesions appear on the leaf. It is caused by the exposure to hormonal levels of  $C_2H_4$  at storage temperature of around  $5^\circ C$  (Ke and Saltveit, 1988). The firmness of many ripening fruits and vegetables decreases with  $C_2H_4$  treatment. This is usually beneficial when associated with ripening (e.g. bananas, tomatoes), but if applied for too long, ripening can progress into senescence and the flesh can become too soft. The crisp texture of cucumbers and peppers is lost on exposure to  $C_2H_4$  (Saltveit, 1999).

Minimally processed products should be refrigerated ( $0-5^\circ C$ ) to prolong their quality and safety (Watada *et al.*, 1996). Removal of  $C_2H_4$  from the storage environment of minimally processed fruits and vegetables can retard tissue softening (Abe and Watada, 1991). Desirable modified atmospheres can be predicted and created within and around commodities by selecting appropriate packaging. Controlled atmospheres can reduce the effects of  $C_2H_4$  on fruit tissues and retard senescence, delay softening, and help to extend the post-harvest life (Agar *et al.*, 1999).

Edible coatings and films have been used successfully with some commodities to provide useful barriers to moisture,  $O_2$  and  $CO_2$ , while improving package recyclability (Perera and Baldwin, 2001). Research has demonstrated that an increase in microbial populations on minimally processed products will have an adverse impact on shelf-life (Hurst, 1995). The higher the initial microbial load, the shorter the storage life (Perera and Kiang, 2003). Whereas psychrotropic Gram-negative rods are the predominant microorganisms on minimally processed products, the primary spoilage organism on pre-packaged salads appears to be the fluorescent pectinolytic pseudomonads (Nguyen-The and Prunier, 1989). Washing of fresh fruits and vegetables before cutting is important to control microbial loads that include mesophilic microflora, lactic acid bacteria, coliform, fecal coliforms, yeasts, molds, and pectinolytic microflora (Perera and Baldwin, 2001). Minimally processed products are generally rinsed in 50–200 ppm chlorine or 5 ppm of chlorine dioxide, which may also aid in reducing the browning reactions (Perera and Baldwin, 2001). However, product safety, not shelf-life is the critical sanitation issue in minimally processed fruits and vegetables (Hurst, 1995).

## 7. QUALITY CONTROL/ASSURANCE

The fruit and vegetable processing industry knows what good quality food production is. However, the small-scale processors often do little to maintain standards unless motivated by economics, regulations, and adverse publicity, because of a lack of

effective management, lack of apparent increased profits, high cost of quality control programs, and lack of knowledge of effective control programs.

Quality Assurance oversees and evaluates quality control, wholesomeness, and integrity. It involves:

- Review quality control sampling protocols.
- Develop recall protocols.
- Develop management reporting systems.
- Implement HACCP and Food Safety Programs.
- Help develop QC methods.
- Develop and improve laboratory methodologies.

Benefits of good quality programs are that they lead to increased yields/productivity, reduced distribution costs, reduced cost of consumer relations and services, more effective sales, reduced recall costs, decreased operating costs, decreased marketing costs, improved worker pride, increased job security, and increased profits.

Quality control involves conforming to product standards and specifications, such as physical attributes, chemical characteristics organoleptic attributes, and microbiological levels, issuing and monitoring manufacturing procedures, such as pre-processing, handling conditions, processing parameters, packaging materials, weight control, and labeling. Other activities include sample collection and testing, record-keeping and reporting, inspection, including sanitation and good manufacturing practices, compliance with regulations, safety of product as well as workplace, environmental control, and energy conservation, and handling of consumer complaints.

A company's objective should be to make a profit. Its objective in manufacturing a product is to satisfy consumer needs and expectations. Consumer complaints fall into many different categories. They may be concerned with the flavor, odor, color, texture, appearance, net volume or weight, deterioration etc. A procedure for handling consumer complaints should be developed and instituted.

The functions of Quality Assurance will include managing Hazard Analysis Critical Control Points (HACCP) and Good Manufacturing Practices (GMP) including, documenting and developing processing procedures, equipment cleaning, and sanitation schedules, a preventative maintenance program for equipment, pest and rodent control programs, providing employee training on GMP, sanitation, and proper product handling procedures, conducting monthly audits for adherence to GMP and quality assurance practices, and inspecting plant and equipment sanitation daily prior to production.

Managing Good Laboratory Practices (GLP) is also a function of Quality Assurance and this includes ensuring adherence to GLP, documentation of all testing methods, record-keeping and calibration processes, evaluating data generated by laboratory, and conducting monthly internal GLP audits.

## 7.1 Traceability

Traceability of finished products is another important aspect of quality assurance. Some aspects of this involve initiating a microbiological and chemical testing program for finished products, implementing systems for lot-identification and tracking all stages of distribution, documenting procedures for out-of-specification finished products, and developing a product recall program.

Traceability systems are a tool to help firms manage the flow of inputs and products to improve efficiency, product differentiation, food safety, and product quality. Food companies need to balance the costs and benefits of traceability to determine its efficiency. In cases of market failure, where the private sector supply of traceability is not socially optimal, the companies could develop a number of mechanisms to correct the problem, including contracting, third-party safety/quality audits, and industry maintained standards. The best-targeted government policies for strengthening this system are aimed at ensuring that unsafe or falsely advertised foods are quickly removed from the system, while allowing companies the flexibility to determine the manner in which it is done. Possible policy tools include timed recall standards, increased penalties for distribution of unsafe foods, and increased foodborne-illness surveillance (Golan *et al.*, 2004).

## 7.2 HACCP

The HACCP concept is a systematic approach to hazard identification, assessment, and control. Identification of hazards and the assessment of severity of these hazards and their risks (hazard analysis) associated with growing, harvesting, processing/manufacturing, distribution, merchandizing, preparation, and/or use of fruits and vegetable products.

Hazards are unacceptable contamination, growth and/or survival of microorganisms of concern to safety or spoilage, and/or the unacceptable production or persistence of products of microbial metabolism. They can also be physical in nature, such as glass and metal in the food, or chemical in nature such as pesticides, poisons, etc.

# 8. FRUIT AND VEGETABLE PROCESSING UNITS

## 8.1 Preliminary Studies

As discussed earlier, each new fruit and vegetable processing plant needs a good, specific preliminary study, which includes, among other things, the following aspects:

- Raw material availability.
- Raw material quality in adequate varieties for the types of finished products that will be manufactured.
- Harvesting and transport practices and organization from the field to the processing plant.



- Processing capacity related to raw material availability quantities, seasonality, etc.
- Processing equipment size/capacity suitable for above points.
- Availability of trained operators and resources to improve their knowledge.
- Availability of workforce in the area and resources for training them in order to be able to assure adequate trained operators.
- Availability of utilities: electricity, water, transport, etc.
- Position of the future processing plant related to raw material supply and to closest transportation means; road access, railway access.
- Market for finished products.

The decision to invest in fruit and vegetable processing must be taken on a case by case basis after adequate, preliminary studies have been carried out.

## 8.2 Production Sites

### 8.2.1 Installation and Operation of a Processing Facility

Several different processes take place on the site at which the production activity is performed, from the reception and conservation of raw materials, to the storage of finished products. Two aspects that must be met in determining the capacity of the plant are the availability of raw materials and ability to store the raw materials for a sufficient length of time to process. Another important factor is the cost of construction of the facility. The building materials must be easy to wash and disinfect, especially those in the clean areas of the processing rooms. Complex types of construction, resulting in the creation of places that are not easily accessible for cleaning must be avoided, for they may turn into bird nests, and contamination foci for rodents, insects, and of course, microorganisms (Dauthy, 1995).

The floor arrangement of the processing plant is more complex in its organization, and therefore specific activities are carried out in determined areas. Some of the aspects that may be considered important in relation to the architectural and construction elements are listed below:

- The ceiling and walls of the processing room must be of washable and easily dried materials; they must be neither absorbent nor porous.
- The lighting should be natural, as far as possible. However, if artificial lights must be used, they should not hinder activities in any way. Artificial lighting must be protected, to prevent fragments of glass from falling into the product as it is being processed, in case of accidents.
- Like the walls and ceiling of the processing room, the floor must be washable, to ensure compliance with the premises' hygienic and health standards.
- The floor must also be sloped to allow appropriate drainage, avoiding at all costs the formation of pools in the processing area. At the same time, care must be taken to prevent the floor from being slippery.

- Ideally, the working environment should always be appropriately ventilated, to facilitate the workers' performance. Poor ventilation in highly enclosed and densely populated premises may generate defects. It is also important to provide for the elimination of heavily contaminating odors, even if they are not necessarily toxic. On the other hand, excess ventilation may lead to aerial contamination from dust and insects, and may prove to be counterproductive. Appropriate ventilation must therefore be based on an efficient system controlling the access of foreign material from the external environment.

### **8.2.2 Basic Installations and Services**

Three basic services are required for most food processing operations, namely, electrical power, potable water, and the disposal of wastewaters. Electrical energy is indispensable, for the mechanization of the processes involved. All lights must be installed on the ceiling at a safe distance to prevent them from getting wet and getting in the way of workers in the processing room.

Availability of potable water is essential to ensure the development of a hygienic process, managed by clean people and with appropriately disinfected equipment. Also, many processes require water, as a result of which water of an appropriate quality must be available.

Water must be protected from possible sources of contamination and must be supplied on a continuous basis at all times. The consumption of water will depend on the process in question and the design of the production systems.

In the developing countries, where access to potable water is restricted, it is advised that chlorine be added to the water supplying the entire plant, so as to provide for permanent disinfection. To this end, a dose of 2 ppm of residual free chlorine is suggested. This will prevent the water from having any chlorine-like taste. It should also be borne in mind that the tank must be covered and not exposed to sunlight, to prevent the chlorine from decomposing.

### **8.2.3 General Flow Plan of a Processing Facility**

A fruit and vegetable processing plant must be set up in such a way as to rely on a number of basic facilities. [Figure 11.11](#) shows a simplified industrial production system for the processing of fruits and vegetables.

### **8.2.4 Reception of Raw Material**

The plant must be equipped with a special area for the reception of raw materials, that is, a site where the raw material received in appropriate conditions may be stored until it is used in the process. This site must meet certain special standards in terms of temperature, humidity cleanliness, and exposure to sunlight. It is important to consider that the quality of most raw fruits and vegetables deteriorate rapidly. That is,

even though many species do preserve their integrity, their inner quality is subjected to variations if storage conditions are less than adequate. It is for this reason that the temperature must be maintained at an appropriate cool temperature.

The raw material must not be directly exposed to sunlight. Storage temperature is a very important factor, and all appropriate precautions should be taken when stored under refrigeration condition to prevent loss of moisture and ethylene production, and cross-contamination from one another. If the storage site is cool, it is important for the humidity to be relatively high to prevent the material from dehydrating and losing its quality. It is important to note that the raw material storage area must not be used for the storage of other products that may be contaminating, such as pesticides, paint, or cleaning utensils, all of which must be kept in specially designated areas. It must never be forgotten that the quality of the product will reflect the quality of the

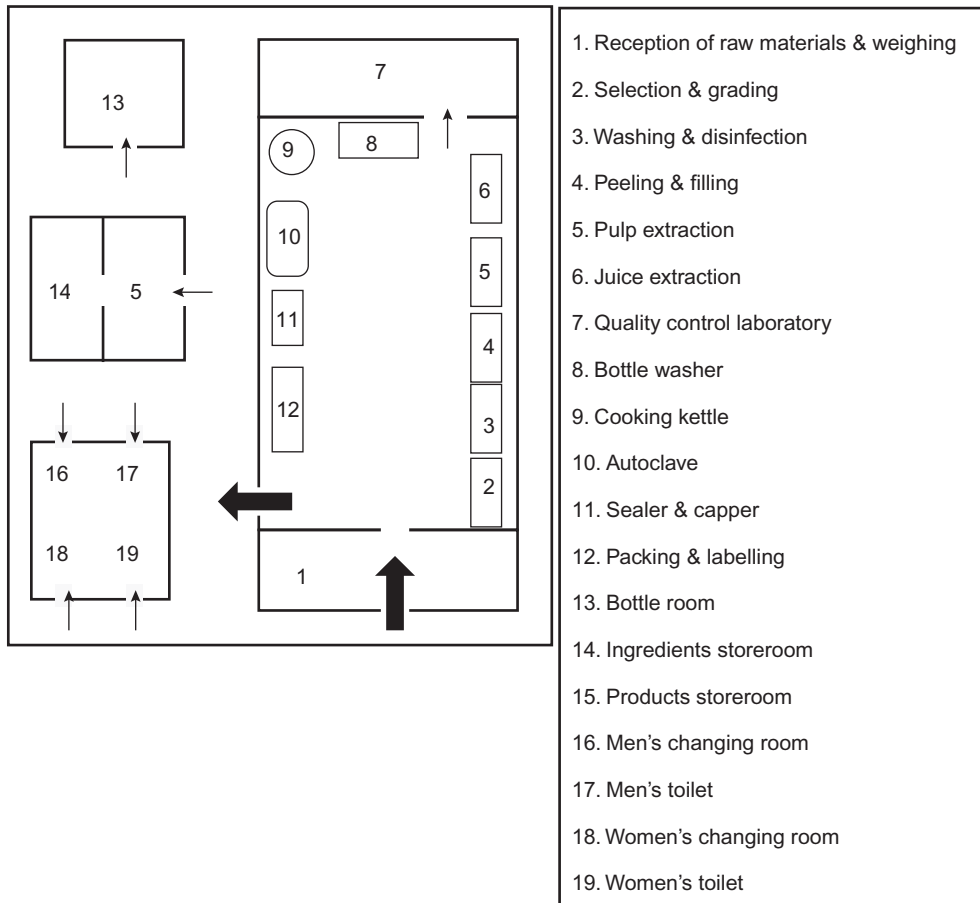


Figure 11.11 Schematic layout of a simple processing operation.

raw material from which it was made; it is therefore important to take this aspect into due account.

### **8.2.5 Processing Room**

It is in the processing room that the different materials used in the processing of the raw materials are stored. On such premises, a continuous production line may be set up. Ideally, this room should be large enough to lodge all of the necessary equipment on a continuous line, even in semi-automated facilities. Even in the case of workbenches, where the work is performed by hand, the process must be carried out on the basis of a continuous line, to step up efficiency.

The processing room should ideally be divided into areas where different functions are performed. This may be achieved by separating such areas physically. Generally, there is a “wet” area, that is, an area where the raw material is washed and peeled, and where operations like pitting, coring, and the removal of inedible parts are performed. This “wet” area must not extend to the section of the plant where the cleanest operations are carried out, like pulp extraction, grinding, cutting, and the filling of containers.

One way of achieving this separation is through the use of light partitions, or washable panels used to simply separate one area from the other. Much care should be taken to avoid contamination by runoff waters. The recontamination of materials that have already been washed and disinfected is a common problem in small-scale industrial processing plants.

### **8.2.6 Quality Control Laboratory**

Ideally, quality control operations should be performed in separate laboratory areas, where the basic tests required to establish the quality of a given raw materials or a given process may be performed. This area should preferably be equipped with a sink, running water, and a counter where tests may be carried out. It should be separated from the other parts of the processing plant, so that basic analyses may be carried out in a quiet environment.

### **8.2.7 Storeroom for Ingredients and Finished Products**

It is often necessary for a product to be stored or remain under observation before being dispatched or consumed. Such a place must be clean, the temperature and humidity levels must be appropriate, and it must be protected from foreign matter, insects, and pests. It should be easily accessible, so that tests may be performed during product storage, and any problems may be detected on the spot. Nowadays, the storerooms are very sophisticated, with palletized and computerized stacks, so that every item can be traced to its date of manufacture and batch number. This allows the goods to be kept for the least length of time in the store, before they are dispatched.

### **8.2.8 Other Facilities**

Some equipment, because of its nature, cannot be installed in the main facility of a processing plant. The boiler is an example. If the plant is equipped with a small steam generator, it should be located outside the processing room, to avoid contamination problems, and at the same time ensure personnel safety.

A drier is another piece of special equipment, which should be installed in a dry place and not in the processing room, as this is an especially humid area in the plant. Dehydrated products should normally be very low in moisture, a condition that can only be fulfilled if dehydration is carried out in an especially dry environment. Otherwise, the energy consumption cost will be very high, as a great amount of heat will be required to dry the air.

### **8.2.9 Sanitary Facilities**

Sanitary facilities are believed to deserve special mention because of the significant role that they play in preserving hygiene and safety standards in a food processing plant. The conditions in which the sanitary facilities operate, the type of evacuation system serving the plant, the location of the facilities, and the sanitation plan are crucial to the quality of the process. One basic condition is for the facilities to be erected in a separate location from the area where the raw material is received and processed, to prevent possible flooding. The facilities must be periodically disinfected, and the supervisors must exercise very strict control in this regard. Sanitary facilities must never be short of water. Its supply must be guaranteed, as the cleanliness of the toilets will determine the cleanliness of the workers, and the products' sanitary qualities will ultimately depend on the cleanliness of the workers.

## **8.3 Equipment Specifications for Processing of Horticultural Crops**

Because of the vast scope of equipment for a myriad of products involving fruits and vegetables, it is not possible to give a specific list of equipment, but a specification for processing equipment is addressed here:

- Equipment should be designed to hold the product with minimum spills and overflow.
- Surfaces in contact with food should be inert and non-toxic, smooth and non-porous.
- No coatings or paints should be used that could possibly chip, flake, or erode into the product stream.
- Equipment should be designed and arranged to avoid having pipes, mechanisms, drives, etc., above the open product streams.
- Bearings and seals must be located outside the product zone or sealed and self-lubricating.

- Proper design avoids sharp or inaccessible corners, pockets, and ledges so that all parts can be reached and cleaned easily. Build so that units are easy to take apart if necessary.
- Loose items like locking pins, clips, handles, gates, keys, tools, fasteners, etc. that could fall into the product stream should be eliminated.
- Equipment should be laid out for easy access for cleaning and servicing. Three feet from walls and between lines is recommended.
- Any and all containers, bins, cans, lug boxes, etc., used in the packaging or handling of food products should not be used for any purpose other than their primary use. Special containers should be provided that are readily identifiable and cannot get into the product stream.
- All equipment parts that come in contact with foods must be constructed with rust-resistant metal, such as stainless steel.

## REFERENCES

- Abe, K., Watada, A.E., 1991. Ethylene absorbent to maintain quality of lightly processed fruits and vegetables. *J. Food Sci.* 56, 1589–1592.
- Agar, I.T., Massantini, R., Hess-Pierce, B., Kader, A.A., 1999. Postharvest CO<sub>2</sub> and ethylene production and quality maintenance of fresh-cut kiwifruit slices. *J. Food Sci.* 64 (3), 433–440.
- Alexander, L., Grierson, D., 2002. Ethylene biosynthesis and action in tomato: a model for climacteric fruit ripening. *J. Exp. Bot.* 53 (377), 2039–2055.
- Ali, Z.M., Chin, L.-H., Lazan, H., 2004. A comparative study on wall degrading enzymes, pectin modifications and softening during ripening of selected tropical fruits. *Plant Sci.* 167 (2), 317–327.
- Ayaz, F.A., Kadioglu, A., 2000. Changes in fatty acid composition of cherry laurel (*Laurocerasus officinalis* 'Globigemmis') fruit during maturation. *N.Z. J. Crop Hort. Sci.* 28, 209–212.
- Babic, I., Nguyen-The, C., Amiot, M.J., Auber, S., 1994. Antimicrobial activity of shredded carrot extracts on food-borne bacteria and yeast. *J. Appl. Bact.* 76 (2), 135–141.
- Bacic, A., Harris, P.J., Stone, B.A., 1988. Structure and function of plant cell walls. In: Preiss, J. (Ed.), *The Biochemistry of Plants*. Academic Press, San Diego, pp. 297–371.
- Bai, J., Baldwin, E.A., Soliva-Fortuny, R.C., Mattheis, J.P., Stanley, R., Perera, C.O., et al., 2004. Effect of pretreatment of intact 'Gala' apple (*Malus domestica*, Borkh) with ethanol vapor, heat or 1-methylcyclopropene on quality and shelf life of fresh-cut slices. *J. Amer. Soc. Hort. Sci.* 129 (4), 583–593.
- Bai, Y., Rahman, M.S., Perera, C.O., Smith, B., Melton, L.D., 2002. Structural changes in apple rings during convection air-drying with controlled temperature and humidity. *J. Agric. Food Chem.* 50 (11), 3179–3185.
- Barry-Ryan, O'Beirne, D., 1999. Ascorbic Acid Retention in Shredded Iceberg lettuce as affected by minimal processing. *J. Food Sci.* 64 (3), 498–500.
- Baskin, T.I., 2001. On the alignment of cellulose microfibrils by cortical microtubules: a review and a model. *Protoplasma* 215 (1–4), 150–171.
- Benkeblia, N., 2004. Antimicrobial activity of essential oil extracts of various onions (*Allium cepa*) and garlic (*Allium sativum*). *Lebensm Wiss Technol.* 37 (2), 263–268.
- Binner, S., Jardine, W.G., Renard, C.M.C.G., Jarvis, M.C., 2000. Cell wall modifications during cooking of potatoes and sweet potatoes. *J. Sci. Food Agric.* 80 (2), 216–218.
- Bolin, H., Huxsoll, C., 1989. Storage stability of minimally processed fruits. *J. Food Proc. Pres.* 13, 281–292.
- Brecht, J., 1995. Physiology of lightly processed fruits and vegetables. *HortScience* 30 (1), 18–22.

- Bron, I.U., Ribeiro, R.V., Azzolini, M., Jacomino, A.P., Machado, E.C., 2004. Chlorophyll fluorescence as a tool to evaluate the ripening of 'Golden' papaya fruit. *Postharvest Biol. Technol.* 33 (2), 163–173.
- Bron, I.U., Ribeiro, R.V., Azzolini, M., Machado, E.C., Jacomino, A.P., 2005. Chlorophyll fluorescence emission and its relation to skin color and firmness during ripening of guava fruit. *Fruits* 60 (1), 25–32.
- Brummell, D.A., Harpster, M.H., 2001. Cell wall metabolism in fruit softening and quality and its manipulation in transgenic plants. *Plant Mol. Biol.* 47 (1–2), 311–340.
- Brummell, D.A., Cin, V.D., Lurie, S., Crisosto, C.H., Labavitch, J.M., 2004. Cell wall metabolism during the development of chilling injury in cold-stored peach fruit: association of mealiness with arrested disassembly of cell wall pectins. *J. Exp. Bot.* 55 (405), 2041–2052.
- Butt, J.G., Abbott, J.A., 2000. Browning inhibition of fresh-cut 'Anjou,' 'Bartlett,' and 'Bosc' pears. *Hortscience* 35 (6), 1111–1113.
- Chin, H.W., Lindsay, R.C., 1993. Volatile sulfur compounds formed in disrupted tissues of different cabbage cultivars. *J. Food. Sci.* 58 (4), 835–941.
- Code of Federal Register. 1991. Food additives. Title 7, Food and Drugs, Part 52.
- Code of Federal Register. 2001. Thermally processed low acid foods packaged in hermetically sealed containers. Title 21, Food and Drugs, Part 113 (revised April 01, 2001).
- Code of Federal Register. 2002. Irradiation phytosanitary treatment of imported fruits and vegetables. 7 CFR Parts 305–319, October 23, 67(205), pp. 65016–65029.
- Cosgrove, D.J., 2000. Loosening of plant cell walls by expansins. *Nature* 407 (6802), 321–326.
- Cowan, A.K., Cripps, R.F., Richings, E.W., Taylor, N.J., 2001. Fruit size: towards an understanding of the metabolic control of fruit growth using avocado as a model system. *Physiol. Plant* 111 (2), 127–136.
- Cunningham, J.H., Milligan, G., Trevisan, L., 2002. Minerals in Australian fruits and vegetables—a comparison of levels between the 1980s and 2000. *Food Standards Australia and New Zealand*. <[www.foodstandards.gov.au/\\_srcfiles/minerals\\_report.pdf](http://www.foodstandards.gov.au/_srcfiles/minerals_report.pdf)> (Last accessed 3.11.11.).
- Dauthy, M.E., 1995. *Fruit and Vegetable Processing*, FAO(UN), Rome. <<http://www.fao.org/docrep/V5030E/V5030E00.htm>> (Last accessed 3.11.11.).
- DeEll, J.R., Toivonen, P.M.A., 2000. Chlorophyll fluorescence as a non-destructive indicator of broccoli storage in modified-atmosphere packaging. *Hortscience* 35, 256–259.
- Dong, X., Wrostad, R.E., Sugar, D., 2000. Extending shelf-life of fresh-cut pears. *J. Food Sci.* 65 (1), 181–186.
- Elss, S., Preston, C., Hertzog, C., Heckel, E., Richling, E., Schreier, P., 2005. Aroma profiles of pineapple fruit (*Ananas comosus* [L.] Merr.) and pineapple products. *Food Sci. Technol.* 38 (3), 263–274.
- Flath, R.A., Light, E.M., Jang, E.B., Mon, R.T., John, J.O., 1990. Headspace examination of volatile emissions from ripening papaya. *J. Agric. Food Chem.* 38, 1060–1063.
- Food Irradiation Website. <<http://www.cdc.gov/ncidod/dbmd/diseaseinfo/foodirradiation.htm#process/>> (Last accessed 3.11.11.).
- Freidrich, J.E., 2002. Acid tastants. In: Wrostad, R.E., Acree, T.E., An, H.-J., et al., *Current Protocols in Food Analytical Chemistry*. John Wiley and Sons Inc., New York, pp. G2.1–G2.12.
- Fry, S.C., 1982. Phenolic components of the primary cell wall. Feruloylated disaccharides of D-galactose and L-arabinose from spinach polysaccharide. *Biochem J.* 203 (2), 493–504.
- Fry, S.C., 1983. Feruloylated pectins from the primary cell wall their structure and possible functions. *Planta* 157 (2), 111–123.
- Gillaspy, G., Ben-David, H., Gruissem, W., 1993. Fruits: a developmental perspective. *Plant Cell* 5 (10), 1439–1451.
- Giovannoni, J., 2001. Molecular biology of fruit maturation and ripening. *Ann. Rev. Plant Physiol. Plant Mol. Biol.* 52, 725–749.
- Giovannoni, J., 2004. Genetic regulation of fruit development and ripening. *Plant Cell (Suppl 16)*, S170–S180.
- Golan, E., Krissoff, B., Kuchler, F., Nelson, K., Price, G., 2004. Traceability in the U.S. food supply: economic theory and industry studies. *Agricultural Economic Report No. (AER830)*, March, p. 56.

- Gould, G.W., Russell, N.J., 2003. Sulfite. In: Russell, N.J. (Ed.), *Food Preservatives*, second ed. Kluwer Academic Publishers, Dordrecht, The Netherlands, pp. 85–102.
- Gullino, M.L., Clini, C., Garibaldi, A., 2005. Life without methyl bromide: the Italian experience in replacing the fumigant. *Commun. Agric. Appl. Biol. Sci.* 13–25 (Faculteit Landbouwkundige en Toegepaste Biologische Wetenschappen, Ghent Belgium).
- Gylling, H., Miettinen, T., 2005. The effect of plant stanol- and sterol-enriched foods on lipid metabolism, serum lipids and coronary heart disease. *Ann. Clin. Biochem.* 42 (4), 254–263.
- Han, Y., Sherman, D.M., Linton, R.H., Nielsen, S.S., Nielsen, P.E., 2000. The effects of washing and chlorine dioxide gas on survival and attachment of *Escherichia coli* O157:H7 to green pepper surfaces. *Food Microbiol.* 17, 521–533.
- Harker, F.R., Redgwell, R.J., Hallett, I.C., Murray, S.H., Carter, G., 1997. Texture of fresh fruit. *Hort. Rev.* 20, 121–233.
- Harker, F.R., White, A., Freeth, B., Gunson, F.A., Triggs, C.M., 2003. Simultaneous instrumental measurement of firmness and juiciness of apple tissue discs. *J. Text. Stud.* 34 (3), 271–285.
- Harris, P.J., Kelderman, M.R., Kendon, M.F., McKenzie, R.J., 1997. Monosaccharide compositions of unlignified cell walls of monocotyledons in relation to the occurrence of wall-bound ferulic acid. *Biochem. Syst. Ecol.* 25 (2), 167–179.
- Hopf, H., Wachholz, G., Walsh, R., 1995. Gas phase kinetics of pyrolysis of 1-methyl-1-cyclopropene. *Chem. Ber.* 118, 3579–3587.
- Hopkirk, G., Beever, D.J., Triggs, C.M., 1986. Variation in soluble solids concentration in kiwifruit *Actinidia deliciosa* at harvest. *N.Z. J. Agric. Res.* 29 (3), 475–484.
- Hurst, W.C., 1995. Sanitation of lightly processed fruits and vegetables. *Hortscience* 31 (1), 22–24.
- Ishii, T., Hiroi, T., 1990. Linkage of phenolic acids to cell-wall polysaccharides of bamboo shoot. *Carbohydr. Res.* 206 (2), 297–310.
- Ishii, T., Tobita, T., 1993. Structural characterization of feruloyl oligosaccharides from spinach-leaf cell walls. *Carbohydr. Res.* 248, 179–190.
- Jackman, R.L., Smith, J.L., 1996. Anthocyanins and betalains. In: Hendry, G.F., Houghton, J.D. (Eds.), *Natural Food Colorants*. Blackie Academic and Professional, London, pp. 244–309.
- Jarvis, M.C., Briggs, S.P.H., Knox, J.P., 2003. Intercellular adhesion and cell separation in plants. *Plant Cell Environ.* 26 (7), 977–989.
- Jensen, W.A., 1962. *Botanical Histochemistry*. W.H. Freeman, San Francisco.
- John, L., 1998. In: John, L. (Ed.), *Laboratory Manual for the Food Microbiology Laboratory*, 1998 ed. The University of Wisconsin, Madison, USA. <<http://www.jlindquist.net/generalmicro/324sauerkraut.html>> (Last accessed 3.11.11).
- Kalamaki, M.S., Harpster, M.H., Palys, J.M., Labavitch, J.M., Reid, D.S., Brummell, D., 2003. A. Simultaneous transgenic suppression of LePG and LeExp1 influences rheological properties of juice and concentrates from a processing tomato variety. *J. Agric. Food Chem.* 51 (25), 7456–7464.
- Kalt, W., 2005. Effects of production and processing factors on major fruit and vegetable antioxidants. *J. Food Sci.* 70 (1), R11–R19.
- Kapseu, C., Tchiegang, C., 1996. Oil composition from two types of African pear in Cameroon. Original Title: Composition de l'huile des fruit de deux cultivars de safou au Cameroun. *Fruits* 51 (3), 185–191.
- Ke, D., Saltveit, M.E., 1988. Plant hormone interaction and phenolic metabolism in the regulation of resset spotting in iceberg lettuce. *Plant Physiol.* 88, 1136–1140.
- Kende, H., 1993. Ethylene biosynthesis. *Ann. Rev. Plant Physiol. Plant Mol. Biol.* 44 (1), 283–307.
- Kende, H., Bradford, K.J., Brummell, D.A., et al., 2004. Nomenclature for members of the expansin superfamily of genes and proteins. *Plant Mol. Biol.* 55 (3), 311–314.
- Knox, J., Seymour, G.B. (Eds.), 2002. *Pectins and their Manipulation*. Blackwell, Oxford.
- Lachman, J., Orsak, M., Pivec, V., Kucera, J., 2000. Effect of the year and storage on ascorbic acid content and total polyphenol content in three apple varieties. *Czech J. Food Sci.* 18 (2), 71–74.
- Lagunas-Solar, M.C., Essert, T.K., Pina, U.C., Zeng, N.X., Truong, T.D., 2006. Metabolic stress disinfection and disinfestation (MSDD): a new, non-thermal, residue-free process for fresh agricultural products. *J. Sci. Food Agric.* 86, 1814–1825.



- Lamikanra, O., Kueneman, D., Ukuku, D., Bett-Garber, K.L., 2005. Effect of processing under ultraviolet light on the shelf-life of fresh-cut cantaloupe melon. *Food Chem. Toxicol.* 70 (9), 534–539.
- Larsen, H., Magnus, E.M., Wicklund, T., 2003. Effect of oxygen transmission rate of the packages, light, and storage temperature on the oxidative stability of extruded oat packaged in nitrogen atmosphere. *J. Food Sci.* 68 (3), 1100–1107.
- Lelievre, J.-M., Latche, A., Jones, B., Bouzayen, M., Pech, J.-C., 1997. Ethylene and fruit ripening. *Physiol. Plant* 101 (4), 727–739.
- Leuschner, R.G.K., Ielsch, V., 2003. Antimicrobial effects of garlic, clove and red hot chilli on *Listeria monocytogenes* in broth model systems and soft cheese. *Internat. J. Food Sci. Nutr.* 54 (2), 127–133.
- Lewinsohn, E., Sitrit, Y., Bar, E., et al., 2005a. Not just colors—carotenoid degradation as a link between pigmentation and aroma in tomato and watermelon fruit. *Trends Food Sci. Technol.* 16 (9), 407–415.
- Lewinsohn, E., Sitrit, Y., Bar, E., Azulay, Y., Meir, A., Zamir, D., et al., 2005b. Carotenoid pigmentation affects the volatile composition of tomato and watermelon fruits, as revealed by comparative genetic analyses. *J. Agric. Food Chem.* 53 (8), 3142–3148.
- Li, Y., Jones, L., McQueen-Mason, S., 2003. Expansins and cell growth. *Curr. Opin. Plant Biol.* 6 (6), 603–610.
- Lineback, D., 2005. Food processing: heat-formed compounds and food safety. MIFT – IUFOST Conference. Focus: Food Science & Technology Updates. 22 & 23 March 2005, Kuala Lumpur, Malaysia.
- Löfgren, C., 2000. Pectins—Structure and gel formation. A literature review (A part of a PhD thesis at the Department of Food Science, Chalmers University of Technology, Sweden).
- Manning, K., 1998. Isolation of a set of ripening related genes from strawberry: their identification and possible relationship to fruit quality traits. *Planta* 205 (4), 622–631.
- Maas, J.L., Wang, S.L., Galletta, G.G., 1995. Health enhancing properties of strawberry fruits. In: Pritts, M.P., Chandler, C.K., Crocker, T.E. (Eds.), IV Proceeding North American Strawberry Growers Conference. University of Florida Press, Cainsville, pp. 11–18.
- McCarthy, R.A., Mathews, R.H., 1994. Nutritional quality of fruits and vegetables subject to minimal processes. In: Wile, R.C. (Ed.), *Minimal Processed Refrigerated Fruits and Vegetables*. Chapman and Hall, pp. 313–326.
- McQueen-Mason, S., Durachko, D.M., Cosgrove, D.J., 1992. Two endogenous proteins that induce cell wall extension in plants. *Plant Cell* 4, 1425–1433.
- Naczki, M., Shahidi, F., 2004. Extraction and analysis of phenolics in food. *J. Chromatogr. A.*, 95–111.
- Ng, A., Waldron, K.W., 1997. Effect of cooking and pre-cooking on cell-wall chemistry in relation to firmness of carrot tissues. *J. Sci. Food Agric.* 73 (4), 503–512.
- Nguyen-The, C., Prunier, J.P., 1989. Involvement of pseudomonads in deterioration of ‘ready-to-use’ salads. *Intl. J. Food Sci. Technol.* 24, 47–58.
- Papageorgiou, G.C., Govindjee, 2004. *Chlorophyll a Fluorescence: A Signature of Photosynthesis*. Kluwer Academic, Dordrecht, London, p. 818.
- Parker, C.C., Parker, M.L., Smith, A.C., Waldron, K.W., 2003. Thermal stability of texture in Chinese water chestnut may be dependent on 8,8'-diferulic acid (aryltetralin form). *J. Agric. Food Chem.* 51 (7), 2034–2039.
- Parker, M.L., Waldron, K.W., 1995. Texture of Chinese water chestnut: involvement of cell wall phenolics. *J. Sci. Food Agric.* 68 (3), 337–346.
- Parr, A.J., Waldron, K.W., Ng, A., Parker, M.L., 1996. The wall-bound phenolics of Chinese water chestnut (*Eleocharis dulcis*). *J. Sci. Food Agric.* 71 (4), 501–507.
- Perera, C.O., Baldwin, E.A., 2001. Biochemistry of fruits. *Biochemistry of fruits and its implications on processing*. In: Arthy, D., Ashurst, P.R. (Eds.), *Fruit Processing: Nutrition, Products and Quality Management*, second ed. Aspen Publisher, Inc, Garthersburg, MD, USA.
- Perera, C.O., Kiang, K.H., 2003. Microbiological safety of minimally processed fruits. *Proceedings of the International Food Safety Conference*, vol. 3. March 24–26, Mascat, Oman. pp. 1–5.

- Perera, C.O., Belchin, L., Baldwin, E.A., Stanley, R., Tian, M.S., 2003. Effect of 1-Methylcyclopropene on the quality of fresh-cut apple slices. *J. Food Sci.* 68 (6), 1910–1914.
- Perin, C., Gomez-Jimenez, M., Hagen, L., et al., 2002. Molecular and genetic characterization of a non-climacteric phenotype in melon reveals two loci conferring altered ethylene response in fruit. *Plant Physiol.* 129 (1), 300–309.
- Philosoph-Hadas, S., Meir, A., Aharoni, N., 1991. Effects of wounding on ethylene biosynthesis and senescence of detached spinach leaves. *Physiol. Plant.* 83, 246–341.
- Pilnik, W., Voragen, A.G.J., 1989. Effect of Enzyme treatment on the quality of processed fruit and vegetables. In: Jen, J.J. (Ed.), *Quality Factors of Fruit and Vegetables*. American Chemical Society, Washington D.C..
- Quach, M.L., Melton, L.D., Harris, P.J., Burdon, J.N., Smith, B.G., 2001. Cell wall compositions of raw and cooked corms of taro (*Colocasia esculenta*). *J. Sci. Food Agric.* 81 (3), 311–318.
- Raab, C.A., 2000. *Pickling Vegetables*. Oregon State University, Pacific Northwest Extension Publication # PNW355. <<http://eesc.orst.edu/agcomwebfile/edmat/PNW355.pdf>> (Last accessed 20.01.06.).
- Rahman, M.S., 1999. Food preservation by freezing. In: Rahman, M.S. (Ed.), *Handbook of Food Preservation*. Marcel Dekker, Inc., New York, pp. 259–284.
- Rahman, M.S., Labuza, T.P., 1999. Water activity and food preservation. In: Rahman, M.S. (Ed.), *Handbook of Food Preservation*. Marcel Dekker, Inc., New York, pp. 339–382.
- Ratnayake, R.M.S., Melton, L.D., Hurst, P.L., 2003. Influence of cultivar, cooking, and storage on cell-wall polysaccharide composition of winter squash (*Cucurbita maxima*). *J. Agric. Food Chem.* 51 (7), 1904–1913.
- Redgwell, R.J., Fischer, M., Kendal, E., MacRae, E.A., 1997a. Galactose loss and fruit ripening: high-molecular-weight arabinogalactans in the pectic polysaccharides of fruit cell walls. *Planta* 203 (2), 174–181.
- Redgwell, R.J., MacRae, E., Hallett, I., Fischer, M., Perry, J., Harker, R., 1997b. In vivo and in vitro swelling of cell walls during fruit ripening. *Planta* 203 (2), 162–173.
- Reed, A.B., O'Connor, C.J., Melton, L.D., Smith, B.G., 2004. Determination of sugar composition in grapevine rootstock cuttings used for propagation. *Am. J. Enol. Vitic.* 55 (2), 181–186.
- Rodriguez-Arcos, R.C., Smith, A.C., Waldron, K.W., 2004. Ferulic acid crosslinks in asparagus cell walls in relation to texture. *J. Agric. Food Chem.* 52 (15), 4740–4750.
- Roy, S., Vian, B., Roland, J.-C., 1992. Immunocytochemical Study of the deesterification patterns during cell wall autolysis in the ripening of cherry tomato. *Plant Physiol. Biochem.* 30 (2), 139–146.
- Saltveit, M., 1999. Effect of ethylene on quality of fresh fruits and vegetables. *Postharvest Biol. Technol.* 15, 279–292.
- Sapers, G.M., Simmons, G.F., 1998. Hydrogen peroxide disinfection of minimally processed fruits and vegetables. *Food Technol.* 52 (2), 48–53.
- Sapers, G.M., Miller, R.L., Mattrazzo, A.M., 1999. Effectiveness of sanitizing agents in inactivating *Escherichia coli* in golden delicious apples. *J. Food Sci.* 64 (4), 734–737.
- Sapers, G.M., Miller, R.L., Jantschke, M., Mattrazzo, A.M., 2000. Factors limiting the efficacy of hydrogen peroxide washes for decontamination of apples containing *Escherichia coli*. *J. Food Sci.* 65 (3), 529–532.
- Sapers, G.M., Walker, P.N., Sites, J.E., Annou, B.A., Eblen, D.R., 2003. Vapor-phase decontamination of apples inoculated with *Escherichia coli*. *J. Food Sci.* 68 (3), 1003–1007.
- Schreiner, M., 2005. Vegetable crop management strategies to increase the quantity of phytochemicals. *Eur. J. Nutr.* 44 (2), 85–94.
- Sisler, E.C., Dupille, E., Serek, M., 1996. Comparison of cyclopropene, 1-methylcyclopropene and 3,3-dimethylcyclopropene as ethylene antagonists in plants. *Plant Growth Regul.* 18, 169–174.
- Smith, B.G., Harris, P.J., 1995. Polysaccharide composition of unligified cell walls of pineapple (*Ananas comosus* (L.) Merr.) fruit. *Plant Physiol.* 107 (4), 1399–1409.
- Smith, B.G., Harris, P.J., 2001. Ferulic acid is esterified to glucuronoarabinoxylans in pineapple cell walls. *Phytochem* 56 (5), 513–519.

- Snelgar, W.P., Hopkirk, G., McPherson, H.G., 1993. Predicting harvest date for kiwifruit: variation of soluble solids concentration with mean temperature. *N. Z. J. Crop Hortl Sci.* 21 (4), 317–324.
- Soliva-Fortuny, B.C., Oms-Oliu, G., Martín-Belloso, O., 2002. Effects of ripeness stages on the storage atmosphere, color, and textural properties of minimally processed apple slices. *J. Food Sci.* 67 (5), 1958–1963.
- Soliva-Fortuny, R.C., Alos-Saiz, N., Espachs-Barroso, A., Martín-Belloso, O., 2004. Influence of maturity at processing on quality attributes of fresh-cut conference pears. *J. Food Sci.* 69 (7), S290–S294.
- Stintzing, F.C., Carle, R., 2004. Functional properties of anthocyanins and betalains in plants, food, and in human nutrition. *Trends Food Sci. Technol.* 15 (1), 19–38.
- Stratford, M., Eklund, T., 2003. Organic acids and esters. In: Russell, N.J. (Ed.), *Food Preservatives*, second ed. Kluwer Academic Publishers, Dordrecht, The Netherlands, pp. 48–85.
- Sturcova, A., His, I., Apperley, D.C., Sugiyama, J., Jarvis, M.C., 2004. Structural details of crystalline cellulose from higher plants. *Biomacromolecules* 5 (4), 1333–1339.
- Talcott, S.T., Moore, J.P., Lounds-Singleton, A.J., Percival, S.S., 2005. Ripening associated phytochemical changes in mangos (*Mangifera indica*) following thermal quarantine and low temperature storage. *J. Food Sci.* 70 (5), C337–C341.
- Tay, S.L., Perera, C.O., 2004. The effect of 1-MCP and edible coatings on quality of minimally processed Baby Butterhead lettuce. *J. Food Sci.* 69 (2), FTC131–135.
- Taylor, R.W.D., 1994. Methyl bromide—Is there any future for this noteworthy fumigant? *J. Stored Prod. Res.* 30, 253–260.
- Tesoriere, L., Fazzari, M., Allegra, M., Livrea, M.A., 2005. Biothiols, taurine, and lipid-soluble antioxidants in the edible pulp of Sicilian cactus pear (*Opuntia ficus-indica*) fruits and changes of bioactive juice components upon industrial processing. *J. Agric. Food Chem.* 53 (20), 7851–7855.
- Thomas, D.J., Atwell, W.A., 1999. In: *American Association of Cereal Chemists I* (Ed.), *Starches*. Eagen Press, St Paul, Minnesota, USA, p. 94.
- Tian, M.S., Downs, C.G., Lill, R.E., King, G.A., 1994. A role for ethylene in the yellowing of broccoli after harvest. *J. Am. Soc. Hort. Sci.* 119, 276–281.
- Torriani, S., Massa, S., 1994. Bacteriological survey on ready-to-use sliced carrots. *Lebensm Wiss Technol.* 27 (5), 487–490.
- Ukuku, D.O., Pilizota, V., Sapers, G.M., 2004. Effect of hot water and hydrogen peroxide treatments on survival of *Salmonella* and microbial quality of whole and fresh-cut cantaloupe. *J. Food Prot.* 67 (3), 432–437.
- Ukuku, D.O., Bari, M.L., Kawamoto, S., Ishiki, K., 2005. Use of hydrogen peroxide in combination with nisin, sodium lactate and citric acid for reducing transfer of bacterial pathogens from whole melon surfaces to fresh-cut pieces. *Int. J. Food Microbiol.* 104 (2), 225–233.
- Voragen, F., Schols, H., Visser, R. (Eds.), 2003. *Advances in Pectin and Pectinase Research*. Kluwer Academic Publishers, Dordrecht, The Netherlands.
- Wakabayashi, K., 2000. Changes in cell wall polysaccharides during fruit ripening. *J. Plant Res.* 113 (1111), 231–237.
- Waldron, K.W., Selvendran, R.R., 1990. Composition of the cell walls of different asparagus (*Asparagus officinalis*) tissues. *Physiol. Plant* 80 (4), 568–575.
- Waldron, K.W., Ng, A., Parker, M.L., Parr, A.J., 1997a. Ferulic acid dehydrodimers in the cell walls of *Beta vulgaris* and their possible role in texture. *J. Sci. Food Agric.* 74 (2), 221–228.
- Waldron, K.W., Smith, A.C., Parr, A.J., Ng, A., Parker, M.L., 1997b. New approaches to understanding and controlling cell separation in relation to fruit and vegetable texture. *Trends Food Sci. Technol.* 8 (7), 213–221.
- Wang, S., Birla, S.L., Tang, J., Hansen, J.D., 2006. Postharvest treatment to control codling moth in fresh apples using water assisted radio frequency heating. *Postharvest Biol. Technol.* 40, 89–96.
- Watada, A.E., Ko, N.P., Minott, D.A., 1996. Factors affecting quality of fresh cut horticultural products. *Post Harvest Biol. Technol.* 9, 115–125.
- Waterhouse, A.L., 2002. Bioactive food components. Determination of total phenolics. In: Wrolstad, R.E., Acree, T.E., An, H.-J., et al., *Current Protocols in Food Analytical Chemistry*. John Wiley and Sons Inc, New York, pp. I.1–I.7.

- Wedzicha, B.L., Lamikanra, O., 1983. Sulphide mediated oxidation of beta carotene: a partial characterization of reaction products. *Food Chem.* 10, 275–283.
- Wehrer, C., Bindler, F., Laugel, P., 1984. Interactions between polyphenols and stannous ions in canned fruits and vegetables. A quantitative approach. *Dtsch. Lebensm Rund* 80 (9), 273–279.
- Wende, G., Waldron, K.W., Smith, A.C., Brett, C.T., 2000. Tissue-specific developmental changes in cell-wall ferulate and dihydroferulates in sugar beet. *Phytochem* 55 (2), 103–110.
- Whitaker, J.R., Lee, C.Y., 1995. Recent advances in the chemistry of enzymatic browning. In: Walker, J.R., Lee, C.Y. (Eds.), *Enzymatic Browning and its Prevention*. American Chemical Society, Washington, D.C., pp. 3–7.
- Wyatt, S.E., Carpita, N.C., 1993. The plant cytoskeleton-cell-wall continuum. *Trends Cell Biol.* 3 (12), 413–417.
- Yamasaki, M., Yasuri, T., Arima, K., 1964. Pectic enzymes in the clarification of apple juice. Part 1. Study on the clarification reaction in a simplified mode. *Agric. Biol. Chem.* 28 (11), 779–787.
- Zulhendri, F., Jamieson, L.E., Feng, J., Perera, C.O., Quek, S.Y., Woolf, A.B., 2012a. A preliminary study on the effect of metabolic stress disinfection and disinfestation (MSDD) on ripening physiology and quality of kiwifruit and apple. *Postharvest Biol. Technol.* 63 (1), 50–54.
- Zulhendri, F., Jamieson, L.E., Perera, C.O., McDonald, R.M., Connolly, P.G., Quek, S.Y., et al., 2012b. The effect of metabolic stress disinfection and disinfestation (MSDD) on ‘Hass’ avocado fruit physiology and mortality of longtailed mealybug (*Pseudococcus longispinus*). *Postharvest Biol. Technol.* 64, 138–145.

This page intentionally left blank

# Food Drying and Evaporation Processing Operations

William L. Kerr

University of Georgia, GA, USA

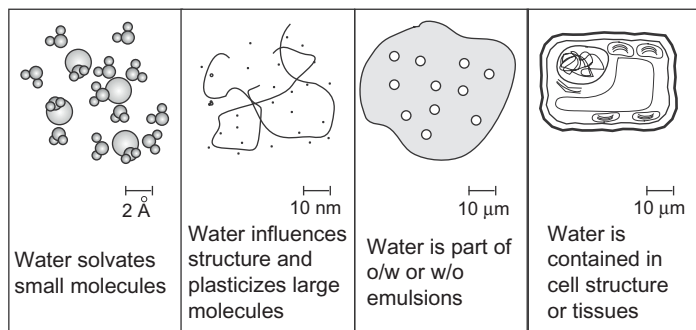
## 1. INTRODUCTION

Removing water is an effective means of preserving food and reducing the costs of transportation and storage. Two principal methods have been developed to accomplish this, drying and evaporation. Drying, or dehydration, is used to remove relatively large amounts of water from foods, and is accomplished by imposing a difference in water activity between the food and its surroundings. Evaporation is used to concentrate liquid foods, as water in the food reaches the boiling point and escapes into the surroundings.

## 2. WATER IN FOODS

Water is the most ubiquitous component of food and biological materials, and has a profound effect on the quality, physical properties, and safety of food. Water serves as the environment in which salts, sugars, acids, peptides, and other relatively small hydrophilic molecules are dissolved (Figure 12.1). For example, sucrose, fructose and citric acid may be dissolved in the water present in an orange. Lipophilic molecules, including oils, flavors, and colorants, do not dissolve in water, but may participate in an emulsion system with water. For example, in homogenized milk the fat is distributed in a series of small spherical globules, in the order of 1–5  $\mu\text{m}$  in diameter, in an aqueous phase containing dissolved minerals, sugars, and peptides.

Foods also contain macromolecules that do not dissolve in water, including some proteins, polysaccharides, and nucleic acids. Water still plays an intricate role in the function, structure, and properties of these molecules, although this role can be quite complex. The conformation of enzymes, and thus their function, is highly dependent on the amount of water as well as the ionic content and pH of the surrounding aqueous milieu. Most enzyme reactions are quite slow at low moisture levels.

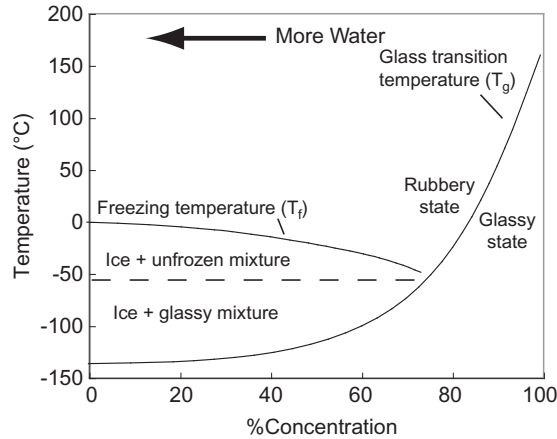


**Figure 12.1** Various roles of water in food products.

Water also interacts with large macromolecular bodies, including suspended colloidal particles and gels. Water may serve as a “plasticizer,” increasing the flexibility of molecules. At a molecular level, water increases the empty spaces in which larger molecules are free to move, thus making the system more likely to flow. These empty spaces are referred to as “free volume.” In dense polymeric systems, the molecular chains are highly constrained because of entanglements among chains. Water separates the side groups and chains of larger molecules, allowing easier reptation, the snake-like movement of polymer chains past each other. On a macroscopic level, this has a profound effect on the rheological and textural properties of the material. For liquid foods, increased moisture reduces the viscosity, thereby enhancing the free flowing properties of the food. For semi-solid and networked foods, increased moisture decreases the firmness, such as that measured by the elastic modulus, and enhances the flexibility. The degree to which water is a “good solvent,” also influenced by the pH and ionic strength, may drive the assembly of gels and other molecular networks.

Many food molecules may form non-crystalline solid states at low moisture content. These states are characterized by molecules with relatively random orientations, and in which the molecules do not freely move past each other. These are often referred to as glassy systems. The temperature of the food system may be increased to a point, the glass transition temperature, at which thermal energy allows molecular motions to occur. The material passes from a solid, inflexible state to a mobile one. For example, a hard candy at 20°C is very hard and brittle, whereas at 60°C it may be spongy or even flow. As noted above, water also increases the mobility of molecular systems. Another way of looking at this is that water decreases the glass transition temperature of the system (Figure 12.2). Thus, a dry pasta noodle is brittle and inflexible, whereas a hydrated noodle is flexible and rubbery.

Other physical states are also determined by the moisture content of a food system. The formation of crystalline materials, typically of sugars or salts, is encouraged at progressively lower moisture contents. For example, the sugar lactose present in milk



**Figure 12.2** *The effect of water on physical states in foods.*

may crystallize when less water is available. This may lead to undesirable grittiness in ice cream or dried milk products.

A variety of physical properties are influenced by the water content of foods. In general, higher moisture content leads to lower viscosity, greater flexibility, higher water activity, higher freezing point, lower boiling point, lower osmotic pressure, higher specific heat, and greater thermal conductivity.

### 3. TYPES OF WATER IN FOODS

It is believed by many that more than one dynamic water structure exists in biological materials at the microscopic level. These various domains of water structure influence biological activity as well as the processing of foods to remove or freeze water. As both drying and evaporation involve the mass transfer of water, and the application of heat to transform water from a condensed to a gaseous state, having various forms of water will affect these processes. There are many experimental observations that suggest the existence of more than one type of water. Calorimetry, for example, shows that there remains a portion of unfrozen water in systems, even at tens of degrees below the equilibrium freezing temperature. NMR studies show that there are often two or more domains of water with different relaxation time constants. This indicates that these regions of water have different rates of rotational motions. During later phases of drying, there is a portion of water that requires more energy to remove, and indeed may not be removable except by freeze drying.

A traditional model for explaining these results purports that water exists in “bound” and “bulk water” phases (Figure 12.3). The term bound suggests that this fraction of water has greater binding affinity for the polar or ionic groups on proteins and polysaccharides,



and thus requires additional energy to dissociate from these groups than from other water molecules in the bulk phase. This probably is not the case. It may also be postulated that additional layers of structured water exist outside of the first layer, or that there is a continuum of water of different degrees of binding from the first bound layer to the bulk phase. Some dispute that there is truly water that has higher binding energy, and alternative theories have been developed. For example, one hypothesis suggests that water exists in low density (LDW,  $\sim 0.91$  g/ml) and high density (HDW,  $\sim 1.2$  g/ml) states. In LDW, H atoms lie in a straight line between O atoms on adjacent molecules. In HDW, the hydrogen bonds are slightly bent, allowing the adjacent O atoms to approach more closely.

The ultrastructural features of biological materials may lead to compartmentalization of water. This also affects drying, and, to a lesser extent, evaporation processes. As a variety of different materials are dried, such as fruits, vegetables, meats, dairy products and coffee, no universal description is possible. In foods consisting of biological tissues, a wide range of features influence the ability of water to diffuse through the structure and to the surface, where it is transformed from liquid to gas (Figure 12.4). Water is

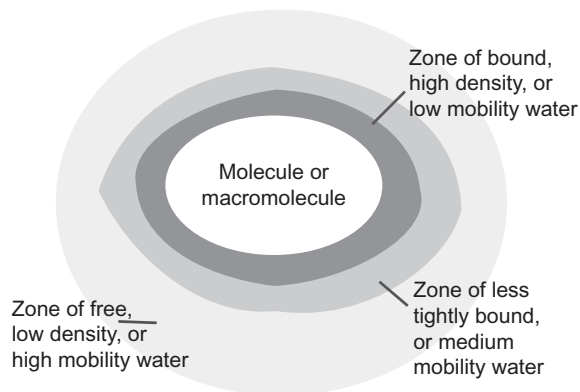


Figure 12.3 Proposed states of water near food molecules.

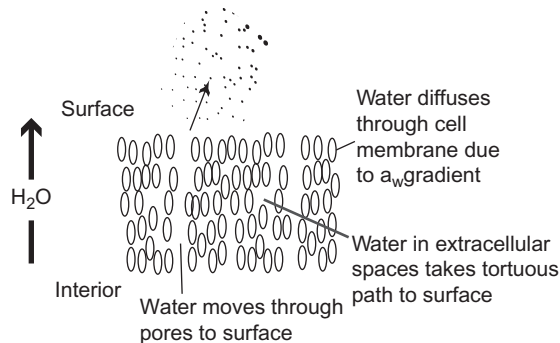


Figure 12.4 Movement of water from product interior to the surface during drying.

often compartmentalized in the cell cytoplasm or cell organelles, and must move by diffusion through the cell membrane, or, in the case of damaged cells, around cell wall and membrane fragments. Extracellular water may be trapped in spaces between cells, and must follow a tortuous path to reach the surface of the food.

#### 4. FOOD STABILITY AND MOISTURE RELATIONSHIPS

As most fresh foods contain considerable water, and a variety of macro- and micro-nutrients, they are very susceptible to attack by microorganisms, including bacteria, yeasts, and molds. These organisms may result in spoilage, evidenced by the deterioration of desirable texture and flavor, or in the production of toxins that threaten the health of consumers. The growth of microorganisms is dependent on the amount of moisture in the food, and this has led to the historical development of preservation mechanisms, including salting, pickling, drying, evaporation, chilling, and freezing.

Interestingly, absolute moisture content is not the best predictor of the susceptibility of a food to microbial attack. A better measure is the water activity of the food, defined as  $a_w = \gamma X_w$ , where  $X_w$  is the mole fraction of water and  $\gamma$  is the activity coefficient, a measure of non-ideal solution conditions. A more practical definition uses the ratio of the vapor pressure of water above the food ( $p$ ) compared to that of pure water ( $p_o$ ) at the same temperature:

$$a_w = \frac{p}{p_o} \quad [12.1]$$

It is customary to plot moisture content versus  $a_w$ , at a given temperature, to form the equilibrium moisture isotherm. This relationship is unique for each food and typically takes one of three general shapes (Figure 12.5). Very hygroscopic materials show

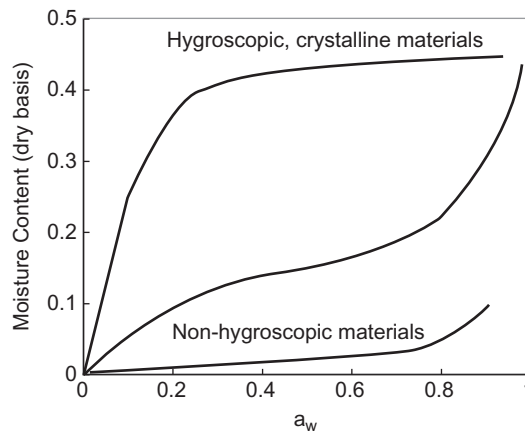
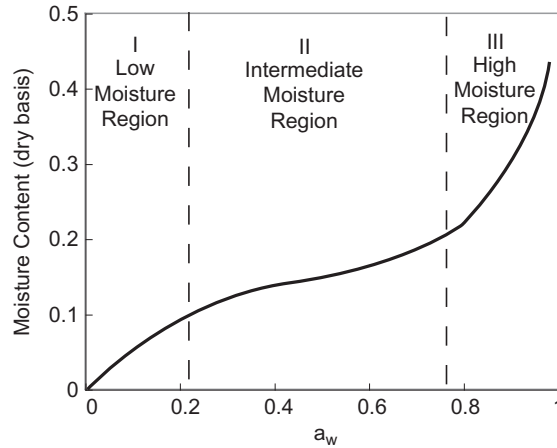


Figure 12.5 Typical moisture isotherms for food products.



**Figure 12.6** Low, intermediate, and high moisture regions of foods.

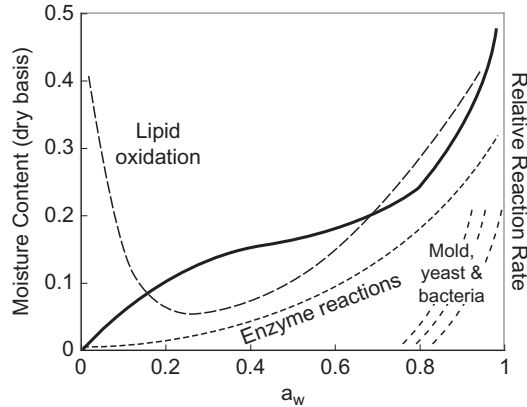
a marked increase in moisture content at progressively higher  $a_w$ , whereas moderately hygroscopic materials show a leveling off of moisture content in intermediate  $a_w$  regions. Low hygroscopic materials show little increase in moisture content with  $a_w$ , until higher  $a_w$  regions are attained. The isotherm attained from moisture sorption to a dry material often does not coincide with that attained through desorption of a high moisture material. This phenomenon is known as hysteresis.

Not everyone ascribes to the use of moisture isotherms to describe dynamic food systems. The concept of water activity and moisture isotherms is based on thermodynamic descriptions of equilibrium systems. Foods are, in fact, changing systems, and the water content may not be at an equilibrium value. The fact that hysteresis occurs is just one example that equilibrium conditions are not always present.

Foods often are described as low moisture (roughly  $a_w < 0.3$ ), intermediate moisture ( $a_w$  between 0.3 and 0.8), and high moisture ( $a_w > 0.8$ ). One theory suggests there are three parts of moisture sorption or desorption isotherms (Figure 12.6). In region I ( $a_w < 0.2$ ), moisture is bound by adsorption and chemisorption, and the apparent transition heat is greater than that of bulk water. In region II, dissolution of chemical constituents occurs, and greater mobility is attained. In region III, water fills the interstitial spaces in the food, and structural aspects of the food limit moisture removal.

As a rough guide, bacteria do not grow on foods at  $a_w$  below 0.8, yeast at  $a_w$  less than 0.75, and molds at  $a_w$  less than 0.7 (Figure 12.7). This depends, however, on the particular food and microorganism considered. Although microbial growth may be limited at lower  $a_w$ s, existing microorganisms may survive drying processes.

Figure 12.7 shows another important aspect of moisture and food stability. It is generally found that deteriorative enzymatic reactions decrease with decreasing  $a_w$ , highlighting another important aspect of drying preservation. Reactions related to



**Figure 12.7** Relative rates of deteriorative reactions in foods as a function of water activity.

enzymatic browning, flavor deterioration, and breakdown of structural polysaccharides proceed more slowly at low  $a_w$ . Non-enzymatic browning, related to interactions between amines and reducing sugars, also proceeds more slowly at low  $a_w$ . An important consideration, however, is that of lipid oxidation, a key deteriorative process in lipid-containing foods. Although lipid oxidation decreases with  $a_w$  to about  $a_w = 0.2$ , it dramatically increases at even lower  $a_w$ . Therefore, removing too much moisture may, in some cases, be undesirable.

The properties of low moisture foods are sometimes understood in terms of glass transition theory. According to this approach, materials below the glass transition temperature ( $T_g$ ) are amorphous solids in which long-range motions or molecular flexibility are extremely slow. Glassy materials are typically dry, hard, and inflexible. Above  $T_g$ , there is increased thermal energy, and the material becomes flexible or rubbery. At higher temperatures, the material may even flow. The situation is made more complex by the fact that water acts as a plasticizer for food materials, increasing the ability of molecules to move at a given temperature. Thus, the  $T_g$  of a material depends on the moisture content, and the greater the moisture content, the lower the  $T_g$ . These relationships are sometimes described in terms of a state diagram for the system (Figure 12.2).  $T_g$  values can be determined by differential scanning calorimetry or mechanical thermal analysis. These are of practical use, as the  $T_g$  is often correlated with important physical properties, such as the transition between crisp or non-crisp cereals, dry or caked powders, or the onset of sugar crystallization.

## 5. DRYING: DESCRIBING THE PROCESS

It is obvious, then, that one way of preserving food against microbiological and chemical deterioration is by reducing the water content so that the water activity of the

material is below approximately 0.7–0.8. Drying, perhaps better-termed dehydration, is one means of removing moisture from food. One definition of food drying is the removal of water by mass transfer from a food product. Most commonly, this occurs as liquid water in the product moves to the surface and is transformed to a gas as it is carried away. In the case of freeze drying, however, ice in the product is sublimated directly to the gaseous phase. In osmotic dehydration, liquid water is drawn out of the product by osmosis, and remains a liquid.

### 5.1 Psychrometrics

Most common dehydration processes use hot air as the drying medium. The air delivers heat to the product to evaporate moisture. In addition, the air must have a lower water activity, compared to the food, in order for moisture to move from the food and into the surrounding air. Obviously, then, the properties of air are critical to drying, and these are most easily understood by psychrometric relationships. Dry air contains approximately 78% nitrogen and 21% oxygen, as well as lesser amounts of argon, carbon dioxide, and a variety of other gases. Air can be understood as a solution of dry gases in constant proportion and water vapor in various amounts. The psychrometric chart (Figure 12.8), or related computer programs, shows the thermodynamic properties of air in various conditions. In order to use this chart, the user must know at least two properties of the air. Often these are the ambient temperature

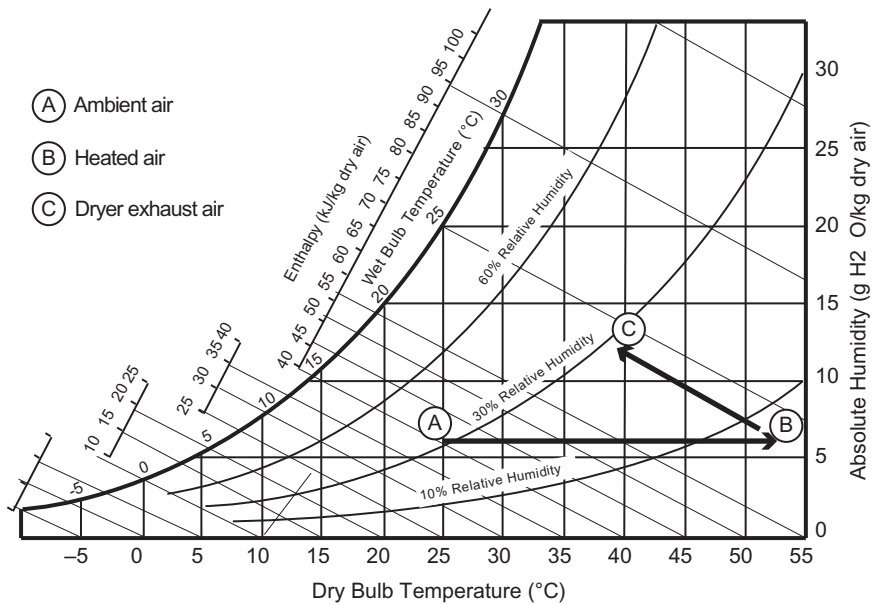


Figure 12.8 Psychrometric properties of air at 101.32 kPa.

(the dry bulb temperature) and the wet bulb temperature (the temperature assumed by a thermometer covered with a wet sock and past which air is moved at high velocity), but may include some other easily measured property such as relative humidity. Among the properties critical to drying are the absolute humidity (grams of water per gram of dry air), the enthalpy or heat content (J/g dry air), the specific volume ( $\text{m}^3/\text{g}$  dry air), and the relative humidity. The relative humidity is 100 times the vapor pressure of water in the air compared to that of pure water at the given temperature. As such, it is equivalent to the water activity of the air.

## 5.2 Drying Curves and Mechanisms of Drying

During drying, moisture moves from the internal regions of the product to the surrounding air. This occurs through several mechanisms that depend on the structure of the food and the stage of drying. Free water near the surface of the product is most easily removed by evaporation, where it moves by gaseous diffusion to the surrounding air. As porous spaces near the surface empty, capillary or other forces may draw water up from deeper regions. Water may also move by liquid or gas diffusion from regions of high to low water activity.

Drying is often monitored by measuring the weight of a food sample as a function of time (Figure 12.9). If the initial wet basis moisture percent ( $M_o$ ) is known, the amount of solids ( $S$ ) can be calculated from the initial total weight ( $W_o$ ), as  $S = W_o(100 - M_o)/100$ . From the weight  $W_i$ , at time  $i$ , the data can be converted to the dry basis moisture content:

$$X_w = \frac{W_i - S}{S} \quad [12.2]$$

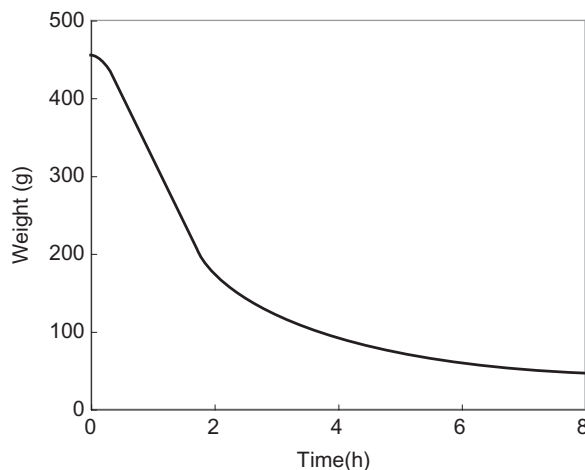
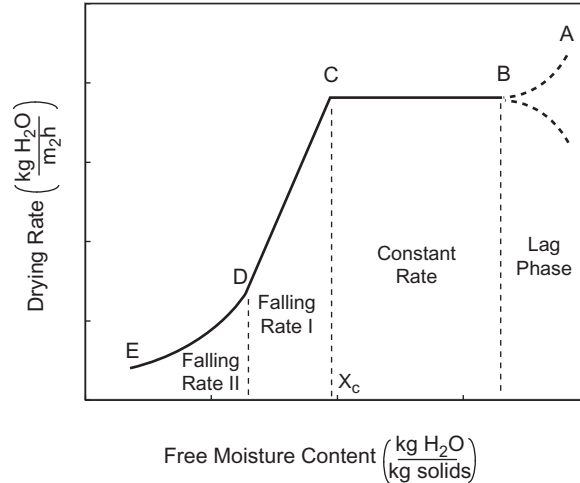


Figure 12.9 Change in weight or moisture content with drying time.



**Figure 12.10** Drying rate versus moisture content.

The so-called free moisture is often used, and is given by  $X_f = X_w - X_e$ , where  $X_e$  is the moisture content at equilibrium. The rate of drying,  $R \propto dX/dt$ , is found by differentiating the curve of moisture versus time. More often, this is written as:

$$R = - \left( \frac{S}{A} \right) \left( \frac{dX}{dt} \right) \quad [12.3]$$

where  $A$  is the surface area of product exposed to drying. A plot of drying rate versus time (or moisture content) shows that the rate of drying changes during the course of drying (Figure 12.10), and can often be separated into several drying regimes. Sometimes, there is a short initial lag phase (A-B), in which the drying increases or decreases. This is usually followed by a constant rate period (B-C), during which the drying rate is constant. This occurs as the product surface remains saturated with water, and water evaporates freely from the surface. The product surface stays at the wet bulb temperature, and the drying rate can be expressed in terms of either the rate of heat transfer or mass transfer occurring at the surface:

$$\begin{aligned} R_c &= h(T_a - T_w) / \Delta H_v \\ &= k_w M_b (H_w - H_a) \end{aligned} \quad [12.4]$$

where  $h$  is the heat transfer coefficient and  $k_w$  the mass transfer coefficient for transfer across the boundary layer from the product surface to the surrounding air. The driving force for heat transfer comes from the difference in temperature between the air ( $T_a$ ) and the product surface at the wet bulb temperature ( $T_w$ ), whereas that for mass transfer comes from the difference in humidity of the air ( $H_a$ ) and product surface ( $H_w$ ).

$M_b$  is the effective molecular weight of air and  $\Delta H_v$  the latent heat of vaporization for water at  $T_w$ . It has been noted that many food and agricultural materials do not display a constant-rate drying period.

As the product continues to dry, the critical moisture content ( $X_c$ ) is reached, at which point the drying rate begins to decrease. At this point, the rate of drying is determined by the rate at which moisture moves as a liquid or gas from within the product to the surface, typically through capillaries, intercellular pockets, or other void spaces. It should be noted that during the course of drying these spaces most likely shrink with the product, thus making theoretical models of falling rate drying more difficult to construct. More than one falling rate period may be observed (such as C-D and D-E). During the first falling rate period, some wet spots may still be present, whereas during subsequent periods the liquid–vapor interface recedes within the product. During later drying, diffusion of vapor becomes more prominent, and the energy needed to transfer liquid water into vapor may increase.

Several mechanisms for moisture movement from within the product have been described. Technically, diffusion of moisture is governed by Fick's law. For unsteady-state diffusion in one dimension (along the x axis), this takes the form:

$$\frac{dX}{dt} = D_s \frac{\partial^2 X}{\partial x^2} \quad [12.5]$$

which predicts that the change in moisture with time depends on the moisture gradient and the diffusion coefficient ( $D_s$ ). This most accurately describes diffusion along a surface. For liquid diffusion in three dimensions, this takes the more general form:

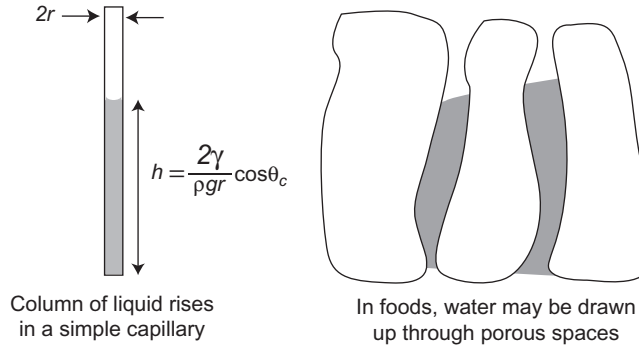
$$\frac{dX}{dt} = D_e \left[ \frac{\partial^2 X}{\partial x^2} + \frac{\partial^2 X}{\partial y^2} + \frac{\partial^2 X}{\partial z^2} \right] \quad [12.6]$$

Ostensibly, water diffuses within capillaries, pores, and other void spaces. Because of changing structure, diffusion mechanisms, temperatures, and solute concentrations, the diffusion coefficient is not likely to remain constant during drying, although an effective diffusion coefficient is sometimes considered in drying calculations. Fick's law can most readily be solved for regular geometries:

$$\text{Sphere} \quad \frac{X - X_s}{X_e - X_s} = \frac{6}{\pi^2} \sum_{n=1}^{\infty} \frac{1}{n^2} \exp\left(\frac{-n^2 D_e t}{r_s^2}\right) \quad [12.7a]$$

$$\text{Slab} \quad \frac{X - X_s}{X_e - X_s} = \frac{8}{\pi^2} \sum_{n=1}^{\infty} \frac{1}{(2n-1)^2} \exp\left(\frac{-(2n-1)^2 \pi^2 D_e t}{4L^2}\right) \quad [12.7b]$$





**Figure 12.11** *Capillary forces in drying.*

$$\text{Cylinder} \quad \frac{X - X_s}{X_e - X_s} = \frac{4}{r_c^2} \sum_{n=1}^{\infty} \frac{1}{\beta_n^2} \exp(-\beta_n^2 D_e t) \quad [12.7c]$$

where  $X$  is the moisture content at time  $t$ ,  $X_s$  the surface moisture content,  $r_s$  and  $r_c$  are the sphere or cylinder radius,  $L$  the slab thickness, and  $\beta_n$  are Bessel functions. An effective diffusion coefficient can be estimated from experiments by plotting the moisture ratio  $\ln[(X - X_s)/(X_e - X_s)]$  versus time.

Liquid water may also move to the product surface by capillary flow (Figure 12.11). Adhesive forces between water and a solid surface cause it to wet the surface. On hydrophilic surfaces, water would tend to creep higher and higher along the surface wall if not held back by cohesive forces with water molecules away from the surface. As water evaporates near the surface of a product, capillary forces can help move water through porous spaces towards the drying surface. In the static case, a liquid will rise up a tube to a height,  $h$ , according to:

$$h = \frac{2\gamma}{\rho g r} \cos\theta_c \quad [12.8]$$

where the surface tension ( $\gamma$ ) is a measure of cohesive forces in the water, and the contact angle ( $\theta_c$ ) measures the adhesion of water to the solid surface. The density ( $\rho$ ) and gravitational constant ( $g$ ) come into play when the liquid rises against the force of gravity. This equation shows that the liquid will move farther as the capillary radius ( $r$ ) decreases. In a drying product, the geometry and forces at work are more complex. The difference in pressure between the water ( $P_w$ ) and air ( $P_a$ ) at the interface is important. Capillary flow can be expressed as:

$$\frac{1}{A} \frac{\partial X}{\partial t} = K \left[ \vec{x} \frac{\partial X}{\partial x} + \vec{y} \frac{\partial X}{\partial y} + \vec{z} \frac{\partial X}{\partial z} \right] \quad [12.9]$$

where the constant  $K$  is given by

$$K = \frac{\gamma \cos \theta_c}{4\pi r^2 f(r) \eta \int r^2 f(r) dr} \quad [12.10]$$

Here the function  $r^2 f(r)$  accounts for the fact that there is a distribution of pore sizes in the product. In some cases, diffusive and capillary flow mechanisms can be distinguished by making a semilog plot of the unaccomplished moisture content ( $X/X_c$ ) versus time.

Once moisture is diminished, gaseous diffusion of water may become important. This is governed by Knudsen diffusion:

$$\frac{dX}{dt} = -\varepsilon \tau \zeta \rho D_k \quad [12.11]$$

where  $\varepsilon$  measures the degree of porosity,  $\tau$  the twistedness of the diffusion path (tortuosity),  $\zeta$  is a geometric indicator, and  $\rho$  represents the vapor density. For gases, the diffusion coefficient is given by:

$$D_k = \frac{2d}{3} \left( \frac{2RT}{\pi M_w} \right)^{0.5} \quad [12.12]$$

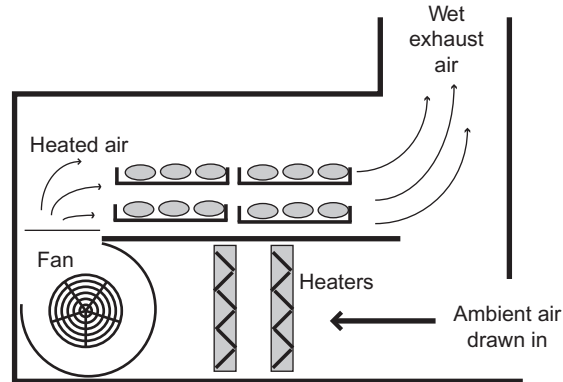
where  $d$  is the average pore diameter,  $R$  the universal gas constant,  $T$  the Kelvin temperature, and  $M_w$  the molecular weight of water. Although Knudsen diffusion describes the diffusion of gas through fixed porous channels, it is highly possible that water vapor diffuses away from a liquid interface whose position changes with time. For example, water may evaporate from the surface of a fixed volume of liquid water in a tube. As it does so, the position of the interface recedes. This mechanism is most often described by Stefan diffusion. This is a combined heat and mass transfer problem as heat is supplied to the liquid to evaporate water, which is then carried away.

## 6. TYPES OF DRYERS

A wide variety of unit operations exist to dry food products. These may be classified loosely as hot air dryers, freeze dryers, and osmotic dryers. There are, of course, many variations of dryers within each broad category.

### 6.1 Hot Air Dryers

Hot air dryers are perhaps the most widely used of food dryers. In this type of dryer, air is drawn in by a fan and passed across a bank of heaters (Figure 12.12). Electrical coils, steam heat exchangers, natural gas burners, or other methods can supply heat. The air continues at relatively high velocity (1–10 m/s) and passes past the product,



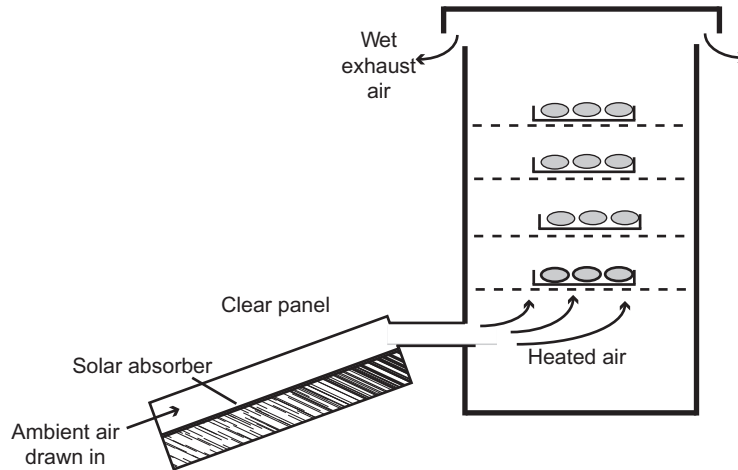
**Figure 12.12** Batch type hot air dryer.

where it provides heat for evaporation and carries away moist air. Normally, a length of tunnel exists between the heaters and food to ensure uniform temperature. The heating of air occurs at constant absolute humidity as shown in the psychrometric chart (Figure 12.8). Note that the heat needed to increase the temperature of air a given amount is easily found from the chart. During constant rate drying, the process is approximately adiabatic. Heat provided by the air is returned as evaporated moisture enters the air. During this period, drying follows constant enthalpy conditions, and the product remains at the wet bulb temperature (Figure 12.8). During falling rate periods, heat provided by the air is greater than that returned to it, and the product temperature begins to increase. Typical hot air dryers are operated at between 40°C and 80°C.

## 6.2 Sun or Solar Drying

In one of the oldest methods of drying, food items are set outside on trays to dry in the sun. As fruits have high sugar and acid, they are less perishable, and thus best suited to sun drying, as long as humidity levels are not too high. Sun dried raisins or tomatoes are perhaps the best-known products, but other fruits can be sun dried as well. In general, an air temperature above 85°F and humidity less than 60% is required for successful drying. In addition, a constant breeze is advantageous. Thus, sun drying is not suited to all regions, and may be limited due to adverse weather.

In solar dryers, radiant energy from the sun penetrates a glass panel and is collected on a flat back panel, which heats air moving past it (Figure 12.13). Air moves in by natural convection, or may be forced in by fans. The heated air passes by the commodity to be dried. Generally, the drying rate is faster than for direct sun drying. As the food is in a separate and covered chamber, it is protected from animals and insects. In addition, the food is not subject to direct radiation that can be harmful to some



**Figure 12.13** *Solar air dryer.*

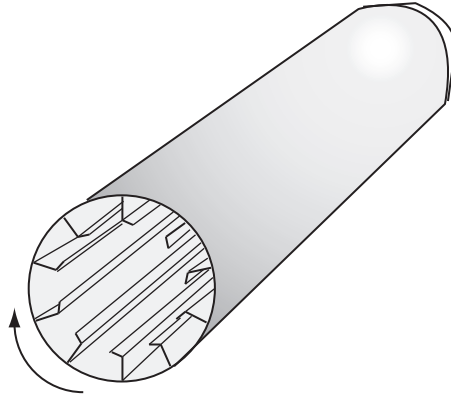
foods, particularly those that are UV-sensitive. The low capital and utility costs make solar drying attractive in poorer countries. Several fruits and vegetables have been successfully dried in this manner, including prunes, peaches, tomatoes, and peppers.

### 6.3 Batch Dryers

In batch dryers such as tray or rotary dryers, food is loaded onto trays in a chamber and left until drying is complete. In cabinet dryers, a series of trays containing the food are stacked in an insulated cabinet, with sufficient space between trays to allow airflow (Figure 12.12). Air enters the cabinet, is heated and is forced parallel to the trays, then exits. Baffles are usually provided to direct air and prevent mixing of entrance and exit air streams. Although simple in design, cabinet dryers have limited throughput, and drying is often not uniform throughout the drying space. In some cases, the trays are rotated manually to encourage more uniform drying. They are most suited for small or medium production runs, or for pilot facilities. Drying times are determined by the period between product loading and unloading. Relatively thin products including fruits, vegetables, meats, or confections are tray dried.

### 6.4 Rotary Dryers

For particulate solids, a rotary dryer may help promote uniform and more rapid drying (Figure 12.14). In the rotary cascade dryer, the material is placed in a rotating cylinder through which a hot air stream is passed. Flights on the cylinder wall lift and cascade the product through the air. In a variant, louvres are used instead of flights so that the product is mixed and rolled instead of dropped. The dryer is typically sloped, so that the product enters and gradually falls towards the discharge end. In direct



**Figure 12.14** *Action of a rotary dryer.*

rotary dryers, the air is passed through burners, and directly comes in contact with the product. Rotary dryers have been used to dry seeds, corn gluten, distiller's grains, and some fruit.

## 6.5 Vacuum Dryers

A vacuum system may be connected to a cabinet dryer to lower the vapor pressure of water in the space surrounding the food, and thus enhance mass transfer of water out of the food. In addition, the lower pressure reduces the boiling point, and provides a greater temperature difference between product and surroundings. The reduced oxygen environment is also useful for products prone to quality loss from oxidation reactions. The leak-proof vacuum system requires higher precision engineering, thus greater equipment costs are expected. In addition, change-over times are greater because of the need to pull and release vacuum.

Drying periods may be longer, however, as conduction of heat from the heated side wall through the rarefied air may be limiting. In one variant, microwaves are used to assist the heating process. A series of magnetrons surrounds the drying chamber. As heating occurs by radiation, heat transfer rates are very rapid. Typically, microwaves at 2.45 GHz are used, and absorption of energy occurs in the rotation of water molecules. Heat transfer by conduction through the product is also by-passed, so that rapid heating from within can occur. As low moisture in the product is attained (<15%), the efficiency of microwave absorption decreases. Attaining low moisture products may be difficult unless the solid material can convert the microwave energy. Vacuum drying has been used on a variety of products including strawberries, broccoli, bananas, and herbs.

To overcome the limitations of batch processing, continuous belt vacuum dryers have been developed (Figure 12.15). Product enters through an airlock and is

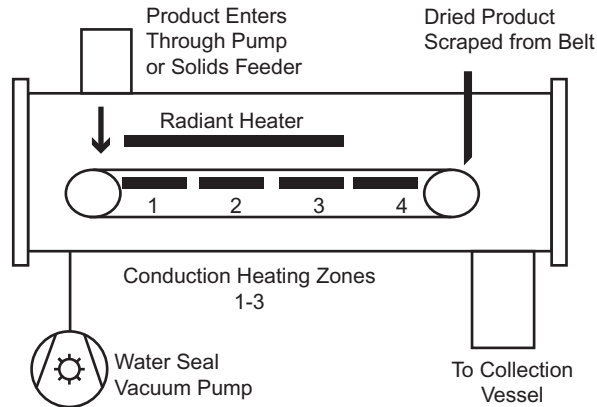


Figure 12.15 *Continuous belt vacuum dryer.*

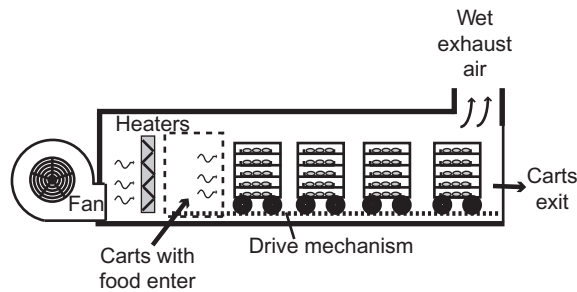


Figure 12.16 *Continuous tunnel dryer.*

deposited on a conveyor belt. The belt passes over a series of conduction heaters, and may also be exposed to microwave or other radiant energy. Drying times can be in the order of 30–90 min. At the end of the belt, the product is scraped off *in vacuo* into a collection vessel. Continuous vacuum drying has been used with mango pulp, blueberries, and various fruit pomaces to produce high nutrient fruit powders.

## 6.6 Tunnel Dryers

To improve product throughput, continuous dryers have evolved. In the tunnel dryer, one or more insulated chambers 10–15 m long are provided, through which a floor-mounted drive moves a series of trolleys, providing semi-continuous movement (Figure 12.16). The food product is often loaded manually onto shelves on the trolleys, and the trolleys engaged in the floor drive. Dryer air enters at one end of the tunnel and flows across the product. Tunnel dryers may be either cocurrent or countercurrent. In the cocurrent models, the air stream travels in the same direction as the

product. Thus, the wettest, and coolest, product experiences the hottest, least humid, air. This configuration encourages rapid drying in initial phases, where the product stays near the wet bulb temperature. The driest product near the end of the tunnel experiences lower temperature air, therefore it may experience less quality changes such as browning or case-hardening. In countercurrent dryers, the air stream enters opposite to product movement. One advantage is that the driest, highest temperature air contacts the lowest moisture product, from which moisture is hardest to remove. Many products can be tunnel dried including papaya, onions, strawberries, hazelnuts, and peppers.

## 6.7 Belt Dryers

For materials that can fit on a conveyor belt, the belt dryer is convenient. Food product is moved through a drying tunnel on a perforated belt. The conveyor belt may pass back and forth in order to minimize the dryer footprint. It is also possible to have a spiral belt, in which product is conveyed in a spiral up or down through the drying chamber. These dryers may be cocurrent, countercurrent, or incorporate separate zones of both drying types. Alternately, the air stream may be cross-current and directed through the belt either from above or from underneath it. The cross-flow configuration may have multiple zones with differing air speeds or temperature profiles.

## 6.8 Fluidized Bed Dryers

The fluidized bed dryer is useful for sufficiently small semi-solid food pieces, with sizes ranging from 50  $\mu\text{m}$  to 5 mm. Products include dried powders and granules, as well as peas, blueberries, or seeds. Here, the product is held aloft in a high velocity hot air stream, thus promoting good mixing and heat transfer for uniform and rapid drying (Figure 12.17). The air passes through a perforated plate from underneath the food and suspends it. Particulate pieces are fed in one end and from above, and help to push along pieces already in the dryer, where they exit at the other end. This is encouraged by the fact that lower moisture pieces have lower mass and density. The process has good thermal efficiency and limits overheating of individual pieces.

## 6.9 Impingement Dryers

In impingement drying, air is directed through tubes or nozzles to strike the food pieces at high speed (Figure 12.18). This creates turbulent flow near the product surface, which greatly enhances the rate of heat and mass transfer. Air can impinge the product from above, below, or both directions. The food may or may not become fluidized. Impingement drying has been used for baked goods, pet treats, and blueberries. Higher temperatures are used if baking or browning is desired.

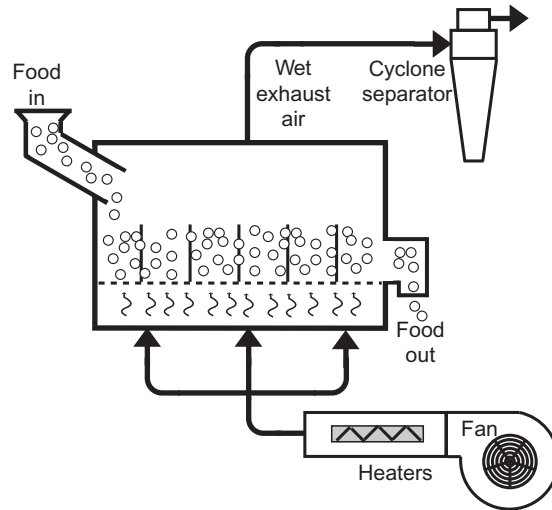


Figure 12.17 Fluidized bed dryer.

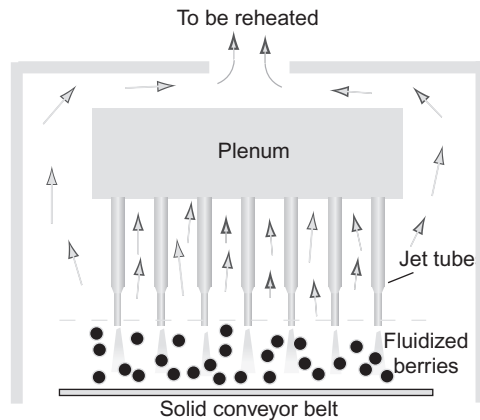


Figure 12.18 Cross-section of impingement drying.

## 6.10 Puff Drying

In puff drying, small pieces are placed in a high pressure and temperature environment for a short time. At elevated pressures, water can remain as a liquid even above 100°C. The pieces are transferred to atmospheric pressure, at which point water rapidly flashes from the product. This leaves a very porous product that is easily rehydrated. This can be particularly useful for small fruit or vegetable pieces that have long falling rate periods and are subject to extensive shrinkage and hardening. Products such as diced carrots do well with puff drying, creating a product with minimal browning and which rehydrates well when placed in water.



## 6.11 Drum Drying

In drum drying, a food paste or slurry is applied directly to one or more heated rotating drums (Figure 12.19). A variety of means may be used to apply the food to the drum surface. In one version, a number of applicator rolls over the drum apply the material, and the position between applicator and drum controls the width of the food layer. In some cases, a single applicator is used beneath the drum. In another version, the food is pumped or sprayed into the nip between two drums, and the thickness of the food film is determined by the spacing between the drums. Drying time is determined by the speed of rotation. Typically, a flaky product is scraped off one end of the dryer. One obvious advantage to the drum dryer is that it provides good heat transfer rates, as heating occurs through direct conduction with the product. However, it is limited to products that can be formed into a paste or slurry. Such food items include cereal flakes, dried baby foods, potato flakes, and fruit pulps.

## 6.12 Spray Drying

Spray drying offers a very useful way of converting liquid food items into powders and other small, dry particles. A spray drying system includes a feed pump, an atomizer, an air heater, a drying chamber, and a means for separating and collecting powder from the exhaust air (Figure 12.20). In the typical operation, the liquid is pumped into an atomizer, which disperses the liquid into fine drops and into a chamber of heated air. There are numerous variations in spray drying, starting with the means of liquid particle atomization. Pressure atomization is the most efficient of these, and used when a narrow particle size distribution is required. Here, the liquid is forced under pressure through a narrow orifice, which breaks the liquid apart. The particle size depends on the flow rate through the nozzle and the pressure drop attained. Though more uniform size distributions are attained, coarse particles in the range of

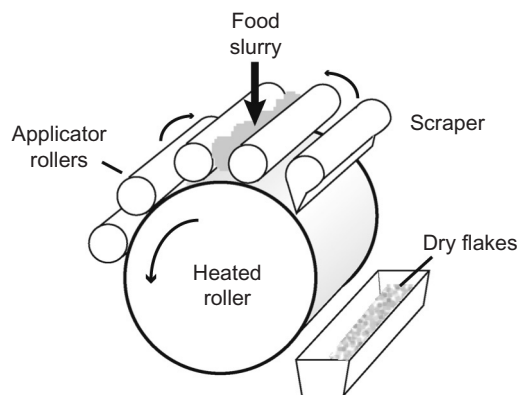
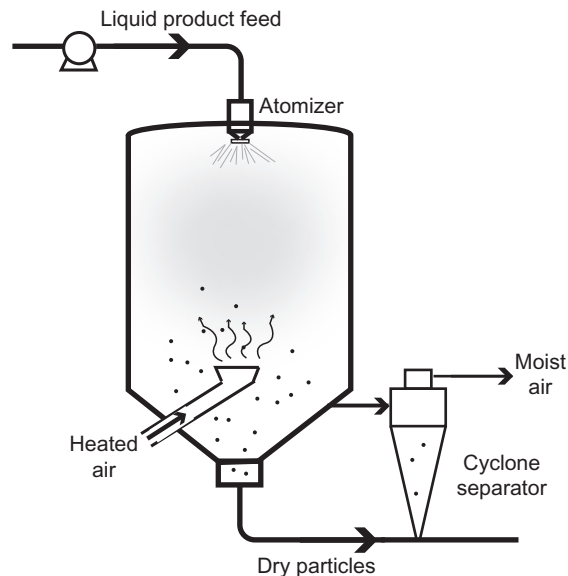


Figure 12.19 Drum dryer with applicators.

100–300  $\mu\text{m}$  are typical. In centrifugal atomizers, drops are created by passing the liquid through a rapidly rotating disk. Fine drops break off at the disc edge either directly or from break up of liquid ligaments. A series of vanes may also be incorporated. Although particles are typically under 100  $\mu\text{m}$  in diameter, broader size distributions are created compared to pressure atomizers. Also, as the materials flows out horizontal to the atomizer, build up of material on the dryer chamber walls is more likely. In the centrifugal atomizer, the average droplet size depends primarily on the fluid feed and atomizer rotational speed. Liquid droplets may also be formed using the two-fluid, or pneumatic, atomizer. Here, the liquid is sprayed together with a compressed gas, which provides the energy to break up the liquid. Contact of the fluids may occur either in or outside of the nozzle. Frictional forces cause the liquid food to tear into filaments or large drops, which are then broken apart into even smaller droplets. Droplet size depends on the absolute and relative velocity of the fluids as well as on nozzle characteristics. This type of atomizer is useful when very fine droplets are required (10–30  $\mu\text{m}$ ), or where small flow rates are needed.

Once dispersed into the drying chamber, the fine particles are exposed to heated air. In cocurrent dryers, the air is blown in the same direction as the product. In countercurrent dryers, the air flows against the product spray. In some cases, a mixture design is used, as when the food material is sprayed upward into the chamber, then falls back down under gravity. Drying time is usually short, and much of it occurs in the constant rate regime. Thus, the product temperature remains near the wet bulb



**Figure 12.20** Cocurrent spray dryer.

temperature for much of the time. One model developed for predicting drying time is:

$$t = \frac{\Delta H_v \rho_o d_o}{8k_g(T_a - T_{wb})} + \frac{\rho_p d_c \Delta H_v (w_c - w_e)}{2h(T_a - T_{wb})} \quad [12.13]$$

where  $T_a$  is the air temperature,  $T_{wb}$  the wet bulb temperature,  $k_g$  is the thermal conductivity of air,  $\Delta H_v$  the latent heat of vaporization,  $\rho$  the density,  $w$  the dry basis moisture content,  $d$  the droplet diameter, and  $h$  the surface heat transfer coefficient. The subscripts  $o$ ,  $c$ , and  $e$  refer to initial droplets, those at the critical moisture content between constant and falling rates, and those at equilibrium, respectively. The first term deals with drying during the constant rate period, and the second refers to drying in the falling rate period.

Although larger dried particles may fall out of the air stream, some finer particles get caught up with the moist exit air. The exhaust air is usually directed to a cyclone separator. As the stream enters horizontally, a spinning action is created. The heavier particle stream falls to the bottom as the exhaust air is carried out the top.

A wide variety of products are spray dried including skim milk, liquid eggs, instant coffee and tea, whey proteins, and enzymes. Spray drying has also been used to create a variety of encapsulated systems.

### 6.13 Osmotic Drying

Water can also be pulled from a food product by immersing it in a relatively concentrated solution of salts or sugars. The food structure acts somewhat like the semi-permeable membranes found in osmometers or dialysis tubes. In those well-defined cases, a porous membrane allows water to pass, but not solutes. Water will flow through the membrane from a dilute solution to a more concentrated one until the pressure build-up counteracts the flow. The osmotic pressure is given by:

$$\pi = MRT \quad [12.14]$$

where  $M$  is the molar concentration of a solution separated from pure water by a membrane. A real fruit or vegetable is more complex, but does have semi-permeable cell membranes. Movement of water out of the cells is controlled by the chemical potential of water on both sides. Chemical potential of water in solution is given by:

$$\mu_w = \mu_w^\circ + RT \ell n a_w \quad [12.15]$$

where  $\mu_w^\circ$  is the chemical potential of pure water in standard conditions. Thus, chemical potential is directly related to the water activity ( $a_w$ ), and the difference in  $a_w$  between the food and surrounding solution determines if water will move in or

out of the cells. In osmotic dehydration, the solution is chosen to have an  $a_w$  value less than that of the food, so that water moves out of the cells. In general,  $a_w = \gamma(1 - X_s)$ , where  $\gamma$  is a coefficient and  $X_s$  is the mole fraction of solute. For a given mass of added solute,  $X_s$  is greater for smaller molecules, thus solutes such as salt or simple sugars are most effective as osmotic agents. Typical solutes include NaCl, glucose, sucrose, fructose, lactose, or glycerol.

Osmotic drying is a complex phenomenon. If a solute does not penetrate the food, water will diffuse from the food's interstitial spaces. When solutes diffuse into the food, flow of water from the cells is enhanced. The presence of infused salts or sugars influences the flavor of the dried fruit or vegetable, which can be desirable or undesirable. Drying often occurs in two stages, with a more rapid initial rate of water (1–2 h) removal followed by a slower rate. Total drying times are typically 3–8 h.

Fruits are often partially dried osmotically prior to subsequent air drying. The fruit is immersed in sugar syrups of up to 70 Brix. The syrup may be slightly heated to enhance diffusion. The application of a vacuum, or pulsated vacuum, is often helpful. This results in a sweeter, more moist, and chewier fruit following air drying.

## 6.14 Freeze Drying

Freeze drying is a unique means of dehydration in which water is sublimated directly from the solid to the gaseous state (Figure 12.21). As there is no liquid state during the course of drying, the food structure remains solid and immobile, therefore it does not experience the type of shrinkage found with hot air drying. In addition, as drying occurs at relatively low temperature, there is less impact on flavor, color, and nutrients. To accomplish sublimation, the pressure must be reduced below 0.06 atm (6.1 kPa). Prior to sublimation, the product must be prefrozen to a temperature below the eutectic temperature or glass transition temperature to ensure that there is no unfrozen water. This may be done on freezing shelves in the freeze dry chamber, or by other means outside of the freeze dryer. Typically, frozen product is placed on or

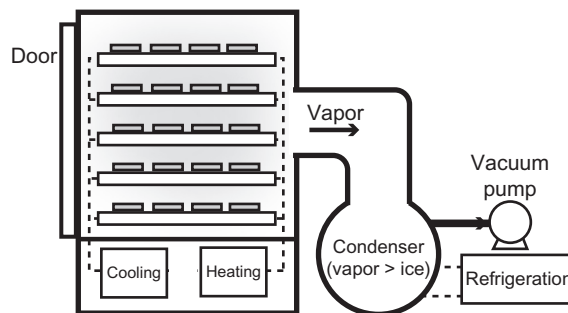


Figure 12.21 Freeze dryer.

remains on shelves in the chamber. The chamber is evacuated and the heat of sublimation supplied by the plates or by radiation. Moisture migrates from the chamber to another compartment, where it is condensed. Enough heat is supplied so that the vapor pressure of ice at the food exceeds that at the condenser, and mass transfer of water vapor can occur. However, the sample temperature should not increase above its collapse point, typically  $-20^{\circ}\text{C}$  to  $-40^{\circ}\text{C}$  during initial stages of drying. After substantial moisture is removed, the collapse temperature increases.

Drying typically proceeds in two stages. During primary drying, ice is sublimated as the ice–air interface recedes in the product. Once this occurs, the product appears dry, but may still contain some 5–10% moisture. During secondary drying, the temperature of the product is increased, and the residual water is desorbed from the product. Although the quality of freeze dried products is high, the cost of freeze drying is prohibitive, as a result of long drying times and low throughput. Drying time can be estimated as:

$$t = \frac{\rho(w_o - w_f)a^2}{2K_p(1 + w_o)(P_s - P_o)} \quad [12.16]$$

where  $\rho$  is the density,  $w_o$  and  $w_f$  the initial and final moisture contents,  $L$  the product half-thickness,  $P_s$  the vapor pressure of water at the product surface,  $P_o$  the vapor pressure in the bulk, and  $K_p$  the permeability of the dried product through which moisture diffuses.

Freeze drying is used for higher value foods, including instant coffee, backpacking foods, space foods, and select ingredients. In addition, freeze dried items are brittle, very hygroscopic, and subject to lipid oxidation. Thus, special packaging is often needed to preserve the shelf-life of freeze dried products.

## 7. QUALITY CHANGES DURING DRYING

During drying, many changes occur in the physical properties and quality attributes of foods. Some of these may be desirable, although many are not. The nature of the changes depends on the commodity, type of drying, and particular conditions applied. One of the primary changes is that occurring in the physical structure, as reflected in the density, porosity, and specific volume of the product. During early phases of drying, cellular structures are still pliable, and can shrink back into the voids left by vacated water. This leads to the typical shrunken appearance of air dried products. As more moisture is removed, the structure becomes less flexible, and may even enter a glassy state. In addition, as more moisture leaves, a porous, rigid structure is left behind. In general, the density of the solid phase increases as more moisture is removed. The apparent density, including solid structure and incorporated air voids,

may decrease or increase at low moisture. The porosity, given by the volume of pores compared to total volume, generally increases at lower moisture. Both the specific volume and porosity depend on the drying method and conditions. Freeze drying creates the least shrinking in foods, with high porosity and little change in specific volume. Osmotic drying creates a lower porosity and denser product. Structural changes also affect how easily a product is rehydrated, as well as the structure of the rehydrated product.

Color and appearance are also major quality factors when considering dried products. Browning is a special problem with dried foods, particularly for hot-air dried products. During drying, such products become darker, with higher degrees of red and yellow. Little changes in color are observed with freeze dried and osmotically dried foods. In general, color changes are most dramatic when higher drying air temperatures are used. Pretreatments also determine the color of dried products. Pre-infusion with sugars or citric acid can help limit color changes in fruits. Water and steam blanching can help prevent color changes in vegetables, although this can occur with some nutrient loss. Sulfur dioxide gas or a dip of 0.2–0.5% sodium metabisulfite applied to fruits inhibit oxidative and enzymatic processes that lead to browning. However, some consumers may be allergic to sulfites. The loss or degradation of pigments, including chlorophylls and carotenoids, can lead to off-colors, such as an olive green versus a grass-green color in peas or beans.

Food texture is also affected by drying and drying conditions. In general, dried foods are more firm, and become firmer at lower moisture levels. Material elasticity also diminishes at low moisture. For some products, a glassy state is reached, and the material becomes brittle. This is undesirable in products such as dried fruits or jerky, but contributes to desirable crispness in dried snack foods. Whereas fruits are often dried to a leathery condition, vegetables are most often dried to a more brittle state. Freeze dried products are often brittle and easily broken. A particular problem in some dried foods is the phenomenon of case hardening. This term refers to a tough skin that develops on some fruits, fish, jerky, and other foods. It most often develops if the temperature is too high in the initial stages of drying, or if low humidity conditions create large moisture gradients between the surface and interior of the product. This phenomenon is related to complex chemical and physical changes occurring at the surface. In some cases, the food may appear dry on the outside while remaining fairly moist on the inside. Case hardening also limits the rate of drying, and may promote mold formation. In addition, case hardened products do not rehydrate well.

For food powders, desirable structure/texture properties are related to the particle size, bulk density, and ease with which these can be dispersed and rehydrated in water. For some materials, including dried milk, additional processing is needed. One important treatment is that of “instantization”; the milk powder is exposed to a water or steam mist as it settles. This encourages crystallization of amorphous lactose, and

causes the fine particles to agglomerate. These agglomerated particles are redried on a vibrating fluidized bed dryer, after which they have much improved flowability, dispersal, and rehydration properties.

Dried foods may suffer a variety of flavor changes that often, but not always, diminish quality. High temperatures tend to reduce important volatile flavor compounds, which are carried away with the drying air. In addition, autooxidation of lipids, thermal decomposition, or development of Maillard reaction products between sugar amines can inject notes of rancidity or cooked flavor. Dried powders containing lipids are especially sensitive to lipid oxidation during storage, which likely explains why only skim milk is dried in the USA. Residual enzymes, including hydrolases or lipases, may also contribute to flavor deterioration during drying or storage. These are limited by treatments including blanching, pasteurization, sulfating, and the addition of ascorbic or citric acids.

Some nutritional factors are also affected by drying. Usually, dried foods retain the same carbohydrate, fat, protein, caloric and fiber contents as their moist precursors, but in a more dense form. For fruits and vegetables, leaching of vitamins can be found during drying preparations. Minerals may be lost by soaking or other pretreatments, but are not expected to be destroyed during drying. As vitamins are more sensitive to heat treatment, they are most labile during the drying process. The degree of vitamin loss is quite variable, and depends on the commodity, drying method, pretreatments, and drying conditions. Vitamin C is perhaps the most sensitive, although some losses of B vitamins may occur. For blanched vegetables, vitamin A losses are usually minimal.

## 8. EVAPORATION

Evaporation is another technique for removing water from foods. It differs from drying, however, in several respects. First, evaporation occurs at the boiling point. By definition, the boiling temperature is that at which the vapor pressure of water in the product is equal to the surrounding total pressure. In contrast, although the vapor pressure of water in a drying product is greater than that in the air, it is still lower than the ambient pressure. In addition, products to be evaporated are in a primarily liquid state. Liquids such as milk, juices, sugar solutions, or liquid wastes can be concentrated by evaporation. Also, for reasons that will become apparent, evaporation is used to concentrate products, but not to dry them.

Although pure water boils at approximately 100°C at typical atmospheric pressures, other boiling points are possible. The variation of boiling point with pressure can be determined from a steam chart or table, which shows the variation of vapor pressure with temperature. For example, the vapor pressure of steam at 40°C is 7.384 kPa. Thus, if liquid water is placed in a chamber evacuated to 7.384 KPa, it will begin to boil at 40°C. In essence, boiling occurs as vaporization occurs throughout

the product. This relationship shows that boiling point decreases with pressure, so that it is possible to evaporate liquid food products at temperatures below 100°C. This is especially advantageous for foods that are subject to cooked flavors, or suffer other losses of flavor or nutrients at high temperatures. The boiling point of a liquid food is also dependent on the concentration of solutes in the aqueous phase. In general, solutes elevate the boiling temperature of pure water. In terms of the concentration of solutes, here expressed as mole fraction  $X_B$ , the boiling point rise is:

$$\Delta T_b = \left( \frac{RT_o^2}{\Delta H_{vap}} \right) \gamma X_B \quad [12.17]$$

where  $T_o$  is the boiling temperature of pure water. For dilute solutions, this can sometimes be estimated as:

$$\Delta T_b = 0.51 m_B \quad [12.18]$$

where  $m_B$  is the molality of solutes in moles of solute per kg of water. As the basic purpose of evaporation is to concentrate solids, as the process continues, the remaining liquid becomes increasingly concentrated with solutes, and thus the boiling point continues to rise.

The actual boiling point is determined by both operating pressure and solute concentration. One technique for estimating the boiling point of a solution at various operating pressures is through Dühring charts. It is assumed that there is a linear relationship between the boiling temperature of water and that of a solution over a range of pressures (Figure 12.22). As the boiling temperature of water at a given pressure

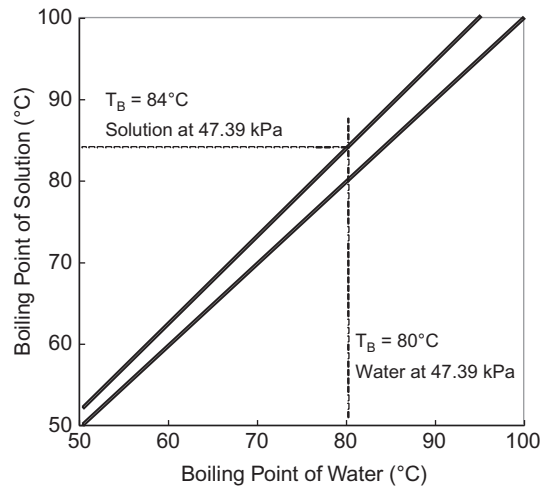


Figure 12.22 Dühring chart for estimating boiling point.



can be found from a steam table, the corresponding boiling temperature of the solution at that pressure can be determined from the chart.

## 9. THE BASIC EVAPORATOR

### 9.1 Pan and Batch Evaporators

The simplest evaporator contains a chamber in which the product is placed (Figure 12.23). The chamber is surrounded by a heat exchanger, which supplies the heat of vaporization for the product (in the order of 2300 kJ/kg of vapor produced). Alternately, the heat exchanger may be a series of tubes running through the product. The heating medium is often steam, although electric or other heating might be used. In some pan evaporators, as are used in concentration of maple syrup, the chamber is an open pan, allowing vapor to rise directly into the atmosphere. Another simple configuration is a spherical chamber. Vapor escapes through a portal and is deflected to the atmosphere or directed to a condenser. In the batch process, liquid is introduced to a specified level in the chamber. Heat is applied until the desired concentration of solids is attained. The heat is removed, and the concentrated product is pumped out of the chamber. During evaporation, the product mixes only by natural convection. Thus, burn-on or fouling at the heat exchanger surfaces is more likely, which also contributes to lower heat transfer rates.

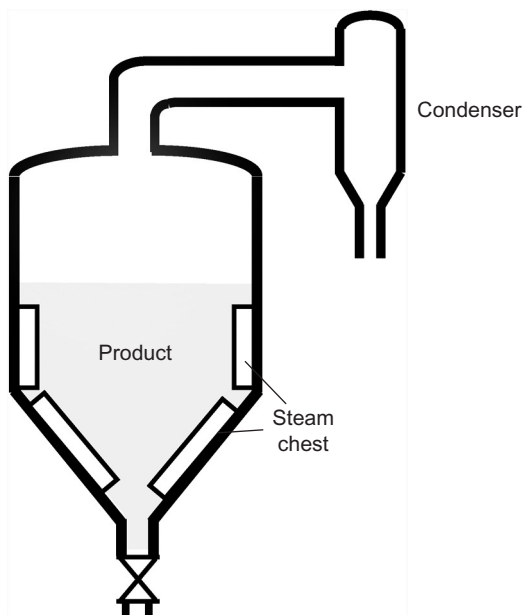


Figure 12.23 *Batch evaporator.*

Evaporation may occur at ambient pressures, but for heat-sensitive products a vacuum system is employed. One means for attaining a vacuum is through a condenser system placed in an elevated position. As water condenses, it falls down a long barometric leg. The pressure at the condenser ( $P_c$ ) will be less than the atmospheric pressure ( $P_a$ ):

$$P_c = P_a - \rho gh \quad [12.19]$$

where  $\rho$  is the density of water,  $g$  is the gravitational constant, and  $h$  is the height of fluid. For example, at  $P_a = 101$  kPa and a height of liquid 5 m high,  $P_c = 52.2$  kPa. In some cases, vacuum can be delivered by a protected vacuum pump or a venturi system.

## 10. TUBE EVAPORATORS

### 10.1 Short Tube Evaporator

Batch evaporators are generally limited to materials that are not heat sensitive, such as sugar or saline solutions. The small heat exchange area contributes to long residence times. Heat transfer can be improved by using a series of tubes to increase the interfacial area between the liquid food and heating medium. One evaporator with a long history is the short tube evaporator. A bundle of tubes, in the order of 5 cm in diameter and 3 m long, extends across a vertical chamber. The product naturally circulates up through the tubes, then down through a central “downcomer” pipe. Steam is circulated around the heating tubes. Water vapor from the boiling product escapes at the surface of the liquid. Residence times in short tube evaporators are still relatively long, so these types of evaporators are used only occasionally in the concentration of sugar cane juice or in salt processing.

### 10.2 Rising Film Evaporator

One widely used tubular evaporator is the rising-film evaporator (Figure 12.24). Long tubes (2–5 cm in diameter and 10–15 m long) are part of a tube and shell heat exchanger, with steam circulated on the shell side. A relatively low viscosity liquid enters the bottom of the tubes. At the lower end, the liquid begins to boil, and bubbles begin to form midway in the tubes, growing in size at the upper end of the tubes. This action causes a film of fluid to rise along the tubes, promoting very rapid heat transfer. A liquid–vapor separator breaks in foam that forms at the top of the tubes. The water vapor continues on to the condenser. Residence time is relatively short, typically 2–5 min. These evaporators take little floor space, but do require relatively high head-room. In addition, to get sufficient rising action, a temperature difference of at least 15°C is needed between the product and the heating medium.

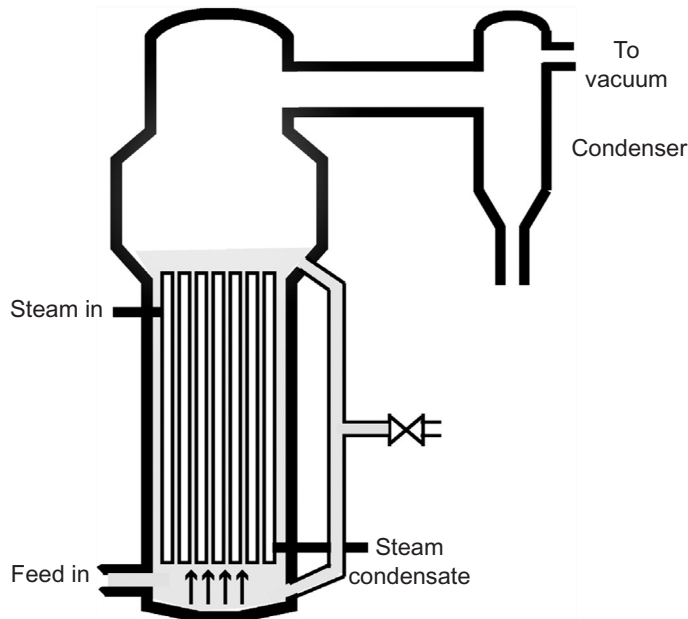


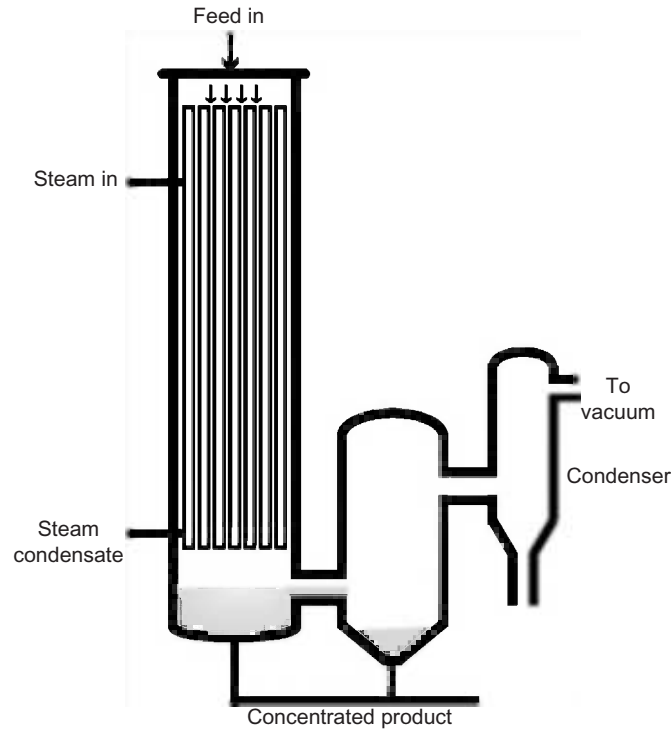
Figure 12.24 *Rising film evaporator.*

### 10.3 Falling Film Evaporator

In the falling film evaporator, the feed is pumped to the top of the chamber, where a distributor introduces it to the tubes (Figure 12.25). The liquid falls as a film down the length of the tubes, at a rate faster than possible with the rising film evaporator. As the concentrated liquid reaches the bottom, a liquid–vapor separator directs the vapor to the condenser. With falling film evaporators, recirculation may be required to attain the necessary solid concentration. Falling film evaporators are more appropriate than rising film evaporators for more viscous liquids, for products with greater heat-sensitivity, or if several effects are needed. Residence times are typically 20–40 s. Heat-sensitive products including milk, juices, and food ingredients can be successfully evaporated in falling film evaporators. The design and operating conditions for falling film evaporators are critical. The surfaces must be adequately wetted to prevent dry spots, crusting, or clogging of the heating tubes. Falling film evaporators are sensitive to changes in operating conditions, including product viscosity, feed rate, and operating temperature.

### 10.4 Rising–Falling Film Evaporator

In some cases, the benefits of both rising and falling film evaporators can be realized by combining them (Figure 12.26). In the rising–falling film evaporator, the feed enters the bottom of one set of tubes in a rising film evaporator and is carried to the



**Figure 12.25** *Falling film evaporator.*

top. The mixture of boiling liquid and vapor is directed and distributed to the top of a falling film, where it falls and the vapor is separated. These evaporators may be helpful when greater ratios of evaporation to feed rate are needed.

In some cases it is advantageous to force circulation through tubes, particularly for viscous products or those with suspended solids or crystallizable substances. The circulating pump helps prevent build-up and fouling of heat exchanger surfaces. Recirculation of product back into the feed stream may be required to obtain sufficient concentration.

### 10.5 Agitated Film Evaporator

For very viscous, high-solids, heat-labile substances or those subject to excessive foaming, agitated film evaporators may be useful (Figure 12.27). A large tube serves as the evaporation chamber. The feed is introduced from the top, and spread as a film on the walls by rotor blades that sweep the surface of the wall. Turbulence imparted by the rotors enables rapid heat transfer and continued cleaning of the surface. Residence time is relatively short, typically under 2 min. Viscous foods with high solids can be successfully evaporated, including fruit and vegetable purees, plant extracts, or fermentation broths.

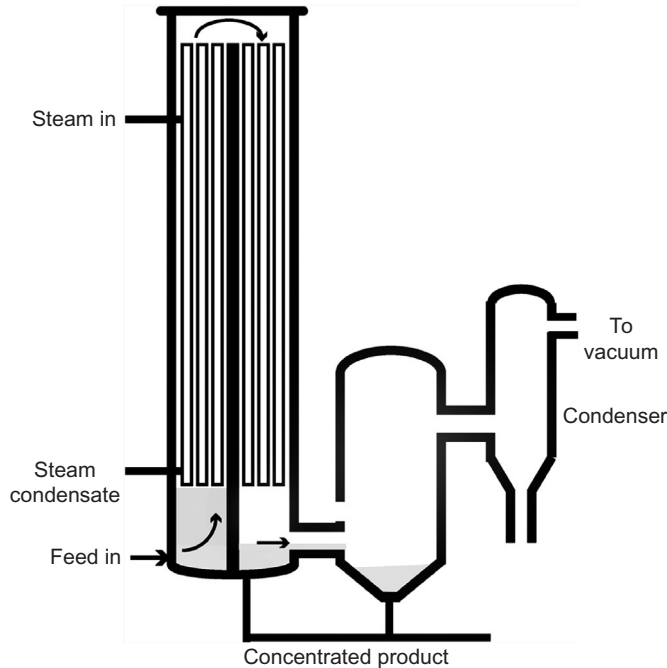


Figure 12.26 *Rising–falling film evaporator.*

## 11. SINGLE EFFECT EVAPORATORS

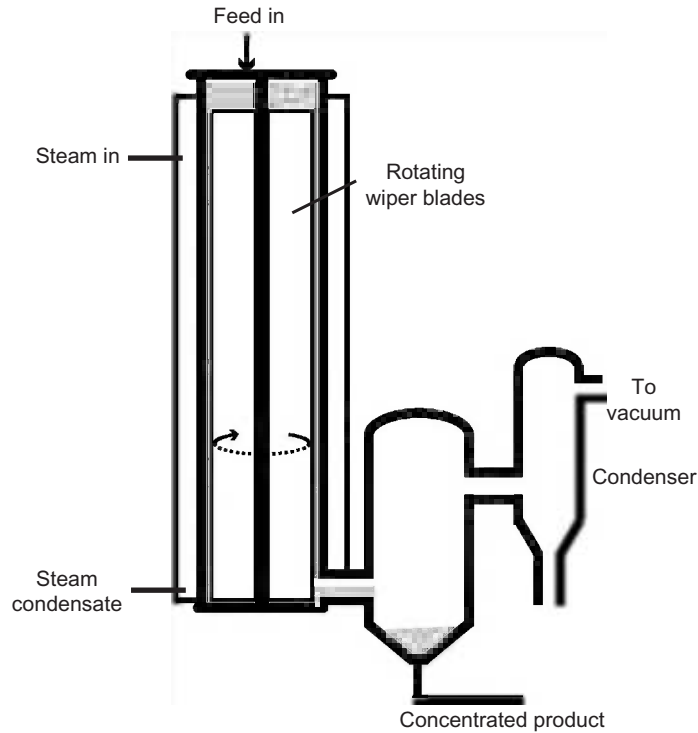
In the simplest system, a single evaporator chamber operates at a single pressure. The initial boiling point of the liquid is controlled by this operating pressure. Often, heat is supplied via steam condensing on the other side of a heat exchanger. The temperature of the product is raised to the boiling point, and vapor is removed from the product. This vapor is usually condensed downstream. Calculation of the mass and concentration of various streams is important to the design of evaporative processes. If  $\dot{m}_f$ ,  $\dot{m}_p$ , and  $\dot{m}_v$  are the mass flow rates of feed, product, and vapor, a total mass balance gives:

$$\dot{m}_f = \dot{m}_p + \dot{m}_v \quad [12.20]$$

The feed is introduced with a solids fraction  $x_f$  and evaporation results in a product with solids fraction  $x_p$ . The amount of solids entering and leaving the system must be balanced:

$$x_f \dot{m}_f = x_p \dot{m}_p \quad [12.21]$$

Energy from the condensing steam is transferred to the product to heat it to the boiling point, providing the latent heat of vaporization. It is important to determine the



**Figure 12.27** *Agitated film evaporator.*

quantity of steam ( $\dot{m}_s$ ) required, and this may be approached by considering an enthalpy balance over the system:

$$\dot{m}_f H_f + \dot{m}_s H_s = \dot{m}_v H_v + \dot{m}_p H_p + \dot{m}_s H_c \quad [12.22]$$

where  $H_f$  is the enthalpy of feed,  $H_s$  the enthalpy of live steam,  $H_v$  the enthalpy of vapor from the product,  $H_p$  the enthalpy of concentrated product, and  $H_c$  the enthalpy of condensed steam. This can be coupled with knowledge of the rate of heat transfer determined by the temperature difference. That is:

$$q = UA(T_s - T_p) = \dot{m}_s H_s - \dot{m}_s H_c \quad [12.23]$$

where  $U$  is the overall heat transfer coefficient (measuring resistance to heat transfer),  $A$  is the heat exchanger area,  $T_s$  is the steam temperature, and  $T_p$  the product temperature.

One measure of evaporator performance is the evaporation capacity, given by the kg vapor produced per hour, and sometimes normalized per square meter of heat exchanger. It is also important to quantify evaporator efficiency, namely as the amount

of vapor removed from the product compared to the amount of steam needed for the process. This is called the steam economy, and is given by:

$$\text{Steam Economy} = \frac{\dot{m}_v}{\dot{m}_s} \quad [12.24]$$

For a single-effect evaporator, the steam economy is typically between 0.75 and 0.95.

## 12. MULTI-EFFECT EVAPORATORS

One obvious limitation to single effect evaporators is that vapor emanating from the product still contains a significant amount of heat. If this vapor is condensed and dumped, that energy is lost. Unfortunately, the vapor cannot be returned directly to the steam supply. Some of the energy may be recovered, however, either through multi-effect evaporators or through mechanical recompression of the vapor. In multi-effect evaporators, the vapor from one chamber is used in the steam chest of a subsequent evaporator (Figure 12.28). To ensure heat transfer in the second chamber, the boiling temperature of that product must be lower than the temperature of the reused vapor. Thus, the pressure in the second effect is lower than that in the first. Several subsequent chambers may be used, each with the requirement of lower boiling temperatures and operating pressures. In this way, the steam economy can be increased from 0.75 to 0.95 in the case of single-effect evaporators, to in the order of 4 to 6 for multi-effect evaporators. The number of effects, however, is limited by capital costs and requirements for greater and greater vacuum.

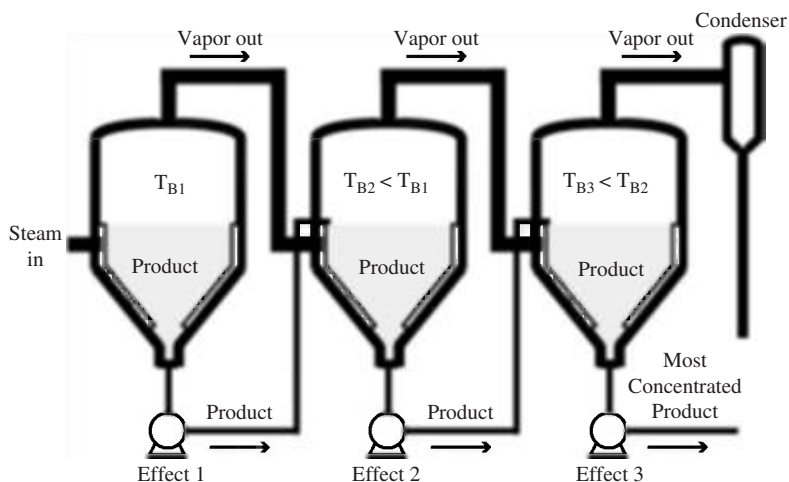


Figure 12.28 Multi-effect evaporator.

Multi-effect evaporators may consist of either forward or reverse feeds. In forward feed systems, the most dilute product is introduced to the first effect, as more concentrated product is introduced to subsequent effects. This is a simpler system, as product tends to flow naturally from the first to subsequent effects. In reverse feed systems, the most dilute feed is introduced in the last effect, and evaporated at the lowest boiling point. This typically provides greater evaporation capacity, as the most concentrated, and most difficult to concentrate, liquid is exposed to the highest temperature. However, this may be a more deleterious system to heat-sensitive products.

### 13. MECHANICAL VAPOR RECOMPRESSION

Another means of reusing the vapor generated from a product is through mechanical vapor recompression (MVR). As the escaping vapor is at relatively low pressure, it cannot be reused directly in the steam supply of a single effect evaporator (Figure 12.29). One way to increase the pressure and temperature of the vapor is by passing it through a specially constructed compressor, at which point it can be introduced to the steam supply of the evaporator. If, for example, a product boils at 50°C

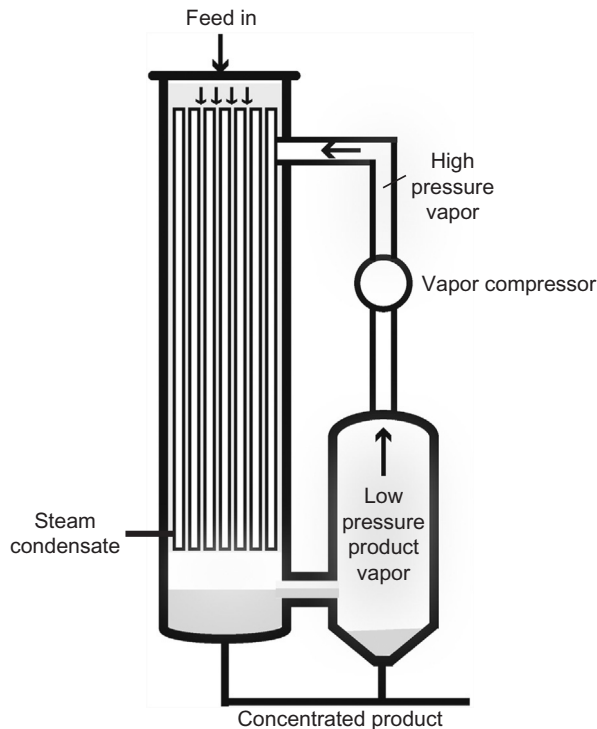


Figure 12.29 *Mechanical vapor recompression.*



and is heated by steam at 70°C, the product vapor has a vapor pressure of 12.35 kPa, while the steam has a vapor pressure of 31.19 kPa. The compressor would need to raise the low pressure vapor to 31.19 kPa to be reused. To convert water to steam requires in the order of 2,350 kJ/kg, depending on the desired steam temperature. Obviously, energy is required to operate a compressor; however, the energy needed is typically 5–10% of that required to generate new steam. Some calculations suggest that the energy efficiency of MVR is equivalent to that attained by a 10–20 effect evaporator.

MVR may be accomplished by positive-displacement, centrifugal, or axial-flow compressors. Often, an electrical motor drives the compressor, but diesel motors have also been used. When lower pressure steam is involved, it may be possible to use a steam-driven turbine. MVR compressors are usually rapidly revolving fans capable of handling large volumes of vapor and operating at low pressures.

Another approach to raising the temperature and pressure of vapor is through thermal vapor recompression (TVR). In this approach, high pressure steam is introduced through a nozzle jet to compress the lower pressure vapor. The rapidly moving high pressure steam sucks the low pressure vapors into the system. The mixture is introduced to a diffuser, where deceleration helps increase the pressure of the mixed steam.

## 14. QUALITY CHANGES DURING EVAPORATION

As with dehydration, evaporation may result in some quality changes in food products. The operation often occurs at elevated temperatures and in conditions that tend to remove aromatic volatiles from the product. This may result in flavor loss, cooked flavors, or a decrease in vitamin content. Evaporation may be used in production of concentrates, such as evaporated milk, that are to be used in confections and other products. Historically, the concentration of fruit juices has relied substantially on evaporators. These products could be readily shipped, even in the frozen state, then reconstituted with water at a later time. Recently, increasing demand for “fresh-like” flavor has increased the production of single-strength juices that are not evaporated. Evaporation is still used substantially in the processing of sugar, syrups, tomato products, and dairy products, as well as in the concentration of waste streams. Evaporation may also be a precursor to other unit operations, as in the concentration of solids prior to spray drying.

## 15. CONCLUSION

Drying and evaporation remain important processes for concentrating solids or removing water from food products. They are mature technologies that can result in very good foods. An increasing desire for minimally processed foods, however, has

driven research into processing that causes the least amount of change in a product. This has caused some processors to move away from drying and evaporation, or toward the development of dryers and evaporators that produce minimal alterations in flavor and color. In addition, concerns with energy costs continue to push for development of improved processes and designs that minimize the extensive need for energy during drying and evaporation.

## FURTHER READING

- Barbosa-Canovas, G.V., Vega-Mercado, H., 1996. *Dehydration of Foods*. Chapman & Hall, New York.
- Bonazzi, C., Dumoulin, E., RaoultWack, A.L., Berk, Z., Bimbenet, J.J., Courtois, F., et al., 1996. Food drying and dewatering. *Drying Technol.* 14 (9), 2135–2170.
- Brennan, J.G., 1994. *Food Dehydration—A Dictionary and Guide*. Butterworth-Heinemann, Boston.
- Caric, M., 1994. *Concentrated and Dried Dairy Products*. VCH, New York.
- Chen, C.S., Hernandez, E., 1997. Design and performance evaluation of evaporation. In: Valentas, K.J., Rotstein, E., Singh, R.P. (Eds.), *Handbook of Food Engineering Practice*, first ed. CRC Press, Boca Raton, Florida.
- Cho, C.H., Singh, S., Robinson, G.W., 1997. Understanding all of water's anomalies with a nonlocal potential. *J. Chem. Phys.* 107 (19), 7979–7988.
- Crapiste, G.H., Rotstein, E., 1997. Design and performance evaluation of dryers. In: Valentas, K.J., Rotstein, E., Singh, R.P. (Eds.), *Handbook of Food Engineering Practice*, first ed. CRC Press, Boca Raton, Florida.
- Dalgleish, J.M., 1990. *Freezedrying for the Food Industry*. Elsevier Science Publishers, New York.
- Ekechukwu, O.V., 1999. Review of solar-energy drying systems. I. An overview of drying principles and theory. *Eng. Convers. Manage.* 40 (6), 593–613.
- Ekechukwu, O.V., Norton, B., 1999. Review of solar-energy drying systems. II. An overview of solar drying technology. *Eng. Convers. Manage.* 40 (6), 615–655.
- Fito, P., Chiralt, A., Barat, J.M., Spiess, W.E.L., Behnlian, D. (Eds.), 2001. *Osmotic Dehydration & Vacuum Impregnation—Applications in Food Industries*. Technomic Publishing Company, Inc., Lancaster, PA.
- Jones, F.E., 1992. *Evaporation of Water: With Emphasis on Applications and Measurements*. Lewis Publishers, Chelsea, Michigan.
- Leon, M.A., Kumar, S., Bhattacharya, S.C., 2002. A comprehensive performance evaluation of solar food dryers. *Renew. Sust. Energ. Rev.* 6 (4), 367–393.
- McMinn, W.A.M., Magee, T.R.A., 1999. Principles, methods and applications of the convective drying of foodstuffs. *Food Bioprod. Process* 77 (C3), 175–193.
- Mishima, O., Stanley, H.E., 1998. Decompression-induced melting of ice IV and the liquid-liquid transition in water. *Nature* 392 (6672), 164–168.
- Mujumdar, A.S. (Ed.), 2004. *Dehydration of Products of Biological Origin*. Science Publishers, Enfield, NH.
- Mujumdar, A.S. (Ed.), 2000. *Drying Technology in Agriculture and Food Sciences*. Science Publishers, Enfield, NH.
- Oetjen, G.-W., Haseley, P., 2004. *Freeze-Drying*, second ed. Wiley-VCH, Cambridge.
- Ratti, C., 2001. Hot air and freeze-drying of high-value foods: A review. *J. Food Eng.* 49 (4), 311–319.
- Re, M.I., 1998. Microencapsulation by spray-drying. *Dry Technol.* 16 (6), 1195–1236.
- Ribatski, G., Jacobi, A.A., 2005. Falling-film evaporation on horizontal tubes—a critical review. *Int. J. Refrig.—Revue Internationale du Froid* 28 (5), 635–653.
- Robinson, G.W., Cho, C.H., 1999. Role of hydration water in protein unfolding. *Biophys. J.* 77 (6), 3311–3318.
- Saguy, I.S., Marabi, A., Wallach, R., 2005. New approach to model rehydration of dry food particulates utilizing principles of liquid transport in porous media. *Trends Food Sci. Tech.* 16 (11), 495–505.

- Singh, R.P., Heldman, D.R., 2001. Heat transfer in food processing, Introduction to Food Engineering, third ed. Academic Press, San Diego, pp. 207–331.
- Singh, R.P., Heldman, D.R., 2001. Psychrometrics, Introduction to Food Engineering, third ed. Academic Press, San Diego, pp. 473–495.
- Vedamuthu, M., Singh, S., Robinson, G.W., 1994. Properties of liquid water: Origin of the density anomalies. *J. Phys. Chem.* 98 (9), 2222–2230.
- Wolfe, J., Bryant, G., Koster, K.L., 2002. What is 'unfreezable' water, how unfreezable is it and how much is there? *CryoLetters* 23 (3), 157–166.

# Food Freezing Technology

Chenchaiah Marella and Kasiviswanathan Muthukumarappan

South Dakota State University, SD, USA

## 1. INTRODUCTION

Food is one of the basic needs of mankind. Mankind meets its food needs from animal and plant sources. As food is highly perishable, in order to make it available throughout the year and in all places, food needs preservation by proper processing. Commonly employed processing techniques are canning, thermal processing such as pasteurization and sterilization, concentration, dehydration, fermentation, chemical preservation, freezing, freeze drying, etc. Preservation of food by lowering the temperature is very well-known process, and has been in use for a long time. Ice–salt mixtures have been used for freezing foods since the mid-1800s. In the USA, a patent was granted to Enoch Piper in 1861 for freezing fish. In England, a patent was granted to H. Benjamin in 1842 for food freezing. Commercial exploitation of food freezing started with the advent of mechanical refrigeration in the late nineteenth century. From the mid-twentieth century, frozen foods started competing with canned and dried foods (Desrosier and Desrosier, 1982).

Nowadays food freezing has become one of the most important unit operations in food processing and preservation. Almost all food products—raw, partially processed, and prepared foods—can be preserved by freezing. In the processed foods sector, the consumer preference for frozen food is even higher than that for dried and canned products. This is mainly visible in the meat, fruit and vegetable sectors. Freezing gives added value to the product and gives a feeling of freshness to the products.

In thermal processing, foods are exposed to high temperatures leading to thermal shock to the food, loss of nutrients, changes in flavor and texture attributes, etc. In chemical preservation and fermentation the initial product properties are modified to a larger extent. However, food freezing involves the removal of heat from the product. This results in converting water into ice and consequent reduction of water activity. The growth of microorganisms and enzymatic activity are reduced as a result of the unavailability of water. The success of food freezing as an important unit operation in

food preservation is mainly attributed to the fact that the foods retain their initial quality such as nutritive value, organoleptic properties, etc.

Successful food freezing technology depends on delivering good quality product to consumers at a reasonable cost. Also good initial quality of product leads to a better frozen food. In prepared foods, maintaining sanitary conditions during preparation and eliminating post-process contamination gives good quality end product. Better understanding of the process of freezing, selection of equipment that causes less mechanical damage to the product during processing and maintains proper freezing rates, proper packing, handling and storage conditions leads to better quality products. Accurate prediction of freezing time, selection of energy efficient equipment, proper automation, taking the advantage of freezing aids such as ice nucleating agents, tracking the freezing front with MRI, etc. can reduce the processing costs. New freezing techniques such as high pressure freezing, de-hydro freezing, etc., are likely to be very helpful in getting better quality product and in reduction of processing costs.

## 2. FREEZING POINT DEPRESSION

Freezing point is the temperature at which the ice crystals are in equilibrium with the water in a food material. Pure water freezes at 0°C at atmospheric pressure. Freezing points of several foods are available in the literature (Desrosier and Desrosier, 1982; Fellows, 2000; Heldman and Singh, 1981). Freezing point of any food product will be lower than that of pure water. This is because food products contain various solutes and their presence depresses the freezing point. The degree of this level depends on the concentration of solutes in the food product. During freezing, as more and more water is converted into ice, the concentration of solutes increases causing the freezing point depression. The extent of this depression can be obtained from thermodynamic relationships based on equilibrium between the states of the system. The freezing point depression of any food product can be estimated using the following equation (Fennema and Powrie, 1964; Heldman and Singh, 1981):

$$\frac{\lambda'}{R_g} \left[ \frac{1}{T_{A0}} - \frac{1}{T_A} \right] = \ln X_A \quad [13.1]$$

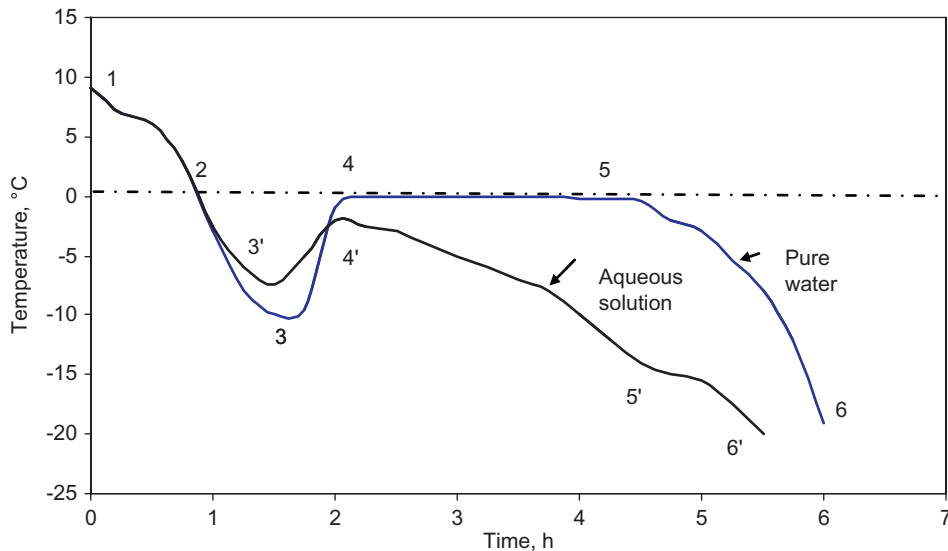
where  $\lambda'$  is latent heat of fusion (J/mol),  $R_g$  is gas constant (J/mol K),  $T_{A0}$  is absolute temperature of pure substance (K),  $T_A$  is absolute temperature (K), and  $X_A$  is mole fraction.

## 3. FREEZING PROCESS

When a food product is exposed to a low temperature medium in the freezer, it starts losing heat as a result of heat transfer from the product to the surrounding medium.

The surface of the food experiences rapid changes in the temperature when compared to the inner part of the product. Changes in temperature of the product measured at the thermal center for an aqueous solution and water during freezing are presented in Figure 13.1. The thermal center is the point that cools slowest and is nothing but the geometric center of the product. The freezing curve for pure water as shown in Figure 13.1 is points 1-2-3-4-5-6. As heat is removed from water, the temperature starts falling and reaches some value below the freezing point. Further removal of heat from the product results in crystallization of water with phase change and ice crystal formation. This proceeds at constant temperature and the heat removed is known as latent heat. Once all the water is converted into ice, further removal of heat results in a decrease in temperature.

Curve 1-2-3'-4'-5'-6' in Figure 13.1 represents a freezing curve for a food product (such as an aqueous solution). During freezing of any food product the initial temperature of the product is much above the freezing point. As heat is removed, during the first stage (curve 1-2) the temperature falls to freezing point of the food and is always less than 0°C. Further removal of heat brings the product temperature to much below the freezing point (curve 2-3'). This temperature is known as the super cooling temperature, and, at times, is as low as 10°C below the initial freezing temperature. This super cooling temperature is slightly higher than that of pure water because of the presence of solutes acting as nuclei, and the crystallization starts early when compared to pure water (Goff, 1992). The heat removed during this process is known as sensible



**Figure 13.1** Temperature–time curve for water (1,2,3,4,5,6) and for an aqueous solution (1,2,3',4',5',6').

heat. During the third stage (curve 3'-4'), crystallization of water starts and, as a result of release of latent heat of crystallization, the temperature of the whole mass slightly increases towards the freezing point. This temperature increase is always less than that for pure water because the presence of solutes lowers the freezing point of the product. During the fourth stage (curve 4'-5'), the temperature of the food starts decreasing as more and more heat is removed. As food products contain solutes, their concentrations continue to increase as more and more water is converted into ice crystals. This increased solute concentration depresses the freezing point of the food and hence the curve is not horizontal. At a certain temperature known as eutectic temperature, the solute crystallizes out. During the fifth stage (curve 5'-6'), the temperature of the product decreases towards the freezing medium temperature.

The amount of water frozen in a food product is dependent on the temperature of freezing. The relation between the freezing temperature and fraction of water frozen for some foods is shown in Figure 13.2. It is clearly seen from the curves that not all the water present in the food product is frozen at the normal freezing temperature of  $-18^{\circ}\text{C}$ . In some foods, even at  $-40^{\circ}\text{C}$  some water still remains in an unfrozen state, and it is not economical to freeze the product to such a low temperature in order to freeze all the water. Data on water contents, unfrozen water fraction at

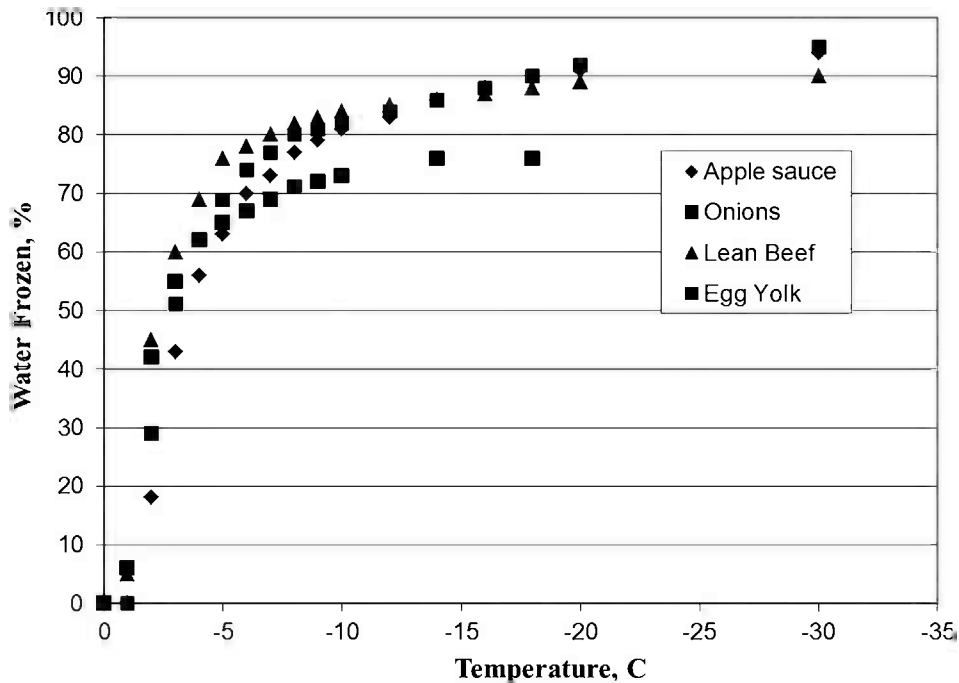


Figure 13.2 The relation between temperature and fraction of water frozen for some foods.

different temperatures for different foods are available in the literature (Dickerson, 1968). Unfrozen water present in the food at a given freezing or frozen storage temperature can be estimated when initial freezing temperature and moisture content of the product are known (Heldman, 1992).

#### 4. PHASE CHANGE AND ICE CRYSTAL FORMATION

As the temperature of the food product is reduced to below freezing point, water starts forming into ice crystals. Ice crystal formation can occur because of combination of water molecules known as homogeneous nucleation or formation of a nucleus around suspended particles or cell walls, known as heterogeneous nucleation (Fellows, 2000). Homogeneous nucleation occurs in the substances free of any impurities that act as nuclei. In food products, heterogeneous nucleation is more common. Heterogeneous nucleation occurs when water molecule aggregates assemble on a nucleating agent such as the wall of the container, foreign body, or insoluble material (Sahagian and Goff, 1996). A third type of nucleation known as secondary nuclei are formed when the crystals are split as a result of attrition forces between the crystals and the walls of the freezer or impeller of the crystallizers. This type of crystallization gives a uniform size of crystals and is more relevant in freeze concentration of liquid foods where formation of large crystals with less deviation in sizes is required (Franks, 1987).

Generally, in food freezing the temperature of the food is reduced from some initial value above the freezing temperature to some value much below the initial freezing temperature. In this process a temperature range of 0 to  $-5^{\circ}\text{C}$  is known as the critical zone. The time taken by a food product to pass through the critical zone determines the number and size of ice crystals that are formed. The effect of freezing rate on the time taken by any product to pass through the critical zone is shown in Figure 13.3. As shown in the figure, slow freezing keeps the product in the critical zone for a longer time when compared to fast freezing. High heat transfer rates, and hence high rate of freezing, gives a large number of small ice crystals, whereas slow freezing gives a small number of large ice crystals. Slow freezing gives more time for the water molecules to migrate to the growing nuclei giving large size crystals.

Formation of large ice crystals will alter the structure of the food and cause loss of quality of the frozen product. Large ice crystals pierce the cell wall causing damage to the cells. This damage is greater at low freezing rates (Otero *et al.*, 2000). Retaining high product quality depends on controlling the ice crystal size during freezing, preventing recrystallization during frozen storage, etc. Addition of antifreeze proteins will be of advantage as they lower the freezing point and prevent recrystallization during frozen storage (Feeney and Yeh, 1998).



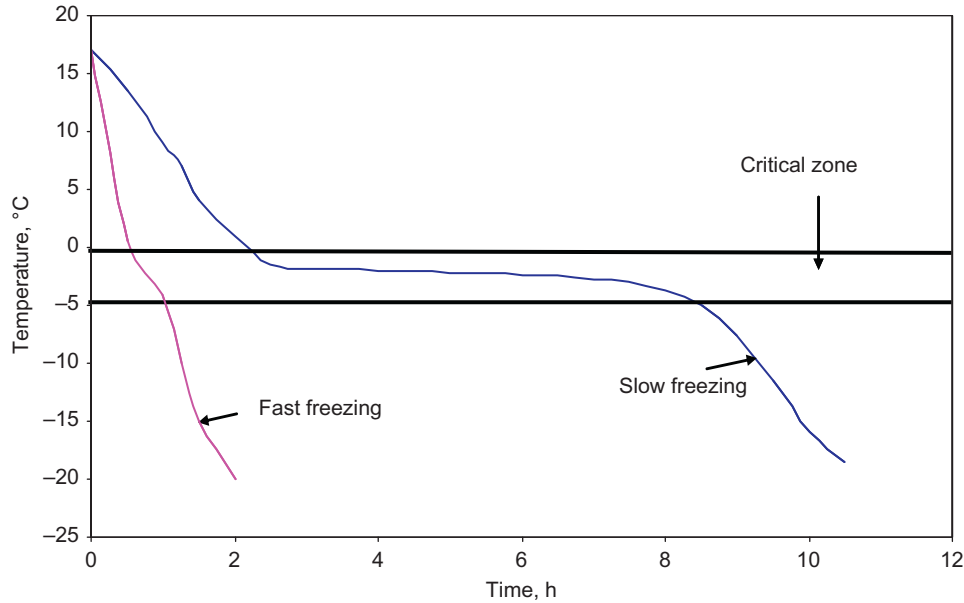


Figure 13.3 Schematic of rate of freezing on residence time of product in the critical zone.

## 5. PRODUCT HEAT LOAD

Total heat load on a refrigeration system required for a specific freezing process include product heat load, heat generated in the freezer from blowers, lighting, heat gain, etc. Product heat load is the main contributor to the load on the freezer. It can be estimated from enthalpy changes during the freezing process.

The total enthalpy includes sensible heat removal from initial temperature to freezing temperature, latent heat removal during phase change and sensible heat removal from initial freezing temperature to final storage temperature. Mathematically, total enthalpy can be represented as:

$$\Delta H = \Delta H_s + \Delta H_u + \Delta H_L + \Delta H_I \quad [13.2]$$

where the terms on right-hand side of the equation represent the sensible heat removed from the product solids ( $\Delta H_s$ ), the sensible heat removed to reduce the unfrozen portion of the product to the storage temperature ( $\Delta H_u$ ), the latent heat removed ( $\Delta H_L$ ), and the sensible heat removed to reduce the frozen portion of the product to the storage temperature ( $\Delta H_I$ ).

Sensible heat  $\Delta H_s$  is given by:

$$\Delta H_s = m_s C_{ps} (T - T_i) + m_s C_{ps} (T_i - T_f) \quad [13.3]$$

where  $m_s$  is mass fraction of solids and  $C_{ps}$  is specific heat of solids,  $T$  is the initial temperature,  $T_i$  is initial freezing temperature and  $T_f$  is final storage temperature.

Change of enthalpy as a result of unfrozen part of the product can be expressed as:

$$\Delta H_u = m_u C_{pu}(T - T_i) + m_u(T) C_{pu}(T)(T_i - T_f) \quad [13.4]$$

where  $C_{pu}$  is specific heat of the unfrozen part.

Similarly, for frozen part (ice):

$$\Delta H_I = m_I(T) C_{pI}(T_i - T_f) \quad [13.5]$$

where  $m_I$  is mass of ice and  $C_{pI}$  is specific heat of ice.

Latent heat portion is given by:

$$\Delta H_L = m_f(T)L \quad [13.6]$$

All the above equations can be written in differential form. Unfrozen and frozen portions of product at any temperature below the initial freezing point can be calculated by Eq. 13.1. One limitation of this method of estimation of enthalpy change is the lack of accountability of solute crystallization. As most of the food products are multisolute systems and some solutes crystallize out at their eutectic points, the latent heat of crystallization is not accounted for in the estimation of total enthalpy.

## 6. FREEZING TIME ESTIMATIONS

All food products contain some solutes. It is not possible to freeze all the water present in the food product at a particular temperature, i.e. freezing point. As more and more water is converted into ice, the concentration of solutes increases causing the freezing point to depress. It is very difficult to assign a clear cut end point to a freezing process. In calculation of time required to complete a freezing process, the time required to reduce the temperature of the product, measured at the thermal center, to some required temperature, leading to crystallization of most of the water and some solutes is taken as the end point to freezing.

The freezing rate that influences the time of freezing and quality of the product can be defined as the difference between the product initial and final temperatures divided by the freezing time ( $^{\circ}\text{C}/\text{s}$ ). It can also be expressed as the ratio of distance between the surface and thermal center of the food, and time elapsed between the surface reaching  $0^{\circ}\text{C}$  and the thermal center reaching  $5^{\circ}\text{C}$  below the temperature of initial ice formation at the thermal center. The depth is measured in cm and time in hours giving units of cm/h for freezing rate (IIR, 1971).

Estimation of freezing time is the main factor in any food freezing operation. Freezing time decides the refrigeration plant capacity needed for freezing operation. The concept of thermal arrest time, the time required to reduce the product

temperature to some stated temperature below the initial freezing point is used in these estimations. During freezing, heat is conducted from the interior of the food to the surface, and then conducted or convected to the freezing medium. Factors that influence this process are thermal conductivity, thickness, density, surface area of the food, temperature difference between product and freezing medium, and resistance offered by the boundary layer surrounding the product. The prediction of freezing time is complicated because properties of the food such as thermal conductivity, density, and specific heat change with temperature, differences in initial temperature, size, and shape of the foods.

### 6.1 Plank's Equation

A simple and straightforward equation for prediction of freezing time is given by Plank (Earle, 1983; Heldman and Singh, 1981). Derivation of the equation involves combining basic conduction and convection equations, and equating this to latent heat of freezing liberated as water is converted into ice.

The most general form of Plank's equation is:

$$t_f = \frac{\rho L}{T_i - T_m} \left[ \frac{Pa}{h} + \frac{Ra^2}{k} \right] \quad [13.7]$$

where  $t_f$  is freezing time (s),  $\rho$  is density of the product ( $\text{kg/m}^3$ ),  $L$  is latent heat of fusion ( $\text{J/kg}$ ),  $T_i$  is initial freezing temperature of the food ( $^\circ\text{K}$ ),  $T_m$  is freezing medium temperature ( $^\circ\text{K}$ ),  $a$  is thickness of the slab or the diameter of the sphere or infinite cylinder (m),  $h$  is surface heat transfer coefficient ( $\text{W/m}^2 \text{K}$ ),  $k$  is thermal conductivity of the frozen food ( $\text{W/m K}$ ), and  $P$  and  $R$  are geometric factors.

For the infinite slab,  $P = 1/2$  and  $R = 1/8$ . For a sphere,  $P$  and  $R$  are  $1/6$  and  $1/24$ , respectively, and for an infinite cylinder,  $P = 1/4$  and  $R = 1/16$ .

The effect of shape of the food product on freezing time can be known from geometric factors. A slab of thickness 'a' and a cylinder and sphere of diameter 'a' will have freezing times of 6:3:2, respectively, when exposed to the same freezing conditions.

### 6.2 Factors Affecting Freezing Time

The time required for the product to freeze is influenced by the product's physical and thermal properties, the properties of the freezing medium, and heat transfer coefficients. It is clear from Plank's equation that freezing time increases with increase in density of the product, latent heat of freezing, and size or thickness of the product, whereas freezing time decreases with an increase in difference between initial freezing temperature of the product and freezing medium temperature, thermal conductivity, and convective heat transfer coefficient.

As the size of the product increases the freezing time increases. This is because of an increase in the latent heat and sensible heat to be removed. In addition, as the product size increases the internal resistance to heat transfer increases requiring more time for the removal of heat. In any heat transfer process the driving force for heat flow is the temperature difference between the heating or cooling medium and the product. As the freezer temperature decreases the driving force increases resulting in reduced freezing time. In the case of air blast freezers, convective heat transfer coefficients have a more pronounced effect on freezing time, an increase in their values drastically reduces the freezing time.

### 6.3 Plank's Equation Modified

Plank's equation assumed only convective heat transfer between the food and the freezing medium, sensible heat load of the product is not taken into consideration. Freezing point of the food product is not the same throughout the process as concentration of solutes influences the freezing point. As water is converted into ice the density of the product decreases, but Plank's equation assumes a constant value for this. The specific heat and thermal conductivity of the food are also not constant. The thermal conductivity of ice is approximately four times that of water. These limitations are taken into account in modifications to Plank's equation (Fricke and Becker, 2004; Leiva and Hallstrom, 2003). Plank's equation assumes that the food product is at its freezing temperature and does not take into account the sensible heat above the freezing and below the freezing. Sensible heat portions and variations in temperature during freezing have been incorporated into Plank's equation (Cleland and Earle, 1977, 1979). Constants P and R are calculated incorporating Biot, Plank and Stefan numbers. These non-dimensional numbers take into account the effects of heat load above and below the initial freezing point.

The Biot number,  $B_i$ , is defined as follows:

$$B_i = \frac{ha}{k} \quad [13.8]$$

where 'a' is the characteristic dimension. It is twice the distance between the surface and the thermal center of the food. For slab it is nothing, but thickness and for cylinder and sphere it is diameter; h is the convective heat transfer coefficient,  $W/m^2 K$  and k is the thermal conductivity,  $W/m K$ .

The Plank number,  $P_k$ , is defined as follows:

$$P_k = \frac{C_u(T - T_i)}{\Delta H} \quad [13.9]$$

where  $C_u$  is volumetric heat capacity of the unfrozen phase ( $J/m^3 K$ ), T is initial temperature of the food (K),  $T_i$  is initial temperature of the food (K), and  $\Delta H$  is

volumetric enthalpy change of the food between initial freezing and the final food temperature ( $\text{J}/\text{m}^3$ ).

The Stefan number,  $S_{te}$ , is similarly defined as follows:

$$S_{te} = \frac{C_I(T_i - T_m)}{\Delta H} \quad [13.10]$$

where  $C_I$  is volumetric heat capacity of the frozen phase ( $\text{J}/\text{m}^3 \text{K}$ ), and  $T_m$  is freezing medium temperature (K).

The values of  $P$  and  $R$  are calculated with the equations given in Table 13.1. Freezing time estimations for different product shapes, conditions, modifications, etc. have been discussed in detail (Cleland and Earle, 1982, 1984; Huns and Thompson, 1983; Michelis and Calvelo, 1983).

The modified Plank's equation takes the form:

$$t_f = \frac{\Delta H_{10}}{T_i - T_m} \left[ \frac{Pa}{h} + \frac{Ra^2}{k} \right] \quad [13.11]$$

The volumetric enthalpy change,  $\Delta H_{10}$  (measured between the initial freezing temperature and final temperature at the center, assumed to be  $-10^\circ\text{C}$ ) replaces the latent heat of freezing and density in the original equation by Plank.

## 7. FREEZING EQUIPMENT

The type of equipment used for a particular product depends on a variety of factors. The sensitivity of the product, the size and shape of the product, finished product quality required, the production rate, space available, investment capacity, type of cooling medium used, etc., decides the type of equipment selected. Freezing equipment can be grouped based on a variety of criteria as given below:

1. Using direct contact with cold surface: Here the product either packed or unpacked will be in direct contact with a metal surface during the freezing process.

This group includes plate freezers and scraped surface freezers.

**Table 13.1** Equations for  $P$  and  $R$  Estimation (Cleland and Earle, 1977, 1979)

Food Shape	Equations
Infinite slab	$P = 0.5072 + 0.2018 Pk + Ste \left[ 0.3224 Pk + \frac{0.0105}{Bi} + 0.0681 \right]$ $R = 0.1684 + Ste(0.2740Pk - 0.0135)$
Infinite cylinder	$P = 0.3751 + 0.0999 Pk + Ste \left[ 0.4008Pk + \frac{0.0710}{Bi} + 0.5865 \right]$ $R = 0.0133 + Ste(0.0415Pk + 0.3957)$
Infinite sphere	$P = 0.1084 + 0.0924 Pk + Ste \left[ 0.2318Pk - \frac{0.3114}{Bi} + 0.6739 \right]$ $R = 0.0784 + Ste(0.0386 Pk - 0.1694)$

2. Using air as cooling medium: Here air at very low temperature is used for freezing the food products. Still air freezers, air blast tunnel, belt freezers, spray freezers, fluidized bed freezers, and impingement freezers fall into this category.
3. Using liquids as coolants: Here very low temperature liquids are used for freezing the products. The liquids may be sprayed onto the product or the products may be immersed in the liquids. This group includes immersion type and cryogenic freezers.

In order to select the right type of equipment for freezing it is essential to know the salient features of these freezers. The following discussion gives some important features of these equipments. In addition, data on convective heat transfer coefficients and freezing times given in [Table 13.2](#) will help in selecting the right equipment.

## 7.1 Direct Contact Freezers Using Cold Surface

### 7.1.1 Plate Freezers

In plate freezers, the metal wall of the plate separates the cooling medium and the product. In freezing of packaged food products, the packaging film also acts as a separation layer and adds its own resistance to heat transfer. Plate freezers can be double plate or multi-plate arrangements. The plates are hollow in construction and the cooling medium is arranged either in coils or flooding the hollow plate. Plates in the plate

**Table 13.2** Typical Convective Heat Transfer Coefficients and Freezing Times for Different Freezing Systems ([Fellows, 2000](#))

Freezing Method	Convective Heat Transfer Coefficient, $W/m^2 K$	Freezing Time at $-18^\circ C$ (min)	Food
Still air	6–9	180–4320	Meat carcass
Blast (5 m/s)	25–30	15–20	Unpacked peas
Spiral belt	25	12–19	Hamburgers, fish fingers
Fluidized bed	90–140	3–4	Unpacked peas
		15	Fish fingers
Plate	100	75	25 kg blocks of fish
		25	1 kg carton vegetables
Scraped surface	–	0.3–0.5	Ice cream
Immersion (Freon)	500	10–15	170 g card cans of orange juice
		0.5	Peas
		4–5	Beefburgers, fish fingers
Cryogenic	1,500	0.9	454 g of cake
		2–5	Hamburgers, seafood
		0.5–6	Fruits and vegetables

freezer are arranged in an insulated cabinet. Heat transfer between the plates and the product is mainly by conduction mode. As shown in Figure 13.4(a), in a double plate freezer the freezing proceeds from both sides of the product. Air pockets or air film between the plates and food packages offer resistance to heat transfer. In order to avoid this, in multi-plate configurations, plates are subjected to a slight pressure to the order of less than one bar (Figure 13.4(c)). This will create better contact between the plates and the food packets and eliminates any air pockets or air film between them. But care should be taken to prevent damage and collapse of packages when pressure is used. Generally spacers are provided to prevent this problem. In the case of loosely packed foods, stagnant air film inside the packet offers resistance to heat transfer. Plate arrangement in multi-plate freezer can be horizontal, as shown in Figure 13.4(c) or vertical as shown in Figure 13.4(b). Horizontal plates are mainly used for products of regular size and rectangular shape. Vertical plate arrangement is used for unpacked, deformable food such as fish and meat products. Liquid and semi-solid foods can also be frozen in vertical plate freezers.

Number of plates depends on the capacity of the system and may be up to 20 plates. Flat packaged foods, ice cream, whole fish, meat pieces, and packaged vegetables are some of the products frozen in plate systems. Plate freezers are compact, require less floor space and head space, and give very high freezing rate. The throughput for the unit volume of the freezer is high when compared to air blast freezers.

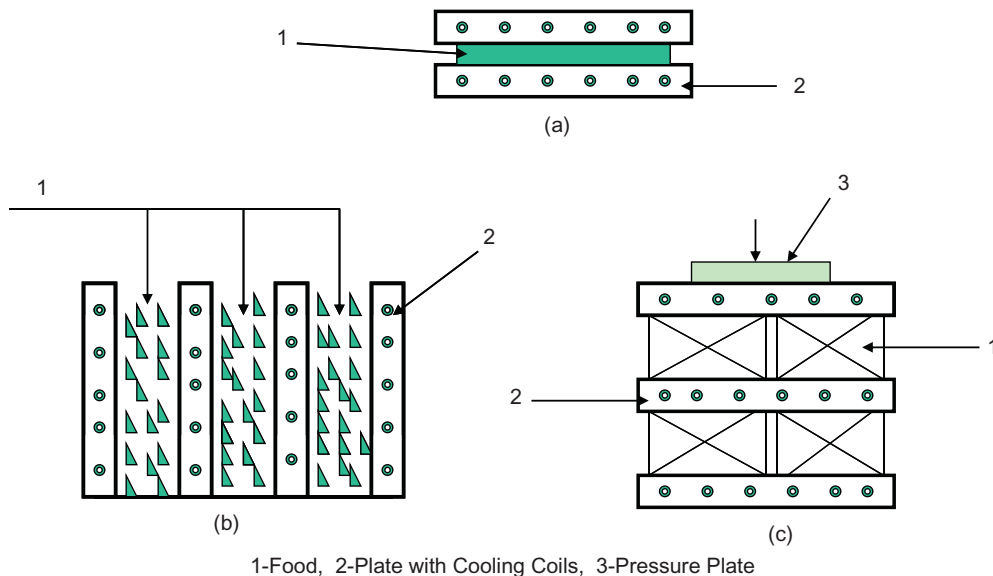


Figure 13.4 Plate freezers: (a) double plate, (b) vertical plate, and (c) horizontal plate with press.

### **7.1.2 Scraped Surface Freezer**

This type of freezer is mainly used for liquid and semi-solid foods with or without particulates. It consists of two concentric cylinders, the outer one being insulated to prevent heat gain from the surroundings. Cooling medium flows in the annular space between the two cylinders whereas the food is contained in the inner cylinder. A scraper rotates inside the inner cylinder and scraps the frozen product layer from the freezer surface. This keeps the metal surface clean and gives high heat transfer coefficients. Scraped surface freezers can be operated in batch mode or continuous mode. The product is frozen very fast and fast freezing gives a large number of small ice crystals in the product. This type of freezer is extensively used in the ice cream manufacturing industry.

## **7.2 Freezers Using Air as Cooling Medium**

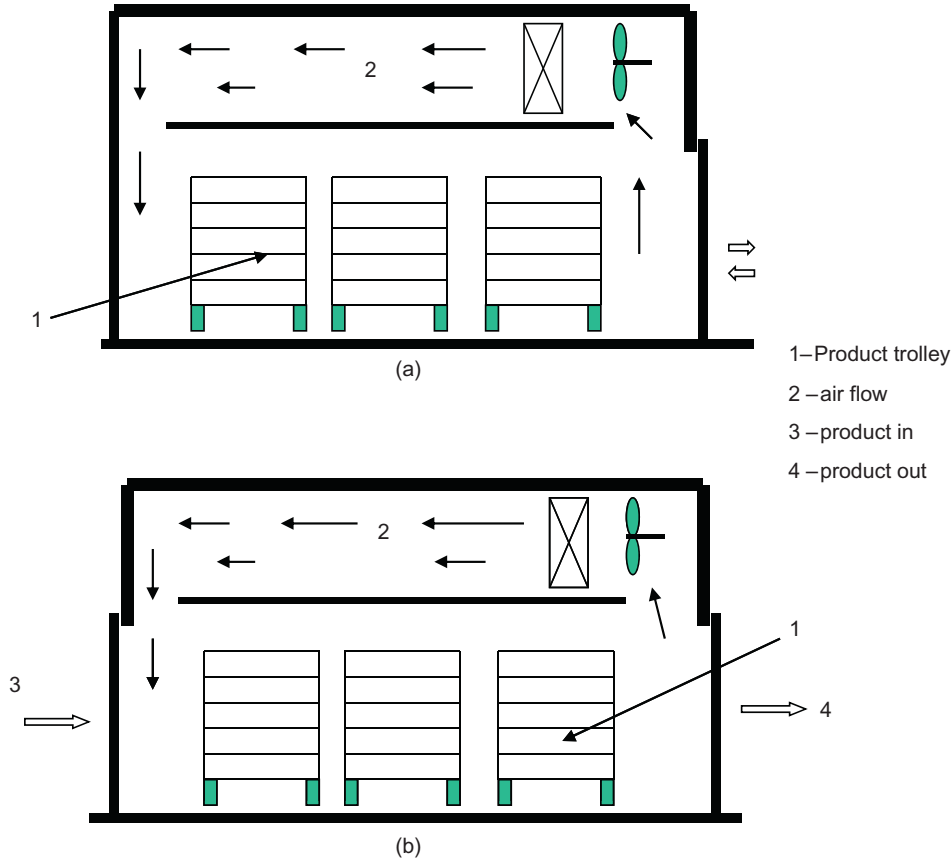
### **7.2.1 Still Air Freezers**

Still air freezers are similar to cold stores. They are relatively large in size and serve the purpose of freezing as well as the storage of the product. Refrigerant coils are generally located at one side of the room. Air flows in the room at very low velocities. The convective heat transfer coefficients are very low and the freezing requires longer time. The slow freezing may lead to quality damage to the product as a result of formation of large ice crystals. Weight loss of the product, especially unwrapped products, will be more as the product is in contact with the air for a long time.

### **7.2.2 Air Blast Tunnel**

An air blast tunnel freezer consists of an insulated tunnel in which the cooling air is circulated by fans or blowers. The product to be frozen is placed on trolleys, hooks, or conveyors and these pass through the tunnel. In batch mode, as shown in [Figure 13.5\(a\)](#), product trolleys are kept inside the tunnel for the required residence time and are removed in order to take in a fresh batch. The air flow arrangement can be horizontal or vertical in relation to the product. In continuous systems, as shown in [Figure 13.5\(b\)](#), the product trolleys will be entering the tunnel at one end and after passing through the tunnel in required residence time come out at the other end. A continuous moving conveyor can also be used in these systems. Continuous systems can have cocurrent or countercurrent air flow arrangements. When compared to cocurrent flow, countercurrent flow arrangement will give better heat transfer rates and a high temperature difference between the product and cooling air. The temperature of air used in these systems is  $-30^{\circ}\text{C}$  to  $-40^{\circ}\text{C}$  and air velocities are 3–6 m/s. Residence time of the product in the freezer depends on the type and size of the product, temperature, and velocity of air. Air blast freezers are simple and easy to operate. They are very flexible in that a wide range of product shapes and sizes can be accommodated. However, low efficiencies, poor heat transfer coefficients,



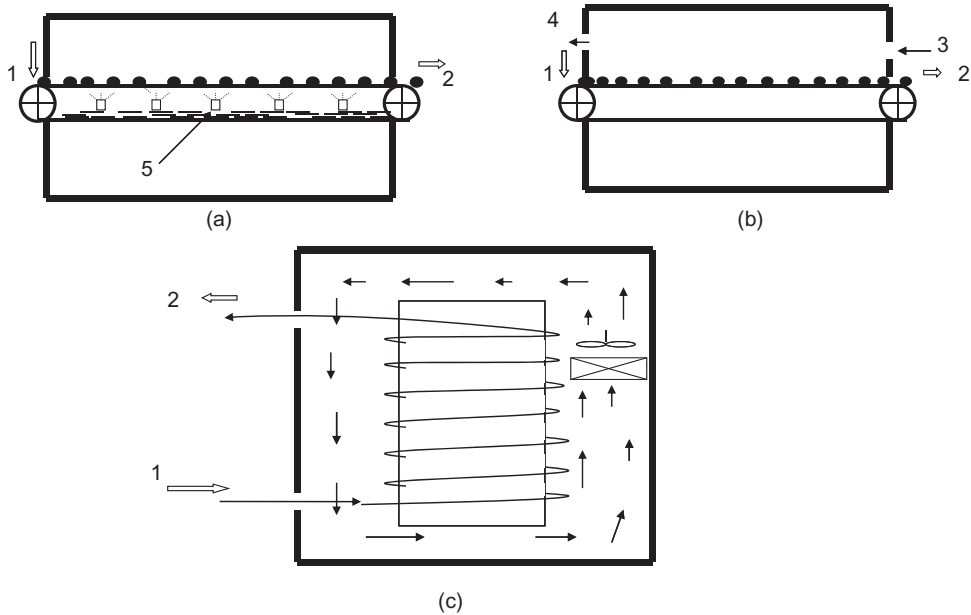


**Figure 13.5** Air blast freezers: (a) batch type, (b) continuous type.

non-uniform distribution of air, and substantial moisture evaporation, especially from unwrapped foods, are some disadvantages with these systems.

### 7.2.3 Belt Freezer

Belt freezers consist of a continuous stainless steel or plastic belt moving in an insulated room. Belt freezers can be straight belt type (Figure 13.6(a), (b)) or spiral belt type (Figure 13.6(c)). Products either in solid or liquid form can be frozen in this type of freezer. For solid foods, perforated belts are generally used and air can be forced upward through the belt. The upward movement of air can partially lift the product giving high heat transfer rates and free flowing nature to the frozen product. Air velocities in the range of 1–6 m/s are generally used in these systems. The product is loaded at one end of the room and is either scraped from the belt surface at the other end or pops up as a result of the brittle nature of frozen product. Heat transfer



1—Product in, 2—Product out, 3—air in, 4—air out, 5—liquid coolant spray

**Figure 13.6 Belt freezers: (a) liquid spray, (b) air cooling, and (c) spiral belt.**

occurring in these systems can be convection and conduction. When high capacities and quick freezing are required, cryogenic gas spray can be used from the top. In a spiral belt freezer, a continuous conveyor belt moves around a cylindrical drum giving up to 50 rounds. These systems require higher head space when compared to straight belt systems. Air flow can be upward or downward through the spirals. As it accommodates a long conveyor belt, this arrangement gives longer product residence times. This type of arrangement is well suited for products requiring longer freezing times, packaged products, and bigger size products.

#### **7.2.4 Fluidized Bed Freezer**

This consists of a perforated metal plate on which a bed of particles rests. Cold air at high velocities is forced through the perforated plate. At low air velocities the air merely percolates through the bed, but as the air velocity is increased the pressure drop across the bed increases. When it equals the ratio of weight of the bed and area of the bed, incipient fluidization occurs. At this point the entire bed of particles is physically lifted from the bottom plate. The particles start vibrating around themselves. This reduces the resistance in the boundary layers and gives very high heat transfer coefficients. Air used as a cooling medium is generally at a temperature of  $-40^{\circ}\text{C}$  and velocity of the air depends on the product size, density, and fluidization characteristics.

The heat transfer in fluidized beds is by convection between the product and the cooling air, and conduction between the adjacent particles as well as between the particles and the support plate. Automatic discharge of the product from the bed can be achieved by providing vibrations or making the support plate slightly inclined. The residence time of the product in the bed depends on the feed rate and volume of the bed, and is controlled by over flow weir/plate. A fluidized bed freezer can also be used for packaged foods but the packing film offers its own resistance to heat transfer. The bed to particle heat transfer mechanisms for small and large particles are well described, and two to three times increase in heat transfer coefficients are reported when compared to forced air convection (Sheen and Whitney, 1990). Over and above a certain heat transfer coefficient, the internal resistance of the product becomes the limiting factor and will not help achieve reduced freezing time. Hence it is recommended to find out the upper limit of convective heat transfer coefficient for different food products in fluidized beds. A fluidized bed freezer works on an individually quick freezing concept, i.e. particles are frozen as individual particles giving a free flowing characteristic to the product. In fluidized beds the moisture loss will be in the order of 2%. The product should be of uniform size and shape. The products frozen include diced carrot, peas, corn kernels, small onions, diced food, and vegetables.

### **7.2.5 Impingement Freezer**

In a conventional air blast freezer using cold air, a stagnant boundary layer of air surrounding the product offers high resistance to heat transfer. As a result of poor convective heat transfer, coefficient freezing rates are low and large ice crystals will be formed leading to poor quality of the product. An impingement freezer is a type of blast tunnel freezer in which cold air at very high velocity is impinged against the food from the top or bottom or from both directions. The impingement disrupts the boundary layer of air surrounding the product thereby eliminating the boundary layer resistance to heat transfer. This technique is being used in freezing of bakery products, candy cooling, and onboard freezing of fish fillets (Salvadori and Mascheroni, 2002). Foods that do not contain surface particles and toppings, chicken, meat, and bread dough are frozen in this type of freezer. Nozzles used in impingement freezers have a great influence on air flow and may be single hole, orifices, or jet tubes. Impingement freezers require low processing times, give higher throughput, and product weight loss will be low as freezing is completed in lesser time.

## **7.3 Freezers Using Liquids as Cooling Media**

### **7.3.1 Immersion Type**

In this system glycol or brine, water–solute mixtures such as sugar alcohol, propylene glycol–water mixtures are used as coolants. Generally, packaged products are frozen

in immersion systems. Freezing is fast because of direct contact and very low temperatures of freezing media. Liquid foods can also be frozen in these systems, in which case the belt conveyor used will have long corrugations and the product is placed in the corrugations. The coolant is sprayed from the bottom of the belt. There is no direct contact between the food and the cooling medium. Alternatively, the corrugated belt can be arranged to pass through a bath of freezing medium giving immersion type of arrangement. However, the top of the corrugation is above the coolant surface thereby preventing direct contact between the product and the coolant. These systems are not commonly used nowadays.

### **7.3.2 Cryogenic Freezers**

Cryogenic freezing came into existence in the 1960s with the introduction of cryogenics such as liquid nitrogen and carbon dioxide. Cryogenic liquids have very low boiling points. The boiling points of liquid nitrogen and liquid carbon dioxide are  $-196^{\circ}\text{C}$  and  $-79^{\circ}\text{C}$ , respectively. Cryogenics are colorless, odorless, and chemically inert. They give very large temperature differences and high heat transfer rates. Enthalpies of liquid nitrogen and liquid carbon dioxide are 228.7 and 310.3 kJ/kg, respectively.

A cryogenic freezer consists of an insulated chamber in which a metallic perforated belt moves continuously. The belt is loaded with the product at one end and at the other end the frozen product is unloaded. The entire belt length can be subdivided into a number of sections: a precooling section, spray or immersion section, and equilibrating section. The precooling section helps in reducing the product temperature close to  $-70^{\circ}\text{C}$ . This helps in preventing freeze cracking damage to the product when exposed to direct contact with the cooling medium in the subsequent immersion or spray section. In the immersion/spray section the product comes into contact with liquid nitrogen giving a product temperature in the order of  $-190^{\circ}\text{C}$ . Attaining such a low temperature is possible because the evaporating liquid nitrogen gives very high convective heat transfer coefficients.

In the case of liquid  $\text{CO}_2$ , when high pressure liquid is released to atmosphere it forms vapor and dry ice in almost equal proportions. Conversion of liquid  $\text{CO}_2$  to vapor requires some time for sublimation and hence spray of coolant is done close to the entrance of the freezer. [Figure 13.7\(a\) and \(b\)](#) shows the immersion and spray types of cryogenic freezers. The latest modification to cryogenic freezers is cryomechanical freezers, combining the advantages of both cryogenic and mechanical freezers. The product is first immersed in liquid cryogen and then moves to a mechanical section that can be a spiral, tunnel, belt, or spray freezer. The vapors generated in the cryogenic section can be used in the mechanical section, and the final temperature is reached in this section. Combining cryogenic and mechanical systems gives reduced

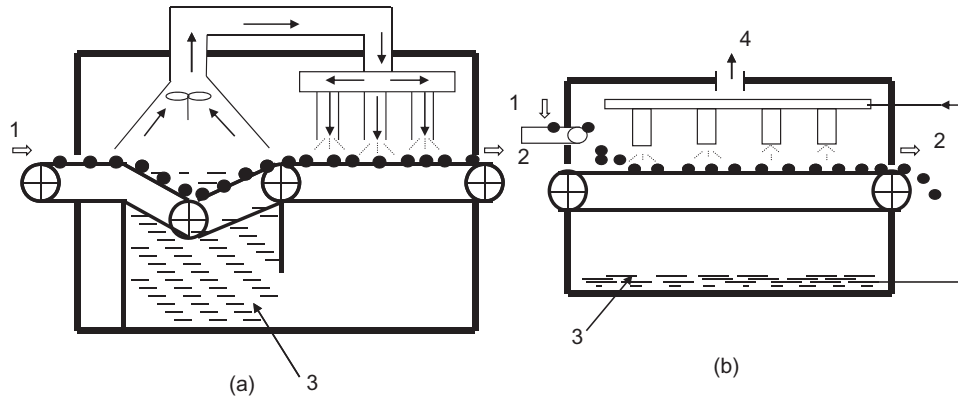


Figure 13.7 Cryogenic freezers: (a) immersion type, (b) spray type.

freezing time, reduced product weight loss, high throughput, improved product quality, and improved efficiency (Agnelli and Mascheroni, 2001).

## 8. EFFECT OF FREEZING AND FROZEN STORAGE ON FOODS

Any addition or removal of heat from the food product brings about several changes to foods. The properties of ice and water are quite different. As freezing converts water into ice the resulting food product is influenced by the properties of ice. Growth of microorganisms and enzymatic activities are influenced to a greater extent by reduced water activity in frozen foods. The size and number of ice nuclei formed will have greater effect on the product quality in terms of degree of damage to bacterial cells as well as product tissues. Weight loss of the product and drying of surface sometimes leads to unacceptable product quality. Conditions during storage and transportation, especially temperature fluctuations, will influence the recrystallization and product quality. As storage temperature decreases, the shelf-life of the product increases. The effect of freezing and frozen storage on food quality and properties is well documented (Fellows, 2000; Jeremiah, 1996; Kessler, 2002; Leniger and Beverloo, 1975; Otero *et al.*, 2000; Rahman, 1999; Singh and Wang, 1977). The effects of freezing and frozen storage on food quality are broadly discussed below.

### 8.1 Effect of Freezing on Food Physical Properties

When water is converted into ice, volume increases by 9% at 0°C and by 13% at -20°C (Kalichevsky *et al.*, 1995). Similarly, when foods are frozen their volume will increase. Moisture content, freezing temperature, and presence of intracellular spaces influence the degree of this increase. Cell damage may also occur because of freezing. This may be because of the mechanical action of ice crystals or osmotic

drying. Muscle foods suffer less damage as a result of their fibrous nature, whereas fruits and vegetables suffer more damage because of their rigid cell structure. Cell damage also depends on rate of freezing; slow freezing leads to formation of extracellular ice crystals and these grow at the expense of tissue cells. Tissue cells suffer dehydration. On the other hand, fast freezing leads to formation of both extra- and intracellular ice crystals.

Loss of weight of the product is another concern in freezing and frozen storage. This not only affects the product quality parameters such as color and appearance, but also affects economic consideration when the product is sold on weight basis. A temperature fluctuation during the storage leads to vapor pressure gradients causing moisture migration to regions of lower pressure. Unpacked and loosely packed products suffer more losses. Type of freezer and freezing medium also affect moisture loss to a great extent. Data on moisture loss from different foods are available in the literature (Sheen and Whitney, 1990; Volz *et al.*, 1949). Mathematical models can be used to predict moisture loss (Norwig and Thompson, 1984; Volz *et al.*, 1949).

Another problem closely associated with moisture loss is freezer burn defect. This manifests in appearance of brown spots on the product surfaces. In cryogenic freezers, when product is immersed in the cooling medium, a hard crust will be formed on the surface of the product. This layer resists any volume increase from inside and the product experiences internal stresses. This may lead to freeze cracking defect in foods. Freeze cracking can be predicted with mathematical models (Kim and Hung, 1994). Product properties such as porosity, size, modulus of elasticity, and density influence greatly freeze cracking. Density of the product can be estimated using a simple equation (Hsieh *et al.*, 1977). However, decrease of density on freezing can be offset by freezing under high pressure conditions.

## 8.2 Effect of Freezing on Food Constituents

Freezing lowers the water activity of foods. Microorganisms cannot grow at low water activity and sub zero temperatures. In addition to arrest of growth, some destruction of microorganisms can also occur during storage. Slow freezing gives more lethal effect on microorganisms. Pathogenic organisms cannot grow at below 5°C, and different types of microorganisms have different susceptibility. Vegetative cells of yeasts, molds, and Gram-negative bacteria are destroyed, whereas Gram-positive bacteria and mold spores are virtually unaffected by low temperature. Freezing and frozen storage do not have considerable effect on enzymes. Peroxidase is active even at very low temperature. Proteins may suffer cold denaturation giving crude appearance, but nutritive value is unaffected due to denaturation. Fats suffer from oxidation and the extent of oxidation depends on the source of the fat. For example, fish fats suffer the most, animal tissues suffer moderately and plant tissues suffer the least. Freezing

has no effect on vitamins A, B, D, and E. Very low temperature frozen storage leads to loss of water-soluble vitamins. Temperature greatly influences vitamin C loss.

### 8.3 Effect of Freezing on Food Thermal Properties

Knowledge of thermal properties of food products is needed in design of cooling, freezing processes, and equipment, as well as cooling load calculations. Data on thermal properties of some foods are given in Table 13.3. Thermal conductivity of ice ( $k = 2.24 \text{ W/m K}$ ) is around four times that of water ( $k = 0.56 \text{ W/m K}$ ). Consequently, thermal conductivity of frozen foods will be three to four times higher than that of unfrozen foods. During the initial stages of freezing, increase in thermal conductivity is rapid. For high fat foods the variation in thermal conductivity with temperature is negligible. For meats, orientation of fibers greatly influences thermal conductivity. Thermal conductivity measured along the fibers is 15–30% higher than that measured across the fibers in meats (Dickerson, 1968). Thermal conductivities of several food products at different temperatures are available in the literature (Lentz, 1961; Smith *et al.*, 1952; Woodams and Nowrey, 1968).

Specific heat of ice ( $2.1 \text{ kJ/kg K}$ ) is only half of the specific heat of water ( $4.218 \text{ kJ/kg K}$ ). On freezing, specific heat of foods decreases. Measurement of specific heat is complicated because there is continuous phase change from water to ice. Latent heat of fusion for any food product can be estimated from the water fraction of the food (Fennema, 1973). Solute concentration in foods is so small that latent heat of freezing of solutes is generally ignored while estimating the cooling loads. Thermal diffusivity of frozen foods can be calculated from density, specific heat, and thermal conductivity data. The thermal conductivity of ice is around four times higher than

**Table 13.3** Thermal Properties of Frozen Foods (Earle, 1983)

Food	Water Content, %	Specific Heat, kJ/kg K	Latent Heat, kJ/kg
Apple	84	1.88	280
Banana	75	1.76	255
Watermelon	92	2.0	305.1
Peaches	87	1.92	288.4
Green beans	89	1.96	296.8
Cabbage	92	1.96	305.1
Carrot	88	1.88	292.6
Beef	75	1.67	255
Fish	70	1.67	275.9
Pork	60	1.59	196.5
Bread	32–37	1.42	108.7–221.2
Egg	–	1.67	275.9
Milk	87.5	2.05	288.4

that of water and its specific heat is half that of water. This leads to an increase of around nine to ten times in thermal diffusivity values of frozen foods when compared to unfrozen ones (Desrosier and Desrosier, 1982).

## 9. DEVELOPMENTS IN FREEZING TECHNIQUES

### 9.1 High Pressure Freezing

Conventional freezing methods, especially for large size foods, lead to development of large temperature gradients. The surface of the product experiences fast freezing giving a large number of small ice crystals, whereas the interior experiences slow freezing giving large ice crystals, leading to product quality losses. Conventional freezing also causes increased volume of the product, leading to tissue damage. When freezing is done under high pressure conditions, ice crystal formation will be homogeneous both on the surface and in the interior thereby minimizing the damage to the tissue. Application of high pressure leads to super cooling of the product. On release of pressure ice nucleation will be very rapid and a large number of small ice crystals will be formed.

High pressure can be applied in different ways:

1. Phase transition in which formation of ice is under constant pressure. This is known as pressure assisted freezing.
2. Phase transition under changing pressure conditions known as pressure shift freezing. The temperature of the product is reduced to lower levels under high pressure conditions (usually 200 MPa) and pressure is released.

Recent studies suggest that pressure assisted freezing and high pressure shift freezing are less harmful methods for vegetables. Pressure of 200 MPa and temperature of  $-20^{\circ}\text{C}$  are found to be optimum for better results for carrots. Reported results indicate improvement in texture and histological changes in high pressure frozen carrots, Chinese cabbage, and tofu (Fuchigami and Teramoto, 1997; Fuchigami *et al.*, 1997a, 1997b). Cells do not face structural damage and enzymatic browning will be reduced. Reduction in freezing time and temperature has been observed for several vegetables with increase in pressure (Knorr *et al.*, 1998). However, high pressure freezing requires special steel for the vessel design and pressure transmitting medium.

### 9.2 Dehydrofreezing

This is a modified freezing method generally applied to high moisture containing foods. The food is partially dehydrated to the required moisture level before being frozen. When freezing foods like fresh fruits and vegetables, the main problem is large increase in volume causing tissue damage. These high moisture containing foods are partially dehydrated prior to freezing (Biswal *et al.*, 1991; Garrote and Bertone, 1989;



Robbers *et al.*, 1997). Partial dehydration can be done with conventional air drying or osmotic drying. Partial dehydration leads to lower product cooling load and product storage, and handling and shipping are less costly.

## 10. ENERGY CONSERVATION IN FREEZING

Freezing is an energy intensive operation. The cost effectiveness of the operation depends on reducing the refrigeration load on the freezer. It is very easy to remove the heat from the food up to initial freezing temperature. Removal of heat below this temperature is difficult and takes a lot of time. As there is no clear-cut end point for freezing, careful selection of an end point for termination of freezing is very important. Moreover, manipulation of freezing point by careful selection and formulation of composition, proper plant automation, etc., is also important. Tracking of the ice–water interface can increase the efficiency of freezing by avoiding removal of excess heat, which normally ranges from 20% to 40 %. Controlling the degree of super cooling will be of advantage in reducing the load on the freezer. Addition of ice nucleation agents such as ice nucleating bacterial cells, chemicals, etc., can raise the super cooling temperature. The raise in super cooling temperature helps in reducing freezing time, and helps in formation of a large number of small ice crystals (Yin *et al.*, 2005).

## 11. SCOPE FOR FUTURE WORK

Scope for future work on food freezing will be on the following lines:

- Freezing the food material under high pressure: Food can be frozen without any form of cooling. This area needs exploitation. The lethal effect of high pressure on microorganisms can also be made use of in extending the shelf-life of the product after thawing. While using high pressure, the effect on proteins and other food components need thorough investigation.
- Application of antifreeze proteins and antifreeze glycoproteins in food freezing applications needs further study. It has been proved that addition of these in chilled and frozen meat reduced ice crystal size and drip loss during thawing (Payne and Young, 1995). Their addition in ice creams and frozen desserts will be of great advantage in controlling recrystallization. The adverse affect of temperature fluctuations in transportation and distribution on quality of the products can be minimized. Cost of antifreeze protein and antifreeze glycoproteins is very high, limiting their use in research. Commercial application of these depends on reducing the cost of these materials by chemical synthesis and genetic engineering (Feeney and Yeh, 1998).
- Use of extrusion principles in food freezing.  
Application of aids to freezing process such as acoustics.

## REFERENCES

- Agnelli, M.E., Mascheroni, R.H., 2001. Cryomechanical freezing—a model for the heat transfer process. *J. Food Eng.* 47, 263–270.
- Biswal, R.N., Bozorgmehr, K., Tompkins, F.D., Liu, X., 1991. Osmotic concentration of green beans prior to freezing. *J. Food Sci.* 56 (4), 1008–1011.
- Cleland, A.C., Earle, R.L., 1977. A comparison of analytical and numerical methods of predicting the freezing times of foods. *J. Food Sci.* 42 (5), 1390–1395.
- Cleland, A.C., Earle, R.L., 1979. A comparison of methods for predicting the freezing times of cylindrical and spherical food stuffs. *J. Food Sci.* 44 (4), 958–963, 970.
- Cleland, A.C., Earle, R.L., 1982. Freezing time prediction for foods—a simplified procedure. *Int. J. Refri.* 5 (3), 134–140.
- Cleland, A.C., Earle, R.L., 1984. Freezing time predictions for different final product temperatures. *J. Food Sci.* 49, 1230.
- Desrosier, N.W., Desrosier, J.W., 1982. *The Technology of Food Preservation*, fourth ed. AVIPub co., Inc., Westport, Conn.
- Dickerson Jr., R.W., 1968. Thermal properties of foods. In: Tressler, D.K., Van Arsdell, W.B., Kopley, M. J. (Eds.), *The Freezing Preservation of Foods*. The AVI Publishing Co, Westport, Connecticut, pp. 26–51.
- Earle, R.L., 1983. *Unit Operations of Food Processing*, second ed. Pergamon press, New York.
- Feeney, R.E., Yeh, Y., 1998. Antifreeze proteins: current status and possible food uses. *Trends Food Sci. Tech.* 9, 102–106.
- Fellows, P.J., 2000. *Food Processing Technology Principles and Practice*, second ed. CRC Press, New York.
- Fennema, D., Powrie, W.D., 1964. Fundamentals of low temperature food preservation. *Adv. Food Res.* 13, 219.
- Fennema, D., Powrie, W.D., Marth, E.H., 1973. *Low Temperature Preservation of Foods and Living Matter*. Marcel Dekker Inc., New York.
- Franks, F., 1987. A maligned and misunderstood concept. *Cryo-Lett.* 8, 53.
- Fricke, B.A., Becker, B.R., 2004. Calculation of food freezing times and heat transfer coefficients. *ASHRAE. Trans.* 110 (2), 145–157.
- Fuchigami, M., Teramoto, A., 1997. Structural and textural changes in Kinu-tofu due to high pressure freezing. *J. Food Sci.* 62 (4), 828–832.
- Fuchigami, M., Kato, N., Teramoto, A., 1997a. High pressure freezing effects on textural quality of carrots. *J. Food Sci.* 62 (4), 804–808.
- Fuchigami, M., Kato, N., Teramoto, A., 1997b. Histological changes in high pressure frozen carrots. *J. Food Sci.* 62 (4), 809–812.
- Garrote, R.L., Bertone, R.A., 1989. Osmotic concentration at low temperature of frozen strawberry halves. Effect of glycerol glucose and sucrose solution on exudates loss during thawing. *Food Sci. Technol.* 22, 264–267.
- Goff, H.D., 1992. Low temperature stability and the glossy state in frozen foods. *Food Res. Int.* 25, 317.
- Heldman, D.R., 1992. Food freezing. In: Heldman, D.R., Lund, D.B. (Eds.), *Handbook of Food Engineering*. Marcel Dekker, Inc., New York.
- Heldman, D.R., Singh, R.P., 1981. *Food Process Engineering*, second ed. The AVI Pub Co., West Port, Connecticut.
- Hsieh, R.C., Lerew, L.E., Heldman, D.R., 1977. Prediction of freezing times for foods as influenced by product properties. *J. Food Proc. Eng.* 1, 183.
- Huns, Y.C., Thompson, D.R., 1983. Freezing time prediction for slab shape food stuffs by an improved analytical method. *J. Food Sci.* 48, 555.
- IIR, 1971. *Recommendations for Processing and Handling of Frozen Foods*, second ed. International Institute of Refrigeration, Paris.
- Jeremiah, L.E., 1996. *Freezing Effects on Food Quality*. Marcel Dekker, Inc., New York.

- Kalichevsky, M.T., Knorr, D., Lillford, P.J., 1995. Potential food applications of high pressure effects on ice water transitions. *Trends Food Sci. Tech.* 6, 253–258.
- Kessler, H.G., 2002. *Food and Bioprocess Engineering*. Verlag H Kessler, Munchen.
- Kim, N.K., Hung, Y.C., 1994. Freeze cracking of foods as affected by physical properties. *J. Food Sci.* 59 (3), 669–674.
- Knorr, D., Scfleveter, O., Heinz, V., 1998. Impact of high hydrostatic pressure on phase transitions of foods. *Food Technol.* 52 (9), 42–45.
- Leiva, M.L., Hallstrom, B., 2003. The original Plank's equation and its use in the development of food freezing rate predictions. *J. Food Sci.* 58, 267–275.
- Leniger, H.A., Beverloo, W.A., 1975. *Food Process Engineering*. D. Reidel, Dordrecht, pp. 351–398.
- Lentz, C.P., 1961. Thermal conductivity of meats, fats, gelatin gels and ice. *Food Technol.* 15, 243–247.
- Michelis, A.D., Calvelo, A., 1983. Freezing time predictions for brick and cylindrical shaped foods. *J. Food Sci.* 48, 909.
- Norwig, J.F., Thompson, D.R., 1984. Review of dehydration during freezing. *Trans. ASAE.*, 1619–1624.
- Otero, L., Martino, M., Zaritzky, N., Solas, M., Sanz, P.D., 2000. Preservation of microstructure in peach and mango during high pressure shift freezing. *J. Food Sci.* 65 (3), 466–470.
- Payne, S.R., Young, O.A., 1995. Effect of preslaughter administration of antifreeze proteins on frozen meat quality. *Meat Sci.* 41, 147–155.
- Rahman, M.S., 1999. Food preservation by freezing. In: Rahman, M.S. (Ed.), *Handbook of Food Preservation*. Marcel Dekker, Inc., New York.
- Robbers, M., Singh, R.P., Cunha, L.M., 1997. Osmotic convective dehydrofreezing process for drying kiwifruit. *J. Food Sci.* 62 (5), 1039–1042, 1047.
- Sahagian, M.E., Goff, H.D., 1996. Fundamental aspects of food freezing process.
- Salvadori, V.O., Mascheroni, R.H., 2002. Analysis of impingement freezers performance. *J. Food Eng.* 54, 133–140.
- Sheen, S., Whitney, L.F., 1990. Modeling heat transfer in fluidized beds of large particles and its application in the freezing of large food items. *J. Food Eng.* 12, 249–265.
- Singh, R.P., Wang, C.Y., 1977. Quality of frozen foods—a review. *J. Food Proc. Preserv.* 2, 249–264.
- Smith, J.G., Eda, A.J., Gene, R., 1952. Thermal conductivity of frozen foods stuffs. *Modern Refri.* 55, 254.
- Volz, F.E., Gortner, W.A., Delwiche, C.V., 1949. The effect of desiccation on frozen vegetables. *Food Technol.* 3, 307–313.
- Woodams, E.E., Nowrey, J.E., 1968. Literature values of thermal conductivity of foods. *Food Technol.* 22 (4), 150.
- Yin, L.-J., Chen, M., Tzeng, S., Chiou, T., Jiang, S., 2005. Properties of extra cellular ice nucleating substances from *Pseudomonas fluorescens* MACH-4 and its effect on the freezing of some food materials. *Fish. Sci.* 71, 941–947.

# Heat and Mass Transfer in Food Processing

Mohammed Farid

University of Auckland, Auckland, New Zealand

## 1. BASIC CONCEPTS OF HEAT AND MASS TRANSFER

Understanding heat transfer in food processing is important for the development of energy efficient thermal processes and insures the production of safe and high-quality food. The food industry is known for its high consumption of energy in processes such as sterilization, evaporation, and drying. Generally, heat transfer is governed by the three well-known modes of transport—conduction, convection, and radiation. However, radiation is important only in high temperature applications such as baking and grilling.

Heat transfer in food processing is complicated by the occurrence of simultaneous heat and mass transfer in drying and frying, free convection heat transfer in thermal sterilization of cans, and phase change in freezing and thawing. Sterilization, drying, and thawing processes will be discussed in some detail in this chapter. First, the fundamentals of heat and mass transfer are briefly introduced. For more detailed analysis, the readers can consult the literature on heat transfer (Holman, 1992; Mills, 1992) and mass transfer (Treybal, 1980).

In many applications, heat transfer is accompanied by mass transfer of moisture or nutrients. Air drying, freeze drying, spray drying, and steam drying are accompanied by moisture transfer, which also undergoes phase change (evaporation). Heat transfer, together with moisture and vapor transfer, controls these processes. Other phase change operations, such as evaporation and condensation, are common in the food industry, mainly to concentrate liquid foods such as milk and juices.

Concentration of liquid foods may also be done using a freeze concentration process in which some of the water is frozen leaving a concentrated solution. Mass transfer of moisture and nutrients may occur independently of heat transfer in osmotic

dehydration, membrane separation, absorption, adsorption, and many other processes, and will not be discussed in this chapter.

During heating, food products undergo various chemical and biological changes at rates that are a function of temperature. In contrast to usual chemical reactions, the chemical and biological reactions associated with food processing do not generate large amounts of heat and hence these changes can be decoupled from the differential equations describing heat transfer, and hence the analysis is significantly simplified.

Food is dried with hot air or superheated steam, fried in hot oil, and usually sterilized in cans or pouches with steam. Heat is transferred from the heating fluid to the surface of the material by free or forced convection. With solid food, heat is transferred by conduction whereas vapor is transported by diffusion or other mechanisms through the pores of the food. For liquid food in containers, natural convection rather than conduction dominates heat transfer. Thawing of products such as meat is usually done in a hot air environment or by using hot water. However, microwave and radio frequency may also be used to assist in thawing of meat, as discussed later in this chapter. Microwaves and radio frequency waves have the ability to penetrate deep inside the food, producing heat within the material. Vacuum microwave drying is sometimes applied to heat sensitive food so that evaporation occurs at temperatures well below 100°C, thus minimizing serious damage caused by high temperature applications (Mousa and Farid, 2002).

In freezing and thawing, heat transfer occurs with minimum mass transfer but with a moving interface separating the frozen and thawed regions, which causes non-linearity in the mathematical analysis of the associated heat transfer.

In cooking, food is usually boiled in water. Heat is transferred from water to the surface of the food with a high boiling heat transfer coefficient and hence it is safe to assume that most of the heat transfer resistance lies within the food itself. This is the same in frying, where water is boiled within the food being deep fried. If a meat patty is grilled in a direct fire, then heat is transferred to its surface mainly by radiation, but when it is grilled between two hot plates, as is usually done in the fast food industry, heat will be mainly transferred by conduction. Ohmic cooking and heating is an efficient means of heating liquid and solid products. For example, a meat patty is conductive to electricity and so if a voltage is applied across two of its surfaces, an electrical current will pass through it generating heat internally, which will assist cooking (Ozkan *et al.*, 2004).

In the following section, the three modes of heat transfer are briefly presented, with a short introduction to mass transfer. For detailed analysis, the reader should consult the literature on heat and mass transfer (Holman, 1992; Mills, 1992; Treybal, 1980).

## 1.1 Conduction Heat Transfer

Steady-state heat transfer in solids is governed by Fourier's Law, which states that the heat flow ( $q$ ) is directly proportional to the temperature gradient in the solid:

$$q = -kA \frac{dT}{dy} \quad [14.1]$$

where  $T$  is the temperature,  $A$  is the area perpendicular to heat flow,  $y$  is the position in the direction of heat flow, and  $k$  is the thermal conductivity of the material, which has values ranging from  $<0.1 \text{ W m}^{-1} \text{ K}^{-1}$  for dried food product to  $0.5 \text{ W m}^{-1} \text{ K}^{-1}$  for most foods. For comprehensive information on the values of thermal conductivity of food products, see [Shafiur \(1995\)](#).

Steady-state heat conduction has limited application in food processing, as all these processes are transient in nature. However, [Eq. 14.1](#) is useful for specific calculations, for example, those related to the estimation of heat gain in cold storage.

The 1-D unsteady-state heat transfer in a solid may be expressed as

$$\frac{\partial T}{\partial t} = \left( \frac{\alpha_{th}}{y^n} \right) \left( \frac{\partial}{\partial y} \left[ y^n \frac{\partial T}{\partial y} \right] \right) \quad [14.2]$$

In [Eq. 14.2](#),  $\alpha_{th}$  is the thermal diffusivity of the material and is equal to  $k/\rho C_p$ , where  $\rho$  is the density, and  $C_p$  is the specific heat capacity of the material. For rectangular coordinates,  $n = 0$ , for cylindrical coordinates,  $n = 1$  and  $y = r$ , and for spherical coordinates,  $n = 2$  and  $y = r$ . The equation can be expanded to cover multi-dimensions, as discussed in most heat transfer textbooks.

Analytical solutions to the above equation are available for very limited boundary conditions and geometry. Simplified methods such as those based on Heissler's Charts ([Holman, 1992](#)) use the available 1-D solution to generate a solution for multi-dimensional problems. However, with the availability of high speed computers and efficient numerical methods (finite difference, finite element, and finite volume), the unsteady-state heat conduction could be solved for almost any geometry and any boundary conditions. These numerical solutions will provide information on the transient temperature distribution within the food, which is important for the determination of food sterility and quality. This is specifically important when the Biot number ( $hL/k$ ) is  $>0.1$ , where  $h$  is the heat transfer coefficient, and  $L$  is a characteristic dimension (slab half thickness or radius of long cylinder and sphere). When the Biot number is  $<0.1$ , it is possible to ignore the temperature distribution and assume that the solid is at uniform temperature. Under such conditions, the lumped heat capacity analysis may be applied to simplify the above equation:

$$mC_p \frac{dT}{dt} = hA(T_\infty - T) \quad [14.3]$$

where  $m$  and  $A$  are the mass and surface area of the body and  $T_\infty$  is the heating or cooling fluid temperature. Eq. 14.3 on integration gives

$$\frac{T - T_\infty}{T_i - T_\infty} = \exp\left(-\frac{hA}{mCp}t\right) \quad [14.4]$$

where  $T_i$  is the initial temperature and  $t$  is the time. Eq. 14.4 provides a quick estimate of the time required for food heating or cooling when there is no phase change and no significant temperature distribution within the solid food.

## 1.2 Forced Convection Heat Transfer

Convection heat transfer from or to the surface of a material at  $T_s$  may be calculated using Newton's Law of cooling:

$$q = hA(T_s - T_\infty) \quad [14.5]$$

Forced convection heat transfer is associated with fluid flow such as in blast freezing and air drying, where cold or hot air is supplied by means of a blower to extract heat from the food product in freezing or provide heat to the food product in drying. The forced convection heat transfer coefficient is calculated from empirical correlation of the form:

$$Nu = cRe^n Pr^m \quad [14.6]$$

In the above equation, the Nusselt number ( $Nu$ ) is  $hL/k$ , the Reynolds number ( $Re$ ) is  $\rho uL/\mu$ , and the Prandtl number ( $Pr$ ) is  $Cp\mu/k$ . The constants in the above correlation are given in the literature (Holman, 1992; Mills, 1992) for a large number of geometry and flow conditions.

## 1.3 Free Convection Heat Transfer

Free convection current is usually established solely as a result of heat transfer and not via the use of externally forced flow. The motion is induced by the density difference in the gas or liquid caused by temperature difference. There are large numbers of food heating and cooling applications in which free convection is the dominant mode of heat transfer. Free convection heat transfer controls the process of sterilization of food in cans and meat freezing in still air or brine. Newton's Law of cooling (Eq. 14.5) describes heat transfer from the fluid to the surface of the food, but the coefficient is calculated based on the following correlation (or many other more complicated forms of the equation):

$$Nu = cRa^n Pr^m \quad [14.7]$$

where Rayleigh number ( $Ra$ ) is  $(T_s - T_\infty) \beta g \rho L^3 / \alpha \mu$ , in which  $\beta$  is the volumetric thermal expansion coefficient of the fluid.

Boiling and condensation heat transfer can occur in free and forced convection environments. Empirical correlations are available in the literature for the calculation of the relevant coefficients.

## 1.4 Radiation Heat Transfer

Thermal radiation is a different mode of heat transfer, requiring no atmosphere for its transfer. Oven baking and cooking of food is controlled by radiant heat generated from the heating element, a flame, or the walls of an oven. Food will receive heat also by natural or forced convection but radiation will be the dominant mode of heat transfer. A black surface is defined as the surface which absorbs all incident radiation ( $\varepsilon = 1.0$ ). Very polished surfaces reflect most of the incident radiation and usually have *emittance* ( $\varepsilon$ )  $< 0.1$ . Real surfaces, including those of food products, have *emittances* lying between these two extreme values. The fraction of incident radiation absorbed by the surface is called *absorptance*. The surface of most food may be assumed a *gray surface*, which is defined as the surface having constant *absorptance* irrespective of the nature of radiation (Mills, 1992). For such gray surfaces, the following equation may be used to calculate heat exchange from surface 1 to 2:

$$q_{12} = \sigma A_1 F_{12} (T_1^4 - T_2^4) \quad [14.7a]$$

where  $\sigma$  is Stefan-Boltzmann constant ( $5.67 \times 10^{-8} \text{ W m}^{-2} \text{ K}^{-4}$ ) and  $F_{12}$  is a *shape factor*, which depends on emittance and geometry (Mills, 1992). Determining the shape factor is difficult, as described in the literature (Holman, 1992; Mills, 1992). For the special case of  $A_1$  being small relative to  $A_2$  or surface 2 is almost black, Eq. 14.7a will simplify to

$$q_{12} = \sigma \varepsilon_1 A_1 (T_1^4 - T_2^4) \quad [14.7b]$$

where  $\varepsilon_1$  is the emittance of surface 1.

## 1.5 Mass Diffusion

Under steady-state conditions, the diffusion of moisture and nutrients in food may be described by Fick's First Law:

$$m_a = -DA \frac{dC_a}{dy} \quad [14.8]$$

where  $m_a$  is the mass flow in  $\text{kg s}^{-1}$ ,  $D$  is the diffusion coefficient in  $\text{m}^2 \text{s}^{-1}$ , and  $C_a$  is the concentration of the diffusing materials in  $\text{kg m}^{-3}$ . The flux is sometimes expressed in moles instead of mass.



Eq. 14.8 is identical to Eq. 14.1, which describes steady-state heat conduction and it may be used to describe steady-state diffusion of gaseous or liquids. By analogy with heat transfer, Eq. 14.2 may be used to describe the unsteady-state mass diffusion (Fick's Second Law) by replacing the temperature with concentration and the thermal diffusivity  $\alpha_{th}$  by mass diffusivity  $\alpha_m$ . In mass diffusion of species in fluids, the diffusion coefficient  $D$  is the molecular diffusion coefficient, whereas in porous foods its magnitude can be different from molecular diffusion coefficients by an order of magnitude. This effective diffusion coefficient, which is a function of moisture content and the structure of the porous food, in processes such as drying, is well discussed in the literature.

## 1.6 Mass Transfer by Convection

Nutrient or moisture diffuses inside the pores of the food at a rate of  $m_a$ , according to Fick's Law and then is transported from or to the surface by convective mass transport, similar to heat transport by free convection:

$$m_a = h_m A (C_s - C_\infty) \quad [14.9]$$

where  $h_m$  is the mass transfer coefficient and  $C_s$  and  $C_\infty$  are the species concentrations at the surface of the food and in the bulk of the fluid.

The mass transfer coefficient  $h_m$  is calculated from empirical correlations available in the literature (Treybal, 1980). These correlations are based on the analogy between heat and mass transfer, which transforms Eq. 14.6, written for heat transfer, into the following form, written for mass transfer:

$$Sh = cRe^n Sc^m$$

where the Sherwood number ( $Sh$ ) is  $h_m L/D$  and the Schmidt number ( $Sc$ ) is  $\mu/\rho L$ .

The remainder of this chapter will present three case studies of food processing in which heat transfer plays a major role, but in ways different from those normally experienced.

## 2. CASE STUDY 1: THERMAL STERILIZATION USING COMPUTATIONAL FLUID DYNAMICS

Two different methods of thermal sterilization are known, the aseptic processing in which the food product is sterilized prior to packaging, and canning in which the product is packed and then sterilized. For liquid food heated in a can, free convection of fluid occurs because of the density differences of the fluid caused by the temperature gradient within the can. For solid food with conduction heating, the location of the slowest heating zone (SHZ) can be determined theoretically and experimentally, as it lies always at the geometric center of the can. However, for liquid food, the

determination of the SHZ is difficult because of the complex nature of natural convection heating, which requires numerical solutions of partial differential equations, describing fluid motion and heat transfer. Measuring the temperature distribution using thermocouples at different positions will disturb the flow patterns and affect the correct prediction of the true location of the SHZ.

The partial differential equations governing natural convection motion of the liquid food in a cylindrical space are the Navier-Stokes equations in cylindrical coordinates (Ghani *et al.*, 1999a and b) as shown below:

$$\text{Continuity equation} \quad \frac{1}{r} \frac{\partial}{\partial r} (r \rho_f v_r) + \frac{\partial}{\partial z} (\rho_f v_z) = 0 \quad [14.10]$$

$$\text{Energy conservation} \quad \frac{\partial T}{\partial t} + v_r \frac{\partial T}{\partial r} + v_z \frac{\partial T}{\partial z} = \frac{k_f}{\rho_f C_{p_f}} \left[ \frac{1}{r} \frac{\partial}{\partial r} \left( r \frac{\partial T}{\partial r} \right) + \frac{\partial^2 T}{\partial z^2} \right] \quad [14.11]$$

*Momentum equation in the vertical direction*

$$\rho_f \left( \frac{\partial v_z}{\partial t} + v_r \frac{\partial v_z}{\partial r} + v_z \frac{\partial v_z}{\partial z} \right) = - \frac{\partial p}{\partial z} + \mu \left[ \frac{1}{r} \frac{\partial}{\partial r} \left( r \frac{\partial v_z}{\partial r} \right) + \frac{\partial^2 v_z}{\partial z^2} \right] + \rho_f g \quad [14.12]$$

*Momentum equation in the radial direction*

$$\rho_f \left( \frac{\partial v_r}{\partial t} + v_r \frac{\partial v_r}{\partial r} + v_z \frac{\partial v_r}{\partial z} \right) = - \frac{\partial p}{\partial r} + \mu \left[ \frac{\partial}{\partial r} \left( \frac{1}{r} \frac{\partial}{\partial r} (r v_r) \right) + \frac{\partial^2 v_r}{\partial z^2} \right] \quad [14.13]$$

where  $T$  is the temperature,  $P$  is the pressure,  $t$  is the heating time,  $g$  is the gravitational acceleration,  $\mu$  is the apparent viscosity,  $\rho_f$  is the density of the fluid,  $C_{p_f}$  is the specific heat of the fluid food,  $k_f$  is the thermal conductivity of the fluid food, and  $v_r$  and  $v_z$  are the velocity components in the radial and axial direction, respectively.

Based on the Boussinesq approximation, the density of the fluid  $\rho_f$  can be written as

$$\rho_f = \rho_o [1 - \beta(T - T_o)] \quad [14.14]$$

where  $\beta$  is the thermal expansion coefficient of the liquid and  $T_o$  and  $\rho_o$  are the temperature and density at the initial condition. The density is assumed constant in the governing equations except in the buoyancy term (Boussinesq approximation), where Eq. [14.13] is used to describe its variation with temperature.

The above equations are written for the vertical can. For horizontal cans and pouches, the formulation becomes three-dimensional. These formulations are not presented here but discussed in detail in Ghani *et al.* (2001, 2002).

## 2.1 Simulations of Thermal Sterilization in a Vertical can

Sterilization of liquid food contained in a metal can, in an upright position and heated at 121°C by steam from all sides, was theoretically modeled and the published results (Ghani *et al.*, 1999a,b) are presented in this chapter. Sodium carboxy-methyl cellulose (CMC) was used as the model liquid. The objective of the simulation was to study the effect of natural convection current on the movement of the SHZ during sterilization. The computations were performed for a can with a radius of 40.5 mm and a height of 111 mm. A non-uniform grid system was used in the simulation with 3,519 cells: 69 in the axial direction and 51 in the radial direction, graded in both directions with a finer grid near the wall. The natural convection heating of CMC was simulated for 2,574s. Because of the axisymmetry of the cylindrical can used in the simulation, heat transfer was simplified into a 2-D problem.

Figure 14.1 shows the temperature profile, velocity vector, and flow pattern of the CMC in a can heated by steam condensing along its outside surface. Figure 14.1(a) shows the influence of natural convection current on the movement of the SHZ in the can (i.e. the location of the lowest temperature at a given time). Figure 14.1(a) shows that the location of the SHZ is not at the geometric center of the can as in the case of conduction heating. As heating progresses, the SHZ is pushed more toward the bottom of the can. The SHZ keeps moving during heating and eventually stays in a region that is about 10–12% of the can height from the bottom. Figure 14.1(b) and (c) shows the recirculating secondary flow created by the buoyancy force, which occurs as a result of temperature variation (from the wall to the core).

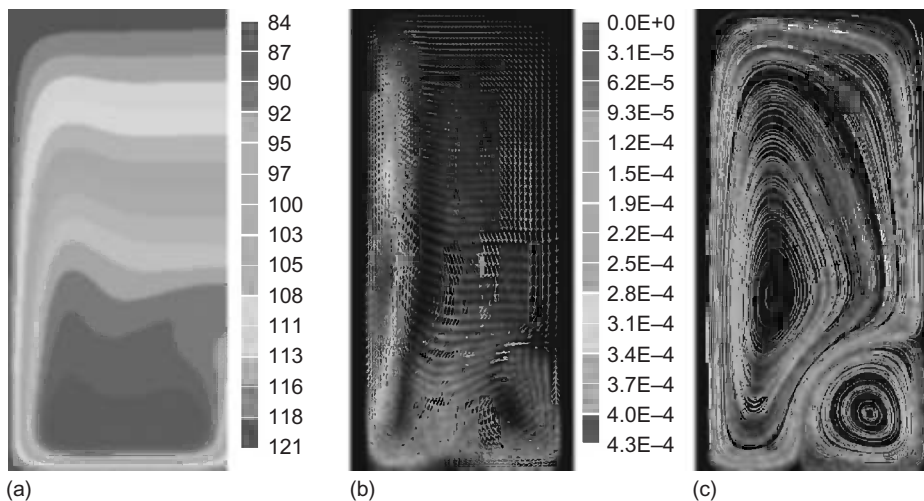


Figure 14.1 Temperature profile, velocity vector, and flow pattern of CMC in a vertical can heated by condensing steam after 1,157s. The right-hand side of each figure is centerline (Ghani *et al.*, 1999b).

## 2.2 Simulation of Bacteria Deactivation during Sterilization

A computational procedure was developed (Ghani *et al.*, 1999a) for describing the changes in the concentration of live bacteria and its transient spatial distributions during the sterilization processing of canned food. The governing equations of continuity, momentum, and energy were solved together with that for bacteria concentration. The Arrhenius equation was used to describe the kinetics of bacteria death and the influence of temperature on the reaction rate constant as described in Ghani *et al.* (1999a)

Figure 14.2 shows the results of the simulation for a metal can filled with CMC, steam heated from all sides (at 121°C). Figure 14.2(a) shows that during the early stage of heating, the bacteria are killed only at locations close to the wall of the can, and are not influenced by the flow pattern (Figure 14.1(c)). Figure 14.2(b) and (c) shows the results of the simulation after longer periods of 1,157s and 2,574s, respectively. The bacteria concentration profiles are different from those observed at the beginning of the heating. The liquid and thus the bacteria carried within it at the SHZ locations are exposed to less thermal treatment than the rest of the product. Figure 14.2(b) and (c) shows that the bacteria deactivation is influenced significantly by both the temperature and the flow pattern (Figure 14.1).

## 2.3 Simulation of Vitamin Destruction during Sterilization

The analysis used to study the inactivation of bacteria was extended to cover the destruction of different types of vitamins during thermal sterilization (Ghani *et al.*

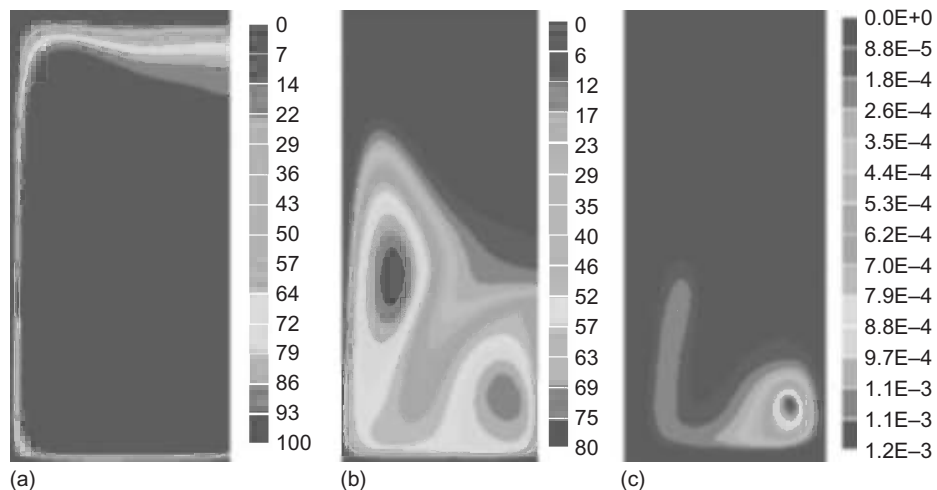


Figure 14.2 Deactivation of bacteria in a can filled with CMC and heated by condensing steam after 180s, 1,157s, and 2,574s, respectively. The right-hand side of each figure is centerline (Ghani *et al.*, 1999b).

2001). Profiles of concentrations of vitamin C (ascorbic acid), B1 (thiamin), and B2 (riboflavin) in a can filled with viscous liquid food (concentrated cherry juice) during thermal sterilization were presented and studied. The simulation highlights the dependency of the concentration of vitamins on both temperature distribution and flow pattern as sterilization proceeds (Figure 14.3).

## 2.4 Simulation of a Horizontal can during Sterilization

In this section, sterilization of a canned liquid food in a can lying horizontally and heated at 121°C from all sides is presented (Ghani *et al.*, 2000). Carrot—orange soup was used as the model liquid food. A non-uniform grid system was used in the simulation with higher mesh of 105,000 cells: 50 in the radial direction, 70 in the vertical direction, and 30 in the angular direction, graded with a finer grid near the wall in the radial and vertical directions. Because of the horizontal orientation of the cylindrical can used in this simulation, heat transfer is taken to be three-dimensional. The Navier—Stokes equations describing the system are presented in Ghani *et al.* (2002). Figure 14.4 shows the radial—angular temperature profile after 600s of heating. The can shown in this figure is in a horizontal position. The inclination shown is to more clearly show the 3-D image. This figure shows the actual shape of the slowest heating zone, which reduces gradually from the middle of the can toward the bottom surface.

## 2.5 Simulation of a 3-D Pouch during Sterilization

In this section, the simulation of a uniformly heated 3-D pouch containing carrot—orange soup is presented (Ghani *et al.*, 2001). As there is limited knowledge available on the

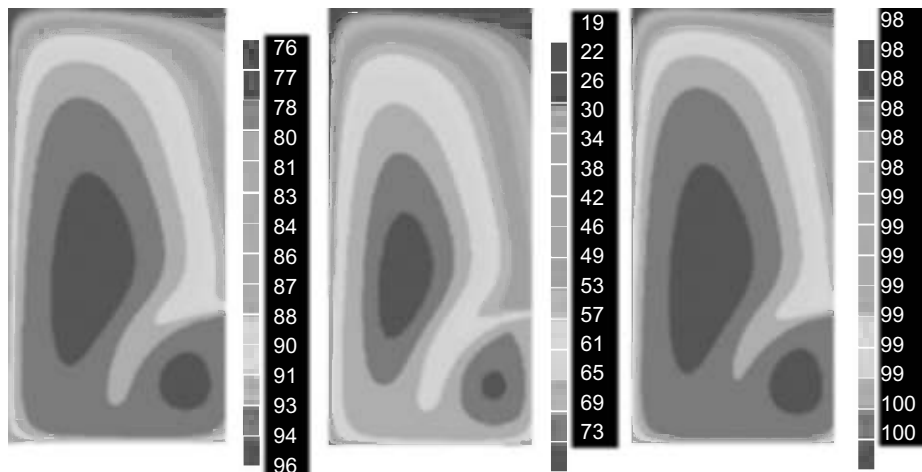
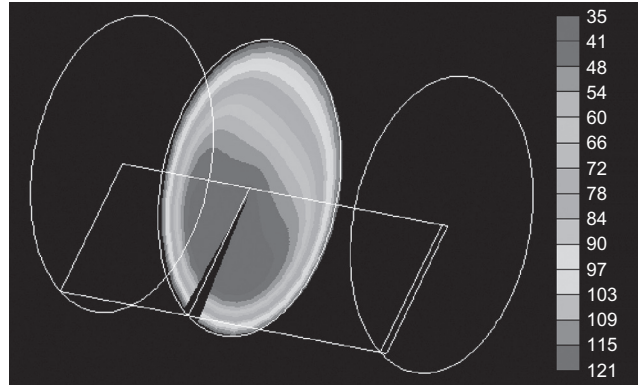


Figure 14.3 Vitamin destruction in a can filled with concentrated cherry juice and heated by condensing steam after 1,640s. The right-hand side of each figure is centerline (Ghani *et al.*, 2001).



**Figure 14.4** Radial–angular plane temperature profile of carrot–orange soup in a 3-D cylindrical can lying horizontally and heated by condensing steam after 600s (Ghani et al., 2002).

sterilization of pouches, the investigation may be used to optimize the industrial sterilization process with respect to sterilization temperature and time.

The computations were performed for a 3-D pouch with a width of 120 mm, height of 35 mm, and length of 220 mm. The pouch volume was divided into 6,000 cells: 20 in the  $x$ -direction, 10 in the  $y$ -direction, and 30 in the  $z$ -direction (Figure 14.5). The partial differential equations governing natural convection of a fluid contained within a pouch are the Navier–Stokes equations in  $x$ ,  $y$ , and  $z$  coordinates.

The result of simulation shows that the SHZ will not remain at the geometric center of the pouch as in conduction heating. As heating progresses, the SHZ is progressively pushed toward the bottom of the pouch as expected and eventually stays in a region about 30–40% of the pouch height. Figure 14.6 shows the temperature distribution at different  $y$ -planes in a pouch filled with carrot–orange soup at the end of heating (50 min).

### 3. CASE STUDY 2: NEW APPROACH TO THE ANALYSIS OF HEAT AND MASS TRANSFER IN DRYING AND FRYING

The common approach usually adopted to describe heat and mass transfer during drying is to solve numerically the heat conduction and mass diffusion equations within the drying material. An effective mass diffusivity is used to describe the diffusion of water and vapor through the solid. This is not true molecular diffusivity as it includes other diffusion mechanisms and was found to vary by more than one order of magnitude with the level of moisture content. Unfortunately, such diffusivity is difficult to measure experimentally and it is a function of moisture content, which limits the usefulness of such analysis.

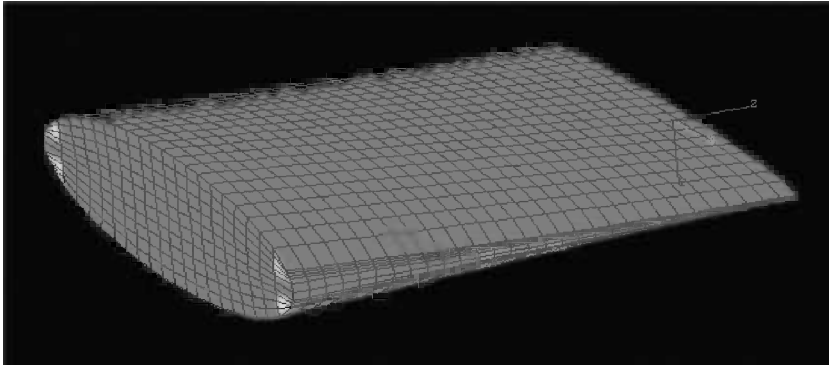


Figure 14.5 Pouch geometry and grid mesh (Ghani et al., 2000).

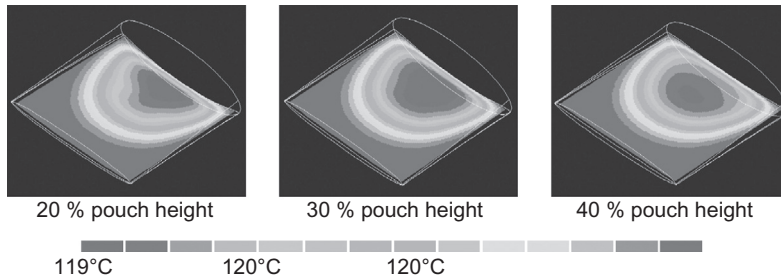


Figure 14.6 Temperature contours at different  $y$ -planes in a pouch filled with carrot—orange soup and heated by condensing steam after 50 min (Ghani et al., 2000).

Farid has introduced a new approach to the analysis of heat and mass transfer during the different drying processes, including deep frying of foods in oil (Farid, 2001, 2002). The analysis was based on the formation of a moving interface, which acts as a heat sink where most of the heat is absorbed through water evaporation or sublimation. Although it may be difficult to describe air drying by this approach, because of the absence of a real sharp interface and the importance of mass diffusion, there are a number of other drying processes that may be described using a moving interface. Water evaporation, from moist solid such as foods, occurs at a receding interface during frying (Farid and Chen, 1998; Farkas *et al.*, 1996; Singh, 2000) air drying (Arzan and Morgan, 1967), and superheated steam drying (Li *et al.*, 1988; Schwartze *et al.*, 1988).

In freeze drying, water sublimation occurs with a moving interface at the water sublimation temperature that corresponds to the vacuum applied (Carn and King, 1977; Jafar and Farid, 2003; Sheng and Peck, 1975). In air drying, such as the spray drying of droplet containing solids, the moving interface may be defined by the air

wet-bulb temperature. In all these processes, heat must be conducted through the crust formed, which has a low thermal conductivity, before being absorbed at the interface. The water vapor generated at the interface will flow outward through the crust with little resistance in most of the applications.

Heat transfer in both the core (wet) and crust (dried) regions is described by the unsteady-state heat conduction Eq. 14.2. When moist materials are dried or fried, the core temperature will rise to the evaporation or sublimation temperature rapidly. Thus in most of these drying processes, the sensible heat of the materials can be ignored. For example, sensible heat accounts for <2% of the heat absorbed in frying and even less in freeze drying.

Most of the temperature distribution will occur within the crust because of its low thermal conductivity, which has been confirmed theoretically and experimentally in a number of drying applications reported in the literatures. The drying rate may be expressed in the case of flat geometry (Farid, 2001) as:

$$R = \frac{(T_{\infty} - T_{critical})}{\lambda \left( \frac{1}{h} + \frac{Y}{k_{cr}} \right)} \quad [14.15]$$

If a modified Stefan Number is defined as  $Ste = \frac{Cp(T_{\infty} - T_{critical})}{\varepsilon_o \lambda}$ , a modified Fourier Number as  $Fo = \frac{k_{cr} t}{\rho C_p}$ , and a modified Biot Number as  $Bi = \frac{hL}{k_{cr}}$ , then Eq. 14.2 may be written in a dimensionless form:

$$R^* = \frac{1}{(\sqrt{1 + 2SteFoBi^2})} \quad [14.16]$$

where the drying/frying rate ( $R^*$ ) is defined as the ratio of the rate of drying at any time to the initial rate (usually known as the constant drying period, before crust is formed). This equation can be used to calculate the rate of drying at any time as the initial rate can be easily calculated from Eq. 14.14 by substituting  $Y = 0$ .

Some of the experimental measurements available in the literature on frying of thick and thin potato chips, freeze drying of slices of frozen beef, and air drying of potato chips were used to test the validity of the model.

Eq. 14.15 was used to calculate the dimensionless drying/frying rate (Figure 14.7) and it is evident that there is good agreement with the experimental measurements. The rate of heat transfer drops rapidly with time during the frying processes, as heat transfer is mostly controlled by heat conduction through the crust as a result of the high external heat transfer coefficient. Much slower drop in the rate is observed during air drying, because of the important role of the external heat transfer in such a process.



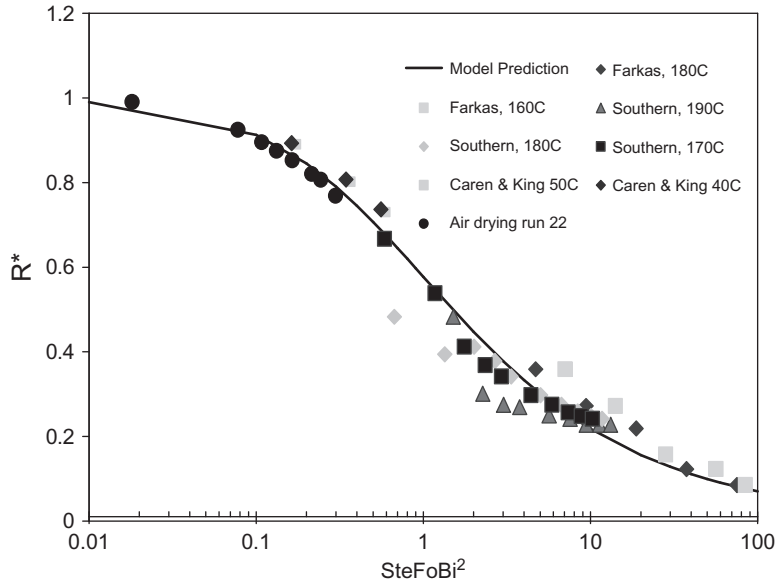


Figure 14.7 Model prediction of the dimensionless rate of frying, freeze drying, and air drying (Farid, 2001).

The above analysis of drying and frying has been conducted based on planar geometry. For spherical and cylindrical geometry, we refer to the analysis presented by Smith and Farid (2004) who have reached the following dimensionless equation, which can be used to calculate the time needed for complete drying/frying:

$$Fo = \frac{R}{Ste} + \frac{P}{Bi \cdot Ste} \quad [14.17]$$

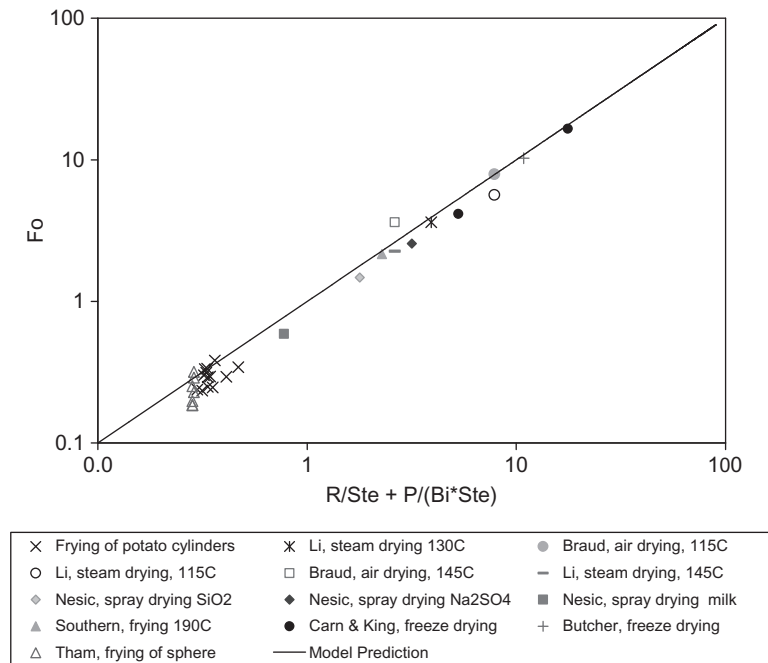
where  $Fo$  is defined in terms of the time needed for complete drying/frying.

The above equation is the same as that developed by Plank in the 1940s for freezing, including the values of the constants  $P$  and  $R$ , which are shown in Table 14.1 for the different geometries.

Figure 14.8 is a generalized plot of the dimensionless time ( $Fo$ ) required for complete drying of all the measurements tested, which includes frying of potato crisps, cylinders and spheres, freeze drying of meat and potato, spray drying of droplets containing solids, and superheated steam drying of tortilla chips. The drying/frying time in these experiments varied from a few seconds as in the frying of thin potato crisps to many hours in freeze drying. Also, the Biot number varied from infinity for freeze drying of meat, 7 to 78 for frying of potato samples, and 0.3 for spray drying. Considering such large experimental variations, the agreement between the model and the experimental results may be considered to be good.

**Table 14.1** Values of P and R for Various Geometries used in the Correlation

Geometry	R	P
Infinite slab	1/8	1/2
Infinite cylinder	1/16	1/4
Sphere	1/24	1/6



**Figure 14.8** Model prediction of the time required for complete frying, freeze drying, superheating steam drying, air drying, and spray drying (Smith and Farid, 2004).

#### 4. CASE STUDY 3: MICROWAVE THAWING OF FROZEN MEAT

Thawing of frozen materials is important in food processing, while freezing is a convenient way of preserving food. Minimizing thawing times will reduce microbial growth, chemical deterioration, and excessive water loss caused by dripping or dehydration. Electromagnetic radiation in the frequency range from 300 MHz to 300 GHz is referred to as “microwaves”. Microwave energy is used as a heat source in applications such as heating, drying, sterilization, and thawing of foods. The capability of a food product to heat when exposed to microwaves is dependent on its dielectric loss coefficient, which reflects the limit of the material to convert electromagnetic field into thermal energy. Frequencies commonly used for microwave heating are 915 and

2,450 MHz. Domestic ovens operate at 2,450 MHz, with a corresponding wavelength of radiation in the medium equal to 12.24 cm ( $\lambda_0 = c/f$ ). Microwaves may provide fast, efficient, and uniform heating but problems such as runaway heating are also common. Tempering or partial thawing of meat products with microwaves is already practiced in the meat industry.

The major problem associated with the development of industrial microwave processing is lack of understanding of the interactions between microwave radiation and food materials. There is a lack of predictive models relating physical, thermal, and electrical properties of food materials to the transient temperature field distribution, which determines microbial safety and product quality (Mudgett, 1986).

Microwaves can rapidly thaw small pieces of meat, but difficulties arise with large masses of frozen meat, which are used in industrial processes. Thawing does not occur uniformly, and some parts of the meat may cook while others remain frozen. Applying cyclic heating may minimize the runaway heating. The thawing rate of a frozen sample depends on the sample's material properties, dimensions, and on the magnitude and frequency of electromagnetic radiation.

Microwave heating has been theoretically studied by a large number of investigators based on the solution of Maxwell's equation, which assumes that microwave radiation is isotropic and normal to the surface of the material to be heated. Hill and Marchent (1996) have reviewed the numerical and analytical techniques used to study microwave heating. However, the theoretical analysis of microwave thawing has not received sufficient attention until recently. Chamchong and Datta (1999a,b) and Taher and Farid (2001) have recently studied microwave thawing of tylose samples using different power levels and showed the effects of power cycling on the non-uniformity of thawing.

## 4.1 Theoretical Analysis

The 1-D unsteady-state heat conduction Eq. 14.2 must be modified to incorporate heat generation due to microwaves:

$$\rho C p_c \frac{\partial T}{\partial t} = \frac{\partial}{\partial y} \left( k \frac{\partial T}{\partial y} \right) + Q(y) \quad [14.18]$$

As the process is accompanied by phase change (thawing), an effective heat capacity ( $C p_c$ ) was applied to account for the latent heat.  $Q(y)$  is the microwave energy absorbed at the different locations ( $y$ ) in the meat sample, which is commonly related to the microwave surface absorption  $Q_0$ , as follows (Taher and Farid, 2001):

$$Q_{th}(y) = Q_0 e^{-(y/D_{pl})} \quad [14.19]$$

where  $D_{pl}$  is the microwave penetration depth in the thawed region, m.

The microwave energy absorbed at the location of the moving interface ( $Y$ ) may be defined by the following equation, based on the above equation:

$$Q_{th}(Y) = Q_0 e^{-(Y/D_{pl})} \quad [14.20]$$

Based on the energy absorbed at the moving interface as defined above, the following expression may be used to calculate the absorbed energy in the frozen region:

$$Q_f(y) = Q_0 e^{-(Y/D_{pl})} e^{-(y-Y)/D_{ps}} \quad [14.21]$$

where  $D_{pl}$  is the microwave penetration depth in the frozen layer and  $Q_{th}$  and  $Q_f$  are the microwaves absorbed in the thawed and frozen regions, respectively. The analysis requires an interface location ( $Y$ ), which is defined as the position corresponding to maximum effective heat capacity. Measurements of thawing of meat show that this maximum effective heat capacity or enthalpy occurs at about  $-2^\circ\text{C}$  to  $-3^\circ\text{C}$ , as will be described later.

By integrating the microwave heat absorbed in the two regions as defined by Eq. 14.18 and 14.20 with the assumption of total absorption of microwave, the following equation for the surface heat absorption due to microwave absorption ( $Q_0$ ) is obtained:

$$Q_0 = \frac{(P/A)}{(1 - e^{-(Y/D_{pl})})D_{pl}(1 - e^{-(E-Y)/D_{ps}})D_{ps}} \quad [14.22]$$

where  $P/A$  is the microwave power per unit surface area exposed to radiation. Microwave penetration depth ( $D_{pl}$  or  $D_{ps}$ ) is defined as the distance at which the microwave field intensity decreases to 37% of its incident value, which may be calculated from the following equation (Basak and Ayappa, 1997):

$$D_p = \frac{c}{2\pi f} \left( 0.5K' \left( \sqrt{1 + \left( \frac{K''}{K'} \right)^2} - 1 \right) \right)^{-1/2} \quad [14.23]$$

The penetration depth in the frozen region is calculated from the known values of  $K'$  and  $K''$  (Table 14.2). The value of  $D_{ps}$  for the frozen meat is found to equal 0.064 m. For the thawed phase, values of  $K'$  and  $K''$  are calculated as functions of the average temperature of the thawed phase ( $T_{av}$ ), using the following equations (Panggrle *et al.*, 1991):

$$K' = 50.6 - 0.183T_{av} \quad [14.24]$$

$$K'' = 20.25 - 0.665T_{av} + 0.0096T_{av}^2 - 5 \times 10^{-5}T_{av}^3 \quad [14.25]$$

**Table 14.2** Average Thermal and Dielectric Properties of Lean Beef

	Unfrozen Phase	Frozen Phase
Thermal conductivity	Eq. 14.30	Eq. 14.30
Density	1,057 kg/m <sup>3</sup>	961 kg/m <sup>3</sup>
Specific heat capacity	3.51 kJ/kg°C	2.09 kJ/kg°C
$K'$	Eq. 14.23	6.0
2,450 MHz $K''$	Eq. 14.24	1.5
$D_p$	Eq. 14.22	0.064 m

Eq. 14.18 to 14.22 may be used to calculate the rate of heat generation due to microwave absorption as a function of position within the meat sample.

According to the effective heat capacity method (EHC), the value of  $C_{p_e}$  is assumed to change within the thawing region such that

$$\int_{T_{m1}}^{T_{m2}} (C_{p_e} - C_{p_e})dT = w\lambda \quad [14.26]$$

where  $\lambda$  is the latent heat of freezing of water,  $w$  is the mass fraction of water in the meat, and  $T_{m1}$  and  $T_{m2}$  are the initial and final thawing temperatures, respectively.

The experimentally measured values of  $C_{p_e}$  are fitted to different polynomials at the different temperature ranges, as shown below (Taher and Farid, 2001):

$$C_{p_e} = 0.00007T^5 + 0.0061T^4 + 0.192T^3 + 2.9T^2 + 21.35T + 66.72 \quad [14.27]$$

for  $-4 \geq T \geq -25$

$$C_{p_e} = 5.8T^3 + 62.83T^2 + 236.6T + 329.4 \quad \text{for } -2 \geq T \geq -4 \quad [14.28]$$

$$C_{p_e} = 153.46T + 368 \quad \text{for } -1.4 \geq T \geq -2 \quad [14.29]$$

$$C_{p_e} = -374T - 370.6 \quad \text{for } -1 \geq T \geq -1.4 \quad [14.30]$$

The thermal conductivity of the frozen and thawed meat sample is calculated from the following equation, derived from the available experimental measurements (Mellor, 1978):

$$k = -0.0007T^4 - 0.0036T^3 - 0.0605T^2 - 0.431T + 0.489 \quad [14.31]$$

for  $20 \geq T \geq -25$

Eq. 14.17 is solved numerically in the frozen, thawed, and phase change (mushy) regions, using the corresponding physical properties of each phase. Explicit finite difference method with controlled stability is used for the numerical solution.

In this analysis, the meat is assumed insulated both thermally and from microwaves at its bottom and sides to maintain 1-D heating. Accordingly, zero heat flux is assumed at the bottom surface, while convective heating or cooling is assumed at the top surface, which is exposed to microwave radiation. The evaporative surface cooling is also included using the Chilton–Colburn Analysis.

The convection heat transfer coefficient calculated from correlations, available in the literature, is used to calculate the heat loss from the surface of the sample according to Newton's law of cooling:

At the surface ( $x = 0$ )

$$-k \frac{dT}{dy} = h(T_s - T_\infty) \quad [14.32]$$

at the bottom insulated surface ( $y = E$ )

$$\frac{dT}{dy} = 0 \quad [14.33]$$

During the early stages of thawing, heat transfer from the ambient has little effect on the thawing process. However, when the surface temperature rises significantly above the ambient, heat loss because of convection and evaporation causes some cooling on the surface and hence slows down the thawing process.

## 4.2 Discussion of Results

Complete thawing of meat by microwaves may not be practical because of excessive heating of the surface that is exposed to microwave heating. The simulation was conducted using controlled temperature heating (Figure 14.9). Microwave heating was stopped when the surface temperature reached 10°C, and it was started again when the surface temperature dropped below 10°C. The use of controlled surface temperature microwave thawing may reduce thawing times by more than one-fifth of those required by conventional thawing. Figure 14.9 shows that complete thawing has occurred after 100 min with the surface temperature not exceeding 10°C, and this helped to maintain the product quality. The corresponding time in conventional thawing, even under ambient temperature, is >500 min (Figure 14.10).

## NOMENCLATURE

<b>A</b>	Heat and mass transfer area, m <sup>2</sup>
<b>Bi</b>	Modified Biot Number, $Bi = hL/k_{cr}$ for slab or $hr_0/k_{cr}$ for sphere
<b>Ca</b>	Concentration, kg m <sup>-3</sup>
<b>Cp</b>	Specific heat capacity of the material core, J/kg K
<b>Cp<sub>e</sub></b>	Effective heat capacity of meat, J/kg K
<b>Cp<sub>s</sub></b>	Specific heat capacity of frozen meat, J/kg K

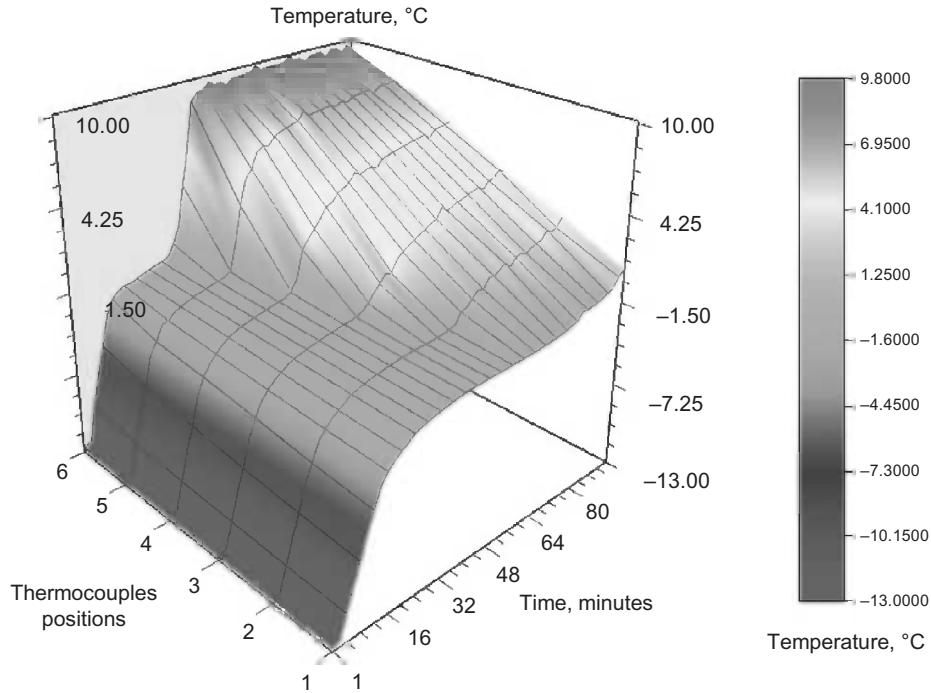
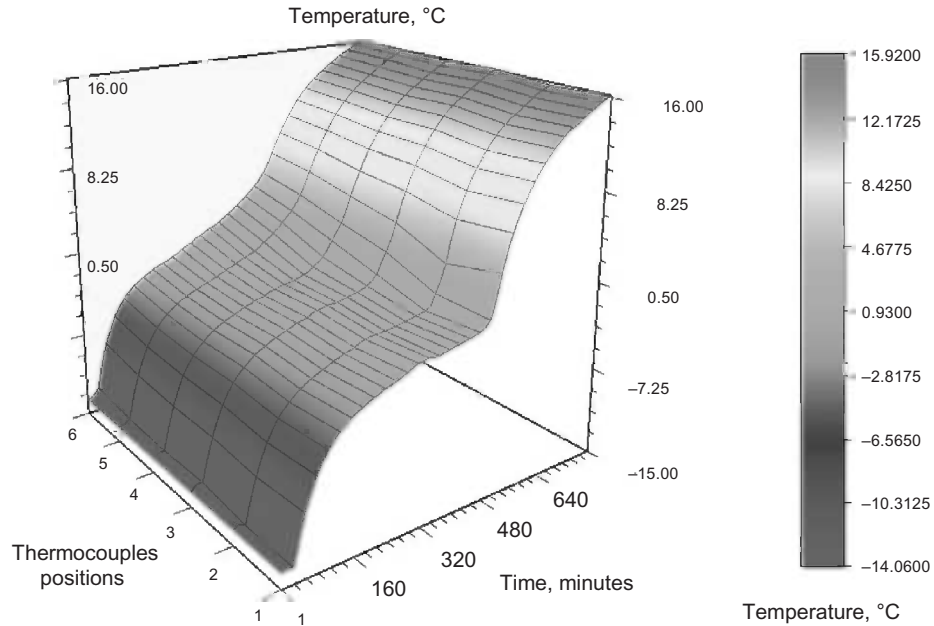


Figure 14.9 Model prediction for microwave thawing of 1.5 kg frozen meat sample with 28% power rating and surface temperature controlled (Ta<sub>h</sub>er and Farid, 2001).

<b>d</b>	Ordinary derivative
<b>D</b>	Diffusivity, $\text{m}^2 \text{s}^{-1}$
<b>D<sub>pl</sub></b>	Penetration depth of the thawed phase, m
<b>D<sub>ps</sub></b>	Penetration depth of frozen phase, m
<b>E</b>	Meat sample thickness, m
<b>F</b>	Radiation shape factor, dimensionless
<b>F<sub>o</sub></b>	Modified Fourier Number, $F_o = k_{cr}t/(\rho C_p)$
<b>h</b>	Heat transfer coefficient, $\text{W}/\text{m}^2 \text{K}$
<b>hm</b>	Mass transfer coefficient
<b>K'</b>	Relative dielectric constant (dimensionless)
<b>K''</b>	Relative dielectric loss (dimensionless)
<b>K</b>	Thermal conductivity, $\text{W}/\text{m K}$
<b>k</b>	Thermal conductivity, $\text{W}/\text{m K}$
<b>k<sub>cr</sub></b>	Thermal conductivity of crust, $\text{J}/\text{s mK}$
<b>L</b>	Characteristic dimension, m
<b>m</b>	Mass of material, kg
<b>Nu</b>	Nusselt number, $hL/k$
<b>P</b>	Microwave power, W
<b>p</b>	Pressure, $\text{Nm}^{-2}$
<b>Pr</b>	Prandtl number, $C_p\mu/k$
<b>q</b>	Heat flow, W



**Figure 14.10** Experimental measurements for conventional thawing of 1.5 kg frozen minced beef sample with ambient temperature = 21°C (Basak and Ayappa, 1997).

<b>Q</b>	Microwave heat absorption, $\text{W}/\text{m}^3$
<b><math>Q_f</math></b>	Microwave heat absorbed in the frozen region, $\text{W}/\text{m}^3$
<b><math>Q_o</math></b>	Microwave surface heat absorption, $\text{W}/\text{m}^3$
<b><math>Q_{th}</math></b>	Microwave heat absorbed in the thawed region, $\text{W}/\text{m}^3$
<b>r</b>	Radial position or coordinate
<b>R</b>	Drying/frying rate (defined by Eq. 14.14), $\text{kg water m}^{-2} \text{s}^{-1}$
<b><math>R^*</math></b>	Dimensionless drying/frying rate (defined by equation 15)
<b>Re</b>	Reynold number, $\rho u L / \mu$
<b>Ste</b>	Modified Stefan Number, $S_{te} = C_p (T_\infty - T_{critical}) / (\epsilon_0 \lambda)$
<b>T</b>	Time, s
<b>T</b>	Temperature, °C
<b><math>T_\infty</math></b>	Ambient temperature, °C
<b><math>T_{av}</math></b>	Average temperature $T_{av} = (T_s + T_m)/2$ , °C
<b><math>T_i</math></b>	Initial temperature, °C
<b><math>T_{m1}</math></b>	Initial melting temperature, °C
<b><math>T_{m2}</math></b>	Final melting temperature, °C
<b><math>T_\infty</math></b>	Fluid bulk temperature, °C
<b><math>T_s</math></b>	Surface temperature, °C
<b><math>T_{critical}</math></b>	Solidification, sublimation, evaporation, or wet-bulb temperature, °C
<b>v, u</b>	Velocity, $\text{m s}^{-1}$
<b>W</b>	Water content, kg water/kg meat
<b>y</b>	Position from surface, m
<b>Y</b>	Interface position, m



## GREEK SYMBOLS

$\alpha$	Thermal diffusivity, $\text{m}^2 \text{s}^{-1}$
$\beta$	Thermal expansion coefficient, $\text{K}^{-1}$
$\lambda$	Latent heat of solidification, evaporation, or sublimation, $\text{J kg}^{-1}$
$\rho$	Density, $\text{kg m}^{-3}$
$\partial$	Partial derivative
$\epsilon_0$	Initial free moisture content, $\text{kg water/kg total}$
$\epsilon_1$	Emittance
$\sigma$	Stefan Boltzmann constant, $\text{W m}^{-2} \text{K}^{-4}$
$\mu$	Dynamic viscosity, $\text{kg m}^{-1} \text{s}^{-1}$

## REFERENCES

- Arzan, A.A., Morgan, R.P., 1967. A two-region, moving boundary analysis of the drying process. *Chem. Eng. Prog. Symp.* 79 (63), 24–33.
- Basak, T., Ayappa, K.G., 1997. Analysis of microwave thawing of slabs with effective heat capacity method. *J. AIChE* 43, 1662–1674.
- Carn, R.M., King, C.J., 1977. Modification of conventional freeze dryers to accomplish limited freeze-drying. *AIChE Symposium Series No. 163*, 73, pp. 103–112.
- Chamchong, M., Datta, A.K., 1999a. Thawing of foods in a microwave oven: effect of power levels and power cycling. *J. Microw. Power Electromag. Ener.* 34, 9–21.
- Chamchong, M., Datta, A.K., 1999b. Thawing of foods in a microwave oven: effect of load geometry and dielectric properties. *J. Micro. Pwr. Electromag. Ener.* 34, 22–32.
- Farid, M.M., 2001. A unified approach to the heat and mass transfer in melting, solidification, frying and different drying processes. *Chem. Eng. Sci.* 56, 5419–5427.
- Farid, M.M., 2002. The moving boundary problems from melting and freezing to drying and frying of food. *Chem. Eng. Proc.* 41, 1–10.
- Farid, M.M., Chen, X.D., 1998. The analysis of heat and mass transfer during frying of food using a moving boundary solution procedure. *Heat Mass Trans.* 34, 69–77.
- Farkas, B.E., Singh, R.P., Rumsey, T.R., 1996. Modeling heat and mass transfer in immersion frying. II, model solution and verification. *J. Food Eng.* 29, 227–248.
- Ghani, A.G., Farid, M.M., Chen, X.D., Richards, P., 1999a. An investigation of deactivation of bacteria in canned liquid food during sterilization using computational fluid dynamics (CFD). *J. Food Eng.* 42, 207–214.
- Ghani, A.G., Farid, M.M., Chen, X.D., Richards, P., 1999b. Numerical simulation of natural convection heating of canned food by computational fluid dynamics. *J. Food Eng.* 41, 55–64.
- Ghani, A.G., Farid, M.M., Chen, X.D., 2000. Thermal sterilization of canned food in a 3-D pouch using computational fluid dynamics. *J. Food Eng.* 48, 147–156.
- Ghani, A.G., Farid, M.M., Chen, X.D., Richards, P., 2001. A computational fluid dynamics study on the effect of sterilization on bacteria deactivation and vitamin destruction. *Proc. Inst. Mech. Eng.* 215 (E), 9–17.
- Ghani, A.G., Farid, M.M., Chen, X.D., 2002. Numerical Simulation of transient temperature and velocity profiles in a horizontal can during sterilization using computational fluid dynamics. *J. Food Eng.* 51, 77–83.
- Hill, J.M., Marchent, T.R., 1996. Modeling microwave heating. *Appl. Math Model.* 20.
- Holman, J.P., 1992. *Heat Transfer*, seventh ed. McGraw-Hill, New York.
- Jafar, F., Farid, M.M., 2003. Analysis of heat and mass transfer in freeze drying. *Dry. Tech. Internat. J.* 21, 249–263.

- Li, Y.B., Yagoobi, J.S., Moreira, R.G., Yamsaengsung, E., 1988. Superheated steam impingement drying of tortilla chips. *Drying 1998: Proceedings of the Eleventh International Drying Symposium*, pp. 1221–1228.
- Mellor, J.D., 1978. Thermophysical properties of foodstuffs: 2. Theoretical aspects. *Bull. IIR* 58, 569.
- Mills, A.F., 1992. *Heat Transfer*. Richard Irwin, Inc, Boston.
- Mousa, N., Farid, M.M., 2002. Microwave vacuum drying of banana slices. *Drying Tech.* 20, 2055–2066.
- Mudgett, R.E., 1986. Microwave properties and heating characteristics in foods. *Food Tech.* 40, 84–93.
- Ozkan, N., Ho, I., Farid, M.M., 2004. Combined ohmic and plate heating of hamburger patties: quality of cooked patties. *J. Food Eng.* 63, 141–145.
- Pangrle, B.P., Ayappa, K.G., Davis, H.T., Gordon, J., 1991. Microwave thawing of cylinders. *J. AIChE* 37, 1789.
- Schwartz, J.P., McKinnon, A.J., Hocker, H., 1988. Experimental investigation of the through-drying of fibrous mats with superheated steam. *Drying 1998: Proceedings of the Eleventh International Drying Symposium*, pp. 1637–1644.
- Shafiq, R., 1995. *Food Properties Handbook*. CRC Press.
- Sheng, T.R., Peck, R.E., 1975. A model of freeze drying of foods and some influence factors on the process. *AIChE Symposium Series*, 37, pp. 124–130.
- Singh, R.P., 2000. Moving boundaries in food engineering. *Food Tech.* 54, 44–53.
- Smith, M.C., Farid, M.M., 2004. A single correlation for the prediction of dehydration time in drying and frying of samples having different geometry and size. *J. Food Eng.* 63, 265–271.
- Taher, B.J., Farid, M.M., 2001. Cyclic microwave thawing of frozen meat: experimental and theoretical investigation. *Chem. Engin. Proc.* 40, 379–389.
- Treybal, R.E., 1980. *Mass Transfer Operation*, second ed. McGraw-Hill, New York.

This page intentionally left blank

# Food Rheology

Qixin Zhong\* and Christopher R. Daubert\*\*

\*University of Tennessee, TN, USA

\*\*North Carolina State University, NC, USA

## 1. INTRODUCTION

Rheology is a field of research that studies flow and deformation (Macosko, 1994), which are encountered in everyday life. In the morning, we use a knife to apply butter on bread, we pour milk from a jar, and water runs through a faucet: all these processes involve flow and deformation. When we bite, chew, and swallow, we are also deforming the food. The texture we feel during consumption is one criterion we use to judge the quality of a product and determine whether or not we purchase it again. The texture of foods is a result of structures formed from food components via complex physical, chemical, and biological changes during processing and storage. These structures determine properties we sense, such as hardness, elasticity, and stickiness. Rheologists apply a fundamental approach in characterizing fluid flow properties important to food processing, as well as understanding interactions between food components and dynamics of structure formation critical for food quality.

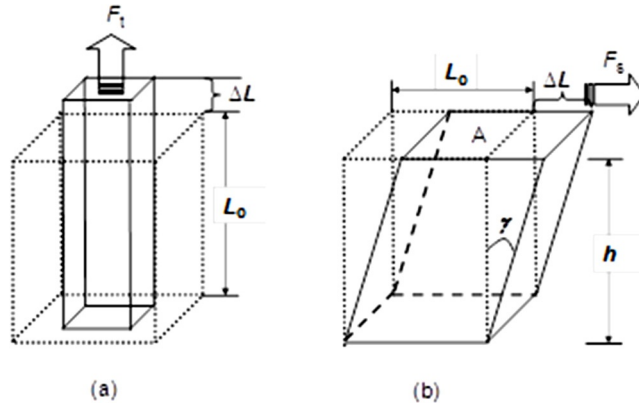
The motivation behind this chapter is to provide an introduction to scientists new to the field of food rheology. Basic rheological concepts will first be introduced, followed by rheology of fluids, semi-solid materials, and interfaces.

## 2. BASIC CONCEPTS IN RHEOLOGY

### 2.1 Stress and Strain

Rheologists are interested in the correlations between stress and strain and describe material properties based on parameters derived from stress and strain. In a rheological test, a material is subjected to a stress, and the strain under this stress is measured, or vice versa.

Stress is defined as a force divided by the area on which this force is applied. Both the magnitude and direction are needed to describe a force and a stress and such variables are called vectors. A force can be applied perpendicularly to a surface (Figure 15.1(a)), generating a normal stress, or parallel to a surface (Figure 15.1(b)), generating a shear stress.



**Figure 15.1** *Difference between a tensile deformation* (a) and a simple shear deformation (b): a tensile force ( $F_t$ ), acting perpendicular to area  $A$ , produces an extension  $\Delta L$ , whereas a shear force ( $F_s$ ), acting tangential to area  $A$ , produces an angular deformation  $\gamma$ . Dotted lines illustrate the position of the cylinder prior to a deformation.

A normal stress can be further defined as a tension or compression stress, depending on the direction of this force. A compression stress reduces the dimension of an object along a normal force, whereas a tension stress has the opposite effect.

The preference of using stress over force in rheology can be understood by examples from daily life. For example, a balloon is pierced easily by a needle. However, if a force with the same magnitude and direction is applied with our palms, the balloon is unlikely to burst. When a force is applied perpendicularly to the balloon surface via a needle, a big stress is generated because of a small area (needle tip). Conversely, the stress is much smaller when the force is applied by the palms that have an area much bigger than a needle tip.

Different types of stresses generate different types of strains. The deformation caused by a normal stress is expressed by a strain called Cauchy ( $\epsilon_c$ ) or engineering strain (Eq. 15.1). Cauchy strain can be positive or negative depending on the direction of stress. An extensional strain (Figure 15.1(a)) is positive, whereas a compression strain is negative. For convenience, a compression strain is expressed in its absolute value with a subscript of compression (Daubert and Foegeding, 1998), illustrated in Eq. 15.2 for a compression strain of  $-0.05$ .

$$\epsilon_c = \frac{\Delta L}{L_0} \quad [15.1]$$

where  $\Delta L$  is deformation generated by a stress on an object of an original dimension of  $L_0$  along the stress direction.

$$\epsilon_c = -0.05 = 0.05_{\text{compression}} \quad [15.2]$$

In the case of a shear deformation (Figure 15.1(b)), a shear strain ( $\gamma$ ) is defined as the longitudinal deformation ( $\Delta L$ ) referenced to the sample height ( $h$ ):

$$\tan(\gamma) = \frac{\Delta L}{h} \quad \text{or} \quad \gamma = \tan^{-1}\left(\frac{\Delta L}{h}\right) \quad [15.3]$$

For a small deformation, an approximation exists as

$$\gamma \approx \tan(\gamma) = \frac{\Delta L}{h} \quad [15.4]$$

When a strain is not constant over time (e.g. deformation increases continuously), a term of shear strain rate (Eq. 15.5) is used to describe the rate of shear strain change with respect to time. The significance of shear strain rate will be discussed in later sections.

$$\dot{\gamma} = \frac{d\gamma}{dt} \quad [15.5]$$

## 2.2 Constitutive Relations and Classification of Materials

Fundamental relations between force and deformation in a material are described with constitutive relationships in fluid mechanics (Macosko, 1994). Hooke's law is the first constitutive equation that describes the proportionality of a deformation caused by a stress (Eq. 15.6). A material obeying Hooke's law is called an ideal solid or a pure elastic material. A mechanical analog of an ideal solid is a spring that deforms linearly with a finite force (Figure 15.2). After finite deformation, a spring returns to its

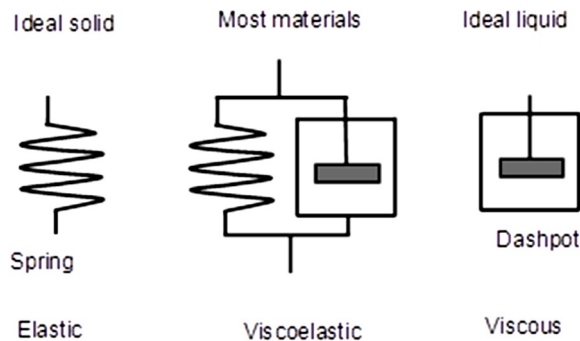


Figure 15.2 Mechanical analogs used to describe different categories of materials: spring for an ideal solid, dashpot for an ideal liquid, and a combination of spring and dashpot for a viscoelastic material.

original position when the force is removed. In other words, an ideal solid (a spring) is able to store the applied mechanical energy.

$$\sigma = G\gamma \quad [15.6]$$

where  $\sigma$  is shear stress, and  $G$  is elastic shear modulus, a constant describing the proportionality between shear stress and shear strain.

Conversely, a constitutive equation for an ideal liquid or a pure viscous material is Newton's law of viscosity:

$$\sigma = \mu\dot{\gamma} \quad [15.7]$$

where  $\mu$  is the Newtonian viscosity describing the proportionality between shear stress and shear strain rate. Fluids obeying this equation are thus called Newtonian fluids. For a pure viscous material, the mechanical energy applied to this material is converted to other forms of energy and cannot be recovered after deformation. A dashpot (Figure 15.2) is a mechanical analog for a pure viscous material, because the piston stays at its position after the force enabling its movement is released.

The previous equations are important when describing a material with ideal rheological behavior. In reality, many materials have both viscous and elastic properties so are called viscoelastic materials. When energy is applied, a portion of the energy is stored and can be recovered, while the remaining energy dissipates as heat and can no longer be recovered (Ferry, 1980). "Solid-like" and "liquid-like" terms are sometimes exchangeable with "elastic" and "viscous" when describing a viscoelastic material.

Food products demonstrate various properties that can be categorized according to the above classification method. These properties may be correlated with sensory properties experienced by human beings. For example, water, vegetable oil, and honey are all examples of Newtonian fluids that flow freely. Honey is more viscous than vegetable oil and water when measured by a rheological instrument and felt by fingertips. Dough is a viscoelastic material because it can return to its original position after a slight deformation but can be kneaded upon extended deformation. The difference between viscous and viscoelastic properties can be illustrated by comparing mayonnaise with honey. Mayonnaise remains on a slice of bread unless it is spread by a knife because it is a viscoelastic material. However, honey is a Newtonian material that may be more viscous (thicker) than mayonnaise. When placed on bread, the honey will flow over and into the bread.

### 2.3 The Importance of Timescale of Deformation, Deborah Number

As rheology is about the deformation of matter, it is important to understand the timescale at which this deformation takes place. "Silly putty" is an example of why the timescale of deformation must be incorporated into the description of material properties. If a silly putty ball is set on a table (on a long timescale), the ball will slowly

flatten, that is, it flows under the gravitational force like a viscous material. However, if this ball is thrown against a wall (at a short timescale), it bounces back like an elastic rubber ball, that is, it behaves like an elastic material. Thus, timescales in food processing unit operations and those during consumption (oral processing) are to be considered along with material properties during development of processes and products.

The Deborah number ( $D_e$ ) is such a dimensionless parameter used to compare the time for a material to adjust to a deformation, i.e. relaxation time ( $t$ ) to the characteristic time of a deformation process ( $T$ ):

$$D_e = \frac{t}{T} \quad [15.8]$$

A small Deborah number ( $D_e \ll 1$ ) indicates that a material behaves as a fluid when  $T$  is much bigger than  $t$ . The same material can behave like a solid at a large Deborah number ( $D_e \gg 1$ , i.e.  $T \ll t$ ).

### 3. RHEOLOGY OF FLUIDS

#### 3.1 Shear Strain Rates in a Laminar Flow

For a fluid between two parallel plates, with one plate (A) moving at a constant velocity ( $u$ ) and the other (B) stationary (Figure 15.3), a similar shear condition as in Figure 15.1(b) is established when the fluid adjacent to each plate has the same velocity as the respective plate (no slip condition) and the fluid velocity in the fluid gap has a linear distribution from 0 to  $u$ . The velocity and the deformation ( $\Delta L$ ) in time  $\Delta t$  can then be correlated as in Eq. 15.9. The fluid between two plates can be hypothetically divided into an indefinite number of fluid layers (Figure 15.3). When all of these layers flow parallel to each other under shear, the flow profile between two parallel plates is called streamline (laminar) flow. The velocity profile between these two plates in this special case increases linearly from a velocity of zero at plate B to a velocity of

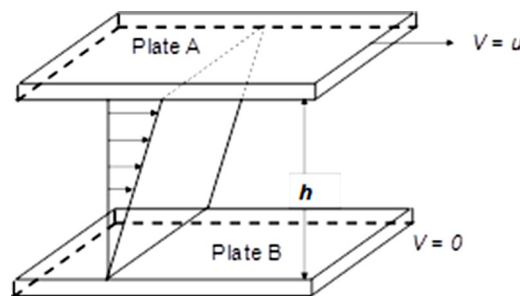


Figure 15.3 A steady shear between two parallel plates with plate A moving at a velocity of  $u$  and plate B being fixed.



$u$  at plate A, and the shear strain is the same throughout the gap between these two plates. The shear strain rate between these two plates can then be described according to Eq. 15.10. As shear rate varies in different processes (see examples in Barnes *et al.*, 1989) and simple shear conditions are used to calculate results in many advanced rheometers, attention must be made to ensure laminar flow conditions are met during rheological tests at the selected shear rate range.

$$u = \frac{\Delta L}{\Delta t} \quad [15.9]$$

$$\dot{\gamma} = \frac{d\gamma}{dt} = \frac{dL/h}{dt} = \frac{u}{h} \quad [15.10]$$

### 3.2 Apparent Viscosity and Yield Stress

As discussed previously, a pure viscous fluid obeys Newton's law of viscosity, that is, shear stress is proportional to shear rate with the proportionality constant being the Newtonian viscosity. However, many foods and non-food materials cannot be so simply described. A typical phenomenon is that some materials demonstrate different viscosities under different shear rates. In other words, the ratio of shear stress to shear rate is a function of shear rate. To distinguish these fluids, the term "apparent viscosity ( $\eta$ )" is used to represent this ratio:

$$\eta = f(\dot{\gamma}) = \frac{\sigma}{\dot{\gamma}} \quad [15.11]$$

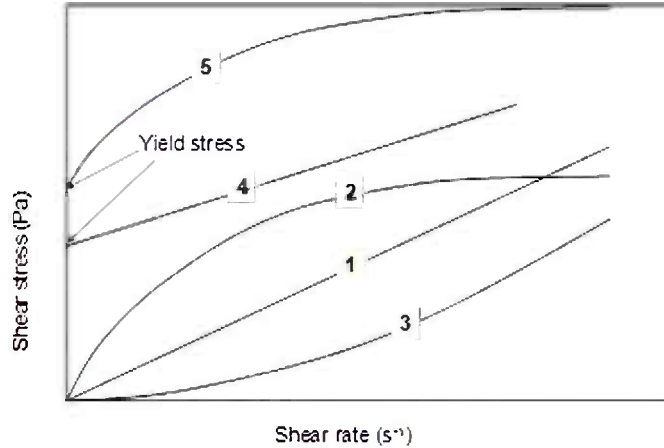
Another situation is that some fluids will not flow unless they are subjected to a sufficient amount of force (stress). For example, ketchup does not flow from a bottle until the bottle is squeezed (sheared) to a certain degree. The stress required to initiate this flow is called the "yield stress".

### 3.3 Rheological Models for Fluids

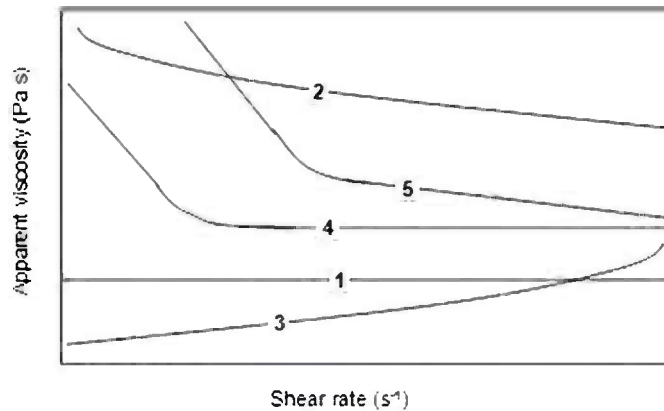
Typical curves for shear stress—shear strain rate plots (called rheograms) are illustrated in Figure 15.4 and those for apparent viscosity—shear strain rate (derived from the stress response) are shown in Figure 15.5. To establish correlations between shear stress and shear strain rate, rheologists generated many models to describe Newtonian and non-Newtonian fluids. For food products, the Herschel–Bulkley model (Eq. 15.12) is of practical significance because it incorporates a yield stress ( $\sigma_o$ ). Fluids are then classified into different types according to the magnitude of  $\sigma_o$ ,  $K$ , and  $n$ , discussed below.

$$\sigma = \sigma_o + K\dot{\gamma}^n \quad [15.12]$$

where  $K$  is the consistency coefficient and  $n$  is the flow behavior index.



**Figure 15.4 Rheograms of different fluids:** 1) Newtonian; 2) shear-thinning (pseudo-plastic); 3) shear-thickening (dilatent); 4) Bingham plastic; and 5) Herschel–Bulkley.



**Figure 15.5 Apparent viscosity as a function of shear rate for different types of fluids:** 1) Newtonian; 2) shear-thinning (pseudo plastic); 3) shear-thickening; 4) Bingham plastic; and 5) Herschel–Bulkley.

### 3.3.1 Newtonian Fluids ( $\sigma_o = 0$ , $n = 1$ , $K = \mu$ )

Newtonian fluids do not have a yield stress, that is, they deform immediately under a small stress. Comparing Eq. 15.7 with Eq. 15.12, it is clear that in the Herschel–Bulkley model, yield stress is zero, the flow behavior index is 1.0, and the consistency coefficient is the Newtonian viscosity (Eq. 15.7). Honey, olive oil, raw milk, water, and air are examples of Newtonian fluids with viscosities of 11.0, 0.084, 0.002, 0.001, and 0.0000181 Pa-s, respectively, at 20°C (Daubert and Foegeding, 1998).

### 3.3.2 Power-Law Fluids ( $\sigma_o = 0$ )

These fluids do not have a yield stress, similar to a Newtonian fluid, and have a rate-dependent viscosity. When plotting apparent viscosity against shear strain rate (Figure 15.5), some power-law fluids have smaller apparent viscosities at higher shear strain rates and are called shear-thinning or pseudo-plastic fluids. Others show larger apparent viscosities at higher shear rates, called shear-thickening or dilatent fluids. The difference between these two types of fluids in a rheogram is a declining slope ( $n < 1$ ) with an increase in shear rate for shear-thinning fluids and an inclining slope ( $n > 1$ ) for shear-thickening fluids (Figure 15.4). For power-law fluids, the Herschel–Bulkley equation is simplified as

$$\sigma = K\dot{\gamma}^n \quad [15.13]$$

### 3.3.3 Bingham Plastic Fluids ( $\sigma_o > 0$ , $n = 1$ , $K = \mu_{pl}$ )

These fluids have a yield stress, and the curve appears to be a straight line in a rheogram, similar to Newtonian fluids. However, the intercept of the curve (yield stress) is greater than zero (Figure 15.4). The symbol used to describe this linearity is called the plastic viscosity ( $\mu_{pl}$ ), and the Herschel–Bulkley model is rewritten as

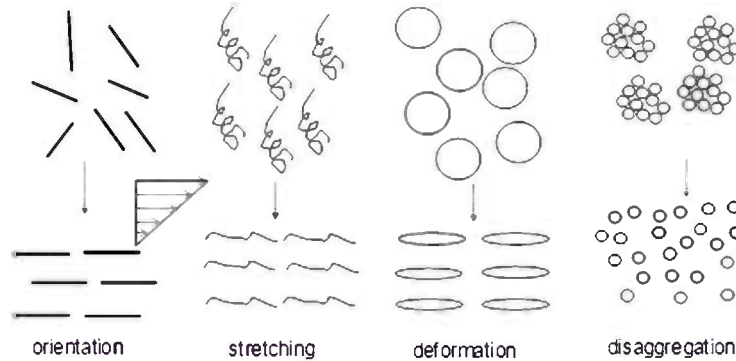
$$\sigma = \sigma_o + \mu_{pl}\dot{\gamma} \quad [15.14]$$

### 3.3.4 Herschel–Bulkley Fluids ( $\sigma_o > 0$ , $\infty > n > 0$ , $K > 0$ )

These fluids also have a yield stress, but unlike Bingham plastic fluids, the curve does not appear to be a straight line in a rheogram. Instead, the curve looks similar to that of a pseudo-plastic fluid at a stress greater than shear stress. Eq. 15.12 is the model for Herschel–Bulkley fluids.

### 3.3.5 Rheological Behavior Correlated with Structure

Newtonian fluids have minimal structure and require little force to initiate flow. For example, water flows easily. Bingham fluids, such as toothpaste, have a weak structure. This structure must be disturbed (with a stress greater than the yield stress) before flowing. Shear-thinning behavior of a material, such as apple sauce, is due to a weakened structure from the reorganization of structural elements during shearing. Possible mechanisms of shear-thinning behaviors can be found in Figure 15.6. Herschel–Bulkley fluids also have a structure that needs to be disrupted before they can flow, and the existence of a network results in a shear-thinning behavior upon further deformation. Many food gels exhibit such behavior.



**Figure 15.6 Possible structure rearrangements responsible for shear-thinning behaviors (top: at rest; bottom: upon shear).**

### 3.4 Rheometry

#### 3.4.1 Vane Method Used to Determine Yield Stress

Yield stress is an important parameter for evaluating the quality of food products. Different forces are required to initiate flow from the ketchup bottle before and after shaking, which means two yield stresses are associated with creating ketchup flow. In rheology, these two yield stresses are called dynamic yield stress and static yield stress. Dynamic yield stress is defined as the yield stress resulting from the chemical structure within the material that is insensitive to shearing. Static yield stress is caused by the structure formed within a material over time at rest and is a secondary yield stress when coupled with the dynamic yield stress. The difference between these two yield stresses is illustrated in [Figure 15.7](#).

Various methods can be used to determine the yield stress of a material, but the Vane method is a simple and practical technique for yield stress measurements in the food industry. The vane is a rheological attachment configured with different numbers of blades (four, six, or eight are common), each giving similar results ([Steffe, 1996](#)). [Figure 15.8](#) shows an example of a vane with four blades. In general, the height and diameter of a vane shall be a ratio of  $1.5 \leq h/d \leq 4.0$ , and the details of vane rheometry are provided in [Steffe \(1996\)](#).

When rotating a vane at a constant speed, the torque required to maintain this speed first increases and then decreases over time, with the maximum torque associated with the disruption of sample structure ( $M_o$ ). Yield stress is estimated from a single measurement according to the following equation:

$$\sigma_o = \frac{6 M_o d}{\pi d^3 (3 h + d)} \quad [15.15]$$

where  $d$  and  $h$  are the diameter and height of the vane, respectively.

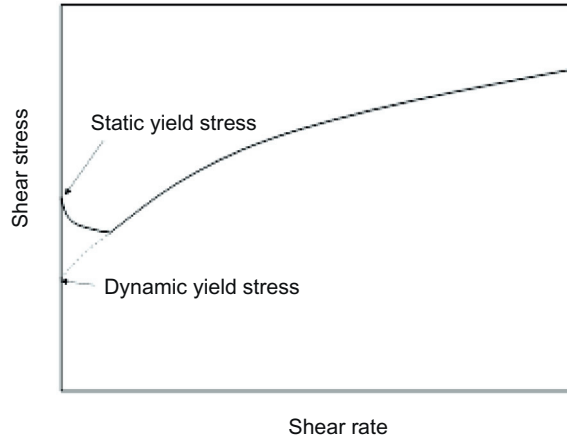


Figure 15.7 Difference between dynamic yield stress and static yield stress in a rheogram (Steffe, 1996).

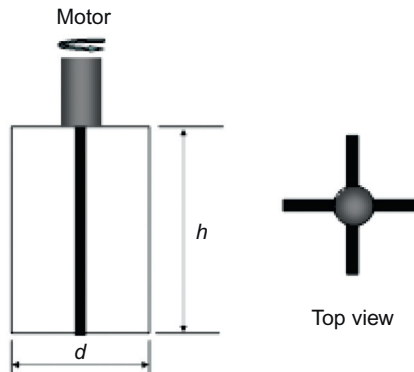


Figure 15.8 Sketch of a four-blade vane with a height of  $h$  and a diameter of  $d$ .

### 3.4.2 Rotational Rheometry

Rotational rheometry is a technique that can measure rheological properties of fluids and semi-solid materials. For a given rheological attachment of known geometrical parameters, fluid dynamics is used to analyze constitutive equations associated with the rotational deformation (Macosko, 1994). These principles have been incorporated in the software of advanced commercial rheometers to give rheological data. Tests can be programmed to shear a sample with a series of shear strain rates, shear strains, or shear stresses. Some simpler viscometers permit only one set of rotational parameters.

The derivations of shear stress and shear rate are described below for two common geometries used in steady shear tests (Daubert and Foegeding, 1998).

### 3.4.2.1 Concentric Cylinders

Two cylindrical parts are used in this type of test. The smaller solid part, called a bob, is usually attached to a sensing device that is connected to a transducer to give a torque during deformation. A cup is used to contain a sample. The bob, concentric to the cup, is immersed in the sample (Figure 15.9). When the cup is rotated by a motor, the setup is called a Couette system, while a Searle system represents the case where a bob is rotated by a motor and the cup is stationary. A bob or a cup can be rotated at a fixed angular velocity ( $\Omega$ ), and the torque ( $M$ ) needed to maintain this steady shear is recorded. An angular velocity is expressed in radians per second, which can be converted from revolutions per minute (rpm), according to the following equation:

$$1 \text{ rpm} = \frac{1 \text{ revolution}}{1 \text{ min}} \times \frac{2\pi \text{ radians}}{1 \text{ revolution}} \times \frac{1 \text{ min}}{60 \text{ sec}} = 0.1047 \text{ radians/sec} \quad [15.16]$$

For a bob with radius  $R_b$  and a cup of radius  $R_c$ , the shear stress and shear strain rate at the circular surface of the bob corresponding to  $R_b$  may be estimated as follows:

$$\sigma_b = \frac{M}{2 \pi h R_b^2} \quad [15.17]$$

$$\dot{\gamma}_b = \frac{\Omega R_b}{R_c - R_b} \quad [15.18]$$

### 3.4.2.2 Cone and Plate

The cone and plate configuration is another common arrangement for conducting steady shear tests (Figure 15.10). The angle of the cone is preferably small ( $\theta \approx 1^\circ$ ) to

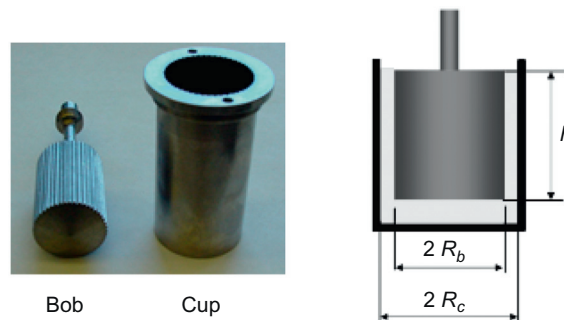


Figure 15.9 Illustration of concentric cylinders: bob and cup.

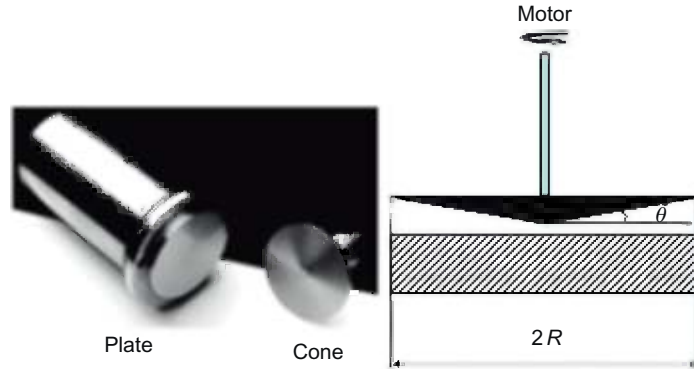


Figure 15.10 Illustration of a cone and plate configuration.

obtain good results. As a rule of thumb, particles shall be smaller than 1/10 of the gap between cone and plate. Shear stress and shear rate are constant in the gap and may be determined based on the torque and angular velocity according to Eq. 15.19 and 15.20:

$$\sigma = \frac{3M}{2\pi R^3} \quad [15.19]$$

$$\dot{\gamma} = \frac{\Omega}{\tan\theta} \quad [15.20]$$

### 3.4.2.3 Selection of Test Parameters

Concentric cylinders are suitable for low viscosity fluids and suspensions, whereas the cone and plate configuration is convenient for samples of a medium or high viscosity. Cone and plate configurations use a smaller amount of sample. The sensitivity of this configuration may be compromised by large particles, and a constant gap height must be maintained (Daubert and Foegeding, 1998). Selection of shear rates is dependent on the application (Barnes *et al.*, 1989).

## 4. RHEOLOGY OF SEMI-SOLID MATERIALS

Most semi-solid materials are viscoelastic materials whose properties cannot be simply differentiated based on viscosity alone. Two categories of rheological studies are used to understand viscoelastic materials: small strain (linear) and large strain (including non-linear and fracture/failure) rheology. In small strain tests, rheological data are obtained without changing the microstructure of a material. Although less commonly studied, non-linear viscoelasticity is of practical importance for food products because

of the mastication process during food consumption. Linear viscoelasticity will be the focus here.

Instead of using steady shear tests for fluids, unsteady shear measurements are used to provide a dynamic approach for studying viscoelasticity. The stress or strain is not a constant during the measurements and is usually applied to a sample so that this material can be characterized without perturbing the structure or structure development. Small strain measurements can be performed by the mode of oscillation, stress relaxation, or creep, as detailed below.

## 4.1 Small Amplitude Oscillatory Shear Tests

### 4.1.1 Principles of Measuring Viscoelastic Properties Using Oscillation (Ferry, 1980)

In these measurements, a sinusoidal strain (or stress) ensuring the linear viscoelasticity is applied to a material, and the corresponding stress (or strain) is then measured (Figure 15.11). Different materials respond to this sinusoidal strain differently. An ideal elastic material responds immediately to this strain, that is, there is no lag between stress and strain—a zero phase angle between strain and stress. For an ideal fluid such as water, the stress is  $90^\circ$  out of phase from strain: a maximum strain corresponds to a zero stress. For a viscoelastic material, the lag is between that of an ideal elastic solid and that of an ideal liquid: a phase angle between  $0$  and  $90^\circ$ .

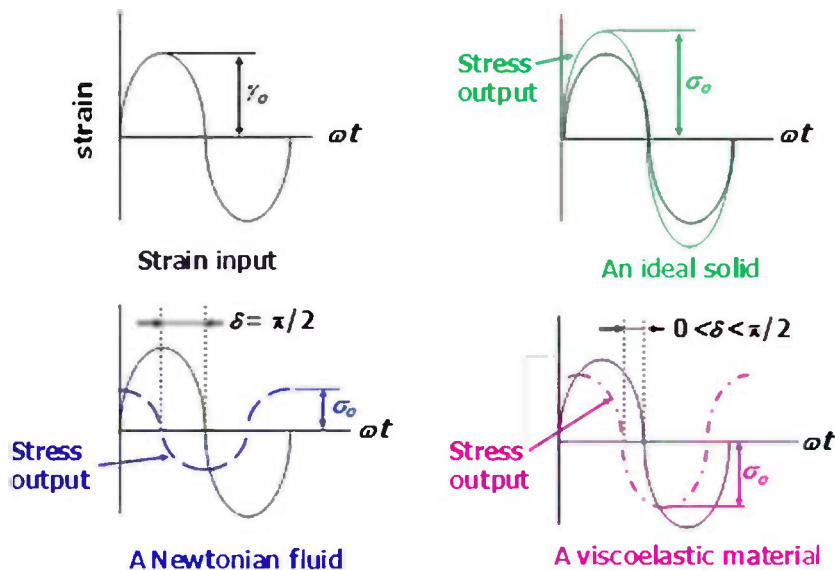


Figure 15.11 Stress responses of different materials to a sinusoidal strain.



Mathematically, when introducing a sinusoidal strain (Eq. 15.21), the strain rate can be written as Eq. 15.22:

$$\gamma(t) = \gamma_o \sin(\omega t) \quad [15.21]$$

$$\dot{\gamma} = \omega \gamma_o \cos(\omega t) \quad [15.22]$$

where  $\gamma$  is the strain at a corresponding time ( $t$ ),  $\gamma_o$  is the magnitude of the sinusoidal strain,  $\omega$  is the oscillatory frequency, and  $\dot{\gamma}$  is the strain rate.

Shear modulus at a time  $t$  is expressed by a ratio of stress over strain as

$$G(t) = \sigma(t)/\gamma(t) \quad [15.23]$$

A shear strain can be expressed as an integral of strain rate over time that starts with a time long before current time. In mathematics, we use a variable, past time ( $t'$ ), to distinguish current time, and the integral can be expressed as

$$\gamma(t) = \int_{-\infty}^t \dot{\gamma}(t') dt' \quad [15.24]$$

After reorganizing Eq. 15.23 and substituting  $\gamma(t)$  with Eq. 15.24, we have

$$\sigma(t) = \int_{-\infty}^t G(t-t') \dot{\gamma}(t') dt' \quad [15.25]$$

After transforming  $s = t - t'$  and substituting Eq. 15.22 for  $\dot{\gamma}(t')$ , Eq. 15.25 can be rewritten as

$$\begin{aligned} \sigma(t) &= \int_0^{\infty} G(s) \omega \gamma_o \cos[\omega(t-s)] ds \\ &= \gamma_o \left[ \omega \int_0^{\infty} G(s) \sin(\omega s) ds \right] \sin(\omega t) + \gamma_o \left[ \omega \int_0^{\infty} G(s) \cos(\omega s) ds \right] \cos(\omega t) \\ &= \gamma_o [G' \sin(\omega t) + G'' \cos(\omega t)] \end{aligned} \quad [15.26]$$

where  $G'$  is the in phase component called storage or elastic modulus, and  $G''$  is the out of phase component called loss or viscous modulus.

In a dynamic test, stress is out of phase with strain for a viscoelastic material. Defining a phase angle ( $\delta$ ) as the parameter related to the energy lost per cycle divided by the energy stored per cycle, stress can also be written in a sinusoidal format as

$$\sigma(t) = \sigma_o \sin(\omega t + \delta) \quad [15.27]$$

The expansion of the above equation gives

$$\sigma(t) = \sigma_o \cos \delta \sin(\omega t) + \sigma_o \sin \delta \cos(\omega t) \quad [15.28]$$

Comparing Eq. 15.28 and 15.26, the following equations are derived:

$$G'(\omega) = \omega \int_0^{\infty} G(s) \sin(\omega s) ds = (\sigma_o / \gamma_o) \cos \delta \quad [15.29]$$

$$G''(\omega) = \omega \int_0^{\infty} G(s) \cos(\omega s) ds = (\sigma_o / \gamma_o) \sin \delta \quad [15.30]$$

In the vector form, the  $G'$ ,  $G''$ , and  $d$  are inter-correlated (Figure 15.12, Eq. 15.31), and the complex modulus ( $G^*$ ) can be defined as in Eq. 15.32, with a magnitude in Eq. 15.33):

$$\tan \delta = G'' / G' \quad [15.31]$$

$$G^* = G' + iG'' \quad [15.32]$$

$$G^* = \frac{\sigma_o}{\gamma_o} = \sqrt{G'^2 + G''^2} \quad [15.33]$$

#### 4.1.2 Setting up Oscillatory Measurement Parameters

Oscillation tests can be performed using concentric cylinders or the cone and plate configuration discussed previously. The following parameters are to be determined when designing an experiment.

##### 4.1.2.1 Strain Amplitude

As mentioned previously, oscillatory measurements are based on the assumption that the applied strain is within the linear viscoelasticity regime (LVR), that is, the applied deformation will not affect the material properties, such as structure. To determine whether or not a strain is within the LVR, a material is usually subjected to a strain or stress sweep by shearing the material in a strain/stress range at a fixed frequency. A typical result from a strain or stress sweep test is illustrated in Figure 15.13. Data can be divided into two regimes: one regime showing independence of moduli

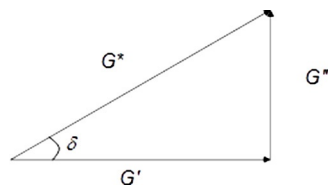
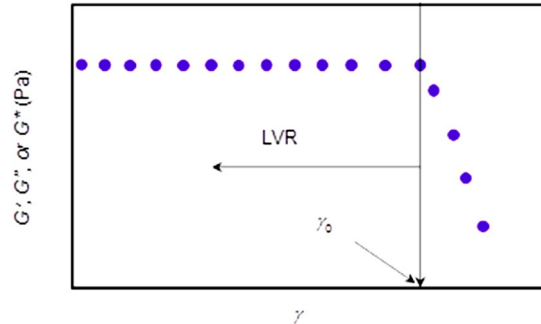


Figure 15.12 Correlations among  $G^*$ ,  $G'$ ,  $G''$ , and  $\delta$ .



**Figure 15.13** Illustration of a typical strain sweep test used to determine the limit of linear viscoelastic regime of a material. At the small strain regime, moduli are independent on the strain applied, and this regime is called the LVR. Moduli show strain-dependence at larger strains, i.e. non-linear regime. The strain dividing data into these two regimes is called the limit of LVR ( $\gamma_0$ ).

with stress or strain (linear viscoelastic regime) and the other regime showing stress (or strain) dependence. The strain or stress dividing these two regimes is called the limit of linear viscoelastic regime ( $\gamma_0$ ).

#### 4.1.2.2 Oscillation Frequency

To program an oscillatory test, oscillatory data must be collected during at least one complete cycle of a sinusoidal curve. The reciprocal of time to complete a cycle is known as the frequency of oscillation. The time to complete a sinusoidal cycle can be estimated by dividing  $2\pi$  (radian of a cycle) by  $\omega$  (oscillatory frequency in radians/s). For example, at a frequency of 0.001 radians/s, it takes 6,280s ( $2\pi/0.001$ ) or 105 min to complete a cycle! For applications in food process engineering, a frequency range between 0.01 and 100 radians/s is usually recommended (Steffe, 1996).

#### 4.1.2.3 Frequency Sweep

Frequency sweep tests are used to characterize the mechanical spectra of a material by oscillating this material in a wide range of frequencies (usually within 0.01 and 100 radians/s) at a fixed strain or stress within the limit of LVR. The data typically indicate that the material is one of three types (Figure 15.14): gels, concentrated solutions, and dilute solutions. For gels, the storage modulus is always greater than the loss modulus. For concentrated solutions, the storage modulus is smaller than the loss modulus at low frequencies and greater at high frequencies, and there is a cross-over between storage and loss moduli within the frequency range. For dilute solutions, the loss modulus is always greater than the storage modulus.

It is also informative to look at the phase angles within the frequency regime (Figure 15.15) for different types of materials. Newtonian materials are pure viscous and their elastic modulus is always zero: a phase angle of  $90^\circ$  according to Eq. 15.31.

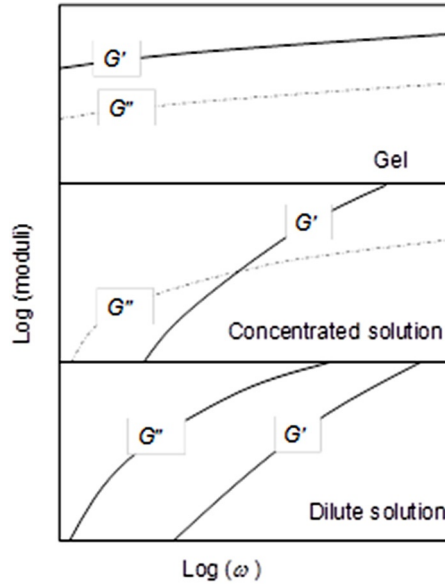


Figure 15.14 Frequency sweeps of three types of viscoelastic materials: gels, concentrated solutions, and dilute solutions.

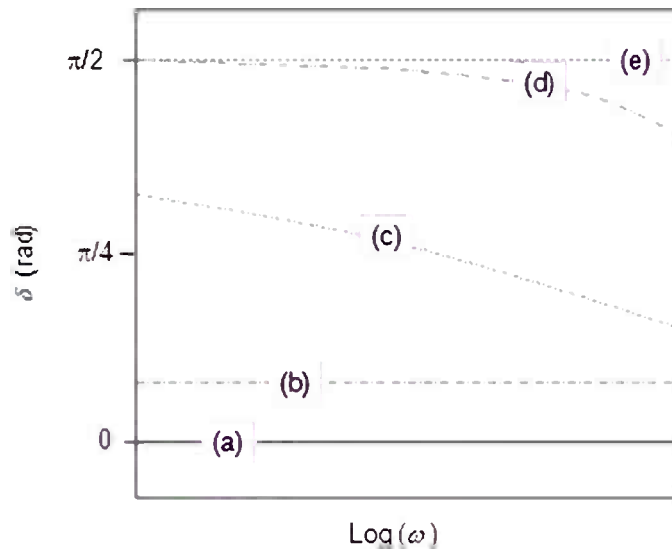


Figure 15.15 Phase angles of five types of materials during frequency sweep tests: (a) an ideal solid, (b) a gel, (c) a concentrated solution, (d) a dilute solution, and (e) an ideal fluid (Steffe, 1996).

A Hookian solid is pure elastic and its loss modulus is always zero: a phase angle of zero. For gels, it usually has a constant ratio of loss modulus to storage modulus, that is, a constant phase angle between  $0^\circ$  and  $45^\circ$  ( $\pi/4$ ). For concentrated solutions, their loss modulus dominates at low frequencies, that is, a phase angle  $>45^\circ$  (tangent of phase angle  $>1$ ). At high frequencies, the storage modulus dominates, and the phase angle is  $<45^\circ$ , meaning the behavior is more like a solid. For dilute solutions, the loss modulus is usually more significant than the elastic modulus (especially at the low frequency regime) even though they become more solid-like at high frequencies. Frequency dependency of materials is important for process design and product quality evaluation, as previously discussed for Deborah numbers (Eq. 15.8).

## 4.2 Stress Relaxation Tests

In this mode of measurements, a material is subjected to a sudden strain ( $\gamma_{\text{step}}$ ) at a time,  $t$ , of zero, and this strain is then held at a constant while measuring the stress ( $\sigma$ ) needed to maintain this deformation over time (Figure 15.16). For an ideal solid, the stress will be a constant over time, as indicated by Hooke's law (Eq. 15.6). For a pure viscous liquid, this stress will become zero in “no” time because even a small deformation will cause this liquid to flow and the structure can be re-equilibrated. For a viscoelastic material, an equilibrium stress is a function of material properties: a viscoelastic liquid will reach a stress of zero if given enough time to reach equilibrium,

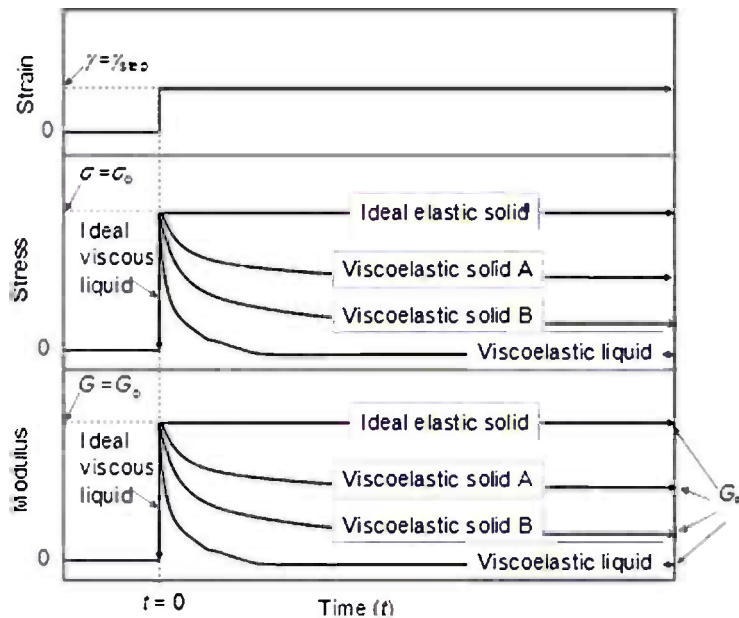


Figure 15.16 Responses of different materials during stress relaxation tests.

while a viscoelastic solid will reach a stress greater than zero when in equilibrium. The closer the equilibrium stress is to the initial stress, the more elastic is the material. For example, a viscoelastic solid A in [Figure 15.16](#) is more elastic than a viscoelastic solid B.

The modulus of a material during relaxation may be fit to a modified Maxwell model ([Eq. 15.34](#)). Both  $G_\infty$  and  $\tau$  are characteristics of a material.  $G_\infty$  equals  $G_0$  for an ideal elastic solid, zero for an ideal viscous liquid and a viscoelastic liquid (e.g. mayonnaise), and a value between zero and  $G_0$  for a viscoelastic solid (e.g. cheddar cheese). The relaxation time describes how slowly  $G$  decreases from its initial value and is defined as the time it takes for the stress to decay to  $1/e$  ( $e$  being the base of the natural logarithm, 2.72) or 36.8% of its initial value. When looking at rheological data ( $G$ ),  $t$  is the time when  $G = G_\infty + 0.368(G_0 - G_\infty)$ .

$$\frac{\sigma}{\gamma_{step}} = G(t|_{t>0}) = G_\infty + (G_0 - G_\infty)\exp\left(-\frac{t}{\tau}\right) \quad [15.34]$$

where  $G_0$  is the initial modulus at time of zero,  $G_\infty$  is the equilibrium modulus for various materials, and  $\tau$  is the relaxation time.

Stress relaxation tests can be performed in the modes of compression, extension, or shear. It should be noted that rheological data of some materials do not fit this modified Maxwell model well and more complicated models will be needed for these materials.

### 4.3 Creep Tests

In this category of measurements, a material is subjected to a sudden stress ( $\sigma_{step}$ ) at time zero, and this stress is then held at a constant for a period of time and then released while measuring the deformation over time ([Figure 15.17](#)). For an ideal solid, the deformation will be seen immediately when the stress is applied and will disappear immediately once the stress is removed (imagine compressing or pulling a spring). In other words, the structure of an ideal solid can be recovered completely. An ideal liquid flows with this applied stress, and strain thus increases with time. When this stress is removed, an ideal liquid stays at the deformed position without going back to its initial position to any degree, that is, there is no recovery because it reaches its new equilibrium state in no time. The behavior of a viscoelastic material lies between these two extremes and there is a permanent deformation at equilibrium. The degree of recovery is thus an indication of the elasticity of a material.

Analogous to relaxation modulus, there is a parameter called compliance modulus ( $J$ , defined as strain divided by stress) to describe the recovering process. Readers are

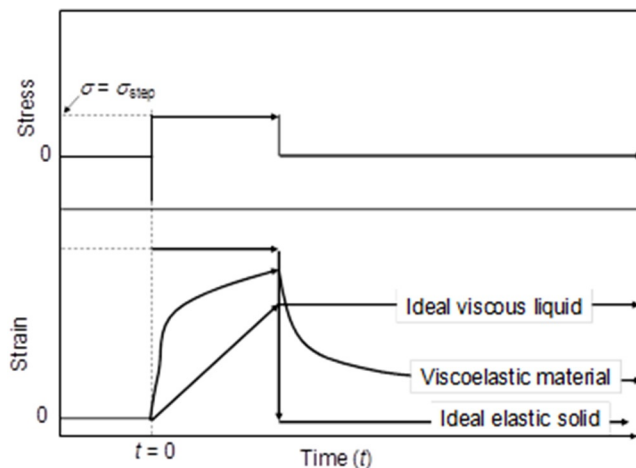


Figure 15.17 Responses of different materials during creep recovery tests.

referred to [Steffe \(1996\)](#) for additional details of applying mathematical models to fit data from creep recovery tests.

## 5. INTERFACIAL RHEOLOGY

Besides measurements on bulk rheological properties discussed above, it is also important to understand properties of oil/water and air/water interfaces, because emulsions and foams are common types of food dispersions. Interfacial properties are important for the stability of these dispersions and thus quality of foods during processing and storage. For example, small molecular weight emulsifiers (e.g. lecithin) and proteins are all surface active agents (surfactants). However, these surfactants have different performances when emulsifying and stabilizing emulsions and foams. Interfaces stabilized by proteins are viscoelastic and more resistant to deformation and coalescence (formation of a larger particle at the cost of two smaller ones). However, interfaces stabilized by proteins at different bulk solvent conditions also possess different characteristics. Interfacial rheology provides a fundamental approach in studying the properties of interfaces. Readers are referred to the literature for interfacial hydrodynamics and derivations leading to interfacial rheological parameters ([Edwards \*et al.\*, 1991](#)).

Briefly, interfacial rheology can be classified into two categories based on the type of deformation at interfaces: dilatational rheology (under a compression/expansion deformation) and shear rheology (with a shear deformation). The timescale for forming a new interface in food colloids during the dispersion process is typical of dilatational rheology, because the deformation of the interfaces during emulsification and

foaming is expansion and compression (Rodríguez Patino and Carrera Sánchez, 2004). However, complex fluid flow properties during food processing may induce coalescence and must be taken into consideration when studying rheology. Conversely, interfacial shear rheology can provide important information about:

1. The interfacial structures that sometimes cannot be obtained from dilatational rheology (Bantchev and Schwartz, 2003).
2. The competitive adsorption and interactions in mixed protein films (Dickinson *et al.*, 1990).

## 5.1 Interfacial Dilatational Rheology

A common method of studying interfacial dilatational rheology is based on the pendant drop principle, also called goniometer (Figure 15.18). A solution is delivered manually or automatically (via computer control) through a capillary tip to form a droplet of a defined volume. This droplet can be immersed in another bulk phase, air or oil, whose temperature can be controlled by an environment chamber. Illumination is provided on one side of this chamber, and the profile of this droplet is captured by a video camera on the other side. By analyzing the shape of this droplet based on the digital images, the interfacial tension between these two bulk phases can be calculated.

A dynamic mode of tests can also be enabled by a motor that introduces an oscillating flow of the solution in the capillary tube, expanding and contracting the droplet at a defined frequency. The principle of this dynamic test is analogous to the aforementioned small amplitude oscillatory shear tests, and the interfacial rheological properties are described using a complex surface dilatational modulus ( $E^*$ ) that has a real component (storage modulus,  $E'$ ) and an imaginary component (loss modulus,  $E''$ ), expressed as in Eq. 15.35. A phase angle can also be defined as Eq. 15.36.

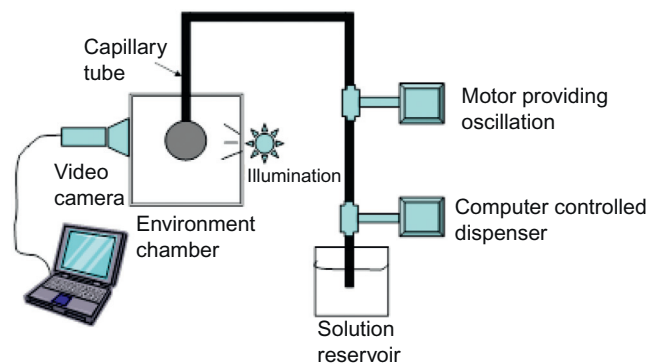


Figure 15.18 Schematic illustration of the setup of a goniometer.



Determination of these moduli is based on the data from the surface area of the droplet and surface tension, detailed by [Myrvold and Hansen \(1998\)](#):

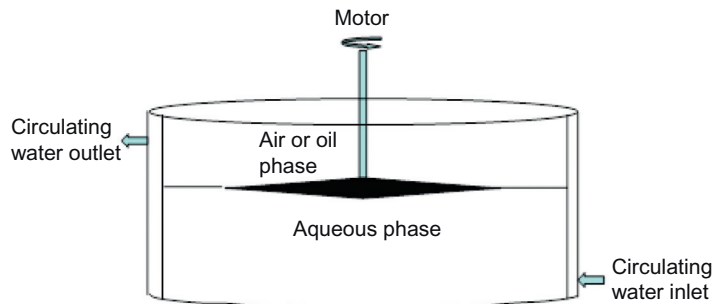
$$E^* = E' + iE'' \quad [15.35]$$

$$\tan\delta = \frac{E''}{E'} \quad [15.36]$$

With these dilatational moduli, it is possible to study the dynamics of interfaces during processing. For example, [Rodríguez Patino \*et al.\* \(1999\)](#), using dilatational modulus and phase angles, illustrated that the gelation of oil/water interfaces in the presence of whey protein isolates occurred at a temperature as low as 40°C, lower than the gelation temperature of whey proteins in bulk solutions (75–90°C) ([Puyol \*et al.\*, 2001](#)). Another example was the application of interfacial rheology to differentiate characteristics of lysozyme (a globular protein) and  $\beta$ -casein (a morphile protein) at a hexadecane/water interface ([Freer \*et al.\*, 2004](#)). Interface with adsorbed lysozyme showed an increase in a solid-like behavior with age after protein unfolding and interaction with remaining proteins in the aqueous solution to form a gel-like interface. In contrast, the interface with  $\beta$ -casein was weaker than that for lysozyme and did not show a substantial change with time.

## 5.2 Interfacial Shear Rheology

Various geometries have been used in interfacial shear rheology ([Edwards \*et al.\*, 1991](#)). Those used to study milk proteins at interfaces included a magnetic rod ([Bantchev and Schwartz, 2003](#)), a Wilhelmy plate ([Rodríguez Patino and Carrera Sánchez, 2004](#)), a Du Noüy ring ([Roberts \*et al.\*, 2005](#)), and a biconical disc operated with a Couette-type ([Dickinson \*et al.\*, 1985](#)) or Searle-type rheometer ([Erni \*et al.\*, 2003](#); [Spiecker and Kilpatrick, 2004](#)). A biconical bob operated with a Searle type rheometer is illustrated in [Figure 15.19](#). The biconical bob is carefully placed at an oil/water



**Figure 15.19** A Searle type rheometer setup using a biconical bob to measure interfacial shear rheology.

or air/water interface, with the bulk phase at a temperature equilibrated by a jacket with circulating water (Spiecker and Kilpatrick, 2004). Interfacial viscosity and interfacial shear moduli can be tested similarly to bulk rheology, and the same terminology can be applied except with addition of “interfacial” before each term. Derivations of interfacial shear rheological parameters from such measurements were provided by Erni *et al.* (2003).

## 6. CONCLUSIONS

Rheology is an important field for studying food products. Rheology is governed by constitutive relations, but non-ideality exists for materials that have not been successfully described with physical models. The non-ideality is more significant for foods because of the complex compositions and processing and storage conditions involved. Rheology provides a powerful approach in quantifying properties of fluidic and semi-solid foods as well as interfaces. Rheological studies supply important information for developing new products and processes and are essential in understanding physical chemistry of foods.

## REFERENCES

- Bantchev, G.B., Schwartz, D.K., 2003. Surface shear rheology of  $\beta$ -casein layers at the air/solution interface: formation of a two-dimensional physical gel. *Langmuir* 19, 2673–2682.
- Barnes, H.A., Hutton, J.F., Walters, K., 1989. *An Introduction to Rheology*. Elsevier, New York.
- Daubert, C.R., Foegeding, E.A., 1998. Rheological principles for food analysis. In: Nielson, S.S. (Ed.), *Food Analysis*, second ed. Aspen Publishers, Inc., Gaithersburg, MD.
- Dickinson, E., Murray, B.S., Stainsby, G., 1985. Time-dependent surface viscosity of adsorbed films of casein + gelatin at the oil-water interface. *J. Colloid Interf. Sci.* 106, 259–262.
- Dickinson, E., Rolfe, S.E., Dalgleish, D.G., 1990. Surface shear viscometry as a probe of protein-protein interactions in mixed milk protein films adsorbed at the oil-water interface. *Int. J. Biol. Macromol.* 12, 189–194.
- Edwards, D.A., Brenner, H., Wasan, D.T., 1991. *Interfacial Transport Processes and Rheology*. Butterworth-Heinemann, Stonham, MA.
- Erni, P., Fischer, P., Windhab, E.J., Kusnezov, V., Stettin, H., Luger, J., 2003. Stress- and strain-controlled measurements of interfacial shear viscosity and viscoelasticity at liquid/liquid and gas/liquid interface. *Rev. Sci. Instrument.* 74, 4916–4924.
- Ferry, J.D., 1980. *Viscoelastic Properties of Polymers*, third ed. John Wiley & Sons, Inc., New York.
- Freer, E.M., Yim, K.S., Fuller, G.G., Radke, C.J., 2004. Interfacial rheology of globular and flexible proteins at hexadecane/water interface: comparison of shear and dilatation deformation. *J. Phys. Chem. B.* 108, 3835–3844.
- Macosko, C.W., 1994. *Rheology Principles, Measurements, and Applications*. Wiley-VCH, New York.
- Myrvold, R., Hansen, F.K., 1998. Surface elasticity and viscosity from oscillating bubbles measured by automatic axisymmetric drop shape analysis. *J. Colloid Interf. Sci.* 207, 97–105.
- Puyol, P., Perez, M.D., Horne, D.S., 2001. Heat-induced gelation of whey protein isolates (WPI): effect of NaCl and protein concentration. *Food Hydrocolloid.* 15, 233–237.
- Roberts, S.A., Kellaway, I.W., Taylor, K.M.G., Warburton, B., Peters, K., 2005. Combined surface pressure-interfacial shear rheology study of the effect of pH on the adsorption of proteins at the air-water interface. *Langmuir* 21, 7342–7348.

- Rodríguez Patino, J.M., Carrera Sánchez, C., 2004. Structural, topographical, and shear characteristics of milk protein and monoglyceride monolayers spread at the air-water interface. *Langmuir* 20, 4530–4539.
- Rodríguez Patino, J.M., Rodríguez Niño, M.R., Carrera Sánchez, C., 1999. Dynamic interfacial rheology as a tool for the characterization of whey protein isolates gelation at the oil-water interface. *J. Agric. Food Chem.* 47, 3640–3648.
- Spiecker, P.M., Kilpatrick, P.K., 2004. Interfacial rheology of petroleum asphaltene at the oil-water interface. *Langmuir* 20, 4022–4032.
- Steffe, J.F., 1996. *Rheological Methods in Food Process Engineering*, second ed. Freeman Press, East Lansing, MI.

# Food Extruders

**Mian N. Riaz**

Texas A&M University College Station, TX, USA

Basic extruder technology has been around for a long period of time. It has been used in one form or another in many industries. New design of extrusion equipment has increased its range of application in the food industry. Today's consumers demand a broader selection of foods. Extrusion cooking has for years provided a means of manufacturing new and novel products. One big advantage of extrusion cooking is the capability to produce a wide range of finished products with minimum processing times using inexpensive raw material.

The verb “extrude” characterizes a process of shaping by forcing softened or plasticized material through dies or holes by pressure. A food extruder is a device that expedites the shaping and restructuring process for food ingredients. Extrusion is a highly versatile unit operation that can be applied to a variety of food processes. Extruders can be used to cook, form, mix, texturize, and shape food products under conditions that would favor quality, high productivity, and low cost (Riaz, 2003).

Extrusion is simply the operation of shaping a plastic or dough-like material by forcing it through a restriction or die. Examples of hand operations for extruding foods include: the rolling of noodles and pie crust doughs, finger-stuffing of chopped meats through animal horns into natural casings, pressing of soft foods through hand ricers to produce string-like particles, and cranking of hand-powered meat grinders. Mechanically powered extrusion devices include wire-cut cookie dough depositors, pasta presses, continuous mixing and scaling systems used in automated bakeries, pneumatic (batch) and continuous (pump) sausage stuffers, hamburger patty formers, and pellet mills used to prepare animal feeds. Rossen and Miller (1973) have offered the practical definition: “Food extrusion is a process in which a food material is forced to flow, under one or more of a variety of conditions of mixing, heating and shear, through a die which is designed to form and/or puff-dry the ingredients.”

The following terms and phrases are the ones most commonly used in food extrusion (Harper, 1981; Riaz, 2000).

- Barrel: This part is in between the preconditioner and knife assembly. It contains shafts (single or twin) and screws with shear locks for cooking and processing the food.

- Breaker plate: This serves as a mechanical seal in between the die and the end of the extruder.
- Compression ratio: This is also called the C/R ratio. It is the volume of the full flight of the screw at the feed opening, divided by the volume of the last full flight before discharge.
- Compression section of the barrel: The main function of the compression section is to plasticize the raw material into a dough-like state. This section is in between the feeding section and the metering section. This section should have a gradual decrease in the screw flight depth in the direction of die.
- Cut flight screw: This is also called interrupted flight screw. In this case, a section of the flight is missing. This is used to increase the shearing action and for more cooking of the raw ingredients.
- Die: These are small openings at the end of the extruder to shape the products.
- Die insert: Individual die openings exist as inserts, which slip into holes in a die plate.
- Pellet: This is a discrete particle which is shaped and cut by the extruder, regardless of shape, sometimes referred to as a “collet”.
- Die land length: This is a ratio between the length and diameter of the die through which the product passes. Longer die land length provides more back-pressure, and the product will be denser.
- Die plate: This plate contains several holes which can receive individual die inserts containing the actual die opening.
- Feeder: This device provides a uniform delivery of the food ingredients to the preconditioner. These feeders are either volumetric or variable-speed augers.
- Feeding section of the barrel: This section usually contains deep flight screws to carry the raw material immediately to the next section. The main function of the feeding section is to ensure that raw material is moving quickly to the barrel. Otherwise, the barrel will plug up and we have to shut down the extruder.
- Flight: This is a helical conveying surface of the screw, which pushes the raw material forward in the extruder barrel.
- Hopper or bin: This part holds the food ingredients above the feeder. They are usually made up of stainless steel with a glass window to see the level of the ingredients.
- Jacket: This comprises hollow cavities outside the barrel in which we can run cooling or heating media such as water, oil, or steam to cool or heat the barrel surface.
- Knife cutter: This is the assembly which cuts the food into desired sizes and lengths.
- Length to diameter ratio: This is also called L/D. It is the distance from the internal rear edge to the discharge end of the barrel, divided by the diameter of the bore.

- **Metering section of the barrel:** This section is nearest the discharge end of the extruder. The main function of the metering section is to increase the shear rate and cooking of the raw material. Therefore, this section should have a very shallow flight screw.
- **Pitch:** This is the angle of the flight, relative to the axis of the root of the screw.
- **Preconditioner:** This part is in between the extruder barrel and the feeder. In the preconditioner we can add moisture and steam to partially cook and mix the raw material before it goes to the extruder barrel. Not all extruders have a preconditioner.
- **Recipe:** The ingredients or mixture (protein, carbohydrates, lipids, minor ingredients, etc.) to be processed in an extruder to make food.
- **Root:** This is a continuous central shaft of the screw, which is usually a cylindrical or conical shape screw, around which the flight is wound.
- **Screw:** This part accepts the food ingredients at the feed port, conveys, works, and then forces through the die. There are several different types of screws, e.g. single flight screw, double flight screw, cut flight screw, shallow flight screw, deep flight screw and feeding screw.
- **Segmented barrel:** This refers to a barrel, which is made of several segments.
- **Shear:** This is a working, mixing action that homogenizes and heats the raw ingredients.
- **Shear ring:** Also called shear-lock or steam-lock or ring dam. This is a round device that locks together individual screws in the barrel.
- **Venting concept:** This is used when we need to make dense food like pasta, third generation snacks, or noodles. Towards the end, one of the barrel sections will have an opening to release the pressure and steam to densify the food products.

## 1. ROLE OF AN EXTRUDER

The conditions generated by the extruder perform many functions that allow it to be used for a wide range of food applications. Depending on the extruder (dry, wet, single, or twin), we can perform one of these or combinations of these functions during processing of food. Some of these functions are (Riaz, 2001):

- **Agglomeration:** Food ingredients can be compacted and agglomerated into discrete pieces in an extruder process.
- **Degassing:** Food ingredients that contain gas pockets can be degassed by extrusion processing.
- **Dehydration:** During normal extrusion processing of food, moisture loss of 4–7% can occur depending on the initial moisture contents.
- **Expansion:** Food density can be controlled by extruder operation conditions and configuration.

- Gelatinization: Extrusion cooking improves starch gelatinization (from all sources, i.e. tuber or cereals) during the processing of foods.
- Grinding: Ingredients can be ground to some extent in the extruder barrel during processing of food.
- Homogenization: An extruder can homogenize by restructuring unattractive ingredients into more acceptable forms during processing of food.
- Mixing: A variety of screws are available for all kind of extruders which can cause the desired amount of mixing action in the extruder barrel during extrusion processing.
- Pasteurization and sterilization: Ingredients can be pasteurized or sterilized using extrusion technology during processing food.
- Protein denaturation: Animal and plant protein can be denatured by extrusion cooking to make it more digestible for the human and animal.
- Shaping: An extruder can make any desired shape of product by changing a die at the end of the extruder barrel.
- Shearing: A special configuration within the extruder barrel can create the desired shearing action for a particular food.
- Texture alteration: The physical and chemical texture can be altered in the extrusion system during processing of food.
- Thermal cooking: The desired cooking effect can be achieved in the extruder during processing of food.
- Unitizing: Different ingredient lines can be combined into one product to give special characteristics by using an extruder for food.

## 2. TYPICAL COMPONENTS OF AN EXTRUDER

An extruder can be divided into four different sections or components (Figure 16.1).

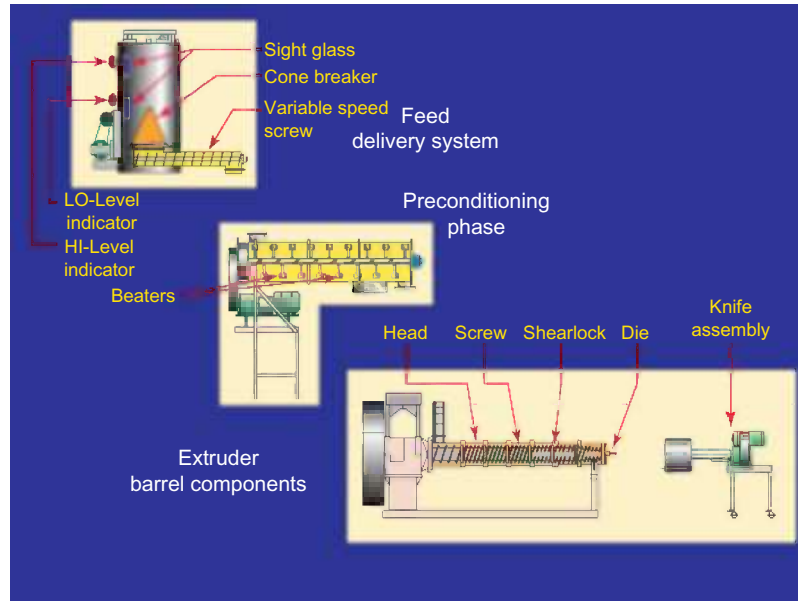
1. Feeding (delivery) system.
2. Preconditioner.
3. Extruder barrel.
4. Knife cutter.

### 2.1 Delivery Systems

The first basic component of the extruder is a delivery system. The purpose of this section is to deliver, uniformly, the food ingredients/recipe or raw material to the next components. Consistent and uniform feeding of ingredients is necessary for the consistent and uniform operation of an extruder.

### 2.2 Preconditioner

Material from the delivery system is fed into the next section of the extruder, which is called the preconditioner. It is not necessarily true that every kind of extruder will



**Figure 16.1** A typical extruder and its components.

have a preconditioner. Most of the dry extruders and direct-expanded snack food extruders do not. However, the majority of the food and feed extruders will have a preconditioner.

### 2.3 Extruder Barrel

The barrel is the heart of the extrusion system. Most of the work is done by this section of the extrusion system. This component consists of screws, sleeves, barrel heads, and dies. This section makes the extruder either a single screw or twin screw extruder. If we have two shafts parallel, then it will be a twin screw extruder, but if we have only one shaft, then it will be a single screw extruder.

### 2.4 Knife Assembly

This is the fourth and last part of the extrusion system. The main function of this component is to cut the product to the desired length and shape. The knife assembly can be a different design depending on the manufacturer of the extrusion system. There is the option to use two, four, or six knives in the assembly.

## 3. TYPES OF EXTRUDERS

There are several different types of extruders available on the market for food and feed production. Some are single screw extruders, twin screw extruders, conical type



twin screw extruders, dry extruders, interrupted flight extruders, extruders—expanders, and new generation extruders. Extruders may be designed to include various grinding, mixing, homogenizing, cooking, cooling, vacuumizing, shaping, cutting, and filling operations. Not all extruders are of the cooking-texturizing type. Single screw extruders come in a number of sizes and shapes, and their screw, barrel, and die configurations can usually be varied to suit the specifications of a particular product.

### 3.1 Single, Segmented Screw Extruders

A cross section of a single screw extruder with a segmented worm screw and barrel is shown in [Figure 16.2](#). Note that the root of the screw is constant in diameter, and that compression results by changing the pitch of the worm flights. In this case, the full-pitch screw segment forces the product onto a worm with twin-spiral, one-half pitch flights to achieve compression. The degree of shear can be modified in two ways: 1. by using shear locks of increasing diameters, requiring increasing pressures to force the product into the adjacent worm section; and 2. by selecting between a grooved- and a spiral-walled barrel. More mixing and shearing occurs with the grooved barrel because of greater slippage between the screw flight and barrel walls. Solid screw extruders are still built for special low-pressure cooking and forming applications. But, segmented screw worms and barrel sections offer considerable versatility in customizing screw barrel design and replacing worn parts, and are used in the majority of both single screw and twin screw extruders.

Most of the single screw extruder's processing conditions can be controlled to achieve a variety of effects. For example, cooking temperature within the extruder barrel can range from 80°C to 200°C, by configuring with high shear screws and shear locks, injecting direct steam, heating the barrel by circulating steam or heating oil, increasing the speed of the shaft or restricting the die open area. Similarly, residence time in the barrel can be varied from 15 to 300 s by increasing or decreasing the speed of the shaft. In general, single screw extruders have poor mixing ability. Therefore, material should be premixed, or a preconditioner should be used for proper mixing of the ingredients. A typical single screw extruder consists of three different zones: 1. feeding zone, 2. kneading zone, and 3. cooking zone ([Hauck, 1985](#)).



**Figure 16.2** A cross-section of a single screw extruder with a segmented worm screw and barrel.

### 3.2 Dry Extruders

All extruders are basically screw pumps through which material is forced, while in the meantime subjected to heat, cooking, and shear forces. The term dry extrusion, as opposed to wet extrusion, refers to the fact that this type of extruder does not require an external source of heat or steam (Said, 2000).

Dry extruders capitalize their source of heat by internal friction for cooking, and therefore no external steam or heat is injected into an extruder barrel during cooking. This type of extruder was developed for processing whole soybeans on the farm. The dry extruder can process ingredients which have a wide range of moisture contents, depending on the formulation. If the material has lower initial moisture contents, then drying of the material after extrusion cooking is not necessary. Usually, in dry extrusion we lose moisture in the form of steam at the exit and this moisture loss depends on the initial start-up moisture in the material. Dry extruders have the option of water injection during extrusion. Usually, starchy material requires some moisture in order to gelatinize.

Recently there has been a lot of development in dry extruder design and its components. Recent research has shown that if the starting material can be preconditioned with steam and water, the efficiency of the extruder is almost doubled (Figure 16.3). Research has also found that in some applications, a longer barrel will work much better than the normal barrel used for soybeans.

Dry extruders are single screw extruders with a segmented screw put together around the shaft. In between the screw a restriction (steam lock, choke plate) of different diameters can be placed to increase the cook and shear (Figure 16.4). When material moves in the barrel and comes across these restrictions, it is unable to pass through and consequently pressure builds up and a backflow is created. Usually these restrictions are arranged in such a way that they increase in diameter toward the die end of the screw, creating more pressure and shear as they reach the die. This build-up of pressure and temperature, together with shear stresses developed, tends to plasticize the raw materials into a viscous paste or puffed shape, depending on the raw material.

In dry extrusion, pressure and temperature should be at a maximum just before leaving the die. The die design and opening also play a very important role in pressure build-up. Different dies are used for different material and shapes. The cooking range in a dry extruder can be 180–320°F with very high pressure. As soon as the material leaves the extruder dies, pressure is instantaneously released from the products, which causes internal moisture to vaporize into steam, making the product expand.

### 3.3 Interrupted Flight Extruders

Figure 16.5 shows the interrupted flight expander's internal arrangement. The interrupted flight worm shaft rotates within a smooth-walled barrel. Removable pins



Figure 16.3 *Dry extruder with preconditioner.*

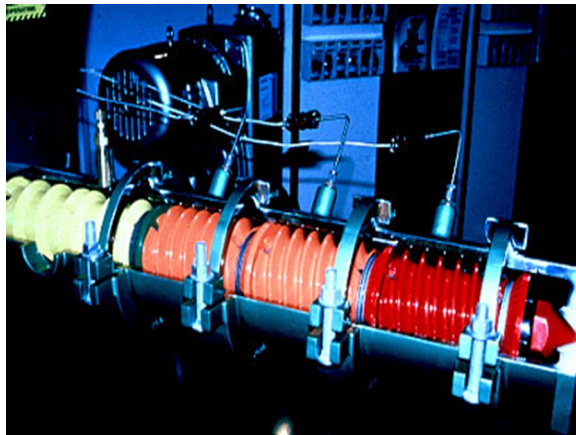


Figure 16.4 *Dry extruder with different screw and steam lock.*

protrude from the barrel's wall and intermesh with the flights. Worms revolving rapidly between the stationary pins blend injected water and steam into the feed material. Frictional heat, plus heat of vaporization released by the steam, raise the temperature.

The worm shaft compacts the mixture, subjecting it to higher pressure and friction, thereby pressure-cooking the mixture. Seconds later, the material contains liquid

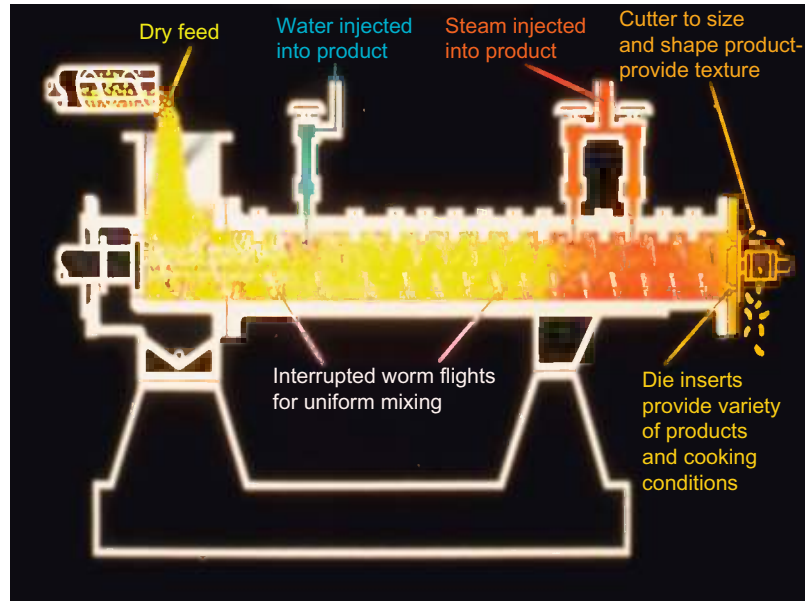


Figure 16.5 *Interrupted flight expander's internal arrangement.*

water, and even the steam is liquefied. Twenty seconds later, the cook completed, the material flows through shaping orifices and is cut to the desired length on exiting the expander. Varying temperature and moisture inside the barrel influence cook. Moisture can vary from 0% to 15% and temperature from 120°F to 320°F (49°C to 160°C). Direct-injected water and steam influence moisture. The amount of final moisture injected as steam and the friction generated per pound of material influence temperature. The number and size of dies through which the material is forced to flow influence horsepower consumption. Moisture level also influences horsepower consumption.

Cooking gelatinizes starch into an elastic adhesive that glues the solid particles into an inflatable mass. When this inflatable mass leaves the expander's high-pressure interior and passes into an atmospheric pressure environment, some moisture vaporizes. This inflates and stretches the mass with many small internal holes, giving the mass a porous interior composition. Conditions within the expander easily control the degree of puffing. Puffing requires that the material contains some ingredients, usually starch that can become sticky and inflatable.

An interrupted flight, single screw expander offers significant advantages because of its uncomplicated design, low cost, and its tolerance for wear. The shaft “free-floats” in the material within the barrel. There are no bearings at the discharge end of the barrel. Shaft and thrust bearings are mounted inside an oil-bath thrust case located

between the motor and the expander's feed end. The last six shaft worms are hardened and ride within two replaceable, case-hardened wear sleeves.

The shaft has a uniform, deep channel and no internal pressure plates or steam locks. The only restriction to flow is the removable die plate, which, when opened, allows the expander to empty. Clean-out is easily done by sending dry feed at high capacity for about 30 s to push out any cooked material left clinging to the shaft on expander shutdown.

The cutter assembly is attached to the die plate with a stationary central shaft attached to the center of the die plate. The cutter's housing, with cutter blades attached, revolves to cut the product as it exits the dies. Each blade sweeps across the surface of each die, slicing the product into uniform lengths. Length is determined by cutter speed and number of blades. Particle cross section is determined by the die opening. Expansion and bulk density are influenced by how the expander is operated.

### 3.4 New Generation Extruders

New generation single screw extruders were introduced in 1998. The new generation of single screw cooking extruders designed for production of pet foods features several key design changes. In general, the extruders have shorter length to diameter (L/D) ratios, which means there are fewer stationary and rotating wear parts. The drive assemblies have been modified to allow the extruder screw to run at 30% to 100% higher speeds.

In addition, preconditioning, which has long been a proven asset to pet food production, is enhanced. Finally, variable frequency drives have been added as an option to increase flexibility. The fixed and rotating components of the extruder barrel are the most expensive portion of the extrusion system. By shortening the length to diameter ratio of the new generation extruders, capital costs can be reduced. In the past, shortening the L/D ratio has led to a reduction in extruder capacity. However, in the case of new-generation extruders, the volumetric capacity of the extruder screw is increased by increasing its rotational speed (Strahm, 1999).

New generation extruders offer several advantages compared to regular extruders. Some of these are (Rokey, 1998; Strahm, 1999):

- 30–50% increase in capacity.
- 5–20% reduction in bulk density.
- > 25% reduction in energy consumed.
- Reduced sensitivity to worn components.
- Improved processing of high-carbohydrate diets.
- Reduced processing and capital cost.

### 3.5 Twin Screw Extruders

Twin screw extruders include a variety of machines with widely different processing and mechanical characteristics and capabilities. These extruders can be categorized

according to the position of the screws in relation to one another and to the direction of screw rotation. In twin screw extruders, the screw either rotates in opposing directions (counter-rotating) or in the same direction (co-rotating). Regarding screw position, extruders can have: 1. intermeshing screw in which the flight of one screw engage or penetrates the channels of the other screw, or 2. non-intermeshing screw in which the screws do not engage each other's threads, allowing one screw to turn without interfering with the other. Non-intermeshing screw extruders function like single screw extruders but have a higher capacity (Dziezak, 1989).

Extruder screws can be either co-rotating, i.e. turn in the same direction with their screw crests matching up with opposing troughs, or counter-rotating, i.e. turn in opposite directions. Therefore four types of twin-screw extruders are possible (Miller, 1990):

- Non-intermeshed, co-rotating.
- Non-intermeshed, counter-rotating.
- Intermeshed, co-rotating.
- Intermeshed, counter-rotating.

All of these variations have been built. It has been noted that non-intermeshed twin screw extruders may act as two separate screws laying side by side, with uneven filling and discharge from each screw. Self-wiping versions of the co-rotating intermeshed twin screw extruder are very popular domestically. However, interest is growing in processing of materials that require high pumping pressures in intermeshed counter-rotating twin screw extruders.

Twin screw extruders typically cost 50–150% more than single screw extruders of the same throughput, but offer several advantages, including:

- Handle viscous, oily, sticky, or very wet material and some other products which will slip in a single screw extruder (it is possible to add up to 25% fat in a twin screw extruder).
- Positive pumping action and reduced pulsation at the die.
- Less wear in smaller part of the machine than in single screw extruder.
- Wide range of particle size (from fine powder to grains) may be used, whereas single screw is limited to a specific range of particle size.
- Because of the self-wiping characteristics, clean-up is very easy.
- Ease of process scale-up from pilot plant to large-scale production.

A cross-section of a co-rotating, self-wiping twin screw extruder screw is shown in Figure 16.6. Please note that the basic elements of feed, kneading, and cooking zones are still there, as are the shear locks.

- Should it be a “wet” or “dry” extruder?
- Is a single or twin screw extruder required?
- Should it be an expander with pellet mill?
- Should it have continuous or interrupted flights?
- Should it have internal steam locks or a single-face die plate?



**Figure 16.6** A cross-section of a co-rotating, self-wiping twin-screw extruder screw.

The right selection of an extruder for the food and feed industry will depend on several factors, as well as on the food and feed products. Therefore, one should ask these questions before selecting an extruder for the food and feed industry (Riaz, 2000):

- What will be the main ingredients to be used in the pet and feed recipe?
- What is the physical nature of the main ingredients?
- What will be the physical and sensory properties of the food and feed?
- What are the moisture contents of the other main ingredients?
- What is the fat content of the ingredient that will be used in food and feed formulation?
- What will be the availability of the constant or seasonal ingredients and substitute ingredients that may be used occasionally?
- What kind of food and feed will be made? Generic or complicated with high density nutrients?
- Does the food and feed formulation contain high levels of fresh meat?
- Is the shape of the food and feed simple, exotic, or detailed?
- Should the food or feed be multi-colored or center-filled with some other ingredients?
- What is the target bulk density of the food and feed to be made on the extruder?
- What is the desired production rate of the food and feed?
- The size of an extruder depends on market size as extruders function best operating at full throughput per hour.
- What will be the source of energy for the food and feed extruder? Is steam or electricity (for product heating) more economical where the extrusion plant will be built?

- For a small operation in a developing country, would a tractor power take-off drive be more suitable?
- What about capital availability and the recovery date target?
- Would a used extruder fill the need better for a start-up operation?

Choosing the proper extruder and extruder configuration is critical for a successful food and feed facility. The extruder manufacturer should be able and willing to assist in tailoring special screw, barrel, and supporting equipment configurations for processing specific food and feed products. All of the previously mentioned factors should be considered when deciding what type of extruder best fulfills the needs of the food and feed industry (Riaz, 2003).

Most commonly used food and feed extruders currently available on the market are single screw “wet” extruders (with or without the preconditioner), single screw “dry” extruders (with or without the preconditioner), single screw interrupted flight extruders (also available with preconditioner), and twin screw extruders with preconditioner. Once the proper extruder is selected for the food, and feed industry, the next challenge will be to make sure it is assembled correctly for the right type of food and feed production, and then adequately maintained on a regular basis.

#### 4. SOURCES FOR MORE INFORMATION FOR EXTRUSION TECHNOLOGY

Various information sources on extrusion technology are available, including internet websites maintained by the various extruder manufacturers. Magazines which contain articles on extrusion include:

*Cereal Food Worlds*, American Association of Cereal Chemists, St. Paul, Minnesota.  
*Food Technology*, Institute of Food Technologists, Chicago, Illinois  
*Feed International*, Watts Publications, Mount Morris, Illinois  
*Feed Management*, Watts Publications, Mount Morris, Illinois  
*Pet food Industry*, Watts Publications, Mount Morris, Illinois  
*Feed Tech*, Elsevier International, The Netherlands  
*Food Processing*, Putnam Publications, Itasca, Illinois  
*Prepared Foods*, Cahners Food Group Publications, Oak Brook, Illinois  
*International Aqua Feed*, Turret RAI, United Kingdom

#### REFERENCES

- Dziezak, J.D., 1989. Single and twin-screw extruders in food processing. *Food Technol.* 43 (4), 163–174.
- Harper, J.M., 1981. *Extrusion of Foods*, Vol. 1. CRC Press, Boca Raton, FL, USA.
- Hauck, B.W., 1985. Comparison of single and twin screw cooking extruders. *Impluse Food Suppl.* Feb. p. 6.



- Miller, R.C., 1990. Unit operations and equipment. IV. Extrusion and extruders. In: Fast, R.B., Caldwell, E.F. (Eds.), *Breakfast Cereals and How They are made*. American Association of Cereal Chemists, St. Paul, MN, pp. 135–193.
- Riaz, 2001. Selecting the right extruder. In: Guy, R. (Ed.), *Extrusion Cooking*. Woodhead Publishing limited, Cambridge, England, pp. 29–49.
- Riaz, M.N., 2000. Introduction to extruders and their principles. *Extruders in Food Application*. CRC Press, Boca Raton, FL, USA, pp. 1–23.
- Riaz, M.N., 2003. Extrusion basics. In: Kvamme, J.L., Phillips, T.D. (Eds.), *Petfood Technology*. Watt Publishing Co., Mt. Morris, IL, USA, pp. 347–360.
- Rokey, G., 1998. New processing technologies. Paper Presented at “Petfood Forum 98”. Chicago, IL. Mar. 30–Apr.1.
- Rossen, J.L., Miller, R.C., 1973. Food extrusion. *Food Technol.* 27, 46–53.
- Said, W.N., 2000. Dry extruders. In: Riaz, M.N. (Ed.), *Extruders in Food Applications*. Technomic Publishing Co. Inc., Lancaster, Pennsylvania, pp. 51–62.
- Strahm, B., 1999. New generation extruders. Proceedings of “Focus on Extrusion” By Pet Food Industry. Watt Publishing Co., Mt. Morris, IL, pp. 24–28.

## FURTHER READING

- Chang, Y.K., Wang, S.S., 1999. *Advances in Extrusion Technology*. Aquaculture/Animal Feeds and Foods. Technomic Publishing Co., Lancaster, Pennsylvania.
- Fast, R.B., Caldwell, E.F., 2000. *Breakfast Cereals and How They are Made*, second ed. American Association of Cereal Chemist, St. Paul, Minnesota.
- Woodroffe, J.M., 1993. *Dry Extrusion Manual*. Rural Pacific Pty, Ltd., Australia.
- Riaz, M.N., 2000. *Extruders in Food Applications*. CRC Press, Inc., Boca Raton, Florida.
- Jowitt, R., 1984. *Extrusion Cooking Technology*. Elsevier Applied Science, New York.
- Mercier, C., Linko, P., Harper, J.M., 1989. *Extrusion Cooking*. American Association of Cereal Chemist, St. Paul, Minnesota.
- Harper, J.M., 1981. *Extrusion of Foods*, Vol. 1 & 2. CRC Press, Inc., Boca Raton, Florida.
- O'Connor, C., 1987. *Extrusion Technology for the Food Industry*. Elsevier Applied Science, New York.
- Riaz, M., 2006. *Feeds and Pet Food Extrusion Manual*. Food Protein R&D Center, Texas A&M University, College Station, Texas, USA.
- Focus on Extrusion (Proceedings). 1999. Pet food industry. Watt Publishing Co., Mt. Morris, IL.
- Kokini, J.L., Ho, C., Karwe, M.V., 1992. *Food Extrusion Science and Technology*. Marcel Dekker, Inc., New York, New York.
- Hayakawa, I., 1992. *Food Processing by Ultra High Pressure Twin-screw Extrusion*. Technomic Publishing Co., Lancaster, Pennsylvania.
- Wilson, D. and Tribelhorn, R.E., 1979. *Low-Cost Extrusion Cookers*. Workshop Proceedings. United States Department of Agriculture. Office of International Cooperation and Development, Washington D. C.
- Mercier, C., Cantarelli, C., 1986. *Pasta and Extrusion Cooked Foods*. Elsevier Applied Science, New York.
- Kvamme, J.L., Phillips, T.D., 2003. *Pet Food Technology*. Watt Publishing, Mt. Morris, Illinois, USA.
- Riaz, M.N., 2007. *Extruders and Expanders in Pet Food, Aquatic and Livestock Feeds*. Agrimedia GmbH, Germany.
- Riaz, M.N., Rokey, G., 2011. *Extrusion Problems Solved—Food, Pet Food and Feed*. Woodhead Publishing Limited, Cambridge, UK.
- Frame, N.D., 1994. *The Technology of Extrusion Cooking*. Blackie Academic & Professional, New York.
- Zeuthen, P., Cheftel, J.C., Eriksson, C., Jul, M., Leniger, H., Linko, P., et al., 1984. *Thermal Processing and Quality of Foods*. Elsevier Applied Science, New York.
- Janssen, L.P.B.M., 1978. *Twin-screw Extrusion*. Elsevier Applied Science, New York.

# Thermal Processing for Food Sterilization and Preservation

Arthur A. Teixeira

University of Florida, FL, USA

## 1. INTRODUCTION

Thermal processing of shelf-stable foods, normally thought of as canned foods, has been one of the most widely used methods of food preservation during the twentieth century, and has contributed significantly to the nutritional well-being of much of the world's population. Thermal processing consists of heating food containers in pressurized retorts (steam autoclaves or "pressure cookers") at specified temperatures for prescribed lengths of time. These process times are calculated on the basis of achieving sufficient bacterial inactivation in each container to assure food safety to the consuming public, and to ensure that the probability of spoilage will be less than some minimum. Associated with each thermal process is always some degradation of heat-sensitive vitamins and other quality factors that is undesirable. Because of these quality and safety factors, great care is taken in the calculation of these process times and in the control of time and temperature during processing to avoid either under- or over-processing. This chapter will describe the food process machinery systems used in the food industry to accomplish sterilization both in-container (retort systems) and out-of-container (aseptic systems), along with a summary of the FDA/USDA Low-acid Canned Food (LACF) regulations that apply to the operation of these equipment and machinery systems.

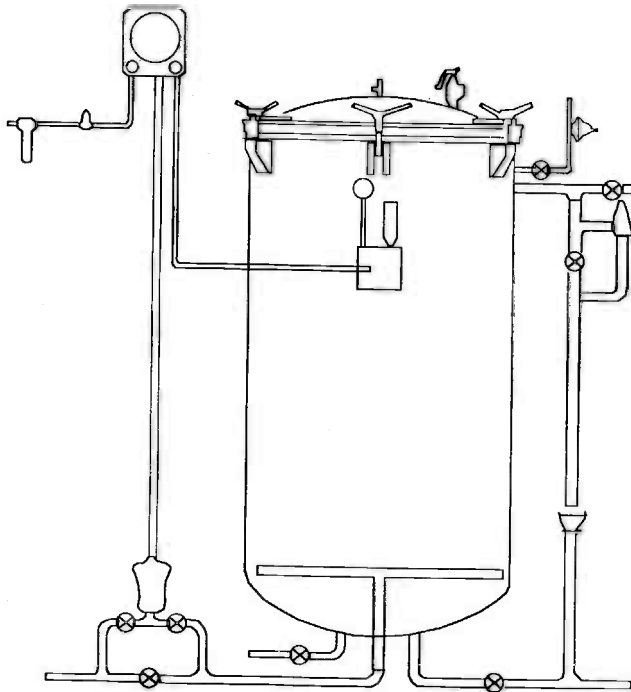
## 2. RETORT SYSTEMS

This section describes briefly some of the commercial retort equipment systems used in the food canning industry to accomplish thermal processes efficiently on a production scale. Just as with most industrial processing operations, both batch and continuous systems are available. As the name implies, batch systems are made up of individual batch retorts that operate intermittently. Scheduling of the retorts is skillfully staggered so that workers move from retort to retort, manually unloading and reloading each retort as its scheduled process cycle comes to an end. In continuous

systems, cans are automatically fed into and out of retort systems that operate continuously over one or more working shifts.

## 2.1 Batch Retorts

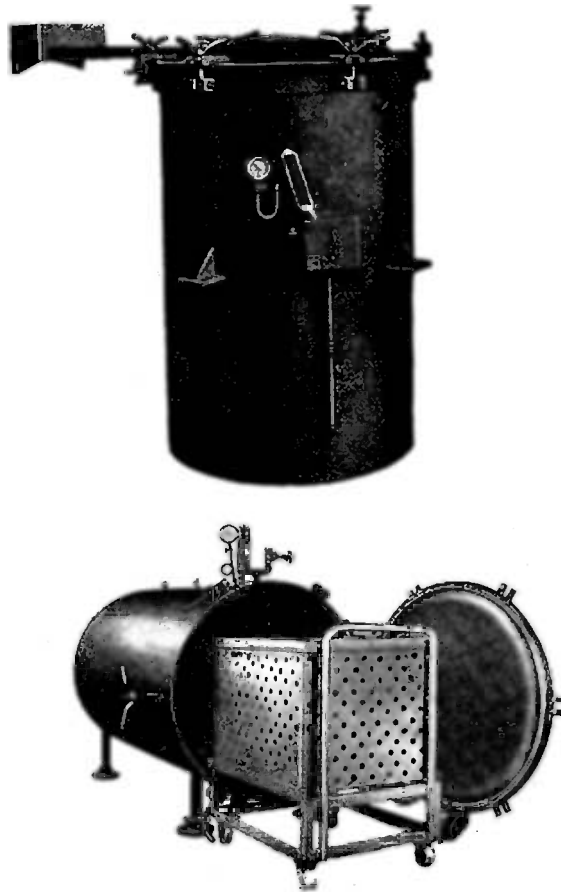
The vertical still cook batch retort shown schematically in [Figure 17.1](#), together with its horizontal counterpart in [Figure 17.2](#) are perhaps the grandfathers of all batch retorts. Hardly any food science pilot plant or laboratory is complete without one. The units shown in [Figure 17.2](#) are of historical vintage, but many still operate today in various parts of the world. A typical production vertical unit will measure 42 in. in diameter by 8 or 9 ft in height. Cans are loaded in crates that are handled by chain hoist for lifting and lowering into vertical retorts, or into wheeled carts that roll on rails into horizontal retorts. Most retorts are designed to hold either three or four crates or carts, with a total capacity of more than 1,000 No. 2 cans per batch, or 400 No. 10 cans. Although the basic design of these retorts has changed little since the turn of the century, they are still quite popular and can be found operating in many food canneries today. Part of the reason for this continued popularity is the simplicity



**Figure 17.1** Schematic diagram of vertical still-cook retort showing basic controls and piping. From [Lopez \(1987\)](#), *A Complete Course in Canning*, 12th Edition. (Courtesy CTI Publications, Inc.)

of their design and operation and their versatility to accommodate virtually all can sizes and shapes.

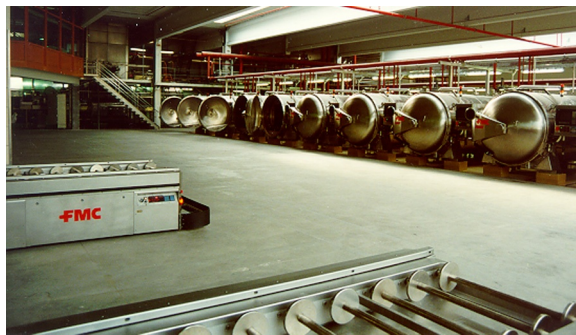
Although the unloading and reloading operations are labor intensive, a well-managed cook room can operate with surprising efficiency. The cook room is the room or area within a food canning plant in which the retorts are located. Some cook rooms are known to have more than 100 vertical still cook retorts operating at full production. Although each retort is a batch cook operation, the cook room as a whole operates as a continuous production “system” in that filled and sealed unsterilized cans enter the cook room continuously from the filling line operations, and fully processed sterilized cans leave the cook room continuously. Within the cook room itself, teams of factory workers move from retort to retort to carry out loading and unloading operations, while retort operators are responsible for a given number or



**Figure 17.2** *Historical vertical (top) and horizontal (bottom) still-cook retorts (vintage 1900–1940).*



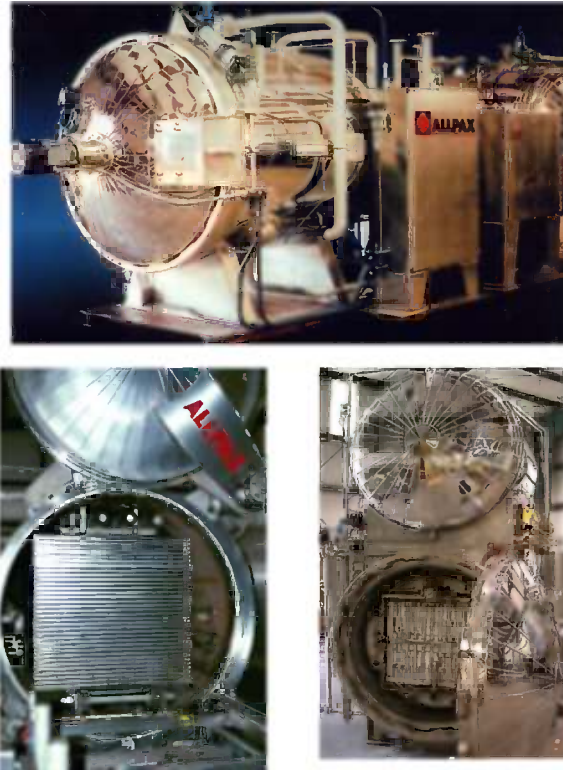
**Figure 17.3** *Modern-day horizontal batch retort.* (Photo courtesy of JBT FoodTech, formerly FMC FoodTech, Madera, CA)



**Figure 17.4** *Batch retort system in large cook room operation.* (Photo courtesy of JBT Food Tech, formerly FMC FoodTech, Madera, CA)

“bank” of retorts. These operators carefully monitor the operation of each retort to make sure that the scheduled process is delivered for each batch.

In general, all operations are the same for horizontal retorts as vertical retorts, except that crates are usually moved into and out of horizontal retorts on trolley tracks instead of chain hoists. For convection-heating products that benefit from mechanical agitation during processing, agitating batch retorts are available. A modern-day horizontal batch retort is shown in [Figure 17.3](#), with a battery of several such retorts making up a large cook room operation shown in [Figure 17.4](#). Batch retorts designed for flexible or semi-rigid retortable packaging systems require overriding air pressure to protect packages from bursting during processing. These operate with water spray, water cascade, or steam–air mixtures with overriding air pressure, and are capable of delivering end-over-end agitation when desired ([Figure 17.5](#)).



**Figure 17.5** *Rotating batch retorts with end-over-end rotation and overriding air pressure for flexible and semi-rigid retortable packages. (Courtesy ALPAX Corporation, Covington, LA)*

## 2.2 Continuous Retort Systems

Continuous retort operations require some means by which filled, sealed containers are automatically and continuously moved from atmospheric conditions into a pressurized steam environment, held or conveyed through that environment for the specified process time, and then returned to atmospheric conditions for further down-stream handling operations. The best-known commercially available systems that accomplish these requirements are the crateless retort, the continuous rotary cooker, and the hydrostatic sterilizer. Two other systems, which operate on different principles but accomplish this same purpose for special products, are the Flash “18” system and the Steriflamme system.

### 2.2.1 *Crateless Retorts*

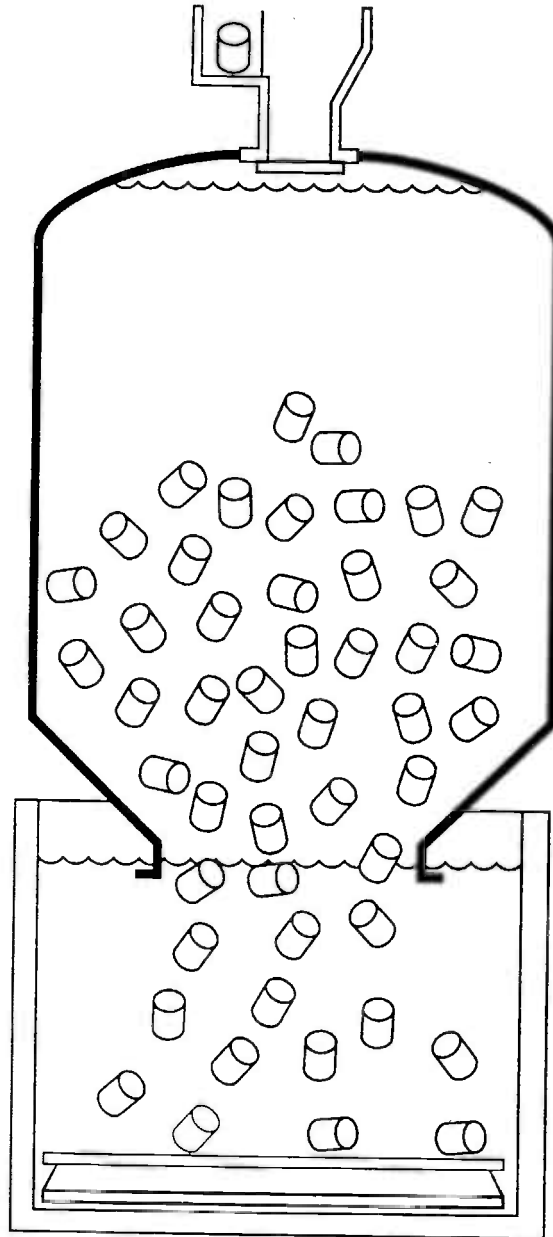
A crateless retort system is, in a sense, an automatic cook room in that the system is made up of a series of individual retorts, each operating in a batch mode, with loading, unloading, and process scheduling operations all carried out automatically

without the use of crates. An individual crateless retort is illustrated schematically in [Figure 17.6](#), and as it appears on the factory floor in [Figure 17.7](#). When ready to load, the top hatch opens automatically, and cans fed from an incoming conveyor literally “fall” into the retort, which is filled with hot water to cushion the fall. Once fully charged, the hatch is closed and steam entering from the top displaces the cushion water out the bottom. When the cushion water has been fully displaced, all valves are closed and processing begins. At the end of the process time, the retort is refilled with warm water and the bottom hatch, which lies beneath the water level in the discharge cooling canal, is opened to let the cans fall gently onto the moving discharge conveyor in the cooling canal. After all cans are discharged, the bottom hatch is reclosed and the retort is ready to begin a new cycle. This sequence of operations is shown schematically in [Figure 17.8](#). A commercial system of crateless retorts would consist of several such retorts in a row sharing a common infeed and discharge conveyor system to achieve continuous operation of any design capacity.

### **2.2.2 Continuous Rotary Cookers**

The continuous rotary pressure sterilizer or “cooker” is a horizontal rotating retort through which the cans are conveyed while they rotate about their own axis through a spiral path and rotating reel mechanism as illustrated in the cutaway view in [Figure 17.9](#) and the schematic diagram in [Figure 17.10](#). Residence time through the sterilizer is controlled by the rotating speed of the reel, which can be adjusted to achieve the required process time. This, in turn, sets the line speed for the entire system. Cans are transferred from an incoming can conveyor through a synchronized feeding device to a rotary transfer valve, which indexes the cans into the sterilizer while preventing the escape of steam and loss of pressure. Once cans have entered the sterilizer, they travel in the annular space between the reel and the shell. They are held between splines on the reel and a helical or spiral track welded to the shell. In this way the cans are carried by the reel around the inner circumference of the shell, imparting a rotation about their own axes, while the spiral track in the shell directs the cans forward along the length of the sterilizer by one can length for each revolution of the reel. At the end of the sterilizer, cans are ejected from the reel into another rotary valve and into the next shell for either additional cooking or cooling.

Most common systems require at least three shells in series to accomplish controlled cooling through both a pressure cool shell and an atmospheric cool shell following the cooker or sterilizer. For cold-fill products that require controlled preheating, as many as five shells may be required in order to deliver an atmospheric preheat, pressure preheat, pressure cook, pressure cool, and atmospheric cool. By the nature of its design and principle of operation, a continuous rotary sterilizer system is manufactured to accommodate a specific can size and cannot easily be adapted to



**Figure 17.6** Schematic diagram of crateless retort illustrating basic principle of charge and discharge through cushion of water.



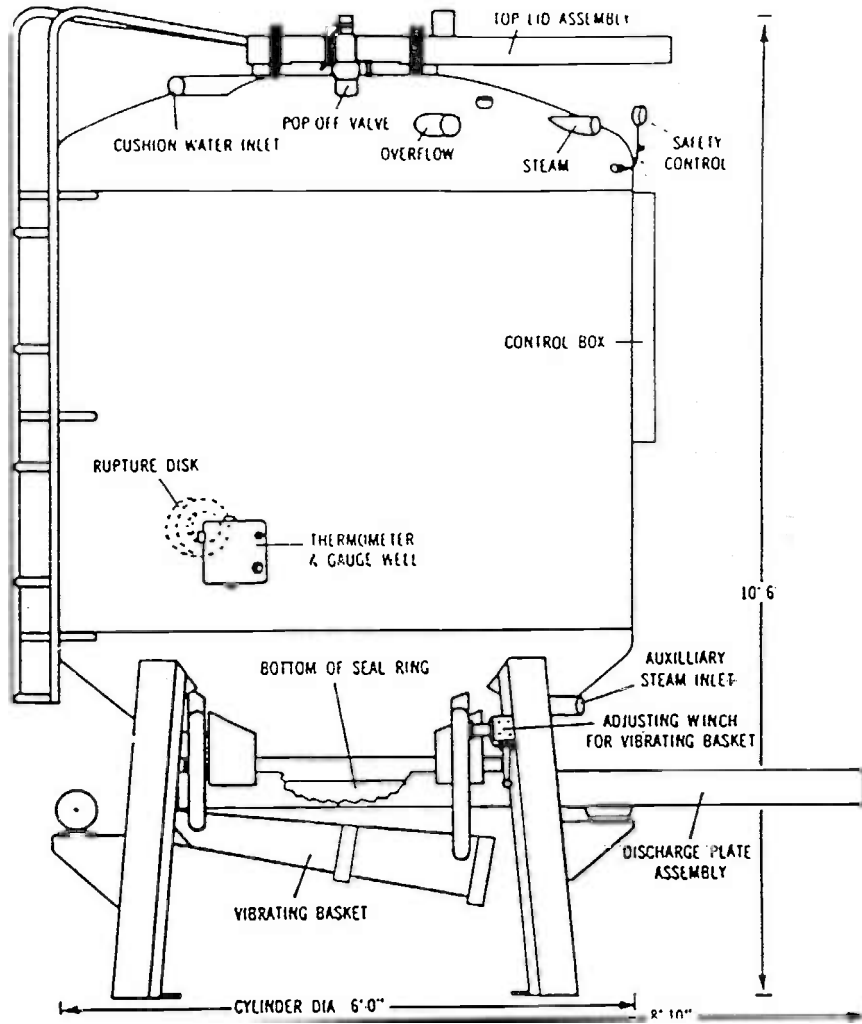
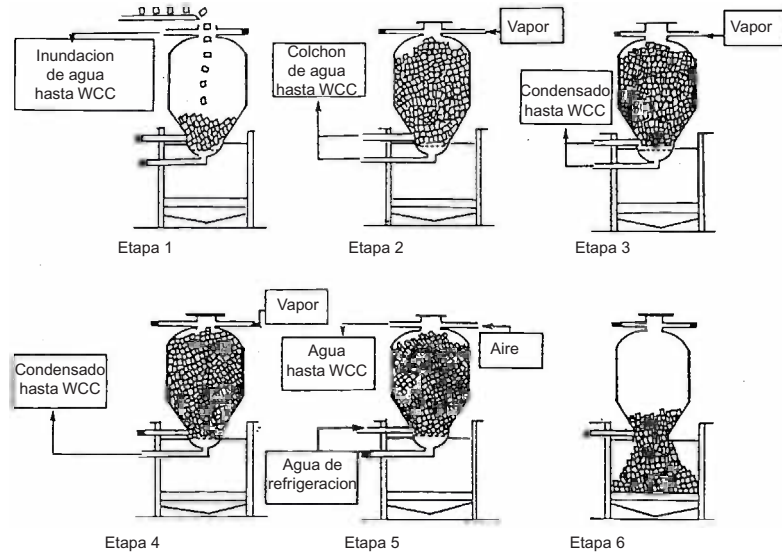


Figure 17.7 Exterior schematic of crateless retort showing details of mechanical operations.

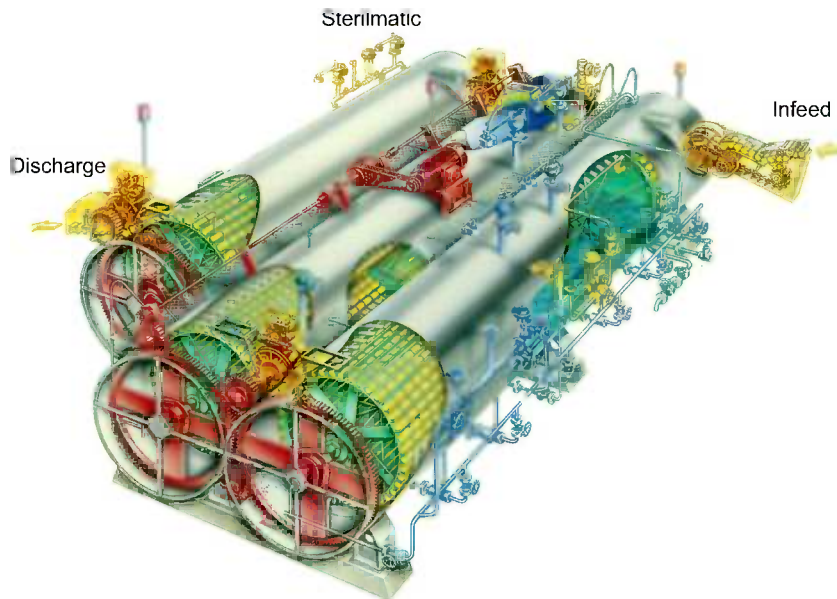
other sizes. For this reason it is not uncommon to see several systems (filling lines) in operation in one food canning plant, each system dedicated to a different can size.

### 2.2.3 Hydrostatic Sterilizers

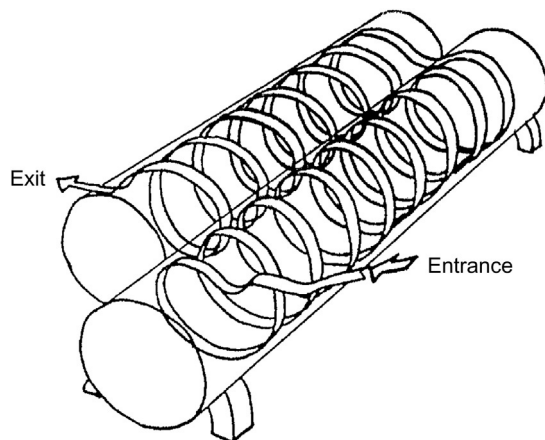
These systems are so named because steam pressure is controlled hydrostatically by the height of a leg of water. Because of the height of water leg required, these sterilizers are usually installed outdoors adjacent to a canning plant. They are self-contained structures with the external appearance of a rectangular tower, as shown in



**Figure 17.8** Schematic of sequence of operations in crateless retort system (in Spanish) (Rees and Bettison, 1991).



**Figure 17.9** Cutaway view of three-shell continuous rotary cooker. (Photo courtesy of JBT FoodTech, formerly FMC FoodTech, Madera, CA)



**Figure 17.10** Schematic describing helical path of can movement through a continuous rotary cooker shell. (Photo courtesy of JBT FoodTech, formerly FMC FoodTech, Madera, CA)

**Figure 17.11.** They are basically made up of four chambers: a hydrostatic “bring-up” leg, a sterilizing steam dome, a hydrostatic “bring-down” leg, and a cooling section.

The principal of operation for a hydrostatic sterilizer can be explained with reference to the schematic flow diagrams in [Figures 17.12 and 17.13](#). Containers are conveyed through the sterilizer on carriers connected to a continuous chain link mechanism that provides positive line speed control and thus residence-time control to achieve specified process time in the steam dome. Carriers are loaded automatically from incoming can conveyors and travel to the top of the sterilizer, where they enter the bring-up water leg. They travel downward through this leg as they encounter progressively warmer water. As they enter the bottom of the steam dome, the water temperature will be in equilibrium with steam temperature at the water seal interface. In the steam dome, the cans are exposed to the specified process or “retort” temperature controlled by the hydrostatic pressure for the prescribed process time controlled by the carrier line speed. When cans exit the steam dome, they again pass through the water seal interface at the bottom and travel upward through the bring-down leg as they encounter progressively warmer water until they exit at the top. Cans are then sprayed with cooling water as the carriers travel down the outside of the sterilizer on their return to the discharge conveyor station. Pressure and temperature profiles that are experienced by the water and steam in the various chambers, as well as by the cans themselves in a typical hydrostatic sterilizer system are shown in [Figure 17.14](#).

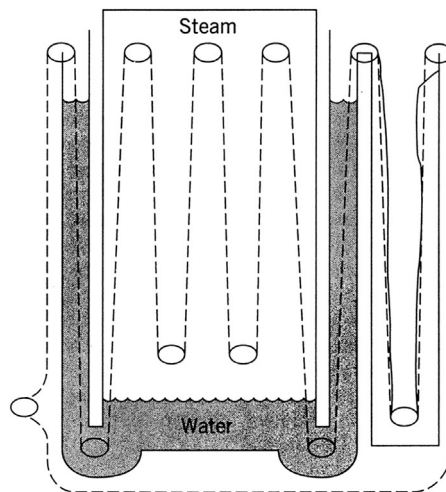
#### **2.2.4 Flash “18”**

The Flash “18” process is unique in that the product is brought to sterilizing temperature prior to filling through steam injection heating, and then pumped while at

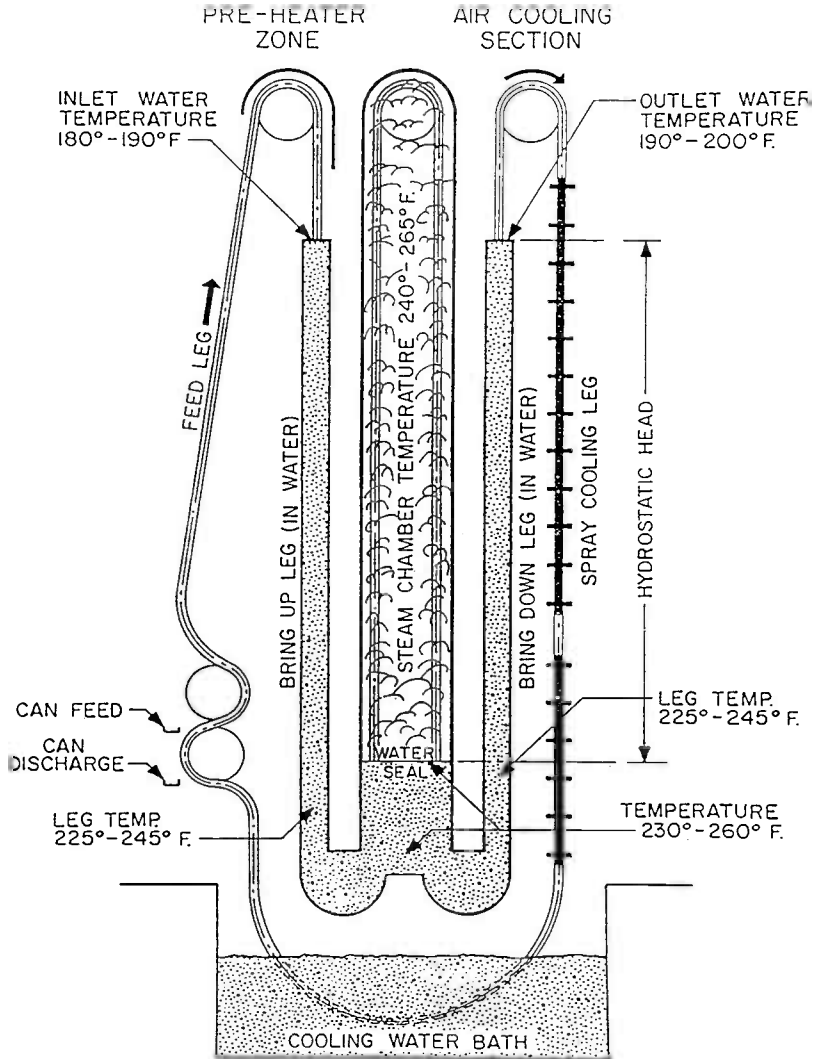


Hydrostatic sterilizer  
(Courtesy FMC Corp. food processing machinery Div.)

**Figure 17.11** External view of full-scale industrial hydrostatic retort. (Photo courtesy of JBT FoodTech, formerly FMC FoodTech, Madera, CA)

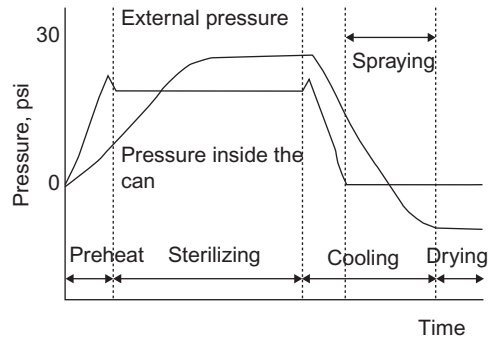


**Figure 17.12** Schematic illustration of hydrostatic retort showing basic principle of operation. (Photo courtesy of JBT FoodTech, formerly FMC FoodTech, Madera, CA)

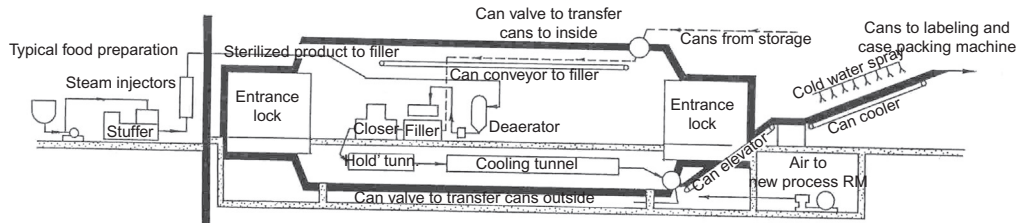


**Figure 17.13** Machine schematic of hydrostatic retort showing details of mechanical operations. From Lopez (1987), *A Complete Course in Canning*, 12th Edition. (Courtesy CTI Publications, Inc.)

sterilizing temperature to a “hot fill” operation carried out under pressure to accomplish sterility at the product–can wall interface. Conventional filling equipment and steam-flow can sealers are housed in a pressurized room or “tank” maintained at 18 psi pressure above atmosphere, as shown in Figure 17.15. Hot product enters the tank at a sterilizing temperature of 265°F. It then flash cools to 255°F (the boiling point at 18 psi pressure). The filled and sealed cans are then processed through a continuous horizontal retort to accomplish a controlled hold time at 255°F to sterilize



**Figure 17.14** Pressure and temperature profiles during thermal processing in a typical hydrostatic retort sterilizer system. From Lopez (1987), *A Complete Course in Canning*, 12th Edition. (Courtesy CTI Publications, Inc.)

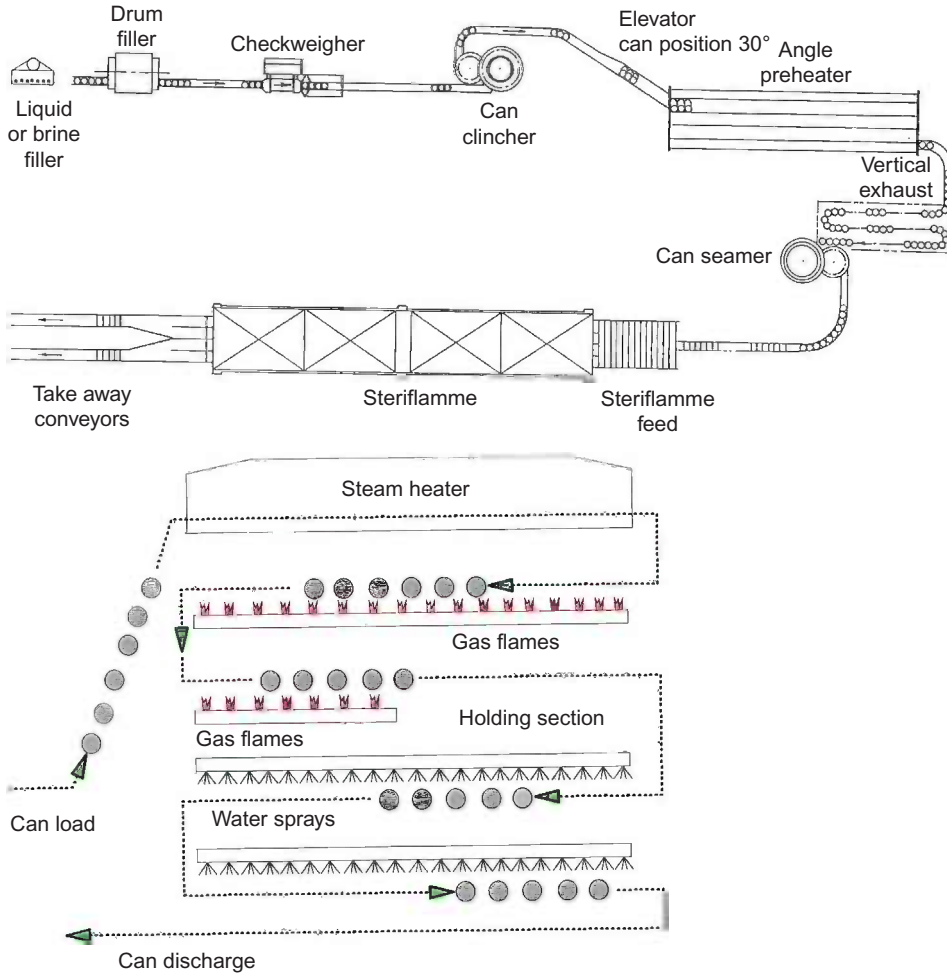


**Figure 17.15** Schematic diagram of Flash "18" system. From Lopez (1987), *A Complete Course in Canning*, 12th Edition. (Courtesy CTI Publications, Inc.)

the inside can surfaces and deliver the required process time before final cooling and exit through pressure seal valves. This system is used primarily for large institutional size cans that would otherwise require such long retort processes that the resulting product quality would be unacceptable.

### 2.2.5 Steriflamme System

The Steriflamme process is shown in Figure 17.16. After closing under a high vacuum, cans are first preheated in steam and then further heated by rotating rapidly over direct contact with flames from a gas burner. After a necessary holding time to ensure sterilization, the cans are cooled by means of a water spray, as shown in the schematic diagram of the process in Figure 17.16. A high vacuum is important to prevent distortion of can seams, as the cans themselves become their own retort pressure vessels when heated by the gas flames. The process is often used for canned vegetables such as corn, peas, carrots, and mushrooms when minimum brine content is required.



**Figure 17.16 Schematic diagram of Steriflamme system.** From Lopez (1987), A Complete Course in Canning, 12th Edition. (Courtesy CTI Publications, Inc.) *Schematic diagram of Steriflamme system—sequence of operations within Steriflamme.* (With courtesy from Lopez,1987)

### 3. AUTOMATED MATERIALS HANDLING SYSTEMS

The preponderance of thermally processed shelf-stable foods in the marketplace today continues to be processed in batch retorts that must be repeatedly loaded and unloaded between each process cycle throughout the workday. In years past this was performed by teams of workers with the help of chain hoists and rail carts as they moved from retort to retort around the cook room floor, while retort operators kept vigilance as time keepers, temperature monitors, and record keepers. Recent innovations in retort control and materials handling systems have essentially revolutionized



**Figure 17.17** *Modern day retorts on cook room floor in a large food canning facility. (Photo courtesy of JBT FoodTech, formerly FMC FoodTech, Madera, CA)*

traditional cook room operations. Today's modern retorts such as those shown in [Figure 17.17](#) are equipped with sophisticated computerized electronic control systems that can be remotely monitored from a control room by a single operator who may be responsible for an entire battery of retorts ([Figure 17.18](#)). These control systems are capable of operating each retort through its entire process cycle, while controlling and recording temperatures and pressures, as well as monitoring process conditions at all critical control points. At the end of each process cycle, a complete set of batch records is provided for compliance with record keeping requirements of the FDA Low-acid Canned Food regulations.

The introduction of automation and robotics for materials handling operations on the cook room floor has perhaps had the greatest impact in reducing the cost to manufacture thermally processed products. An automated batch retort system in a modern cook room today consists of a battery of retorts laid out in a row on the cook room floor to accommodate automated loading and unloading ([Figure 17.19](#)). Both track-guided and trackless systems are available for this purpose. In track-guided systems, a rail cart transfers crates or baskets of product from loading stations to the retorts, and from the retorts to the unloading stations automatically on a rail track. The track allows the cart to move in a transverse direction along the cook room floor until it is aligned with the target retort ([Figure 17.20](#)). Once the cart is aligned with the retort, the loaded baskets or crates

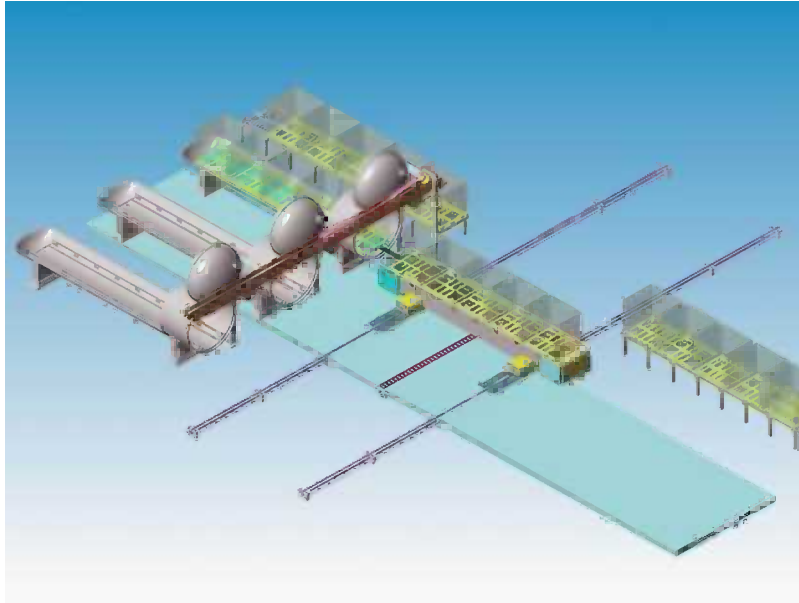




**Figure 17.18** Computerized electronic control systems to remotely monitor retort operations by a single operator responsible for an entire battery of retorts. (Photo courtesy of JBT FoodTech, formerly FMC FoodTech, Madera, CA)



**Figure 17.19** Modern cook room showing battery of retorts arranged for automated loading and unloading. (Photo courtesy of JBT FoodTech, formerly FMC FoodTech, Madera, CA)



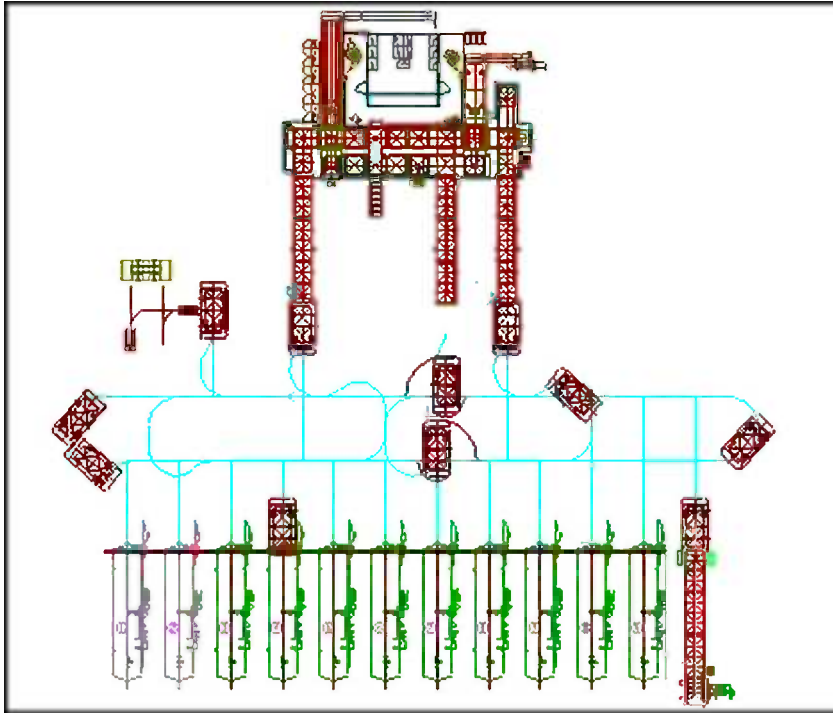
**Figure 17.20** *Track-guided automated batch retort system (ABRS). (Courtesy Allpax Products, Inc., Covington, LA)*

automatically transfer from the cart into the retort for loading operations, or from the retort onto the cart for unloading operations.

Trackless systems work in much the same way, except that rails and rail carts are replaced by automated guided vehicles (AGV) that move about the cook room floor controlled by electronic guidance systems (Figure 17.21). These systems offer the advantage of keeping the cook room floor free of rails or tracks that could impede safe movement of workers on the floor. A close-up view of AGVs approaching or returning from retorts awaiting loading or unloading is shown in Figure 17.22, and an AGV having just loaded or about to unload a retort is shown in Figure 17.23.

#### **4. ASEPTIC PROCESS EQUIPMENT SYSTEMS**

Recent regulatory approval for the use of chemical sterilants such as hydrogen peroxide to sterilize the surfaces of various paper, plastic, and laminated packaging materials has opened the door to a wide array of commercially available aseptic filling systems to produce shelf-stable liquid foods in a variety of gable-topped, brick-packed, and other novel package configurations. Filling machines designed for these packaging systems are usually based on the use of form-fill-seal operations. In these machines, the packaging material is fed from either pre-cut blanks or directly from roll stock, passed through a chemical sterilant bath or spray treatment, formed into the final



**Figure 17.21** Trackless system layout for automated guided vehicles (AGV). (Photo courtesy of JBT FoodTech, formerly FMC FoodTech, Madera, CA)

package shape while being filled with cool sterile product from the product sterilizing system, and then sealed and discharged, all within a controlled aseptic environment (Figure 17.24).

Another important commercial application of aseptic processing technology is in the storage and handling of large bulk quantities of sterilized food ingredients, such as tomato paste, fruit purees, and other liquid food concentrates that need to be purchased by food processors, or institutional end users for use as ingredients in further processed prepared foods. The containers for such applications can range in size from the classic 55-gallon steel drum to railroad tank cars or stationary silo storage tanks. Specially designed aseptic transfer valves and related handling systems make it possible to transfer sterile product from one such container to another without compromising sterility. A schematic flow diagram of a typical aseptic processing system for 55-gallon steel drums is shown in Figure 17.25, with a cutaway view of a typical aseptic drum-filling station in Figure 17.26. A system such as this is capable of filling 15 drums per hour, with each drum containing nearly 500 lb of product (Rice, 1987; Wagner, 1982).



**Figure 17.22** Automated guided vehicles in the process of approaching or returning from retorts awaiting loading or unloading. (Photo courtesy of JBT FoodTech, formerly FMC FoodTech, Madera, CA)

## 5. LOW-ACID CANNED FOOD REGULATIONS

Food engineers involved with thermal processing operations should be familiar with all federal regulations applicable to sterilization of low-acid canned foods. The specific provisions for regulating the low-acid canned food industry are contained in Title 2, Part 113 of the US Code of Federal Regulations entitled “Thermally Processed Low-Acid Foods Packaged in Hermetically Sealed Containers”. These regulations are also published in detail in *The Almanac of the Canning, Freezing, Preserving Industries* (Judge, 2012), and were summarized earlier by Teixeira (2007). The purpose of this concluding section is to acquaint the food engineer with the scope of compliance activities required to initiate and sustain commercial food canning operations under these regulations. In the broadest sense, these regulations direct the attention of low-acid canned food processors to four operational levels:

1. Adequacy of equipment and procedures to perform safe processing operations.
2. Adequacy of record keeping to prove safe operations.
3. Justification of the adequacy of time-and-temperature processes used.
4. Qualifications of supervisory staff responsible for thermal processing and container closure operations.



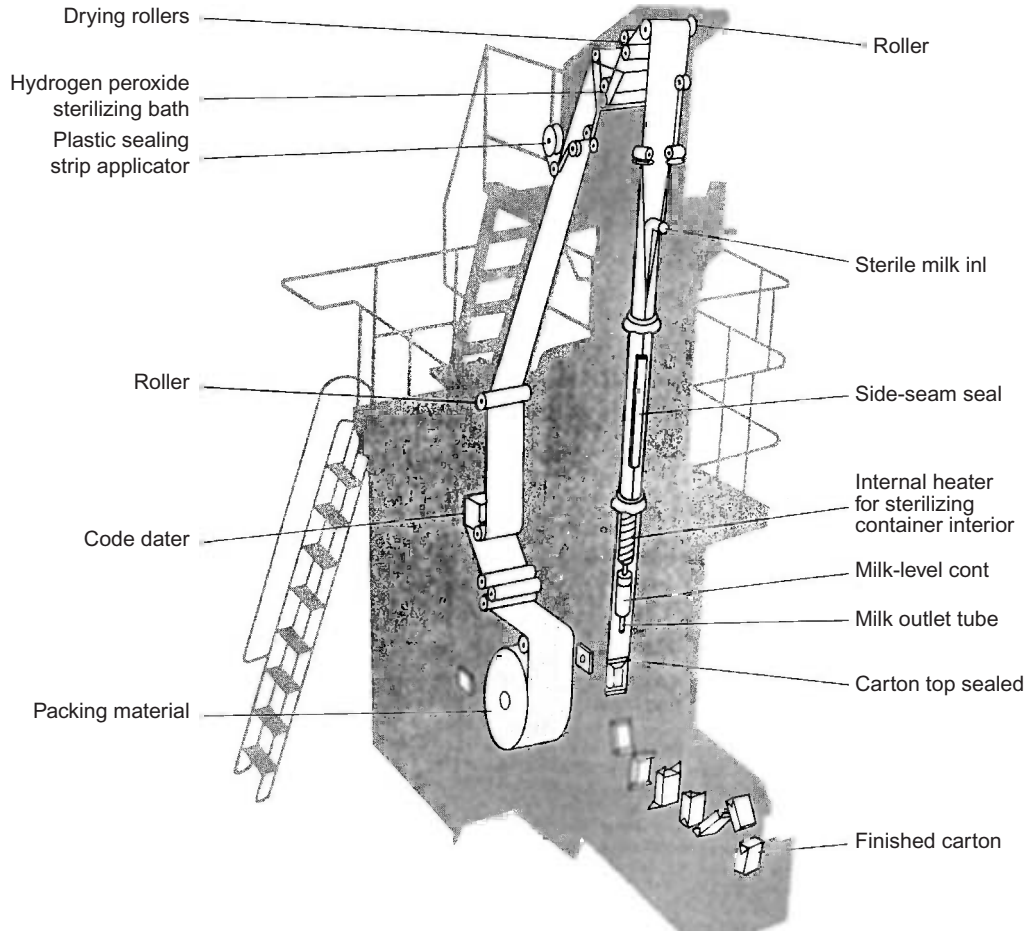
**Figure 17.23 Automated guided vehicle in process of retort loading/unloading.** (Photo courtesy of JBT FoodTech, formerly FMC FoodTech, Madera, CA)

The requirements of the regulation can be further broken down into 11 specific compliance activities, as described below.

1. *Plant registration.* This compliance activity requires that every plant producing low-acid canned foods and selling these foods in the USA be registered with the Food and Drug Administration (FDA). This is accomplished by the submission of necessary forms (FD 2541), which require such information as:

- Name of company.
- Place of business.
- Location of plant.
- Processing method: type of equipment used.
- List of food products processed.

Although most processors normally provide this type of information regularly for their trade associations and for various business accounting purposes, technical and administrative personnel need to exercise care in such matters as choosing appropriate definitions for the type of equipment and processing method they use, and in defining each “product” for the list of products required. If a plant has to close for reasons other than seasonal operations or labor disputes, the regulation requires notification to the FDA within 90 days of closing.



**Figure 17.24** Schematic illustration of form-fill-seal aseptic filling machine with packaging material fed from roll stock. (Courtesy Tetra-Pak)

2. *Process filing.* This compliance activity requires all processors to file Form 2541a for each product with the FDA within 60 days of plant registration and prior to packing any new product or adopting any change in process for an existing product. The type of information required on each form may include:

- Name of product and container size.
- Processing method used and type of retort.
- Minimum initial product temperature (IT).
- Time and temperature of processing.
- Process lethality or equivalent scientific evidence of process adequacy.
- Critical factors affecting heat penetration.

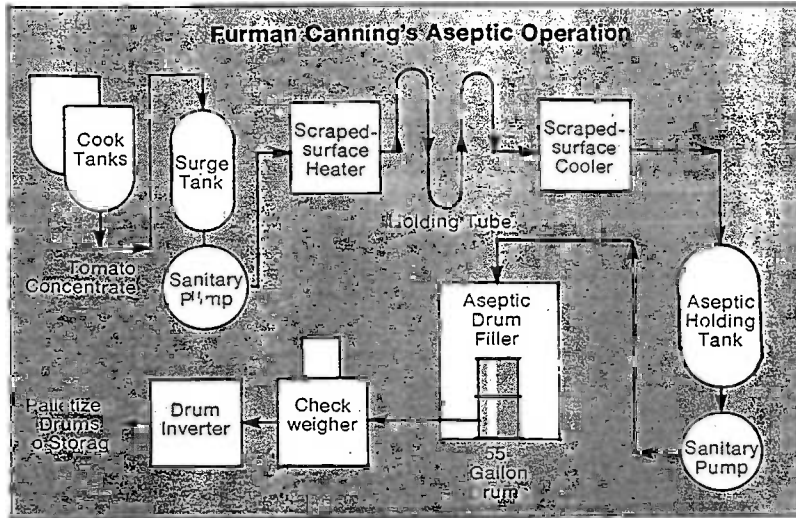


Figure 17.25 Schematic diagram of aseptic drum filling operation (Rice, 1987; Wagner, 1982).

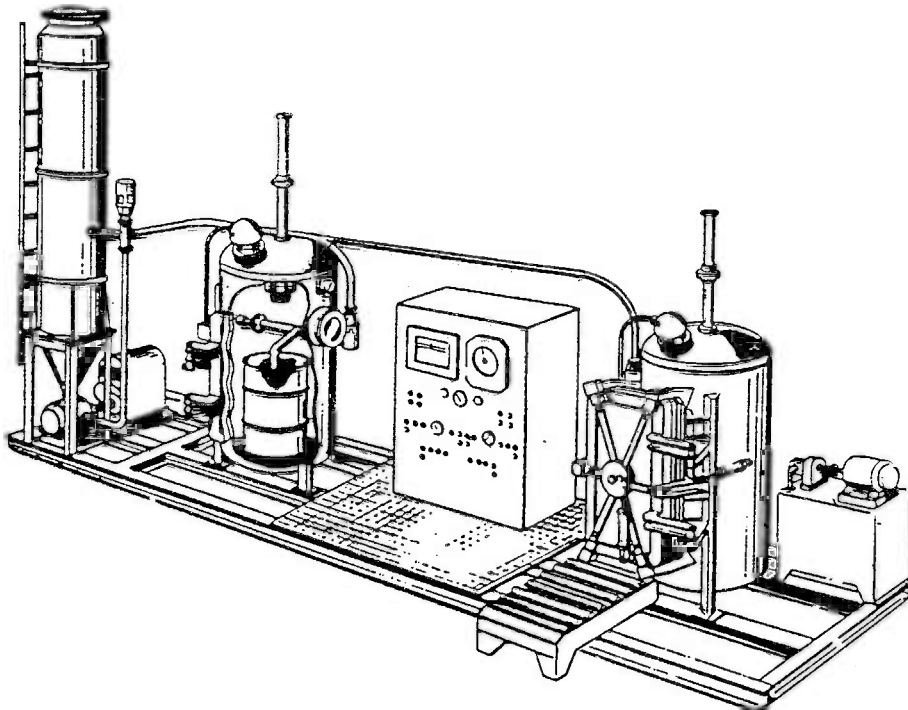


Figure 17.26 Schematic illustration with cutaway view of dual chamber aseptic drum filling operation. From Lopez (1987), A Complete Course in Canning, 12th Edition. (Courtesy CTI Publications, Inc.)

- Authoritative source used and date of establishment of the process.  
One form containing all of this information is required for each product in each size container for all product–container size combinations processed in any given plant.
- 3. *Personnel training.* This compliance activity requires that supervisors of operators of retort processing systems and container closure inspectors must have attended a school approved by the FDA and have satisfactorily completed the prescribed course of instruction. These “Better Process Control and Container Closure” schools are sponsored jointly on a regular basis by the FDA and the National Food Processors Association (NFPA). They are held in conjunction with the food science departments at a number of colleges and universities across the country to bring them within reasonable proximity to most canned food processors. The curriculum is presented in a short-course format over 4-1/2 days, including examinations of the material presented and the awarding of certificates of completion.
- 4. *Equipment and procedures.* This compliance activity requires all processors to make certain that equipment related to the thermal processing operations is maintained in compliance with established specifications. For still cook retort operations, these requirements relate to such items as:
  - Mercury and glass thermometers.
  - Temperature recorders or recorder–controllers.
  - Steam pressure controllers and gages.
  - Steam inlet size, headers, and location in retort.
  - Steam spreaders and bleeders.
  - Crates (baskets), crate supports, and separators.
  - Vents, size and location, venting times and temperature.
  - Water-level indicators.
  - Level indication for retort headspace in pressure cooking.
  - Air supply to pneumatic controllers.
- 5. *Product preparation.* This compliance activity requires each processor to have documented policies and procedures for this product preparation, production, and sanitation, delineating proper procedures to be followed in such areas as:
  - Raw material testing and certification, including proper storage and inventory control.
  - Blanching and cooling operations.
  - Filling operations, including frequent monitoring of critical factors such as initial product temperature, fill weight, headspace, product density, viscosity, and pH.
  - Exhausting of headspace air prior to closing by heat, vacuum, steam injection, hot brine, and so on.
  - All areas of plant, equipment, and materials–handling sanitation.



This compliance activity forces all processors to review thoroughly existing quality control and sanitation policies and procedures, or develop appropriate policies and procedures where none have previously existed.

6. *Establishing scheduled processes.* This compliance activity requires all processors to document and file the following information in support of establishing the scheduled process for any new product or product-process change that is to be filed with the FDA:
  - The source of qualified expert knowledge used in establishing the scheduled process.
  - The heat penetration tests, microbial death time data, and thermal process calculations used to establish the scheduled process.
  - Specification of all critical control factors affecting the scheduled process.
  - Verification of the scheduled process through inoculated packs, or incubation of product samples from initial production runs.
7. *Thermal process operations.* This compliance activity specifies minimum requirements that processors have to meet with respect to operations that take place in the retort room or cook room, where the filled and sealed cans or jars are sterilized under pressure in steam or water–air override retorts. Some of these requirements include:
  - Posting of scheduled processes.
  - Use of heat-sensitive indicators.
  - Review of data on all critical control factors to make certain that they fall within specifications for the scheduled process prior to sterilization.
  - Calibration of thermometers, recorders, controllers, and timing devices.
  - Control of retort operations to assure compliance with specified venting procedures and time-temperature conditions for the established thermal process.
  - Use of a fail-safe traffic control pattern to make certain that no unprocessed product can be mistaken for processed product, or vice versa.
8. *Process deviations.* This compliance activity specifies what processors have to do in the event of a process deviation, such as drop in temperature caused by a sudden loss of steam pressure or a reduced cook time caused by a faulty timer, which would suggest that the product received a process less than the scheduled process. In the event of such a process deviation, the regulation specifies that the processor must either: (a) reprocess the product according to the established scheduled process and retain all records of such event; or (b) put the product on “hold” and have the “deviate” process evaluated for its public health significance by a recognized processing authority with qualified expert knowledge. Such a processing authority may “clear” the deviation if it is judged to pose no significant risk to public health. Again, records containing documentation in support of such an evaluation have to be retained on file.

As most canned food products cannot tolerate a second exposure to the heat sterilization process without serious degradation in physical quality, processors generally prefer to put products on hold while process deviations are evaluated. Large processors clear deviations quickly with appropriate documentation. Other processors may rely on outside services provided by trade associations, can manufacturers, or consultants.

9. *Container closure and coding.* This compliance activity specifies the inspection and testing required to assure that all containers are properly closed and coded prior to sterilization. Some of the activities specified include:
  - Visual inspection of can top seams (or glass jar closures), at a minimum frequency of once every 30 min, with documentation for records retention.
  - Complete seam teardown with measurement of critical dimensions taken under optic magnification (or coldwater vacuum tests for glass jars) at a minimum frequency of once every 4 h, along with documentation for records retention.
  - Periodic testing of cooling water to check concentration of residual chlorine.
  - Proper code on each container for:
    - Identity of product.
    - Where packed (plant).
    - When packed (date).
    - Who packed (shift or line).
  - Use of proper postprocessing can handling systems to minimize damage to can seams or closures prior to labeling and case packing.
10. *Records and storage.* This compliance activity requires all processors to prepare, review, and retain all records from each product packed for at least 1 full year or packing season at the processing plant itself, followed by retention of these records for at least 2 years at some other location, so that all records will be readily available for inspection over a minimum period of 3 full years from the date the product was packed. The records themselves include all documents and recordings of data, test results, inspections, critical control factors, and so on, required by all of the individual compliance activities described previously. This means that on a continuing basis, essentially all processors must have procedures in place at each plant to:
  - Review all records for completeness.
  - Collate and arrange records in an organized file for each product “batch code”.
  - Store the records in sequence with a systematic file system for future retrieval.
11. *Recall planning.* This final compliance activity requires that all processors have on hand a plan for recalling any product through primary distribution, plus a plan for each distributor to use in recalling the product from further distribution

channels downstream. Some processors have adopted the practice of conducting “drills” to test the effectiveness of their recall plans. Such drills are not specifically required by the regulation, but are strongly advised as part of this compliance activity.

## REFERENCES

- Judge, E.E., 2012. *The Almanac of the Canning, Freezing, Preserving Industries*. Edward E. Judge and Sons, Westminster, Md. (published annually).
- Lopez, A., 1987. *A Complete Course in Canning, Book 1, Basic Information on Canning*, twelfth ed. CTI Publications, Inc., Baltimore, MD.
- Rees, J.A.G, Bettison, J., 1991. *Procesado Termico y Envasado De Los Alimentos*. Editorial ACRIBIA, S.A., Zaragoza, Spain, pp. 64.
- Rice, J., 1987. International trends in food packaging. *Food Process.* 48 (10), 86–91.
- Teixeira, A.A., 2007. Thermal processing of canned foods. In: Heldman, D.R., Lund, D.B. (Eds.), *Food Engineering Handbook*, second ed. CRC Press, Taylor and Francis Group, Boca Raton, FL, pp. 592–659 (Chapter 11).
- Wagner, J.N., 1982. Aseptic drum processing. *Food Eng.* 54 (1), 120–121.

# Artificial Neural Network (ANN) Based Process Modeling

Gauri Shankar Mittal

University of Guelph, Ontario, Canada

## 1. BASICS

Prediction of moisture and temperature profiles of food products during processing using computer simulation based on mathematical models is time consuming work as a consequence of the requirement for numerical iterative computing and special simulation or programming software. Developing ANN based on simulation data from validated models is a useful tool to use results in practice and for process controls. Trained ANN are also needed if neuro-fussy controls are incorporated for better process control.

An ANN is a data processing system based on the structure of a biological neural system. Prediction with ANN is not like modeling and simulation, but by learning from the data generated experimentally or using validated models. ANN have the ability for relearning according to new data (Hertz *et al.*, 1991). Unlike other modeling techniques such as simultaneous heat and mass transfer, kinetic models, and regression analysis, an ANN can accommodate more than two variables to predict two or more parameters. ANN differ from conventional programs in their ability to learn about the system to be modeled without prior knowledge of the process variable relationships (Ramesh *et al.*, 1996). ANN are now used for food process-related problems. Park *et al.* (1993) developed a feed-forward back-propagation NN model for predicting and classifying beef palatability attributes using ultrasonic spectral features as descriptive parameters. Arteaga and Nakai (1993) developed an ANN for predicting foam capacity and stability, and emulsion activity index using physicochemical properties of 11 food-related proteins. Greeraerd *et al.* (1997) used a low-complexity, black box ANN model to predict microbial growth considering the effects of temperature, pH, and water activity. Ruan *et al.* (1997) used two spectrum analysis techniques, fast Fourier transformation, and power spectrum density for data preprocessing as part of ANN development for predicting rheological properties of cookie dough.

## 1.1 Hidden Layers and Nodes

A decision on the number of hidden layer nodes is complex as it depends on the specific problem being solved using ANN. With too few nodes, the network may not be powerful enough for a given learning task. With a large number of nodes (and connections), computation is too lengthy. Sometimes an ANN may “memorize” the input training samples; such a network tends to perform poorly on new test samples, and is not considered to have accomplished learning successfully. Neural learning is considered successful only if the system can perform well on test data on which the system has not been trained. An ANN should have capabilities to generalize from input training sets, and not to memorize them (Mehrotra *et al.*, 1996).

## 1.2 Learning Rate and Momentum

Weight vector changes in back-propagation are proportional to the negative gradient of the error. This determines the relative changes that must occur in different weights when a training set is presented in an ANN, but does not fix the exact magnitudes of desired weight changes. The magnitude change depends on appropriate choice of the learning rate. A large value of learning rate will lead to rapid learning but the weight may then oscillate, whereas low values imply slow learning. The right value of learning rate will depend again on the application. Adding a momentum term to the weight update rule in back-propagation is to avoid trapping in some local minima in training. A value for momentum can be obtained adaptively, as in the learning rate. A well-chosen value of momentum can significantly reduce the number of iterations for convergence (Mehrotra *et al.*, 1996).

## 2. EXAMPLES

Mittal and Zhang (2000a) developed an ANN to predict temperature and moisture content of frankfurters during smokehouse cooking. Fat protein ratio (FP), initial moisture content, initial temperature, radius of frankfurter, ambient temperature, relative humidity, and process time were input variables. Temperature at frankfurter centre, average temperature of frankfurter, and average moisture content (d.b.) of frankfurter were outputs. Network training data were obtained from validated heat and mass transfer models simulating temperature and moisture profiles of a frankfurter. A back-propagation method was used for ANN training. Selection of hidden nodes, learning rate, momentum, and range of input variables were important to ANN prediction. The FP was not an important factor in predictions.

Mittal and Zhang (2000b) predicted food freezing time of food products of any shape with eight ANN inputs, where for more than 95% of cases, the relative error was less than 5%. Pham’s model (Pham, 1986) was used to generate freezing time data

and to train ANN based on Wardnets (developed by Ward System Group, Inc., Frederick, MD). The product thickness (a), width (b), length (c), convective heat transfer coefficient ( $h_c$ ), thermal conductivity of frozen product (k), product density ( $\rho$ ), specific heat of unfrozen product ( $C_{pu}$ ), moisture content of the product (m), initial product temperature ( $T_i$ ), and ambient temperature ( $T_\infty$ ) were taken as input variables of the ANN to predict freezing time. The effects of the number of hidden layer nodes, learning rate, and momentum on prediction accuracy were analyzed. The performance of the ANN was checked using experimental data. Predicted freezing time using the ANN proved a simple, convenient, and accurate method. Selection of hidden nodes, learning rate, and momentum were important to ANN predictions.

Mittal and Zhang (2000c) developed an ANN to predict heat and mass transfer during deep fat frying of infinite slab shaped foods coated with edible films. Frying time, slab half-thickness, film thickness, food initial temperature, oil temperature, moisture diffusivity of food and film, fat diffusivity through food and film, thermal diffusivity of food, heat transfer coefficient, initial moisture content of food, and initial fat content of food ( $mf_0$ ) were inputs. Temperature at the center ( $T_1$ ), and average temperature ( $T_{ave}$ ), fat content ( $mf_{ave}$ ), and moisture content ( $m_{ave}$ ) of food were outputs. Four ANNs with 50 nodes each in two hidden layers with learning rate = 0.7 and momentum = 0.7 provided most accurate outputs, i.e. maximum absolute errors for  $T_1$  and  $T_{ave}$  were  $<1.2^\circ\text{C}$ ,  $<0.004$  db for  $m_{ave}$  and  $<0.003$  db for  $mf_{ave}$ . The predictions of  $mf_{ave}$  varied linearly with  $mf_0$ .

Two ANNs were developed (Mittal and Zhang, 2002) to predict thermal process evaluation parameter (g) and  $f_h/U$  (the ratio of heating rate index to the sterilizing value), respectively. The temperature change required for the thermal destruction curve to traverse one log cycle (z), cooling lag factor ( $j_c$ ) and  $f_h/U$  were input variables for predicting g; and z,  $j_c$ , and g were inputs for predicting  $f_h/U$ . The data used to train and verify the ANN were obtained from reported values. Shrinking of input and output variables using natural logarithm function improved prediction accuracy. Use of Wardnets with three slabs of 14 nodes in each slab with learning rate of 0.7 and momentum of 0.9 provided the best predictions. The g (unshrunk values) was predicted with mean relative error of  $1.25 \pm 1.77\%$  and mean absolute error of  $0.11 \pm 0.16^\circ\text{F}$ . The  $f_h/U$  was predicted with mean relative error of  $1.41 \pm 3.40\%$  and mean absolute error of  $2.43 \pm 15.97$  using 10 nodes in each slab. Process time calculated using the g from the ANN models closely followed the time calculated from tabulated g values (RMS = 0.612 min, average absolute error = 0.466 min with s.d. of 0.400 min).

### 3. MEATBALL COOKING EXAMPLE IN DETAIL

An ANN was developed (Mittal and Zhang, 2001) to predict heat and mass transfer during deep fat frying of meatballs. Frying time, radius of meatball, fat diffusivity,

**Table 18.1** Input Variables and their Values for ANN Training

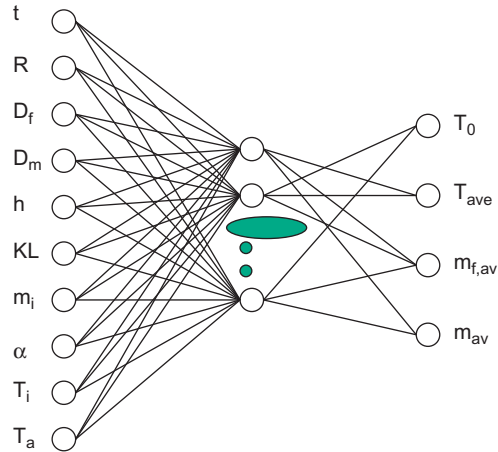
Input Variables	Values for Data Generation
Frying time (t), s	240, 360, 480, 600
Radius of meatball (R), m	0.01, 0.02, 0.03
Fat diffusivity ( $D_f$ ), $10^{-7}$ m <sup>2</sup> /s	0.15, 0.45
Moisture diffusivity ( $D_m$ ), $10^{-9}$ m <sup>2</sup> /s	0.1, 0.45, 0.80
Heat transfer coefficient (h), W m <sup>-2</sup> K <sup>-1</sup>	250, 350
Fat conductivity (KL), $10^{-4}$ m/s	0.2, 0.4
Initial moisture constant ( $m_i$ ), db	2.00, 2.75, 3.50
Thermal diffusivity ( $\alpha$ ), $10^{-6}$ m <sup>2</sup> /s	0.05, 0.15, 0.25
Initial meatball temperature ( $T_i$ ), °C	5, 25
Oil temperature ( $T_a$ ), °C	140, 160, 180

moisture diffusivity, heat transfer coefficient, fat conductivity, initial moisture content, thermal diffusivity, initial meatball temperature, and oil temperature were all input variables. Temperature at meatball geometric center ( $T_o$ ), average temperature of meatball ( $T_{ave}$ ), average fat content of meatball ( $m_{f,ave}$ ), and average moisture content of meatball ( $m_{ave}$ ) were outputs. The data used to train and verify the ANN were obtained from validated mathematical models. This is based on earlier work by [Ateba and Mittal \(1994\)](#).

For data generation, 10 parameters were used for inputs ([Table 18.1](#)) and four for outputs, and 15,552 sets of data were generated based on the combination of parameters change. The range and intervals of input parameters were selected based on the physical properties of meat products and deep fat frying process conditions ([Huang and Mittal, 1995](#)). Constant inputs for the simulation were: specific heat of meat ( $C_p$ ) as  $3.428 \text{ kJ kg}^{-1} \text{ K}^{-1}$ , density of meatball as  $1058 \text{ kg m}^{-3}$ ,  $m_e = 0.0$ ,  $m_{fe} = 0.58$  db, and initial fat content ( $m_{fi}$ ) as 13.7% wet basis (0.6532 based on dry material excluding water and fat). Average chemical composition of the meat considered was 65.30% water, 16.54% protein, 13.71% fat, 2.83% carbohydrate, and 1.61% ash ([Ateba and Mittal, 1994](#)).

### 3.1 Neural Network Model

A three-layered ANN was developed to predict the meatball deep fat frying ([Figure 18.1](#)). Ten nodes in the input layer represented 10 input parameters and four nodes in the output layer represented temperature at the meatball centre (°C),  $T_o$ , average temperature of meatball (°C),  $T_{ave}$ , average fat content of meatball (db),  $m_{f,ave}$ , and average moisture content of meatball (db),  $m_{ave}$ . The number of hidden layer nodes was chosen according to ANN performance. The back-propagation algorithm was used for ANN training. The least testing error was taken as the criterion to stop training.



**Figure 18.1** Configuration of ANN for meatball deep frying process prediction.

### 3.2 Network Training and Testing

From the generated data (15,552 sets), 3,110 and 3,110 data sets were randomly selected as testing and production sets, respectively (approximately 20% each of total). The remaining 9,332 data sets were used for ANN training. Inputs of the data sets were normalized in the 0–1 range before using in training, testing and validation of the ANN. After training on every data set, ANN weights were adjusted. Testing data were fed to test trained ANN after training 500 epochs. Testing errors (deviations between ANN predictions and training data sets) were recorded. At the beginning of training, testing error decreased with training process. Training was continued until the testing error did not decrease. If the testing error was greater than the previous minimum testing error, then testing was continued until 100,000 epoch training was reached. After training, 3,110 production sets were used to verify ANN performance.

### 3.3 Hidden Layers and Nodes

Different hidden layer nodes and hidden layer arrangements were chosen to select the best production results (deviations between ANN predictions and production data sets). First, both learning rate and momentum were set at 0.3. In one hidden layer ANN, with the increase in nodes from 40 to 60,  $R^2$  was slightly improved; mean squared errors (MSE) were decreased for  $T_0$  and  $T_{ave}$ ; mean absolute errors (MAE) were reduced for  $T_0$ ,  $T_{ave}$ , and  $m_{ave}$ ; maximum relative errors were decreased for all outputs; and mean relative errors were also reduced for all outputs except for  $T_{ave}$  and  $m_{ave}$ . Maximum relative errors also reduced for all outputs except for  $m_{f,ave}$  and  $m_{ave}$ , other errors were not changed much when nodes were increased to 60 from 50. With further increase in nodes from 60 to 70, the various errors were increased.



For two hidden layers, for different combinations of nodes (10–20, 20–20, 30–40, and 40–40), the errors were generally higher for all outputs except for 30–40 and 40–40 combinations, and a few errors for  $m_{f,ave}$  and  $T_{ave}$  were slightly lower, but there was no improvement in  $T_0$  and  $m_{ave}$  predictions. Thus, comparing production results, ANN with 60 hidden nodes provided minimum errors. The 60 hidden node ANN was chosen for further improvement.

### 3.4 Learning Rate and Momentum

A number of combinations of learning rate and momentum were tried to reduce prediction errors. With the change in learning rate and momentum, there was no effect on  $R^2$ , correlation coefficient, and minimum absolute and relative errors. However, learning rate = 0.5 and momentum = 0.3 provided minimum values of minimum and maximum relative errors for all outputs. Others errors were minimum or near to minimum at this combination. Thus, the ANN with learning rate 0.5 and momentum 0.3 achieved the best prediction results.

### 3.5 Performance

For the best prediction results, the maximum absolute errors for prediction of  $T_0$  and  $T_{ave}$  were 1.894°C and 1.895°C, and the mean relative errors were only 0.542% and 0.145%, respectively. Much high precision was obtained for the prediction of  $m_{f,ave}$  and  $m_{ave}$ . Hence, ANN provided small errors in predicting various outputs of interest.

## REFERENCES

- Arteaga, G.E., Nakai, S., 1993. Predicting protein functionality with artificial neural networks: foaming and emulsifying properties. *J. Food Sci.* 58 (5), 1152–1156.
- Ateba, P., Mittal, G.S., 1994. Modelling the deep-fat frying of beef meatballs. *Int. J. Food Sci. Technol.* 29, 429–440.
- Greeraerd, A.H., Cenens, C., Herremans, C.H., Van Impe, J.F., 1997. A prototype grey box model using neural networks for prediction of microbial growth. *Int. Conf. Eng. Food 7*, n21–n24.
- Hertz, J., Krogh, A., Palmer, R.G., 1991. *Introduction to the Theory of Neural Computation*. Addison-Wesley Publishing Co., Redwood City.
- Huang, E., Mittal, G.S., 1995. Meatball cooking—Modelling and simulation. *J. Food Engg.* 24, 87–100.
- Mehrotra, K., Mohan, C.K., Ranka, S., 1996. *Elements of Artificial Neural Networks*. MIT Press, London.
- Mittal, G.S., Zhang, J., 2000a. Prediction of temperature and moisture content of frankfurters during thermal processing using neural network. *Meat Sci.* 55 (1), 13–24.
- Mittal, G.S., Zhang, J., 2000b. Prediction of freezing time for food products using neural network. *Food Res. Int.* 33, 557–562.
- Mittal, G.S., Zhang, J., 2000c. Use of artificial neural network to predict temperature, moisture and fat in slab-shaped foods with edible coatings during deep-fat frying. *J. Food Sci.* 65, 978–983.
- Mittal, G.S., Zhang, J., 2001. Artificial neural network for the prediction of temperature, moisture and fat contents in meatballs during deep-fat frying. *Int. J. Food Sci. Technol.* 36, 1–9.
- Mittal, G.S., Zhang, J., 2002. Prediction of food thermal process evaluation parameters using neural networks. *Int. J. Food Microbiol.* 79, 153–159.

- Park, B., Chen, R.R., Whittaker, A.D., Miller, R.K., 1993. Neural modelling for predicting beef palatability. Paper No. 933047, Amer. Soc. Agric. Eng., St. Joseph, MI.
- Pham, Q.T., 1986. Simplified equation for predicting the freezing time of foodstuffs. *J. Food Technol.* 21, 209–219.
- Ramesh, M.N., Kumar, M.A., Rao, P.N.S., 1996. Application of artificial neural networks to investigate the drying of cooked rice. *J. Food Process Eng.* 19, 321–329.
- Ruan, R., Almaer, S., Zou, C., Chen, P.L., 1997. Spectrum analysis of mixing power curves for neural network prediction of dough rheological properties. *Trans. ASAE* 40, 677–681.

This page intentionally left blank

# Design of Food Process Controls Systems

Mark T. Morgan\* and Timothy A. Haley\*\*

\*Purdue University, West Lafayette, IN, USA

\*\*Iowa State University, Ames, IA, USA

## 1. INTRODUCTION

### 1.1 Design of Food Process Controls

Design of food process controls includes the specification of sensors, actuators, controllers, software, and networks that must be fully compatible and integrated into a working system. This process control system must have real benefits for the enterprise in order to justify the costs. Many in the food industry think of process automation as a luxury that can only be justified by the largest processors. However, even small, self-contained systems purchased directly from a manufacturer typically have automatic controls installed. Process controls, automatic controls, and automation are similar terms that are commonly used interchangeably. In this chapter, the term automation will be considered a more general term, which includes the elements of process controls and automatic controls.

When examining the state of process automation in the food industry, wide ranges exist in the level of automation. Some processors rely heavily on experienced operators and manually operated controls with minimal automation. Others may have fully automated systems that only require operators to supervise and troubleshoot when anomalies occur in the system.

This chapter is divided into sections covering the basics of each of the following components of food process controls: benefits of automation, computer integrated manufacturing, automation components and terminology, control system automation (discrete controls), and continuous feedback controls, controllers, sensors, and actuators.

## 2. BENEFITS OF AUTOMATION

Automation is the mechanization of a system so that it may be operated, regulated, and controlled without the need for human intervention. Examples of automated

systems encountered in everyday life include washing machines, dishwashers, automobile cruise-control, automated car wash systems, air conditioning, and heating systems.

There are many reasons to automate a food processing system. Some of these include:

- Reduction of manual labor.
  - In developed countries such as the United States, manual labor is expensive. The most successful food companies are those that can reduce manufacturing production costs while maintaining safety and quality.
- Reduction of variability in finished product quality.
  - Customers want consistent quality in the food products they purchase. One of the goals of food automation is to regulate the process equipment to maintain a desired quality specification in the food being produced, despite variability in raw materials or disturbances in process utilities.
- Reduction in waste.
  - When automation is used to regulate food process equipment, there is less out-of-specification product that otherwise would require disposal or salvage.
- Improved productivity.
  - Productivity is the ratio of the amount of material produced to the cost of production. In many cases, automation allows for increased equipment speeds and reduced manual labor costs, both of which increase overall productivity.
- Improved food safety.
  - The objective of many food processes is to reduce the microbial load and render the final food product shelf-stable. Automatic detection and control of key variables that meet these goals during processing help to assure the production of foods safe for consumption.
- Extended equipment life.
  - Automation systems can be used to keep the process from operating in ranges that stress the equipment. Further, automation systems can provide notification when equipment or device failures appear imminent. This allows plant management to address equipment related problems before the equipment fails.
- Improved worker safety.
  - Automation systems can monitor conditions that represent a threat to worker safety and sound alarms or shut down equipment when necessary to prevent worker injury.

### **3. COMPUTER INTEGRATED MANUFACTURING**

Automatic control systems used in the food industry are generally categorized under either: 1. unit operation processing, or 2. material handling, transfer, and positioning.

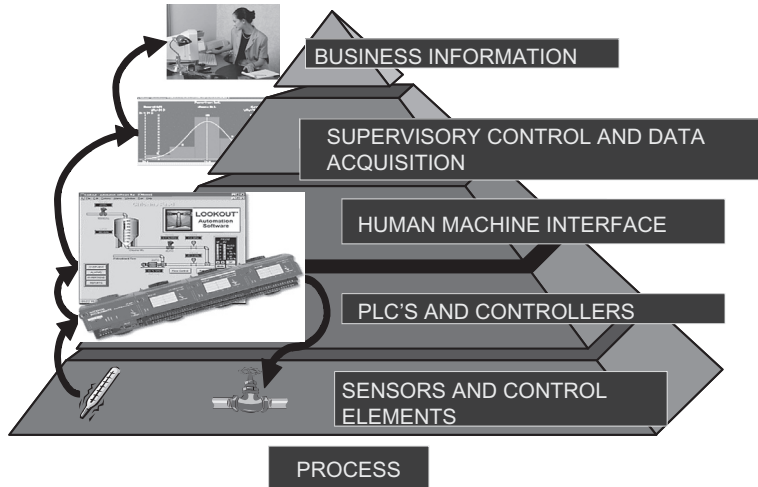
During unit operation processing, an exchange of energy, mass, or momentum is induced within the unit operation to effect some desired change in the food material contained within the equipment. All actions taken within a unit operation are intended to transform the food material from one state or condition into another more valuable state or condition. In this case, process control is synonymous with unit operation control. During material handling, transfer, and positioning, food or packaging material is physically moved from one location to another, usually between a series of intermediate unit operation processing steps.

It is interesting to note that food plants may be highly automated in one area but not in another. That is, some food plants may exhibit a high level of sophisticated control for unit operations but not for raw material or ingredient handling. Likewise, some food plants may exhibit a high degree of automated material handling and little or no automation of unit operations. Although the food industry as a whole has gradually increased its level of automation over time, there is wide variation in level of automation in the food industry.

Computer integrated manufacturing (CIM) refers to the use of computer systems to interconnect the various unit operations and material handling operations to each other and to other corporate operations such as maintenance, quality control and assurance, product development, resource planning, warehousing, marketing, and sales.

CIM is often depicted as an automation pyramid (Figure 19.1). Sensors and actuators at the process level form the base of the pyramid. Controllers form the next level. Supervisory control systems that generate process records and evaluate process trends form the next layer. Higher layers include purchasing, resource planning, warehousing, sales, and marketing. Information is filtered from the data as it passes from level to level.

For example, the control system for a food container filler provides fill weight data to a supervisory system. The supervisory system calculates the statistical mean and standard deviation of food product filled into containers. These descriptive statistics are used to calculate the fill weight target necessary so that 99% of the containers will be at or above label weight. The calculated fill weight target is transmitted regularly back to the automated filler control system. In the meantime, the amount of food material over label weight is sent to a computer system in the operations management office, where it is tabulated over time and the cost of lost material is calculated on a monthly basis. The detailed costs of these losses are transmitted to corporate headquarters, where a decision is made whether or not to purchase new fillers with a smaller variance in fill weight. The corporate managers have all the information they need to determine whether they can justify the expenditure for new fillers based on the performance of the current fillers as reported by the plant automation system.



**Figure 19.1** *Computer integrated manufacturing (CIM) automation pyramid.*

Owing to the cost and complexity, only large food manufacturing plants seek to employ total CIM. It is necessary that such systems remain secure, flexible, and robust. The recent move to open architecture software systems and standards facilitates CIM by allowing various operations within the food company to use the best-of-class software and hardware solutions. The vendors of such software and hardware only need follow industry standards to allow their systems to communicate efficiently with hardware and software provided by other vendors.

#### **4. AUTOMATION COMPONENTS AND TERMINOLOGY**

Automation has been referred to as an invisible technology or invisible glue that holds processes together. In most cases, one is unaware of the decision-making that goes on during automatic regulation of processing equipment. Although there are certain hardware elements of automation that are tangible, there are other software, electronic signals, and logic elements that are intangible. It is these intangible and indeed invisible elements that lend a certain mystery about automation to those unfamiliar with it.

**Table 19.1** Hardware Components Commonly Found in Automated Systems

Sensors	Controllers	Actuators
Transmitters	Computers and monitors	Relays
Switches	Network interfaces	Motor starters
Wires and cables	Alarms	Solenoids

**Table 19.2** Intangible Components Commonly Found in Automated Systems

Logic	Algorithms	Non-linearity
Signals	Disturbances	Gains and bias
Time delay	Noise	Software
Dynamic responses	Linearity	Process interactions

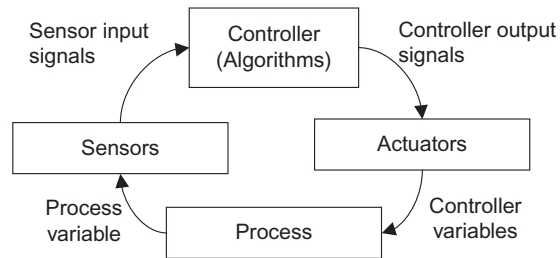
**Figure 19.2** Block diagram summarizing the interaction between sensors, actuators, and controllers with the process.

Table 19.1 lists some of the hardware components commonly found in automated systems, and Table 19.2 lists some of the intangible components commonly found in automated systems.

Switches, sensors, and transmitters are examples of hardware devices that are used to measure important process variables and events. These devices produce signals (an intangible component) that can be sent, usually by wires, to a controller. The signals from sensors and transmitters represent the measured variables of a process, also commonly referred to as the process variables (PV). Solenoids, relays, and motor starters are hardware devices, commonly called actuators, used to manipulate or change a variable in the process. The signals sent to these devices from a controller represent the manipulated variables or controlled variables (CV). The controllers themselves are typically computer or microprocessor-based devices that use logic or algorithms to determine when and how to adjust or change the controlled variables. A simple block diagram can summarize the interaction between sensors, actuators, and controllers (Figure 19.2).

Here is a list of many other components listed in the tables above.

- Signals that contain process information can be encoded in electrical wires, pneumatic lines, and hydraulic lines where they are routed between tangible hardware devices.
- Control logic is the algorithm or sequence of step-by-step operations that determine when and how controller outputs change the control variables based on information provided by sensor inputs from the process variables.



- Computer software and controllers are used to execute algorithms and mathematically manipulate the numerical values that represent the control and process variable signals.
- Computer terminals are used to display the various signals in a form that human operators can interpret.
- Alarm hardware such as indicators and sirens are used to warn human operators of abnormal conditions detected by the logic encoded in the controller.
- Linearity is the tendency of device outputs to scale linearly with their inputs. For example, a device such as a valve is considered linear if it responds with a 10% increase in output when given a 10% increase in input.
- Gain and bias are properties of linear systems that dictate how much the device output changes relative to its input. Gain and offset are synonymous with the terms slope and intercept, respectively, which are used to define a straight line in the Cartesian coordinate system. Devices that do not scale linearly are considered non-linear.
- Disturbances are unexpected signals from outside the process that influence process variables and control variable signals. These may include variability in raw material properties and upsets in the utilities that provide energy to the process.
- Noise is any statistically random disturbance.
- Time delay is a phenomenon whereby the output response of a device to its input is delayed for some period of time. This often occurs when a sensor is located some significant distance downstream of the process. Detection of process changes will be governed by residence time in the equipment and have strong implications for automation behavior.
- Dynamics are defined as the way a device's output changes with time in response to some static input. Dynamic behavior is also related to residence time as well as heat and mass transfer properties of the food and/or equipment.
- Process interaction is the manner in which one system input affects more than one of the system's outputs. For example, pump speed can affect both heat transfer rate (and product temperature) of a liquid food product in a heat exchanger as well as its flow rate (throughput).

## 5. CONTROL SYSTEM OBJECTIVES

All automation systems have one or more specific, measurable objective that is directly related to the overall process objectives. Each automation objective is termed a set point (SP). The sole purpose of automation is to achieve those specified objectives (SP) without the need for human intervention. Often the degree of automation is measured by the degree to which human intervention is not required to meet manufacturing objectives.

The key to successful automation design is how well the automation objectives (SP) correlate with the process objectives. Often, the process objectives in food processing are to produce a safe, high-quality food product with a reasonable shelf-life, as efficiently as possible. As there are no sensors that directly measure safety, quality, shelf-life, and efficiency, these objectives must be recast in terms of process variables that can be measured and regulated by control variables. The role of food scientists and engineers during the design stage of unit operations and material handling systems is to select those measurable process variables, control variables, and operating conditions that best meet overall process objectives.

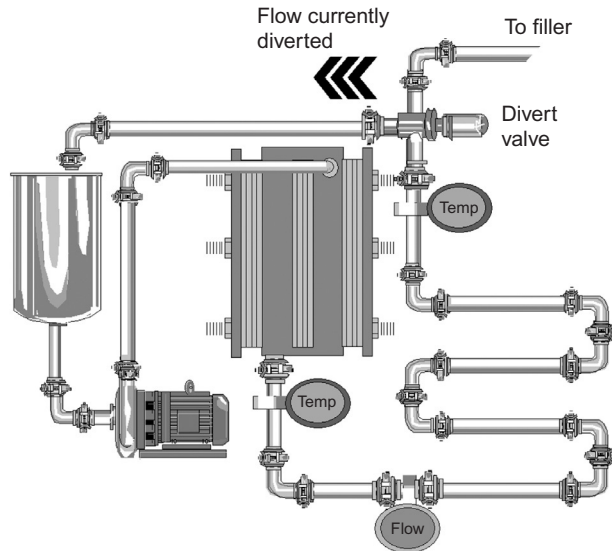
Consider pasteurization, for example. One of the process objectives of pasteurization is to eliminate all pathogenic microorganisms (safety). Another is to reduce microbial load (shelf-life). A sophisticated engineering design will translate these process objectives (that cannot be measured using sensors) into automation objectives (SP), such as target flow rates and temperatures (that can be measured). In this example, the automation SP will be assigned to maintain acceptable product flow rate and suitable product temperature necessary to meet the overall process safety and shelf-life objectives.

The automation objective (SP) is always specified in terms of the process variable. In unit operations, the process objectives and process variables used are ultimately specified in terms of mass, energy, or momentum transfer within the unit operation. For example, in a food dryer, the automation SP is the moisture content of the final product and is based on mass transfer. For pasteurization, the automation SP are the product temperature and residence time (in a heat exchanger) and are based on energy transfer. In material handling operations, the process objectives and process variables used are ultimately specified in terms of position, speed, and acceleration of products or conveying equipment.

## 5.1 Discrete Control

Discrete control is automation that involves logical and sequential control of discrete devices. Logical operations and discrete devices are those that have no dynamic behavior. The simplest operations or devices are either true or false, on or off. Discrete control is also commonly referred to as on–off or logic control. Two-state devices include sensors that exhibit only two input states (e.g. high/low, on/off, hot/cold, high-pressure/low-pressure, etc.) and control elements that exhibit only two output states (e.g. open/closed, on/off).

Figure 19.3 shows an example of discrete control in the food processing industry; the flow diversion valve used during pasteurization, and aseptic processing. During startup, the diversion valve is normally open to divert unpasteurized product away from the filler. Also, if the product temperature exiting the pasteurizer drops below a



**Figure 19.3** Discrete control example: the flow diversion valve used during pasteurization and aseptic processing.

minimum predefined threshold at any time during processing, the diversion valve is opened to send the product back for reprocessing. It is only closed when the temperature rises above a threshold indicating that product has been adequately pasteurized and is ready for packaging. Note that the valve can be in only one of two states at a time, that is, diverted flow (normally open) or forward flow (closed).

In general, discrete control is not suitable for precise regulation of temperature, flow rate, and pressure. It is primarily used in material handling operations (flow diversion can be considered a type of material handling). Like the flow diversion example, most discrete control systems can be explained by logic statements such as: “If switch A is closed then turn on motor 2.”

However, as early logical control systems relied on hardwired, electrical circuits like the one on the left in [Figure 19.4](#), “logic wiring diagrams” were used to explain control logic of the many circuits at one time. These logic diagrams were called relay ladder logic (RLL), and represented the connections of electrical switches and devices that allowed electrical current to flow through the circuits to power the loads, such as motors, solenoid valves, lights, etc.

Today, programmable logic controllers (PLC) have replaced hard-wired control circuits in most applications. For this reason, ladder logic diagrams have been adopted as the symbolic language most commonly used to document and implement discrete control operations. PLC are usually programmed with a software interface that mimics

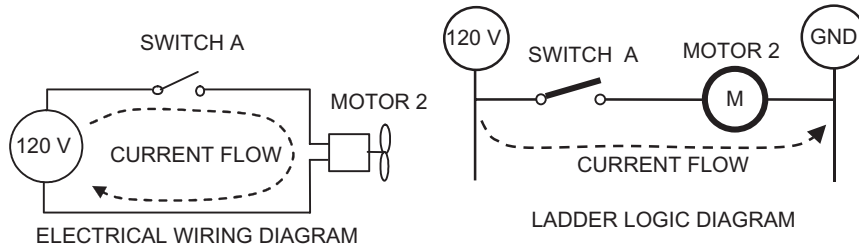


Figure 19.4 Wiring diagram (left) and logic diagram (right).

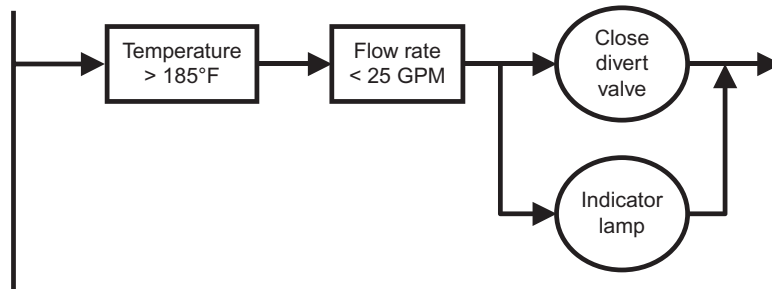
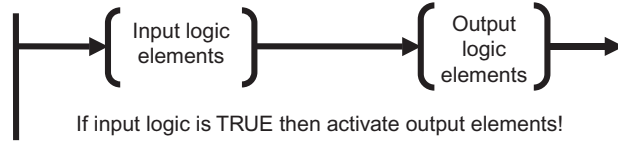


Figure 19.5 Example of a ladder logic diagram.

ladder logic diagrams. In the software version of ladder logic, true/false functions typically replace the electrical switches and a true statement is analogous to closing an electrical switch. An example of a ladder logic diagram that may be programmed into a PLC for controlling the example of a diversion valve during pasteurization is shown in Figure 19.5.

The logic in the diagram assumes that the divert valve is normally open, diverting fluid away from the filler unless proper temperature and flow conditions are met. Once the specified temperature and flow conditions are met, the divert valve is closed, allowing the product to flow to the filler and an indicator lamp is illuminated signifying that the product is flowing to the filler.

In ladder logic, the instructions are placed on rungs between two vertical posts, hence the reference to the logic as a ladder diagram. Although the example above shows only one rung of logic, it is common for ladder diagrams to contain hundreds of rungs. The interpretation always begins at the left-hand post and moves across to the right-hand post. All rungs are evaluated by moving from left to right. Logical input element(s) placed at the left side of each rung are evaluated first and, if all elements are found to be true, then output element(s) for that rung are executed. If any, or all, of the input element(s) are not true, the output element(s) for that rung are not executed (Figure 19.6).



**Figure 19.6** Example of a ladder logic execution.

When a PLC is used to implement ladder logic, each rung is executed one at a time, from the top to the bottom of the ladder diagram. In most instances, the time it takes for a PLC to scan all of the rungs is short (in the order of 100 ms) and is functionally equivalent to all rungs executing simultaneously.

## 5.2 Continuous Control

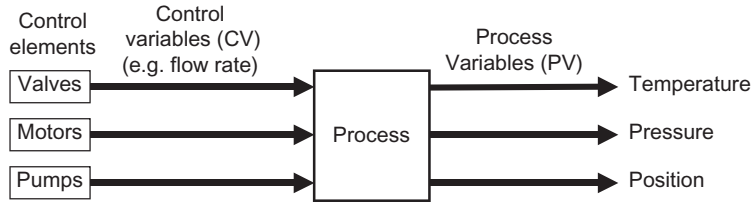
Continuous control is automation that involves the sensing and adjustment of devices that can vary incrementally between their limits. Prior to the use of microprocessors and PLC, this was referred to as analog control because of the use of analog signals and controllers. Analog devices include sensors that measure process variables over a range of values (e.g. 32–300°F, 0–100 GPM, 0–50 psig) and control elements that can be positioned between 0% and 100%. For example, continuous control is used to regulate the temperature of product exiting a heat exchanger during a pasteurization process.

In order to use these analog devices with a digital, microprocessor-based controller, such as a PLC, the analog signals from these devices must be converted to digital form. Most PLC or microprocessor-based controllers have analog to digital converters (ADC), which perform this task.

Continuous control is primarily used in the regulation of mass and energy flow in unit operations. Distributed control systems (DCS), developed in the 1970s, were originally used to implement continuous control. These systems consisted of large, mainframe computers that would perform all continuous control calculations for an entire process line or manufacturing plant. However, owing to the widespread success of PLC in the 1980s to control discrete devices, continuous capabilities were added to PLC. Today, most food processing plants use PLC to implement continuous control for unit operations.

## 5.3 Block Diagrams

Block diagrams are used to illustrate the flow path of the invisible *signals* that pass between hardware devices. Block diagrams consist of blocks, arrows, and arithmetic junctions. Blocks represent a device that has one or more inputs and/or outputs. Arrows represent a signal that carries information. Arithmetic junctions are used to represent mathematical operation on signals. Block diagrams are different from



**Figure 19.7** *Generic block diagram showing signals between blocks.*

manufacturing flow charts in that the arrows depict the path of *signals* and not necessarily the path of food materials. For example, consider the generic block diagram in [Figure 19.7](#).

In this example, valves, motors, and pumps are identified as control elements for some process. The control variable (e.g. the pump speed) is considered to be the signal manipulated by the control element and thus will have a specific effect on the process. Temperature, pressure, and position are identified as process variables. The numerical value of each process variable (for example temperature) is considered a signal and represents some aspect of the state of the process.

## 5.4 Closed Loop Systems

A *closed loop* system implies a structure, whereby PV signals generated by the process output are ultimately used to determine the control variables (CV) that regulate the process input.

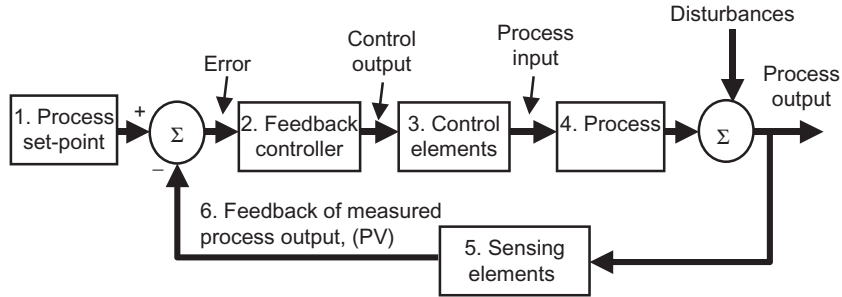
A commonly used closed loop automation technique is negative feedback control. A negative feedback control system consists of:

1. Process SP signal.
2. Feedback controller.
3. Control elements.
4. Process to be controlled.
5. Sensing element.
6. Process output measurement signal.

A block diagram that depicts a closed loop system (incorporating a negative feedback control strategy) is shown in [Figure 19.8](#).

The sensing elements are the measuring devices used in the feedback loop to monitor the process output. In negative feedback control, this PV is subtracted mathematically from the process SP. The SP represents the desired operating value of the process output and is usually entered by the operator.

The result of this subtraction, set point minus PV, is the error signal. The purpose of the controller is to eliminate the error. If the PV is greater than the SP, the error is negative. If the PV is less than the SP, the error is positive. The controller uses this



**Figure 19.8** Block diagram of a closed loop system (incorporating a negative feedback control strategy).

error signal to adjust the CV. If the error is negative, the CV will be reduced. If the error is positive, the CV will be increased. The magnitude with which the CV is changed depends on the controller algorithm and the magnitude of the error signal.

The control elements in a negative feedback control system are the mechanical devices used to change the process. These mechanisms vary from system to system and consist of devices such as motors, valves, solenoid switches, piston cylinders, gears, power screws, pulley systems, chain drives, and other mechanical and electrical components.

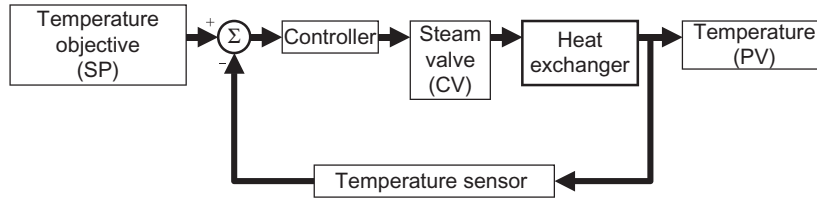
Negative feedback control is thus able to maintain some specified process behavior, despite disturbances in processing by regulating the error between the measured process output and the SP.

The difference between the term “closed loop” and the term “feedback control” is that feedback control implies some set of goals in regulating the system to some desired specification. The term “closed loop” simply defines a system structure with no implied specification on system response. Negative feedback control can thus be considered one example or subset of a closed loop system structure.

As an example of a food process that uses negative feedback control, consider the control of product temperature during pasteurization (Figure 19.9).

In this case, the objective is to regulate the product temperature to reduce microbial population to some minimum acceptable level. This is termed the temperature objective SP. The product temperature (PV) is constantly measured with a temperature sensor, such as an RTD or thermocouple. If the product temperature equals the SP, then no adjustment to the steam flow rate to the heat exchanger is necessary. However, if the PV is greater than the SP, then it makes sense that the steam flow rate should be reduced. If the PV is lower than the SP, the steam flow rate should be increased.

The controller is constantly calculating the error by subtracting the PV from the SP. If the product temperature (PV) is higher than the SP, the error is negative and



**Figure 19.9** Example of a food process that uses negative feedback control; control of product temperature during pasteurization.

the controller throttles the steam valve (CV) to reduce the amount of steam going to the heat exchanger, which decreases product temperature. If the product temperature is lower than the SP, the error is positive and the controller opens the valve (CV) to increase the amount of steam going to the heat exchanger, which increases product temperature.

## 5.5 PID Control Algorithm

The most common feedback control method is the PID algorithm. PID is an acronym for Proportional plus Integral plus Derivative action on the error signal to calculate a process input signal. A proper balance between each of these actions is necessary to obtain the desired control characteristics.

### 5.5.1 Proportional Control Action

Proportional control is the simplest form of feedback control. The output of a proportional controller is simple proportional to the error between the SP and the process output.

Mathematically, the controller output “ $u(t)$ ” is calculated as

$$u(t) = K_p \times e(t)$$

where  $K_p$  is the gain of the controller and  $e(t)$  is the error signal.

$K_p$  is also referred to as the proposal sensitivity of the controller. It indicates the change in the CV per unit change in the error. The proportional gain can be viewed as an operator-adjustable amplification of the error used to control the process input (Figure 19.10).

The larger the error, the larger the change to the process input. Likewise, the smaller the error, the smaller the change to the process input. If the error is zero, no change is made to the process input. The term Proportional (P) as used in feedback control is also known as gain, proportional gain, or sensitivity. In many industrial controllers, the proportional control is expressed in terms of proportional band (PB).



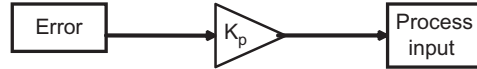


Figure 19.10 Proportional gain amplifies the error signal as a process input.

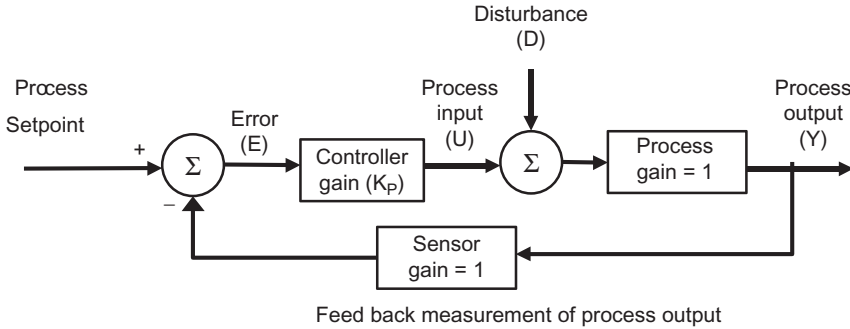


Figure 19.11 Example where the process and sensor have a gain equal to 1 and negligible dynamics.

Proportional band is defined as the percentage change in input required to produce a 100% change in the output. PB is related to  $K_p$  by

$$PB = 1/K_p \times 100$$

One drawback to proportional feedback control is that for non-integrating processes a persistent residual error can occur.

Consider a simple example in Figure 19.11, where the process and sensor have a gain equal to 1 and negligible dynamics. Using block diagram algebra, we see that the process output ( $Y$ ) equals the error ( $E$ ) times the controller gain ( $K_p$ ) times the process gain (1) plus any disturbance ( $D$ ). We also see that the error ( $E$ ) equals the setpoint ( $R$ ) minus the output ( $Y$ ) times the sensor gain (1). Summarizing, we have

$$\begin{aligned} Y &= K_p E + D \\ E &= R - Y \end{aligned}$$

This gives

$$Y = K_p(R - Y) + D$$

Solving for  $Y$ , we find

$$Y = \frac{K_p}{1 + K_p} R + \frac{1}{1 + K_p} D$$

This equation tells us that for a SP change ( $R \neq 0, D = 0$ ), the output  $Y$  can never equal the SP value  $R$ , unless the gain  $K_p$  is infinite. Likewise, the effect of a

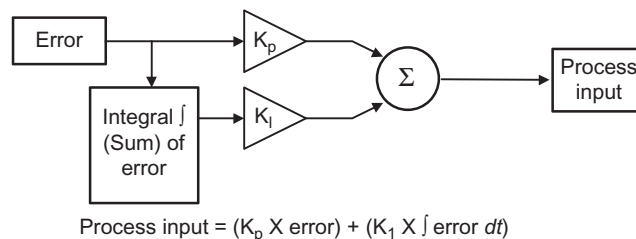
disturbance ( $D \neq 0$ ,  $R = 0$ ) on the output  $Y$  will never be completely eliminated by proportional control unless  $K_p$  is infinite.

What this means is that for most (non-integrating) processes, proportional-only control will neither enable the process to reach a new SP nor will it completely eliminate disturbances. The process output  $Y$  will be offset from its desired SP value  $R$ . In fact, this phenomenon is called *offset*. One might ask, “Why use proportional feedback control?” For simple, first-order processes with negligible disturbances operated at a constant SP, proportional feedback control (alone) may be adequate for bringing the process output to the SP more rapidly than if the process was operated in open loop. The bottom line here is that proportional control will get the process variable close to the desired SP and will speed up the dynamics of the system. Elimination of the offset in a proportional feedback controller is the role of the next control action, integral action.

### 5.5.2 Integral Control Action

The term “integrate” means to add or sum together. In fact, the integral sign ( $\int$ ) used in the integral calculus was derived by Newton from the script  $S$  and stands for “Sum”. Integral control is proportional to an integration of the error signal “ $e(t)$ ”. Thus, the value of the controller output “ $u(t)$ ” changes at a rate proportional to the error “ $e(t)$ ”. This means if the error is doubled over a previous value, the controller output increases twice as fast to compensate for the rapidly increasing error. When the process variable is at the SP (no error), the integral control action remains constant. Likewise, whenever an error is present, the integral control action is changing (increasing or decreasing) to eliminate the error.

Integral control action is usually combined with proportional control action (Figure 19.12). The combination is termed proportional plus integral action and is referred to as PI control. The output of a PI feedback controller is proportional to the error plus the sum of the error over time, as shown below. Thus, integrating action corrects for the offset that occurs in controllers with proportional only gain by integrating “out” the errors that persist over time.



**Figure 19.12** Integral control action combined with proportional control action.

The integral gain,  $K_I$ , is an adjustable parameter to “control” the amount of integral action by the controller. On some industrial controllers, the adjustable parameter for the integral mode is  $T_I$ , and the integral time-constant.  $K_I$  and  $T_I$  are reciprocals of each other.

The advantage of including integral action with the proportional action is that the integral eliminates offset. Typically there is some decreased stability (more oscillations) in the response as a result of the presence of integral action.

### 5.5.3 Derivative Control Action

Derivative control action changes the controller output proportional to the rate of change of the error signal “ $e(t)$ ”. The derivative term calculates the change-in-error and provides anticipatory action to the controller. The idea is that if the error is changing at a fast rate, then additional control action is warranted to prevent overshoot or undershoot of the SP. The amount of derivative control is determined by a proportional constant,  $K_D$ , the derivative gain (Figure 19.13).

Derivative action is usually not necessary for processes that exhibit first-order dynamics. Also, derivative action is not recommended for processes with significant measurement noise. If the measurement of the process output contains a noticeable amount of noise then derivative action will amplify the noisy signal and produce undesirable results.

The PID control algorithm, although available in several forms, has been the main workhorse of the controls industry for many years. Today, it is still useful for controlling many systems because of the flexibility in changing each of the three actions individually. Proper adjustment of the three gains to get an acceptable control system is called tuning. Tuning is often performed by trial and error by the experienced control

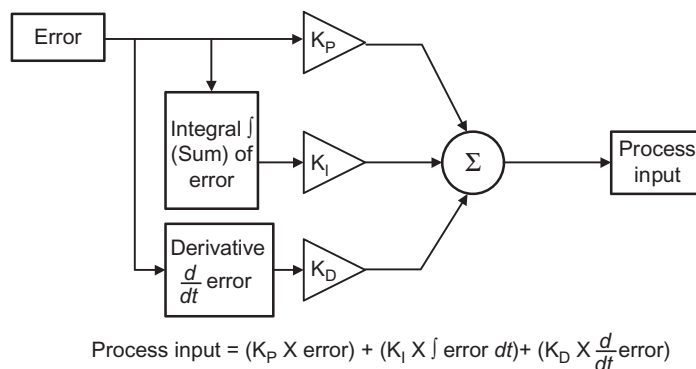
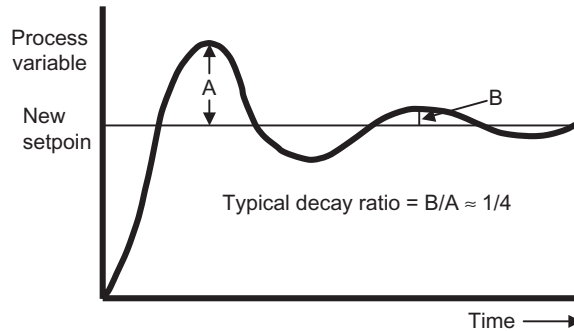
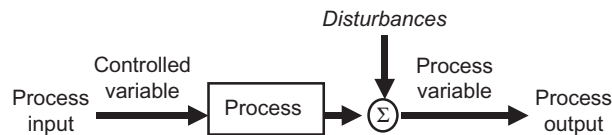


Figure 19.13 The amount of derivative control is determined by a proportional constant,  $K_D$ , the derivative gain.



**Figure 19.14** A typical response curve for a change in the set point after proper tuning.



**Figure 19.15** An open loop control system implies a control structure whereby measurements of the process variable are not used to regulate the process inputs.

systems engineer. However, there are also several methods for tuning closed loop, PID controllers. Most of the methods are based on some experimentation with the process in order to determine its dynamic characteristics. A typical response curve for a change in the SP after proper tuning is shown in [Figure 19.14](#).

## 5.6 Open Loop Control Systems

An *open loop* control system implies a control structure whereby measurements of the process variable are not used to regulate the process inputs ([Figure 19.15](#)).

In an open loop system there is no SP and no feedback controller. Processes can be operated in open loop if:

- They are stable.
- There are little or no disturbances.
- Process response time is adequate.

Some examples of food processes commonly operated in open loop are belt conveyors, mixers, pumps, dryers, and dough sheeters. For example, in a drum drying process, the drum speed and steam pressure are set to some predefined constants by the operator. Provided that there are no disturbances in the drum speed, steam supply pressure, or feedstock moisture, the quality of the product output by the dryer should remain constant ([Figure 19.16](#)). Hence, there is no need to measure the process output (product moisture or quality) in order to control the process.

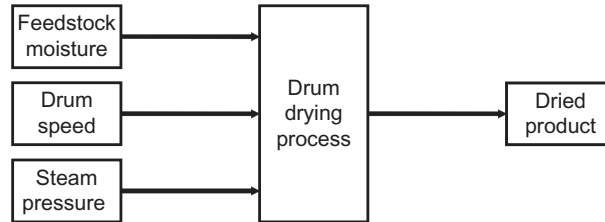


Figure 19.16 Drum drying as an example of an open loop process.

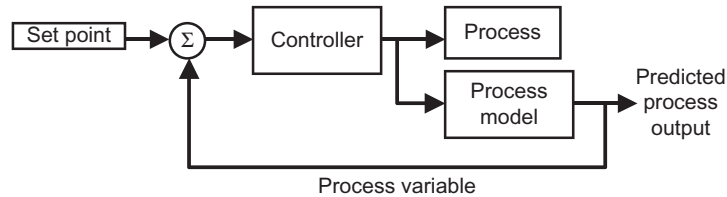


Figure 19.17 Feedback control performed using the predicted value instead of the measured value.

A process *must* be operated in open loop if:

- There is no way to sense the process variable (e.g. retorting).
- The process dynamics are too complex to implement feedback control (fermentation, extrusion).

For example, in most baking, extrusion, cooking, and retorting operations, the temperature inside the food material cannot be measured and hence the oven, extruder, or retort temperature profile and cook time cannot be based on measured product temperature. Two examples of open loop control are predictive control and feed-forward control.

## 5.7 Predictive Control

In instances where the process variable of concern cannot be measured, it may be able to be estimated using engineering models. Feedback control is then performed using the model predicted value instead of a measured value (Figure 19.17). This technique is often used in the food industry where it is difficult or impossible to measure food properties during processing. The process time and temperature used to sterilize canned foods in a retort is based on engineering models that predict how the food inside the can will heat and the how the microorganisms inside the food product succumb to the heat.

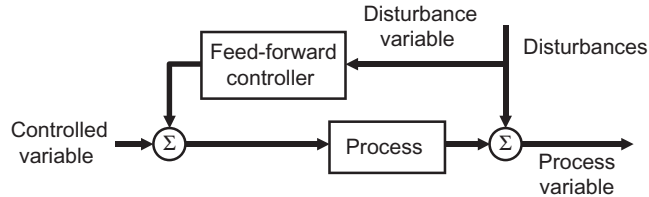


Figure 19.18 Using deviations in the disturbance variable in a feed-forward control system.

## 5.8 Feed-Forward Control

If disturbances can be measured and their effect on the process is known, then feed-forward control can be used to reduce the effect of those disturbances on the process. In feed-forward control, the measured *disturbance variable* is used to alter the controlled variable. Feed-forward control is only successful if the effect of the disturbance on the process output can be accurately predicted.

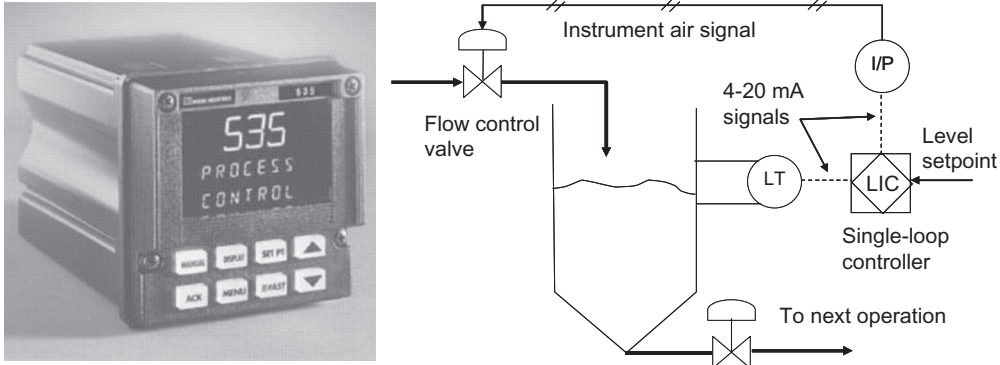
For example, consider a drying process with a long residence time. Using feedback control, a moisture sensor would be placed at the output of the drying unit and its signal would be used to adjust the drying time and or drying temperature. However, if the residence time is 3 hours, then it will take close to 3 hours to determine if the right adjustment has been made. In the meantime, the product under production may not meet quality standards for moisture and require reprocessing or disposal. Both alternatives impose unacceptable costs during manufacturing.

A better solution is to measure the moisture of incoming feed material and treat any deviation in feed moisture content from nominal as a disturbance variable and use this in a feed-forward type of controller (Figure 19.18). By measuring the moisture content of feed material entering the dryer, a mass balance calculation can be employed to determine the change in drying temperature or drying time required for that feedstock. The correct process is applied without feedback control.

Both feed-forward and predictive controls are open loop control strategies and are often confused with one another. In feed-forward control the control variable signal is computed based on an actual measurement of a disturbance variable, whereas in predictive control the control variable signal is computed based on a computational model's prediction of the process variable.

## 6. CONTROLLERS

In the food industry there are basically three types of microprocessor-based control systems, single-loop controllers, PLC, and distributed control systems (DCS). The smallest and least expensive is the single-loop controllers. Most single-loop controllers are dedicated to the continuous feedback control of one unit operation or single piece



**Figure 19.19** A typical process controller and a schematic diagram of the liquid level control system.

of equipment. For example, the level of water in a tank can easily be controlled by a single-loop controller.

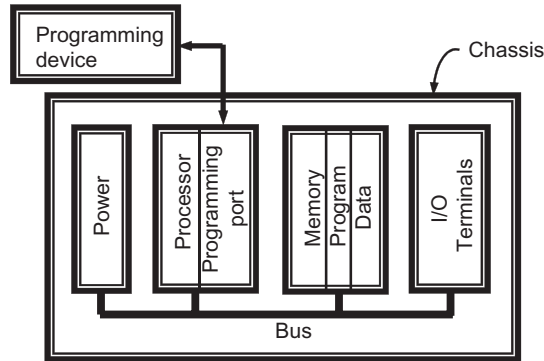
Single-loop process controllers most commonly use a PID algorithm to control the feedback loop. However, some process controllers are available, which use fuzzy logic-based control algorithms. Figure 19.19 shows a typical process controller and a schematic diagram of the liquid level control system. In this example, the controller (LIC) accepts the analog output signal, 4–20 mA, from a level transmitter (LT) and controls the position of a flow control valve (FCV) to regulate the liquid level in the tank.

Programmable logic controllers are basically specialized computer systems designed for industrial use. Instead of having a keyboard, mouse, and monitor for input and output (I/O) devices, PLC have input and output interfaces, or terminals, for connecting devices such as push buttons, switches, motor starters, and solenoids. All of the devices that would be used to sense and control a machine, system, or process can be interfaced to a PLC.

The main components of all PLC are shown schematically in Figure 19.20. Those components include a processor, memory, I/O terminals, and a power supply contained inside some type of chassis.

## 6.1 Processor

The processor, or Central Processing Unit (CPU), is the heart of the PLC and is similar to that found in any computer. The CPU organizes and controls the functioning of the PLC. It keeps track of the status of any inputs and outputs connected to the PLC, runs the program, and provides communications ports for the user to connect to the PLC and enter or change programs and monitor operating status. The CPU also performs functions that duplicate conventional timers, control relays, counters,



**Figure 19.20** The main components of PLC shown schematically.

and more complex electronic circuits. The processor is what executes the logic in a PLC.

## 6.2 Memory

The CPU uses the memory to store programs, and record the status of inputs and outputs, that is, are they on or off? The memory is usually divided into “system memory” and “application memory”. The system memory is preprogrammed with the operating software of the PLC. This memory is usually read-only memory (ROM) and cannot be changed easily by the user. The application memory consists of Random Access Memory (RAM), which is used to store ladder logic programs and input/output data. The state of each discrete input or output device connected to the PLC can be designated by a single memory *bit* whose value is 0 or 1 when the device is FALSE or TRUE, respectively. For example, the state of a discrete proximity switch will be stored in the PLC memory as a 0 if the switch is open (false) and as a 1 if the switch is closed (true).

## 6.3 Power supply

Both AC and DC powered models are available with required voltages ranging from as low as 12 V to as high as 240 V. Regardless of the type of power source for which a PLC is designed, the power supply module must convert the power into low voltage DC for use by the CPU and associated electronics. The power supplies for PLC are typically reliable and tolerant to environmental conditions, such as humidity, temperature, vibrations, etc. Most PLC do not have an uninterruptible power supply (UPS). So if electrical power outages could cause a hazardous condition in the process, one may need to be installed. Alternatively, some PLC have a programmable, emergency shutdown feature. With the aid of capacitors to store power, the PLC performs an emergency shutdown sequence when it senses a power failure. All PLC also have



some sort of battery backup that maintains the program in memory during power outages or scheduled down time.

## 6.4 Input/Output Terminals (I/O)

If the processor is responsible for the logic in PLC, then the I/O terminals can be thought of as putting the control in PLC. These I/O terminals allow the PLC to “sense” and “control” events occurring in a machine, system, or process. Small PLC have a fixed number of input and output terminals. Larger PLC have I/O modules that can be added to the PLC rack as needed, based on the size of the process being controlled. Basic types of I/O modules include:

- AC input modules—discrete signals 120 VAC typical.
- AC output modules—discrete signals 120 VAC typical.
- DC input modules—discrete signals 0–24 VDC typical.
- DC output modules—discrete signals 0–24 VDC typical.
- Analog input modules—signals ranging from 0–10 VDC, or 4–20 mA.
- Analog output modules—signals ranging from 0–10 VDC, or 4–20 mA.
- Thermocouple input modules—signals from thermocouples.
- RTD input modules—signals from resistance temperature devices.
- Communications modules—many protocols including TCP/IP, Modbus, Data Highway +, Fieldbus, Devicenet, etc.

All input and output terminals provide electrical isolation between the PLC and external signals. This isolation keeps any stray signals, short circuits, or ground faults from damaging the processor. Most I/O modules use optical isolation for this purpose. In optical isolation, electrical signals are converted into light signals and then back to electrical signals and transmitted into the PLC.

## 6.5 Chassis

The chassis, or enclosure, of the PLC is usually one of two types (Figure 19.21). For small PLC, all of the components are contained in one enclosure. The shape can be varied but some are referred to as “bricks” because of their resemblance to a square block or brick. In these small PLC, the number of input and output terminals to which external devices can be connected is fixed. Larger PLC are built in modules that are held within a large chassis called a rack. These rack-type PLC are flexible in the number of input and output terminals and types of I/O devices to which they can interface. Each slot in a rack can contain a different I/O module for inputs or outputs to/from the PLC. The slot number for each module is used as part of the address for identifying where components are connected to the PLC, as described later.

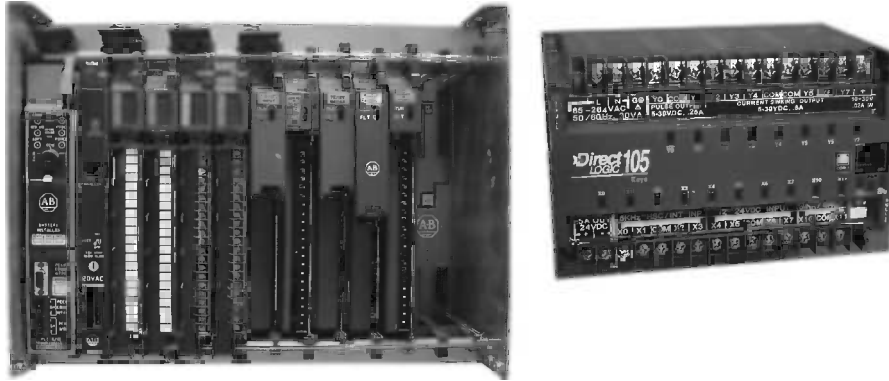


Figure 19.21 Typical rack and brick-type PLC.

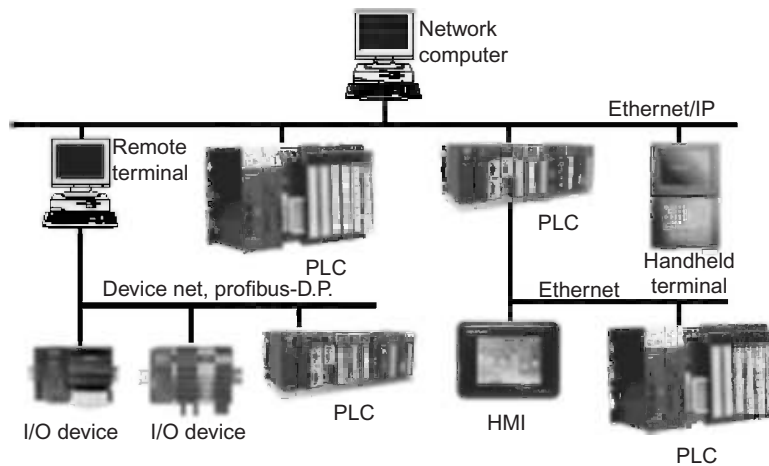


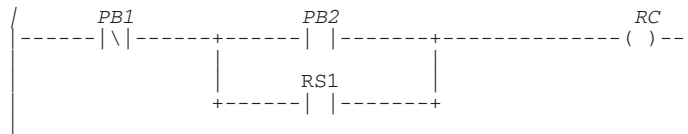
Figure 19.22 Network of PLC and I/O devices.

## 6.6 Programming Device

Programming devices can range from keypads built into the PLC itself, to hand-held programming terminals, and computers running specialized software. The benefits of keypads and hand-held terminals are that they are portable and rugged enough to make changes right in the plant where the PLC may be installed. The benefit of programming with a computer and software is that a copy of the program can be stored outside of the PLC for offline modification or upgrading, emergency backup, or simply documentation purposes. With the help of communications modules, most PLC can communicate over a network (Figure 19.22) to computers for both programming and monitoring.

**Table 19.3** Simplest Ladder Logic Programming Instructions Used for Discrete Control on PLC

Instruction	I/O	Symbol	Meaning
XIO—eXamine If Open	Input	-] [-	True if the bit is set to 1. False if the bit is set to 0.
XIC—eXamine If Closed	Input	-] \ [-	True if the bit is set to 0. False if the bit is set to 1.
OTE—OuTput Enable	Output	-( )-	Sets the designated output bit to 1 if the logical combination of input conditions is TRUE, otherwise it sets the designated output bit to 0.
OTL—OuTput Latch	Output	-(L)-	Sets the designated output bit to 1 if the logical combination of input conditions is TRUE.
OUT—OuTput Unlatch	Output	-(U)-	Sets the designated output bit to 0 if the logical combination of input conditions is TRUE.

**Figure 19.23** Logic for a motor control panel programmed in ladder logic.

## 6.7 Controller Programming

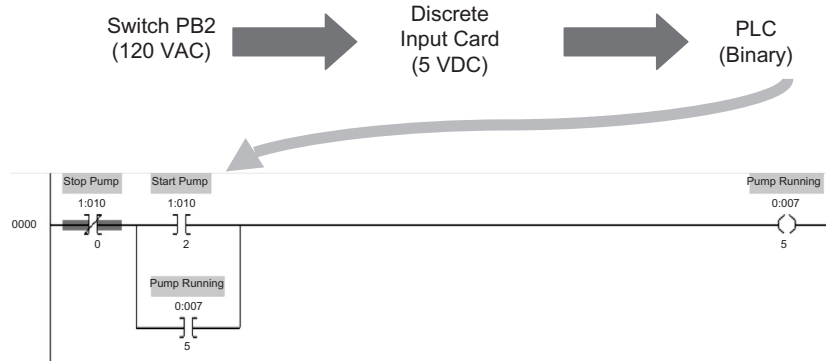
Most control systems on the market today are microprocessor-based and require programming by the user before they can be used to automate a process. Small process control systems simply require that the user select configuration parameters from a predefined list. Other more complex systems like PLC require programming using sophisticated software. A programmed set of instructions forms the algorithm that determines the actions to be accomplished automatically by the system. The program specifies what the automated system will do and how the various process signals must be acted on to accomplish the desired result.

The simplest ladder logic programming instructions used for discrete control on PLC are listed in [Table 19.3](#).

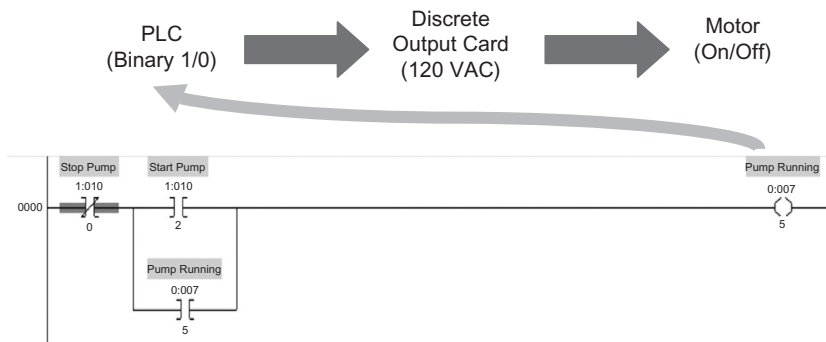
Logic for a motor control panel can be programmed in ladder logic ([Figure 19.23](#)).

Each physical device in the factory is wired to a termination point on the PLC. Each termination point on the PLC has a corresponding physical location in the program. Note the switch inputs and relay outputs used in the following examples:

- PB1 is a NC momentary push button switch labeled STOP. It is wired to a discrete input card in slot 010 terminal number 0. The address of PB1 is thus: I:010/0.
- PB2 is a NO momentary push button switch labeled START. It is wired to a discrete input card in slot 010 terminal number 2. The address of PB2 is thus: I:010/2.



**Figure 19.24** Diagram showing how real devices, like a push button switch are linked to software-programmed ladder logic.



**Figure 19.25** Diagram showing how real output devices such as motors are linked to software-programmed ladder logic.

- RC is a relay coil in a motor control panel. It is wired to a discrete output card in slot 7 terminal number 5. The address of RC is thus: O: 007/5.
- RS1 is a NO set of contacts on the relay RC. When the relay is activated, these contacts will close.

When the operator presses PB2 (Figure 19.24), the electronics inside the discrete input card places 5 VDC on the backplane of the PLC rack that corresponds to the address of that switch input. The software program running in the PLC then sets the corresponding *bit* to 1 to indicate that the physical switch is closed.

The PLC is operating program logic that determines the appropriate state of the output and sets the memory address *bit* associated with the output to either a 0 or 1 accordingly. The electronics inside the PLC places 0 VDC or 5 VDC on the backplane of the PLC rack that corresponds to the address of that output. The discrete output card, upon sensing the DC voltage, switches 120 VAC (Figure 19.25) to the motor control relay if the output is TRUE.

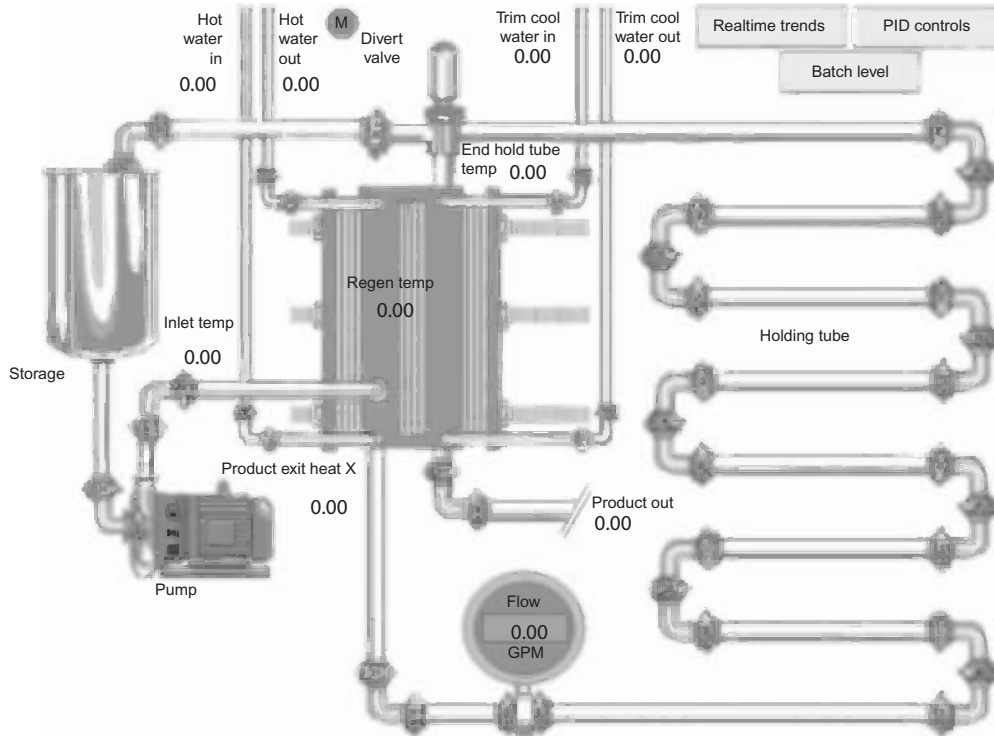
One of the advantages of using a computer to program logical control should be apparent. When using a computer program, it is not necessary to have a physical set of contacts for RS1. Rather, the program can inspect the status of any output just as easily as it can an input. Note in the above program, the reference to O:007/5 using an input (XIC) instruction. If this control logic were hardwired, that input would need to examine a set of relay contacts. Using software, it does not! This capability not only saves wiring costs but relay hardware as well.

The above example explains in detail how a discrete control example is programmed into ladder logic software in a PLC. As most rack-type, modular PLC used today can also perform continuous control, ladder logic instructions have been created to perform analog control tasks. For example, block instructions in a PLC ladder program may include an analog block read to input values from analog sensors, PID control blocks to perform PID loop calculations, and an analog block write to output a signal to control a valve whenever the rungs containing these block instructions are executed.

## 6.8 HMI—Human-Machine-Interface

As most controllers need human input or monitoring, normally a human-machine-interface (HMI) is required. The HMI includes any equipment used to allow automated systems to interface with human operators. The HMI can be as simple as indicator lamps and pushbuttons on a panel or as complex as a group of graphic display windows presented on a computer monitor. Indicator lamps and pushbuttons are most commonly used for material handling operations. Indicator lamps are lit, for example, when conveyors or motors are running and are extinguished when they are stopped. Pushbuttons are used to start and stop these devices. For unit operations, it is common practice to use a computer monitor to display a color cartoon of the process with important process variables depicted as text, bar graphs, or line graphs. Colors are often used to differentiate various components of the process or to communicate the process status. An example of a computer-displayed HMI for a pasteurization process is shown in [Figure 19.26](#).

Safety monitoring is a special case of automation in which the control system is programmed to detect and correct for a safety hazard. Decisions are required when sensors detect that a critical condition has developed that would be hazardous to the food material, equipment, or humans in the vicinity. The purpose of the safety-monitoring system is to detect the hazard and to take the most appropriate action to remove or reduce it. This may involve stopping the operation and alerting maintenance personnel to the condition, or it may involve a more complex set of actions to eliminate the safety problem. The divert valve logic examined earlier in this chapter is one example of safety monitoring.



**Figure 19.26** An example of a computer-displayed human-machine-interface (HMI) for a pasteurization process.

It is critical that proper operation of automation and safety monitoring of food manufacturing systems require flawless execution of the control system. The probability for errors and malfunctions occurring increases exponentially with program complexity. This has prompted the regulatory agencies, such as the Food and Drug Administration (FDA) and United States Department of Agriculture (USDA), to consider the need for control system validation as part of process validation for those food processes that are regulated by US federal law. Control system validation is a set of well-defined methods that, when followed, provide assurance that the control system behaves in the manner intended. Control system validation is necessary to assure that all programming is free of syntactical or logical errors that would result in either a safety hazard or a reduction in productivity.

A natural advantage to computer-controlled processes is that process data can be stored electronically for future analysis and documentation. To preserve the integrity of electronically stored data, the FDA has promulgated regulations (21CFR11) that govern how computer generated data is to be handled when used to document FDA regulated processes. Some of the systems covered by 21CFR11 include computer

generated event logs for retort and aseptically processed foods, computer generated Hazard Analysis and Critical Control Point (HACCP) records, and computer generated container seam inspection systems for low-acid canned foods.

## 7. SENSOR FUNDAMENTALS

The role of sensors is to provide accurate and repeatable measurements of process variables for indicating, monitoring, recording, and/or controlling specific processes in a production environment. The objective of this section is to describe basic concepts that apply to all sensors, such as accuracy and precision. Also discussed are sensors that are commonly used to measure position, temperature, pressure, level and flow in food process operations.

Electronic sensors are designed such that some given property of the process, such as temperature, pressure, flow, etc. is ultimately converted into one or more fundamental electrical properties, such as voltage, resistance, capacitance, etc. (Figure 19.27). This conversion is an example of “transduction”, which is defined as the transfer of information from one signal-carrying medium to another. The exchange of such information fundamentally involves a transfer of mass, energy, or momentum from the process to the sensor that results in a change of the sensor’s electrical properties.

Not all sensors are created equal. For any one given sensor technology, there may be thousands of variations in shape, size, range, accuracy, precision, and sensitivity to accommodate the wide variety of manufacturing environments in industry today. Further, all sensors have limitations with regards to how well they can represent the process variable. There are many different ways to design a technology that senses product flow, for example. However, only those technologies that are most commonly found in the food-manufacturing sector are presented here.

This first part of the section describes the terminology used to characterize sensor limitations with respect to their performance. This is followed by a description of the most common technologies used to measure the fundamental process properties: position, temperature, pressure, flow, and level.

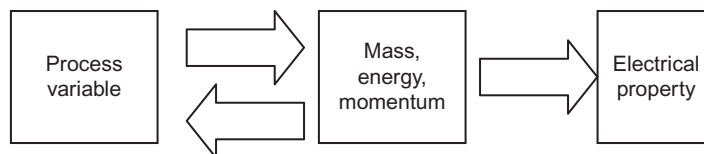


Figure 19.27 *Transduction: process variables are converted into electrical properties.*

## 7.1 Range and Resolution

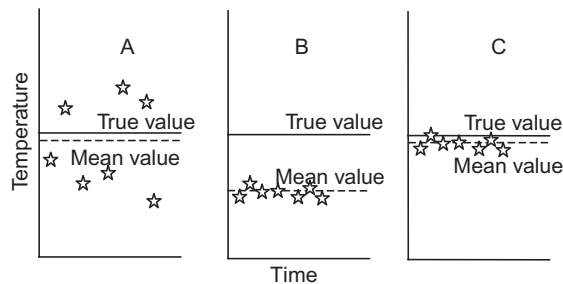
Range describes the maximum and minimum values over which an instrument is designed to operate. Resolution is defined as the minimum change in process variable that can be detected by an instrument. This has important consequences for process control because an automation system cannot regulate a process variable more accurately than the resolution of the sensor.

## 7.2 Accuracy and Precision

A sensor must provide a unique relationship between a process variable and electrical property such that subsequent measurements of the electrical property suitably correlates to a corresponding value of the process variable. Accuracy is a term used to describe how well the mean value of a series of measurements matches the true value of the process variable. Precision and repeatability are interchangeable terms used to describe the statistical variance of a series of measurements about its mean value. The distinction between these two properties of measurement, under conditions where the process variable is held constant, is shown in Figure 19.28.

The solid curve is an indication of the actual or true value of fluid temperature as a function of time. Figure 19.28(a) shows the measurement given by an imprecise but accurate instrument. Figure 19.28(b) illustrates a precise but inaccurate instrument. Figure 19.28(c) shows both an accurate and precise instrument.

Accuracy can be defined in many ways. The most common are relative-to-reading (RR) and relative-to-full-scale (RFS). Sensors that define accuracy by RR will be more accurate over some ranges and less accurate over other ranges. This is typical, for example, in many (but not all) flow meters whose accuracy tends to degrade at low flow rates. Sensors that define accuracy by RFS exhibit the same accuracy over their entire operating range. This is true, for example, for most temperature sensors. However, the accuracy of some sensors cannot be expressed as a function of their reading or their range. These sensors are usually supplied from the manufacturer with



**Figure 19.28** The distinction between accuracy and precision under conditions where the process variable is held constant.



tables or charts that indicate the device's accuracy at selected points over its operating range. Often the manufacturer will also specify a maximum error that can be expected over the operating range.

“Static” accuracy is the term used when the process variable is constant, as described above. “Dynamic” accuracy is the term used to describe how well the mean value of a series of measurements follows the true process variable when the true value is changing.

Dynamic accuracy is defined by the time-constant of the sensor and is dependent not only on sensor construction but also by factors that influence the rate of mass, energy, or momentum transfer between the sensor and the process environment.

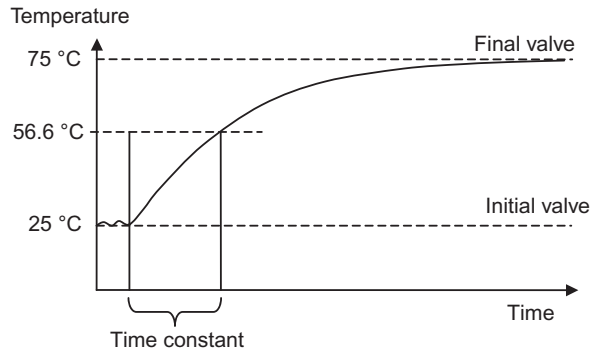
### 7.3 Sensor Dynamics

No sensor can respond instantaneously to a change in process variable. All sensors have some finite response time. This characteristic is important to consider because the response time of an automation system cannot be less than the response time of the sensors employed.

As an example of sensor dynamics, consider a bare bulb-type glass thermometer at ambient temperature suddenly immersed into a process stream at a higher temperature. The liquid within the thermometer will not expand instantaneously. Rather, the energy of the process will transfer to the glass bulb according to some convective heat transfer rate. This energy then transfers through the glass according to the conductive heat transfer properties of the glass. Finally, the energy then transfers into the thermometer fluid according to some other convective heat transfer rate whereupon the thermometer fluid expands as it heats. Because the difference in temperature between the process stream and the thermometer is the driving force that governs the flow of energy, the greatest energy flow occurs at the time that the thermometer is initially immersed in the process. The result is that the temperature of the thermometer fluid changes rapidly at first and then slows down as its temperature approaches that of the process.

Because the change in temperature difference is proportional to the actual temperature difference, the response can be characterized as an exponential function of time, that is, the difference between the process temperature and that of the thermometer fluid decreases exponentially over time. The resulting response is characterized by a “time-constant” and is defined as the time required for the difference in temperature to diminish by one natural log cycle. When the response is put in terms of percentage change, the time-constant is the time necessary for the response to reach 63.2% of its total change in value. A typical response curve for a temperature sensor with a time-constant is shown in [Figure 19.29](#).

When used in closed loop feedback control, the time-constant imposed by sensors adds lag (or time delay) to the overall loop response time. Thus, it is always desirable



**Figure 19.29** A typical response curve for a temperature sensor with a time-constant.

to minimize the time-constants of sensors and other loop components. Sensors with a small time-constant make it possible for the controller to provide better closed loop performance. Sensors with large time-constants will degrade the overall operation of the feedback loop. Large and small are relative terms here. A rule of thumb is that the time-constant of the sensors should be about 5–10 times smaller than the time-constant for the process itself. Therefore, a thermal process in which it takes the temperature 10 min to change from one steady-state to another should use temperature sensors with time-constants around 1 min or less.

## 7.4 Rangeability and Turndown

Rangeability casts the valid operating range of an instrument to a percentage of its maximum value. For example, a flow meter with a rangeability of 5–100% and designed for a maximum flow rate of 1,000 gallons per minute (gpm) would be able to measure flow rates as low as 50 gpm. Turndown of an instrument is defined as the ratio of the maximum of its operating range to the minimum of its operating range. For the flow meter above, the turndown would be 200 to 1.

## 7.5 Sensitivity/Gain

Sensitivity and gain are interchangeable terms defined as the ratio of the change in output signal to the change in process variable. The greater the change in output for a given input change, the greater the sensitivity.

## 7.6 Linearity

Linearity is a measure of how constant an instrument's sensitivity is over its operating range. In a linear instrument the ratio of change in electrical output over change in process input is constant for the entire range of the instrument. From a visual perspective, linearity defines how well a line fits a graph of process variables plotted on the

abscissa versus electrical output plotted on the ordinate. Linearity has important consequences for accuracy and process control. Assuming linear behavior for a non-linear instrument is analogous to trying to fit a curve with a straight line. The fitted line may be accurate at some portions of the curve but not over the entire range.

## 7.7 Maintenance

Components wear over time, affecting their individual accuracy, precision, sensitivity, and reliability. As a result, sensors require regular periodic calibration and maintenance.

## 7.8 Specification of Sensors

Some of the considerations necessary when specifying sensors include:

1. What is the range of the process variable?  
 Generally, the larger the range of a sensor, the lower its resolution and precision. Sensors should be selected to cover the expected operating range of the process  $\pm 10\%$
2. What accuracy, precision, and sensitivity are necessary?  
 The cost of sensors increases with required accuracy, precision, and sensitivity. Therefore, sensors should be selected whose specifications slightly exceed the performance objectives of the control system.
3. Is the sensor linear over the normal operating range?  
 Linear sensors should be used whenever possible. If it is not possible to use a linear sensor, then sensors of which the non-linearity can be characterized should be used. Modern computer technology is capable of using this characterization to linearize otherwise non-linear sensors for more accurate control.
4. What response time is required?  
 Equipment sizes, utilities, and production constraints will dictate the required response time for a given process. Those sensors should be chosen that provide a response time at least ten times faster than for the process itself.
5. What reliability is required?  
 Generally, it is important to select sensors that are robust to harsh manufacturing conditions and perform reliably over extended periods of time. Sensor failures will result in expensive shut-down operations. Some transducers have multiple (backup) sensing elements to avoid shut-downs as a result of failure of the sensor.
6. What are the hardware, installation, and operating costs involved?  
 Sophisticated sensors, for example, on-line spectrometers and vision systems, are expensive to purchase, require special resources for installation, and require trained personnel to operated and maintain. The benefit for using such technology must outweigh the costs involved in its operation.

## 7. What are the sanitary and safety requirements?

Sensors in direct contact with food must not compromise process sanitary requirements or food safety. For example, glass pH probes are not permitted to be directly in food processing streams owing to the potential for breakage and subsequent hazardous contamination of the food product with glass fragments. Sensors should meet 3A ([www.3A.org](http://www.3A.org)) or EHEDG (European Hygienic Engineering Design Group, [www.EHEDG.org](http://www.EHEDG.org)) specifications. Otherwise they could potentially introduce a source for incipient contamination of the food-processing stream. Typically, stainless steel sensor bodies are common for food industry applications.

## 7.9 Common Sensor Technologies

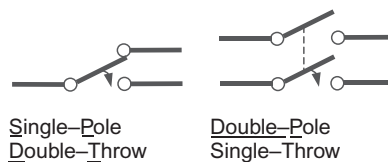
### 7.9.1 Switch Inputs

The simplest input devices are discrete, two-position switch inputs. Switches are commonly used in automation systems to indicate the presence or absence of a certain condition. The structure of a switch is designated by poles and throws. These archaic names are taken from a time in history when a switch consisted of a moveable lever and a stationary contact. The switch pole is analogous to the moveable lever. The switch throw is analogous to the stationary contact.

A single-pole switch has one movable lever and a double-pole switch has two movable levers (that move in unison), etc. The purpose for the multiple-pole feature is that it allows a single switch to control multiple circuits simultaneously.

A single-throw switch has only one position in which the pole connects with a stationary contact, that is, closes a circuit. In a double-throw switch, the pole can connect with one of two stationary contacts. In a triple-throw switch, the pole can connect with one of three stationary contacts, etc. The purpose for multiple throws is to allow switches to take on more than two discrete states.

Switches are often designated using acronyms that describe the combination of the number of poles and number of throws used. For example, the switch designations: single-pole-double-throw and double-pole-single-throw are depicted by the corresponding acronyms: SPDT and DPST, respectively. [Figure 19.30](#) represents SPDT and DPST switches.



**Figure 19.30** SPDT and DPST switches.

Momentary contact switches, for example, limit switches and push-button switches, are a special class of switch that has a normal, un-actuated state. The switch automatically returns to the normal state when the stimulus that actuated the switch is removed. The designation “normally open” and “normally closed” are used to identify the normal, un-actuated position of the switch. If the switch must be actuated to close the circuit, it is designated as normally open (NO). If, on the other hand, it must be actuated to open the circuit, it is designated as normally closed (NC). Mechanical momentary switches have built-in spring mechanisms that retract the switch to some nominal position when not externally actuated.

### 7.9.2 Position

Sensing position has wide application in all manufacturing environments. Applications include sensing the position of a manufactured product along a conveyor belt, the position of boxes in a packaging line, and as part of more complex sensors such as the position of a bourdon tube inside a pressure gauge. Position sensors are available as discrete or analog devices. Some of the common position-sensing technologies are listed in [Table 19.4](#).

### 7.9.3 Toggle Switch

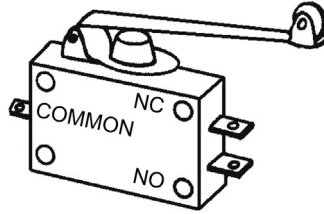
A mechanical toggle switch is the oldest technology for sensing position. These switches are simple discrete devices that change state when they come in contact with the process. For example, these switches are often used to:

- Detect individual presence or absence of objects along single-width conveyors.
- Detect when moving equipment (e.g. a divert valve or door) is in the correct position.
- Convert process variables that are typically considered analog measurements to discrete measurements.

For example, a flow switch can be constructed using a paddle connected to a toggle switch. When immersed in a flowing stream, the paddle actuates the toggle switch

**Table 19.4** Common Position-Sensing Technologies

Device	Technology	Analog/discrete
Toggle switch	Mechanical switch (voltage)	Discrete
Proximity switch	Electromagnetic induction (current)	Discrete
Photo-cell	Optical (current)	Analog/discrete
Encoder/programmable limit switch	Digital microprocessor	Analog/discrete
LVDT	Inductance (current)	Analog
Radar	Electromagnetic timing	Analog
Ultrasonic	Acoustic timing	Analog



**Figure 19.31** *Limit switch.*

at some preset flow rate. In a similar fashion, a temperature switch can be made from a bi-metallic strip attached to a toggle switch. The bi-metallic strip actuates the toggle switch at some preset point as the strip expands and contracts with temperature.

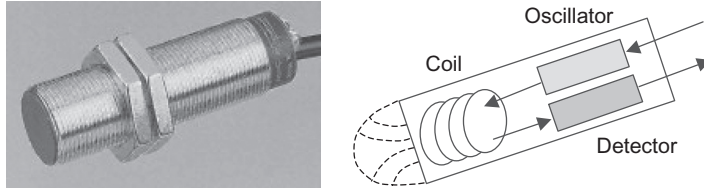
Often, arms or rollers are attached to the switch mechanism to enable the switch to actuate on contact with another object under a designed set of conditions. Mechanical devices, such as toggle switches, have limited life owing to the fact that the moving parts they contain wear with use over time. Most switches used in automation are momentary, double-throw, contact switches. They may be single or multiple pole.

An example of a limit switch is shown in [Figure 19.31](#). When an object moves the switch lever, the contacts switch, so the NC contacts open and the NO contacts close.

### **7.9.4 Proximity Switch**

A proximity switch is designed to change state when it comes within a specified range of the object to be sensed. The unique feature of a proximity switch is that the switch does not require physical contact with the object. A common type of proximity switch works on the principle of inductance. The switch has a small coil embedded just under its surface, which is driven by an oscillator generating a fluctuating magnetic field. When a conductive object passes into the field, energy is extracted from the field as a result of eddy currents in the metal. This energy loss changes the inductance of the coil and the oscillator's field strength. The sensor's detection circuit monitors the oscillator's strength and triggers an output when the oscillator becomes reduced to a sufficient level ([Figure 19.32](#)).

In another type of proximity switch, an encased, magnetically sensitive switch closes when in range of a small magnet attached to the target object. Induction switches are popular because they have little if any moving parts and tend to have long life. One disadvantage is that they actuate only in the presence of a metallic object. However, capacitive proximity switches can be used to also detect non-metallic objects. Proximity switches are used in many of the same applications as toggle switches but where direct contact with an external object is impossible or not



**Figure 19.32** Proximity switches.

necessary. They are most often found as momentary, double-throw, and may be single or multiple pole.

### 7.9.5 Photocell

A photocell is a non-contact device that uses a light source and light sensitive detector (photo-eye) placed some distance from each other. Partial or total interruption of the light path generated by the light source can be detected by measuring the voltage or current output from the photo-eye. Thus, photocells can be used as discrete or analog devices, depending on the application. Photocells are commonly used to:

- Detect the individual presence or absence of objects passing between two widely separated points.
- Align equipment separated over a wide distance.
- As part of other sensors.

For example, one manufacturer has embedded a photocell within a pressure gauge. As the bourdon tube within the gauge expands and contracts with pressure, the tube slides and retracts a vane in front of a photo-eye, blocking an amount of light proportional to the tube's position. The output of the photo-eye is an electrical signal that is proportional to the pressure. Another example is a manufacturer that uses a photocell to measure process fluid turbidity. The light source and photo-eye are mounted directly across a pipe from each other. The turbidity of the process stream flowing through the pipe is a function of the amount of light received by the photo-eye from the light source across the pipe. The output of a discrete photocell is usually made to mimic the action of a momentary, double-throw switch that may be single or multiple pole.

### 7.9.6 Encoder/Programmable Limit Switch

An encoder is an analog device that provides a precise digital representation of position measurement. Encoders are normally associated with rotary equipment such as that found in packaging machines and other material handling devices. Rotary encoders provide a precise angular position measurement of a rotating shaft. Rotary encoders that can be programmed to actuate a switch output at precise angular positions are called programmable limit switches. Other options commonly found on rotary

encoders include change in position over time (angular velocity) and change in velocity over time (angular acceleration).

### **7.9.7 LVDT**

An LVDT (Linear Variable Differential Transformer) is an analog device that provides precise linear position measurements. When the measurement is provided in digital form, the result is a linear encoder. An LVDT is made from a coil of fine wire. Within the coil of wire is a conductive material, such as a metal bar, that is allowed to move freely in one direction along the center axis of the coil. The impedance in the coil is directly proportional to the position of the bar within the coil. The position of the central bar can be determined directly by measuring the coil impedance. Impedance is the resistance to change in current. An AC signal is used to provide a constantly changing current. When the corresponding voltage across the coil is measured, it is found that the oscillating voltage cycle lags behind the oscillating current cycle. The amount of this time lag is called the phase shift and is proportional to the coil inductance. Thus, the position of the metal bar within the coil can be determined by measuring the inductance change created by the presence of the metal bar.

### **7.9.8 RADAR**

RADAR is an acronym for Radio Detection And Ranging. Radar position detectors operate in a similar fashion to those devices used by law enforcement officials to monitor the speed of automobiles. The principle is that the round trip time for a pulsed radio wave to be transmitted and then reflected from a target back to its source, is proportional to the distance between the source and the target. Low power RADAR applications include level measurement applications of bulk slurries, solid powders, or particulates, and even foaming liquids.

### **7.9.9 Ultrasonic**

Ultrasonic position detectors operate using a similar principle to radar detectors except that high frequency sound waves are used instead of electromagnetic radio waves. Ultrasonic position detection is used primarily for close range applications owing to the attenuation of ultrasonic sound with certain materials and over long distances. The principle used is that the round trip time for a sound wave to be reflected from a target back to its source is proportional to the distance between the source and the target. Ultrasonic position applications include level measurement applications of some bulk slurries and solids.

### **7.9.10 Temperature**

The science of temperature measurement, or pyrometry, is one of the oldest technologies in the process industries. Temperature is certainly one of the most common



**Table 19.5** Commonly Used Technologies to sense temperature

Device	Technology	Output	Analog/discrete
Bimetallic Strip	Thermal Expansion	Mechanical	Discrete
Thermocouple (TC)	Thermo-electric effect (Seeback Effect)	Voltage (mV)	Analog
Resistance Temperature Device (RTD)	Thermal Expansion	Resistance	Analog
Thermistor	Thermal Resistor	Resistance	Analog
Integrated circuits	Digital	Voltage/ Current voltage/	Analog
Infrared	Electromagnetic	Current	Analog

process variables measured in the food industry. The most commonly used technologies to sense temperature are shown in [Table 19.5](#).

Temperature is a measure of the mean kinetic energy in a material. Common units for temperature include Kelvin (K), Celsius ( $^{\circ}\text{C}$ ), Fahrenheit ( $^{\circ}\text{F}$ ), and Rankin (R).

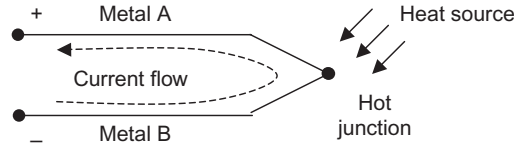
### 7.9.11 Bi-Metallic Strip

The bi-metallic strip is one of the oldest mechanical methods used to sense temperature for use in automation systems. It is still commonly found in inexpensive household thermostats. The bi-metallic strip is a small, long rectangular sandwich composed of two metals with different thermal expansion coefficients. As the environmental temperature changes, each metal in the strip expands or contracts at a different rate, causing the strip to coil inward or outward. A momentary switch connected to the strip provides a discrete signal when the temperature exceeds a given threshold. Most temperature switches that contain bi-metallic strips have a facility to manually adjust the temperature threshold at which the switch actuates. Another name for bi-metallic temperature switches are snap-action switches.

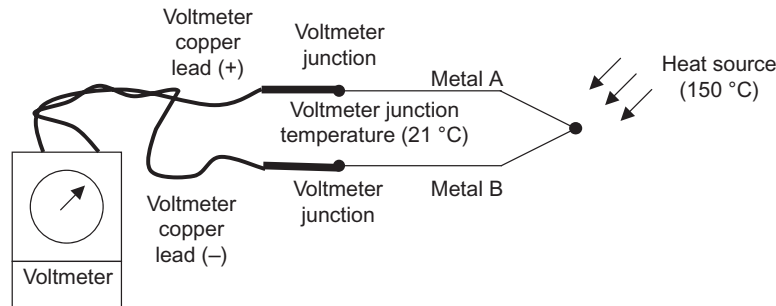
### 7.9.12 Thermocouples

In 1821, Thomas Seeback discovered that when two wires of dissimilar metals are joined and the junction is heated, an electric potential (thermoelectric voltage) forms that is proportional to the increase in junction temperature ([Figure 19.33](#)). All dissimilar metals exhibit this effect. However, the function that relates temperature to voltage is different for different metals.

The thermoelectric voltage cannot be measured directly using a voltmeter because in connecting a voltmeter to the thermocouple, another new thermoelectric circuit is



**Figure 19.33** Thermoelectric voltage produced by heating the junction of two dissimilar metals.



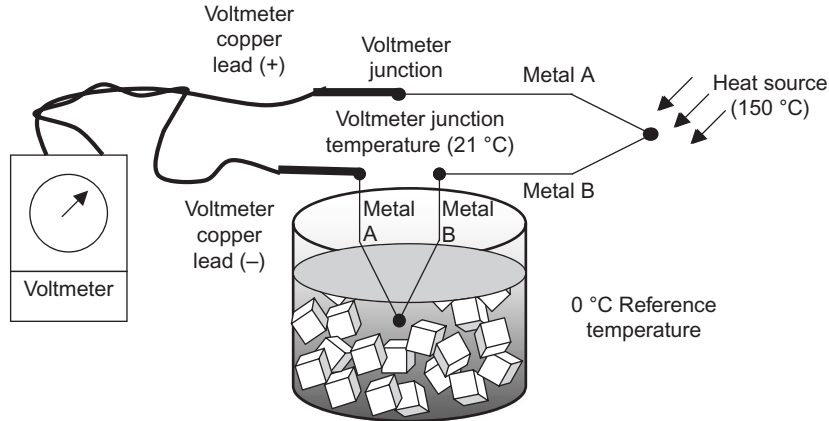
**Figure 19.34** Thermocouple connected to voltmeter; the voltmeter junction also creates thermoelectric voltage depending on temperature.

created at the voltmeter junction point (Figure 19.34). This new junction will create its own thermoelectric voltage depending on the temperature at the junction. The resulting voltage will be the difference between the heated junction and the voltmeter junction. Thus, measurements made at different ambient temperatures will give different results.

One way to solve this problem is to place the junction connection, of the voltmeter with the thermocouple, into an ice bath (Figure 19.35).

By adding the voltage of the ice point reference junction, the primary thermocouple reading has been referenced to  $0^{\circ}\text{C}$ . Electronic compensation circuits are now used that eliminate the need for an actual ice bath. These methods use another technology to measure the voltmeter junction temperature and electronically adjust the measured volts to compensate accordingly.

The voltage created by thermocouples is extremely small and is in the order of millivolts. Consequently, such small voltage signals are subject to electrical disturbances and signal degradation. It is important to use shielded cable for transporting thermocouple signals in a manufacturing environment and to keep the signal path to the data measurement device as short as possible. Over small temperature changes, the millivolt signal generated by thermocouples is linear with respect to temperature. The degree of linearity, or lack thereof, is highly dependent on the type of thermocouple wire used. For most thermocouples, the signal starts to become non-linear over ranges  $>100^{\circ}\text{C}$ .



**Figure 19.35** Thermocouple and voltmeter with ice bath using the ice point as reference.

Thus, it is imperative to use suitable signal conditioning equipment that incorporates the proper linearization for the type of thermocouple used.

### 7.9.13 Resistance Temperature Device (RTD)

The same year that Seebeck made his discovery about the thermoelectric effect, Sir Humphrey Davy found that the conductivity of metals was related to their temperature. In 1871, Sir William Siemens suggested using platinum as the component for a thermometer based on electrical resistance. Platinum is still the metal of choice in all high-accuracy resistance thermometers. In 1932, C. H. Meyers proposed the now classical design for RTD construction. He wound a helical coil of platinum on a crossed mica web and mounted the assembly inside a glass tube. In modern RTD construction, a platinum or platinum-glass slurry film is deposited onto a small flat ceramic substrate, etched with a laser-trimming system and sealed. This “metal film” RTD can be readily manufactured at high speeds. The small size of the RTD element enables the finished RTD to respond quickly to temperature changes.

The principle behind the metal RTDs is that as the metal expands with temperature, the electrical current path increases and accordingly the resistance as well. One disadvantage to metal film RTD elements is that they can be subject to thermal shock damage. This is because of the difference in expansion coefficient between the platinum and the substrate. On rapid heating or cooling, the film and substrate expand or contract at different rates and cause stress cracks in the element leading to failure. However, recent advances in modern materials engineering has led to the use of materials that are more robust to temperature stress and subsequently less stress induced failures.

RTDs that use long lead runs are subject to errors induced by wire resistance. Both three-wire and four-wire RTD configurations are available to reduce errors caused by lead wires. These additional leads allow the measurement system to measure the lead resistance as well as the sensor resistance and compensate accordingly.

Unlike thermocouples, the RTD is not self-powered. To determine the resistance of the RTD, a small but constant electrical current is placed on the lead wires and the resulting voltage drop is used to calculate the resistance. According to Joule's law, this current, no matter how small, causes the RTD to dissipate heat, potentially changing the temperature of the microenvironment at the RTD element. This self-heating effect can lead to measurement errors depending on the thermal medium, the current applied, and the style of RTD.

The linearity of RTDs depends on how constant the coefficient of thermal expansion is for the base metal at different temperatures. The thermal expansion of platinum, and consequently its change in thermal resistance with temperature, is nearly constant.

RTDs are designated by their nominal resistance at  $0^{\circ}\text{C}$ . Thus, a  $100\ \Omega$  RTD is one that measures  $100\ \Omega$  when immersed in a medium that has a temperature of  $0^{\circ}\text{C}$ . The thermal constant of RTDs is given by the constant  $\alpha$  (resistivity) and is defined as the change in resistance per  $^{\circ}\text{C}$ . For platinum RTDs, for example, a resistivity of 0.00392 means that the resistance increases by  $0.00392\ \Omega$  for every  $^{\circ}\text{C}$  increase in temperature.

#### **7.9.14 Thermistor**

Thermistors are primarily composed of semiconductor materials whose resistance decreases as their temperature increases (negative temperature coefficient), although some thermistors exhibit a positive temperature coefficient. Thus, as with the RTD, the thermistor is a temperature sensitive resistor. The resistance of a thermistor as a non-linear function of temperature and special signal processing techniques are required to improve the linearity of the device. Thermistors typically operate over a narrower range than thermocouples or RTDs. Thermistors are often found in instruments that require an inexpensive measurement of ambient temperature.

#### **7.9.15 Integrated Circuits**

A recent innovation in pyrometry is the development of an integrated circuit temperature transducer. These devices can supply either an output voltage or current that is linearly proportional to absolute temperature. However, these devices are subject to self-heating, are fragile, and operate under a limited range of temperatures. They are commonly used in electronic zero reference circuits for thermocouples.

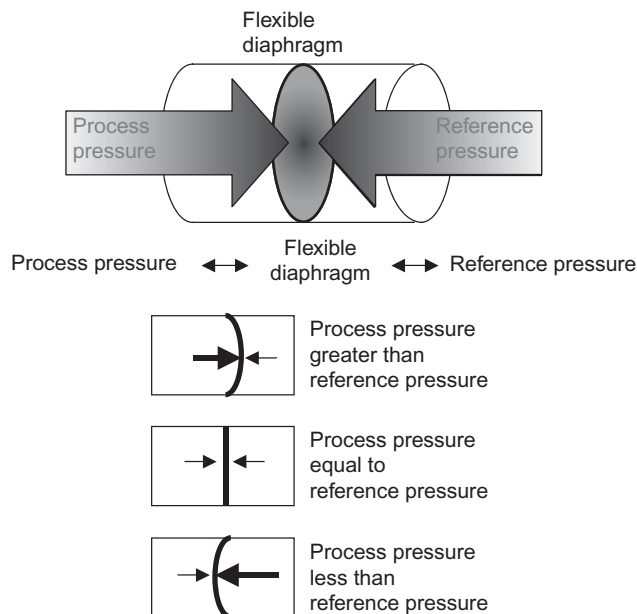
### 7.9.16 Infrared Radiation

Heat is transmitted as electromagnetic radiation in the infrared spectrum. All objects emit such radiation and sensors are available that can detect such radiation and estimate the temperature of the source. Often, such devices use infrared detection to estimate the surface temperatures without the need for direct contact. The amount of infrared radiation emitted at each temperature is affected by the emissivity of the material. The precision of these devices is limited and they are subject to thermal noise from the surrounding environment.

### 7.9.17 Pressure

Pressure is defined as force per unit area; some common units are pounds per square inch gauge (psig), pounds per square inch absolute (psia), inches of water, inches of mercury, atmospheres, bars, and torrs.

Almost all pressure measurement technologies use a diaphragm that flexes as a result of differential pressure across the diaphragm. The degree to which the diaphragm flexes or distends is a function of the process pressure relative to the reference pressure on the other side of the diaphragm (Figure 19.36). In this sense, all pressure measurements that use a diaphragm are differential pressure measurements. It is the



**Figure 19.36** Almost all pressure measurement technologies use a diaphragm that flexes as a result of differential pressure across the diaphragm.

reference pressure that differentiates the various types of pressure measurements. Pressure is always measured against one of three common references.

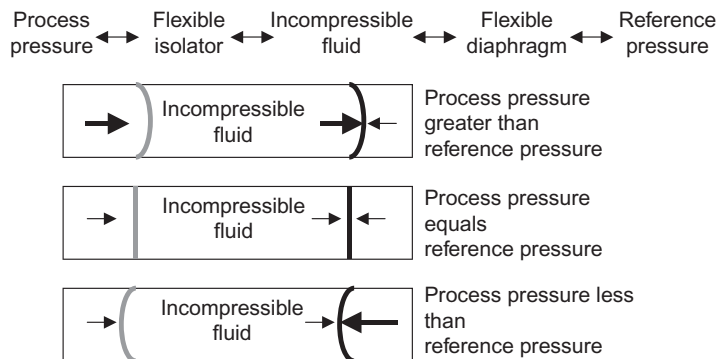
1. If the reference is a vacuum, the measured pressure is called absolute pressure.
2. If the reference is local ambient or atmospheric pressure, the measured pressure is called gauge pressure.
3. If the reference is supplied from another point in the process, the measured pressure is called differential pressure.

Pressure sensors used for direct contact with food usually require the use of remote seals that isolate the food material in the process from contaminating the diaphragm and associated electronics. Flow-through isolators consist of a thin, cylindrical corrugated stainless steel tube laser welded inside a machined pipe section. The void between the two concentric pieces and the capillary to the pressure diaphragm and electronics are filled with a food grade incompressible liquid (Figure 19.37). The thin-wall isolators are designed so that there are no dead ends or dead volume in the fluid's path.

The technologies discussed below are differentiated by how the distention of the diaphragm is measured.

#### 7.9.17.1 Resistive

Pressure transducers generally contain a pressure sensitive diaphragm with a bonded strain gauge. As the diaphragm flexes in response to a pressure differential, stress is placed on the strain gauge element. Strain gauge elements are either piezo-resistive or thin metal foil. When these elements stretch, they expand and their resistance increases. A typical sensing element of a pressure transmitter comprises four nearly identical piezo-resistors buried in the surface of a thin circular silicon diaphragm. Any



**Figure 19.37** Pressure sensors used for direct contact with food usually require the use of remote seals that isolate the food material in the process from contaminating the diaphragm and associated electronics.

pressure causes the thin diaphragm to bend, inducing a stress or strain in the diaphragm and also in the buried resistor. The resistor values will change depending on the amount of strain they undergo, which in turn depends on the amount of pressure applied to the diaphragm. These four strain gages are connected into a Wheatstone bridge circuit to yield an electrical signal proportional to the strain. Hence, a change in pressure (mechanical input) is converted to a change in resistance (electrical output). The sensing element converts (transduces) energy from one form to another. The transmitter's housing contains the strain gage sensor as well as a signal conditioner, a signal port, and an electrical connector.

#### 7.9.17.2 Capacitance

Placing a dielectric material between two conductive plates forms a capacitor. This property can be used to sense pressure. When a flexible diaphragm is placed between two electrode plates, and the diaphragm and plates flex in response to pressure across the diaphragm, the capacitance between the plates changes.

#### 7.9.17.3 Thin Film

This is a strain gage formed by vapor deposition of a metal onto an oxide-coated diaphragm. In newer technologies, the diaphragm is made from ceramic materials.

#### 7.9.17.4 LVDT

An LVDT in contact with a pressure sensor diaphragm translates the diaphragm motion to linear motion and is able to detect small displacements of the diaphragm as it flexes under pressure. The linear motion is then expressed as a function of process pressure.

#### 7.9.17.5 Fiber Optic

An optical fiber is used to transmit light to and from the diaphragm. As the diaphragm flexes, the properties of the reflected light change and can be correlated to diaphragm distention and process pressure.

### **7.9.18 Level**

Level measurement plays an extremely important role in food process automation. In the food industry, level measurements are used to determine bulk quantities of stored solids or liquids. Level measurement may be divided into two categories, point level measurement and analog level measurement. Point level sensors are discrete devices used to indicate the presence or absence of a liquid or solid at some point, usually within a storage tank. Generally, discrete level sensors are used as a high or low point alarm, to alert the existence of over or under-fill conditions. Discrete point level

sensors include float-switch, conductivity/capacitive probes, contact ultrasound, and tuning forks.

Analog level sensors measure the fluid level over a continuous range. These sensors provide an electronic signal that directly correlates to the level within the storage vessel. The most common analog level measurement technologies include reflectance methods (ultra-sonic, RADAR and time-domain reflectometry (TDR)), capacitance, weight, and differential pressure.

Each of three level sensing methods are briefly described below.

### **7.9.19 Discrete Level Measurements Methods**

Discrete, point level measurements are required in vessels or pipes to automatically operate pumps, valves and/or audible or visual high or low alarms. Two units can be used to control tank filling (or emptying) or metering of a specific volume of liquid. Point level sensors must perform satisfactorily in most liquids, and be unaffected by coatings, clinging droplets, foam, or vapor. Liquid food products that are foamy, highly aerated, or highly viscous and can cling to the sensor, may present operating difficulties.

#### **7.9.19.1 Float Switch**

The basic float switch is a mechanical, discrete level sensor. A magnet equipped float moves directly with the liquid surface and actuates a hermetically sealed switch within the stem. Because of poor cleanability, float switches are not intended for direct contact with liquid foods. The switch incorporated in a float switch is hermetically sealed and magnetically actuated.

#### **7.9.19.2 Conductivity/Capacitance Probes**

For vessels constructed of electrically conductive materials, the two conductive parts of the probe consist of a rod and the vessel wall. For non-conductive vessels, the probe requires another conductive plate somewhere inside and along the vessel or the rod may be mounted inside a conductive tube. For a non-conductive fluid vessel, special systems using either dual probes or an external conducting strip may be required.

Sensors based on conductivity require the fluid to be conductive (e.g. aqueous solutions) so that when the fluid bridges the gap between the rod and vessel wall, the fluid closes a circuit, allowing current to flow.

Sensors based on capacitance do not require the fluid to be conductive. With these types of sensors, the conductive parts of the probe form the two plates of a capacitor, with the liquid medium and air serving as the dielectric. The operating principle is based on the fact that the capacitance between the two plates of the probe changes when the fluid contacts the two conductive surfaces.



In most cases, the probe is installed on top of the tank with the probe vertical. The actuation point is then the tip of the probe. The length of the probe must therefore be chosen according to the position of the desired switch point. As soon as the tip of the probe contacts the process material, a conductive/capacitance change is sensed and registers that the level point has been reached. Many probes used in this kind of application are partially insulated versions, as this increases their tip sensitivity. Capacitance probes are designed to tolerate a fair amount of probe fouling from the presence of material buildup on the conductive parts, so long as the material does not bridge conductive plates.

#### 7.9.19.3 Contact Ultrasonic

The contact ultrasonic liquid level switch detects the level of liquids, at a point, by means of a low energy ultrasonic technique. The sensor contains a  $\frac{1}{2}$  inch gap across which an inaudible, high frequency ultrasonic signal is generated. The presence of liquid in the gap allows the ultrasonic signal to easily travel across the gap. A microphone pick-up actuates a switch when ultrasound is present. The actuation point is approximately midway in the gap for horizontally mounted sensors, and is at the top face of the gap for vertically mounted sensors. As the liquid falls below this level, the ultrasonic signal is attenuated and the switch returns to its normal state.

This type of level switch can be used in vessels or pipes to automatically operate pumps, valves, and/or audible or visual alarms. Two units can be used to control tank filling (or emptying), or metering of a specific volume of liquid. The switch will perform satisfactorily in most liquids, and is unaffected by coatings, clinging droplets, foam, or vapor. Foamy liquids, which are highly aerated, or so highly viscous as to cling in the sensor gap, may present operating difficulties.

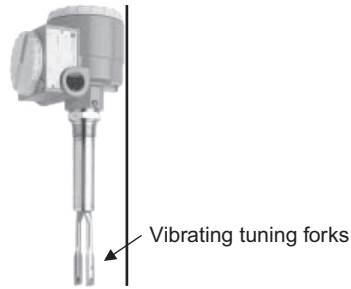
#### 7.9.19.4 Tuning fork

The tuning fork level sensor is constructed with a pair of paddles that oscillate at a specified natural frequency. If the paddles make contact with a fluid or solid of significant bulk, the oscillation frequency, or amplitude, is attenuated. These sensors are available with a sensitivity adjustment to allow the device to be tuned for fluids of different viscosities. A typical tuning fork level sensor is pictured in [Figure 19.38](#).

### **7.9.20 Analog Level Measurement Methods**

#### 7.9.20.1 Reflective Methods

All reflective methods are based on the generation of an energy pulse that is transmitted toward the process material at a constant, known speed. The process material reflects the energy pulse back to the sensor and the time of flight between the moment the pulse was generated until the moment the echo was received, which can be used to calculate the distance, or level of the process material in the tank.



**Figure 19.38** A typical tuning fork level sensor.

All reflective methods must cope with spurious echoes caused by:

- Permanent fixtures in the tank or features other than the process material.
- Secondary and higher-order echoes.
- Irregular surface features in the process material, for example, surface waves and vortices (in fluids), and irregular filling patterns (in solids).

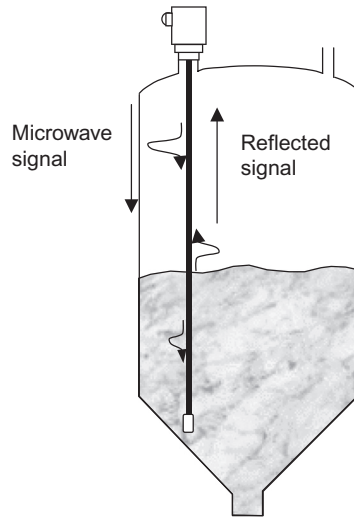
To remove the effects of noise, the calculations are averaged over a period of several pulses.

#### 7.9.20.2 Non-Contact Ultrasonic

A non-contact ultrasonic ( $> 20$  KHz) level sensor is similar to that used to determine position. The sensor is usually located at the top of a storage tank and the distance between the permanently mounted sensor and the surface of the liquid or solid is measured and translated into level. The sensor generates a series of acoustic pulses that are transmitted to the product surface, returned as an echo and detected by a microphone pick-up within the sensor. Owing to the fact that the speed of sound in air is constant, the distance to the surface is determined by measuring the interval of time between when the pulse was generated and when the echo returned. The calculation is averaged over a period of several pulses to remove noise from the effects of surface waves from any turbulence or agitation in the tank.

#### 7.9.20.3 RADAR

The RADAR level sensor is a subset of the RADAR technology used to determine position or distance. The sensor is located at the top of a storage tank and the distance between the permanently mounted sensor and the surface of the liquid or solid measured and translated into level. The sensor generates a series of electromagnetic pulses in the radio frequency spectrum, which are transmitted to the surface of the process material, returned as an echo, and detected by an antennae within the sensor.



**Figure 19.39** Time domain reflectometry (TDR) level measurement system.

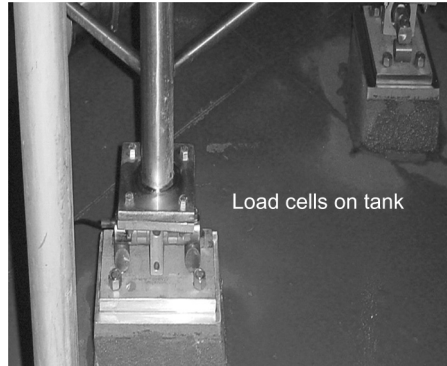
#### 7.9.20.4 Time Domain Reflectometry (TDR)

TDR transmits microwave pulses of low power along a braided steel cable that hangs within a tank (Figure 19.39). Any material in contact with the cable will reflect the microwave pulse back to the source. A massive weight at the end of the cable reflects the remaining microwave energy and acts as a reference point. The dielectric constant of the process material will affect the strength of the echo as does temperature, pressure, and the presence of foam.

#### 7.9.20.5 Capacitance

As with the ultrasonic sensor, this technology of level measurement may be used for either discrete or analog level measurement. For vessels constructed of electrically conductive materials, the two conductive parts of the probe consist of a rod and the vessel wall. For non-conductive vessels, the probe requires another conductive plate somewhere inside and along the vessel or the rod may be mounted inside a conductive tube. These conductive parts of the probe form the two plates of a capacitor, with the liquid medium and air serving as the dielectric. Probe fouling from the presence of material build-up on the conductive parts does not affect the operation of the probe as long as the material does not bridge the gap.

The sensing probe may be constructed from different materials, with either a rigid or a flexible design. The most common design is a conducting wire insulated with Teflon. A stainless steel probe is also available for applications where greater probe



**Figure 19.40** Load cells measure the weight of the vessel.

sensitivity is necessary. For example, low dielectric or non-conductive fluids (dielectric constant under 4) or granular fluids require the stainless steel probe. The flexible probes are used when there is not enough overhead clearance for the rigid probe, or in applications requiring longer length. The rigid probe provides higher stability, especially in turbulent systems. If the probe sways to and from the vessel wall, the signal from the probe may fluctuate.

#### 7.9.20.6 Weight

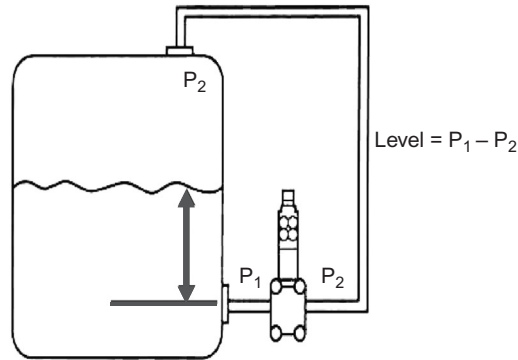
A direct method to detect level is simply to measure the weight of a vessel on an electronic scale or load cells (Figure 19.40). Using load cells, the vessel weight can be determined and if the substance has a constant density then the change in weight can be converted into product level. Load cells are only practical for small or intermediate sized storage tanks. Large tank weights reduce the sensitivity of the level measurement.

#### 7.9.20.7 Differential Pressure

A differential pressure sensor can be used to measure the level of a liquid in a pressurized vessel (Figure 19.41). The output of the sensor depends only on level and not on the static pressure in the vessel. This is an example of a pressure-type level device. A differential pressure sensor also is another means of determining the weight. As the quantity, or level, of the substance in the tank changes, so does the differential pressure, regardless of the overriding pressure or vacuum in the tank.

#### 7.9.21 Flow

The rate of material flow through the process is an important measurement in many food processing applications. Similarly, the total amount of a food ingredient or



**Figure 19.41** Differential pressure used to measure tank level.

**Table 19.6** Types of Flow Meters Used in the Food Industry

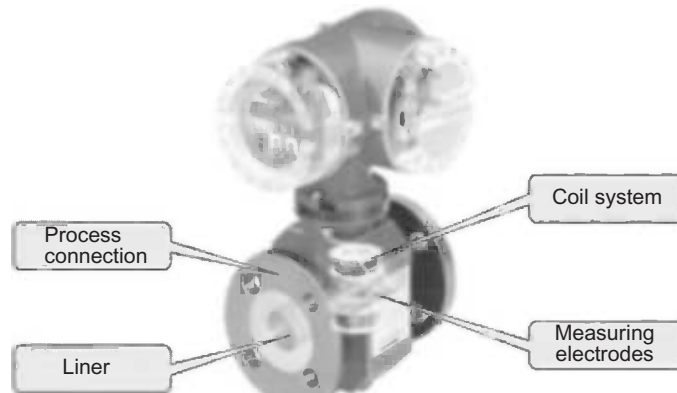
Type of Flow Meter	Measurement	Applications
Paddle meter	Flow velocity	Water usage
Vortex shedding	Flow velocity	Steam usage
Ultrasonic	Flow velocity	Liquid with particulates
Differential pressure	Flow velocity	Water flow rates
Magnetic	Flow velocity	Most products w/some conductivity
Coriolis	Mass flow	De-aerated liquids

product that has been delivered to, or from, a process over time is important for recipe management and inventory control. This information is provided using flow sensors or flow meters. There are several technologies used to measure either average flow velocity, which is related to volumetric flow rate, or true mass flow rate. Table 19.6 lists some of the types of flow meters used in the food industry.

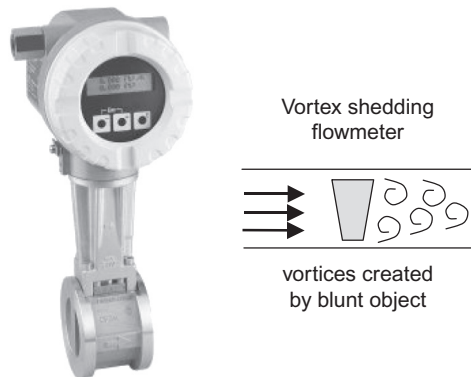
#### 7.9.21.1 Magnetic Flow Meter (commonly called a “Mag” meter)

The magnetic flow meter (Figure 19.42), is based on Faraday’s law of electromagnetic induction. This law states that a conducting material passing through (i.e. perpendicular to) a magnetic field produces a voltage proportional to the velocity of the moving conductor. The liquid moving through the sensor acts as the conductor and the magnetic field is created by coils near the flow tube.

For food products, the advantages of the magnetic flow meter include an obstruction-free flow path, no significant pressure drop, and suitability for clean-in-place operations. Its limitation is the need for the liquid to be electrically conductive. For this reason, it does not work for fats and oils.



**Figure 19.42** Typical magnetic flow meter showing main components.



**Figure 19.43** Typical vortex shedding flow meter.

#### 7.9.21.2 Vortex Shedding Flow Meter

The vortex shedding flow meter (Figure 19.43) uses a blunt object in the flow path to generate vortices. The rate of production of vortices is proportional to the flow velocity and volumetric flow rate. As these vortices travel through the meter, they create alternating low and high pressure areas. The sensing elements within the blunt body measure these pressure fluctuations. These flow meters can be used for liquids or gases. Their disadvantages are that the blunt body creates an obstruction in the flow path, wearing of the object can cause calibration shifts, and they are limited by a minimum flow rate under which flow is undetectable. In order to generate vortices, the flow must be turbulent.

Vortex shedding flow meters are best for clean, low viscosity fluids. Particulates in the fluid will build up on the blunt body. The most common applications are to measure flow rate of utilities such as steam, air, and water.

### 7.9.21.3 Coriolis Mass Flow Meter

In order to determine mass flow rate, we can measure two parameters, volume flow rate and density. This leads to an inferential measurement. An alternative approach is to measure mass flow directly, that is, a direct mass measurement that is independent of the properties and state of the fluid. The Coriolis-type flow meter (Figure 19.44) provides a direct mass flow measurement. As fluid flows around a bent tube, a force is created that is tangent to the direction of flow. This force is called the Coriolis force and causes the ends of an oscillating U-tube to vibrate out-of-phase. The phase shift is proportional to the mass flow rate. Current designs of Coriolis mass flow meters now use a pair of nearly straight tubes. The phase shift between these vibrating tubes is related to mass flow rate. Coriolis flow meters are, in general, very accurate, better than  $\pm 0.1\%$  with a turndown rate more than 100:1. The Coriolis meter can also be used to measure the fluid density.

### 7.9.21.4 Ultrasonic

Ultrasonic flow meters (Figure 19.45) are a good choice to measure flow through existing pipes. These flow meters can be applied to the outside of the pipe and do not

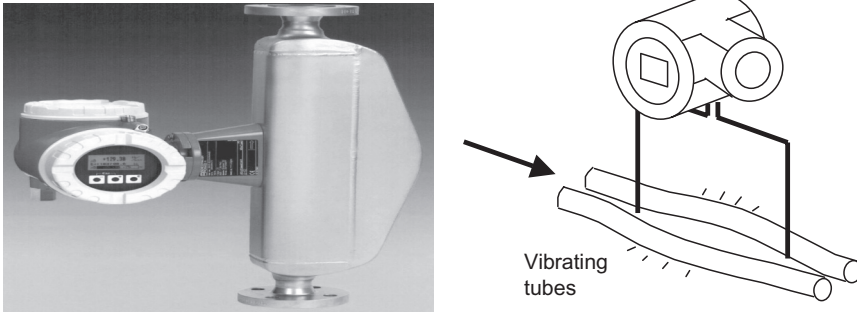


Figure 19.44 *The Coriolis-type flow meter.*

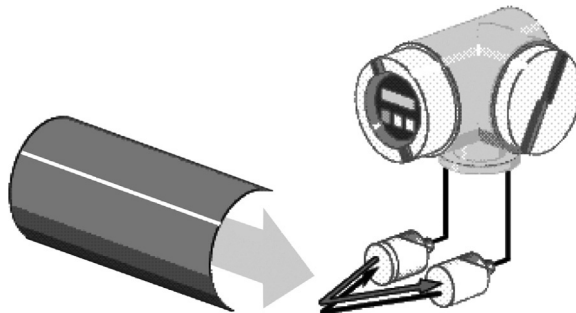


Figure 19.45 *Ultrasonic flow meter.*

need to be directly inserted into the flow stream. One principle behind this technology is that the amount of time it takes for ultrasonic waves to traverse a section of pipe and return is proportional to the flow rate. As the fluid moves through the pipe, the sound waves are deflected increasing their transit time. This information can then be related to the velocity of the fluid. Another type of ultrasonic flow meter uses Doppler principles to measure the amount of shift in the frequency of a sound wave as it is reflected by particles in the fluid stream. This information can then be related to the velocity of the fluid. The Doppler-type ultrasonic flow meters require some sort of particles to be present in the flow stream. Small air bubbles in a liquid stream also serve the same purpose as particles.

#### 7.9.21.5 Differential Pressure

In an orifice meter, there are two basic elements, the orifice plate and the differential pressure transmitter (Figure 19.46). The orifice plate itself is a thin plate with a hole bored in it and this plate acts as a restriction to the flow of fluid through the pipe.

As the fluid flows along the pipe and passes through the orifice plate, its velocity must increase because the cross-sectional flow area is decreased. The energy necessary to increase the fluid velocity causes a pressure drop downstream of the restriction. By measuring the pressure drop with a differential pressure transmitter, the volumetric flow rate of the fluid can be inferred. The flow rate is proportional to the square root of the output from the differential pressure transmitter.

The orifice meter is inexpensive, widely accepted, and readily available. It has a low turndown ratio, produces a large pressure drop, and its accuracy is affected by plate wear, fluid density, and viscosity. However, it is not applicable to measuring the flow of liquid food materials because of fouling, sanitation concerns, and difficulty in cleaning the orifice using CIP procedures.

Both the flow nozzle and the venturi tube work on the same principle, that is, the restriction shape and flow pattern are different. As a fluid passes through an orifice,

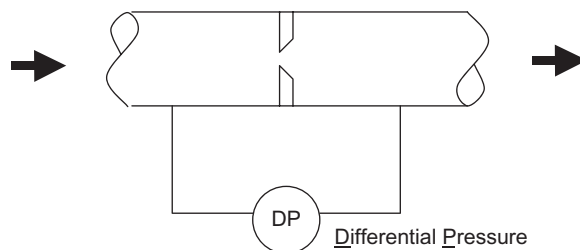


Figure 19.46 An orifice meter.



there is a pressure drop that relates to the square of the flow rate. This effect is illustrated by the well-known Bernoulli equation:

$$\frac{P}{\Delta} + v^2 = 0$$

where  $\Delta p$  is the differential pressure,  $\rho$  is the fluid density and  $v$  is the flow velocity. The Bernoulli equation can be rearranged to obtain flow velocity as follows:

$$v = C \sqrt{\frac{P}{\rho}}$$

where  $C$  is an orifice flow coefficient.

## 7.10 Transmitters and Transducers

A *transmitter* is a device that converts one electrical signal into another. A *transducer* is a device that converts one type of signal into another form of signal. For example, a pressure sensor is a *transducer* because it converts a pneumatic signal into an electrical signal. Most of the sensors described earlier can be considered transducers.

### 7.10.1 Sensor Transmitters

Suppose it is necessary to transmit “information” regarding the measurement of a process variable a considerable distance from the factory floor to another location. How might this be accomplished? One method is to convert the electronic signal provided by the sensor (e.g. mV, ohms resistance, capacitance, etc.) to a standard electrical voltage or current. Take a thermocouple, for example. Thermocouples produce low millivolt (thousandth of a volt) signals corresponding to the temperature at the thermocouple junction. These low voltage signals do not have enough energy to travel through much more than 10–20 ft of cable before incurring signal loss because of the resistance in the wire. Even the best conductors have sufficient resistance to restrict the flow of small currents at low voltages. Thus, it is necessary to amplify such low voltage sensor signals and convert them to appropriate levels suitable for transmission over reasonable lengths of wire.

In addition, because the signal strength is so small, any electrical noise that is induced into the sensor output wires from adjacent electromagnetic fields (e.g. motors, fluorescent light transformers) is significant and decreases the signal-to-noise ratio. It is extremely difficult to interpret the low voltage signals against high background electrical noise.

Sensor transmitters are signal amplifiers that convert a sensor’s output to a signal level appropriate for input to a display panel or controller. There are two kinds of sensor transmitters, analog and digital. Analog transmitters are currently the most popular.

However, the use of digital transmitters is growing rapidly and they are replacing analog transmitters in many applications.

For analog transmitters, the automation and process control industry has standardized on a 4–20 mA current loop for signal transmission.

This standardization of transmission signals allows equipment from different manufacturers to communicate with each other. Sensor transmitters take the low voltage output from a sensor and convert it to a 4–20 mA current output that is linearly proportional to the measured variable. Transmitters are usually designed to be direct acting. That is, the output signal increases as the measured variable increases. In addition, most transmitters have adjustable ranges. For example, a temperature transmitter can be adjusted so that the 4–20 mA signal corresponds to any range of temperature, such as 50–150°C, 0–300°C, or –100–500°C. To do this, the transmitter is actually converting the sensor output signal to a 4–20 mA signal for an RTD sensor and transmitter (Figure 19.47).

Take for example, a temperature transmitter for an RTD sensor. The transmitter measures the change in resistance for the platinum wire element of the RTD and provides a 4–20 mA output signal that is proportional to a user-specified temperature range, say 20–300°C. A block diagram of this example sensor/transmitter combination is illustrated in Figure 19.48.

Even if the output of the RTD is *non-linear* with respect to the measured temperature, the transmitter *linearizes* the signal as well as amplifies it. Thus, the output of the transmitter is a linear function of the measured variable and fits the equation  $y = mx + b$ , where  $y$  is the transmitter output (mA),  $x$  is the measured variable, and  $b$  is the offset.

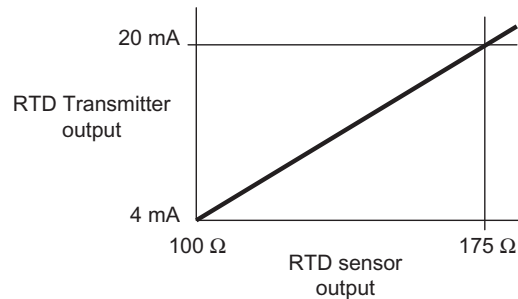


Figure 19.47 Converting the output signal to a mA signal for an RTD sensor and transmitter.

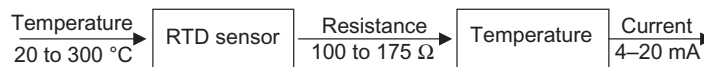


Figure 19.48 Block diagram of example sensor/transmitter combination.

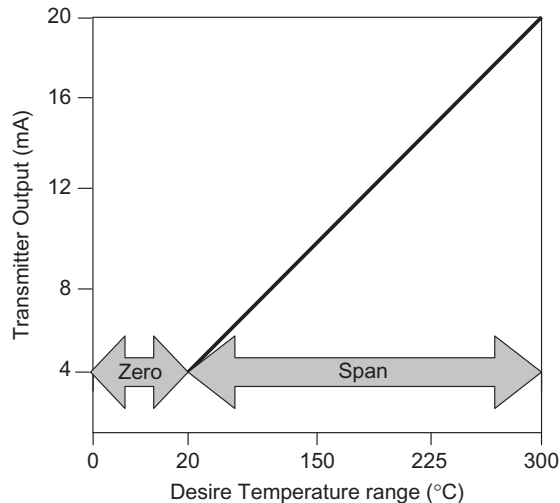
Because sensors vary in accuracy and change properties over time, transmitters permit the adjustment of the slope  $m$  and offset  $b$ , so that the sensor/transmitter combination can be calibrated to a known standard. In our RTD example, the sensor may be slightly inaccurate. When placed in an ice bath, the current output may measure 3.050 mA (it should measure 4.000 mA) and when placed in a boiling water bath the current output may measure 9.005 mA (it should measure 8.57 mA). However, the error can be corrected by adjusting the slope  $m$  and offset  $b$  until the measured mA output at the two temperatures agrees with the correct mA output.

The *gain* of the transmitter equals the slope  $m$  and the *bias* of the transmitter equals the offset  $b$ . The *span* adjustment of a transmitter modifies the gain or slope  $m$  and the *zero* adjustment of a transmitter modifies the bias or offset  $b$ . Using the above example, that is, 20–300°C of temperature corresponding to 4–20 mA of current output from the transmitter, the equation for converting temperature ( $x$ ) to mA ( $y$ ) using the *span* and *zero* values is

$$y = mx + b = \frac{20 - 4}{\text{Span}}(x - \text{zero}) + 4 = \frac{16}{280}(x - 20) + 4$$

This equation is also illustrated in the [Figure 19.49](#).

Digital transmitters provide a digital electronic representation of the measured variable rather than an analog electronic representation. To do this, digital transmitters contain microprocessors that encode the information in a binary, digital format suitable for transmission over a digital network protocol. Digital transmitter networks have similar advantages to computer networks by providing more accurate data transmission in error checking and diagnostics.



**Figure 19.49** *Span and zero of a transmitter.*

Some of the popular digital bus networks for sensors include:

- Foundation Fieldbus (USA and Asia primarily).
- Ethernet with TCP/IP.
- Highway Addressable Remote Transmitter (HART).
- RS-232 Serial.
- Profibus (Europe primarily).
- DeviceNet.
- Modbus.

Another advantage offered by digital bus-type transmitters is that a group of sensors can all be connected (multi-dropped) to the same network cable thus reducing wiring costs. In addition, because the signal is digital, the information can be transmitted in both directions and can contain more than just the measured variable. Calibration factors, date of calibration, and diagnostic information can also be transmitted over the digital bus network between the transmitter and the computer controller. With strictly analog transmitters, only the measured variable is available to be transmitted to the computer controller. Because of the additional information and microprocessor power in digital transmitters, a sensor with a digital transmitter pair is often called a “smart sensor”.

### **7.10.2 Smart Sensors**

“Smart sensors” refers to those sensors that are connected to digital transmitters controlled by a microprocessor. The signal sensed by the measuring device is brought into the transmitter and is immediately converted into a digital signal; all internal signal conditioning and processing are done digitally. Tremendous gains are made in accuracy, linearity, and versatility. The output of the smart transmitter in digital format will always conform to some designated or specified electrical standard for current or voltage.

One popular digital bus protocol listed above is HART, which stands for Highway Addressable Remote Transmitter. HART is a hybrid protocol that shares characteristics of both analog and digital signal transmissions. In a typical HART sensor, the measured variable is transmitted using the standard 4–20 mA analog signal. However, a digital signal is superimposed over the 4–20 mA analog signal to transmit diagnostic and calibration information. HART was designed to maintain compatibility with use of analog-only signal transmitters, while taking advantage of “smart” transmitters in the same system.

## **8. ACTUATORS**

### **8.1 Motors**

Motors convert electrical energy into mechanical energy and are used to power mixers, pumps, grinders, mills, valves, etc. Two types of motors are commonly used in

processing systems, alternating current (AC) and direct current (DC) motors. AC motors are commonly used for discrete control systems by using a motor starter to turn on and off the motor. In continuous control systems, both AC and DC motors are used to vary the speed of mechanical systems or pumps. A DC motor's speed varies simply by changing the voltage sent to the motor.

In the USA, AC electricity cycles at a very accurate frequency of 60 Hz or 60 cycles per second. This means that the current changes direction of flow 120 times per second. An AC motor connected to 60 Hz electrical current will rotate at a nearly constant speed. The most common rated speeds are 1,725 or 3,500 RPM under full load. Most AC motors used in the food industry are considered three phase-type motors. A three phase motor simply uses three AC wires whose currents are “out of phase” to power the motor.

When a three phase, AC motor is used to drive a pump, either a mechanical transmission system can be used to vary the speed of the pump or a variable frequency drive (VFD) can be used to vary the speed of the AC motor connected to the pump. The variable frequency drive electronically changes the frequency of the electrical input to the motor in order to change its speed. A VFD can be thought of as a transmitter when it receives a 4–20 mA signal from a controller and converts it into a range of frequencies that adjust the motor speed from 0 to 110% of its rated speed.

## 8.2 Pumps

Pumps are mechanical devices used to move fluids through a system. They consist of a motor to provide the mechanical energy and an impeller to generate fluid movement. Pumps come in primarily two types, positive displacement (PD) and centrifugal (CF).

PD pumps deliver a relatively constant flow rate despite line restrictions or pressure changes in the line. The higher the line restriction, the higher the pressure developed at the outlet of the pump. PD pumps are for applications that require minimal to no backward flow. In the food industry they are used for pasteurization and aseptic processing where positive flow rate is mandatory. If the line is completely restricted, PD pumps will create high pressures and cause the motor to overload. Typical designs of PD pumps include piston, diaphragm, progressive cavity, gear, lobe, and peristaltic pumps.

In contrast to PD pumps, CF pumps deliver fairly constant pressure over a range of flow rates. If the line is completely restricted, centrifugal pumps will continue to run without damage, although there will be no forward flow. Differences in the pressure versus flow curves for each type of pump are shown in [Figure 19.50](#).

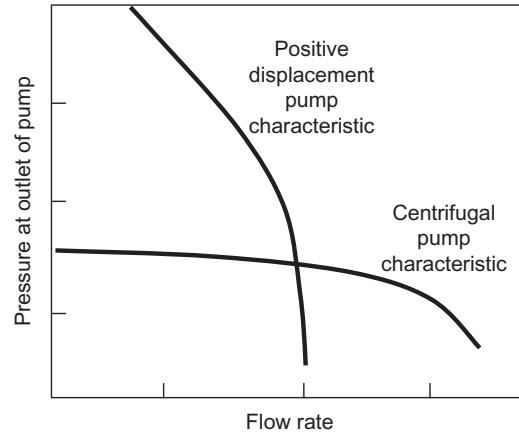


Figure 19.50 Pressure versus flow curves for positive displacement and centrifugal pumps.

### 8.3 Control Valves

Control valves are a primary method for regulating the flow of material and energy into and out of a process. Valves are classified as:

- Linear stem control valves.
- Rotary control valves.
- Ball control valves.

#### 8.3.1 Linear Stem Control Valves

In linear stem control valves, the valve plug is positioned by a stem that slides through a packing gland. Linear stem motion control valves may be single-seated, double-seated, gate valves, etc.

Linear stem motion control valves have many different body styles, the most common being in the form of a globe. Single-seated valves are commonly employed for situations in which tight shut-off is required or in sizes of 1 in. or smaller. Double-seated valves generally have leakage through the valve that is somewhat greater than in single-seated valves because it is virtually impossible to close the two ports simultaneously, especially when thermal expansion and other factors are considered. However, the advantage of double-seated bodies is that the hydrostatic effect of the fluid pressure acting on each of the two seats will tend to cancel out and much less actuator force is necessary to move the valve. Linear stem motion valves are also used in three-way valve bodies where the control valve may be used to divert a stream or to combine streams.

### 8.3.2 Rotary Control Valves

Rotary shaft control valves enjoy the advantages of low weight, simplicity of design, relatively high flow rates, more reliable and friction-free packing, and relatively low initial cost. They are not usually found in sizes under 1 in.

The most common rotary shaft control valve is the butterfly valve. Butterfly valves range in size from 2 in. through 36 in., or larger. They are often used in applications involving large flows, high static pressures, and limited pressure drop availability. One type of rotating shaft control valve of particular usefulness is the eccentric cylindrical plug valve. Its relative capacity is high and its cost is low. It is especially useful on services involving corrosive fluids, viscous liquids, or fluids with suspended solids.

### 8.3.3 Ball Control Valves

The ball valve has historically been used principally as a tight shut-off hand valve. However, in recent years, ball valves have been automated for control purposes and have shown excellent rangeability and suitability to handle slurries.

There are two distinctly different types of ball control valves, one involves a ball (a complete sphere) with a waterway through it; this is generally referred to as the full ball type. The second type is developed along the lines of the concentric plug valve and utilizes a hollowed out spherical segment, or partial ball, which is supported by shafts. Both types of ball valves are quarter-turned rotary valves.

Ball valves have the highest flow capacity of any commonly used control valves. They are useful whenever slurries are involved and also provide tight shut-off. They are required, for example, on retort vent lines so that no restriction is present while the retort is being vented of air.

## 8.4 Control Valve Actuators and Positioners

### 8.4.1 Valve Actuator

Valves require an *actuator* to move the valve, thus opening or closing the area through which fluid passes. Most food automation applications use air-actuated or pneumatically controlled valve actuators (Figure 19.51). When supplied with increasing air pressure, a single acting pneumatic actuator increases the pressure on the actuator piston or diaphragm compressing the springs and moving the valve stem.

When air is applied to open the control valve, it is termed “Air to open” or ATO. When air is applied to close the control valve, it is termed “Air to close” or ATC. Normally, the choice of an ATO or ATC configuration is based on safety considerations. Normally, the choice is based the way the valve should operate in case of a controller failure.

Valve actuators should be adjusted so that the control valve is completely closed at 3 psig and begins to open as the air pressure increases above 3 psig. The valve should be fully open at 15 psig. Actuators should be adjusted with the valve under nominal

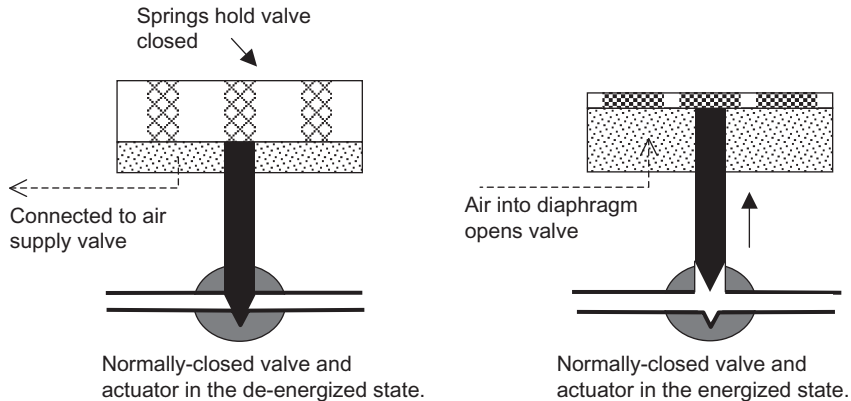


Figure 19.51 *Diaphragm and valve on Air to Open (ATO) valves.*

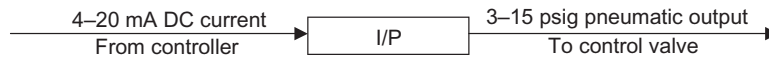


Figure 19.52 *Diagram of current to pressure transducer used for continuous control of a valve.*

line pressure. The line pressure adds force that can lift to the valve stem and cause the valve to leak. This effect is called *flow loading*. In many cases, actuators adjusted while the valve is not under line pressure will result in valve leakage once installed.

As an electronic controller cannot supply air pressure to open or close a pneumatic valve directly, a solenoid valve or current to pressure transducer (I/P) is required between the components. A solenoid valve is simply an open or closed air valve that is actuated by an electrical solenoid. When current is supplied to the solenoid, it will actuate the valve and either open (in the case of a normally closed valve) or close (for a normally open valve) the valve body. The solenoid controlled valve can be used for discrete control valves when air supplied by the solenoid valve is connected to the diaphragm of a flow control valve to change its position. If the solenoid was large enough and had enough power to move the stem of the flow valve against the pressure head, it could be used to directly actuate the flow control valve.

Current to pressure transducers, typically called “eye-to-pea” transducers (Figure 19.52) are used for continuous control of a valve. The I/P usually accepts 4–20 mA of current input, which is converted to 3–15 psig of air pressure out of the transducer.

Valve positioners can be used to increase the relatively small mechanical force that is exerted by I/P. Valve positioners also eliminate hysteresis and flow loading, providing more accurate control of the valve position.



### 8.4.1.1 Valve Positioner

A valve positioner is itself a type of mechanical feedback control device. A positioner senses the actual position of the valve stem, compares that position to the desired position, and adjusts the air pressure to the valve to position the valve stem precisely as dictated by the signal from the controller. The use of a valve positioner often is desirable to improve both the dynamic and the static behavior of the valve. A valve positioner is typically an air relay, which is used between the controller output and the valve diaphragm. It usually has a separate air supply and a feedback signal indicating stem position. The positioner acts to eliminate hysteresis, packing-box friction, valve plug unbalance because of pressure drop of the manipulated flow, and assures the exact positioning of the valve stem in accordance with the controller output. The valve positioner also is useful in minimizing lag associated with the valve response.

Figure 19.53 shows pneumatically actuated valves controlled by I/P, and valve positioners.

### 8.4.1.2 Failure Mode

It is inevitable that power will fail occasionally in a process. Regardless of whether the final control element is pneumatic, hydraulic, or electric, this situation requires analysis and specification of valve behavior during such emergencies. In general, there are three possible patterns that might be encountered in power failure:

1. The final control element may fail “open”.
2. The element may fail so as to hold the position which it last held. This is referred to as “last position”.
3. The element may fail “closed”.

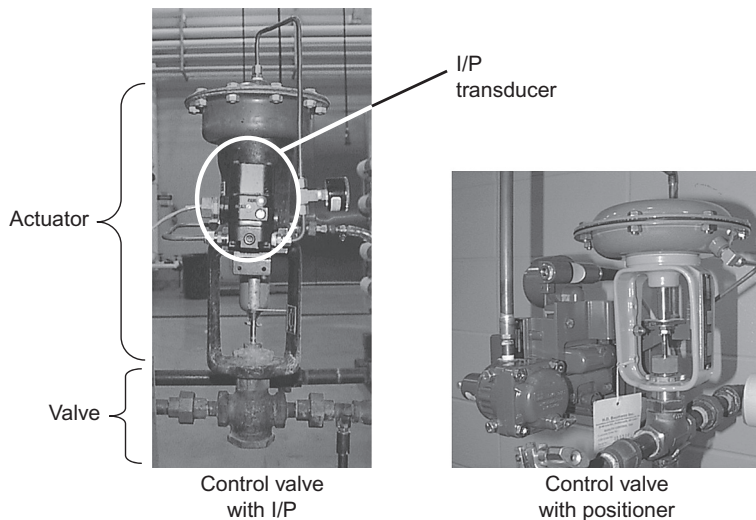


Figure 19.53 Pneumatically actuated valves controlled by I/P, and valve positioners.

In any given instance, it is required to select the failure pattern that is most desirable under a power failure.

### **8.4.2 Valve Selection and Sizing**

There are several important factors to consider in control valve selection. These include:

- The rangeability and turndown of the valve.
- The range of operating loads to be controlled.
- Valve materials in relation to the nature of the fluid flowing through the valve.
- The dynamic flow behavior at nominal, maximum and minimum flow.

#### **8.4.2.1 Rangeability and Turndown**

Rangeability is the ratio of the maximum controllable flow through the valve to the minimum controllable flow through the valve. In typical operations, control valves do not close off entirely because to do so might damage the valve seat or cause the valve to stick. Flow in the closed position, therefore, is typically 2–4% of the maximum flow. This corresponds to a rangeability of 25–50. Linear stem motion control valves show a rangeability of 20–70.

Turndown is defined as the ratio of the normal maximum flow through the valve to the minimum controllable flow. A practical rule of thumb is that a control valve should be sized so that the maximum flow under nominal operating conditions is approximately 70% of the maximum possible flow. Thus, the turndown ordinarily is about 70% of the rangeability.

#### **8.4.2.2 Range of Operating Loads**

Not only must control valves have sufficient rangeability, but also they must be able to moderate flows that are well below the minimum requirement of the process. In addition, the maximum flow rate through the valve must exceed the peak requirement of the process. For many process plants, the range of nominal operating loads is narrow and, in such cases, the control valves maintain nearly constant flow rates. However, peak and minimum loads must also be considered.

Valves selected to normally operate at 60–70% of full capacity are used in such applications. However, there are many process systems in which the operating conditions vary considerably, that is, the load varies significantly. In such conditions, equal-percentage flow characteristics are often used, as they provide a more constant fractional sensitivity at all operating levels.

#### **8.4.2.3 Materials**

The nature and condition of the fluid have obvious effects on valve selection. The material from which the body of the control valve is made is specified by first

considering the properties of the process fluid. The choice of construction material depends on the properties of the process fluid at operating conditions. Commercial valves are available that are constructed from brass, carbon steel, and stainless steel. The valve seat material will also depend on the process fluid and requirements. For example, valves that must pass fluid foods such as milk and juices are usually specified to meet 3A sanitary design approval standards. Typically these valves are made of stainless steel and have Teflon seats. The valve size, valve flow characteristics, and actuator size are determined by the process.

#### 8.4.2.4 Dynamic Flow Behavior

Flow through a control valve depends not only on the extent to which the valve is open, but also on the pressure drop across the valve. The flow characteristics of linear stem motion control valves generally fall into three broad categories depending on the relationship between the amount of valve position, travel, stroke, or lift in the opening direction as compared to the resulting flow (Figure 19.54).

- *Quick Opening*: In this case, the valve sensitivity (defined as the change in flow for a given change in valve position) decreases with increasing flow.
- *Linear*: In this case, the valve sensitivity is more or less constant throughout the flow range.
- *Equal Percentage*: The equal-percentage type valve derives its name from the fact that the valve sensitivity at any given flow rate is a constant percentage of that given flow rate.

The individual flow characteristics of a particular valve can be custom specified for a particular application. Valve sizing depends on the pressure drop across the valve and

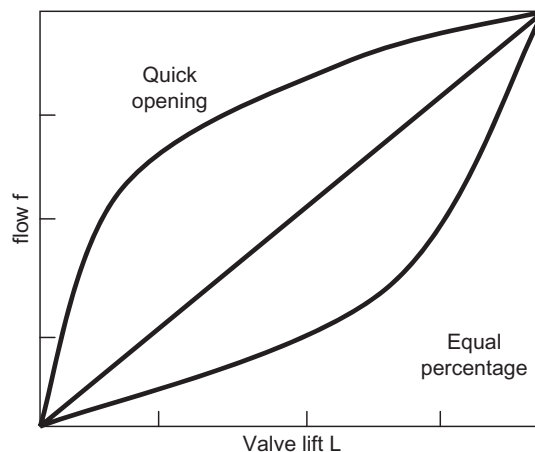


Figure 19.54 Flow characteristics of linear stem motion control valves.

the dynamic performance required. The proper size of a control valve is most important to the overall operation of the feedback control system. If the valve is over-sized, it tends to operate only slightly open and the minimum controllable flow is too large for the system. In addition, the lower part of the flow characteristic curve is often non-uniform in shape. On the other hand, if the valve is under-sized, the maximum flow needed may not be obtainable.

In sizing control valves, it is standard practice to combine many terms from the basic orifice equation into the following general relationship for incompressible liquids:

$$q = C_v f(L) \sqrt{\frac{\Delta P}{g_s}}$$

The valve coefficient  $C_v$  is defined as the flow rate of water in gallons per minute provided by a pressure differential of 1.0 psi through a fully opened control valve. This coefficient is determined by the manufacturer of the valve under actual test conditions. The valve coefficient for a control valve of the linear stem travel type is approximately equal to the square of the nominal valve size multiplied by ten. For the flow of compressible fluids, the valve coefficient is also employed with suitable conversion factors.

A design equation used for sizing control valves relates the valve lift  $L$  to the actual flow rate  $q$  by means of the *valve coefficient*  $C_v$ , the proportionality factor which depends predominantly on valve size or capacity:

$$q = C_v f(L) \sqrt{\frac{P}{g_s}}$$

where  $q$  is the flow rate,  $f(L)$  is the flow characteristic,  $\Delta P$  is the pressure drop across the valve, and  $g_s$  is the specific gravity of the fluid. This relationship is valid for non-flashing liquids.

Valve size selection is dependent on the *valve characteristic*  $f$ . Three control valve characteristics are used primarily. For a fixed pressure drop across the valve, the flow characteristic ( $0 \leq f \leq 1$ ) is related to the lift ( $0 \leq L \leq 1$ ) by one of the following relationships:

$$\text{Linear: } f = L$$

$$\text{Quick opening: } f = \sqrt{L}$$

$$\text{Equal percentage: } f = R^{L-1}$$

where  $R$  is a valve design parameter that is usually in the range of 20–50.

Sizing control valves is a complex issue. The correct valve size to use depends on valve cost, allowable pressure drop, and installed flow characteristic. The entire question of determining control valve size, flow rate, or pressure differential is made in most industrial applications by the use of special purpose calculations or special-purpose computer programs.

## **FURTHER READING**

- Bryan, L.A., Bryan, E.A., 1997. Programmable Controllers: Theory and Implementation, second ed. Industrial Text Company, Marietta, GA.
- Hughes, T., 1995. Measurement and Control Basics, second ed ISA, Research Triangle Park, NC.
- Murrill, P., 2000. Fundamentals of Process Control, second ed ISA, Research Triangle Park, NC.
- Seborg, D.E., Edgar, T.F., Mellichamp, D.A., 1989. Process Dynamics and Control, first ed. John Wiley and Sons, Hoboken, NJ.

# Ohmic Pasteurization of Meat and Meat Products

James G. Lyng and Brian M. McKenna

University College Dublin, Ireland

## 1. INTRODUCTION

Ohmic heating is a term used to describe direct electrical resistance heating of food products. It is a technology which was awarded the USA Institute of Food Technologists industrial achievement award for 1996 and is a topic on which many review and popular articles (Frampton, 1988; Larkin and Spinak, 1996; Reznick, 1996; Rice, 1995; Ruan *et al.*, 2001; Sastry, 1994; Sastry, 2005; Sperber, 1992; Vicente and Castro, 2007; Vicente *et al.*, 2006; Zoltai and Swearingen, 1996) have been written. Applications, which have been proposed for ohmic heating include:

- Sterilization of single and multiphase products (Berthou *et al.*, 2001; Chun-Shi *et al.*, 1999; Decio, 2003; Eliot-Godereaux *et al.*, 2001; Ladwig, 1991; Parrot, 1992; Sastry, 1992; Sastry and Palaniappan, 1992; Zhou Yajun *et al.*, 2003; Zuber, 1997).
- Pasteurization (Leizerson and Shimoni, 2005a,b; Tucker *et al.*, 2002).
- Protein recovery from surimi wash water (Benjakul *et al.*, 1997; Huang *et al.*, 1996; Kanjanapongkul *et al.*, 2009).
- Enhancing extraction yield (Onwuka and Ejikeme, 2005; Praporscic *et al.*, 2005; Rao Lakkakula *et al.*, 2004; Wei-Chi and Sastry, 2002).
- Blanching (Icier *et al.*, 2006; Mizrahi, 1996; Sensoy and Sastry, 2004).
- Pre-treatments to enhance drying rates (Lima and Sastry, 1999; Salengke and Sastry, 2005; Tuoxiu and Lima., 2003).
- Enzyme inactivation (Castro *et al.*, 2004).
- Thawing (Cheol-Goo *et al.*, 1998; Icier *et al.*, 2010; Roberts *et al.*, 1998 and 2002).
- Cooking (Uemura *et al.*, 1998).
- Starch gelatinization (Wei-Chi *et al.*, 1997).

Sterilization of ambient storage products is the area on which much work has been done and relevant papers focus on the influence of electrical conductivity

(De Alwis and Fryer, 1992; Halden *et al.*, 1990) and particle shape (De Alwis *et al.*, 1989) on heating rates. Pasteurization of meat and meat products is an area in which ohmic heating has potential. Traditionally, commercial pasteurization of meat products has been carried out by placing the product in a suitable container (i.e. glass, metal or plastic), which is then immersed in hot water or placed in a steam oven. In both these processes heat is transferred by conduction from the outside surface of the product to its interior. This can lead to over-heating of the outer regions of the product while waiting for the interior to reach appropriate temperatures, which in turn can potentially reduce product quality and nutritional value. In contrast ohmic heating occurs volumetrically, which theoretically means that all parts of the product more or less heat simultaneously and at the same rate. This largely avoids overheating in the outer regions of the product and could potentially increase product quality and nutritional value while reducing cooking times. This in turn could be expected to lead to the production of products with improved nutritional quality. In addition it also makes continuous processing a reality for such products.

De Alwis and Fryer (1990) reviewed a number of early patented applications for ohmic heating of meat products. The 17 patents they describe date from 1937 to 1975 and include commercial vending and domestic units for reheating frankfurters with only a limited number (Luijterink, 1962; Neumann, 1961) designed for ohmic heating for raw meat. Piette *et al.* (2001) overview another early investigation into ohmic heating of meat which was conducted in Finland in the 1970s. These experiments involved cooking a meat emulsion while it was being pushed at a rate of a few centimeters per minute through a Teflon tube which was fitted with circular electrodes. A patent was granted but the difficulties in maintaining stable operating conditions over prolonged periods ultimately led to this method being abandoned. Piette and Brodeur (2003) also describe a French exploratory study conducted in the 1990s between the Meat Institute Development association and the national power corporation, Électricité de France. According to Piette and Brodeur (2003) this group developed a batch procedure for cooking 2 kg batches of liver pate and hams in 10 min, but the subsequent development of a prototype continuous method yielded disappointing results. More recently Özkan *et al.* (2004) compared the quality of conventionally grilled hamburger patties to patties cooked ohmically. Patties were cooked from frozen and these workers concluded that ohmic heating was capable of producing patties of comparable quality to conventionally cooked products. In the past number of years a number of more in depth studies have been conducted on ohmic cooking of meat and meat products (De Halleux *et al.*, 2005; Piette *et al.*, 2000a,b, 2001, 2004; Shirsat *et al.*, 2004a,d; Zell *et al.*, 2009a,c; 2010a,b, 2011, 2012). The current chapter intends to overview these articles while also providing an introduction to the use of this technology for pasteurization of meat and meat products.

## 2. CONVENTIONAL THERMAL METHODS FOR THE PRESERVATION OF MEATS

Preservation of meat by thermal processing dates back to the beginning of the nineteenth century when in 1810 Appert, although not aware of the nature of the process involved, found that meat would remain edible if it were heated in a sealed container and the seal maintained until the meat was to be eaten (Lawrie, 1998). Heat processing is still viewed as one of the key methods for meat preservation as it kills pathogenic and spoilage microorganisms likely to grow during normal distribution and shelf-life of a product while also inactivating enzymes. Heat processes for meats can be classed as sterilization or pasteurization with sterilization being generally regarded as a heat process in which a product is heated to temperatures in excess of 100°C, whereas pasteurization is normally defined as a method of preserving food by heating it to temperatures under 100°C (typically 66–77°C). Sterilized products have a substantially reduced microbial load and as a result are shelf-stable even at ambient temperatures. However, relative to sterilization, pasteurization is a milder heat process that kills off pathogenic organisms but has a minimal effect on the flavor or quality of the food (Fellows, 1988). There is currently a move away from sterilized ambient temperature storage products towards pasteurized refrigerated products.

The extent to which a product has been pasteurized is quantified using pasteurization units (PU) and Eq. 20.1 below allows the calculation of pasteurization units (PU<sub>60</sub>) using a z value for pasteurization (z<sub>p</sub>) of 5.5°C (*Listeria monocytogenes* in meat products (IFT, 2001)), a reference temperature (θ<sub>p</sub>) of 60°C.

$$\int_0^{t_p} dt \times 10^{\frac{T-\theta_p}{z_p}} = \int_0^{t_p} dt \times 10^{\frac{T-60}{5.5}} = \text{Pasteurization units (PU}_{60}) \quad [20.1]$$

where, T is the temperature (°C) at the measurement point at any time during the heat process, dt is the duration of time at a temperature T (s), and t<sub>p</sub> is the time (s) at the end of the heating process. In addition to its importance in the inactivation of microorganisms, a second function of meat pasteurization is to induce chemical changes in texture, color and flavor concomitant with the change from a raw to a cooked product. Like microbial destruction these chemical reactions are a function of time and temperature and can be quantified using the cook value (Cs). Cs<sub>100</sub> values can be calculated using the procedure of Mansfield (1962) and Eq. 20.2.

$$\int_0^{t_p} dt \times 10^{\frac{T-\theta_c}{z_c}} = \int_0^{t_p} dt \times 10^{\frac{T-100}{33}} = \text{Cook value (Cs}_{100}) \quad [20.2]$$

where, Cs<sub>100</sub> is the Cs value calculated using a reference temperature (θ<sub>c</sub>) of 100°C and a z value for cooking (z<sub>c</sub>) of 33°C. T, dt and t<sub>p</sub> are as previously defined. The relationship between Cs and microbial destruction was discussed at length by Holdsworth



(1985) who described four possible outcomes for a heat treatment. These outcomes redefined in the context of meat pasteurization could be described as uncooked un-pasteurized, cooked un-pasteurized, uncooked pasteurized and cooked pasteurized. For ohmic heating to be accepted as a method for cooking meat and meat products it must induce the chemical changes associated with a cooked product while rendering the product safe from a microbial point of view. In addition, ohmically pasteurized products must also have comparable shelf-lives to conventionally cooked meats.

### 3. BASIC PRINCIPLE OF OHMIC HEATING

#### 3.1 Fundamentals of Electrical Circuitry

The operation of any electrical circuit is characterized by the presence of three physical quantities, namely voltage, amperage, and resistance. Voltage (volts) is the electrical pressure supplied by an AC mains supply, battery, alternator, or generator. Resistance (ohms) is the opposition to the current flow caused by the circuit (e.g. wires, electrical components or food (in the case of ohmic heating)), whereas amperage (amperes) is the current flow through the wires, electrical components, or food. As these physical quantities are quite abstract, the analogy of a garden hose connected to a tap is often used to assist in their visualization. When the tap is opened fully, there is a good water pressure (electrical pressure (voltage)) and a substantial water flow (current flow (amperage)) through the hose (wires, electrical components or food). Squeezing the hose (increasing resistance) will decrease the water flow (decrease electrical current) but will not change water pressure (electrical pressure (voltage)). If on the other hand the water is allowed to flow through the hose normally but the tap is closed to the half way position, the water pressure (electrical pressure (voltage)) in the hose will decrease as will the water flow (current flow (amperage)) through no change in the resistance will occur. The mathematical relationship between these three fundamental electrical quantities (applied to circuits containing only resistive elements (i.e. no coils)) is one of the most important, basic laws of electricity and is known as Ohms law (Eq. 20.3)

$$V = I \times R \quad [20.3]$$

where, V is the voltage (volts), I is the amperage (amperes) and R is the resistance (ohms ( $\Omega$ )).

#### 3.2 Mechanism of Ohmic Heating

To ohmically heat a material, it must be capable of conducting an electrical current. For a material to be classified as a conductor, electrical charges must be able to move from one

point to another within it to complete an electrical circuit (Brady and Humiston, 1986). Meat and meat products, although generally containing relatively high levels of water (Chan *et al.*, 1995; Chan *et al.*, 1996), are regarded as solid materials. When it comes to conducting electricity, solids such as metals generally display metallic conduction as a result of the relatively free movement of electrons through metallic lattices. Meats, on the other hand behave like electrolytic solutions, conducting electricity through electrolytic conduction. A description of ion flow in an electrolytic cell connected to a DC source can be found in any basic electrochemistry textbook. When an electrolytic solution is placed in contact with a pair of electrodes to which a DC source is connected, mobile positive ions present in the product (e.g.  $\text{Na}^+$ ) migrate towards the negative electrode (cathode) and mobile negative ions (e.g.  $\text{Cl}^-$ ) move toward the positive electrode (anode). At the negative electrode (which has an excess of electrons), the positive ions pick up electrons and are reduced, whereas at the positive electrode (which has a deficiency of electrons) the negative ions give up electrons and are oxidized. If the current supply used in ohmic heating was DC, electrode polarization would rapidly occur. Therefore to prevent this AC current is used, as the cyclic change (generally low frequency 50 Hz in Europe or 60 Hz in USA) in current direction allows insufficient time for appreciable polarization to occur as the electrochemical reactions described above are considered undesirable in ohmic heating. As a further preventative measure against their occurrence, electrodes are often constructed from titanium or titanium coated with colloidal deposits of “platinum black” to facilitate the adsorption of the extremely small quantities of electrode reaction products. In addition recent work by Samaranayake *et al.* (2005) has shown that further reductions in electrochemical reactions in stainless steel, titanium and platinized-titanium electrodes can be achieved by changing the pulse characteristics from traditional 60 Hz sine wave pulses to bipolar pulses of 10 or 4 kHz. The effect of differing pulse width and delay times was also discussed in this paper.

When a meat product conducts electricity by electrolytic conduction the moving ions within it collide with other molecules and these collisions lead to momentum transfer to these molecules, which in turn increases their kinetic energy thereby heating the product. De Alwis *et al.* (1989) state that the interaction between the local field strength and local electrical conductivity will govern the local heat generation rate (Eq. 20.4)

$$Q = E^2 k = \lambda J^2 \quad [20.4]$$

where  $Q$  is the heat generation rate per unit volume ( $\text{W m}^{-3}$ ),  $E$  is the electrical field strength ( $\text{V cm}^{-1}$ ),  $k$  is the electrical conductivity ( $\text{S m}^{-1}$ ),  $\lambda$  is the resistivity ( $\Omega \text{ m}$ ) and  $J$  is the current density ( $\text{A m}^{-2}$ ). The actual heating rate for the substance can then be calculated from Eq. 20.5 (De Alwis and Fryer, 1990)

$$\frac{dT}{dt} = \frac{Q}{\rho C} \quad [20.5]$$

where,  $\rho$  is the density ( $\text{kg m}^3$ ) and  $C$  is the specific heat capacity ( $\text{kJ kg}^{-1} \text{ }^\circ\text{C}^{-1}$ ).  $\rho C$  is often referred to as the volumetric heat capacity (i.e. the amount of heat energy that is required to raise the temperature of one cubic meter of the substance by  $1^\circ\text{C}$ ). Eq. 20.5 shows that a high  $Q$  does not guarantee a rapid rate of temperature rise, which is also dependent on  $\rho C$ .

### 3.3 Factors Influencing Heat Generation Rate

#### 3.3.1 Electrical Field Strength

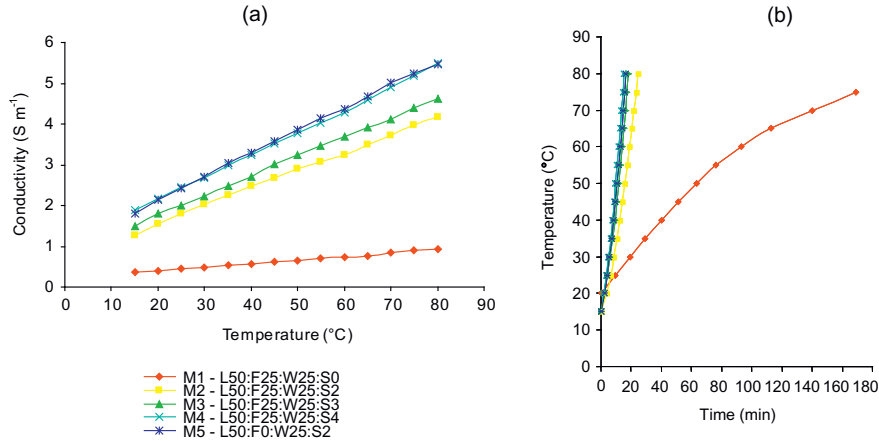
The electrical field strength can be varied by adjusting the gap between the electrodes or by changing the applied voltage.

#### 3.3.2 Electrical Conductivity

De Alwis *et al.* (1989) stated that the electrical conductivity of a product determines its suitability for ohmic heating. Piette *et al.* (2001) claimed that it is theoretically possible to provide any food with enough ohmic power to generate a target temperature rise. However, this will require using increasingly large current densities or increasingly large electrical field strengths when electrical conductivity values become very large or very small respectively (Eq. 20.4). However, these workers also state that in reality various considerations related to safety, cost, and product quality limit the extents of electrical field strength and current density that can be used in practice. Overall these workers suggest that ohmic heating is only possible between a certain range of electrical conductivity values ( $0.01 \text{ S m}^{-1}$  and  $10 \text{ S m}^{-1}$ ) and that it works optimally in the range of  $0.1$  to  $5 \text{ S m}^{-1}$ .

##### 3.3.2.1 Temperature vs. Electrical Conductivity

The electrical conductivity of food products generally increases with temperature and it is believed that this increase is mainly because of increased ionic mobility (Parrott, 1992). Shirsat *et al.* (2004b) showed that the conductivity of model and commercial meat batters increased with temperature across a range  $15\text{--}80^\circ\text{C}$  (Figure 20.1(a)). A similar effect of temperature on electrical conductivity was also illustrated by Piette *et al.* (2004). Bozkurt and Icier (2010a) also found an increase in  $\sigma$  of minced beef fat blends (containing 2%, 9%, 15%, and 90% fat) with increasing temperature, but only up to a “critical” initial cooking temperature ( $60\text{--}70^\circ\text{C}$  depending on fat content) above which either a plateau or decline in conductivity was noted. Sarang *et al.* (2008) measured the  $\sigma$  of a range of chicken, pork, and beef meats (with fibers oriented perpendicular to the electric field) across a temperature range  $25\text{--}140^\circ\text{C}$  and reported a linear increase in conductivity with temperature during ohmic heating at a



**Figure 20.1** Ohmic heating (constant voltage density of  $4\ V\ cm^{-1}$ ) of model meat formulations (M1–M5) containing different proportions of Lean muscle (L) Fat (F) Water (W) and Salt (S). (a) Effect of temperature on conductivity, (b) time temperature cooking profile. (From Shirsat et al., 2004b)

constant voltage gradient. Zell et al. (2009b) also found a linear increase in the  $\sigma$  of a range of lean meats (chicken, turkey, pork, beef, and lamb) across a temperature range 5–85°C. Both of the latter research teams noted that chicken breast had the highest  $\sigma$  of the meat species examined. This phenomenon of increasing conductivity with increasing temperature is often factored into the design of continuous ohmic heaters for pumpable fluids. In these heaters which have multiple heating sections, the spacing between electrodes is often increased towards the outlet to ensure that each heating section has the same electrical impedance.

### 3.3.2.2 Product Formulation vs. Conductivity

Meat products are generally formulated to contain meat and non-meat ingredients. It is through this blend that the electrical current flows during ohmic heating.

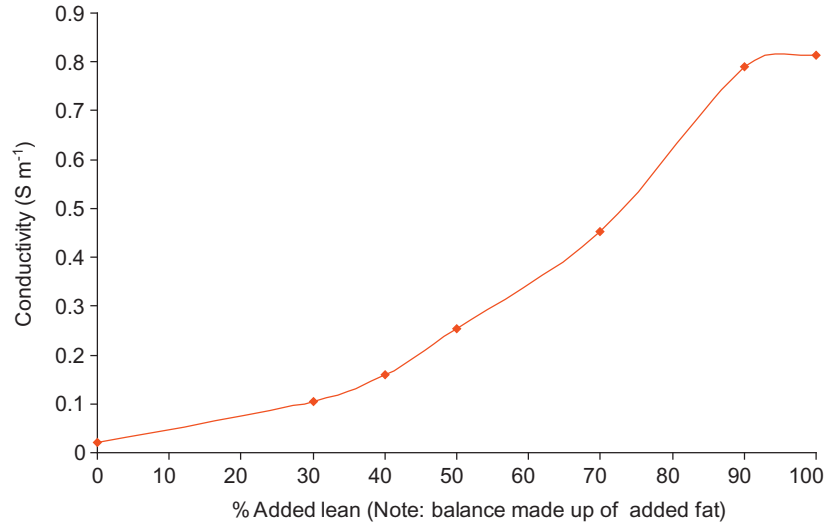
**3.3.2.2.1 Meat Ingredients** Compared to fat, lean has a much higher electrical conductivity with Shirsat et al. (2004a) showing lean pork to fall in the conductivity range 0.64–0.86 ( $S\ m^{-1}$ ). However, non-comminuted lean meat is a complex structure consisting of muscle fibers, connective tissue with a certain amount of intramuscular fat (marbling) also occurring within the tissue. The diversity and complexity of components in the muscle fiber coupled with the involvement of some of these entities in muscle contraction and the integration of connective tissue throughout the muscle make it difficult to precisely visualize the passage of electrical current through lean meat during ohmic heating. The following section briefly overviews these components.

**Muscle Fibers:** Muscle cells or fibers are generally 10–100  $\mu\text{m}$  in diameter (Honikel, 1992) but can vary in length from a few millimeters to tens of centimeters or more (Gault 1993; Skaara and Regenstein, 1990). The muscle cell has the following components:

1. The sarcolemma, a thin double layered (Lawrie, 1985) outer membrane of the muscle fiber lying inside the endomysium (Asghar and Pearson, 1980). It is through this outer membrane that the nerve impulses for muscle contraction are transmitted (Gault, 1993).
2. The sarcoplasm is the cytoplasm of the muscle fiber and contains organelles (mitochondrion, lysosomes, nuclei, golgi apparatus, sarcoplasmic reticulum, ribosomes, fibroblasts, etc.), enzymes, and other substances (i.e. glycogen and lipid droplets) essential for normal metabolic activities of the muscle cell (Asghar and Pearson, 1980).
3. The sarcoplasmic reticulum, together with the T-tubules (a system which transmits the excitatory impulse on contraction) controls muscle contraction and relaxation (Lawrie, 1985) in living tissue. Contraction of muscle occurs as a result of depolarization of the sarcoplasmic reticulum (via the T-tubules). This results in an increase in the sarcoplasmic concentration of free calcium ions. The sarcoplasmic reticulum reabsorbs these ions during relaxation (Gault, 1992).
4. The sarcolemmal cytoskeletal proteins, for the purpose of this chapter will not include the proteins of the entire cytoskeletal network. The cytoskeleton protein filament system consists of intracellular structures that hold the contractile apparatus in register (Gault, 1993), maintain cell structure, interconnect organelles, and often attach to the cell membrane (Greaser, 1991).
5. The myofibrillar proteins or contractile apparatus occupy approximately 80% of the muscle cell volume and run the entire length of the cell (Gault, 1992). There may be as many as 1,000 of these 1–2  $\mu\text{m}$  diameter myofibrils in a cross-section of a muscle fiber (Greaser, 1991).

**Connective Tissue:** Muscle connective tissue comprises fibrous proteins collagen, elastin, and reticulin (Pearson and Young, 1989), ground substance, and cells (Asghar and Pearson, 1980). Muscular connective tissue may be subdivided into the endo-, peri-, and epi-mysium depending on its location within the muscle. The endomysium is a layer which surrounds individual muscle cells, which in turn are grouped into bundles surrounded by connective tissue known as the perimysium. These bundles of cells together form the muscle that is itself surrounded by an outer layer known as the epimysium (Light *et al.*, 1984).

**Fat:** Shirsat *et al.* (2004a,b) showed that electrical conductivity of pork fat is very low (0.01–0.09  $\text{S m}^{-1}$ ). In the preparation of some meat products, fat trimmings are added to lean to form a blend. Shirsat *et al.* (2004a) presented a graph (Figure 20.2) showing the effect of added fat (0–100%) on the conductivity of a lean-fat blend.



**Figure 20.2** Effect of added fat (0–100%) on the conductivity of a lean–fat blend. (From Shirsat et al., 2004a)

This graph shows the poorly conductive nature of fat and the conductivity of lean minced muscle (Figure 20.2). However, the relationship between fat content and conductivity appears asymptotic rather than linear. As the percentage of fat in lean was reduced, the conductivity of lean increased until the level of fat (<10%) had a limited effect on the conductivity of the mixture. These workers suggested that the addition of fat to lean could possibly influence the conductivity of the mixture in two ways: 1. reduction because of the fat itself and its poor conductivity, 2. coating of lean particles with fat thereby creating a barrier for the passage of electrical current.

**3.3.2.2.2 Non-Meat Ingredients** Although lean and fat meats are principle ingredients in processed meat products, other non-meat ingredients are usually incorporated which have various functions. Examples of such ingredients include salt (flavor, water binding, and preservation), seasoning (flavor), nitrates and nitrites (color and antimicrobial), proteins (increase nutritional value and gelation aid), bulking agents such as starch, and artificial colorings. If the addition of these ingredients to the product increases the amount of mobile ions in the product (i.e. the ingredients are electrolytic), the electrical conductivity will increase which in turn will increase the rate of ohmic heating. A relative ranking of non-meat ingredients in terms of their electrolytic capacity was presented by Lyng et al. (2005). In this study, 5% aqueous solutions/suspensions of non-meat ingredients were prepared and their dielectric properties at 27.12 MHz were subsequently measured. Although dielectric properties are used in the context of microwave and radiofrequency heating, the dielectric loss

factor ( $\epsilon''$ ) has some relevance in this context as its magnitude is related to the availability of ions. These workers found non-meat ingredients such as deionized water, sucrose, and starch had extremely low  $\epsilon''$  values, while at the other end of the scale solutions containing nitrate, nitrite, and salt had  $\epsilon''$  values which were up to four orders of magnitude higher than deionized water. Relative to the  $\epsilon''$  of lean meats, Lyng *et al.* (2005) subdivided the measured samples into two groups, one of which had lower  $\epsilon''$  values than lean and the other which had higher  $\epsilon''$  values than lean.

**3.3.2.2.3 Blends of Lean Fat and Non-Meat Ingredients** To further study the effects of salt and fat on conductivity and ohmic heating times, a number of model meat emulsion formulations with different salt levels and also a formulation with no added fat, were prepared by Shirsat *et al.* (2004b) using shoulder lean and back fat. Results indicated that salt or other electrolytic ingredients were essential for ohmic heating, and for a given batter an increase in salt content increased electrical conductivity and increased ohmic heating rate ( $P < 0.001$ ) (see Figure 20.1). In relation to fat Shirsat *et al.* (2004b) also noted an increase in fat content caused a reduction in conductivity ( $P < 0.001$ ) leading to an increase in ohmic heating time ( $P < 0.001$ ). Piette *et al.* (2004) also reported that increasing salt content (1–2.5%) in pseudo ham resulted in a linear increase in electrical conductivity while increasing fat content (10–30%) in bologna sausages lead to a linear decrease in electrical conductivity.

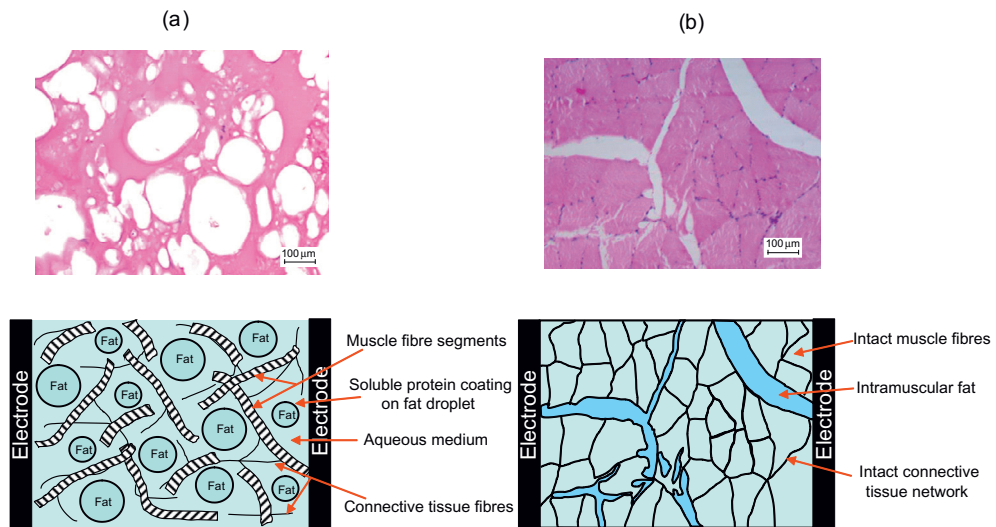
**3.3.2.2.4 Distribution of Non-Meat Ingredients within a Meat Product** Non-meat ingredients are generally added to comminuted meat batters during a bowl chopping procedure. Uneven distribution of ionic non-meat ingredients (e.g. salt, phosphate, nitrate, etc.) through a product could lead to uneven ohmic heating, and therefore care should be taken to ensure that bowl chopping procedures are of sufficient duration and intensity to thoroughly blend these ingredients throughout the batter. For non-comminuted products such as ham, non-meat ingredients are incorporated into a brine which is normally injected into the product using a multi-needle injector. This brine is further distributed throughout the product during a tumbling procedure. Similar to bowl chopping, care should be taken to ensure that injection and tumbling procedures are sufficient to ensure a uniform distribution of ionic non-meat ingredients through the product.

### 3.3.2.3 Size reduction vs. Electrical Conductivity

In the manufacture of meat and meat products the extent of size reduction varies from highly comminuted meat emulsions (e.g. frankfurter and luncheon roll batters) to minced products to non-comminuted products (e.g. selected ham and beef products).

**3.3.2.3.1 Highly Comminuted Meat Emulsion Products** The majority of the in depth studies on ohmic heating of meat conducted to date have focused on highly comminuted meats and meat emulsions. The manufacture of such products involves breaking down the connective tissue, myofibrillar, and intramuscular fat networks of entire meat during extensive bowl chopping. As a result, the microstructure of meat emulsions is relatively homogenous and consists of fat droplets coated with soluble proteins (emulsifying agents) suspended in an aqueous medium containing soluble proteins, segments of myofibrils, connective tissue fibers, and other soluble muscle constituent (Forrest *et al.*, 1975) (Figure 20.3(a)). In addition, these products are formulated to include a range of non-meat ingredients (e.g. salt, starch, seasoning, etc.) some of which are ionic in nature. When an alternating current is applied to such a matrix in an ohmic heater, it is most likely that dissociated ions will oscillate back and forth within the aqueous medium at 50–60 Hz leading to heating of the product. Fat which is a poor conductor has been reduced in size and therefore the current can easily flow around the dispersed fat globules.

**3.3.2.3.2 Non-Comminuted Meat** In contrast the structure of entire meat is considerably more complex (Section 3.3.2.2.1) as the muscle fiber and connective tissue (epimysium, perimysium, and endomysium) structures are still intact and there will be a certain amount of intramuscular fat (marbling) within the tissue (Figure 20.3(b)). To further complicate matters, many muscles fibers change direction



**Figure 20.3** Images (Shirsat *et al.*, 2004a,d) and schematic diagrams showing the microstructure of (a) highly comminuted meat emulsion (note schematic adapted from Forrest *et al.*, 1975), and (b) entire meat in contact with a pair of electrodes.



along the length of the muscle. As a result the potential pathways for the passage of electrical current will be considerably more complex and non-conductive fat deposits are potentially larger providing greater obstacles to current flow. In emulsions directionality is not really a major issue as a result of the homogeneity of the structure but in entire meats, the relative positioning of electrodes parallel or perpendicular to myofibrillar and connective tissue structure could provide very different pathways for the movement of ions within the product.

**3.3.2.3.3 Minced Meat** Mincing, although less severe than bowl chopping, also disrupts the connective tissue and cellular structure of meat and [Shirsat \*et al.\* \(2004a\)](#) suggested different effects of mincing on the conductivities of lean vs. fat. Minced lean had higher electrical conductivity compared to its non-minced counterpart and a possible explanation given for this increase was the release of moisture and inorganic constituents from myofibrillar tissue on mincing. In contrast, [Shirsat \*et al.\* \(2004a\)](#) found that conductivities of minced fat were lower than entire fat. As these workers took measures to minimize air incorporation into sample material, they suggested that disruption of the connective tissue network running through the fat (which could have provided a pathway for a small amount of current to flow) could have contributed to the observed changes.

#### 3.3.2.4 Anatomical Location vs. Electrical Conductivity

In addition to the points raised in [Section 3.3.2.2](#), [Shirsat \*et al.\* \(2004a\)](#) suggested that anatomical location of a muscle could also influence its electrical conductivity. These workers found that the conductivity of non-comminuted leg lean was significantly ( $P < 0.01$ ) higher than shoulder lean (0.75 vs. 0.64 S m<sup>-1</sup>). Following an examination of samples using light microscopy, [Shirsat \*et al.\* \(2004a\)](#) suggested this difference could be because of a denser muscle fiber structure, greater amounts of connective tissue and/or higher intra-muscular fat in shoulder vs. leg.

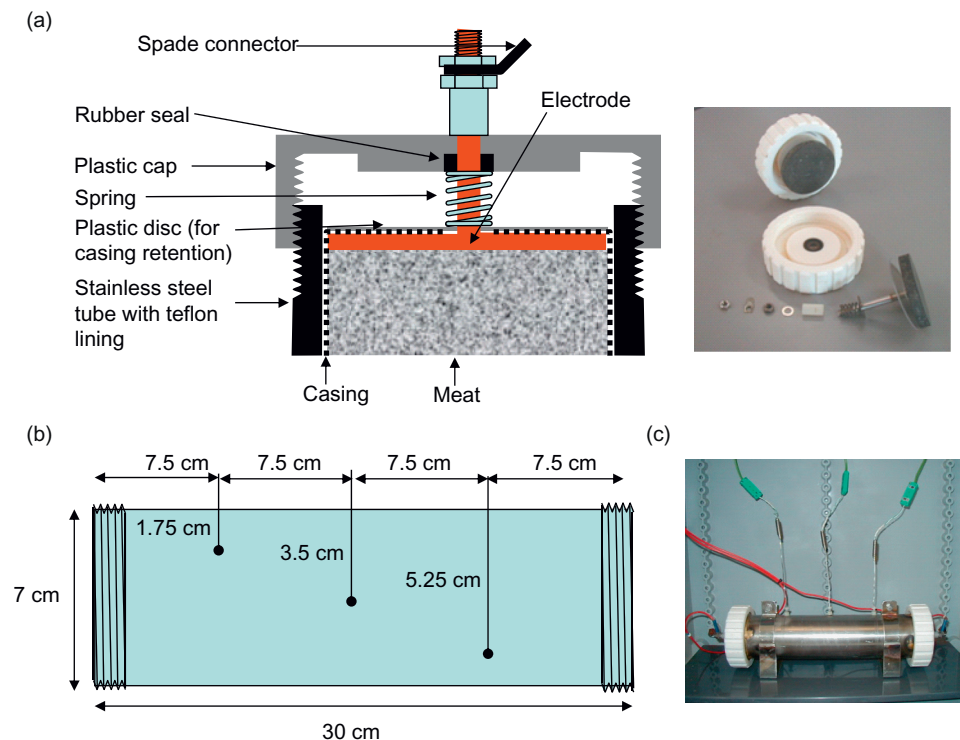
## 4. MICROBIAL INACTIVATION DURING OHMIC HEATING

The literature on ohmic heating suggests that inactivation of microorganisms occurs primarily via thermal methods ([Aymerich \*et al.\* 2008](#); [Biss \*et al.\*, 1989](#); [Skudder, 1989](#)). However, two other mechanisms, namely mechanical and chemical effects have been suggested. In the mechanical effects death of microbes occurs as a result of membrane damage, leading to leakage of cellular contents ([Shimida and Shimahara, 1985](#)). Chemical effects involve the formation of free oxygen and hydrogen, hydroxyl and hydroperoxyl radicals and metal ions, which were found to cause bacterial death ([Gilliland and Speck, 1967a,b](#); [Martin, 1960](#)). The early literature investigating the non-thermal effects of ohmic heating, found evidence for such an effect to be

inconclusive because the thermal effects were not fully eliminated (Palaniappan *et al.*, 1990). Palaniappan and Sastry (1992) found no difference between the effects of ohmic and conventional heat treatments on the death kinetics of yeast cells. However, more recent studies on ohmic heating, where the thermal effects were eliminated, indicate the possibility of a mild electroporation (Cho *et al.*, 1999; Fox *et al.*, 2008), similar to high voltage pulses (Grahl and Maerkl, 1996), as an additional mechanism for microbial inactivation (Sastry and Barach, 2000). Electroporation is a low frequency (50–60 Hz) phenomenon in which cell walls are allowed to build up charges and form pores (Sastry and Barach, 2000). In contrast, heating at high frequency (microwave and radio frequency) causes rapid changes in polarity, thus preventing the building of the charges at the cell walls (Sastry and Barach, 2000). The effects of sublethal electrical treatment have been shown to reduce the subsequent thermal treatment for the inactivation of microorganisms (Palaniappan *et al.*, 1990) and decreased the lag period in a fermentation involving lactic acid bacterium (Cho *et al.*, 1996). Methods for microbial validation of ohmic processing have been described in the literature (Betts and Gaze, 1992; Cho *et al.*, 1999; Kim *et al.*, 1996; Parrott, 1992). Mitelut *et al.* (2011) provide the most recent study on microbial inactivation under ohmic heating and, although a comparison is made between unheated and ohmically heated samples, no comparison appears to have been made to a conventionally heated control.

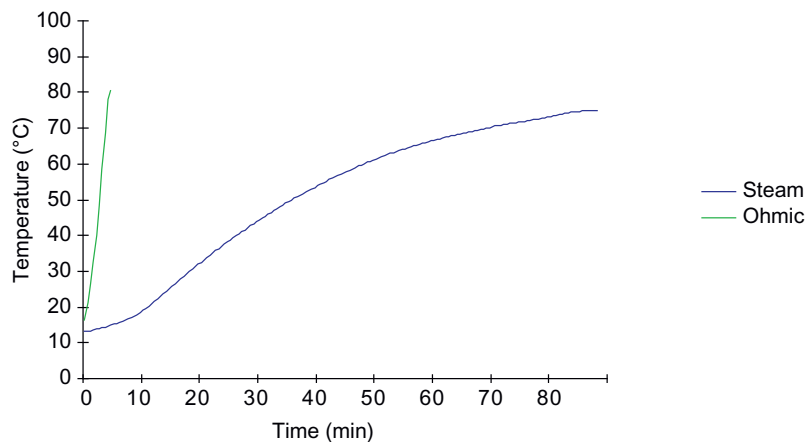
## 5. QUALITY OF OHMICALLY HEATED MEAT PRODUCTS

Piette *et al.* (2004) and Shirsat *et al.* (2004c) compare the quality of ohmically heated comminuted meat products to conventionally cooked products. Batch ohmic heating cells were used in both studies and an illustration of the system used by Shirsat *et al.* (2004c) is given in Figure 20.4(a–c). Sample sizes were of similar order of magnitude in both studies (i.e. 1 kg), although product formulations varied from a frankfurter style meat batter (Shirsat *et al.*, 2004c) to a bologna sausage and a model ham (Piette *et al.*, 2004). The steam and ohmic cooking treatments used in these studies were broadly similar, although not directly comparable. Shirsat *et al.* (2004c) steam or ohmically cooked (at voltage densities ranging from 3 to 7 V cm<sup>-1</sup>) to standardized cook values (C<sub>s</sub>) or to target end point temperatures. Piette *et al.* (2004) steam cooked bologna samples to an end point temperature of 70°C. These workers ohmically cooked bologna to a range of target end point temperatures (70°C, 75°C, and 80°C) at a fixed voltage density (3.5 V cm<sup>-1</sup>), and also ohmically cooked to a fixed target temperature (70°C) but varied voltage density (2.9, 3.5, and 4.7 V cm<sup>-1</sup>). In addition, these workers cooked a homogenized model ham to 70°C at constant voltage densities of 2.3 and 4.5 V cm<sup>-1</sup>, but subsequently held these samples at 70°C for 20 min. In both studies higher ohmic voltage densities produced faster heating rates.



**Figure 20.4** (a) Diagram and image of the meat cell lid showing casing sealing mechanism and electrodes (from [Shirsat \*et al.\*, 2004c](#)). (b) Stainless steel teflon lined tube showing thermocouple positioning ([Shirsat \*et al.\*, 2004c](#)). (c) Cell in safety cabinet with thermocouples in position ([Shirsat \*et al.\*, 2004c](#)).

Texture Profile Analysis (TPA) of ohmic and steam cooked frankfurter batter by [Shirsat \*et al.\* \(2004c\)](#), showed no significant difference ( $P \geq 0.05$ ) in any of the attributes assessed (hardness (1 and 2), energy (1 and 2), cohesion energy, gumminess, and chewiness) with the exception of springiness, which was significantly lower ( $P < 0.05$ ) in ohmically cooked samples heated to similar cook values, although this trend was less pronounced in samples cooked to similar end point temperatures. Sensory analysis on ohmic and steam cooked samples cooked to similar end point temperatures supported these observations with regard to texture. In contrast, [Piette \*et al.\* \(2004\)](#) presented partial results of bologna TPA and found conventionally cooked samples to have higher hardness, cohesive, and more resilience (with no significant difference in springiness), although units for expressing cohesiveness, resilience, and springiness differ between these papers. Although these workers did not conduct formal sensory analysis, they made the observation that untrained laboratory



**Figure 20.5** Time vs. temperature profile for steam and ohmically ( $5 \text{ V cm}^{-1}$ ) cooked 1 kg meat emulsions.

personnel constantly referred to ohmically cooked samples as being softer than conventionally cooked, although also noted that these personnel did not find the ohmically heated bologna samples unpleasant. However, [Piette \*et al.\* \(2004\)](#) found no significant difference in TPA attributes of ohmically heated model hams. [Bozkurt and Icier \(2010b\)](#) found ohmically cooked ( $20\text{--}40 \text{ V cm}^{-1}$ ) ground beef (containing 2–15% fat) was firmer than conventionally cooked samples, had similar fat retention and yield, although the volume reduction was less in ohmic compared to conventional samples.

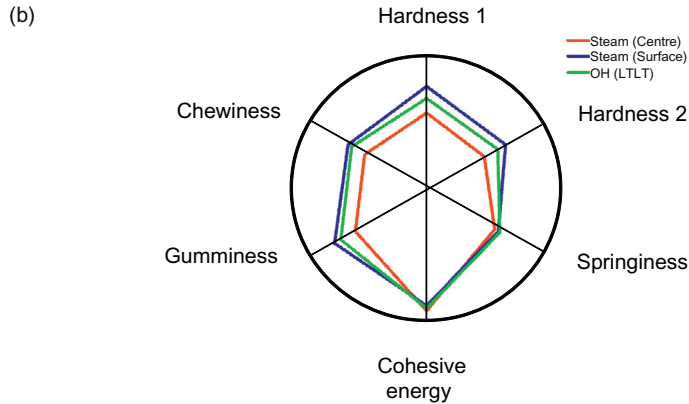
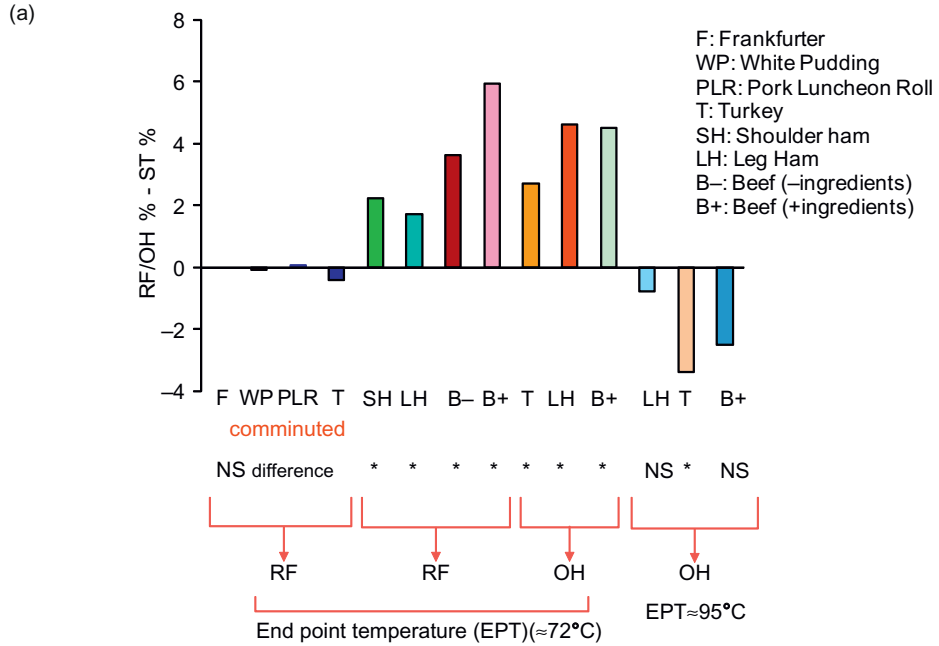
Instrumental color evaluations by [Shirsat \*et al.\* \(2004c\)](#) revealed that ohmically cooked samples (cooked both to similar cook values and end point temperatures) differed from steam cooked in both  $a^*$  and hue angle values ( $P < 0.05$ ), with these differences being less pronounced in samples cooked to similar cook values. [Piette \*et al.\* \(2004\)](#) presented  $L^*$ ,  $a^*$ , and  $b^*$  values (but gave no results for hue angle or saturation) and also found significant differences ( $P < 0.05$ ) in color attributes ( $L$  and  $a^*$  values) between ohmic and conventionally cooked bologna and model ham samples, although these workers noted that these differences were small and not likely to be detected by consumers. Overall, both papers acknowledge that subtle differences in quality could be observed in some instances in the products examined, although both come to a broadly similar conclusion that ohmic heating has the potential to produce these products with comparable quality to conventionally cooked samples.

The work above was all performed on comminuted meats. The most comprehensive studies on non-comminuted samples were performed by [Zell \*et al.\* \(2010a,b, 2012\)](#) using an optimized ohmic/convection heat system (described in [Section 7.4](#))

and preparation protocols (described by Zell *et al.* (2009c)). Three product types (beef, turkey, and ham) were cooked by ohmic or conventional (steam) methods and were compared in terms of their yield (Section 6.2) and quality attributes using instrumental and sensory analysis. Heat processing times were reduced by a factor of approximately 7 using a “low temperature long time” protocol (LTLT, up to 72°C with a maximum holding time of up to 15 min) or a factor of 15 using a “high temperature short time” protocol (HTST up to 95°C with a maximum time of up to 7–8 min), compared to the control. Texture analysis of ohmic and steam cooked beef products, showed no significant differences ( $P \geq 0.05$ ) in any of the attributes assessed with the exception of the HTST treated turkey, which was significantly higher ( $p < 0.05$ ) in all TPA attributes with the exception of cohesiveness although this was most likely because of chemical changes induced by the higher temperatures encountered under HTST (i.e. 95°C) rather than the actual heating method. An interesting finding was that when a comparison of the textural attributes of the edge vs. centre of turkey products was made, the conventional steam cooked samples were quite different in texture between surface and center (Figure 20.6(b)) (most likely because of overheating the surface regions for longer times while waiting for the center to reach pasteurization temperatures), whereas the ohmically processed samples showed no difference between surface and center (most likely because of the greater uniformity of heating).

Instrumental color evaluations found that ohmically cooked samples had a more uniform color with higher Hunter L-surface values indicating a lighter colored product. Although sensory evaluation revealed differences in selected texture and color attributes, it was unable to distinguish between steam and ohmically cooked samples ( $P < 0.05$ ) in terms of overall acceptability. For ham products, significant color differences were found, with ohmic LTLT cooked hams showing lower Hunter a-values. This was attributed to the less severe thermal treatment involved, which could have had a negative impact on the chemistry of nitrite mediated color development. However, although some quality attributes were slightly different between ohmic and steam cooked meats, these differences were unlikely to be of such magnitude as to affect consumer perception of ohmically cooked meat products. These results demonstrate that there is considerable potential for ohmic heating in the production of high quality cooked non-comminuted meat products.

In terms of flavor, various analyses including GC and Tbars were conducted on some products (Lyng *et al.* 2009). Some differences were noted, although they were very slight and unlikely to have an impact on sensory perception. Rates of oxidation in beef and turkey were slightly less in RF compared to steam cooked but this difference was so small that it was unlikely to be detected by sensory analysis. No major qualitative differences were noted in sulfur volatiles in RF vs. steam cooked samples.



**Figure 20.6** (a) A comparison of cook yield (%) difference between meats pasteurized by rapid (ohmic (OH) or radio frequency (RF)) and conventional steam (ST) cooking methods (Lyng *et al.*, 2009). (b) A comparison of textural attributes of edge vs. center of turkey samples cooked conventionally vs. ohmically heated (OH) (Zell *et al.*, 2010b).

## 6. ECONOMICS OF OHMIC PROCESSING

Innovation both in terms of new products and also in terms of alternative processing techniques, will be required if the food industry is to remain profitable and prosper in

increasingly competitive market conditions. Ohmic pasteurization offers potential economic and practical benefits to the meat industry which could possibly include increased energy efficiencies, increased throughput, potential for continuous vs. batch process, and improved product yield.

## 6.1 Power Consumption

The basic energy balance equation governing pasteurization is given in Eq. 20.6.

$$P\psi = \frac{mC(\Delta T)}{t_p} = \frac{H}{T} \quad [20.6]$$

where,  $P$  = power consumption of cooker (kW);  $\psi$  = efficiency of cooker;  $m$  = mass of meat (kg);  $\Delta T$  = temperature rise in meat during cooking ( $^{\circ}\text{C}$ );  $H$  = energy required to cook the meat (kJ); and  $C$  and  $t_p$  are as previously defined. Both conventional and ohmic pasteurization require the same energy input to heat a certain mass of product. However, ohmic heating is generally regarded as being a more efficient power source than conventional methods with energy efficiencies of greater than 90% being reported (De Halleux *et al.*, 2005). Therefore all things being equal, ohmic heating will require less power input than conventional cooking for a given temperature rise. It has been reported that ohmic cooking can reduce energy consumption by 82–97% compared to conventional smokehouse cooking (De Halleux *et al.*, 2005) while meeting the minimum specifications necessary for pasteurization. In addition to improved energy efficiencies, the potential for increased throughput and reduced  $t_p$  is illustrated in Figure 20.5, which shows the substantial reduction in time taken to reach pasteurization temperatures in meat emulsion samples.

## 6.2 Product Yield

Product yield is a key commercial consideration. Figure 20.6(a) summarizes a comparison of yield between meats cooked by rapid (ohmic or radio frequency) vs. conventional methods (Lyng *et al.* 2009). In comminuted products no differences ( $P \geq 0.05$ ) were noted between the yield of rapid vs. conventionally pasteurized samples. However, for the non-comminuted products the more rapid heating obtained under radio frequency or ohmic heating conditions, consistently gave higher yields than steam cooking. As products cook, proteins such as myosin and collagen denature and lose water. The observed result may be indicative of less heat induced protein denaturation (and associated water loss) in the more rapidly heated ohmically cooked products, which manifests in higher yield. An analysis of composition data (Lyng *et al.*, 2009) indicated that rapidly cooked samples have higher moisture content and lower protein and fat contents (the latter suggestive of a dilution effect), which appears to be consistent with yield results and the theory outlined above.

## 7. OHMIC HEATING FOR COMMERCIAL SCALE PRODUCTION OF COOKED MEATS

### 7.1 Ohmic Heater Control Options

#### 7.1.1 Control of Electricity Supply during Ohmic Heating

*Piette et al. (2004)* describe a number of electricity control options for ohmic heaters.

1. *Constant voltage*: Ohmic heaters controlled in this way will show an increase in current intensity as product temperature (and therefore conductivity (Section 3.3.2.1)) increases. Such heaters will display an increase in heating rate during the cook cycle. This option is the simplest, but results in most of the cooking being done below optimal conditions because the chosen voltage must be limited to avoid excessive current density values towards the end of the cook cycle.
2. *Constant current intensity*: Operating ohmic heaters in this manner means less voltage is required as cooking progresses, which in turn results in a decrease in power supply and heating rate with time.
3. *Constant power*: Ohmic cooking at a constant power results in a virtually constant heating rate, although a slight increase in specific heat capacity with temperature may lead to a slight decrease in heating rate between the start and end of cooking. However, this requires more sophisticated feedback control because voltage and current intensity will vary with time.

#### 7.1.2 Control of the Extent of Pasteurization/Cooking

The safety and shelf-life of an ohmically heated product depends on the delivery of sufficient pasteurization units, while the quality will depend on the extent of heat induced chemical changes quantified by the cook value. Pasteurization units and cook values cumulatively increase throughout the heating and cooling phases of cooked meat production. However, the shape of the time temperature profiles during heating will differ substantially between conventional and ohmically heated products. Conventional cooking is characterized by a sigmoid shaped temperature profile which has an initial settling down period, followed by a period where a relatively linear temperature rise occurs, and ending with a final phase where rate of temperature increase declines. In commercial pasteurization of cooked meats, processors generally heat the cold spot in the product in excess of a target temperature for a specified time (e.g.  $\geq 70^{\circ}\text{C}$  for 2 min or equivalent). In contrast, because of its volumetric nature, ohmic heating is generally characterized by a relatively linear increase in product temperature during cooking. In Section 2 it was stated that an ohmic heating process must produce a cooked pasteurized meat product. Semi-continuous systems (Section 7.3) would lend themselves to very precise control in this regard, in that continuous feedback of cook value and/or pasteurization units could be sent to a PLC controller, which could be programmed to release products on reaching a target pasteurization



unit/cook value. Alternatively, ohmic heating could be used to preheat the product to a target temperature, before releasing the product into a chamber which would hold the product at this temperature for sufficient time to pasteurize and cook the product.

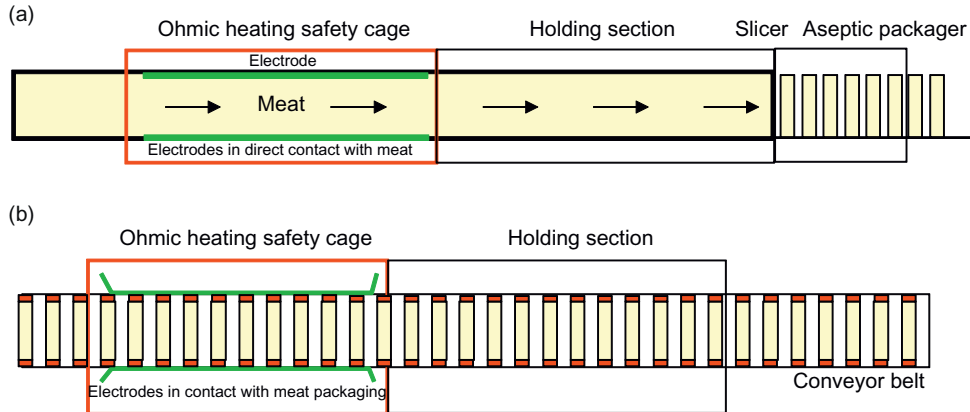
## 7.2 Packaging for Ohmic Processing

In commercial production of cooked meats the majority of products are traditionally packaged in sealed casings or vacuum package bags prior to cooking. Packaging products in this way has the advantage of preventing post-process contamination of the pasteurized product following cooking. Ohmic is a direct electroheating method which means if a product is to be processed in a package, conductive regions (which could be placed in contact with a series of electrodes) will be required in the packaging to allow current to flow through the product. Nowadays, with the advances in packaging including the development of conductive polymers, there is the possibility of low cost in-container ohmic processing systems, which would not have a requirement for aseptic conditions. Such packaging would substantially reduce the initial capital outlay, associated with these systems. Recent work by [Jun and Sastry \(2005\)](#) modeled temperature distribution in chicken noodle soup and black beans reheated within a flexible packaging with integrated foil electrodes. However, further feasibility and development work is needed before this could be considered for commercial application.

## 7.3 Possible Methods for Commercial Application of Ohmic Heating to Meat

Depending on whether the product is packaged or unpackaged, there are a number of possible methods for ohmically heating meats:

1. Product is left unpackaged and is ohmically pasteurized while being continuously pumped through a tube fitted with a series of electrodes before being cooled and subsequently aseptically packaged ([Figure 20.7\(a\)](#)). This is the traditional method of ohmically heating pumpable liquids on a continuous basis. However, of the three options this is the least likely for processing meat as it:
  - a. Will most likely be costly in terms of the initial purchase of equipment compared to conventional methods.
  - b. Requires operators with higher skill levels to operate the aseptic packaging equipment.
  - c. Could give rise to quality concerns as meat is traditionally cooked in a static state and continuous movement during cooking may give rise to separation within the product as fat melts and protein denatures while movement during cooling may affect gelation.



**Figure 20.7** (a) Illustration of a continuous flow ohmic heater for meat products. (b) Illustration of a continuous ohmic heater for meat products packaged in containers with conductive regions.

- d. Could give rise to pumping difficulties as cooling of meat (in which heat transfer will be primarily by conduction) will be by conventional methods which will require a long cooling tube, which in turn will take up a lot of floor space.
2. Product is packaged in special packaging which includes electrically conductive packaging regions. Electrical current is passed into the product as it passes through a continuous system similar to that described in [Figure 20.7\(b\)](#). This is certainly a possibility but:
  - a. Depends on the availability of suitable packaging at low cost.
  - b. Packaging design could be complex and may have to be designed on a product by product basis.
3. Product is partially packaged during ohmic pasteurization before being sealed under aseptic conditions following cooking. This system certainly has advantages as it could be applied in a continuous fashion similar to option 2 but:
  - a. Conventional packaging could be used.
  - b. Cost of creating aseptic conditions would be substantially reduced relative to full aseptic packaging required in option 1.

Greater control of cooking of each package could be achieved by applying options 2 and 3 above in a semi-continuous fashion where each package is ohmically heated individually and released on reaching a target temperature, pasteurization unit, or cook value.

## 7.4 Other Design Considerations

As discussed in [Section 2](#), heat process validation is essential to ensure consumer safety. As ohmic is a volumetric form of heating with heat generation taking place within

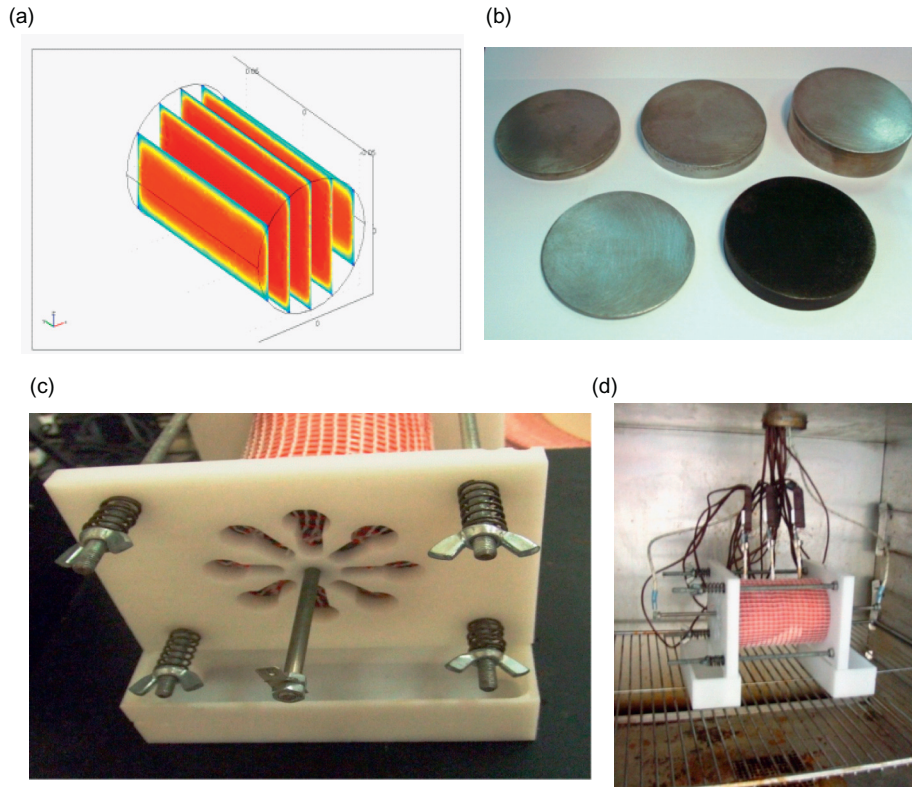
the product, the location of the cold spot is unlikely to be at the geometric center (as it would be under conventional heating) but could be found at outer surfaces and electrode contact points where heat losses from the product could occur. Much of the modeling which has been performed to date on ohmic heating focuses on liquids and solid–liquid mixtures. Although not carried out on meat products, a very relevant publication in the context of designing a system for ohmic processing of a solid such as meat is the work of [Marra \*et al.\* \(2009\)](#), who analyzed heat transfer during batch ohmic processing of reconstituted potato flakes. These workers found good correlation between experimental (temperatures measured at nine different locations) and model data and did not detect cold spots within the product. However, cold regions and heat losses were noted from the product in regions adjacent to the electrode and also the ohmic cell structure ([Figure 20.8\(a\)](#)).

Following on from this work, [Zell \*et al.\* \(2011\)](#) assessed a variety of methods that could be used to minimize such losses including reducing the thickness of electrodes, insulation of the cell body during heating or providing supplementary heat via a heating belt, panel, or eliminating the cell body and housing the product in a hot air cabinet. Various electrode materials and designs were also evaluated. Optimized conditions were found by combined ohmic/convection (80°C) heating, with the food stuff contained in a plastic casing pressurized between two spring loaded electrodes which were of minimal practicable thickness (1 mm) (as illustrated in [Figure 20.8 \(b–d\)](#)). Under these conditions a temperature variation of 12.1°C maximum overall was achieved within the product after 150s, which reduced to 8.6°C after 3 min standing time.

## 7.5 Other Potential Commercial Ohmic Heating Applications for Muscle Foods

### 7.5.1 Defrosting of Meat and Fish

Defrosting a product involves increasing its temperature from frozen storage temperatures to just below (i.e. tempering) or above (i.e. thawing) its freezing point. In commercial practice, conduction based systems are the most commonly used and involve the supply of heat to the outer product surfaces (via air, water, contact with a heated surface or condensing steam (vacuum–thawing)) with this heat then being transferred to the center of the product by conduction. However, a number of studies have evaluated the potential for ohmic defrosting of meats. One of the difficulties with using ohmic heating for defrosting is that for heat to generate, direct contact between electrodes and product surface must occur. However, the solid non-pliable nature of frozen foods could pose problems in this regard. [Yun \*et al.\* \(1998\)](#) integrated two electrodes into an immersion vessel with the aim of combining ohmic (0–210 V AC at frequencies between 60 Hz and 60 kHz) with conventional water immersion (10°C



**Figure 20.8** (a) Model of heat loss from solid food during batch ohmic heating (Marra *et al.*, 2009). (b) A selection of electrodes examined by Zell *et al.* (2011). (c) Venting behind electrodes to facilitate their heating while housed in a convection oven at 80°C, allowing the collection of cook loss during heating (Zell *et al.*, 2011). (d) Combined ohmic/convection (80°C) heating system, with the meat product contained in a plastic casing pressurized between two spring loaded electrodes of minimal practicable thickness (1 mm) (Zell *et al.*, 2011).

or 20°C) for thawing frozen chunks (10 cm<sup>3</sup>) of meat. Under these conditions no direct contact between the meat and the electrodes occurred. Thawing time was reduced with increasing voltage, although frequency changes had no significant effect. Samples treated at lower voltages showed reduced drip loss and improved water holding capacity. Hong *et al.* (2007) compared brine immersion and electrode contact ohmic thawing methods for pork meat and found more rapid thawing with the electrode contact method, while the total color difference was slightly higher with the ohmic immersion thawing. Increasing voltage increased water holding capacity and generally tended to decrease TBARS values. Overall the immersion thawing proved more suitable at high voltage levels whereas electrode contact was more suited to low

voltage levels. Products such as patties have flatter surfaces than other meats. [Kim \*et al.\* \(2006\)](#) ohmically thawed frozen pork patties formulated with 0 and 0.5% added salt. Thawing rate increased with increasing power intensity while patties with added salt thawed faster than those with no added salt. Increasing the power intensity tended to increase the TBARS, and it was suggested that thawing at 50 V induced lipid oxidation in pork patties.

[Roberts \*et al.\* \(1998\)](#) designed a prototype ohmic thawing unit with surface temperature sensing and automated control for thawing two shrimp blocks simultaneously. The substantial amount of waste water, generated with conventional warm water immersion thawing is avoided using ohmic heating, which is also more energy efficient. The design features of the system prevented runaway heating. A subsequent comparison of the sensory, microbial, and quality attributes of shrimp thawed by conventional water immersion vs. ohmic methods ([Roberts \*et al.\* 2002](#)) revealed no significant differences in sensory or total aerobic microbial counts, while small shrimp had higher moisture content when conventionally thawed. Overall, these workers concluded that ohmic thawing is effective for shrimp blocks.

[Miao \*et al.\* \(2007\)](#) compared the thawing rate and gel strength in frozen surimi in saline cubes thawed by conventional and ohmic methods. These workers found faster thawing rates and stronger gels in the ohmically thawed product. Homogenous temperature distributions were obtained when the saline solution concentration was <4% with 20 V applied voltage and a frequency of 60 Hz.

The most recent study in the area of ohmic thawing ([Icier \*et al.\*, 2010](#)) compared the texture and histology of beef cuts which were ohmically or conventionally thawed. These workers found that ohmic thawing had less impact on texture and histology than conventional thawing.

## 8. CONCLUSION AND FUTURE WORK

Ohmic heating is a technology which is capable of pasteurizing meats to produce products of comparable quality to conventionally cooked samples while substantially reducing cooking times and improving yield particularly in non-comminuted meat products. Commercial systems need to be developed and industry made aware of the capabilities of this technology for processing meat.

## ACKNOWLEDGEMENTS

This research has been part-funded by grant aid under the Food Institutional Research Measure, which is administered by the Department of Agriculture and Food, Ireland. Thanks are given to Dr. Nicky Shirsat and Dr. Markus Zell.

## ABBREVIATIONS

$a^*$	Redness/greenness (Hunter $L^*a^*b^*$ scale)
$b^*$	Yellowness/blueness (Hunter $L^*a^*b^*$ scale)
$C$	Specific heat capacity ( $\text{kJ kg}^{-1}\text{°C}^{-1}$ )
$C_s$	Cook value
$dt$	Duration of time at a particular temperature $T$
$E$	Electrical field strength ( $\text{V cm}^{-1}$ )
$\epsilon''$	Dielectric loss
$f$	Frequency (Hz)
$H$	Energy required to heat the meat (kJ)
$J$	Current density ( $\text{A m}^{-2}$ )
$k$	Electrical conductivity ( $\text{S m}^{-1}$ )
$I$	Amperage (amperes)
$L^*$	Lightness (Hunter $L^*a^*b^*$ scale)
$m$	Mass of meat (kg)
$P$	Power consumption of cooker (kW)
<b>PU</b>	Pasteurization units
$Q$	Heat generation rate per unit volume ( $\text{W m}^{-3}$ )
$\rho$	Density of the material ( $\text{kg m}^{-3}$ ).
$R$	Resistance (ohms ( $\Omega$ ))
$\Delta T$	Temperature rise ( $^{\circ}\text{C}$ )
$t$	Time (s)
$t_p$	Total cooking time (s)
$T$	Temperature ( $^{\circ}\text{C}$ )
$\Delta T$	Temperature rise in meat during cooking ( $^{\circ}\text{C}$ )
<b>TPA</b>	Textural profile analysis
$V$	Voltage (volts)
$\lambda$	Resistivity ( $\Omega \text{ m}$ )
$\psi$	Efficiency of cooker
$\theta_p$	Reference temperature for pasteurization units ( $^{\circ}\text{C}$ )
$\theta_c$	Reference temperature for cook value ( $^{\circ}\text{C}$ )
$z_p$	$z$ value for pasteurization ( $^{\circ}\text{C}$ )
$z_c$	$z$ value for cooking ( $^{\circ}\text{C}$ )

## REFERENCES

- Aymerich, T., Picouet, P.A., Monfort, J.M., 2008. Decontamination technologies for meat products. *Meat Sci.* 78, 114–129.
- Asghar, A., Pearson, A.M., 1980. Influence of ante-and postmortem treatments upon muscle composition and meat quality. *Adv. Food Res.* 26, 53–212.
- Benjakul, S., Morrissey, M.T., Seymour, T.A., An, H., 1997. Recovery of proteinase from pacific whitening surimi wash water. *J. Food Biochem.* 21, 431–443.
- Berthou, M., Aussudre, C., Chopard, F., 2001. Improved equipment for ohmic heating of a fluid, system including this equipment for processing of a fluid, and process for ohmic heating of a fluid. French Patent Application, FR 2 802 052 A1.
- Betts, G.D., Gaze, J.E., 1992. Food Pasteurisation Treatments, Technical Manual 27. Campden Food and Drink Research Association, Chipping Campden, Gloucestershire, UK.

- Biss, C.H., Coombes, S.A., Skudder, P.J., 1989. The development and applications of ohmic heating for the continuous processing of particulate foodstuffs. In: Field, R.W., Howell, J.A. (Eds.), *Process Engineering in the Food Industry*. Elsevier, London, pp. 17–25.
- Bozkurt, H., Icier, F., 2010a. Electrical conductivity changes of minced beef-fat blends during ohmic cooking. *J. Food Eng.* 96 (1), 86–92.
- Bozkurt, H., Icier, F., 2010b. Ohmic cooking of ground beef: effects on quality. *J. Food Eng.* 96 (4), 481–490.
- Brady, J.E., Humiston, G.E., 1986. *Electrochemistry. General Chemistry: Principles and Structure*. John Wiley and Sons, New York, 596–639.
- Castro, I., Macedo, B., Teixeira, J.A., Vicente, A.A., 2004. The effect of electric field on important food-processing enzymes: comparison of inactivation kinetics under conventional and ohmic heating. *J. Food Sci.* 69 (9), C696–C701.
- Chan, W., Brown, J., Lee, S.M., Buss, D.H., 1995. *Meat, Poultry and Game. Fifth Supplement to the Fifth Edition of McCance & Widdowson's, The Composition of Foods*. The Royal Society of Chemistry and Ministry of Agriculture, Fisheries and Food.
- Chan, W., Brown, J., Church, S.M., Buss, D.H., 1996. *Meat Products and Dishes. Sixth Supplement to the Fifth Edition of McCance & Widdowson's, The Composition of Foods*. The Royal Society of Chemistry and Ministry of Agriculture, Fisheries and Food.
- Cheol-Goo, Y., Do Hyun, L., Jiyong, P., 1998. Ohmic thawing of a frozen meat chunk. *Korean J. Food Sci. Technol.* 30 (4), 842–847.
- Cho, H.Y., Sastry, S.K., Yousef, A.E., 1996. Growth kinetics of inactivation of *Lactobacillus acidophilus* under ohmic heating. *Biotechnol. Bioeng.* 49 (3), 334–340.
- Cho, H.Y., Sastry, S.K., Yousef, A.E., 1999. Kinetics of inactivation of *Bacillus subtilis* spores by continuous or intermittent ohmic and conventional heating. *Biotechnol. Bioeng.* 62 (3), 368–372.
- De Alwis, A.A.P., Fryer, P.J., 1990. A finite-element analysis of heat generation and transfer during ohmic heating of food. *Chem. Eng. Sci.* 45 (6), 1547–1599.
- De Alwis, A.A.P., Fryer, P.J., 1992. Operability of the ohmic heating process: electrical conductivity effects. *J. Food Eng.* 15, 21–48.
- De Alwis, A.A.P., Halden, K., Fryer, P.J., 1989. Shape and conductivity effects in the ohmic heating of foods. *Chem. Eng. Results Dissemination* 67, 159–168.
- De Halleux, D., Piette, G., Buteau, M.-L., Dostie, M., 2005. Ohmic cooking of processed meats: energy evaluation and food safety considerations. *Can. Biosyst. Eng.* 47, 3.41–3.47.
- Decio, P., 2003. A new ohmic concept for high quality fruit preparations and desserts containing pieces. *Fruit Process.* 13 (2), 110–113.
- Eliot-Godereaux, S.C., Zuber, F., Goullieux, A., 2001. Processing and stabilisation of cauliflower by ohmic heating technology. *Innovative Food Sci. Emerg. Technol.* 2 (4), 279–287.
- Fellows, P., 1988. *Food Process Technology*. Ellis Horwood, London.
- Forrest, J.C., Aberle, E.D., Hedrick, H.B., Judge, M.D., Merkel, R.A., 1975. Principles of meat processing. *Principles of Meat Science*. W.H. Freeman and Company, San Francisco, USA, 191–226.
- Fox, M.B., Esveld, D.C., Mastwijk, H., Boom, R.M., 2008. Inactivation of *L. plantarum* in a PEF microreactor. The effect of pulse width and temperature on the inactivation. *Innovative Food Sci. Emerg. Technol.* 9 (1), 101–108.
- Frampton, R., 1988. Ohmic potential. *Food Manuf.* 6, 61–63.
- Gault, N.F.S., 1992. Structural aspects of raw meat. In: Johnston, D.E., Knight, M.K., Ledward, D.A. (Eds.), *The Chemistry of Muscle Based Foods*. Royal Society Chemistry, Cambridge, pp. 79–105.
- Gault, N.F.S., 1993. Understanding the structure of meat. *New Meat Products Development. Course Notes. The National Food Centre, Dublin (in collaboration with ECCEAMST)*, 1–24.
- Gilliland, S.E., Speck, M.L., 1967a. Inactivation of microorganisms by electrohydraulic shock. *Appl. Microbiol.* 15 (5), 1031–1037.
- Gilliland, S.E., Speck, M.L., 1967b. Mechanism of the bacterial action produced by electrohydraulic shock. *Appl. Microbiol.* 15 (5), 1038–1044.

- Grahl, T., Maerkl, H., 1996. Killing of microorganisms by pulsed electric fields. *Appl. Microbiol. Biotechnol.* 45 (1/2), 148–157.
- Greaser, M.L., 1991. An overview of the muscle cell cytoskeleton. *Reciprocal Meat Conf.* 44, 1–5.
- Halden, K., de Alwis, A.A.P., Fryer, P.J., 1990. Changes in the electrical conductivity of foods during ohmic heating. *Int. J. Food Sci. Technol.* 25, 9–25.
- Holdsworth, S.D., 1985. Optimisation of thermal processing—a review. *J. Food Eng.* 4, 89–116.
- Hong, G.P., Min, S.G., Ko, S.H., Shim, K.B., Seo, E.J., Choi, M.J., 2007. Effects of brine immersion and electrode contact type low voltage ohmic thawing on the physico-chemical properties of pork meat. *Korean J. Food Sci. Animal Resour.* 27 (4), 416–423.
- Honikel, K.O., 1992. In: Smulders, F.J.M., Toldra, F., Flores, J., Prieto, M. (Eds.), *New Technologies for Meat and Meat Products*. ECCEAMST, Utrecht, pp. 135–161.
- Huang, L., Chen, Y., Morrissey, M.T., 1996. Analysis of a batch-type ohmic heating device used in coagulating proteins from surimi waste water. *IFT Annual Meeting: Book of Abstracts*.
- Icier, F., Yildiz, H., Baysal, T., 2006. Peroxidase inactivation and colour changes during ohmic blanching of pea puree. *J. Food Eng.* 74 (3), 424–429.
- Icier, F., Izzetoglu, G.T., Bozkurt, H., Ober, A., 2010. Effects of ohmic thawing on histological and textural properties of beef cuts. *J. Food Eng.* 99 (3), 360–365.
- Institute of Food Technologists (IFT), 2001. Overarching principles: kinetics and pathogens of concern for all technologies. In: Weber, D.E., Katz, F.R., Mattson, C.L. (Eds.), *Journal of Food Science Special Supplement: Kinetics of Microbial Inactivation for Alternative Food Processing Technologies*. Institute of Food Technologists, Chicago, IL, pp. 16–32.
- Jun, S., Sastry, S., 2005. Modelling and optimization of ohmic heating of foods inside a flexible package. *J. Food Process Eng.* 28, 417–436.
- Kanjanapongkul, K., Tia, S., Wongsangasri, P., Yoovidhya, T., 2009. Coagulation of protein in surimi wastewater using a continuous ohmic heater. *J. Food Eng.* 91 (2), 341–346.
- Kim, S.H., Kim, G.T., Park, J.Y., Cho, M.G., Han, B.H., 1996. A study on the ohmic heating of viscous food. *Foods Biotechnol.* 5 (4), 274–279, Oxford: Pergamon.
- Kim, J.Y., Hong, G.P., Park, S.H., Spiess, W.E.L., Min, S.G., 2006. Effect of ohmic thawing on physico-chemical properties of frozen hamburger patties. *Korean J. Food Sci. Animal Resour.* 26 (2), 223–228.
- Ladwig, H., 1991. Ohmic heating system. A continuous sterilization process for particulate products. *Lebensmitteltechnik* 23 (5), 241–242, 244–245.
- Larkin, J.W., Spinak, S.H., 1996. Safety considerations for ohmically heated, aseptically processed, multi-phase low-acid food products. *Food Technol.* 50 (5), 242–245.
- Lawrie, R.A., 1985. *Meat Science*, fourth ed. Pergamon Press, Oxford, England.
- Lawrie, R.A., 1998. *Meat Science*, sixth ed. Woodhead Publishing Limited, Cambridge, England.
- Leizerson, S., Shimoni, E., 2005a. Effect of ultrahigh-temperature continuous ohmic heating treatment on fresh orange juice. *J. Agric. Food Chem.* 53 (9), 3519–3524.
- Leizerson, S., Shimoni, E., 2005b. Stability and sensory shelf life of orange juice pasteurized by continuous ohmic heating. *J. Agric. Food Chem.* 53 (10), 4012–4018.
- Light, N.D., Restall, D.J., Bailey, A.J., 1984. Relationship of collagen content, type and cross linking with texture of different muscles. *Proc. Eur. Meat Res. Work.* 30, 139–140.
- Lima, M., Sastry, S.K., 1999. The effects of ohmic heating frequency on hot-air drying rate and juice yield. *J. Food Eng.* 41 (2), 115–119.
- Luijterink, J.H., 1962. Process for the preservation of non-homogeneous meat. US Patent 3 053 667.
- Lyng, J.G., Zhang, L., Brunton, N.P., 2005. A survey of the dielectric properties of meats and ingredients used in meat product manufacture. *Meat Sci.* 69, 589–602.
- Lyng, J.G., Cronin, D.A., Zell, M., Morgan, D.J., 2009. Electro-heating of meat and meat products: ohmic and radiofrequency applications. *ICoMST Proceedings*. August 16–21, 2009, Copenhagen, Denmark.
- Mansfield, T., 1962. High-temperature, short-time sterilisation, *Proceedings First International Congress on Food Science and Technology*, vol. 4. Gordon and Breach, London, 311–316.



- Marra, F., Zell, M., Lyng, J.G., Morgan, D.J., Cronin, D.A., 2009. Analysis of heat transfer during ohmic processing of a solid food. *J. Food Eng.* 91, 56–63.
- Martin, E.A., 1960. Experimental investigation of a high-energy density, high-pressure arc plasma. *J. Appl. Phys.* 31, 255–267.
- Miao, Y., Chen, J.Y., Noguchi, A., 2007. Studies on the ohmic thawing of frozen surimi. *Food Sci. Technol. Res.* 13 (4), 296–300.
- Mitelut, A., Popa, M., Geicu, M., Niculita, P., Vatuiu, D., Vatuiu, I., et al., 2011. Ohmic treatment for microbial inhibition in meat and meat products. *Rom. Biotechnol. Lett.–Suppl.* 16 (1), 149–152.
- Mizrahi, S., 1996. Leaching of soluble solids during blanching of vegetables by ohmic heating. *J. Food Eng.* 29 (2), 153–166.
- Neumann, A.E., 1961. Method of cooking meat products. US Patent 3 009 813.
- Onwuka, U.N., Ejikeme, C., 2005. Influence of voltage and electrode type on the yield and quality of fruit juice extracted by ohmic heating. *Fruits* 60 (5), 341–349.
- Özkan, N., Ho, I., Farid, M., 2004. Combined ohmic and plate heating of hamburger patties: quality of cooked patties. *J. Food Eng.* 63 (2), 141–145.
- Palaniappan, S., Sastry, S.K., 1992. Effects of electroconductive heat treatment and electrical pretreatment on thermal death kinetics of selected microorganisms. *Biotechnol. Bioeng.* 39 (2), 225–232.
- Palaniappan, S., Sastry, S.K., Richter, E.R., 1990. Effects of electricity on microorganisms: a review. *J. Food Process Preserv.* 14, 393–414.
- Parrott, D.L., 1992. Use of ohmic heating for aseptic processing of food particulates. *Food Technol.* 46 (12), 68–72.
- Pearson, A.M., Young, R.B., 1989. *Muscle and Meat Biochemistry*. Academic Press, Inc., London.
- Piette, G., Brodeur, C., 2003. Ohmic cooking for meat products: the heat is on! Website: <[http://sci.agr.ca/crda/pubs/art10\\_e.htm](http://sci.agr.ca/crda/pubs/art10_e.htm)>, 1–3.
- Piette, G., de Halleux, D., Dostie, M., Raymond, Y., Buteau, M.-L., 2000a. Energetic aspects of ohmic cooking for processed meats. Forty-sixth International Congress of Meat Science and Technology, pp. 244–245.
- Piette, G., Ramaswamy, H., de Halleux, D., Dostie, M., Raymond, Y., Buteau, M.-L., et al., 2000b. Ohmic heating behaviour of processed meats. Forty-sixth International Congress of Meat Science and Technology, pp. 246–247.
- Piette, G., Dostie, M., Ramaswamy, H., 2001. Ohmic cooking of processed meats—state of the art and prospects. Forty-seventh International Congress of Meat Science and Technology, pp. 62–67.
- Piette, G., Buteau, M.L., de Halleux, D., Chiu, L., Raymond, Y., Ramaswamy, H.S., et al., 2004. Ohmic cooking of processed meats and its effects on product quality. *J. Food Sci.* 69 (2), FEP71–FEP78.
- Praporscic, I., Ghnimi, S., Vorobiev, E., 2005. Enhancement of pressing of sugar beet cuts by combined ohmic heating and pulsed electric field treatment. *J. Food Process. Preserv.* 29 (5, 6), 378–389.
- Rao Lakkakula, N., Lima, M., Walker, T., 2004. Rice bran stabilization and rice bran oil extraction using ohmic heating. *Bioresour. Technol.* 92 (2), 157–161.
- Reznick, D., 1996. Ohmic heating of fluid foods. *Food Technol.* 50 (5), 250–251.
- Rice, J., 1995. Ohmic adventures. *Food Process.* 3, 87–91.
- Roberts, J.S., Balaban, M.O., Zimmerman, R., Luzuriaga, D., 1998. Design and testing of a prototype ohmic thawing unit. *Comput. Electron. Agric.* 19, 211–222.
- Roberts, J.S., Balaban, M.O., Luzuriaga, D.A., 2002. Comparison of quality attributes of ohmic and water immersion thawed shrimp. *J. Aquat. Food Prod. Technol.* 11 (2), 3–11.
- Ruan, R., Ye, X., Chen, P., Doona, C.J., 2001. Ohmic heating. In: Richardson, P. (Ed.), *Thermal Technologies in Food Processing*. Woodhead Publishing Limited, Cambridge, pp. 241–265.
- Salengke, S., Sastry, S.K., 2005. Effect of ohmic pretreatment on the drying rate of grapes and adsorption isotherm of raisins. *Drying Technol.* 23 (3), 551–564.
- Samaranayake, C.P., Sastry, S.K., Zhang, H., 2005. Pulsed ohmic heating—a novel technique for minimization of electrochemical reactions during processing. *J. Food Sci.* 70 (8), E460–E465.

- Sarang, S., Sastry, S.K., Knipe, L., 2008. Electrical conductivity of fruits and meats during ohmic heating. *J. Food Eng.* 87 (3), 351–356.
- Sastry, S.K., 1992. A model for heating of liquid-particle mixtures in a continuous flow ohmic heater. *J. Food Process Eng.* 15 (4), 263–278.
- Sastry, S.K., 1994. Ohmic heating. In: Singh, R.P., Oliveria, F.A.R. (Eds.), *Minimal Processing of Foods and Process Optimisation*. CRC Press, London, pp. 17–32.
- Sastry, S.K., 2005. Advances in ohmic heating and moderate electric field processing. In: Barbosa-Cánovas, G.V., Tapia, N.S., Cano, M.P. (Eds.), *Novel Food Processing Technologies*. CRC Press, New York, pp. 491–500.
- Sastry, S.K., Barach, J.T., 2000. Ohmic and inductive heating. *J. Food Sci.-Suppl.* 65, 42–46.
- Sastry, S.K., Palaniappan, S., 1992. Ohmic heating of liquid-particle mixtures. *Food Technol.* 12, 64–67.
- Sensoy, I., Sastry, S.K., 2004. Ohmic blanching of mushrooms. *J. Food Process Eng.* 27 (1), 1–15.
- Shimida, K., Shimahara, K., 1985. Leakage of cellular contents and morphological changes in *Escherichia coli* B cells exposed to an alternating current. *Agric. Biol. Chem.* 49, 3605–3607.
- Shirsat, N., Lyng, J.G., Brunton, N.P., McKenna, B., 2004a. Ohmic processing: electrical conductivities of pork cuts. *Meat Sci.* 67, 507–514.
- Shirsat, N., Lyng, J.G., Brunton, N.P., McKenna, B., 2004b. Conductivities and ohmic heating of meat emulsion batters. *J. Muscle Foods* 15, 121–137.
- Shirsat, N., Brunton, N.P., Lyng, J.G., McKenna, B., 2004c. Water holding capacity, dielectric properties and light microscopy of a conventionally and ohmically cooked meat emulsion batter. *Eur. J. Food Res.* 219, 1–5.
- Shirsat, N., Brunton, N.P., Lyng, J.G., McKenna, B., Scannell, A., 2004d. Texture, colour and sensory evaluation of a conventionally and ohmically cooked meat emulsion batter. *J. Sci. Food Agric.* 84, 1861–1870.
- Skaara, T., Regenstein, J.M., 1990. The structure and properties of myofibrillar proteins in beef, poultry and fish. *J. Muscle Foods* 1, 269–291.
- Skudder, P.J., 1989. Ohmic heating in food processing. *Asian Food J.* 4 (4), 10–11.
- Sperber, B., 1992. Ohmic—a shock to the system. *Food Process.* 11, 97–99.
- Tucker, G.S., Lambourne, T., Adams, J.B., Lach, A., 2002. Application of a biochemical time-temperature integrator to estimate pasteurisation values in continuous food processes. *Innovative Food Sci. Emerg. Technol.* 3 (2), 165–174.
- Tuoxiu, Z., Lima, M., 2003. The effect of ohmic heating on vacuum drying rate of sweet potato tissue. *Bioresour. Technol.* 87 (3), 215–220.
- Uemura, K., Toyoshima, H., Okadome, H., 1998. High pressure ohmic heating process for cooking rice. *J. Jpn. Soc. Food Sci. Technol.* 45 (9), 533–538.
- Vicente, A.A., de Castro, I., 2007. Novel thermal processing technologies. In: Tewari, G., Juneja, V. (Eds.), *Advances in Thermal and Non-Thermal Food Preservation*. Blackwell Publishing Professional, Ames, IO, pp. 99–130.
- Vicente, A.A., de Castro, I., Teixeira, J.A., 2006. Ohmic heating for food processing. In: Sun, D.W. (Ed.), *Thermal Food Processing*. CRC Press, Boca Raton, FL, pp. 425–468.
- Wang, C.-S., Wu, J.S.-B., 1999. Ohmic heating of fluid containing apple particulates. *Food Sci. Agric. Chem.* 1 (2), 154–161.
- Wang, W.-C., Sastry, S.K., 1997. Starch gelatinization in ohmic heating. *J. Food Eng.* 34 (3), 225–242.
- Wang, W.-C., Sastry, S.K., 2002. Effects of moderate electrothermal treatments on juice yield from cellular tissue. *Innovative Food Sci. Emerg. Technol.* 3 (4), 371–377.
- Yajun, Z., Yongguang, Y., Qingyu, Y., Wei, L., 2003. Processing technique of ohmic heating of liquor foods containing particulates and its influencing factors. *Food Ferment. Ind.* 29 (7), 75–78.
- Yun, C.G., Lee, D.H., Park, J., 1998. Ohmic thawing of a frozen meat chunk. *Korean J. Food Sci. Technol.* 30 (4), 842–847.
- Zell, M., Lyng, J.G., Morgan, D.J., Cronin, D.A., 2009a. Development of rapid response thermocouple probes for use in a batch ohmic heating system. *J. Food Eng.* 93, 344–347.

- Zell, M., Lyng, J.G., Cronin, D.A., Morgan, D.J., 2009b. Ohmic heating of meats: electrical conductivities of whole meats and processed meat ingredients. *Meat Sci.* 83, 563–570.
- Zell, M., Lyng, J.G., Cronin, D.A., Morgan, D.J., 2009c. Ohmic cooking of whole beef muscle—Optimisation of meat preparation. *Meat Sci.* 81, 693–698.
- Zell, M., Lyng, J.G., Morgan, D.J., Cronin, D.A., 2010a. Ohmic cooking of whole beef muscle—Evaluation of the impact of a novel rapid ohmic cooking method on product quality heating of meats. *Meat Sci.* 86 (2), 258–263.
- Zell, M., Lyng, J.G., Morgan, D.J., Cronin, D.A., 2010b. Ohmic cooking of whole turkey meat—Effect of rapid ohmic heating on selected product parameters. *Food Chem.* 120 (3), 724–729.
- Zell, M., Lyng, J.G., Morgan, D.J., Cronin, D.A., 2011. Minimising heat losses during batch ohmic heating of solid food. *Food Bioprocess Process.* 89 (2), 128–134.
- Zell, M., Lyng, J.G., Morgan, D.J., Cronin, D.A., 2012. An evaluation of quality of an ohmically cooked ham product. *Food Bioprocess Technol.* 5 (1), 265–272.
- Zoltai, P., Swearingen, P., 1996. Product development considerations for ohmic processing. *Food Technol.* 50 (5), 263–266.
- Zuber, F., 1997. Ohmic heating: a new technology for stabilising ready-made dishes. *Viandes et Produits Carnes* 18 (2), 91–95, 128.

# Food Processing Facility Design

Timothy J. Bowser

Oklahoma State University, OK, USA

## 1. INTRODUCTION

A food processing facility has been defined by the FDA (1999) as “those facilities where food is subject to activities that constitute *processing*”. Processing is further described as food subjected to the following activities: canning, freezing, cooking, pasteurization or homogenization, irradiation, milling, grinding, chopping, slicing, cutting, canning, cooking, dehydration or peeling. Post-slaughter carcass handling for meat and poultry are also classified as processing (FDA, 1999). Some exceptions exist. The purpose of a food processing facility is to convert unprocessed ingredients into shelf-stable, transportable food products that are desirable to the consumer and generate a profit for the facility owner.

Design of a food processing facility includes the activities of ideation, planning, concept development, testing, evaluation, construction, and startup. Design is often an iterative process in which the basic sciences, creativity, and experience are applied to meet an objective which includes a variety of constraints such as economics, safety, flexibility, aesthetics, reliability, and social impact (Ertas and Jones, 1996). The purpose of this chapter is to provide an overview of food processing facility design, highlighting some of the manifold factors that must be considered.

## 2. BACKGROUND

Prehistoric people collected foods, such as grains or fish, and processed them in central locations for immediate consumption, storage, transportation, or use as currency. Documented food processing occurred as early as 3000 BC, when workers on the pyramids of Egypt were paid with manufactured bread (Trager, 1995). One of the most important early food processing facilities was probably the “House of Appert”, a cannery that began operation in about 1810, based on technology discovered by the owner, Nicolas Appert. Canning soon became widespread (*Britannica Concise Encyclopedia*, 2005) and many regard its discovery as the seminal event in modern food processing

history (Pehanich, 2003). The basic food preservation technologies practiced today were discovered and in place by the end of the 1920s. *Food Engineering* (Morris, 2003) provided a timeline of the most important food processing developments from 1928 to 2003. Most of the listed technologies, such as air-blast freezer, fork-lift truck, and plate heat exchanger, are found in today's modern food processing facilities.

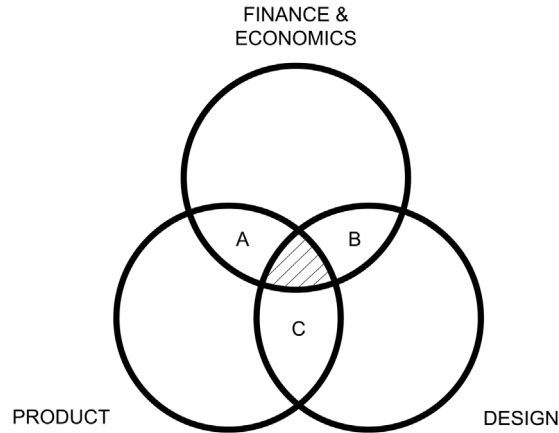
Automation and computer controls had one of the most significant impacts in the history of food plant design (Cherok, 2005; Morris, 2003; Saravacos and Kostaropoulos, 2002). Economists Connor and Schick (1997) stated this differently; claiming that in comparison to other industries, food processors are "labor extensive". The Sara Lee plant in Deerfield, Illinois, which opened in 1964, was probably the first application of a plant-wide computer control system in any industry (Gould, 1965; Thomas, 1964), and clearly marked the beginning of the computerized era for food processing facilities. The revolutionary Sara Lee plant included a totally automated frozen warehouse, and automated batching and shipping systems (Gould, 1965). Today's modern food plants take full advantage of automation technologies and are amazing centers of productivity.

In the mid-1980s, a new trend occurred in food processing plants. The number of facilities being constructed started to slowly increase. The increased numbers were accounted for by startups of small plants targeting niche markets, rather than the traditional mega-plants built by large firms (Connor and Schick, 1997). Unfortunately, most of the smaller plants escaped the notice of the popular media. Installation costs for facilities listed in *Food Engineering* magazine's "Plant of the Year Award" have exceeded 25 million dollars. Small facilities have also escaped the attention of the large consulting firms that carry the core knowledge and resources necessary for state-of-the-art facility design and construction.

Food production is becoming increasingly capital intensive. From 1963 to 1992, food plant investment rose 7.2% per year; which is more than increases in sales, or value-added activities. Even though the investments in new plants have increased, they made up a relatively small proportion of the total costs in the industry; about 2–4% in the last 10–20 years. Of this amount, nearly 25% was used for buildings and 75% was spent on equipment (Connor and Schick, 1997). Based on these trends, it is clear that the design of new food processing facilities must be better than ever to provide higher production rates of superior products with more attractive financial returns.

### 3. KEY FACILITY ISSUES

The decision and the subsequent design path followed to develop a new food processing facility is a complex undertaking that involves many sequential steps, concurrent activities, and dozens of hidden pitfalls. Each facility design is unique, but similarities between cases exist. A new food processing facility design project begins with



**Figure 21.1** Graphic showing the three descriptive categories important to food processing facility success and the interaction between categories. The hatched area indicates the location of cross-cutting issues that are present in all three categories and therefore have the most significant interaction. The letters A, B, and C indicate the remaining interaction areas between the three categories.

**Table 21.1** Key Cross-Cutting Issues (located in hatched area of Figure 21.1) Important for Successful Food Process Facility Design

No.	Key Cross-Cutting Issues
1.	Ethics
2.	Hygiene and sanitation
3.	Market demographics
4.	Research and development
5.	Safety
6.	Site selection
7.	Timing
8.	Trends
9.	Waste

Cross-cutting issues are listed in alphabetical order.

identification, understanding, and resolution of key issues. These key issues fall into three broad categories distinguishing new food processing facilities: 1. products; 2. economics & financing; and 3. design. A graphical interpretation of the three categories and their interactions is shown in Figure 21.1. The central overlap area identifies cross-cutting issues that are common in all three categories.

Cross-cutting issues may be the most critical to project feasibility and overall success as they involve interaction between the three categories. Table 21.1 lists the most common cross-cutting issues found in new food processing facility design. Table 21.2 lists some of the issues found in each category and their possible interaction (if any)

**Table 21.2** Key Issues Important for Successful Food Processing Facilities  
**No. Category & Applicable Interaction Area (see Figure 21.1)**

	Product	Finance & Economics	Design
1.	Capacity (including future) C	Automation & efficiency B	Automation & efficiency B
2.	Flexibility (line additions and co-products) C	Cash available B	Capacity (including future) C
3.	Freight A	Equipment cost B	Cash available B
4.	Ingredient cost A	Facility (site, design, construction, maintenance) B	Equipment cost B
5.	Locally available ingredients C	Freight A	Facility (site, design, construction, maintenance) B
6.	Market price/profitability A	Ingredient cost A	Facility & process technology/art
7.	Packaging design C	Insurance	Flexibility (line additions and co-products) C
8.	Physical properties of product C	Labor quality B	Labor quality B
9.	Process design C	Market price/profitability A	Locally available construction materials
10.	Voice of consumer	Packaging cost	Locally available ingredients C
11.		Return on investment	Owner preference
12.		Sales	Packaging design C
13.		Site incentives B	Permitting
14.		Startup	Physical properties of product C
15.		Utilities available and cost B	Process design C
16.			Site incentives B
17.			Site topography/geography
18.			Transportation access
19.			Utilities available and cost B

The key issues are as located in the identified area of Figure 21.1, which may or may not include one of the interaction areas A, B, or C. Issues are listed in alphabetical order.

with other categories based on their location in overlap areas A, B, or C of Figure 21.1. Area A shows interaction between the categories of finance & economics and product. Area B encloses interactions between the categories of finance & economics and design. Area C covers the interactions between design and product. Interacting issues found in overlap areas should be studied, identified, and treated after cross-cutting issues have been resolved. Finally, individual issues located uniquely in any of the three broad category areas should be addressed. We will now describe cross-cutting issues in the order that they are listed in Table 21.1.

### 3.1 Cross-Cutting Issues

Decisions in all aspects of food facility design must be filtered by sound ethics. Albert Einstein (1879–1955) once said “Relativity applies to physics, not ethics”. Relativity has no place in the manufacturing of food products. Ethics of food processing (Bliss, 2011; Singer and Mason, 2007) and manufacturing (Gottwald et al., 2010; Kutz, 2007) deserve and are receiving more attention. Animal welfare, environmental stewardship, and contract awards are examples where ethical filters have been established and are improving. Product formulation, packaging choices, and reactions to consumer trends represent areas of nascent ethical reasoning.

Of the cross-cutting issues listed in Table 21.1, hygiene and sanitation have probably received the most attention in the literature. Wierenga and Holah (2003) claim that hygiene is the number one element common in the design of all food plants. Milledge (1980) pointed out that a clean plant atmosphere will also inspire operators to practice good hygiene. Shore and Jowitt (1971) summarized the objective of good hygiene as the maximization of sanitation during production and the minimization of cleanup effort required afterward. The reader is encouraged to consult the literature available on hygiene (Clark, 2008; Cramer, 2006; Etienne, 2006; Imholte, 1984; Jowitt, 1980; Lelieveld et al., 2003; Lelieveld and Holah, 2011; Marriott and Gravani, 2006) specifically related to facility design.

“Market demographics” is a term that refers to the statistical characteristics of a particular food consumer group. Food processing companies need strategies to help them identify consumer target groups and understand how their attitude affects purchasing behavior. For instance, the annual food and beverage market for children is in excess of \$27 billion (Swann, 2007). Demographic research reports are available covering many consumer groups, such as active seniors, African-Americans, college students, teens, and luxury consumers (Packaged Facts, 2012).

Innovations, breakthroughs, and improvements that result from research and development have a broad and long-lasting impact on the food industry. *Food Engineering* magazine (Morris, 2003) compiled a list of major technologies that, as a result of their implementation, have changed the face of food processing facility design over the past 75 years. For example, Majoor (2003) suggested that clean in place (CIP) technologies and their implementation have directly affected facility design, layout, and processes.

Human and product safety are integrated into every facet of food processing facility design with a goal of producing safer products in a safer facility. Kletz (1998) describes a widely accepted approach to accomplish inherently safer design. Safety matters have sufficient gravity to justify government and third-party regulatory agencies. The Food Drug and Cosmetic Act of 1938 was one of the first examples of legislation that seriously impacted the design of food processing facilities (Gould, 1994). Other significant regulations include the USDA Meat Inspection Act, the Good



Manufacturing Practices (GMPs), the Pasteurized Milk Ordinance, the Occupation Health Safety Act (OSHA), the Environmental Protection Act (EPA), Hazard Analysis Critical Control Point (HACCP) (Cherok, 2005; Imholte, 1984; Saravacos and Kostaropoulos, 2002), and the Food Safety Modernization Act (FSMA). Fassl and Schweizer (2004) cited the Bioterrorism Act as being the latest legislative piece that has changed the entire food development, manufacturing, and distribution chain. Impact of the new FSMA is presently unfolding, but according to Burns & McDonnell, Inc. (2012), it will impact plant design with regard to implementation of preventative controls. Besides legislation, regulations impacting safety have been developed by industry, professional societies, and special interest groups have helped to establish food plant design standards, such as the 3-A Sanitary Standards (3-A Sanitary Standards, Inc., 2012).

Good soil, a gentle slope, and close proximity to the interstate and railways are not enough to attract potential buyers to a building site. Historically, and more now than ever, facility site selection depends greatly on special incentives such as free land, low mortgage, workforce education, tax breaks, and low utilities prices (Robberts, 2002). Most owners select several sites and encourage potential providers to bid against each other in a contest to “win” the new facility. Beyond this very important bidding war, there is a long list of site features that must be examined during the selection process (De Meirleir, 2007; Gould, 1994; Imholte, 1984; Jowitt, 1980; Lee, 1997; Rosen and Blombergsson, 1963).

Timing can be critical through all stages of food processing facility design. A sudden outbreak of a foodborne illness or disease could affect public perception and the movements of the market, causing funding to disappear quickly. Other examples of unforeseen timing-related events are dips in the economy, shifting international markets, changing business competition, seasonal fluctuations, and new research findings. Future Beef Operations (FBO) is an example of how timing can affect facility design. FBO was a highly celebrated meat processing facility (*Food Engineering Magazine's* 2002 plant of the year (2003)) that never achieved success despite “revolutionary” processing concepts and automation. Wes Ishmael, editor of *Beef* magazine, (Ishmael, 2002) explained the reasons for the demise of FBO and included the statement “if timing is everything, the FBO had it all—bad timing that is”. After only one year from opening, a court ordered FBO into Chapter 7 bankruptcy liquidation.

Trends affect the food industry almost as much as they affect the diets of consumers. The following current trends were identified from *Food Processing* magazine's 2011 survey of the top issues plant managers face today (Sperber, 2011) (listed in order): food safety, cost control, sourcing and materials, inspection/certification, labor, energy, environmental concerns, automation, water, and consolidation. Today, wood and wood materials are no longer used to frame structures (Imholte, 1984). Stainless steel is the preferred material for wall, ceiling, drain, and curb coverings (Milledge,

1980) and process equipment (Gilmore, 2003). In the 1970s, the Department of Defense suggested that the design of food plants should reduce their vulnerability to nuclear attack, and provide fallout shelters (US Department of Defense, 1970); fortunately this trend has disappeared. Multilevel structures were preferred in the 1960s (Parker and Litchfield, 1962) but, have largely been replaced with single-storey structures (Saravacos and Kostaropoulos, 2002; Wieringa and Holah, 2003). These few examples illustrate the impact of trends on food facility design, a phenomenon that is challenging to predict.

The importance of waste recycling, handling, and disposal is frequently underestimated in the practice of facility design. Good facility design will provide for waste minimization and disposal activities. Waste cannot be stored for long periods and must be quickly and efficiently removed from the premises. Products may be defined, formulated and produced to minimize waste; this effort places special demands on processing space, utilities, hygiene, materials handling, and other facility design issues. For example, onsite reclamation and use of gray water will reduce potable water needs and waste-water disposal. Co-products, like pet foods, can be purposefully designed to make use of primary product waste streams. Shipping containers may be washed and reused. Waste heat from ovens can be recovered and used for preheating purposes.

### 3.2 Interacting Issues

In this section, the interaction areas A, B, and C (shown in Figure 21.1) will be described. Area A shows interactions between the categories of finance & economics and product. Two key issues are found in this region: freight and market price/profitability. The former relates to the cost of delivery, mode of transport, handling and destination of materials and products. These variables directly affect the product packaging and design for shelf-stability and consumer acceptance. Pricing and profitability of the product affects many factors including product quality, consumer acceptance, return on investment, and sales.

Overlap area B contains the largest number of overlap issues between the categories of finance & economics and design: automation and efficiency, cash available, equipment cost, facility, labor quality, site incentives, and utilities costs & availability. Design efficiencies can be improved in areas such as process, facility, materials handling, waste reduction, labor savings, and ingredient savings. Morris (2003) stated that most recent innovations in food processing have focused on efficiency and effectiveness, as the basic science has been developed. Availability of cash and credit for investment is an obvious financial and design issue. Often the owner's desire for a state-of-the-art facility yields to the practicality of finances and return on investment. Equipment cost and budget will have serious impacts on facility design. For example, continuous processes often

have higher equipment costs and require additional space compared to batch operations. Facility issues include factors such as site layout and location, building footprint, type of building frame and construction, and contractors. These factors contribute directly into the overall facility cost and therefore the financing & economics of the facility.

Designers may consider increased levels of automation when skilled maintenance workers and operators are available; lowering the cost of manufacturing. Site incentives supplied by property owners and municipalities seeking to entice new facilities can play a large role in facility design and economics as previously mentioned. Utilities costs daily impact the bottom line of plant operation. Decisions to make use of a particular utility and alternatives or backups may change design space, ventilation, security, access, storage and other facility features.

Overlap area C includes six interaction issues from product and design: capacity, flexibility, locally available ingredients, packaging design, physical properties of the product and ingredients, and process design. Capacity (including future opportunities for expansion) refers to product throughput and is directly related to the type of product and the manufacturing process. Raw ingredient storage needs, utilities demand, and waste generated are examples of quantities that are based on manufacturing capacity. Some product lines are simple to expand and co-products can be manufactured on the same line with little or no differences. In general, this is not the case and extensive changeovers, additional space, and new equipment are required. Flexibility (without excess complexity or expense) for product and design is of great value to facility operations and allows capacity increases, line extensions, ingredient changes, and other options such as utility conversions.

Locally available ingredients are frequently a lynch-pin in the decision to locate a food plant. Local ingredient availability can improve product quality, reduce freight, and possibly reduce storage costs of ingredients. Use of local products may also enhance the public opinion and reputation of the plant. Packaging design choices will influence product development and specifications in size, shelf-life, durability, and uniformity (for example). Packaging influences design by dictating process and storage space requirements and accommodation for change and future upgrades. Physical properties of the product and ingredients are important for process design, materials handling, and safety purposes. Process design determines the steps that transform raw ingredients into a final product, greatly influencing the outcome of facility design.

### **3.3 Individual Issues**

Individual issues in the three categories of finance & economics, product, and design will now be addressed. The only individual issue in the product category is voice of the customer. Voice of the consumer is the feedback received from customers on their

likes, dislikes, needs, and desires for the product and is used for continuous improvement activities.

Unique issues in the finance & economics category include: insurance, packaging cost, return on investment, sales, and startup. Insurance premiums will impact the profitability of the investment. In rare cases, design and product choices are made solely to reduce insurance costs. Packaging material expenses are a consequence of packaging design and plant capacity. Packaging costs may be negotiated with suppliers after the packaging design is complete. Return on investment is normally given as a percentage value (using a given calculation method) that is set by the board of directors or other company leadership. The facility payback schedule must satisfy the desired return on investment or the project will not be funded. Sales have an obvious bearing on finances. A safe, high-quality product will enhance and maintain sales. Startup is a one-time cost that is factored into the overall facility investment and will be discussed in a later section.

Individual issues falling into the design category include facility and process art, locally available construction materials, owner preference, permitting, site topography and geology, and transportation access. Facility and process art are the combination of science, technology, creativity, and experience embodied by the team of professionals selected to accomplish the food process facility design. Materials from local manufacturing plants such as acid brick, masonry, steel, tile, and insulation should be considered for facility construction because of availability, pricing considerations, community relationships, and transportation costs. Many facility owners will have firm preferences for facility design based on their past experience and personal knowledge. Permits are required to begin construction and operation of new processing facilities. Permits involving long approval times should be targeted early to maintain the project schedule. Site topography and geology can dramatically affect the design of a facility. Steep slopes, for example, are favorable for multilevel facilities. Geology will affect foundation and structural plans. Transportation access is important to activities both within and without the facility; affecting shape, orientation, and safety considerations of the building.

#### **4. PROJECT PHASES**

Facility design consists of four major project phases:

1. Planning and feasibility.
2. Conceptual design.
3. Preliminary design.
4. Final design.

Final design normally leads to construction and startup. Construction and startup are not necessarily classified as “design” phases, but the lessons learned during the

execution of these two phases are vital to the improvement of future designs. All project phases are highly interdependent and required for sound project design and successful completion. Error checking and continuous improvement activities should be integral to each phase. A description of the four design phases follows, including a short treatment of construction and startup. In each description, we will begin with the expected results and list outputs for the phase. But before entering the design phases, it is useful to discuss drawings as they are an extremely significant component common to all design phases.

## 4.1 Drawings

Table 21.3 shows a listing of the drawings typically rendered during the conceptual, preliminary and final design phases of food processing facilities. Site plans show land use for the immediate project and for the future. Buildings, parking, retention areas, open space, and “green” areas are depicted. Figure 21.2 is an example of a site plan for a food processing facility. A site plan should reflect the business strategy of the organization, as well as the building and grounds layout of the facility. Site plans are normally formulated by a team of specialists including industrial and civil engineers, architects, and facility designers (Lee, 1997).

**Table 21.3** Drawing List for a Typical Food Processing Facility Design Project and Associated Design Phase or Phases

Drawing	Design Phase		
	Conceptual	Preliminary	Final
Site plan	X	X	X
Process flow diagram (PFD)	X	X	X
General arrangement drawing (GA)	X	X	X
Utility flow diagram (UFD)	X	X	X
Single-line electrical diagram	X	X	X
Alternative design drawings	X		
Piping and instrumentation diagram (P&ID)		X	X
Floor plans	X	X	X
Roof plans		X	X
Foundation plans (equipment and building)		X	X
Lighting plan		X	X
Reflected ceiling plan		X	X
HVAC		X	X
Controls diagrams		X	X
Fire protection plan		X	X
Plumbing details			X
Construction drawings (package)			X

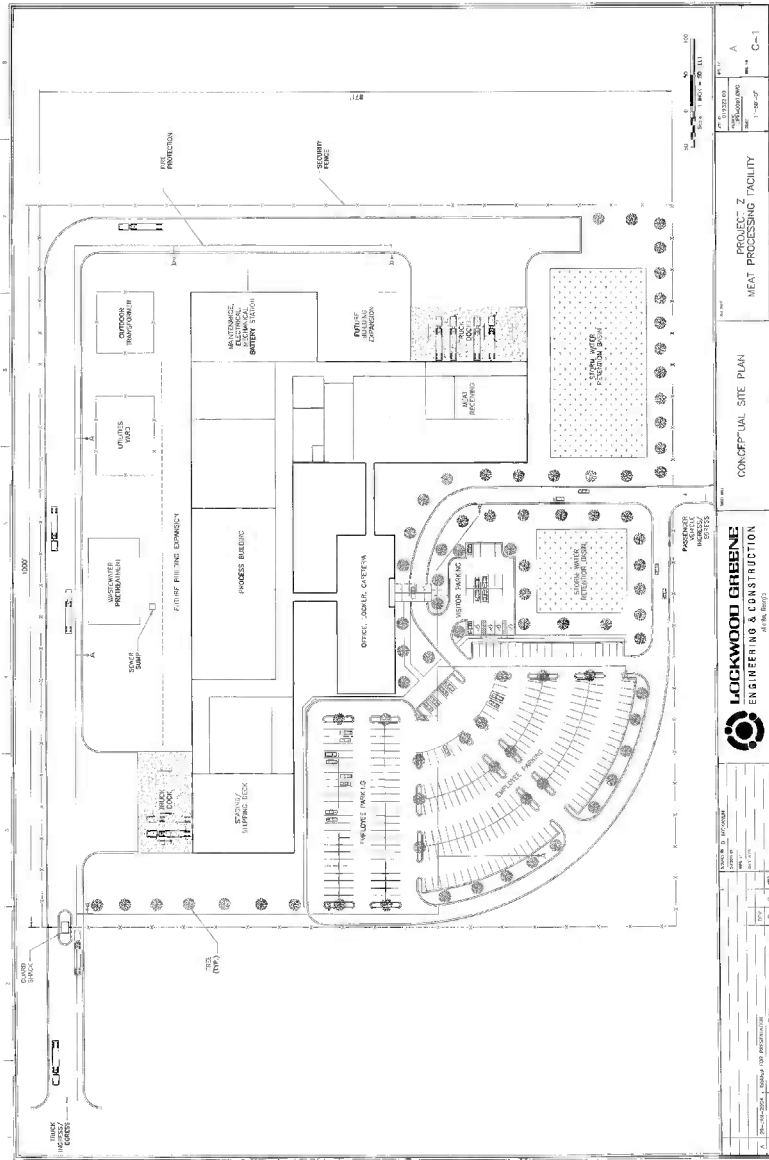


Figure 21.2 Conceptual site plan for a meat processing facility, used with permission from Lockwood Greene Engineers.

Process flow diagrams (PFD) are among the first drawings rendered. PFDs are continuously updated, and are useful to the owners long after the facility design project is closed. They show major steps or elements in plant processes. Process steps are represented by simple shapes which are interconnected by flow arrows. Materials, utilities, inputs, and outputs are included for each step. Bowser (1999) provides examples and thoroughly explains the use and utility of PFDs. Figure 21.3 shows a simple PFD of a portion of a tamale production line.

General Arrangement drawings (GA) show the physical layout of an area within a building or structure, including equipment and access space. Figure 21.4 is an example of a GA of a portion of a meat processing line. GAs are used to efficiently build processes into a given space. Field personnel use GAs to set equipment into its proper place. Envelopes are often outlined around equipment and adjacent areas to reserve space for maintenance and operation activities. GAs may include architectural walls,

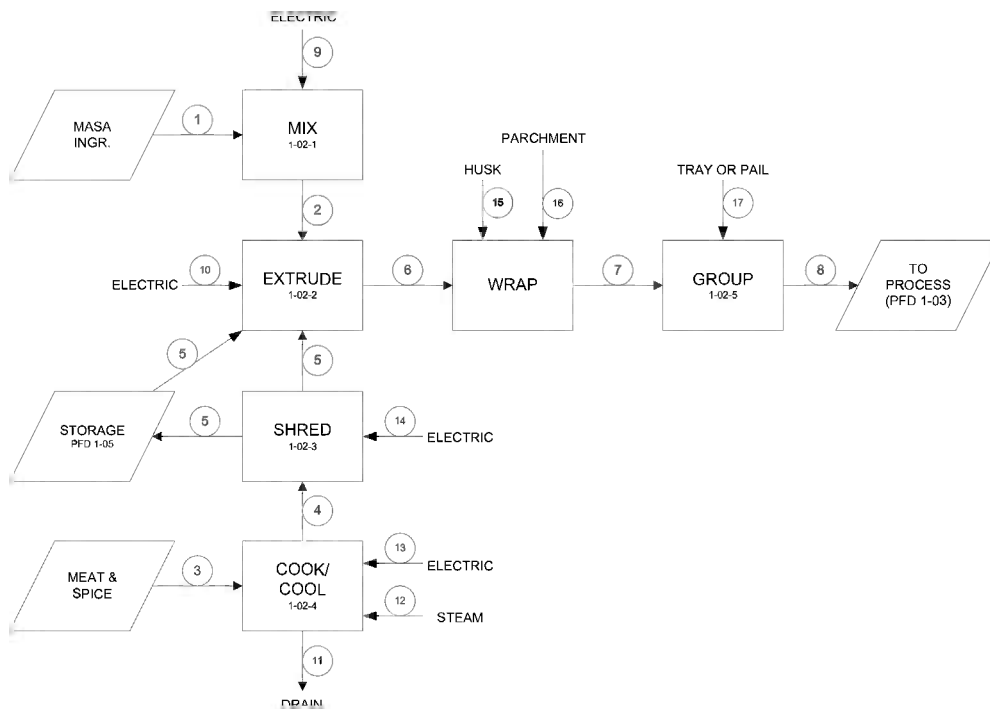
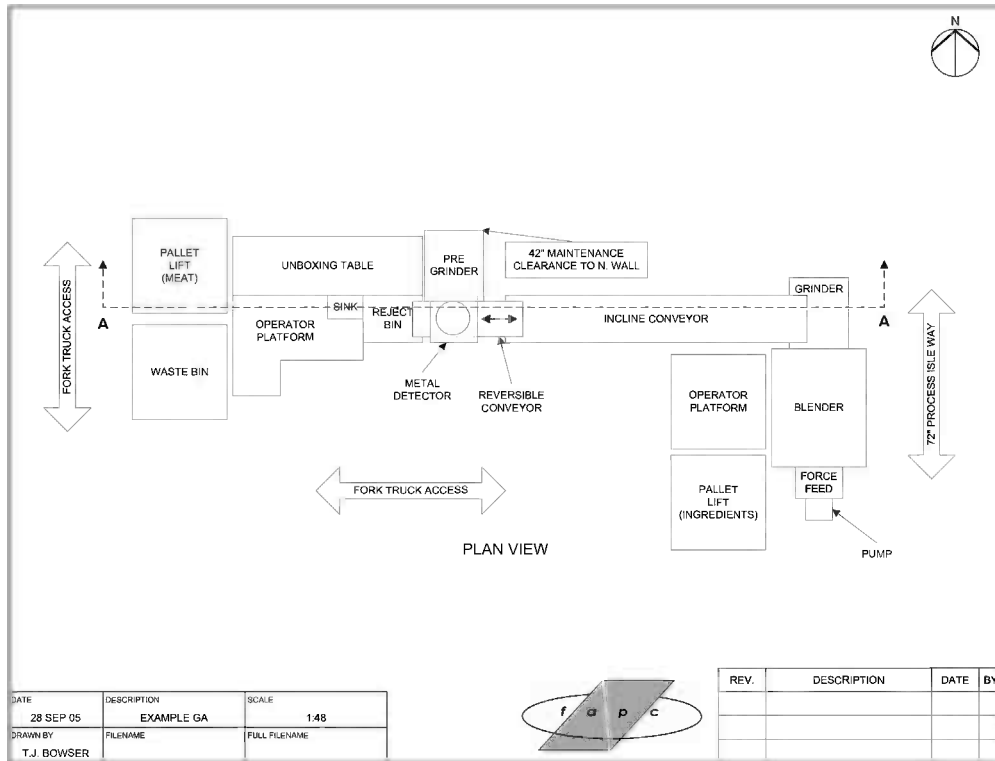


Figure 21.3 Simple process flow diagram (PFD) of a portion of a tamale production line. Inputs and outputs are shown enclosed in parallelograms and may include reference to other PFDs (if applicable); process elements are given in rectangles along with equipment numbers (if applicable); and, materials and energy flow are shown by arrows. The numbered "bubbles" identify flow arrows.

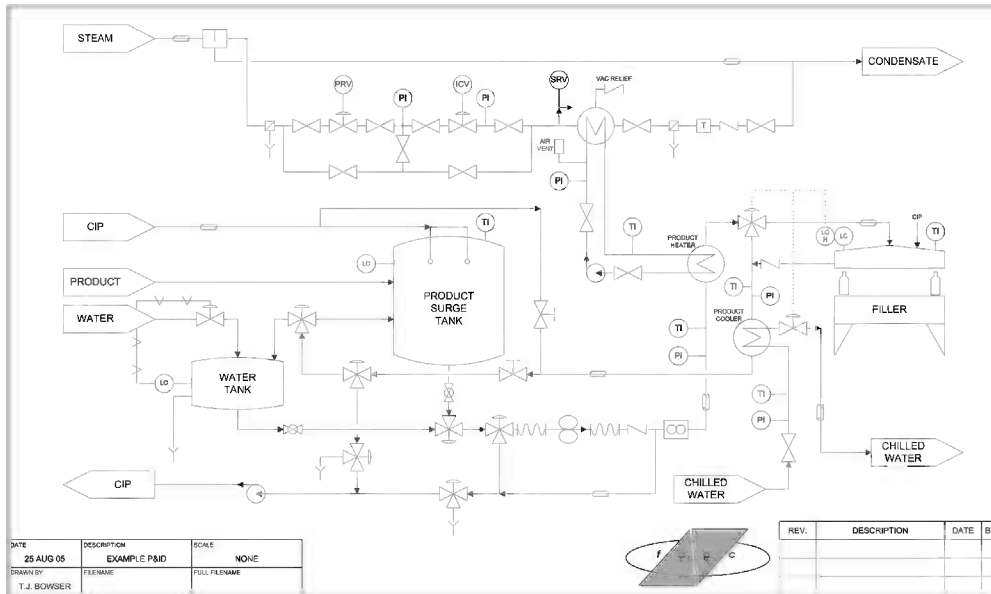


**Figure 21.4** General arrangement drawing (GA) of a meat processing line, used with permission from the Food & Agricultural Products Center, Oklahoma State University.

windows and door openings, equipment and process layout, personnel egress, vehicle lanes and movement, and maintenance activity areas.

A utility flow diagram (UFD) is a specialized PFD that focuses on the connected utilities of the facility. UFDs are often drawn for electrical, steam, water, natural gas, ammonia, compressed air, ethylene glycol, and refrigerant connections. Single-line electrical diagrams are simplified representations of the plant's electrical system that broadly show the power flow of the various major components such as transformers, switch gear, main distribution panels, and motor control centers. Alternate design drawings are used only in the conceptual phase and refer to any of the conceptual drawing types that are used to describe substitute design paths. It is ultimately up to the facility owner to designate which of the conceptual drawings are alternate. Piping and Instrumentation Diagrams (P&ID) show actual equipment, connections, piping details, line sizes, insulation, utility connections, and other information needed to install a working process (see example in [Figure 21.5](#)). P&IDs are schematic only, are not dimensioned, and are not representative of the physical layout of equipment and piping.





**Figure 21.5** Piping and instrumentation diagram (P&ID) for a hot-fill beverage process, used with permission from the Food & Agricultural Products Center, Oklahoma State University.

Floor, roof, foundation, lighting and reflected ceiling plans, are all specific types of GA drawings. Floor plans show details of floors, walls, openings, ramps, railings, mezzanines, columns, and floor areas, including drains, slope, penetrations, and additional details needed for construction. Roof plans detail the materials, framing, joist and girder details, dimensions, pitch, penetrations, egress, foundations for roof-mounted equipment, ice control, water drainage, and other details important to roof construction. Foundation plans give footing requirements including materials, cross-sections, rebar size and placement. Lighting plans may include indoor and outdoor fixture locations, mounting heights, plots demonstrating adequate intensities and uniformities of light, proposed hours of operation, and maintenance schedules. Reflected ceiling plans show the location of lighting fixtures, ceiling coverings, decorative materials, fire sprinkler heads, smoke detectors, and air ventilation grills.

HVAC drawings detail the heating, ventilating and air-conditioning systems of the facility, including refrigeration systems or process freezers, coolers, and heaters. Control diagrams describe the regulation of important process and facility systems such as HVAC, building security, fire control, computer systems, and process operations. Fire protection plans include information about items that may include fire resistive walls and partitions, doors, fire extinguishers, alarms, lighting, smoke detectors, signs, fire suppression systems, and egress pathways. Plumbing detail drawings provide information needed to construct and connect piping to deliver and remove

fluids to and from fixtures and equipment located in or around the facility. Construction drawings encompass a complete set of drawings needed to guide the builders in construction of a facility. Construction drawings may include specific information for the following disciplines: civil/site, structural, architectural, electrical, interior and furnishing, plumbing, HVAC, process piping, utility piping, refrigeration, controls, electrical and mechanical.

## 4.2 Planning

Outputs for the planning phase of the project include:

- Scope of work.
- Goals and objectives.
- Project schedule.
- Identity of key participants.
- Project budget.
- Request for proposal (to solicit bids for facility design and construction).
- External interfaces (USDA, FDA).
- Planning session notes.

Food processing facility design and construction require a great deal of organized planning. The material in this section was developed over many years of planning exercises (Bowser, 1998). Information must be collected from a wide array of sources and combined into documents that are simple to read and share with others. Some documents will merely be checklists, or fill-in-the-blank sheets, whereas others will provide a detailed summary of project requirements, such as the materials handling needs for a particular ingredient.

Planning sessions should involve persons that represent all aspects of facility activity. Examples are production, maintenance, supervision, sales, accounting, receiving, warehousing, distribution, human resources, management, engineering, research and development (Bowser, 1999), key suppliers (products and services), government agencies, and consultants. Consultants include engineers, lawyers, insurance providers and other specialists that may not be regularly employed by the company. Scheduled planning sessions may proceed more smoothly when held at a convenient location that is free from normal work distractions. It is often desirable to obtain an unrelated third party to take notes, lead, and moderate planning sessions to retain objectivity and purpose. Having an agenda for each planning session is highly recommended.

Many of the elements to consider when planning food processing plants are given in this section. As each situation is unique, some elements may not apply and other important elements may need to be added. Elements are not listed in any particular order of importance. Lists of planning considerations are grouped under four headings.

1. Cross-cutting and multicategory issues (see [Table 21.1](#) and [Figure 21.1](#)).
2. Product.
3. Finance & economics.
4. Design.

Examples and a brief explanation of the desired input are given for selected elements.

#### **4.2.1 Cross-Cutting and Multicategory Issues**

The “Cross-cutting and multicategory issues” list contains elements that can be classified in two or more of the planning consideration areas of: product, finance & economics, and design.

1. Ethics.
  - a. Human welfare: personnel, consumers, stakeholders.
  - b. Product safety.
  - c. Animal welfare.
  - d. Environmental stewardship.
  - e. Citizenship.
  - f. Fiscal responsibilities.
  - g. Sales and marketing.
  - h. Technology utilization.
  - i. Sustainability.
2. Hygiene and sanitation.
  - a. Sanitary facilities (cleaning and sanitizing methods and systems required).
  - b. Standards and Standard Operating Procedures (SOPs): housekeeping, raw materials handling and storage, processed and finished product handling and storage, waste handling procedures, current Good Manufacturing Practices (cGMP), HACCP program, FSMA, identification and treatment of visitors, handling of hazardous chemicals.
  - c. Waste treatment, handling, disposal and recovery: wastewater pretreatment, secondary and tertiary wastewater treatment systems.
  - d. Facility design for cleanliness: cleaning and sanitation, layout, materials flow, materials handling, grease trap location, HVAC system pressure and balance, building exterior, floors and drains, walls and ceilings, ventilation (static pressure, temperature and humidity control, filtration, makeup, and circulation), lighting (interior and exterior), pest proofing, surface treatments and coatings, truck and railcar sanitation, warehouse wall and isles clearance, and ante rooms.
3. Market demographics.
  - a. Customer (location, age, income, habits, interests).
  - b. Transportation methods, carriers, and routes.
  - c. Segmentation.

- d. Sales.
        - e. Market forecast.
  - 4. Research and development.
    - a. New technology and applications: process/equipment, facility and design, product/package.
    - b. Cost savings, waste reduction.
    - c. Time savings.
  - 5. Safety.
    - a. Personnel.
    - b. Environmental.
    - c. Product and process: risk assessment, metal detection, line magnets and strainers, cGMP, explosion and other hazards, and regulatory requirements (local, state, federal, international).
    - d. Facility: protective guards for doors, walls and openings, alarm systems, and communications.
  - 6. Site selection
    - a. Footprint size of the proposed facility (area): footprint of individual areas (storage, cooler, processing, packaging, etc.), plan view of the proposed facilities layout, and estimate of expansion requirements.
    - b. Utilities: Source(s) and cost to provide utility service as shown in [Table 21.4](#). Review the impact of variable demand charges (if any) and limitations on quantity (e.g. concentration of waste discharge to treatment system). Consider including meters or other devices to record utility usage and provide data for improving operating efficiency.
    - c. Applicable code and permit requirements for business, construction, and environmental (local, state, federal, and international).
    - d. Expansion capability and space availability.
    - e. Parking and access: delivery trucks, truck drivers lounge, railcar, employee, fire and emergency vehicles, ice and snow removal, and special designation (inspector, visitor, customer, etc.).
    - f. Local labor pool.
    - g. Local infrastructure (training facilities, hospitals, schools, services).
    - h. Cropping practices.
    - i. Soil types.
    - j. Weather patterns.
    - k. Flooding.
  - 7. Timing
    - a. Startup and marketing.
    - b. Competition.
    - c. Emergent trends.

**Table 21.4** Utility Source, Availability, Capacity, Fee, and Rate

Utility	Source (provide contact name and phone number)	Hook-Up Fee	Capacity (maximum)	Rate
Electric			kW	\$/kW
Natural Gas			Therm	\$/therm
Water			Liter	\$/1,000 liter
Sewage			Liter per day	\$/1,000 liter
Solid waste			Cubic meter per day	\$/cubic meter
Other				

- d. Economy.
  - e. Business.
  - f. News headlines (political, outbreaks, consumer health).
8. Trends
- a. Consumer health and demand (organic, low-fat, nutritional).
  - b. Technology research and development (nutraceuticals, high pressure processing, ohmic heating).
  - c. Packaging (e.g. recyclable, plastic vs. glass, radio frequency identification device (RFID), microwaveable).
  - d. Process (e.g. process and analytical technology (PAT), just-in-time, lean manufacturing).
  - e. Labor (salaries, benefit packages, training history, ethnic background).
  - f. Facility design (single level, daycare, exercise facilities).
  - g. Construction (favored materials and techniques of installation, design-build, other).
9. Waste
- a. Elimination.
  - b. Reduction.
  - c. Recycling.
  - d. Disposal.

#### 4.2.2 Product

1. Describe the value-added products to be processed as shown in the examples given in [Table 21.5](#). Include future requirements.
2. Describe the physical properties of ingredients, intermediate and final product(s) (include or forecast ingredients in future plans). Intermediate products may be important in cases where physical properties and/or handling requirements of the intermediates are unique when compared to the ingredients and final product. Descriptions of ingredients and value-added products may include the following

**Table 21.5** Description of Product, Production Rate, and Package

Product	Production Rate			Package
	Min	Max	Period	
Sports beverage in 750 ml container, three recipes	500 per min	750 per min	Two, 10 h shifts	Plastic bottle with shrink label. Six and twelve packs in 24 bottle tray cases with plastic over-wrap.
Baked dog biscuits in four shapes	350 kg per h	400 kg per h	One, 8 h shift	1 kg net weight in a mylar bag in paper box
Pre-cooked, frozen sausage patties	250 patties per min	300 patties per min	Two, 8 h shifts	100-count, poly bag with a twist-tie in a corrugated box

information: common name of ingredient, source or specification, density (weight per volume), corrosive nature, viscosity (indicate temperature or range of temperatures), sensitivity to air, sensitivity to temperature, sensitivity to moisture, sensitivity to materials (contact), requirement for agitation or mixing, dustiness, flammability, volatility, reactivity, bridging, abrasive nature, toxicity, freezing point, boiling point, flowability, particle size, stiffness, thermal properties, and electrical properties.

3. Provide recipes and examples of product/packaging materials if available.
4. Product and process safety: coverings over exposed product and open containers, line magnets and strainers, metal detection, X-ray inspection, cGMP, and traceability.
5. Determine how ingredients or raw materials will be delivered to the facility (truck, rail, barge, pipe, delivery size, pallet or container size, stacking specifications, temperature, frequency, supply capability and plans for handling).
6. Determine how packaging materials will be delivered to the facility (truck, rail, barge, delivery size, frequency, pallet dimensions, stacking specifications, case size, plans for handling).
7. Describe how finished goods leave the facility (frequency, pallet requirement, wrapping, coding, handling requirement).
8. Refrigerated storage requirement (volume or area or amount of products/materials/pallets and temperatures) for proper handling, rotation and placement of goods.
  - a. Raw materials (ingredients).
  - b. Finished product.

- c. Rework.
- d. Long-term storage requirements for seasonal goods.
- 9. Ambient temperature storage requirement (volume or area or amount of products/materials/pallets).
  - a. Raw materials (ingredients).
  - b. Finished product.
  - c. Packaging materials.
  - d. Rework.
  - e. Long-term storage for seasonal products (estimate).
  - f. Incoming materials inspection and storage.

#### **4.2.3 Finance & Economics**

1. External image desired for the facility (e.g. state-of-the-art, expansive, futuristic, practical).
2. Return on investment required.
3. Cash available, interest rates, and financing.
4. Budget estimates for large expenses: site, facility, equipment, installation, consulting services, planning, training, startup, freight.
5. Marketing and sales history, and forecast.
6. Freight.
7. Packaging.
8. Negotiations for site incentives: labor rates, training, utilities, land, permitting, taxes, infrastructure, loans, grants, and credits.

#### **4.2.4 Design**

1. Expansion.
  - a. Facility.
  - b. Process.
  - c. Storage.
  - d. Waste treatment.
  - e. Utilities services.
  - f. Parking.
  - g. Access points and methods.
2. Test kitchen.
3. Research and development laboratory.
4. Pilot plant.
5. Seasonal processing requirements.
6. Water treatment needs.
7. Energy and process materials recovery systems.

8. Gray-side maintenance (placement of service equipment and high-maintenance portions of process equipment in rooms that are physically separate from production).
9. Type of construction (steel frame, concrete, panel, pre-packaged, etc.).
10. Ventilation and room/area static pressures.
11. Floor material and finish requirements or preference.
12. Drain types and locations.
13. Overhead clearance available or required in designated areas (especially processing).
14. Description of access requirements to facility and dimensions of openings.
15. Flooring, walls, and ceiling specifications in wash-down and special-use areas.
16. Floor drain size, type, and location in wash-down and process areas.
17. Type (drop-down, floor or wall) and number of utilities connections (electric, steam, water, air, etc.) in process areas.
18. Employee service facilities requirements such as drinking water fountains, toilet and lavatory facilities, change rooms, training or class rooms, retiring room, first aid, food service, exercise, wellness, day-care, and pet-care.
19. Process electrical equipment rating (wash-down, dust proof, explosion proof, etc.).
20. Electrical switch gear and motor control room location.
21. Emergency power: Indicate the amount (size or percentage of area) and temperature of refrigerated warehouse or facility area to be protected by an emergency power source (if any).
22. Process organization and flow.
  - a. Materials flow (product, waste, rework, packaging, ingredients, and intermediates) and storage.
  - b. Personnel flow.
  - c. Data collection and manipulation.
23. Level of process automation desired for the facility (e.g. manual, semi-automated or fully automated).
24. Level of packaging automation desired for the facility (e.g. manual, semi-automated or fully automated).
25. Carton or case requirements for products.
26. Internal image desired for the facility (e.g. state-of-the-art, modern, or utility).
27. Equipment preferences (suppliers, new or used).
28. Flexibility (changeovers, seasonal packs or products and future upgrades).
29. Reliability of equipment (lifetime requirement).
30. Structural materials available and preference.
31. Strategy for grouping separate refrigerated areas to maximize energy efficiency, materials handling requirements, and expansion needs.



32. Freezer design, frost management, foundation protection.
33. Disaster protection (hurricane, flood, earthquake).

### 4.3 Conceptual Design

Outputs that can be expected from the conceptual design phase include:

- Conceptual design studies.
- Models.
- Drawings (see [Table 21.3](#)).
- Cost estimate ( $\pm 30\%$ ).
- Code review (building, process, environmental).
- Conceptual design schedule.
- Major equipment (includes process, HVAC, and electrical) list and location plan.
- Materials of construction.
- Product and packaging specifications.
- Production rates.
- Area classification (clean-room, temperature or humidity control, hazardous materials, etc.).
- Control systems requirements.
- Structural material options.

Conceptual design of a new food processing facility involves conceiving it in the abstract, based on concrete instances, new knowledge, and visionary thinking. A thorough identification and assessment of the design problem is carried out as the initial task of this phase. Literature references such as books, catalogs, encyclopedias, journal articles, handbooks, websites, and patents should be fully utilized. [Lopez-Gomez and Barbosa-Canovas \(2005\)](#) recommend an evaluation of the socioeconomic context of the plant design. They also outline the latest techniques for analysis of process alternatives, mathematical modeling of food processing systems, and simulation of food plants.

Conceptual design assembles all of the facts generated in the planning phase. Planning results and information obtained from references are integrated with other reliable information such as historical processing data, design data, laboratory and pilot plant studies, and research results. A model of an existing process (if available) is a useful starting place. Open issues are addressed by commissioning design studies ([Bowser, 1999](#)).

### 4.4 Preliminary Design

Outputs expected from the preliminary design phase may include:

- Preliminary design studies.
- Drawings (see [Table 21.3](#)).

- Cost estimate ( $\pm 15\%$ ).
- Preliminary schedule.
- Preliminary design calculations.
- Major equipment (includes process, packaging, HVAC, and electrical) list and location plan.
- Preliminary construction specifications (structural materials options and materials of construction).
- Area classification (e.g. bio-safety level, explosion, fire protection).
- Safety analysis.
- Detailed building code analysis.
- Civil engineering code review.
- Control system functional specification.
- Instrument list.
- Electrical load data.
- Lighting levels and fixture identification.
- HVAC code investigation and operation plan.
- Equipment motor list.
- Design calculations.
- Pipe sizing and specifications.
- Environmental permits.
- Utility loads investigation.
- Building insulation specifications.
- Equipment specifications.
- Bid list and bid documents.

Preliminary design supplies the details needed to make the conceptual design into a functioning food processing facility using currently available equipment, materials, and techniques. Design studies may be needed in this phase to evaluate alternatives and to continue to develop conceptual design into full-scale operations ([Bowser, 1999](#)).

## 4.5 Final Design

Final design phase typically produces outputs such as:

- Drawings (see [Table 21.3](#)).
- Final cost estimate ( $\pm 10\%$ ).
- Construction specifications.
- Process equipment and installation.
- Specifications.
- Safety analysis.
- Calculations.

- Demolition plan.
- Permits.
- Instrumentation specifications.
- Control system specifications.
- Software design and specifications.
- Software test plan.
- Motor list.
- Purchase order preparation.
- Bid analysis.

In final design, all of the documents necessary for facility construction are generated and approved. Bid packages are sent to contractors and suppliers and subsequent quotations are evaluated using predetermined procedures. Quantitative bid evaluation methods are described by [Bowser \(1999\)](#). Based on the results, orders are sent to suppliers and contractors. All drawings are checked and revised as needed.

#### 4.6 Construction

The construction phase of the facility design process produces the following outcomes:

- Construction drawings.
- Construction specifications.
- Installation guidelines.
- Punch list.
- Operations and maintenance manuals.
- Record drawings.

Construction involves the physical phase and the beginning of the most visual aspects of the project. Activities may include site grading, utilities installation, and concrete work. In design-build projects, construction can start long before the final design has been completed. Any long-lead items (such as steel) require early orders. Environmental permits and site remediation are examples of issues that are handled as early as possible.

#### 4.7 Startup

The startup phase produces the following deliverables:

- Salable product.
- Non-salable product.
- Training classes/manuals.

The final phase of facility installation is startup. Startup includes the production of salable and non-salable product at partial and full production speeds. Significant materials and labor charges can be incurred during startup, and unforeseen delays in this phase can erode the confidence of management, financial supporters, and

personnel. Record drawings are completed by updating all drawings to reflect the installed and operating conditions (Shore and Jowitt, 1971).

## 5. CONCLUSION

Food processing facility design is a challenging, dynamic, and exciting activity that requires an organized, methodical approach to achieve success. Success is often celebrated when the facility has fulfilled the requirements of the startup phase on schedule and within budget. True success, however, is best measured by the long-term satisfaction of the plant management, operations, maintenance, engineering, and cleanup crews. The intrinsic value of advance planning and sound design and construction will be appreciated for many years in a food processing facility that is profitable, simple to operate, maintain, and adaptable to meet the changes of an industry that is constantly in transition.

## REFERENCES

- 3-A Sanitary Standards, Inc., 2012. The 3-A Symbol. <<http://www.3-a.org/symbol/about.html#benefits>>.
- Bliss, J., 2011. *Processing Your Food (Ethics of Food)*. Heinemann-Raintree Publishing, Mankato, MN, 56 pp.
- Bowser, T.J., 1998. Planning the Engineering Design of a Food Processing Facility, Fact sheet FAPC-104. Oklahoma State University, Food and Agricultural Products Center, Stillwater, Oklahoma.
- Bowser, T.J., 1999. Process Engineering Method for Food and Agricultural Products, Circular E-959. Oklahoma State University, Oklahoma Cooperative Extension Service, Division of Agricultural Sciences and Natural Resources, Stillwater, Oklahoma.
- Britannica Concise Encyclopedia, 2005. Canning. Encyclopaedia Britannica Premium Service, 22 July 2005. <<http://www.britannica.com/ebc/article?tocId=9359675>>.
- Burns & McDonnell, Inc., 2012. A New Taste of Regulation. <<http://www.burnsmcd.com/BenchMark/Article/A-New-Taste-of-Regulation>>.
- Cherok, G., 2005. Personal communication, Global Client Development Manager, Food, Beverages, Ingredients. Lockwood Greene Engineers, Cincinnati, Ohio.
- Clark, J.P., 2008. *Practical Design, Construction and Operation of Food Facilities*. Academic Press, Maryland Heights, MO, 328 pp.
- Connor, J.M., Schick, W.A., 1997. *Food Processing and Industrial Powerhouse in Transition*, second ed John Wiley and Sons, New York, pp. 117–118, 122, 234, 224.
- Cramer, M.M., 2006. *Food Plant Sanitation: Design, Maintenance, and Good Manufacturing Practices*. CRC Press, Boca Raton, FL, 304 pp.
- Ertas, A., Jones, J.C., 1996. *The Engineering Design Process*, second ed John Wiley & Sons, Inc., New York (Chapter 1).
- Etienne, G., 2006. *Principles of Cleaning and Sanitation in the Food and Beverage Industry*. iUniverse, Inc., Bloomington, IN, 418 pp.
- Fassl, J., Schweizer, K., 2004. Annual plant construction survey: plant projects tool down. *Food Eng.* 76 (6), 46–50.
- FDA, 1999. *Guidance for Industry: Antimicrobial Food Additives*. US Food & Drug Administration, Silver Springs, MD. <<http://www.fda.gov/Food/GuidanceComplianceRegulatoryInformation/GuidanceDocuments/FoodIngredientsandPackaging/ucm077256.htm#7>>.

- Food Engineering, 2003. 21 Years of Manufacturing Excellence, 75 (9), 79–90. BNP Media, Troy, Mich.
- Gilmore, T., 2003. Hygiene regulation in the United States. In: Lelieveld, H.L.M., Mostert, M.A., Holah, J., White, B. (Eds.), *Hygiene in Food Processing*. Woodhead Publishing Limited, Cambridge, England, pp. 44–57.
- Gottwald, F., Ingensiep, H.W., Meinhardt, M. (Eds.), 2010. *Food Ethics*. Springer Science + Business Media, New York, NY, 219 pp.
- Gould, G.A., 1965. Integrated computer systems. *Food Eng.* 26 (1), 76–87.
- Gould, W.A., 1994. *CGMP's/Food Plant Sanitation*. CTI Publications, Inc, Baltimore.
- Imholte, T.J., 1984. Engineering for Food Safety and Sanitation: A Guide to the Sanitary Design of Food Plants and Food Plant Equipment. Technical Institute of Food Safety, Crystal, Minn., pp. 14, 37, 268.
- Ishmael, W., 2002. Why future beef went under. *Beef Magazine*. Primedia Business Magazines and Media, Skokie, Ill, November.
- Jowitt, R., 1980. *Hygienic Design and Operation of Food Plant*. The AVI Publishing Company, Inc., Westport, Conn.
- Kletz, T., 1998. *Process Plants: A Handbook for Inherently Safer Design*. Taylor & Francis, Philadelphia, PA, 209 pp.
- Kutz, M. (Ed.), 2007. *Environmental Conscious Manufacturing*. John Wiley and Sons, New York, 306 pp.
- Lee, Q., 1997. *Facilities and Workplace Design, an Illustrated Guide*. Institute of Industrial Engineers, Engineering and Management Press, Norcross, Georgia, pp. 188 (Chapter 6).
- Lelieveld, H.L.M., Holah, J. (Eds.), 2011. *Hygienic Design of Food Factories*. Woodhead Publishing, Cambridge, UK, 824 pp.
- Lelieveld, H.L.M., Mostert, M.A., Holah, J., White, B., 2003. *Hygiene in Food Processing*. Woodhead Publishing, Limited, Cambridge, England.
- Lopez-Gomez, A., Barbosa-Canovas, G.V., 2005. *Food Plant Design*. Taylor & Francis Group, New York, pp. 10–14 (Chapter 2, 5).
- Majoor, F.A., 2003. Cleaning in place. In: Lelieveld, H.L.M., Mostert, M.A., Holah, J., White, B. (Eds.), *Hygiene in Food Processing*. Woodhead Publishing Limited, Cambridge, England, p. 210.
- Marriott, N.G., Gravani, R.B., 2006. *Principles of Food Sanitation*, fifth ed. Springer, New York, NY, 427 pp.
- De Meirleir, M. (Ed.), 2007. *Location, Location, Location: A Plant Location and Site Selection Guide*. Haworth Press, Inc., Philadelphia, PA, 184 pp.
- Milledge, J.J., 1980. *The Hygienic Design of Food Plant: Liquid 'hold-up'* (Ph.D. thesis). University of Reading, pp. 22, 26, 36.
- Morris, C.E., 2003. 75 years of food frontiers. *Food Eng.* 75 (9), 54–63 (Troy, Mich.: BNP Media).
- Packaged Facts, 2012. A Division of MarketResearch.com. <<http://www.packagedfacts.com>>.
- Parker, M.E., Litchfield, J.H., 1962. *Food Plant Sanitation*. Reinhold Publishing Corp, New York.
- Pehanich, M., 2003. Hail to the innovators: the food engineering hall of fame. *Food Eng.* 75 (9), 65–78 (Troy, Mich.: BNP Media).
- Robberts, T.C., 2002. *Food Plant Engineering Systems*. CRC Press LLC, Boca Raton, Florida, pp. 203.
- Rosen Yngve, H.S.H., Blombergsson, H., 1963. *Milk Plant Layout*. Food and Agricultural Organization of the United Nations, Rome.
- Saravacos, G.D., Kostaropoulos, A.E., 2002. *Handbook of Food Processing Equipment*. Kluwer Academic/Plenum Publishers, New York, pp. 1–46.
- Shore, D.T., Jowitt, R., 1971. Design and operation of food plant. In: Fox, A. (Ed.), *Hygiene and Food Production*. The Williams and Wilkins Company, Baltimore, p. 134.
- Singer, P., Mason, J., 2007. *The Ethics of What We Eat: Why Our Food Choices Matter*. Rodale, Inc., Emmaus, PA, pp. 151–169.
- Sperber, B., 2011. 2011 Manufacturing Trends Survey: One Percent Better. <<http://www.foodprocessing.com/articles/2011/manufacturingsurvey.html>>?

- Swann, L., 2007. Food and Beverage Market for Kids Growing Like a Weed. <<http://www.foodprocessing.com/articles/2006/126.html>>.
- Thomas, G.C., 1964. How Sara Lee tackled computerized handling. *Mod. Mater. Handl.* 19 (8), 34–37.
- Trager, J., 1995. *The Food Chronology*. Henry Holt and Company, Inc, New York, Chapter 1.
- US Department of Defense, Office of Civil Defense with US Department of Agriculture, Agricultural Research Center, 1970. *Facility Protection for Food Processing Plants: An Industrial Civil Defense Handbook for Minimizing Damage in Case of Nuclear Attack*. US Government Printing Office, Washington, D.C., pp. 1, 2, 14.
- Wieringa, G., Holah, J.T., 2003. Hygienic plant design. In: Jowitt, R. (Ed.), *Hygiene Design and Operation of Food Plant*. The AVI Publishing Company, Inc., Westport, Conn., pp. 79–108.

This page intentionally left blank

# Sanitary Pump Selection and Use

**Timothy J. Bowser**

Oklahoma State University, OK, USA

## 1. INTRODUCTION

Sanitary pumps transport and meter liquids and liquid–solid mixtures of food and agricultural products. “Sanitary” means that the pump is cleanable by manual or automated techniques. Sanitary pumps are frequently used in the food and pharmaceutical industries when product integrity and cleanliness are important. Identification and selection of a suitable sanitary pump is a task that can be difficult or confusing.

Before making a decision to install a sanitary pump, other alternatives should be investigated. Pumps are expensive to purchase, install, and maintain. Designing a system that makes use of gravity to transfer product instead of a pump reduces system cost and complexity. Combining operations in a single vessel can also eliminate the need to pump product to separate stations. For instance, a solitary vessel may be used to cook, cool, mix, and deaerate product.

Another method used to reduce the need for mechanical pumping is pressure pumping. Pressure pumping uses a vessel as the pump cavity. The headspace of a vessel containing a product to be pumped is pressurized with a clean, product-compatible gas, such as filtered air or nitrogen. The gas pressure forces the product out of the tank, through piping, to its required destination. A drawback of the pressure method is the higher cost of pressure-capable vessels and the limitation of a batch process.

Many varieties and versions of sanitary pumps are available. Pumps are often sold separately from other critical pumping system components, such as drives, couplings, stands, and gear reducers. Selection and successful installation of a sanitary pump requires a great deal of knowledge about the process, environment, and product to be pumped. Mistakes in pump specification and operation can be costly in terms of capital expense, process losses, product recall, loss of product quality, facility downtime, and utility costs. This chapter provides a guide for sanitary pump selection and use.



## 2. SANITATION STANDARDS FOR PUMPS

Sanitation standards for different products vary, depending on the owner and customer, the regulatory agency governing processing activities, as well as the local or on-site inspector(s). The Food and Drug Administration (FDA) enforces the Food, Drug, and Cosmetic Act, as well as other standards. Good Manufacturing Practices (GMPs) were developed to establish criteria in determining compliance with the FDA standards, particularly in regard to the terms “sanitary” and “unsanitary”. GMPs lack specificity when it comes to describing acceptable equipment, including sanitary pumps. Lack of specificity permits interpretation and allows inspectors to account for the variables encountered in the field. Current GMPs for manufacturing, packing, or holding human food can be found in the Code of Federal Regulations (CFR), Title 21, Part 110.

The United States Department of Agriculture (USDA) has exclusive jurisdiction in the areas of meat, poultry, and egg products. Regulations can be found under Title 9, CFR. The USDA publishes a list of accepted processing equipment that is available (USDA, 2012) from their website ([www.ams.usda.gov](http://www.ams.usda.gov)), which also has downloadable forms (DA-157, DA-162) for equipment evaluation. Firms are expected to comply with GMPs and to work with the on-site inspector to determine suitability of fluid handling equipment. Voluntary standards for sanitary pumps are published by various organizations. 3 A Sanitary Standards, Inc., McLean, Virginia, maintains the 3 A Sanitary Standards. This widely accepted voluntary standard provides criteria for the sanitary construction and installation of dairy processing equipment. The 3 A Sanitary Standards are often applied to processes other than dairy.

## 3. SANITARY PUMP CLASSIFICATION

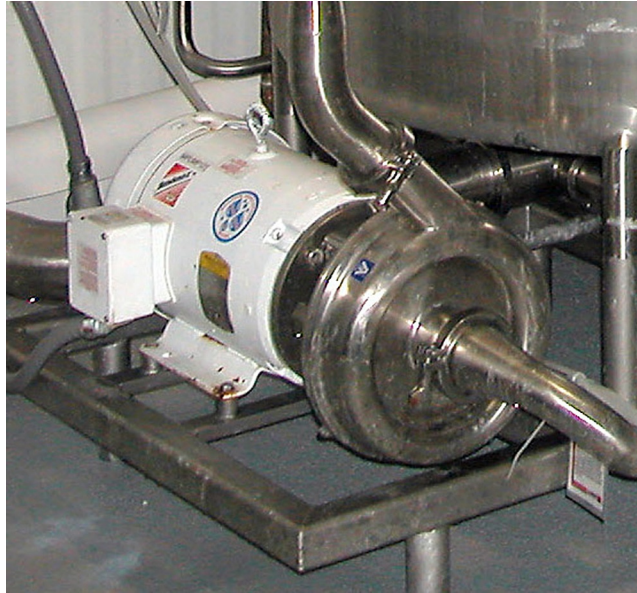
Sanitary pumps are classified as follows:

- Centrifugal.
- Positive displacement.
- Jet.
- Airlift.

These pump classifications are explained in detail in the following subsections.

### 3.1 Centrifugal

The two main components of a centrifugal pump (Figure 22.1) are the rotating impeller and stationary casing. The high-speed impeller produces liquid velocity, while the casing forces the liquid to discharge from the pump, converting velocity to pressure. The relatively simple design of these pumps makes them ideal for many



**Figure 22.1** Centrifugal pump.

**Table 22.1** Products Typically Moved by Sanitary Centrifugal Pumps

Industry	Product
Bakery	Yeast creams, sweeteners, fats, oils, frying oil, batters, flavorings
Beverage	Sweeteners, flavorings, acids, juices, wort, wine, beer, concentrates
Confectionary	Sweeteners, creams, syrups, frosting
Dairy	Milk, cream, whey, ice cream
Fruit and vegetable	Wax solutions, hydro-cooling systems, washing systems, transportation systems
Meats	Brine solution, flavorings, fats, blood, frying oil, frying batter
Other	Cleaning solutions, water, heat exchange fluids, pH buffers

sanitary applications. A list of products typically handled by centrifugal pumps is given in [Table 22.1](#).

Centrifugal pumps are well suited to applications involving variable flow rates. Their flow capacity can be regulated by throttling, recycling, and by varying impeller speed. Throttling requires an adjustable valve in the discharge piping and provides one of the most inexpensive and reliable means of flow control. Drawbacks of throttling are an increase in system pressure and wasted energy. Unrestricted pipe flow with recycling may not be the best solution, as most pumps operate at peak performance

with backpressure. Also, the pump may be difficult to control, and inefficient (Driedger, 2000). Impeller speed can be varied using adjustable speed drives; however, this option is not commonly exercised. The range of flow adjustment is limited to mid to higher flows, as the typical pump and system curves are nearly parallel at low flows, making control difficult (Driedger, 2000).

Centrifugal pumps should not be used on foods with viscosities greater than 500 cP, foods that include particles that must be kept intact, and shear-sensitive materials. Centrifugal pumps, depending on how they are installed and operated, may also incorporate air into pumped materials. Some equipment manufacturers have taken notice of how well centrifugal pumps shear products as they are being pumped and have modified them to take a greater advantage of this characteristic. The Powder Mixer, by Fristam ([www.fristam.com](http://www.fristam.com)), is one example of a modified centrifugal pump used to thoroughly mix powders into liquids.

### 3.2 Positive Displacement

Positive displacement, or PD, pumps have an expanding cavity on the suction side of the pump and a decreasing cavity on the discharge side. Liquid flows into the pump as the cavity on the suction side expands and is forced out of the discharge side as the cavity collapses. Figure 22.2 shows a few of the many variations of positive displacement pumps, including: (a) rotary piston, (b) rotary lobe, (c) tubing, (d) gear, (e) progressive cavity, (f) piston, (g) vane, and (h) diaphragm. The same principle of operation applies for each variation.

A PD pump, unlike a centrifugal pump, will produce the same flow at a given speed, independent of discharge pressure (neglecting slip, or backflow through clearances between components). A PD pump cannot be completely throttled or dead-headed (operated against a closed valve on the discharge side). If dead-heading is attempted, it will continue to produce flow, increasing the pressure in the discharge line until either the line bursts, the pump is damaged, or both. The most practical means to control flow rate is to adjust component speed with a variable-speed drive. Table 22.2 lists products typically handled by PD pumps.

### 3.3 Jet and Airlift

Jet and airlift pumps are not as common in sanitary applications as centrifugal and PD pumps. The jet pump (Figure 22.3) operates on the velocity energy of a fluid jet. The fluid is forced through a jet or nozzle so that all or nearly all of its energy is converted to velocity energy. The energy is directional and applied to the fluid to be moved. Jet pumps are frequently used for pumping sumps or process residues that contain solid matter or chemically active materials. When the jet is produced by a recirculated



**Figure 22.2** Positive displacement pumps (a) rotary piston, (b) rotary lobe, (c) tubing, (d) gear.

stream (as shown in [Figure 22.3](#)), the centrifugal pump must be protected from damage by solid particles in the fluid stream ([Henderson \*et al.\*, 1997](#)).

An airlift pump is shown in [Figure 22.4](#). It is not a pump in the strictest sense because it does not significantly alter the pressure or velocity head of the fluid in any practical degree ([Henderson \*et al.\*, 1997](#)). Air or other gas is delivered at the bottom of the lift pipe and mixes with the liquid. The air–liquid mixture, with lower specific weight than the liquid, rises in the pipe and is discharged at the point above the level of the liquid. This device can be used for elevating liquids that contain foreign



**Figure 22.2 (Continued) Positive displacement pumps** (e) progressive cavity stator (black plastic) and rotor, (f) hand operated piston, (g) rubber vane, and (h) diaphragm for chemical metering.

materials or are corrosive. Twenty to 40% of the energy used to compress the gas is effective in elevating the liquid (Henderson *et al.*, 1997).

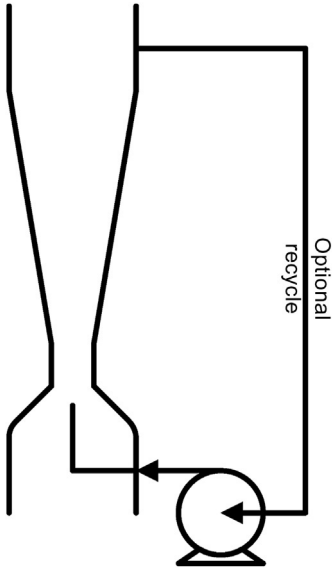
#### 4. SELECTING SANITARY PUMP TYPE

Selection of sanitary pumps is discussed in this section. A decision tree for selecting between centrifugal and PD sanitary pumps is given in Figure 22.5. The units for viscosity, given in Figure 22.5, are centipoise. Application requirements in five areas should be identified to properly select and apply a sanitary pump:

1. Process requirements.
2. Product properties.

**Table 22.2** Products Typically Moved by Sanitary Positive Displacement Pumps

Industry	Product
Bakery	Yeast creams, sweeteners, fats, oils, frying oil, batters, flavorings, fruit fillings, dough
Beverage	Sweeteners, flavorings, acids, juices, wort, wine, beer, concentrates, pulp
Confectionary	Sweeteners, creams, syrups, frosting, chocolate, cocoa butter, fondants, nougat
Dairy	Milk, cream, whey, ice cream, soft cheese, yogurt, butter
Fruit and vegetable	Wax solutions, hydro-cooling systems, washing systems, transportation systems, tomato base, whole fruit and vegetable in liquid base, diced fruit and vegetables in liquid base, cream-style vegetables, fruit purees, concentrates
Meats	Brine solution, flavorings, fats, blood, frying oil, frying batter, meat emulsions, ground meat, rendering products
Other	Baby food, cleaning solutions, gravy, heat exchange fluids, mayonnaise, pH buffers, soups, chunky sauces, salsa, gelatinized starch, water



**Figure 22.3** Jet pump.

- 3. Operational requirements.
- 4. Cost.
- 5. Safety.

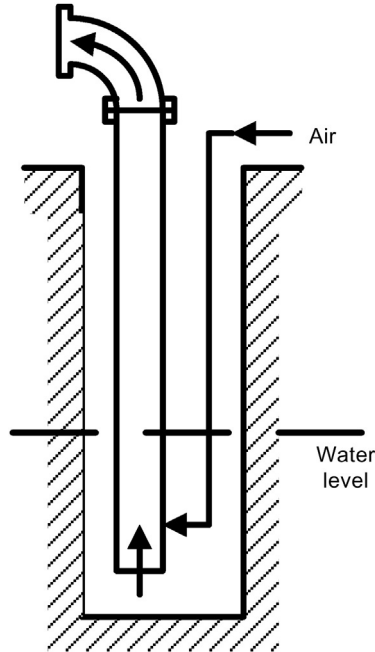


Figure 22.4 Airlift pump.

#### 4.1 Process Requirements

Process requirements define the information necessary to select a pump that meets the needs of production. Typical process requirements that should be considered when selecting a sanitary pump are shown in Table 22.3. A flow rate or range must be defined based on the present and future needs of the process. Examples are “how much product must be pumped to empty the tank in the desired time?” or “how much product must be pumped to provide enough product to the next unit process?” A design flow rate fulfills the process requirement. The maximum flow rate is the most the pump can deliver as installed and operating under expected conditions. Maximum flow rate is considered for future expansion requirements or certain processing needs such as rapid product transfers.

Pressure rating of the pump is an important issue. Factors to consider include rated pressure of the pump and piping, product sensitivity, and energy. The pump manufacturer will specify the upper pressure limit for the pump. Sanitary piping systems are frequently constructed of schedule 5 tubing (referred to as “piping” in this chapter) and fittings that are either joined by welds or clamp-type connections (Bowser and Choudhary, 2004). Clamps are used to join components when the piping must be disassembled for reconfiguration, cleaning, or inspection. The upper pressure limit for typical piping and connectors ranges from 500 to 20,000 kPa, depending on factors such as connector type, product temperature, and installation and service conditions.

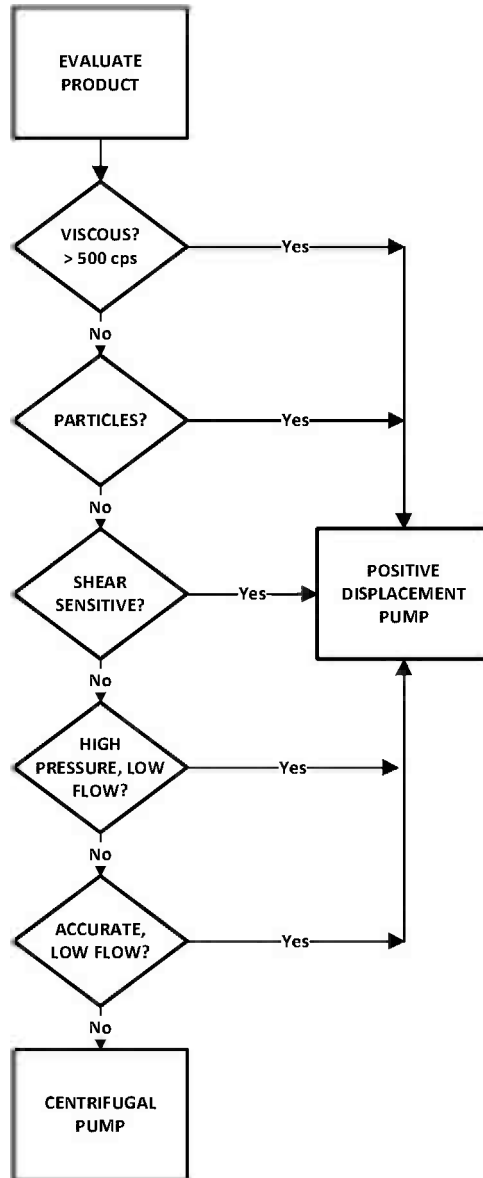


Figure 22.5 Decision tree for pump selection.

In many systems, the pressure must be calculated for the given product, process conditions, and piping arrangement. Assistance with this task can be obtained from the equipment supplier or vendor. [Steffe and Singh \(1997\)](#) provide an excellent resource for pipeline design for food products. Line diameter can be increased or decreased to



control pressure and fluid velocity. It is customary to limit product flow rate to achieve a head loss of under 0.45 kPa/m of pipeline. Reduction of pressure losses by increasing pipe diameter are limited, in part, by the cost of installation. An estimate of the relative cost of installation of different diameters of sanitary piping, including valves and insulation, is given in [Table 22.4](#). Also, a minimum product flow rate may be specified to control product settling, temperature loss, or other physical phenomena. A minimum pipeline diameter may be specified to accommodate passage of particles in the product.

Product temperature requirements are critical for a variety of reasons, including melting and freezing of products, viscosity, ingredient degradation, pasteurization, and other product quality and thermal treatment issues. Process designers and operators will need to know the target temperature of the product and the allowable minimum and maximum temperatures. Lines will be appropriately insulated, heat traced, or refrigerated to help meet targeted temperature. Discussion of the importance of product temperature is continued in the following section on product properties.

## 4.2 Product Properties

Product properties provide the information needed to select the pump based on the characteristics of the pumped product. [Table 22.5](#) lists product properties that are

**Table 22.3** Process Factors to Consider When Selecting a Sanitary Pump

Item #	Process Requirements	Value or Range (to be Completed by User)
1	Design flow rate	
2	Design temperature	
3	Maximum flow rate	
4	Maximum temperature	
5	Minimum flow rate	
6	Minimum temperature	
7	Pipe diameter	
8	Pressure rating	

**Table 22.4** Relative Cost of Sanitary Piping (Tubing) Installed in Food Plants

Pipe (Schedule 5 Tubing) OD, cm	Relative Cost
5.1 (and under)	1.0
7.6	1.2
10.2	1.3
15.2	1.6
20.3	1.9

Based on estimates made by a national contractor.

Costs include materials and labor for overhead (suspended) installation and include insulation and miscellaneous costs. The values are assumed per 30 m of pipe length: eight 90 s, four Tees, six valves.

often considered. The ingredient or product name may be the only item required to specify product properties because the behavioral properties are well known. In other cases, physical properties of the product may not be documented. If estimation is not possible or acceptable, laboratory measurements are required (Abdulagatov *et al.*, 2011; Steffe and Daubert, 2006; Steffe and Singh, 1997).

Temperature of the product is critical, as physical properties like viscosity (a measurement of resistance to flow) vary with product temperature. Further, some positive displacement pumps feature extremely close tolerance between the impeller and casing to improve pumping efficiency. These close-fitting parts are designed to operate within a specified temperature range. If the range is exceeded, component expansion could damage the pump. For example, Waukesha Cherry-Burrell PD pumps ([www.gowcb.com](http://www.gowcb.com)) can be ordered with “standard” (below 93°C) or “hot” (up to 149°C) clearance rotors, to operate in the desired product temperature range.

Product particle size information is needed when particle integrity must be maintained or if the particles could interfere with the operation of the pump or other process equipment. Examples of particles are whole fruits, fruit pieces, meat chunks, noodles, nuts, and spices. PD pumps are frequently specified based on their ability to move food particulates with minimal physical abuse. A rule of thumb is to specify a pump with an inlet and outlet diameter that is at least 1.5 times the size of the greatest expected particle dimension. Considering the case of large particle size and low product flow, the PD pump will be oversized and operated under capacity. Reduced pump rpm may have a negative effect on suction capability, may cause pulsation, and impact the drive design.

Information on chemical activity of the product is needed for specifying construction materials for the wetted pump parts. Handling highly acidic or caustic products

**Table 22.5** Product Properties that are Frequently Considered When Selecting Sanitary Pumps

<b>Product Properties</b>	<b>Comments</b>
Abrasiveness	Relates to wear of contact surfaces and pump design to reduce consequences
Corrosiveness	Temperature, pH, concentration, time of contact, surface geometry, surface finish, and contact materials composition
Density	Mass per unit volume
Hazardous	Potentially harmful to human health or the environment
Particle size	Used to help determine internal passage dimensions for pump, valves, and piping
Shear sensitivity	Product textural issues and pump design/application
Temperature	Effects physical properties like viscosity, vapor pressure, phase, and color
Vapor pressure	Relates to cavitation, and vapor lock
Viscosity	Indication of resistance to pumping

and wash solutions may require special materials (e.g. 316 L, AL6XN, Hastelloy, or other) to help prevent corrosion. Vibration, high pressure, high temperatures, and ambient conditions can act together to accelerate corrosion of product contact surfaces of the pump over time. More information on selection and corrosion of steel is available from [CSI \(2012\)](#), [Revie \(2011\)](#), and [Roberge \(2000\)](#).

Shear sensitivity refers to the effect of the pump's mechanical movement in contact with the product. An example is the "cutting" action of an impeller. Physical characteristics of some products will change after exposure to high shear. For instance, fat particles in meats may "smear" when under high shear conditions, resulting in a greasy, mealy mouth feel that is undesirable.

Vapor pressure in an enclosed area above the product to be pumped at equilibrium conditions can be a critical factor. If the pressure in the pumping system is below the vapor pressure of the liquid, "flashing" will occur. Flashing is the vaporization of a product component into gas. Gas pockets that have formed around the impeller may vapor lock the pump. Gas bubbles within the product will collapse when the system pressure exceeds the vapor pressure. The phenomenon of bubble collapse is known as cavitation. Cavitation occurs most frequently near the pump impeller (where product pressure is rapidly increasing) and energy transferred by collapsing bubbles can severely damage product-contact surfaces. Cavitation in the pump may be eliminated by increasing the pressure at the suction side to prevent bubble formation. This is often accomplished by stuffing the pump with product under pressure from another pump, or by including a gravity leg in the piping. A gravity leg may take the form of a vertical pipeline or tank and makes use of the static pressure of the product to increase the pressure at the pump inlet.

As mentioned above in the process requirements section, melting and freezing points should be considered for products that could solidify during processing or downtimes. Chocolate, and some oils, for example, may freeze in lines under certain conditions. Insulation, heat tracing, and ambient temperature control can be used to help control phase-change issues. Some pumps are available with integrated steam traces or jackets to maintain product temperature in the casing.

### 4.3 Operational Requirements

Operational requirements ([Table 22.6](#)) determine how the pump will be installed and function in the plant. Plant environmental conditions and available utilities must be identified to ensure a safe and reliable installation. Environmental conditions include specifications of utilities such as electrical, hydraulic, and compressed air at the point of installation, ambient temperature range, wash-down or cleanup procedures encountered at the site, physical accessibility for maintenance and operations, and the presence of hazardous materials.

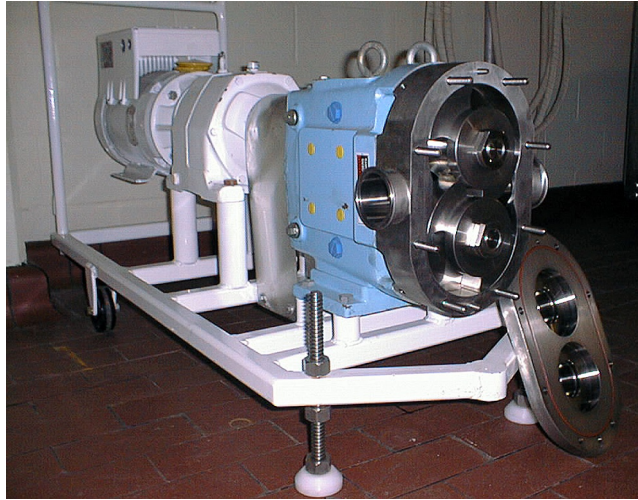
**Table 22.6** Operational Requirements to Consider When Selecting a Sanitary Pump

<b>Item #</b>	<b>Operational Requirement</b>	<b>Value or Response (to be Completed by User)</b>
1	Ambient temperature range	
2	Cleaning and sanitation (product contact) procedures	
3	Control scheme (manual, automatic, semi-automatic)	
4	Electricity, hydraulic fluid, or compressed air available	
5	Fixed or portable	
6	Hazardous conditions	
7	Hours of operation	
8	Physical accessibility	
9	Protection scheme (strainer, magnet, metal detector, pressure, current, vibration sensor)	
10	Speed (capacity) range	
11	Type of drive (fixed, variable speed, mechanical, variable frequency)	
12	Wash-down (external) procedures	

Sanitary pumps are normally powered by electricity, hydraulic fluid, or compressed air. Pumps powered by compressed air and hydraulic fluids (referred to as “fluid powered” pumps) may be less expensive to purchase initially, but are often more expensive to operate compared to electrically powered pumps. Fluid powered pumps can be more convenient from the standpoint of controls and size. They are also generally safer for environments with explosion hazards.

It is important to have knowledge of equipment cleanup procedures used in the facility or to control how equipment will be cleaned. The pump may be subject to, for example, hot, high-pressure water (external washing) and corrosive chemicals (both internal and external). Identify the presence, concentration, and time that the pump is exposed to potentially damaging elements and select contact materials accordingly. Pump systems must be designed to withstand the local elements and any foreseeable changes in cleanup procedures. If the pump is frequently disassembled for manual cleaning or component cleaning in automatic washers, padded racks or other accessories should be designed and implemented to protect the parts from abuse.

Manual pump control is initially the most inexpensive and least complicated control option, but may be more costly over time as a result of labor requirements and process needs. Fixed pump speeds can be implemented using a motor with a direct-gear or belt drive system. Multiple, discreet speed requirements can be obtained with a motor and a multiple-speed gear drive or a belt drive with multiple sheaves. Speed adjustment for fluid powered pump drives is accomplished by controlling the flow of the power media. AC variable-frequency drives (VFD), and mechanical, adjustable-speed drives are available for continuous pump speed control over a specified rate of



**Figure 22.6** *Portable PD pumps.*

rotation (rpm) range. Mechanical, adjustable-speed drives have a higher initial cost, lower efficiencies, and require additional maintenance compared to VFD.

Pump head and drive motor rpm are important design factors to consider. Particle integrity, pulsation, and suction issues were already mentioned in the process requirements and product properties sections. Product flow (neglecting slippage) is directly proportional to the rpm of a PD pump. Drive motors are designed to function at peak performance within a given rpm range. When the rpm range differs from the desired rpm range of the pump, a speed reducer or multiplier (transmission) is required. This is especially common for electric drives. The pump shown in [Figure 22.6](#) is driven by an electric motor with a nameplate rpm of 1,750. Peak performance of the motor, controlled by a VFD, is between 800 and 1,750 rpm. A 10:1 mechanical gear reducer was included to reduce the rpm of the drive to a range of 80 to 175, which is appropriate for the pump head and application.

#### **4.4 Cost**

Expense is a major criterion in the selection of sanitary pumps. Sanitary pumps are inherently expensive in part because of use of unique construction materials and stringent requirements for cleaning and inspection. The need for frequent assembly and disassembly necessitates rugged components that can be easily removed and replaced. Sanitary pumps must be exceedingly reliable because pump downtime translates to costly production downtime. Expensive construction materials, special surface finishes, quick-change parts, ruggedness, and reliability all contribute to higher equipment cost. Installation expense increases when appropriate product and human safety factors (discussed in the section on safety) are included. Portability and other factors, described in the installation section, also

increase cost. Cost of portability (disconnects for piping, utilities, and controls) may be offset by savings gained when using the pump in multiple production lines.

Maintenance and operation costs of a pump should be considered when comparing pump alternatives. Lower initial pump costs do not always result in increased savings. Limiting the number of unique pump types and sizes in a processing facility can reduce spare parts inventory and simplify maintenance.

## 4.5 Safety

Human, product, and equipment protection are safety issues to be considered when installing pumps. Human protection is foremost. Rotating components of pumps should be adequately guarded to prevent entanglement of hands, clothing or limbs. Hot surfaces can be guarded or insulated. Design should include a review of maintenance activities required for the pumping system and address accessibility issues. Pumps located on the same pipeline as steam or other gas or fluid injection devices must include a check valve or means to prevent the injected media from entering the pump. A major steam leak flowing through the pump, for example, could cause the pump to rotate at high speeds, potentially resulting in an explosion.

Product safety in pumping systems is accomplished by using strainers, metal detectors, line magnets, or X-ray equipment. These devices should be installed in the pipeline ahead of the pump if possible to protect it from damage by foreign materials. Strainers and line magnets can be installed in a duplex arrangement to facilitate operations. Duplex installations allow periodic cleaning and inspection of one protective device while the other, identical device, remains on-line. [Figure 22.7](#) gives a schematic of a duplex strainer arrangement. Some pumps, by the nature of their design or type of contaminant expected, are insensitive to many types of contaminants in the product stream. For example, diaphragm pumps may not be damaged by metal particles below a given size.

Physical protection of sanitary pumps is imperative, as they are valuable and pump failure may result in costly downtime. Protection schemes in addition to those already mentioned include: over-pressure, run-dry, over-current, bearing-wear, and external impact or abuse. Over-pressure protection can be as simple as a spring-operated pressure-relief valve. Run-dry conditions occur when the pump is operated without product. A downstream pressure sensor (or current sensor on electric pump drives) combined with a controller can be used to protect the pump from over-pressure and run-dry conditions. Vibration sensors and analysis packages are available that can be used to predict the failure of mechanical components such as bearings, seals, and drive parts. Some pump designs are less susceptible to mechanical failure than others. Check with the pump supplier for recommendations on pump protection.

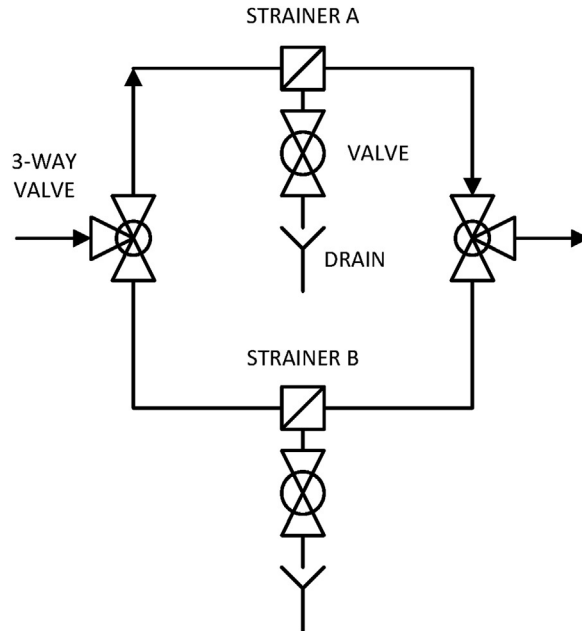


Figure 22.7 Schematic of a duplex strainer system for pump protection.

## 5. INSTALLATION

Sanitary pumps can be installed with drives on fixed or portable bases. Portable pumps (see example in [Figure 22.6](#)) are designed to increase flexibility of operations and are ideal for situations where a pump or pumps can be used on multiple lines that do not run simultaneously. Portable pumps also facilitate maintenance and cleanup. Whether fixed or portable, the pump base should be rugged and sanitary. Rugged means the base must withstand rough treatment by workers, including fork trucks, and use as a step-stool. It also must function to protect the pump components and operators.

Carefully designed and constructed pump stands facilitate adjustment and maintenance of drive shaft alignment, protect components, and are simple to clean and inspect. Sanitary designation indicates that the pump base is easily cleaned, self-draining, and is free from ledges, cracks, and crevices that collect debris. Tips on the sanitary design and installation of food equipment that can be applied to pump stands are available from [Schmidt and Erickson \(2012\)](#).

Use of corrosion resistant materials, like stainless steel, is becoming more widespread throughout the food industry. Stainless motor housings and gear casings, plastic enclosures and seal-tight fittings are examples of sturdy, corrosion resistant components. Pump systems without painted surfaces require less maintenance and can

provide a higher level of product safety. Products left in pumps for long periods between cleanup activities, can result in ordinary corrosion and microbially induced corrosion (MIC). This is not normally a problem in the food industry, because of periodic cleaning, but used equipment, stored equipment, and systems that have undergone lengthy startups may have unexpected corrosion. Pumps and associated stainless piping should be passivated as described in ASTM standards A967 (ASTM, 2002) and A380 (ASTM, 2006).

Pump controls may be integrated with the VFD, wirelessly connected, or remote mounted. Completely sealed, touch-sensitive keypads have generally replaced bulky switches and buttons. In the future, controls may be entirely hands-free, relying on operator gesture, posture or speech. Fluid power drives, electrical contacts, control hardware, and other ancillary equipment can often be located outside of the food processing envelope, in a maintenance alley, dedicated room, or overhead attic. This practice saves valuable space and reduces maintenance activity in food processing areas. Maintenance operations performed outside of the food processing envelope can be more convenient for workers and pose fewer food safety issues.

## 6. CLEANING AND MAINTENANCE

Pumps and associated hardware may be cleaned using three possible methods: Clean-in-Place (CIP), Clean-out-of-Place (COP), and manual cleaning. CIP involves the circulation of various rinsing, cleaning, and sanitizing fluids through the system without disassembly. CIP cleaning relies on the turbulent motion of a pumped fluid and the cleaning power (at a given temperature and concentration) of added chemicals to remove soils (Seiberling, 1997). A Reynolds number greater than 10,000 is preferred for CIP cleaning to achieve adequate turbulence. PD pumps naturally restrict fluid flow to their highest capacity, which is determined by displacement and maximum rpm. In most cases the top flow capacity of a PD pump is far below the flow rate required for effective CIP. A bypass circuit (Figure 22.8) is required to achieve the required flow rate. The bypass circuit is active only during CIP and is opened with automatic valves. Pumps must be rated for CIP cleaning, and it is normally the end user's responsibility to determine the suitability of the pump for the intended application. Pump cases must be self-draining at the end of the CIP cycle, unless other provisions to prevent bacterial growth are in place (e.g. pressurized water with sanitizer).

COP cleaning of pumps and related components is frequently practiced in the food industry. It is also recommended to periodically COP pumps used in CIP systems. COP practices require the disassembly of the product-contact parts of the pump into parts or elements that can be effectively washed in an automatic parts washer. Valuable pump parts are often placed into mesh baskets or specially designed racks that can be loaded into washers for processing. Parts holders are designed to facilitate parts tracking and to minimize abuse





**Figure 22.8** *Bypass circuit for CIP operations with PD pump.*

in handling and washing procedures. Dedicated tools, specific procedures, and precision training make COP processes safer, less expensive, and more effective.

Manual cleaning of pumps and pumping hardware is common practice that has been successfully used for decades. Manual cleaning is similar to COP cleaning, except a parts washer is not included. A trained technician washes parts by hand. Each part in this process receives individual attention and inspection. Repeatability and process verification is more difficult because of day-to-day differences in an operator's technique and variations between operators. Manual cleaning tends to be more expensive because of increased labor requirements and may be more hazardous when strong cleaning chemicals are used.

Cleaning issues are often overlooked during the design and installation of sanitary pumping systems. Ample space is needed to access parts for disassembly and handling. Good lighting is required to see surfaces and to identify potential mechanical or hygiene situations. Mechanical assistance may be needed to handle heavy, awkward parts. Floors and parts may become slippery because of spilled product or other materials, surface finishes or coverings and good technique are required to reduce accidents and parts damage.

## 7. CONCLUSION

Production processes should be designed to minimize the use of pumps, which are costly to install and maintain. When required, selection of sanitary pumps can be a complicated task. Physical characteristics of products to be pumped are often unavailable and difficult to estimate. The problem is further compounded when pumps are used for a variety of products with diverse characteristics and pumping requirements. Regulatory standards and the processing environment and procedures heavily factor into pump selection.

The sheer number of pumps available can be overwhelming. Food Engineering's Food Master on-line database ([www.foodmaster.com](http://www.foodmaster.com)) lists more than 75 manufacturers under the heading "Pumps, Sanitary". A strategy for the selection of pumps is needed and a basis is provided in this article. For a general guide on the selection and purchasing of food processing equipment, see [Bowser \(1999\)](#).

When possible, visit similar processing establishments to learn about pumps and pumping applications that have worked well for others. Talk to suppliers and investigate the used equipment market and the cost of replacement and spare parts. Consider long-term, as well as short-term, costs of pumping systems when making a purchase decision. Properly selected, installed, and maintained pumps will provide many years of service and less distraction for busy plant operators and managers.

## REFERENCES

- [Abdulagatov, I.M., Magerramov, M.A., Abdulagatov, A.I., Azizov, N.D., 2011. Viscosity of Fruit Juices: Experimental and Modeling. Nova Science Publishers.](#)
- [ASTM, 2002. A967, Standard Specification for Chemical Passivation Treatments for Stainless Steel Parts. ASTM International, PA.](#)
- [ASTM, 2006. A308, Standard Practice for Cleaning, Descaling, and Passivation of Stainless Steel Parts, Equipment and Systems. ASTM International, PA.](#)
- [Bowser, T., 1999. Selecting and purchasing food processing equipment. OSU Food Technology Facts, FAPC-102. Oklahoma State University Cooperative Extension Service, Stillwater, OK. <\[www.fapc.okstate.edu\]\(http://www.fapc.okstate.edu\)> \(Last accessed 24.05.12.\).](#)
- [Bowser, T., Choudhary, R., 2004. Sanitary fittings and tubing for food processors. OSU Food Technology Facts, FAPC-127. Oklahoma State University Cooperative Extension Service, Stillwater, OK. <\[www.fapc.okstate.edu\]\(http://www.fapc.okstate.edu\)> \(Last accessed 24.05.12.\).](#)
- [CSI. 2012. Stainless steel selection guide. Central States Industrial Equipment, MO. <<http://www.csidesigns.com/literature.php>> \(Last accessed 24.05.12.\).](#)
- [Driedger, W., 2000. Controlling centrifugal pumps. <\[www.driedger.ca\]\(http://www.driedger.ca\)> \(Last accessed May 24.05.12.\).](#)
- [Henderson, S.M., Perry, R.L., Young, J.H., 1997. Principles of Process Engineering. American Society of Agricultural Engineers, St Joseph, MI.](#)
- [Revie, R.W., 2011. Uhlig's Corrosion Handbook, third ed. John Wiley & Sons, Inc., NJ.](#)
- [Roberge, R.P., 2000. Handbook of Corrosion Engineering. McGraw-Hill, NJ.](#)
- [Schmidt, R.H., Erickson, D.J., 2012. Sanitary design and construction of food equipment. University of Florida IFAS Extension document FSHN0409. <<http://edis.ifas.ufl.edu/fs119>> \(Last accessed 24.05.12.\).](#)

- Seiberling, D., 1997. CIP sanitary process design. In: Valentas, K.J., Rotstein, E., Singh, R. (Eds.), Handbook of Food Engineering Practice. CRC Press, NY, pp. 581–631.
- Steffe, J.F., Daubert, C.R., 2006. Bioprocessing Pipelines: Rheology and Analysis. Freeman Press, MI.
- Steffe, J.F., Singh, R.P., 1997. Pipeline design calculations for Newtonian and non-Newtonian fluids. In: Valentas, K.J., Rotstein, E., Singh, R. (Eds.), Handbook of Food Engineering Practice. CRC Press, NY, pp. 1–35.
- USDA, 2012. USDA Meat and poultry equipment program accepted equipment list [rev 4/29/12]. <<http://www.ams.usda.gov/AMSV1.0/getfile?dDocName=STELPRDC5056459&acct=grddairy>> (Last accessed 25.05.12.).

# Agricultural Waste Management in Food Processing

Conly L. Hansen and Dae Yeol Cheong

Utah State University, UT, USA

## 1. INTRODUCTION

The uncontrolled decomposition of waste from agricultural and agro-industrial sources results in large-scale contamination of land, water, and air. Waste products from food processing facilities include bulky solids, airborne pollutants, and wastewater. All of these cause potentially severe pollution problems and are subject to increasing environmental regulation in most countries. Generally, the wastewater is of most concern because food processing operations involve a number of unit operations, such as washing, evaporation, extraction, and filtration. The process wastewaters resulting from these operations normally contain high concentrations of suspended solids and soluble organics such as carbohydrates, proteins, and lipids, which present difficult disposal problems. Regulatory agencies, such as the Environmental Protection Agency (EPA) in the United States, have promulgated regulations on effluent for a variety of food processing industries. Table 23.1 summarizes pollution characteristics of wastewaters from food processing industries.

Technology to remove major pollutants, such as total dissolved and suspended solids and organic materials in the food processing industry, can generally be classified into physical-chemical and biological, and land treatment. The most common practice until now has been to dispose of them in landfills. As the methane and carbon dioxide released from landfills is a major concern for global warming, biological treatment offers a clear method of reducing wastes going to landfills. In addition, biological processes can lead to the production of valuable products. Biological treatment can be subclassified into aerobic and anaerobic treatments. Under aerobic conditions, microorganisms convert carbohydrates, lipids, and proteins in wastes into microbial biomass and carbon dioxide (CO<sub>2</sub>). Under anaerobic conditions, wastes containing those components can be digested to yield methane (CH<sub>4</sub>), which can be burned as a fuel source. Anaerobic treatment (anaerobic digestion) is frequently cost effective as a result of energy production through methane. Also, ethanol or organic acids can be produced by the anaerobic microbiological process.

**Table 23.1** Comparative Strengths of Wastewaters from Food Processing Industries

Waste	BOD (mg/l)	COD (mg/l)	TSS (mg/l)	pH	Protein (mg/l)	Fat (mg/l)
Brewery	850	17,000	90	4–6	—	—
Dairy	1,000–4,000	—	1,000–2,000	Acid	6–82	30–100
Farm	1,000–2,000	—	1,500–3,000	7.5–8.5	—	—
Fish	500–2,500	—	100–1,800	—	300–1,800	100–800
Fruit	1,200–4,200	—	2,500–6,700	Acid	—	—
Meat	1,000–6,500	—	100–1,500	—	350–950	15–600
Potato processing	2,000	35,000	2,500–3,000	11–13	—	—
Poultry	500–800	600–1,050	450–800	6.5–9.0	300–650	100–400
Silage	50,000	—	Low	Acid	—	—
Slaughterhouse	1,500–2,500	—	800	11–13	—	—
Vegetable	1,000–6,800	—	100–4,000	Acid	—	—

BOD, biochemical oxygen demand; COD, chemical oxygen demand; TSS total suspended solids.

Not all agricultural and food processing wastes have a high organic content that is amenable to biological treatment, and those with a low organic content, insufficient nutrients, and which contain toxic compounds, require physical-chemical treatment, such as settlement, pH adjustment, chemical precipitation, coagulation, reverse osmosis, ionexchange, or adsorption. Cleaning wastewater to a point whereby it can be disposed of onto land or into a receiving stream, requires treatment plants that are a mixture of physical-chemical and biological unit processes. However, biological treatment, particularly anaerobic, is often the best and/or most cost effective alternative for economical pretreatment of food processing waste.

Key considerations in determining appropriate treatment technology are process operating cost, quantity and characteristics of waste, and market value of recovered products. Because of the diverse nature of the various food processing wastes such as differences in concentrations of carbohydrates, protein and fat, there are differences in treatment methods. Unit processes including physical, biological, and chemical or other tertiary treatment, are the parts common to all waste treatment systems. Treatment plants are assembled from combinations of unit processes, and as the range of available unit processes, it is possible to produce a final effluent of a specified quality from almost any type of influent wastewater. The quality of the final effluent required, the nature of wastewater, and its volume all influence the unit processes selected in the design of a wastewater treatment system. Descriptions of common unit processes are covered in this chapter. The waste treatment systems most often used for the major food commodities, dairy, meat, poultry, seafood, and vegetable processing, are listed. Also, this chapter introduces attractive biotechnological processes in terms of re-use, conversion, and recovery of useful constituent materials from food processing wastes.

## 2. COMMON UNIT PROCESSES EMPLOYED IN FOOD WASTE TREATMENT

Commonly used food processing waste treatment methods include those listed below. The order of presentation has relevance to frequency of use from first to last, but this is not quantified and can vary from country to country (Hansen and Wrigley, 1997; Gosta, 1999; Hansen and Hwang, 2003). Later in this chapter, waste treatment methods are described in more detail.

### 2.1 Land Application of Untreated or Partially Treated Waste

This is one of the least expensive methods, if inexpensive land is available with good drainage and local regulations allow it. However, cheap land is often not available and the problems with this technology include possible odor nuisance, salt buildup in the soil, standing water, and maintenance difficulties. The success of this method depends on the use of proper application rates. Effective pretreatment of the wastewater is helpful. Wastewater high in organic matter should be screened prior to irrigation. The soil can do an excellent job of removing nutrients and pathogens from waste.

### 2.2 Sedimentation, Settling, and Chemical Precipitation

Sedimentation or settling of solids can occur in collecting ponds or lagoons, or in basins designed for this.

### 2.3 Dissolved Air Flotation (DAF)

DAF is extremely useful and efficient to remove fats, oils, and grease (FOG) and can remove significant quantities of other pollutants. A DAF unit can remove up to 90% of FOG (FOG) and 50% of biochemical oxygen demand (BOD). These high removal rates almost surely require pH adjustment and chemical addition. Even so, DAF is often the unit process of choice for food processing waste.

### 2.4 Stabilization Ponds

Oxygen is provided by the algal population. These ponds have a relatively large surface to volume ratio and thus sunlight reaches algae that produce  $O_2$  by photosynthesis. Stabilization ponds require a relatively large land area and may be impractical for that reason.

### 2.5 Aerated Lagoons

The active biomass in the lagoon is low, thereby requiring longer periods of aeration for comparable performance to other aerobic processes, such as the activated sludge process. Aerated lagoons are not vigorously mixed, so there is solids sedimentation. The aerated lagoon is often facilitative (part with  $O_2$  and part without), thus organic

matter is actually removed through a combination of physical separation, aerobic, and anaerobic stabilization.

## 2.6 Anaerobic Lagoons

The biological degradation of organic material occurs in the absence of dissolved oxygen. Organic materials are converted to organic acids, carbon dioxide, and methane. In addition, odiferous gases including ammonia and hydrogen sulfide are produced in small quantities.

## 2.7 Other Anaerobic Processes

Anaerobic digestion is often thought of primarily for solids destruction. The energy that is produced as methane is a reason to consider the process. Improved methods to utilize the energy in the biogas are now available. The electricity that is generated is considered “green” energy yielding carbon credits. Anaerobic digestion requires control of pH value and this can be costly. Anaerobic systems generally produce much less sludge than aerobic ones.

## 2.8 Activated Sludge Process

The process provides aerobic biological treatment employing suspended growth of bacteria. Organisms separated from the treated effluent by sedimentation are returned back to an aerated chamber. This makes the solids retention time much longer than the hydraulic retention time, and thus improves process results.

## 2.9 Membrane Processes

Reverse osmosis, diafiltration, electrodialysis, and ultrafiltration are some of the methods used. These processes can yield salable products from some wastes, such as whey protein from whey.

## 2.10 Chemical Methods

A chemical method is often used in combination with other methods. When used singly, it may have the disadvantage of relatively high cost with often nominal effectiveness in organic matter removal. Metals, such as calcium or iron may be used to aid certain unit processes. Adding polyelectrolytes improves the efficiency of other unit processes such as DAF.

## 2.11 Trickling Filters

These have a fixed support medium to maintain the active organisms within the wastewater stream. Some unique plastic media have been developed for this purpose.

Stones have also been commonly used. Organic matter is absorbed on to the fixed biological film and is subsequently oxidized.

## 2.12 Rotating Biological Discs

Rotating biological discs are a modification of the trickling filter process, whereby a fixed biological film is rotated through the wastewater. A large biological surface is provided by a series of closely spaced discs mounted on a rotating horizontal shaft. The device usually works in the presence of oxygen or it can be used for anaerobic treatment.

## 2.13 Disinfection

Disinfection is the removal or inactivation of pathogenic microorganisms. Chemical agents, commonly chloride or its derivatives, may be used or the water may be exposed to ultraviolet (UV) light or radiation. Ozone is becoming more widely used as a disinfectant ([Table 23.2](#)).

# 3. CHARACTERISTICS OF WASTES AND TREATMENT TYPES

Food processing wastes are rich in organic materials and thus are often readily degraded biologically. Generally, these wastes contain sufficient nitrogen, phosphorous, and trace elements for biological growth. The volume and strength of solid and liquid wastes from food processing depends on the type of process, and the size and age of the plant, as well as the season.

The primary objective of the US Clean Water Act (CWA) is to restore and maintain the chemical, physical, and biological integrity of the nation's waters. To prevent contamination and deterioration of water quality, wastewaters from industrial, commercial, and residual activities are treated at Wastewater Treatment Plants (WWTPs). Currently, more than 80% of industrial wastewater, including food processing wastes, is treated in publicly owned treatment works (POTWs) with or without pretreatment at the plant. A plant may use a municipal wastewater treatment system directly without private treatment facilities. In this case, the increased cost to treat the waste will be passed on to the users, including food processing plants as municipalities are required to install new or remodel existing wastewater treatment facilities. Therefore, food processing industries that pretreat in privately owned wastewater treatment works are increasing ([McFarland, 2001](#)).

Food processing wastewater treatment may consist of physical unit processes such as screening, flow equalization, air flotation, sedimentation, etc., normally followed by some type of biological treatment. If space is available, land treatment or pond systems are the frequently used treatment methods. Possible biological treatment systems



**Table 23.2** Comparison of the Characteristics of Chlorine, Ozone, and Ultraviolet Radiation in Wastewater Effluent Disinfection

Characteristic	Chlorine	Ozone	Ultraviolet Radiation
Effectiveness as a disinfectant	Very effective against bacterial cells, much less so against bacterial spores or the oocysts of a parasite	Effective against bacteria, thought to be a better viricide than chlorine	Effective against microbial cells. Dosage must allow for the UV damage-repair systems of microbes
Toxic residuals of products	Chlorine residuals possible unless dechlorination used, potentially toxic halogenated organics may be formed	Dissipates rapidly, little or no residual formation	No toxic residuals formed
Penetration	High	High	Moderate suspended solids interface. UV lamps require frequent cleaning
Cost	Low if no dechlorination is required	Moderately high, but becoming competitive with chlorination/dechlorination	Moderately high

include trickling filters, activated sludge, aerated, facultative, or anaerobic lagoons, and other types of anaerobic digestion.

### 3.1 Dairy Processing Waste

Milk production had steadily grown over the past 30 years, such that the dairy industry has now become the major agricultural processing industry in the USA. Wastewater originates from two major processes, from fluid milk itself at reception and bottling plants, but more importantly at the processing plants that produce butter, cheese, evaporated and condensed milk, milk powder, and other milk products. Milk has a BOD value of 100,000 mg/l and washings from plants producing butter and cheese can have a BOD ranging between and 1,500 and 3,000 mg/l. Dairy wastes are dilutions of whole milk, separated milk, butter milk, and whey. They are high in dissolved organic matter mainly in the form of the proteins (3.8%) and lactose (4.5%) but low in suspended solids, except for the fine curd found in cheese processing wastes. Nitrogen and phosphorous are also present, which originate mainly from milk proteins (Guillen-Jimenez *et al.*, 2000). Apart from whey, derived from the manufacture of cheese which is acidic, most dairy processing wastes are neutral or slightly

**Table 23.3** Composition and Organic Strength of Milk Products and Associated Waste Products (Nemerow, 1978)

Characteristics	Whole Milk (mg/l)	Skim Milk (mg/l)	Buttermilk (mg/l)	Whey (mg/l)	Process Wastes (mg/l)
Total solids	125,000	82,300	77,500	72,000	4,516
Organic solids	117,000	74,500	68,800	64,000	2,698
Ash solids	8,000	7,800	8,700	8,000	1,818
Fat	36,000	1,000	5,000	4,000	
Soluble solids					3,956
Suspended solids					560
Milk sugar	34,000	46,000	43,000	44,000	
Protein (casein)	38,000	39,000	36,000	8,000	
Organic nitrogen					73.0
Free ammonia					6.0
Na					807
Ca					113
Mg					25
K					116
P					59
BOD	102,500	73,000	64,000	32,000	1,890

alkaline but have a tendency to become acidic rapidly due to the fermentation of lactose to lactic acid. The average composition of milk, milk byproducts, and cheese processing wastes are given [Table 23.3](#).

The most visible source of waste in the dairy processing plant is in the whey resulting from the various cheese processing operations. Whey is a unique part of dairy processing wastewater because of its high pollution potential and quantity. About 9 kg of whey is produced for every kg of cheese produced. In cottage cheese production, the curd is more fragile than rennet curd produced in other types of cheese. Thus, the whey and wash water BOD can be increased if mechanical washing processes are used. In cheddar cheese production, the whey drained during cheddaring (matting of curd) and processing should be collected and combined with the whey. In Swiss cheese manufacture, appreciable whey is lost in the transfer of the curd from vat to draining table. In Provance and Mozzarella cheese manufacture, the milling, mixing, and molding of the curd produces high fat, low pH (5.1–5.3) wash water ([Harper, 1974](#); [US Environmental Protection Agency, 1971](#)).

Dissolved air flotation (DAF) is one of the most useful waste treatment processes for several types of food processing wastes, including dairy processing waste. Lagoons and stabilization ponds are often used where conditions allow. Odor from any waste treatment process open to the air is becoming a more serious problem and impediment for using uncovered lagoons. [Figure 23.1](#) summarizes various processes used in

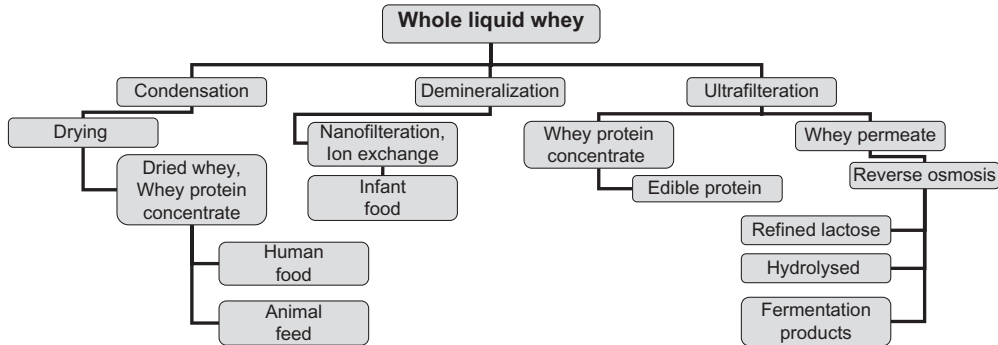


Figure 23.1 Schematic presentation of whey processing into various saleable products.

the treatment of whey that yield end products. Whenever a saleable end product can be produced, it is often going to be the treatment of choice, even if the plant only breaks even in the process. Sludge disposal is becoming an increasingly difficult problem to solve. Details of the various processes used in the dairy industry, with specific reference to wastewater production, are given by [Nemerow and Agardy \(1998\)](#).

### 3.2 Meat, Poultry, and Seafood Processing Waste

Meat, poultry, and seafood processing waste have many similarities. These wastewaters are high in dissolved and suspended organic matter, in particular proteins and fats, are high in organic nitrogen and grease, and may contain a significant amount of pathogens. Slaughterhouse and meat packing wastewaters are strong and unpleasant, comprising feces and urine, blood washings from carcasses, floors, and utensils, and the undigested food from paunches of slaughtered animals.

The type of waste treatment for these wastes often includes ([Ockerman and Hansen, 2000](#), [Hansen \*et al.\*, 1984](#)):

- Screens and fat traps. The main task is to remove particles contained in the wastewater.
- Flotation with some chemical addition, to remove suspended solids and emulsified fats.
- Aeration of the waste to minimize organic and nitrogen load.
- Anaerobic lagoons to destroy organic solids.
- Biofilters, carbon filters, and scrubbers to control odors and air emissions.
- Disinfection of the final effluent, when high levels of bacteria are found. Use of chlorine compounds is one good alternative, ultraviolet light may also be used.
- Anaerobic digestion.

### 3.3 Fruit and Vegetable Processing Waste

Waste from fruit and vegetable processing is similar in nature to the food itself. Some processes give rise to large volumes of weakly polluted effluents such as vegetable washing water, which only contains soil and small amounts of organic matter. More concentrated wastewaters come from processes that either prepare the food or transform it in some way, such as blanching of vegetables. Cannery wastewaters are essentially the same as domestic kitchen waste. The waste originates from trimming, culling, juicing, and blanching of fruit and vegetables. The wastewaters are high in suspended solids, and colloidal and dissolved organic matter, the main components being starch and fruit sugars. For example, 85–90% of the organic wastes from a pineapple cannery is sugar in the form of sucrose (Nemerow and Agardy, 1998). Sugar beet waste also comprises sugars, 95% of which are sucrose, with raffinose making up most of the remainder, although the waste is particularly low in nitrogen and phosphorous. The sugars are leached from cut and damaged surfaces into the transport and wash-water circuits. The accumulated sugars are rapidly catabolized in the circuits to short chain aliphatic carboxylic acids, so that the wastewater requiring treatment comprises almost exclusively acids. However, at low pH concentrations, offensive odors from volatile fatty acids and sulfides can be generated, and sufficient lime (CaO) must be added to maintain circulating water at neutral pH (Shore *et al.*, 1984).

Common fruit and vegetable waste treatment processes are (Jones, 1994; Carawan *et al.*, 1979):

- Screening: an effective separation and segregation of the solids in the effluent will often be the first step in the waste treatment. The effectiveness of this depends on the physical properties of the particles, including size, density, and concentration, and on the capability of the equipment for their separation.
- Trickling filters.
- Sedimentation, settling, and chemical precipitation.
- Activated sludge process.
- Aerated lagoons and stabilization basins. They are used when land is available.
- Anaerobic lagoons.
- Anaerobic digestion.
- Fungal treatment: selected strains of fungi are used mostly on waste from corn and soy bean processing plants. The mycelium can be harvested by filtration and has utility as a feed product.
- Tertiary (chemical, chlorine, ultraviolet light): used when the bacterial contents are too high and to reduce odors.

### 3.4 Brewery and Distillery Waste

Brewery and distillery wastewaters are high in dissolved solids, which contain nitrogen and fermented starches and their products. Fermentation wastes and in particular spent

yeast are extremely concentrated with BOD (2,000–15,000 mg/l), total nitrogen (800–900 mg/l), and phosphate (20–140 mg/l), almost entirely present in the dissolved or colloidal fractions with the suspended solids content rarely in excess of 200 mg/l. The brewing and distillation process generates a unique, high-strength wastewater as a byproduct. The wastewater typically has a high concentration of BOD from the carbohydrates and protein used in brewing beer. Brewery wastewater usually has a warm temperature ( $> 100^{\circ}\text{F}$  ( $38^{\circ}\text{C}$ )).

Common brewery and distillery waste treatment processes include (Ochieng *et al.*, 2002; Petruccioli *et al.*, 2002).

- Activated sludge process.
- Other aerobic technology: reactor configurations such as sequencing batch biofilm reactor and aerated continuously stirred-tank reactor are employed.
- Sedimentation, settling, and chemical precipitation.
- Anaerobic digestion: technologies, using anaerobic sequencing batch reactor, upflow anaerobic sludge blanket reactor, fixed bed anaerobic reactor, etc.
- Anaerobic lagoons.
- Coagulation and flocculation.
- Disinfection and chemical treatment: treatment with ozone and with ozone/hydrogen peroxide, both followed by granular activated carbon. Treatment with ozone, ozone plus ultraviolet light (UV), and ozone plus UV light in the presence of titanium dioxide.
- Chemical conditioning: the treatment is used for conditioning of sludge generated in electro-flocculation treatment of fermentation wastewater.

## 4. PHYSICAL-CHEMICAL TREATMENT PROCESS

The following discussion gives more information about specific treatment processes. These are all treatment processes used in food waste treatment.

### 4.1 Screening

Screening is usually the first unit operation in a wastewater treatment processes. A screen is a device with openings, generally of uniform size, that is used to retain the coarse solids present in wastewater. The screening element consists of parallel bars, rods or wires, grating, wire mesh, or perforated plate. The openings may be of any shape but are generally circular or rectangular slots. The materials removed by these devices are called “screenings”. The head loss through the process is normally the parameter used to determine the efficiency of screening.

### 4.1.1 Screens

Screens include the inclined disk type or cylindrical, tangential, vibrating, and drum type. An advantage of the tangential screen is that it is mostly self-cleaning. The application for screening ranges from primary treatment to the removal of residual suspended solids in the effluent from biological treatment processes. The head loss can be estimated using the following equation:

$$h_L = \frac{1}{C(2g)} \left( \frac{Q}{A} \right)^2$$

where  $h_L$  is head loss [m],  $C$  is coefficient of discharge for the screen (@ 0.60),  $g$  is acceleration due to gravity ( $\text{m/s}^2$ ),  $Q$  is discharge through screen ( $\text{m}^3/\text{s}$ ) and  $A$  is effective open area of submerged screen ( $\text{m}^2$ ).

### 4.1.2 Bar racks

Bar racks are normally used to protect pumps, valves, pipelines, and other facilities from damage or clogging by rags and large objects. Industrial waste plants may need them, depending on the character of the wastes. The following equation is used to calculate head loss through the bar rack:

$$h_L = \frac{1}{0.7} \left( \frac{V^2 - v^2}{2} g \right)$$

where  $h_L$  is head loss (m), 0.7 is an empirical discharge coefficient to account for turbulence,  $V$  is velocity of flow through the openings of the bar rack (m/s),  $v$  is approach velocity in upstream channel (m/s) and  $g$  is acceleration due to gravity ( $\text{m/s}^2$ ).

## 4.2 Sedimentation (Settling)

Sedimentation is the separation of suspended particles that are heavier than water by gravitational settling. In most cases, the primary purpose is to produce a clarified effluent, but it is also necessary to produce concentrated sludge that can be easily handled and treated. There are four types of sedimentation and it is common to have more than one type of settling occurring at a given time. In fact, it is possible to have all four occurring simultaneously during the sedimentation operation.

### 4.2.1 Discrete Particle Sedimentation (Type 1)

This is the sedimentation of particles in a suspension of low solid concentration. Particles settle as individual entities, and there is no significant interaction with neighboring particles. Sedimentation of grits and sand particles from wastewater are type 1.

#### **4.2.2 Flocculant Sedimentation (Type 2)**

This refers to a rather dilute suspension of particles that coalesce or flocculate during the sedimentation operation. By coalescing, the particles increase in mass and settle at a faster rate. This process is used to remove a portion of the suspended solids in untreated wastewater in primary settling facilities and in upper portions of secondary settling facilities. It is also used to remove chemical floc in settling tanks.

#### **4.2.3 Hindered (or Zone) Sedimentation (Type 3)**

This refers to suspensions of intermediate concentration in which inter-particle forces are sufficient to hinder the settling of neighboring particles. The particles tend to remain in fixed positions with respect to each other and the mass of particles settles as a unit. It occurs in settling devices where a solids–liquid interface develops at the top, commonly used in conjunction with biological treatment facilities.

#### **4.2.4 Compression Sedimentation (Type 4)**

Compression takes place from the weight of the particles, which are constantly being added to the structure by sedimentation from the supernatant fluid. It usually occurs in the lower layers of a deep sludge mass, such as in the bottom of deep secondary settling and sludge thickening facilities (Eckenfelder, 1961).

### **4.3 Flotation**

Flotation is a unit operation used to separate solid or liquid particles, such as grease from a liquid phase. Separation may be enhanced by introducing fine gas (usually air) bubbles into the liquid phase. The bubbles attach to the particles and the buoyant force of the combined particle and gas bubbles cause the particle to rise to the surface. Particles that have a higher density than the liquid can thus be made to rise. The rising of particles with lower density than the liquid can also be facilitated (e.g. oil suspension in water).

In wastewater treatment, flotation is used principally to remove suspended matter. The principal advantage of flotation over sedimentation is that very small or light particles that settle slowly can be removed more completely and rapidly. Once the particles have been floated to the surface they are removed by a skimming operation (Eckenfelder, 1961).

#### **4.3.1 Dissolved Air Flotation**

In this system, air is dissolved in wastewater held under high pressure. This is followed by release of pressure to atmospheric pressure level. In small systems, the entire flow may be pressurized to 275–350 kPa (40–50 psi) with compressed air added at the pump suction. In larger units, a portion of the effluent is recycled, pressurized, and

semi-saturated with air. The recycled flow is mixed with the unpressurized main stream and the air finally comes out of solution.

### **4.3.2 Air Flotation**

Air that is injected directly into the liquid phase through a revolving impeller or through diffusers forms air bubbles to provide the buoyant force. Aeration alone for a short period is not particularly effective in flotation of solids.

### **4.3.3 Vacuum Flotation**

Wastewater is saturated with air and then a partial vacuum is applied. This causes the dissolved air to come out of solution as fine bubbles. The solid particles attached to the bubbles rise to the surface to form a scum layer, which is removed by a skimming mechanism.

### **4.3.4 Chemical Additives**

Chemicals such as aluminum, ferric salt, activated silica, and organic polymers are used to aid the flotation process. These chemicals function to create a surface or a structure that can easily absorb or entrap air bubbles.

## **4.4 Filtration**

Filtration is usually a polishing step to remove small flocs or precipitant particles. Although filtration removes many pathogens from water, filtration should not be relied on for complete health protection.

The most commonly used filtration processes involve passing water through a stationary bed of granular medium that retains solids. Several modes of operation are possible in granular medium filtration including: downflow, upflow, biflow, pressure, and vacuum filtration. Among these, the most common practice is gravity filtration in a downward mode, with the weight of the water column above the filter providing the driving force.

Solids removal with granular medium filters involves several complicated processes. The most obvious process is the physical straining of particles too large to pass between filter grains. Removal of particles and floc in the filter bed depends on mechanisms that transport the solids through the water to the surface of the filter. Transport mechanisms include settling, inertial impaction, diffusion of colloids into areas of lower concentrations, and to a lesser extent, Brownian movement and van der Waals forces. Brownian motion is the random, thermal motion of solutes as a result of their continuous bombardment by the solvent molecules.

Removal begins in the top portion of the filter. As pore openings are filled by the filtered material, increased hydraulic shear sweeps particles farther into the bed. When the storage capacity of the bed has become exhausted, the filter must be cleaned.



Hydraulic backwashing is the most used method to clean the filter. Backwash water containing the accumulated solids is disposed of and the filter can then be reused.

The smaller the size of granular media, the smaller the pore openings through which the water must pass. Small pore openings increase filtration efficiency not only because of straining but also because of other removal mechanisms. However, as size of pore openings decreases, head loss through the medium increases, resulting in a diminished flow rate. Larger media increase pore size, reduce head loss, and increase flow rate, but filtration efficiency decreases (Cheremisinoff, 1993).

#### **4.4.1 Slow Sand Filter**

This was the first filter to be used for water purification during the 1800s. These filters were constructed of fine sand with an effective size of about 0.2 mm. The small size resulted in virtually all of the suspended material being removed at the filter surface. Slow sand filters have large space requirement and are capital intensive. Additionally, they do not function well with highly turbid water as the surface plugs quickly, requiring frequent cleaning.

#### **4.4.2 Rapid Sand Filter**

This filter was developed to alleviate difficulties of the slow sand filter. Sizes range from 0.35 to 1.0 mm or even larger, with effective sizes of 0.45–0.55 mm. These larger sizes result in a rate of filtration an order of magnitude larger than that of the slow sand filter.

#### **4.4.3 Dual Media Filters**

Dual media filters are usually constructed of silica sand and anthracite coal. The large pores in the anthracite layer remove large particles and flocs, whereas most of the smaller material penetrates to the sand layer before it is removed. Dual media filters thus have the advantage of more effectively utilizing pore space. A disadvantage of dual media filters is that the filtered material is held loosely in the anthracite layer. Any sudden increase in hydraulic loading removes particles from the anthracite layer and transports them to the surface of the sand layer, which results in rapid binding at this level.

#### **4.4.4 Mixed Media Filters**

The ideal filter would consist of medium-sized granules graded evenly from large at the top to small at the bottom. This can be accomplished by using three or more types of media with carefully selected size and density. Dual and mixed media filters make possible the direct filtration of water of low turbidity without settling operations.

## 4.5 Coagulation and Flocculation

Coagulation is the destabilization of colloidal particles. The particles are essentially coated with a chemically sticky layer that allows them to flocculate (agglomerate) and settle in a reasonable period of time. Coagulation of waters to aid their clarification has been practiced since ancient times. Many naturally occurring compounds from starch to iron and aluminum salts can accomplish coagulation. In addition, synthetic cationic, anionic, and non-ionic polymers are effective coagulants but are usually more costly than natural compounds. The most common coagulants are alum (aluminum sulfate) and iron salts, with alum being the most extensively used agent. The multivalent characteristic of these cations strongly attracts them to charged colloidal particles and their relative insolubility ensures their removal to a high degree (Guibai and Gregory, 1991).

Activated silica is another commonly used coagulation agent. Sodium silicate ( $\text{Na}_2\text{SiO}_3$ ) is activated by acidification. When a concentrated solution of sodium silicate is acidified, it becomes oversaturated with respect to the precipitation of  $\text{SiO}_2$ . The precipitation process begins with the formation of polysilicate polymers that contain  $-\text{Si}-\text{O}-\text{Si}-$ linkages (Stumm *et al.*, 1967). Ozone has been found to be an effective coagulant aid. Low dosages ( $<3$  mg/l and often 0.5–1.5 mg/l) are most effective, and overdosing can actually deteriorate coagulation. Ozone does not improve ultimate particle removal but facilitates the removal of readily coagulatable material with greater economy of coagulant (Singer, 1990).

### 4.5.1 Mixers

Because coagulation reactions are rapid, a short detention time is all that is necessary, but a high degree of turbulence is required. Velocity gradient values ( $G$ ) up to  $5000 \text{ s}^{-1}$  have been used. Mixing units should be designed for the maximum day flow. Letterman *et al.* (1988) found the following empirical correlation that relates the key parameters of  $G$ ,  $t_{\text{dopt}}$ , and concentration of coagulant for an impeller rapid mixing device using alum as a coagulant:

$$G \cdot t_{\text{dopt}} \cdot C^{1.46} = 5.9 \times 106$$

where  $t_{\text{dopt}}$  is the optimum detention time and  $C$  is the concentration of alum (mg/l)

Conditioning chemicals are added to sludge to aid dewatering. High-shear conditions in the mixer can destroy the structure of sludge.

### 4.5.2 Flocculators

There are a wide variety of devices that can be used to accomplish the gentler mix required for flocculation. Basins with mechanically driven paddles and pneumatic flocculators are common. Devices in the hydraulic category are pipes, baffled channels,

pebble bed flocculators, and spiral flow tanks. Head loss calculations are made from basic fluid mechanical principles.

Flocculators are commonly designed to have  $Gtd$  values in the range  $10^4$ – $10^5$ .  $G$  values may range from 10 to  $60\text{ s}^{-1}$  and detention time is typically in the range 15–45 min. Mixing in an individual flocculator basin causes the hydraulic flow regime to approach complete mixed conditions. Therefore, it is desirable to have two or more basins in series to ensure that all particles are exposed to the mixing for a significant amount of total detention time and to promote plug flow through the system as a whole.

#### 4.6 Chemical Precipitation

Chemical precipitation in food wastewater treatment involves the addition of chemicals to alter the physical state of dissolved and suspended solids and to facilitate their removal by sedimentation. Chemical precipitation processes, in conjunction with various physical operations, have been developed for the complete secondary treatment of untreated wastewaters, including the removal of either nitrogen or phosphorous, or both. The chemicals added to wastewater interact with substances normally present in the wastewater. Common reactions are those with alum, lime, ferrous sulfate (coppers) and lime, ferric chloride, ferric chloride and lime, and ferric sulfate and lime (McFarland, 2001).

Other chemical precipitation processes have also been developed to remove phosphorous by chemical precipitation and are designed to be used in conjunction with biological treatment. The removal of phosphorous from wastewater involves the incorporation of phosphate into suspended solids and the subsequent removal of those solids. Agents used to precipitate dissolved phosphorous are salts of the chemicals calcium, iron, or aluminum. The chloride and sulfate salts of  $\text{Fe}^{2+}$  and  $\text{Fe}^{3+}$  can be used. The chemistry of phosphate precipitate formation is complex because of complexes formed between phosphate and metals and between metals and other ligands in the wastewater. Side reactions of the metals with alkalinity to form hydroxide precipitates are another factor to be considered (Jenkins and Hermanowicz, 1991).

#### 4.7 Disinfection

Disinfection refers to operations aimed at killing pathogens. Sterilization, the complete destruction of all living matter, is not usually the objective of disinfection. A good disinfectant must be toxic to microorganisms at concentrations well below the toxic thresholds to humans and higher animals. Additionally, it should have a fast rate of kill and should be persistent enough to prevent regrowth of organisms in the distribution system.

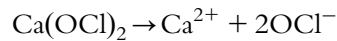
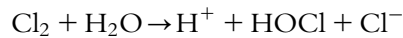
Pathogenic kill efficiency is not the only consideration in selecting a disinfectant. The characteristics of a good disinfectant are:

- Effective kills of pathogenic microorganisms.
- Non-toxic to humans or domestic animals.
- Easy and safe to store, transport, and dispense.
- Non-toxic to fish and other aquatic species.
- Low cost.
- Easy and reliable analysis in water.
- Provides residual protection in drinking water.

Many chemical agents have been used as disinfectants, including chlorine, bromine, iodine, ozone, phenols, alcohols, hydrogen peroxide, quaternary ammonium compounds, heavy metal based compounds, and various alkalis and acids. In addition, the disinfectant properties of physical agents such as ultraviolet radiation (UV) and ionizing radiation have also been investigated (Rhyner *et al.*, 1995). Three of the above, chlorine, ozone, and UV radiation, will be discussed here. Some of the properties of chlorine, ozone, UV radiation are compared in [Table 23.2](#).

#### 4.7.1 Chlorination

Chlorine may be applied to water in gaseous form,  $\text{Cl}_2$ , or as an ionized product of solids,  $\text{Ca}(\text{OCl})_2$  or  $\text{NaOCl}$ . The reactions in water are:



where  $\text{Ca}(\text{OCl})_2$  is calcium hypochlorite,  $\text{NaOCl}$  is sodium hypochlorite,  $\text{HOCl}$  is hypochlorous acid and  $\text{OCl}^-$  is hypochlorite ion.

Chlorine in various forms, especially hypochlorite salts, has been successfully used to sanitize utensils and equipment in dairy and other food processing industries. Hypochlorites are considered GRAS substances and thus are permitted in various food applications in the USA. Chlorine compounds are effective and inexpensive disinfectants. For example, use of hypochlorite dip or spray is effective in controlling bacterial contamination of fruits and vegetables. In the egg industry, chlorine compounds are used in the wash water to decrease the load of spoilage and pathogenic microorganisms (Kim *et al.*, 1999).

At low concentrations, chlorine probably kills microorganisms by penetrating the cell and reacting with the enzymes and protoplasm. At higher concentrations,

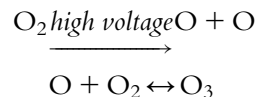
oxidation of the cell wall will destroy the organism. Factors affecting the process are:

- Forms of chlorine.
- pH.
- Concentration.
- Contact time.
- Types of organism.
- Temperature.

Chlorine compounds have a few drawbacks that increasingly limit their use in the food industry. Chlorination may lead to the formation of toxic or carcinogenic chlorinated organic compounds in wastewater and food or food surfaces. In addition, the residual chlorine may be toxic to aquatic life in receiving waters. This has brought about environmental regulations requiring dechlorination of wastewater effluent before discharge (Wei *et al.*, 1985).

#### 4.7.2 Ozonation

Ozone (O<sub>3</sub>) can be produced in a high strength electrical field from pure oxygen or from the ionization of clean dry air:



Ozone is a powerful oxidant, which reacts with reduced inorganic compounds and with organic material including vigorous reactions with bacteria and viruses. It is reported to be more effective than chlorine in inactivating resistant strains of bacteria and viruses. Because ozone is chemically unstable it must be produced on-site and used immediately. Ozone has a low solubility in water and thus must be mixed thoroughly with the water to ensure adequate contact. This can be a problem when air is used as the oxygen source, as large volumes of nitrogen must also be handled. Ozone inactivates microorganisms less effectively when they are on food surfaces rather than in low ozone-demand liquid media (Steihelin and Hoigne, 1985; Stover and Jarnis, 1981). Inactivation of microflora on food by ozone depends greatly on the nature and composition of food surface, the type of microbial contaminant, and the degree of attachment or association of microorganisms with food. The cost of ozone disinfection is greater than chlorine disinfection. However, recent advances in ozone generation technology have made it more competitive (Kim *et al.*, 1999).

#### 4.7.3 Ultraviolet Radiation

Irradiation with ultraviolet light is a promising method of disinfection. This method is effective in inactivating both bacteria and viruses. Ultraviolet (UV) light occupies a

wide band of wavelengths in the non-ionizing region of the electromagnetic spectrum between X-rays (200 nm) and visible light (400 nm). For practical purposes, the UV spectrum can be subdivided into three regions:

1. Shortwave UV (UVC) with wavelengths 200–280 nm.
2. Mediumwave UV (UVB) with wavelengths 280–320 nm.
3. Longwave UV (UVA) with wavelengths 320–400 nm.

The intensity of UV radiation is expressed as irradiance as or intensity flux ( $\text{WM}^{-2}$ ), while the dose, a function of the intensity and time of exposure, is expressed as radiant exposure ( $\text{Jm}^{-2}$ ) (Bintsis *et al.*, 2000).

UV radiation is produced by low-pressure mercury lamps. These lamps generate about 85% of their output radiation at a wavelength of 254 nm, which is effective in disrupting the nucleic acids (DNA and RNA) of cells or viruses. Because UV radiation is a physical disinfecting agent, it is thought that no toxic residuals are produced, as occurs in the use of chlorine disinfection. Until recently, UV radiation has not received much consideration as a means of the disinfection of wastewater effluent because it is easily absorbed by suspended solids and other UV-absorbing materials often found in wastewater effluent streams. However, with improved tertiary treatment, many wastewater effluents have much lower concentrations of solids and dissolved chemicals so that UV treatment for disinfection becomes more efficient and cost effective. Increasing regulatory pressures to eliminate chlorination as a disinfectant process have stimulated much research into the full-scale application of UV as a disinfectant for wastewater effluent (White, 1992).

## 4.8 Carbon Adsorption

Carbon is able to adsorb dissolved substances onto its porous, fissured surfaces. Activated carbon is adsorbent and substances being adsorbed are adsorbates. There are other materials that can be used as adsorbents but carbon is the choice for water treatment because it is able to remove a broad range of adsorbates. Activated carbon is most often used to remove organic contaminants, particularly synthetic organic chemicals, but it can effectively remove many inorganic contaminants such as radon-22, mercury, and other toxic metals. Dechlorination is another use of activated carbon. Chlorine and chloramines react with the carbon to form chloride and carbon dioxide products.

Activated carbon is prepared in a manner that results in a large surface area (fissures) within the medium. In granular activated carbon (GAC) beds there is also some degree of filtration phenomena. An alternative to GAC is powdered activated carbon (PAC), which may be added to biological treatment (Faust and Aly, 1987). Adsorption is a surface area phenomenon. The surface areas of commercial GACs range from 600 to 1600  $\text{m}^2/\text{g}$ . Commercially available GAC has most of its particles

ranging in size from 40 mesh (0.425 mm) to 8 mesh (2.36 mm), whereas 80% of PAC particles are smaller than 325 mesh (0.025 mm) (Flick, 1991).

## 4.9 Ion Exchange

Ion exchange is the exchange of ions in solution for other ions on a medium. In food and agricultural wastewater treatment, it can be used for removal of toxic metals or recovery of precious metals. There are many natural substances that are able to exchange ions. Synthetic resins are most commonly used because of their better performance.

Ion exchange resins are designed to remove ions of a certain class. In general there will be exchange of more than one ion species. The selectivity characteristics of resins that are available from manufacturers and the presence and concentration of dissolved solids in the water dictate the most favorable choice of a resin to achieve removal of the target species. The total exchange for a number of commercial resins ranges from 2.5 to 4.9 meq/g of resin on a dry basis (Flick, 1991). Resins have different swelling characteristics and the total exchange capacity on a volumetric basis ranges from 1.0–4.0 meq/ml.

The saturation capacity of a resin can be measured by simply by means of a titration. The procedure is:

- Regenerate the resin with acid (base).
- Rinse the resin with distilled water or water that does not contain any ions that are exchangeable with the resin.
- Measure the resin volume.
- Titrate the resin with base (acid).

## 4.10 Membrane Process

Membrane treatment processes are used to separate dissolved and colloidal constituents from wastewater. In membrane treatment, water or components in water are driven through a membrane under the driving force of a pressure, electrical potential, or concentration gradient. Two examples of membrane-based filtration systems are ultrafiltration and reverse osmosis (Rhyner *et al.*, 1995).

### 4.10.1 Ultrafiltration

Ultrafiltration membrane systems are typically designed to remove colloidal matter (5–100 nm or more) and large molecules with molecular weight in excess of 5,000 amu. Given the small pore size in ultrafiltration membranes, waste streams that are to be treated with ultrafiltration require expensive processing. Ultrafiltration can produce a good-quality effluent. If still greater effluent quality is desired, the output from an ultrafiltration process can be used as the feedstock to a reverse osmosis unit.

#### 4.10.2 Reverse Osmosis

Reverse osmosis can effectively remove particles in the size range 0.1 to 15 nm. The term osmosis describes the natural movement of water from one solution through a selective (semi-permeable) membrane into a more concentrated solution. By applying pressure to the more concentrated solution, the flow direction can be reversed so that water passes through the membrane, hence the name, reverse osmosis. The pressures required for this process are typically 2,000–7,000 kPa (300–1,000 lb/in.<sup>2</sup>).

The membranes in reverse osmosis units are easily fouled by colloidal matter in a feed waste stream, therefore a feed stream free of these materials is required for efficient performance of a reverse osmosis unit. It may also be necessary to remove iron to minimize scaling. The application of reverse osmosis in the treatment of secondary-treated wastewaters has been limited because the operating and maintenance costs are relatively high. However, this process may prove to be a suitable and cost effective choice for purifying certain industrial waste streams.

## 5. BIOLOGICAL TREATMENT PROCESS

Biological treatment of wastes encompasses those processes that rely on microbes to change or degrade organic wastes in a controlled manner. A function of biological treatment processes is to remove organic matter from the effluent through the metabolic means of oxidation and cell synthesis. Major factors affecting the microbial activity are moisture, temperature, pH, oxygen concentration, hydraulic retention time (HRT), presence of toxic elements or compounds, and the type and quality of the organic material serving as the food supply of microbes. The challenge for the designer or a biological waste processing system is to be able to exercise some degree of control over these conditions (Horan, 1990).

Biological processes are categorized according to the method of contacting the organic food with the microflora and the presence or absence of molecular oxygen. The common biological treatment processes of agricultural and food processing residues are aerobic decomposition, anaerobic digestion, and composting. Biological processes are generally viewed more positively by the public than landfilling and incineration. Perhaps the reason is that biological processing is touted as “natural”, with the end products being safely returned to the earth.

### 5.1 Aerobic Processes

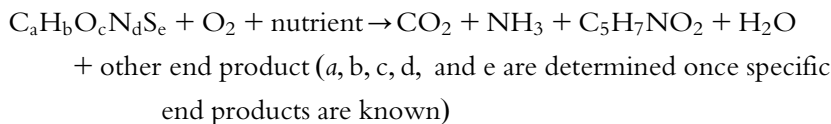
The uses for aerobic biological processes are chemical oxidation of organic material, ammonium ( $\text{NH}_4^+$ ), or ammonia ( $\text{NH}_3$ ). These reactions are brought about with oxygen as the final electron acceptor. Organic material is mineralized to  $\text{H}_2\text{O}$ ,  $\text{CO}_2$ ,



$\text{NH}_4^+$ , or  $\text{NH}_3$ , and other constituents, and the  $\text{NH}_4^+$  or  $\text{NH}_3$  are oxidized to nitrate ( $\text{NO}_3^-$ ). Each reaction also results in the synthesis of new cell mass.

### 5.1.1 Biochemical Reactions

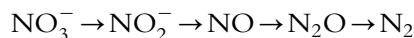
#### 1. Oxidation and synthesis.



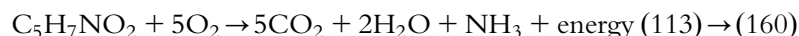
#### 2. Nitrification.



#### 3. Denitrification.



#### 4. Endogenous (meaning growing from within) respiration.



(These are the molecular weights for compounds on either side of the reaction)  
1:1.42

(These are ratios of molecular weights showing it takes 1.42 moles of  $\text{O}_2$  to every mole of bacteria to undergo endogenous respiration.)

### 5.1.2 Microbiology

*Achromobacter*, *Beggiatoa*, *Flavobacterium*, *Geotirichum*, *Nitrobacter*, *Nitrosomonas*, *Pseudomonas*, and *Sphaerotilus* are the common microorganisms found in aerobic systems. Protozoa such as *Vorticella*, *Opercularia*, and *Epistylis* and rotifers do not stabilize waste but they consume dispersed bacteria and small biological floc particles that have not settled, that is, protozoa and rotifers act as effluent polishers:

#### 1. Suspended growth system.

a. *Bdellovibrio*, *Lecithothrix*, *Mycobacterium*, *Nocardia*, *Thiothrix*, and *Zoogloea* are bacteria that are mostly found in suspended growth systems.

#### 2. Attached growth system.

a. *Alcaligenes*, *Chlorella*, *Fusarium*, *Mucor*, *Penicillium*, *Phormicium*, *Sphaerotilus natans*, *Sporothrix*, and *Ulothrix*, and yeasts are mostly found in attached growth systems. Algae such as *Chlorella*, *Phormicium*, and *Ulothrix* are not directly involved in waste stabilization. They add oxygen to the system but they can cause clogging of the system or take up  $\text{O}_2$  when they die, which can cause bad odors.

### 5.1.3 Activated Sludge Process

Activated sludge treatment of food processing wastewater involves an initial aeration process followed by a clarification step wherein biomass is settled out and a return of varying amounts of the active biomass to the aeration tank. The activated sludge process is an aerobic suspended growth treatment system in which microorganisms use the organic content of wastewater as an energy source and for survival and replication. The activated sludge process has the advantage of removing organic matter from large volumes of wastewater in a relatively compact reactor. The combination of primary treatment (e.g. sedimentation, floatation) followed by secondary treatment using the activated sludge process is capable of removing over 90% of the BOD from a given wastewater.

The aerobic treatment process is appropriate for some food processing wastewaters. Costs associated with aeration may be prohibitive. [Orhon et al. \(1993\)](#) investigated biological treatability by aeration of various dairy processing wastewaters, but aerobic treatment by aeration was unsuitable for treating high-strength wastewater such as whey, because of high energy requirements for aeration and the need for copious dilution water.

### 5.1.4 Trickling Filters

Trickling filters are a fixed film biological wastewater treatment system used primarily to remove soluble organic matter and for ammonia oxidation. A trickling filter is a fixed film process in which the reactor is filled with a medium, such as small rocks. A principal advantage of fixed film biological wastewater treatment systems over suspended growth systems is that their microbial populations are more resistant to shock loads of contaminants. Also, trickling filters are simpler to operate than the activated sludge process and have lower operational costs. This makes them attractive for wastewater treatment in smaller communities and in certain industries ([McFarland, 2001](#)).

They are not suited to large flow volumes because land requirements are high and they are not able to achieve the high level of BOD reduction that is possible with a well-designed activated sludge system. They may also be a source of odors and fly nuisance, especially during periods of warm weather ([Horan, 1990](#)).

### 5.1.5 Rotating Biological Reactors

Another reactor suitable for small wastewater flow is the rotating biological contactor (RBC). It is similar in principle to the trickling filter (fixed film). However, its operation is based on thin films of microbes attached to rotating disks immersed in a tank of wastewater.

A major advantage of the RBC system is its ease of operation. The system can be designed as a package plant to fit the wastewater flow needs of a small community or an industry. Other advantages of the RBC are stability against hydraulic shock

loadings and eliminations of clogging of filter nozzles, a problem which is associated with the trickling filter process (Rhyner *et al.*, 1995).

### 5.1.6 Aerated Lagoon

An aerated lagoon is a basin in which wastewater is treated either on a flow-through basis or with solids recycle. Oxygen is usually supplied by means of surface aerators or diffuser air units. As with other suspended growth systems, the turbulence created by the aeration devices is used to maintain the contents of the basin in suspension.

### 5.1.7 Anaerobic Processes

Anaerobic biological treatment processes do not require air input and generate considerably smaller amounts of sludge. Because oxygen is toxic to most anaerobic microorganisms, molecules other than oxygen such as sulfur or carbon dioxide are used as the final electron acceptors. Anaerobic treatment normally produces ten times less refractory biomass (sludge) that must be disposed of than aerobic treatment. Under anaerobic conditions, ordinarily more than 90% of the organic matter in the wastewater is converted to methane gas as an end product. Methane is a potential energy source. This equivalent energy is not available for biomass synthesis, and thereby lessens biomass disposal requirements and the financial burden associated with disposal considerably.

Methane accounts for about 90% of the energy, originally in the wastewater stream that could be tapped by the bacteria. Methane has a calorific value of 9,000 kcal/m<sup>3</sup> (1,000 Btu/ft<sup>3</sup>) and can be burned on site to provide heat for digesters or to generate electricity. Biogas produced from anaerobic treatment has been promoted as part of the solution to energy problems. Little energy (3–5%) is wasted as heat in the anaerobic biological process (Saham, 1984; Speece, 1996). Table 23.4 compares aerobic and anaerobic treatment processes in food processing waste treatment.

**Table 23.4** Comparison of Aerobic and Anaerobic Decomposition Processes in Food Processing Waste Treatment

Characteristic	Aerobic	Anaerobic
Dilute wastes	Very effective in removal of BOD	Generally not as efficient in BOD removal as aerobic
Concentrated waste streams (>3,000 mg BOD/l)	Cost of aeration (O <sub>2</sub> /air) is significant	Good potential for energy recovery (methane)
Temperature of operation	Effective over a wide range of temperatures, from 10 °C to 60°C	Best above 25 °C, relatively poor efficiency below 20 °C
Cell generation	High cell generation per gram BOD removal	Low cell generation per gram BOD removal
Oxygen	Oxygen/air required	No oxygen required

The anaerobic process is accomplished through biological conversion of organics to methane and carbon dioxide in an oxygen-free environment. The overall conversion process is often described as a three stage process, which occurs simultaneously within the anaerobic digester. These are:

1. Hydrolysis and liquefaction or the hydrolysis of insoluble biodegradable organic matter.
2. Acidogenesis, which is the production of organic acids from smaller soluble organic molecules.
3. Methane fermentation.

A basic outline of the pathways of anaerobic metabolism is given as [Figure 23.2](#). More detailed pathways through completion of the acidogenic phase are given in [Figure 23.3](#). Under most circumstances in treating food processing wastes, acetate is a common end product of acidogenesis. This is fortunate because acetate is easily converted to methane in the methanogenic phase. Because of the difficulty in isolating anaerobes and the complexity of the bioconversion processes, much still remains unsolved about anaerobic digestion.

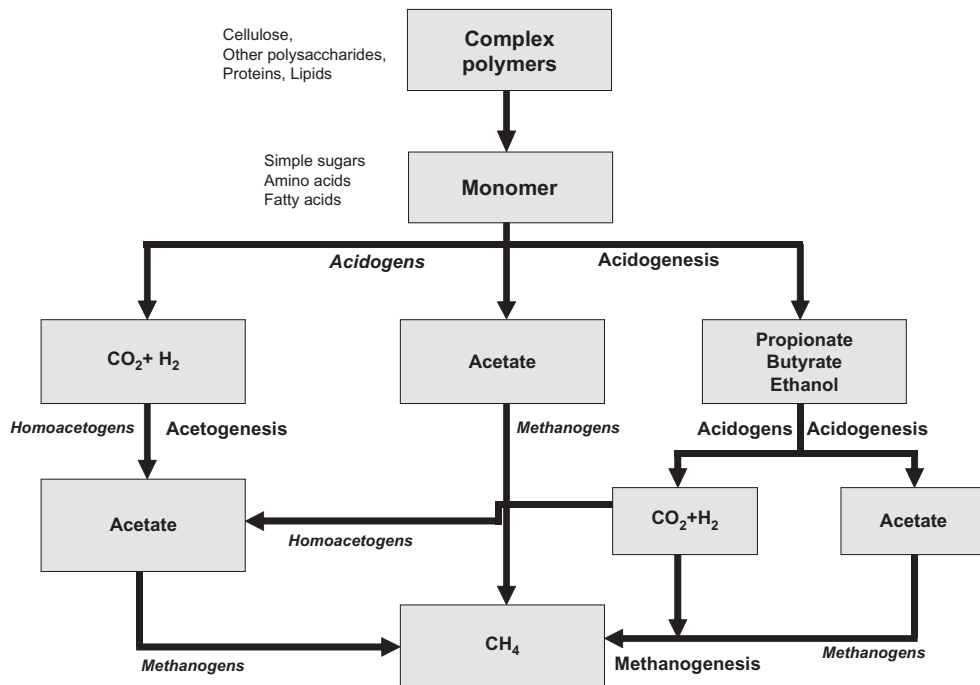


Figure 23.2 Scheme of anaerobic metabolism pathways.

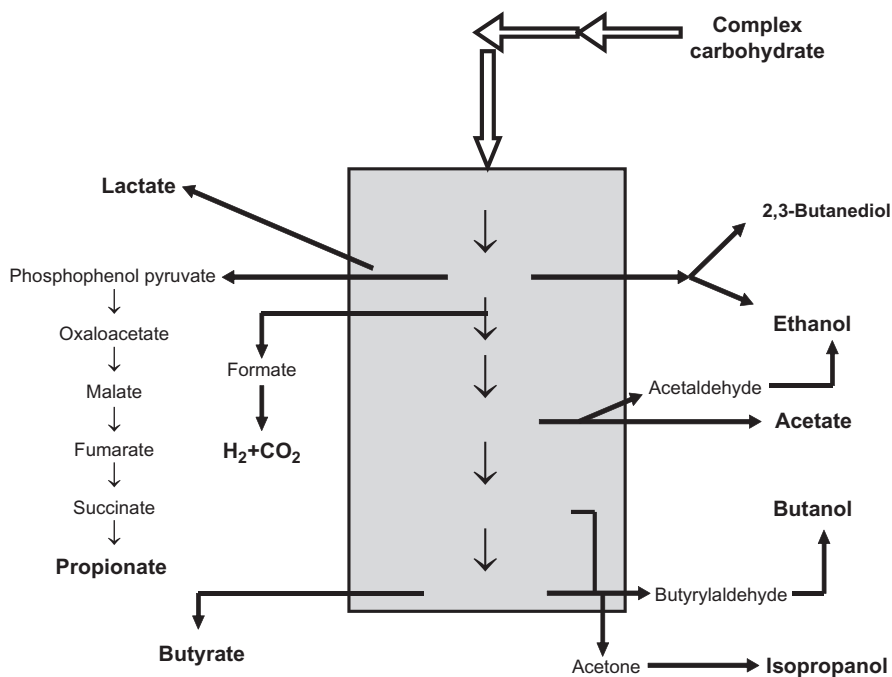


Figure 23.3 Anaerobic metabolism pathway and end products.

### 5.1.8 Hydrolysis and Liquefaction

Hydrolysis and liquefaction are the breakdown of large, complex, and insoluble organics into small molecules that can be transported into microbial cells and metabolized. Hydrolysis of the complex molecules is catalyzed by extracellular enzymes such as cellulase, protease, and lipase. Essentially, organic waste stabilization does not occur during hydrolysis, and the organic matter is simply converted into a soluble form that can be utilized by the bacteria (Parkin and Owen, 1986).

### 5.1.9 Acidogenesis

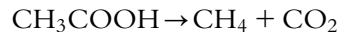
The acidogenesis stage is a complex phase involving acid forming fermentation, hydrogen production, and the acetogenic step. Once complex organics are hydrolyzed, acidogenic (acid-forming) bacteria convert sugars, amino acids, and fatty acids to smaller organic acids, hydrogen, and carbon dioxide. The products formed vary with the types of bacteria as well as environmental conditions. The community of bacteria responsible for acid production may include facultative anaerobic bacteria, strict anaerobic bacteria, or both (e.g. *Bacteroides*, *Bifidobacterium*, *Clostridium*, *Lactobacillus*, and *Streptococcus*). Hydrogen is produced by the acidogenic bacteria and hydrogen-producing acetogenic bacteria. Acetic acid is also produced by these groups

in addition to hydrogen-consuming acetogenic bacteria (McCarty and Smith, 1986; Parkin and Owen, 1986).

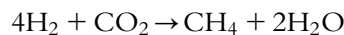
Acetogenic bacteria, such as *Syntrobacter wolini* and *Syntrophomonas wolfei*, convert fatty acids (e.g. propionic acid, butyric acid) and alcohol into acetate, hydrogen, and carbon dioxide, which are used in methanogenesis. These microorganisms are related and can tolerate a wide range of environmental conditions (Novaes, 1986). The syntrophic association between acetogenic bacteria and CO<sub>2</sub> reducing methanogenic bacteria can ensure maintenance of low hydrogen concentration (Harper and Pohland, 1986).

#### 5.1.10 Methanogenesis

The formation of methane, which is the ultimate product of anaerobic treatment, occurs by two major routes. Formic acid, acetic acid, methanol, and hydrogen can be used as energy sources by the various methanogens. The primary route is the fermentation of the major product of the acid forming phase, acetic acid, to methane and carbon dioxide. Bacteria that utilize acetic acid are acetoclastic bacteria (acetate splitting bacteria). The overall reaction is



The acetoclastic bacteria grow much more slowly than acid-forming bacteria. This group comprises two main genera, *Methanosarcina* and *Methanotherix*. During the thermophilic digestion of lignocellulose waste, *Methanosarcina* is the dominant acetoclastic bacteria encountered in the bioreactor. About two-thirds of methane gas is derived from acetate conversion by acetoclastic methanogens. Some methanogens are also able to use hydrogen to reduce carbon dioxide to methane (hydrogenophilic methanogens) with an overall reaction of



(Balch *et al.*, 1979; Novaes, 1986; Zeikus, 1977).

#### 5.1.11 Anaerobic Reactor Designs

The nature of the waste is an important consideration in the choice of an anaerobic reactor design. Beyond this, the molecular composition of the waste may also influence reactor operation. Successful anaerobic treatment requires a microbial balance between the fast-growing acidogens and the slow-growing methanogens. Because of the slow growth rate of methanogens, efficient biomass retention is required for successful anaerobic system performance. The retention of active biomass has been achieved in advanced reactors such as the upflow anaerobic sludge blanket (UASB), which has been used widely. More recently, the induced blanket reactor (IBR), the anaerobic sequencing batch reactor (ASBR), various anaerobic contact reactors, anaerobic bio-filters, and fluidized bed reactors have become available (Lettinga, 1995; Lettinga and Hulshoff-Pol, 1991). Also, there

are other types of bioreactors that retain biomass including the fixed film process, the filter or expanded bed process, anaerobic baffled reactor, and the rotating biological contactors. More detailed descriptions of most of them can be found in [Metcalf and Eddy \(1991\)](#) and [Rittmann and McCarty \(2001\)](#). The advantages and disadvantages of the various biomass-retaining anaerobic systems are summarized in [Table 23.5](#).

#### **5.1.12 Up-Flow Anaerobic Sludge Blanket Reactor (UASB)**

The UASB was initially developed for widespread use in The Netherlands, and is currently the most popular high-rate anaerobic system in the world, used in particular to treat different types of wastewaters. The UASB process is ideally suited for high strength organic wastes that contain low concentrations of suspended solids. Unlike some systems, such as fluidized bed and biofilter systems, the UASB does not require attachment material. Wastewater enters into a UASB at the bottom and exits at the top, and the biomass is developed as a flocculent mass in an upward flowing water stream. Mixing in a UASB is not necessary. Sufficient contact between the biomass and the substrate occurs because of the up-flow velocity of the wastewater in the sludge blanket, as well as biogas production. A good distribution of the substrate is obtained by having more inlet points at the bottom of the reactor. A gas–solids separation system is used in this type of reactor to collect the biogas and to separate the biomass from the effluent. Biomass falls back in the reactor because of a decreased up-flow velocity after biogas is separated in the settling section. A gas solid separation system is even required for the treatment of much-diluted wastewater ([Hulshoff-Pol and Lettinga, 1986](#); [Weiland and Rozzi, 1991](#)).

#### **5.1.13 Induced Blanket Reactor (IBR)**

The IBR is an in-vessel high rate ( $\leq 5$  day hydraulic retention time) anaerobic digester developed at Utah State University. Like the UASB, the IBR does not require attachment material. Wastewater enters at the bottom and exits at the top, and the biomass is developed as a flocculent mass inside the tank. Mixing is not necessary. Sufficient contact between the biomass and the substrate occurs because of the up-flow velocity of the wastewater in the sludge blanket, and the biogas production. An IBR tank has a height to diameter ratio of 2.5–3.5, which can vary depending on waste type. The tanks are usually  $\sim 10$  m (32 ft) tall to facilitate settling. There is a septum located near the top of the tank. Treated waste must pass through a relatively small orifice in the septum. An anti-plugging device fills the orifice and can be made to push solids back below the septum or can be reversed to pull solids through the hole, if necessary ([Hansen and Hansen, 2005](#)). IBRs are also equipped to break up foam or a floating layer that may otherwise form at the top. Waste enters the bottom of the tank and is treated as it moves vertically through the tank and discharged at the top. The upward velocity is much less than that recommended for UASBs. Livestock

**Table 23.5** Comparison of Biomass-Retaining Anaerobic Reactor Designs (Grady *et al.*, 1999; Weiland and Rozzi, 1991; Zhang *et al.*, 1997)

Type of Process	Advantages	Disadvantages
Anaerobic contact	Suitable for concentrated wastewaters; easy to mix; high effluent quality achievable	Ability of biomass to settle is critical; system is mechanically complex; suitable for low to moderate levels of TSS
UASB	High biomass concentrations; small bioreactor volumes; high quality effluent; mechanically simple; well mixed; no need of support media.	Special bioreactor configurations required; performance depends on settleable of biomass; little dilution of inhibitors; granulation process difficult to control
ASBR	High biomass concentrations; better effluent quality control; a simple and flexible operation; No liquid or solids recycling; mechanically simple; well mixed; No short circuit	Long start-up period; occurrence of dead zones, requirement of high settle time, solids washout, slow start-up period, little dilution of inhibitors; poor knowledge of feeding strategy
Anaerobic filter	High biomass concentrations; small reactor volume; high quality effluent; mechanically simple; well mixed; not dependent on settleable biomass	Suspended solids can accumulate and plug reactor; not suitable for high levels of TSS; little process control; high cost of media and support; little dilution of inhibitors
Downflow stationary fixed film	High biomass concentrations; small reactor volumes; high quality effluent; mechanically simple; compact system; performance not affected by high levels of TSS and not dependent on settleable biomass; well mixed	Biodegradable solids are not degraded; high cost of process control; little dilution of inhibitors
Fluidized bed/expanded bed	High biomass concentrations; small reactor volumes; excellent mass transfer; often better quality than other processes; most compact of all processes; performance does not depend on settleable solids; well mixed; good process control	Long start-up period; high power requirements; not suitable for high levels of TSS; mechanically complex; cost of media is high; little dilution of inhibitors
Induced blanket reactor	High biomass concentrations; small bioreactor volumes; high quality effluent; mechanically simple; well mixed; no need of support media; insulated from environmental conditions and thus operates more consistently, and the likelihood of system plugging is very low	Special bioreactor configurations required; will not handle high viscosity wastes (i.e. >12% solids animal manure) or it essentially becomes a vertical plug flow digester; biomass must settle to some extent



waste has been successfully treated with short HRT in an IBR that was about 10 m high by 4 m in diameter (Hansen and Hansen, 2002).

The IBRs captures solids from the influent where they are kept in the reactor vessel so that solids retention time greatly exceeds hydraulic retention time. These solids also become attachment media for bacteria. If the solids concentration becomes too great, a portion is removed to avoid plugging. The IBR thus forms a sludge blanket within the digester vessel and can help maintain the size of the blanket so as to avoid plugging.

An integral part of the IBR system is a modular approach. IBR tanks are usually not larger than 100,000–120,000 l (26–32 thousand gallons). Very large agricultural production or processing facilities can be accommodated. A 1,000 animal unit (1,000 pounds (454 kg) of live weight per animal unit) farm would require three to four tanks depending on species and milk production, in the case of dairy animals. An IBR system can be built to fit small or large facilities and can be easily expanded. If part of the system fails, it does not stop the entire process.

#### **5.1.14 Anaerobic Sequencing Batch Reactor (ASBR)**

The ASBR process is able to handle soluble influent streams and also those with higher TSS. The ASBR is a non-steady-state or pseudo steady-state, anaerobic treatment system. By definition of non-steady-state, substrate conversion rate and biomass production rate of the system vary during the cycle. An intermittent feed and decant regime results in alternating high/low substrate (feast/famine) conditions in the reactor. One of the most important operation characteristics of the ASBR is a high substrate concentration at the end of the feed cycle and a low substrate concentration at the end of the react cycle. The reactor cycle includes four-steps:

1. Wastewater is fed into the reactor with settled biomass.
2. Wastewater and biomass are mixed intermittently.
3. Biomass settled.
4. Effluent is withdrawn from the reactor (Arora, 1985; Dague *et al.*, 1992; Sung and Dague, 1995).

As the ASBR is a closed system, a reduced pressure results when effluent is withdrawn unless provision is made for biogas backflow. To overcome this, a separate gas bag is installed to maintain constant pressure. While decanting, the gas bag decreases in volume, refilling again during the feed step. Once the decant step is completed, the reactor is ready to be fed another batch of substrate (Sung and Dague, 1995).

#### **5.1.15 Anaerobic Contact Reactor**

The anaerobic contact reactor has been successfully used to treat high BOD industrial wastes, for example, those generated in meat packaging operations. In this anaerobic treatment process, raw wastes are mixed with recycled sludge solids and digested in a completely mixed reactor. The HRT may be less than 12 h and after digestion the

mixture is separated in a clarifier or vacuum flotation unit. The supernatant is discharged, typically to an aerobic treatment basin, for further treatment. Much of the settled biological solids are recycled back to the reactor in order to maintain a high rate of biological activity. The synthesis rate of microbes is low in the anaerobic environment. Therefore, the amount of waste solids requiring final disposal is small.

#### **5.1.16 Continuously Stirred Tank Reactor (CSTR)**

The CSTR is also commonly called a completely mixed high rate digester. It is used for the digestion of concentrated organic mixtures, such as waste primary and biological sludge, as well as high strength industrial wastes. It is commonly used around the world. In the CSTR, the liquid or slurry stream is continuously introduced and liquid contents are continuously removed from the reactor.

Anaerobic treatment using a CSTR normally consists of a well-mixed reactor without solids recycling because all solids are in suspension and exit with the effluent. The SRT is equal to the HRT in this type of reactor. If operated properly, biomass that grows within the reactor continuously replaces the biomass removed from the reactor in the effluent stream. The CSTR is commonly used for aerobic or anaerobic treatment of highly concentrated organic mixtures, such as waste primary and biological sludge, as well as high strength industrial wastes (Rittmann and McCarty, 2001). The basic characteristic of the ideal CSTR is that the concentration of substrate and biomass are the same everywhere throughout the reactor. As the biomass in the CSTR configuration is not retained by settling or attachment, the percentage of COD removal tends to be limited. The reactor must provide a minimum HRT of about 10 days at 35°C, depending on the waste, with 10–20 days being a reasonable HRT range. Nevertheless, these vary with wastewater composition and degree of agitation.

## **5.2 Composting Processes**

The term composting is a biological treatment process most commonly applied to solid or semisolid waste material with moisture content of 30–50%. Modern definitions of composting further expand on this description to include conditions that promote development of high temperatures sufficient to destroy pathogens, ending with a compost product sufficiently stable for storage and environmentally safe for application to land (Mulligan, 2002).

Composting involves biological decomposition and stabilization of organic materials, with putrescible organic material converted to stabilized compost by microbial action. Compared to other stabilization processes, composting is a fast, simple, and safe approach to the bulk treatment of solid or semisolid organic wastes. Composting is commonly used for treating agricultural wastes and sewage sludge (Epstein, 1997).

Most composting processes are aerobic, with the main products being stabilized organic matter, water, carbon dioxide, and heat. Anaerobic composting is sometimes

called solid state fermentation. Significantly less heat is produced during anaerobic composting, with methane, carbon dioxide, and low molecular weight organic acids being produced. Energy, or heat production, is essential to the success of the composting process. Two distinct temperature phases occur during composting. First, a mesophilic phase in which microbial action raises the temperature up to 40–55°C, forcing the process into a thermophilic phase in which the mesophilic microorganisms are inactivated and replaced by thermophiles. At these higher temperatures, pathogenic microorganisms are inactivated. Process control is essential in maintaining temperatures at suitably high levels in order to destroy pathogens. Composting also reduces the water content of the composted waste thereby reducing the volume of material that has to be eventually disposed of. Composting effectively recycles the organic matter and nutrients in wastewater and converts wastes into a useful material.

Composted waste can be used as a soil conditioner to reduce the bulk density of the soil, to increase the water holding capacity, and encourage proper soil structure by the additional organic matter, thus encouraging a healthy soil microfauna/flora and healthy plant root development. Composted waste is also a fertilizer that can improve crops by the addition of nitrogen, phosphorous, and trace elements (Haug, 1993).

## 6. LAND TREATMENT OF WASTE

### 6.1 Land Application

Under the right circumstances, land application of wastewater can be a more effective and less energy-intensive treatment than conventional systems such as activated sludge process, trickling filters, and aerated lagoons. However, transportation distance to application sites, land area of application sites, soil types, and public attitudes may be limiting factors in choosing land application as a method of wastewater treatment.

Land application of wastes is the surface spreading or subsurface injection (10–25 cm (4–10 in.)) of liquid or solid waste material on or into soil (Ockerman and Hansen, 2000). Wastewater polluted with organics, including wastewater from a food processing facility can be land applied. This method of treatment removes a large percentage of organic and inorganic pollutants from food processing waste. Land treatment employs mechanical, biological, and chemical processes, which occur naturally in or on the soil in the purification of wastewater. Organic matter in food processing waste represents high BOD and is degraded by soil bacteria. Refractory matter eventually becomes part of the soil matrix. Nutrients in the waste are taken up by crops or recycled into the soil.

Commercial agricultural manure spreaders and liquid-manure injection equipment are suitable for land application of food processing waste. Subsurface injection of offensively odoriferous material will control odors, reduce insect attraction, and conserve nitrogen. Surface-applied animal-processing waste can be incorporated into the soil by plowing or disking soon after application. References which explain land

application of wastes in more detail include [Loehr \*et al.\* \(1979a,b\)](#), [McFarland \(2001\)](#), [Ockerman and Hansen \(2000\)](#), [Reed and Crites \(1984\)](#).

The large amounts of wastewater produced by a food processing plant often require a large land area for even a medium-sized plant. If land is not available or too costly, this type of treatment method is not feasible. In most cases, waste streams should be segregated and the most heavily polluting wastes can be land applied, as for example blood from meat processing or rendering that is about 160,000 mg/l BOD.

Food processing waste is often a good source of nitrogen (N), phosphorus (P), and potassium (K). Nearly all of the P and K in food processing wastes are available for plant use in the year of application. Nitrogen in organic waste is of two forms, organic and ammonia. The nitrogen in the ammonia form is available when spread. However, if the organic waste is spread on to the surface, sizable amounts of ammonia N may be lost to the atmosphere by volatilization. Generally less than one-half of organic N is available to plants in the year it is spread. Organic N released (mineralized breakdown of organic N to available ammonia N) during the second, third, and fourth years after initial application is usually about 50%, 25%, and 12.5%, respectively of that mineralized during the first cropping season. However, to determine precisely how much N, P, or K will be available to crops from land application of food processing waste, it is necessary to have the waste analyzed. This can be done at state universities (in the USA) or at commercial laboratories. Records should be kept of each year's application. Soil receiving food processing wastes should also be tested regularly for levels of the so-called macronutrients N, P, and K.

The waste and soil might also be tested for micronutrients such as sulfur and iron and for possible toxic substance buildup such as copper, zinc, lead, or cadmium. Food waste application rates should be designed to match the nutrients removed by the crop. If a particular waste is extremely high in some particular nutrient, it will limit the application rate. Most often, the application rate is limited by P or N. If the application rate is limited due to a particular nutrient, the waste can still be used to advantage by adding commercial fertilizer to make up deficits in other nutrients.

## 6.2 Landfilling

Landfilling is the most commonly used waste disposal method in the USA. Landfills receive about 80% of the discarded solid wastes. A modern sanitary landfill is an engineered site, selected, designed, and operated in such a manner as to minimize environment impacts. The number of landfills in the USA is decreasing for three reasons:

1. Many older landfills that do not meet current design operation standards are being closed.
2. It has become increasingly more difficult to site new landfills, i.e. land is generally expensive near heavily populated areas where large amounts of solid wastes, including food processing wastes are produced.

3. The costs of site design, construction, leachate and gas monitoring and collection, leachate treatment, administration, and engineering favor the construction of large facilities (Rhyner *et al.*, 1995).

The difficulty faced by municipalities in identifying and developing new landfill sites is not necessarily caused by a lack of land at a suitable location with suitable soil and hydrogeological conditions, but rather by public opposition. People object to landfills because of the nuisance concerns (e.g. dust, noise, traffic, odor), aesthetics, and environmental concerns (e.g. groundwater pollution from landfill leachate, migration of landfill gases to adjacent properties, use of agricultural land).

A sanitary landfill is operated to minimize nuisance conditions arising from litter, dust, odors, and fire, and the attraction of rats, flies, mosquitoes, and birds. The standard method of operation consists of:

- Spreading waste in thin layers in a confined area.
- Compacting the waste to the smallest practical volume.
- Covering the waste daily with soil.

Waste compaction is accomplished by repeated trips over a waste layer with a heavy compactor vehicle. In some cases, soil cover is required less frequently than at the end of each day's operation (Bagchi, 1994).

### 6.2.1 Landfill Bioreactors

A newly developed method for operating landfills is to operate them as anaerobic bioreactors. Landfill bioreactors have several advantages over conventional landfills. Further efforts are required to optimize leachate recirculation, gas production, and the degradation of recalcitrant compounds (Clarke, 2000). In many landfills, the production of landfill gases is considered a nuisance. When operated as a bioreactor, gas collection systems are installed to collect the gases. The gases are often burned or flared to destroy the methane, but at an increasing number of landfills, the gases are being collected for beneficial purposes, such as providing heat and generating electricity. At such sites, it is desirable to design the landfill and control the conditions of decomposition to accelerate the decomposition process, thereby increasing the rate of gas generation. The production of methane can be enhanced by controlling the types of waste accepted and the placement of the wastes, recycling leachate into the landfill to supply moisture, neutralizing the inhibitory effects of organic acids, and adding old anaerobically degraded refuse to increase the population of slow-growing microbes (Barlaz and Ham, 1990; Pohland and Kim, 2000).

## 7. BIOPROCESS TECHNOLOGY FROM WASTE

Many bioprocesses can provide bioenergy or valuable chemicals while simultaneously achieving the objective of pollution control. Wastewaters from the food processing

industry and agricultural wastewaters are ideal candidates for bioprocessing because they contain high levels of easily degradable organic material, which results in a net positive energy or economic balance. Such wastewaters are potential commodities from which bioenergy and biochemicals may be produced. Recovery of energy and valuable materials might reduce the cost of wastewater treatment, and somewhat reduce our dependence on fossil fuels.

The next section describes some different bioprocess strategies that can be used to treat food processing and agricultural wastewater, with resource recovery, biological conversion, and generation of valuable products.

### 7.1 Reuse of Effluent as Resource

As a result of the relatively low costs of potable water and effluent disposal in the USA, it is rarely economical to treat wastewater for reuse within a particular production process. However, some situations can make the reuse of effluent economical. Where local water capacity is insufficient to meet the needs of industry or effluent treatment costs are high, it may be best or necessary for industries to treat their own waste and reuse it. Usually, water is reused several times within the factory before eventually being discharged, starting with processes that require clean water, such as for vegetable washing (Shore *et al.*, 1984).

With the introduction of water supply and disposal discharges, the conservation and multiple use of water, industry has greatly reduced water usage and alleviated water pollution. An interesting example of water reuse can be seen in the sugar beet processing industry. The total water requirement for processing a tonne of sugar beet is between 9 and 19 m<sup>3</sup> (2,200 and 22,000 gal), and most beet factories operated on a once through basis with little or no recirculation of water, which resulted in vast quantities of wastewater being generated. Wastewater from sugar beet is particularly polluting as it contains low molecular weight carbohydrates, usually sucrose or volatile fatty acids, in high concentrations (2,000–5,000 mg/l BOD). These can cause severe sewage fungus outbreaks and deoxygenation in receiving waters. However, with careful waste management, the wastewater can be reduced to as little as 0.5–1.0 m<sup>3</sup>/t (120–240 gal/t) (McNeil, 1984). This has the added advantage of producing an effluent volume more amenable to treatment, normally by anaerobic processes (Shore *et al.*, 1984).

### 7.2 Bio-Energy Recovery

Energy produced from the bioconversion of food industry wastes has mainly been confined to the production of methane from anaerobic digestion, although the production of energy from various other types of food wastes is possible. Energy can be produced from waste material by a variety of other processes including combustion,

pyrolysis, liquefaction, and gasification. Hydrogen is a promising alternative clean energy source, which produces no greenhouse gases and is more economical than methane at less than stoichiometric yields, when produced with modified anaerobic microorganisms in fermentation.

### **7.2.1 Pyrolysis and Gasification**

Pyrolysis and gasification can convert biomass into a stable and transportable fuel that can be substituted for conventional fuels. Solid, liquid, and gaseous fuels that have similar properties to coal, oil, and natural gas can be produced from biomass – including wastes, by a variety of processes.

Pyrolysis is the thermal degradation of carbonaceous material at temperatures of 400–800°C in the absence of oxygen. The products are gases, a mixture of liquid hydrocarbons, and a char residue (Caballero *et al.*, 1997; Stolarek and Ledakowicz, 2001). Gasification is the thermal conversion of carbonaceous material to gaseous hydrocarbons by partial combustion with air at temperatures of 900–1,100°C. The process uses the waste sludge with high dry solids content of 90–95% and so is used in conjunction with thermal dryers as an alternative to incineration. The advantage of gasification is that it can produce sufficient fuel to power both the thermal dryer and the gasifier producing as an inert residue suitable for landfill. The environmental advantages are the reduction in associated transport (Stolarek and Ledakowicz, 2001).

### **7.2.2 Methane Recovery**

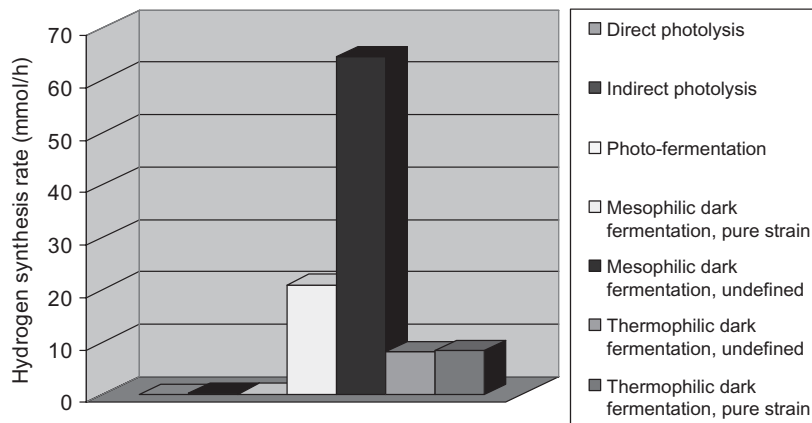
Methane recovery as biogas is the most widespread bioconversion process used for industrial and agricultural wastewaters. The methane that is produced by anaerobic digestion has traditionally been used as a fuel resource, usually for on-site heating or electricity production. The digestion process and the biochemical and microbiological principles involving the anaerobic reaction are fully explained in Section 5.2. Recently, methane has also been converted to other useful products, such as methanol for use in production of biodiesel, by production of syngas (a mixture of hydrogen and carbon monoxide) in chemical processes. Production of syngas requires the removal of impurities, such as hydrogen sulfide, in the digester biogas, which can poison the catalyst.

### **7.2.3 Hydrogen Recovery**

Much recent interest has been expressed in the production of hydrogen from wastewater, because of its potential importance in our economy. Biological systems provide a range of approaches to generate hydrogen including direct photolysis, indirect biophotolysis, photo-fermentation, and dark fermentation (Benemann, 1996). The biological production of hydrogen from anaerobic fermentation of

organic substrates promises to be an economical and sustainable means of hydrogen production if the conversion yield can be increased. To some extent, anaerobic or semi-anaerobic photo-biological processes have economic benefits, if only in considering hydrogen yields. However, the oxygen content of the resulting gas mixture is dangerous, and its fermented broth can cause additional water pollution problems (Das and Veziroglu, 2001; Nandi and Sengupta, 1998). Dark fermentation, using anaerobic fermentative bacteria that produce hydrogen anaerobically is actually a more cost effective process, as it can use waste material or wastewaters of low value. One of the merits of anaerobic fermentative hydrogen production is a higher hydrogen synthesis rate, compared to many other biological processes (Figure 23.4) (Levin *et al.*, 2004). The anaerobic fermentation system may have a more practical application by producing hydrogen on site with a reduced reactor size. Also, biological hydrogen production can share many common features with methanogenic anaerobic digestion, especially the relative ease with which the two gaseous products can be separated from the treated wastes.

Studies of hydrogen production using mixed cultures with non-sterile substrates have only recently attracted research attention. It was thought that using non-sterile substrate from natural mixed inocula would probably cause bioreactors to lose recoverable hydrogen production capabilities. In order to recover the bio-hydrogen produced during mixed culture anaerobic fermentation, consumption of hydrogen through interspecies transfer—methanogens, homoacetogens, and sulfate reducing bacteria—must be prevented. If the activities of hydrogen-consuming bacteria are inhibited by the enrichment of hydrogen-producing spore formers, the culture possesses a significant capacity for the conversion of non-sterile substrates (i.e. as organic waste and wastewater) into hydrogen (Cheong and Hansen,



**Figure 23.4** Comparison of the rates of hydrogen synthesis in different biological production processes.



2006). The inhibition is commonly accomplished by heat treatment of the inoculum to kill or injure all microorganisms, except for spore-forming fermentative bacteria (i.e. *Clostridiaceae*, *Thermoanaerobacteriaceae*) (Lay *et al.*, 1999; Van Ginkel *et al.*, 2001).

Other methods that have been used include the operation at high dilution rates or low pH (Chen *et al.*, 2001; Lee *et al.*, 2002). Cheong and Hansen (2006) investigated the single and combined effects of various other treatment processes (e.g. wet heat, dry heat and desiccation, methanogen inhibitor, freezing and thawing, chemical acidification) to find enrichment conditions that enhance anaerobic hydrogen production in a more efficient manner. Figure 23.5 illustrates the difference of hydrogen production yield induced from various treatments of the natural sludge as an inoculum.

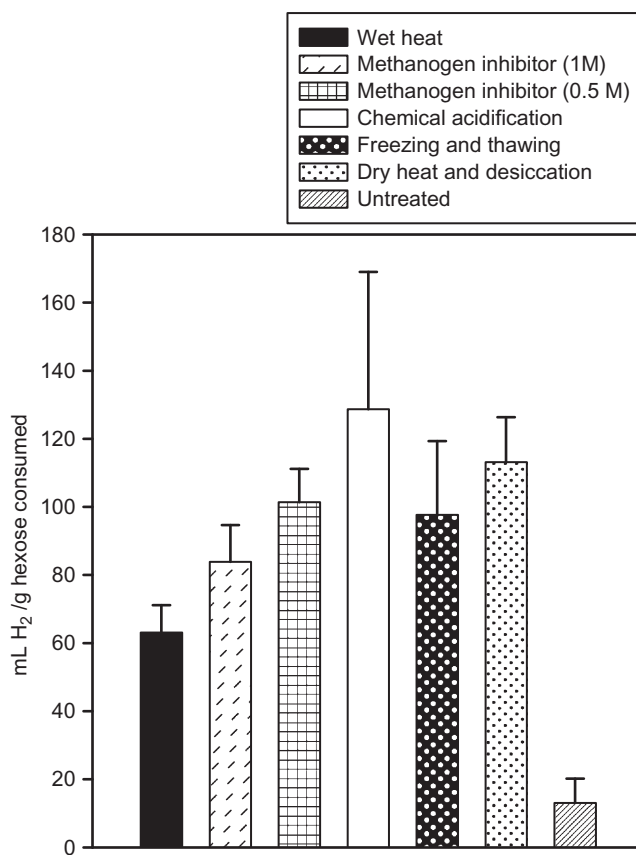


Figure 23.5 Specific hydrogen production yield after bacterial stress treatments. ml H<sub>2</sub>/g hexose consumed, milliliters hydrogen per consumed gram of hexose (Cheong and Hansen, 2006).

### 7.3 Fuel-Ethanol Production

Bioethanol is another biofuel that has been included in many research programs. Four basic steps produce bioethanol:

1. Production of biomass from solar energy (biomass comes from different sources: energetic crops, waste from food crops; biomass waste in general).
2. Conversion of biomass to fermentable products (there are basically four processes, with different technologies for ethanol production, which will be commented on below).
3. Fermentation of biomass intermediates to ethanol.
4. Recovery of ethanol and byproducts.

The basic differences among bioethanol technologies lie in the hydrolysis processes obtaining sugars. Basically there are four:

1. Concentrated acid hydrolysis.
2. Diluted acid hydrolysis.
3. Enzymatic hydrolysis.
4. Gasification and fermentation (Mata-Alvarez and Mace, 2002).

The bioconversion technologies for ethanol fermentation are mainly crop-based, utilizing substrates such as sugar cane juice and corn starch. There has been increasing interest in the idea of obtaining chemical and liquid fuels from cellulose. As the cost of raw materials can be as high as 40% of the ethanol cost, recent efforts have concentrated on utilizing lignocellulose to produce a biomass-derived fuel. It has been estimated that lignocellulose accounts for about 50% of biomass in the world (Zaldivar *et al.*, 2001).

Cellulose is converted to ethanol (ethyl alcohol) by a two-stage reaction. Crude cellulose, in the form of oligosaccharides and polysaccharides, generally must be hydrolyzed to monosaccharides in a separate reaction before fermentation. Hydrolysis can be either chemical, using acids, or enzymatic, using cellulase obtained from bacteria and fungi, such as *Cellulomonas* spp., *Trichoderma vivide*, *T. lignovum*, *Chrysosporium lignovum*, *C. pruiniosum*, and *Penicillium irieusis*. Starch hydrolysis is relatively easy by using both acid and enzyme methods, whereas cellulose requires pretreatment to free the associated lignin before enzymatic hydrolysis. If the percentage of lignin in the crude cellulose is high, as is the case with a number of agricultural derived byproducts, enzymatic hydrolysis is much less effective. Therefore, chemical or mechanical methods must be used instead of enzymes, which results in high energy costs (Chandrakant and Bisaria, 1998). The yeasts used for fuel ethanol production are all strains of *Saccharomyces cerevisiae* and so are genetically similar (Chung and Lee, 1984). Apart from sugar cane, a wide range of materials can be used including oats, wheat, silage, and sugar beet pulp (Zaldivar *et al.*, 2001).

### 7.4 Chemical Production

Although bioenergy production may reduce the cost of wastewater treatment, it cannot entirely satisfy the energy demands of our society. Therefore, the production of

high-value chemicals from organic material in wastewater might be more feasible than bioenergy production. Food processing wastes can become inexpensive raw materials for integrated fermentation processes. High-carbohydrate wastewaters that are unsuitable for animal or human feeding are particularly appropriate for conversion to valuable products in co-culture or mixed culture processes. It is the cost efficiency of the bioconversion process that ultimately determines whether a specific waste stream is suitable for production of a given product.

Lactic acid fermentation has been proposed mainly as a bioconversion system for development of biobased chemicals from food and agricultural wastes. Lactic acid produced through lactic acid fermentation is polymerized from poly acetate, which is used as a plastic. Lactic acid and ethanol is esterified to produce ethyl acetate, which is used as a biodegradable solvent (Ohara, 2003). Polyhydroxyalkanoates (PHAs) have potential use as a biodegradable alternative to the petroleum-based synthetic plastics, such as polypropylene (PP) and polyethylene (PE). Much effort has been put into the production of PHAs by microbial fermentation from organic matter in agricultural and industrial wastes because producing the biodegradable thermoplastics from pollutants can provide multiple benefits to the environment and contribute to sustainable development (Aldor and Keasling, 2003; Park *et al.*, 2002). Examples of biochemicals that are obtained via fermentation of organic material in food wastes are shown in Table 23.6. Yang and Silva (1994) have a good review of useful chemical products that can be fermented from whey using various microorganisms.

**Table 23.6** Some Advantages and Disadvantages of Immobilized Cells used in Wastewater Treatment

Advantages	Disadvantages
Continuous reactor operation	Diffusion problems due to high cell density
No washout of biomass	Cell physiology changes may affect productivity
Simple separation of biomass and liquid	
Cells reused many times	Beads can overgrowth by other microbes
Comparatively long operational life	Cost of immobilization can be high when using artificially captured systems
Control of settlement problems (e.g. bulking)	
Microbes performing different reactions can be easily spatially separated	Possible loss of bead stability with time
Small reactor volumes possible because of high cell concentration	
Immobilized cells are very stable	
Increased plasmid stability	
Higher productivity per unit volume	
Immobilized microbes are protected from environmental stress and toxicity	

## 7.5 Single-Cell Protein and Biomass

The link between biomass for food production and wastewater treatment arose from two particular observations. First, large crops of protein-rich algae grow on oxidation ponds and second, the conversion of waste from various food processing industries to yeast resulted in the purification of the wastewater as well as the production of a useful byproduct. These kinds of observations led to the development of numerous schemes for the utilization of wastewater as substrates for the production of biomass or single-cell protein, and at the same time purifying the effluent (Samuelov, 1983).

Single-cell protein (SCP) is microbial biomass produced by some form of fermentation process and can be used as food or food additive. In its simplest form, a suitable organism, such as yeast, is cultured in a suitable substrate, normally carbohydrate, such as molasses solution. The yeast or biomass is recovered from the fermentation by filtration, and then washed and dried to produce a free-flowing powder, rich in protein. The SCP is cheap to produce, versatile, and depending on its quality, can be used for either animal or human consumption. Its most promising applications are for animal feed, although it is widely used in fortifying poor diets and adding flavor and protein to processed foods (Chen *et al.*, 2000).

Various groups of microorganisms have been used for the production of SCP, including bacteria, yeasts, fungi, and algae from food processing wastes as substrates. Single-cell protein from cultivated biomass is now widely used as a protein supplement replacing costly conventional sources of protein such as fish meal or soya meal. The current status and developments of SCP are reviewed by Anupama and Ravindra (2000).

## 7.6 Immobilized Cells

Immobilized cells for wastewater treatment provide compact, specialized, bioreactors ensuring high biomass concentration without the risk of biomass loss. Immobilization is mainly by entrapment in polymeric materials such as agar, agarose, alginate, carrageenan, cellulose, chitosan, collagen, polyacrylamide, polyurethane, and polyvinyl alcohol (PVA). Natural algal polysaccharides have been widely studied for use as an immobilization entrapment medium (Lennen *et al.*, 1996).

Immobilized cells have been used in a wide variety of food and agricultural wastewater treatment and pollution control applications (Casidy *et al.*, 1996). The advantage and disadvantages of immobilized cells are summarized in Table 23.7.

## 8. CONCLUSIONS

As the principles of the various processes are understood and the wastewater has been characterized, the most appropriate process can be selected (Table 23.8). Lettinga and

**Table 23.7** Chemicals Production from Food Industry Waste Streams by Different Microorganisms

Chemicals	Waste Stream	Function	Organisms	References
Lactic acid	Food	Bioplastic	<i>Lactobacillus delbrueckii</i>	Kim <i>et al.</i> (2003)
Polyhydroxyalkanoates	Food	Bioplastic	<i>Ralstonia eutropha</i>	Du and Yu (2002)
Poly-3-hydroxybutyrate	Whey	Bioplastic	Recombinant <i>E.coli</i>	Park <i>et al.</i> (2002)
Lipase	Corn steep liquor	Enzyme	<i>Galactomyces geotrichum</i>	Burkert <i>et al.</i> (2004)
Protease	Whey	Enzyme	<i>Mucor</i> spp.	Tubesha and Al-Delaimy (2003)
Xylitol	Sugar cane bagasse	Sweetner	<i>Geotrichum Guilliermondii</i>	Carvalho <i>et al.</i> (2002)
Biomass protein Jin <i>et al.</i> (1999)	Starch	processing	Feed	<i>Rhizopus</i> sp.
<i>Monascus</i> Pigment	Gluten free effluent	Dye	<i>Monascus purpureus</i>	Dominguez-Espinosa and Webb (2003)
Acetic acid Collet <i>et al.</i> (2003)	Milk	permeate	Deicing salt	<i>Clostridium Thermolacticum</i> plus <i>Moorella</i>
Citric acid	Orange wastes	Preservative	<i>Aspergillus niger</i>	Aravantinos-Zafris <i>et al.</i> (1994)
Chitin	Shrimp wastes	Functional additive	<i>Lactobacillus plantarum</i>	Rao <i>et al.</i> (2000)
Nisin, Pediocin Guerra and Pastrana (2002)	Mussel-	processing	Antibacterials	<i>Lactococcus lactis</i> <i>Pediococcus acidilactici</i>
Vitamin B12	Acid whey	Dietary source	<i>Propionibacterium</i> sp.	Yang and Silva (1994)

Hulshoff-Pol (1991) have listed criteria to select proper treatment for any given wastewater. The criteria for environmental protection technologies and methodologies are:

- They should lead to prevention of the production of additional wastewater(s), or at least a sharp reduction.
- They should not require any dilution of the pollutants with clean water.
- They should provide a high efficiency with respect to environmental pollution control.
- They should lead to maximum recovery and reuse of polluting substances (e.g. to integrated systems), particularly from food processing wastewaters.

**Table 23.8** Applicability of Treatment Technology for Various Contaminants from Food Processing and Agricultural Wastes (Mulligan, 2002)

Technology	Contaminant Type				
	Inorganic	Organic	Dissolved	Suspended	Biological
Biological	×	×	×	×	×
Carbon adsorption	×	×	×		
Centrifugal separation				×	
Chemical oxidation	×	×	×		
Crystallization	×	×	×		
Electrolysis	×		×		×
Evaporation	×	×	×		
Filtration	×	×		×	×
Flotation	×	×		×	
Gravity separation	×	×		×	×
Ion exchange	×	×	×		
Membrane separation	×		×	×	×
Precipitation	×	×	×	×	
Solidification	×	×	×	×	
Solvent extraction	×	×	×		
Stripping	×	×	×		
Thermal treatment		×	×	×	×

- They should be low cost, both with respect to construction, required infrastructure (including energy requirement), and operation and maintenance.
- They should be applicable at small as well as large scale.
- They should lead to a high self-sufficiency in all respects.
- They should be well acceptable for the local population.
- The method should provide sufficient treatment efficiency for removal of various categories of pollutants, such as biodegradable organic matter, suspended solids, ammonia, organic-N compounds, phosphates, and pathogens.
- The system should be stable for interruptions in power supply, peak loads, feed interruptions, and/or for avoiding toxic pollutants.
- The process should be flexible with respect to future extensions and possibilities to improve the efficiency.
- The system should be simple to operate, maintain, and control, so that good performance does not depend on the continuous presence of highly skilled operators and engineers.
- Land requirements should be low, especially when little land is available and/or the price of the land is high.
- The number of process steps should be as low as possible.
- The lifetime of the system should be long.

- The system should not suffer from serious sludge disposal problems.
- The application of the system should not be accompanied with malodor or other nuisance problems.
- The system should offer good possibilities for recovery of useful byproducts, such as for irrigation or fertilization.
- There should be sufficient experience with the system to manage it easily.

Based on the criteria above and [Table 23.8](#), biological treatment technology is regarded as an effective method for the treatment of most wastewaters.

As summarized in [Table 23.4](#), the anaerobic treatment processes is often considered the best environmental protection and resource recovery concept for treating food processing wastes compared to other biological processes. On an energy basis, even though aerobic bacteria can extract 14 times more energy from a sugar substrate than aerobic bacteria, the aerobes use much of the energy to produce sludge, which often becomes a disposal problem. The chemical energy is transformed by anaerobic bacteria into methane, a good fuel. The gaseous products from anaerobic processes can be used to produce heat and electricity. Anaerobes do not require oxygen, thus reducing operational costs. In terms of treatment efficiency, there is little difference in the biodegradability of many wastewaters by aerobic and anaerobic means, and the overall removal is about the same, particularly for high strength wastes. Anaerobic systems are usually used for the wastes from food processing industries where toxicity is not a problem.

The development of new bioreactors is one reason why anaerobic treatment technologies will probably gain in popularity. Organic loadings rates (OLR) of well over 20 kg COD/m<sup>3</sup>/day (g COD/l/d) are possible for some types of food processing wastes in a modern high-rate anaerobic digester. High loading rates result in relatively low hydraulic retention times, which reduces capital costs because vessels holding the waste are smaller. Anaerobic digestion shows promise to produce hydrogen, a high-value fuel, during the treatment of wastewaters. Anaerobic hydrogen fermentation would use similar hardware to that used currently in methane fermentation. Useful biochemical products might soon be produced from food wastewaters as an economical choice.

## REFERENCES

- Aldor, I.S., Keasling, J.D., 2003. Process design for microbial plastic factories: metabolic engineering of polyhydroxyalkanoates. *Curr. Opin. Biotech.* 14, 475–483.
- Anupama, A., Ravindra, P., 2000. Value-added food: single cell protein. *Biotech. Adv.* 18 (6), 459–479.
- Aravantinos-Zafiris, G., Tzia, C., Oreopoulou, V., Thomopoulos, C.D., 1994. Fermentation of orange processing wastes for citric acid production. *J. Sci. Food. Agri.* 65, 117–120.
- Arora, M.L., 1985. Technology evaluation of sequencing batch reactors. *J. Water Pollut. Control Fed.* 57 (8), 867–875.

- Bagchi, A., 1994. Design, Construction, and Monitoring of a Sanitary Land Fills. John Wiley and Sons, New York.
- Balch, W.E., Fox, G.E., Magrm, L.J., Woese, C.R., Wolfe, R.S., 1979. Methanogens: re-evaluation of a unique biological group. *Microbiol. Rev.* 43 (2), 260–296.
- Barlaz, M.A., Ham, R.K., 1990. Methane production from municipal refuse: a review of enhancement techniques and microbial dynamics. *Crit. Rev. Environ. Con.* 19 (6), 557–584.
- Benemann, J.R., 1996. Hydrogen biotechnology: progress and prospects. *Nature Biotech.* 14, 1101–1103.
- Bintsis, T., Litopoulou-Tzanaetaki, E., Robinson, R.K., 2000. Existing and potential applications of ultraviolet light in the food industry—a critical review. *J. Sci. Food. Agric.* 80, 637–645.
- Burkert, J.F., Maldonado, R.R., Filho, F.M., Rodrigues, M.L., 2004. Comparison of lipase production by *Geotrichum candidum* in stirring and airlift fermenters. *Biotech. Bioeng.* 80 (1), 61–67.
- Caballero, J.A., Font, R., Marcilla, A., Conesa, J.A., 1997. Characterization of sewage sludges by primary and secondary pyrolysis. *J. Anal. Appl. Pyrol.* 40–41, 433–450.
- Carawan, R.E., Chambers, J.V., Zall, R.R., 1979. Water and Wastewater Management in Food Processing–Seafood Water and Wastewater Management. North Carolina Agricultural Extension Service, Raleigh, NC.
- Carvalho, W., Silva, S.S., Converti, A., Vitolo, M., 2002. Metabolic behavior of immobilized *Candida guilliermondii* cells during batch xylitol production from sugarcane bagasse acid hydrolyzate. *Biotechnol. Bioeng.* 79 (2), 165–169.
- Casidy, M.B., Lee, H., Trevors, J.T., 1996. Environmental applications of immobilized cells: a review. *J. Ind. Microbiol.* 16, 79–101.
- Chandrakant, P., Bisaria, V.S., 1998. Simultaneous bioconversion of cellulose and hemicellulose to ethanol. *Crit. Rev. Biotech.* 18, 295–331.
- Chen, C.C., Lin, C.Y., Chang, J.S., 2001. Kinetics of hydrogen production with continuous anaerobic cultures utilizing sucrose as the limiting substrate. *Appl. Microbiol. Biotech.* 57, 56–64.
- Chen, L.C., Carbonell, R.G., Serad, G.A., 2000. Recovery proteins and other biological compounds from food processing wastewaters using fibrous materials and polyelectrolytes. *Water Res.* 34, 510–518.
- Cheong, D.-Y., Hansen, C.L., 2006. Bacterial stress enrichment enhances anaerobic hydrogen production in cattle manure sludge. *Appl. Microbiol. Biotech.*
- Cheremisinoff, N.P., 1993. Filtration Equipment for Wastewater Treatment. Prentice Hall, Englewood Cliffs, NJ.
- Chung, I.S., Lee, Y.Y., 1984. Ethanol fermentation of crude acid hydrolyzate of cellulose using high-level yeast inocula. *Biotech. Bioeng.* 27, 308–315.
- Clarke, W.P., 2000. Cost-benefit analysis of introducing technology to rapidly degrade municipal solids waste. *Waste Mgmt. Res.* 18, 510–524.
- Collet, C., Schwitzgubel, J.P., Peringer, P., 2003. Improvement of acetate production from lactose by growing clostridium thermolacticum in mixed culture. *J. Appl. Microbiol.* 95, 824–831.
- Dague, R.R., Haben, C.E., Pidaparti, S.R., 1992. Initial studies on the anaerobic sequencing batch reactor. *Water Sci. Tech.* 26, 2429–2432.
- Das, D., Veziroglu, R.N., 2001. Hydrogen production by biological processes: a survey of literature. *Int. J. Hydrogen Ener.* 26, 13–28.
- Dominguez-Espinosa, R.M., Webb, C., 2003. Production of monascus pigments in wheat based substrates. *World J. Microbiol. Biotech.* 19, 329–336.
- Du, G., Yu, J., 2002. Green technology for conversion of food scrape to biodegradable thermoplastic polyhydroxyalkanoate. *Environ. Sci. Tech.* 36, 5511–5516.
- Eckenfelder Jr., W.W., 1961. Biological Waste Treatment. Pergamon Press, Oxford.
- Epstein, E., 1997. The Science of Composting. Technomic Publishing Company, Lancaster, Pa.
- Faust, S.D., Aly, O.M., 1987. Adsorption Processes for Water Treatment. Butterworth Publisher, Toronto.
- Flick, E.W., 1991. Water Treatment Chemicals: An Industrial Guide. Noyes Publication, Park Ridge, NJ.
- Gosta, B., 1999. Dairy Processing Hand Book. Tetra Pak Processing System, Lum, Sweden.



- Grady, C.P., Daigger, L.G., Lim., H.C., 1999. *Biological Wastewater Treatment*. Marcel Dekker, New York.
- Guerra, N.P., Pastrana, L., 2002. Nisin and pediocin production on mussel-processing waste supplemented with glucose and five nitrogen sources. *Lett. Appl. Microbiol.* 34, 114–118.
- Guibai, L., Gregory, J., 1991. Flocculation and sedimentation of high-turbidity waters. *Water Res.* 25 (9), 1137–1143.
- Guillen-Jimenez, E., Alvarez-Mateos, P., Romero-Guzman, F., Pereda-Marin, J., 2000. Biomineralization of organic matter in dairy wastewater, as affected by pH. The evolution of ammonia and phosphates. *Water Res.* 37, 1454–1463.
- Hansen, C.L., Hansen, C.S., 2005. Induced sludge bed anaerobic reactor. U.S. Patent #6,911,149.
- Hansen, C.L., Hwang, S., 2003. Waste treatment. In: Mattsson, B., Sonersson, U. (Eds.), *Environmentally Friendly Food Processing*. Woodhead, Cambridge, pp. 218–240.
- Hansen, C.L., Wrigley, R.J., 1997. Dairy processing waste management in Australia. In: *Proceedings of the International Congress on Engineering and Food 7*. Lewis Publishers, Boca Raton, FL.
- Hansen, C.L., White, R.K., Okos, M., 1984. Optimization of water management and associated energy in a meat packing plant. *Trans. Am. Soc. of Ag. Engr.* 27 (1), 305–319.
- Hansen, C.S., Hansen, C.L., 2002. Demonstration of dairy manure remediation using IBR technology. In: *Proceedings of the Application of Waste Remediation Technologies to Agricultural Contamination of Water Resources Conference*, 166–172, Kansas State University, Manhattan, K. Also found at: <[http://www.engg.ksu.edu/HSRC/ag/2002/abstracts/13Hansen.pdf](http://www.engg.ksu.edu/HSRC/ag/2002/proceed/j01.pdf)>.
- Harper, S.R., Pohland, F.G., 1986. Recent developments in hydrogen management during anaerobic biological wastewater treatment. *Biotech. Bioeng.* 28, 585–602.
- Harper, W.J., 1974. In-plant control of dairy wastes. *Food Tech.* June, 50–52.
- Haug, R.T., 1993. *Compost Engineering*. Lewis Publishers, Raton, FL.
- Horan, N.J., 1990. *Biological Wastewater Treatment Systems*. John Wiley and Sons, New York.
- Hulshoff-Pol, L.W., Lettinga, G., 1986. New technologies for anaerobic wastewater treatment. *Water Sci. Tech.* 18, 41–49.
- Jenkins, D., Hermanowicz, S.W., 1991. *Principles of Chemical Phosphate Removal in the Phosphorous and Nitrogen Removal from Municipal Wastewater*, second ed. Lewis Publishers, Chelsea, Mich.
- Jin, B., van Leeuwen, J., Yu, Q., Patel, B., 1999. Screening and selection of microfungi for microbial biomass protein production and water reclamation from starch processing wastewater. *J. Chem. Tech. Biotech.* 74 (2), 106–110.
- Jones, H.J., 1994. *Waste Disposal Control in the Fruit and Vegetable Industry*. Noyes Data Corporation, London.
- Kim, J.-G., Yousef, A.E., Dave, S., 1999. Application of ozone for enhancing the microbiological safety and quality of foods: a review. *J. Food Prot.* 62 (9), 1071–1087.
- Kim, K.I., Kim, W.K., Seo, D.K., Yoo, I.S., Kim, E.K., Yoon, H.E., 2003. Production of lactic acid from food wastes. *Appl. Biochem. Biotech.* 105, 637–647.
- Lay, J.J., Lee, Y.J., Noike, T., 1999. Feasibility of biological hydrogen production from organic fraction of municipal solid waste. *Water Res.* 33, 2579–2586.
- Lee, Y.J., Miyahara, T., Noike, T., 2002. Effect of pH on microbial hydrogen fermentation. *J. Chem. Tech. Biotech.* 77, 694–698.
- Lennen, E.V., Santos, D., Grolle, E., Tramper, J., Wijffels, R., 1996. Characteristics of and selection criteria for support materials for cell immobilization in wastewater treatment. *Water Res.* 30, 2985–2996.
- Letterman, R.D., Quon, J.E., Gemmill, R.S., 1988. Influence of rapid-mix parameters on flocculation. *J. Amer. Water Works Assoc.* 65 (11), 716–722.
- Lettinga, G., 1995. Anaerobic digestion and wastewater treatment systems. *Antonie Van Leeuwenhoek* 67, 3–28.
- Lettinga, G., Hulshoff-Pol, L.W., 1991. Application of modern high anaerobic treatment processes for wastewater treatment. In: Turkman, A., Uslu, O. (Eds.), *New Developments in Industrial Wastewater Treatment*. Kluwer Academic Publishers, Netherlands, pp. 33–64.

- Levin, D., Pitt, L., Love, M., 2004. Biohydrogen production: prospectus and limitations to practical application. *Int. J. Hydrogen Ener.* 29, 173–185.
- Loehr, R.C., Jewell, W.J., Novak, J.D., Clarkson, W.W., Freidman, G.S., 1979a. Land Application of Wastes, 1. Van Nostrand Reinhold, New York.
- Loehr, R.C., Jewell, W.J., Novak, J.D., Clarkson, W.W., Freidman, G.S., 1979b. Land Application of Wastes, 2. Van Nostrand Reinhold, New York.
- Mata-Alvarez, J., Mace, S., 2002. Biomass as source of energy. In: Grover, V.I., Grover, V.K., Hogland, W. (Eds.), *Recovering Energy from Waste*. Science Publishers, Enfield, NH, pp. 33–48.
- McCarty, P.L., Smith, D.P., 1986. Anaerobic wastewater treatment. *Environ. Sci. Tech.* 20 (12), 1200–1206.
- McFarland, M.J., 2001. *Biosolids Engineering*. McGraw-Hill, New York.
- McNeil, K.E., 1984. The treatment of wastes from the sugar industry. In: Barnes, D., Forster, C.F., Hurdey, S.E. (Eds.), *Food and Allied Industries*. Pitman, London, pp. 1–68.
- Metcalf, Eddy, 1991. *Wastewater engineering: treatment*. In: Tchobanoglous, G., Burton, F.L. (Eds.), *Disposal and Reuse*, third ed. McGraw-Hill, New York.
- Mulligan, E.N., 2002. *Environmental Biotreatment: Technologies for Air, Water, Soil, and Wastes*. ABS Consulting, Rockville, Md.
- Nandi, S., Sengupta, S., 1998. Microbial production of hydrogen: an overview. *Crit. Rev. Microbiol.* 24, 61–84.
- Nemerow, N.J., Agardy, F.J., 1998. *Strategies of Industrial and Hazardous Waste Management*. Van Nostrand Reinhold, New York.
- Nemerow, N.L., 1978. *Industrial Water Pollution*. Addison-Wesley, Massachusetts.
- Novaes, R.E.V., 1986. Microbiology of anaerobic digestion. *Water Sci. Tech.* 12, 1–14.
- Ochieng, A., Ogada, T., Sisenda, W., Wambua, P., 2002. Brewery wastewater treatment in a fluidized bed bioreactor. *J. Hazard. Mater.* 90, 311–318.
- Ockerman, H.W., Hansen, C.L., 2000. *Animal By-product Processing and Utilization*. Technomic, Lancaster, Pa.
- Ohara, H., 2003. Biorefinery. *Appl. Microbiol. Biotech.* 62, 474–477.
- Orhon, D., Gorgun, E., Germirli, F., Artan, N., 1993. Biological treatability of dairy wastewater. *Water Res.* 27 (4), 625–633.
- Park, S.J., Park, J.P., Lee, S.Y., 2002. Production of poly-3-hydroxybutyrate from whey by fed-batch culture of recombinant *Escherichia coli* in a pilot-scale fermenter. *Biotech. Lett.* 24 (3), 185–189.
- Parkin, G.F., Owen, W.F., 1986. Fundamentals of anaerobic digestion of wastewater sludges. *J. Environ. Eng.* 112 (5), 867–920.
- Petrucchioli, M., Duarte, J.C., Eusebio, A., Federici, F., 2002. Aerobic treatment of winery wastewater using a jet-loop activated sludge reactor. *Proc. Biochem.* 37, 821–826.
- Pohland, F.G., Kim, J.C., 2000. Microbiologically mediated attenuation potential of landfill bioreactor systems. *Water Sci. Tech.* 41 (3), 247–254.
- Rao, M.S.J., Munoz, J., Stevens, W.F., 2000. Critical factors in chitin production by fermentation of shrimp biowaste. *Appl. Microbiol. Biotech.* 54, 808–813.
- Reed, S.C., Crites, R.W., 1984. *Handbook of Land Treatment Systems for Industrial and Municipal Wastes*. Noyes Publications, Park Ridge, NJ.
- Rhyner, C.R., Schwartz, L.J., Wenger, R.B., Kohrell, M.G., 1995. *Waste Management and Resource Recovery*. Lewis publishers, New York.
- Rittmann, B.E., McCarty, P.L., 2001. *Environmental Biotechnology: Principles and Applications*. McGraw-Hill, New York.
- Saham, H., 1984. Anaerobic wastewater treatment. *Adv. Biochem. Eng. Biotech.* 29, 84–115.
- Samuelov, N.S., 1983. Single-cell protein production: review of alternatives. In: Mizrahi, I.A., van Wezel, A.L. (Eds.), *Advance in Biochemical Processes*, 1. Wiley-Liss, New York, pp. 293–335.
- Shore, M., Dutton, J.V., Broughton, N.W., Bumstead, N., 1984. Anaerobic treatment of wastewaters in the sugar beet industry. *Water Poll. Con.* 83, 499–506.
- Singer, P.C., 1990. Assessing ozone research needs in water treatment. *J. Amer. Water Works Assoc.* 82 (10), 78–88.
- Speece, R.E., 1996. *Anaerobic Biotechnology for Industrial Wastewaters*. Archae Press, Nashville, TN.

- Steihelin, J., Hoigne, J., 1985. Decomposition of ozone in water in the presence of organic solutes acting as promoters and inhibitors of radical chain reactions. *Environ. Sci. Tech.* 19, 1206–1213.
- Stolarek, P., Ledakowicz, S., 2001. Thermal processing of sewage sludge by drying, pyrolysis, gasification, and combustion. *Water Sci. Tech.* 44 (10), 333–339.
- Stover, E.L., Jarnis, R.W., 1981. Obtaining high-level wastewater disinfection with ozone. *J. Water Pollut. Control Fed.* 53, 1637–1647.
- Stumm, W., Huper, H., Champlin, R.L., 1967. Formulation of polysilicates as determined by coagulation effects. *Environ. Sci. Tech.* 1 (3), 221–227.
- Sung, S., Dague, R.R., 1995. Laboratory studies on the anaerobic sequencing batch reactor. *Water Environ. Res.* 67 (3), 294–301.
- Tubehsa, Z.A., Al-Delaimy, K.S., 2003. Remain-like milk coagulant enzyme produced by a local isolate. *Mucor. Int. J. Dairy Tech.* 56, 237–241.
- US Environmental Protection Agency. 1971. Dairy Food Plant Wastes and Waste Treatment Practices: Water Pollution Control Series. Washington, DC.
- Van Ginkel, S., Sung, S., Lay, J.-J., 2001. Biohydrogen production as a function of pH and substrate concentration. *Environ. Sci. Tech.* 35, 4726–4730.
- Wei, C.I., Cook, D.L., Kirk, J.R., 1985. Use of chlorine compounds in the food industry. *Food Tech.* 39, 107–115.
- Weiland, P., Rozzi, A., 1991. The start-up, operation, and monitoring of high-rate anaerobic treatment system: discussion report. *Water Sci. Tech.* 24, 257–277.
- White, G.C., 1992. *Handbook of Chlorination and Alternative Disinfectants*, third ed. Van Nostrand Reinhold, Toronto.
- Yang, S.T., Silva, E.M., 1994. Novel products and new technologies for use of a familiar carbohydrate, milk lactose. *J. Dairy Sci.* 78 (11), 2541–2562.
- Zaldivar, J., Nielsen, J., Olsson, L., 2001. Fuel ethanol production from lignocellulose: a challenge for metabolic engineering and process and process integration. *Appl. Microbiol. Biotechnol.* 56, 17–34.
- Zeikus, J.G., 1977. The biology of methanogenic bacteria. *Bact. Rev.* 41 (2), 514–541.
- Zhang, R.H., Yin, Y., Sung, S., Dague, R.R., 1997. Anaerobic treatment of swine waste by the anaerobic sequencing batch reactor. *Trans. ASAE.* 40, 761–767.

## FURTHER READING

- Danalewich, J.R., Papagiannis, T.G., Belyea, R.L., 1998. Characterization of dairy waste streams, current treatment practices, and potential for biological nutrient removal. *Water Res.* 32 (12), 3555–3568.
- Environmental Protection Agency, 1977. *Pollution Abatement in the Fruit and Vegetable Industry*, EPA-625/3-77-0007. USEPA Technology Transfer, Washington, DC.
- Hwang, S., 1995. *Bioprocess Models to Control Production of Short-Chain Organic Acids from Cheese-Processing Wastewater*. Ph.D. Thesis. Logan, Utah: Utah State University.

# Food Packaging Machinery

**Harold A. Hughes**

Michigan State University, MI, USA

## 1. INTRODUCTION

Packaging is an essential activity in the food industry. Virtually every food product is packaged one or more times before it reaches the ultimate consumer. Packages are used at each stage in the process of production and distribution of food products: from farms to processing plants, between processing plants, from processing plants to warehouses to retail outlets, and from retail outlets to consumers. A package can hold a food product, several food products, or packages of food products. There are many package forms, including wraps, pouches, bags, boxes, cups, trays, cans, tubes, and bottles.

Packages perform one or more of the following four basic functions: containment, protection, communication, and utility. Each function is discussed briefly in the following sections.

### 1.1 Containment

Many food products, especially liquids and free flowing solids are contained in packages to facilitate convenient handling and to avoid spillage and loss of the product. Table salt and granulated sugar are examples of free flowing solids. Liquid food products include water, milk, fruit juices, and a wide assortment of other products.

### 1.2 Protection

Food products must be protected against contamination by microorganisms and a wide array of other hazards. Depending on the characteristics of the product and other factors, it may be necessary to provide protection from gain or loss of moisture, oxygen, CO<sub>2</sub>, and other constituents from crushing and other distribution damage, from improper temperature, from light, from tampering and theft, and from numerous other hazards.

### 1.3 Communication

Every package communicates information. The communication may be simple and straightforward, such as a label listing the contents and showing the source and destination. However, most retail food packages include expensive and elaborate multicolored labels, bar codes, and radio frequency tags. Every retail food package must include a nutritional label.

### 1.4 Utility

Some packages and package components are designed to add value to the packaged product. Spouts shakers and similar fitments enable the consumer to apply spices, salt, and similar materials more easily and accurately. Printed directions add convenience. Handles enable small children to handle large packages conveniently and safely.

The modern food production and distribution system could not function without packaging. Even fresh food, such as bananas, oranges, tomatoes, and lettuce is packaged for transport from the store to the consumer's residence. The packages may be made of corrugated board, mesh bags, paper bags, or plastic containers. A large percentage of the fresh products are packaged by hand.

However, unlike the fresh products mentioned above, most modern food products are prepared or processed in factories and then packaged for distribution to warehouses and stores and ultimately to consumer residences. Most of the packaging is done by machines set up into systems. The packaging equipment often receives the prepared product from an adjacent preparation area. Four example production and packaging systems are described in [Table 24.1](#).

The descriptions illustrate two important principles about packaging machines. The first is that packaging machines are generally set up as a system. It is unusual for a packaging operation to have only one machine. Rather, there is nearly always a series of machines. For example, the milk system generally includes a filler, a capper, a labeler, and other machines. The packages go down the packaging line, moving from machine to machine as different operations are performed.

The second principle is that there are almost always options in the way that a particular operation can be performed. The options may be provided by different machines. Alternatively, there may be a choice to not use a machine. For example, in the candy packaging system, the individual pieces of candy could be placed into the carton by a robot or by people working with their hands.

The next portion of this chapter will discuss some of the different types of packaging machines that are available, including machine capacity, operating principles, and other characteristics. The discussion will start with filling machines.

**Table 24.1** Description of Some Typical Food Packaging Systems

<b>Product</b>	<b>Steps in the Preparation/Packaging System</b>
Milk in one gallon plastic jugs	<ol style="list-style-type: none"><li>1. Milk is received at the plant, filtered, processed as necessary, and stored in large stainless steel tanks</li><li>2. Plastic jugs are manufactured on site by blow molders and placed into temporary storage</li><li>3. The jugs and the milk are conveyed to a filling machine, which meters one gallon of milk into each container</li><li>4. The filled jugs are capped, washed, and labeled</li><li>5. The completed gallon packages of milk are placed into plastic crates for handling</li><li>6. The crates are stacked and conveyed to a refrigerated temporary holding area</li></ol>
Soup in metal cans	<ol style="list-style-type: none"><li>1. The constituents for the soup are delivered to the plant</li><li>2. The metal cans, labels, and other packaging components are delivered to the plant</li><li>3. The soup is prepared and conveyed to the packaging line</li><li>4. The cans are depalletized and conveyed into the packaging line</li><li>5. The cans are cleaned as necessary</li><li>6. Empty cans and the soup are conveyed to a filling machine and the soup is metered into the cans</li><li>7. The can end is applied</li><li>8. The filled cans are retorted</li><li>9. Labels are applied to the cans</li><li>10. Completed cans are packed into corrugated trays</li><li>11. The filled trays are wrapped with shrink-wrap and palletized</li></ol>
Granulated sugar in multiwall paper bags	<ol style="list-style-type: none"><li>1. Sugar is extracted from sugar cane or sugar beets and transported to a temporary holding area</li><li>2. Preprinted, multiwall paper bags and rolls of heavy Kraft paper are delivered to the plant</li><li>3. Empty bags are held open by the filling machine and the specified weight of sugar is metered into the bag</li><li>4. The top of the bag is rolled over, crimped, and glued shut</li><li>5. Bags of sugar are bundled together and wrapped in Kraft paper</li><li>6. The bundles of sugar are palletized and moved to a warehouse</li></ol>
Assorted chocolates in paperboard cartons	<ol style="list-style-type: none"><li>1. Decorated paperboard cartons, plastic trays, plastic overwrap, corrugated shipping containers, labels, and other packaging components are delivered to the plant</li><li>2. Chocolates are manufactured and placed into temporary holding locations in the packaging area</li><li>3. Empty cartons are conveyed past the filling station where a robot picks up individual pieces of chocolate and places them into particular locations in a thermoformed plastic tray</li><li>4. Filled trays are placed into cartons</li><li>5. A lid is placed on the cartons</li><li>6. Completed cartons are wrapped in plastic film</li><li>7. Wrapped cartons are placed into the shipping containers, which are closed, taped, labeled, and palletized</li><li>8. The loaded pallets are moved to a warehouse for temporary storage</li></ol>

## 2. FILLING MACHINES

The filling machine is usually the most important machine in a food packaging line. The filler performs two critical functions. It measures out a specific quantity of a food product and places that metered quantity of food into a package. The machine may also perform other functions, such as making the package and closing the package. Most fillers can be set up to work on many different products. For example, a machine that is used to meter water into 12 oz. plastic bottles could also be used to meter one quart of motor oil into different plastic bottles or two quarts of milk into paperboard, gable topped cartons. However, as this chapter addresses only food products, motor oil and other non-food products will be ignored. Filling machines used in food systems measure out a quantity of product by volume or weight.

## 3. VOLUMETRIC FILLERS

Volumetric fillers deliver a measured volume of product into each container. Volumetric systems are flexible and can be adapted to a wide variety of products, ranging from water to thick pastes or powders and other dry products.

Most fillers can be adjusted to deliver a desired quantity of product. A typical unit can be adjusted in a 10-fold range. For example, a particular machine might be adjusted to deliver any volume from 2 fluid ounces to 20 fluid ounces.

### 3.1 Piston Fillers

Piston fillers (Figure 24.1) are the most common type of volumetric filler. Piston fillers measure and deliver the product by the action of a single piston. On the intake stroke, the piston draws product out of a supply tank, through a directional valve, and

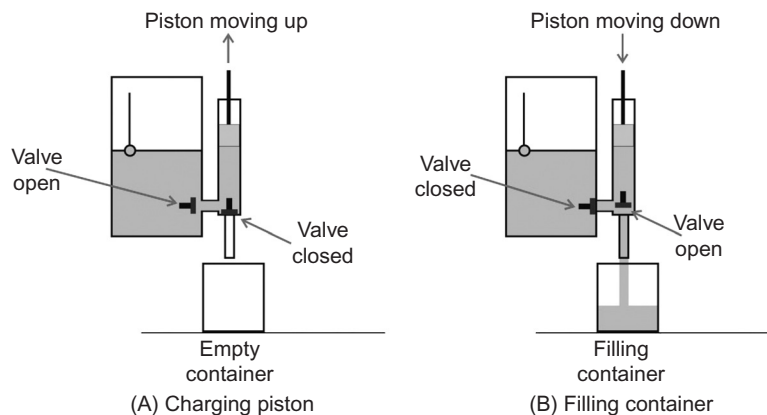


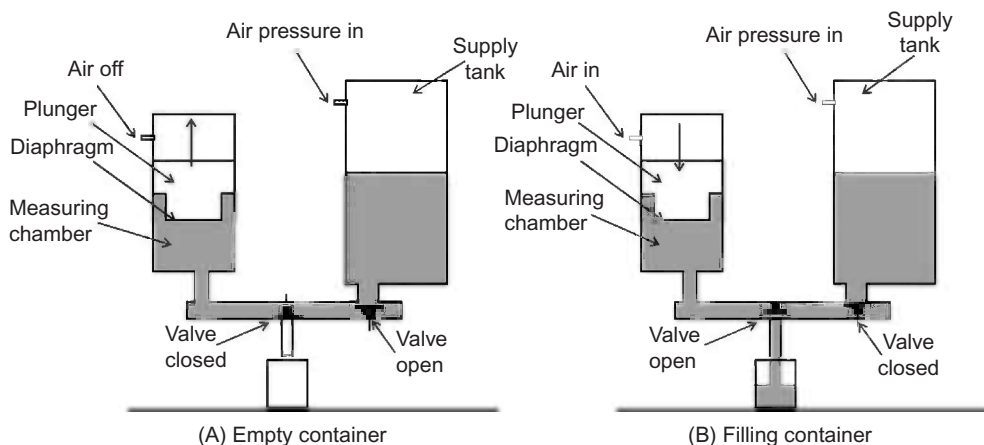
Figure 24.1 *Piston filler operation.*

into the measuring chamber which houses the piston. Then, on the following delivery stroke, the valve leading to the container is opened and the valve leading to the supply chamber is closed causing the product to flow out of the chamber and into the container. The filled container is then conveyed away and replaced by another empty container and the process repeats.

The length of the stroke and the diameter of the chamber determine the volume of product that is metered out. To alter the quantity of product, either the stroke length or the chamber diameter (or both) must be changed. On most machines, the stroke length can be adjusted easily. However, to change chamber diameter, the entire chamber must be removed and replaced, a relatively complex and time consuming operation on most machines and not possible on some machines.

### 3.2 Diaphragm Fillers

Diaphragm fillers (Figure 24.2) are similar in principle to piston fillers. Instead of a rigid piston and cylinder, a diaphragm filler has a flexible diaphragm which can be distorted to adjust its volume. The operation of a diaphragm filler is straightforward. When the cycle starts, the valve at the bottom of the supply tank is opened and the valve to the empty container is closed. Air pressure in the supply tank forces the product out of the tank and into the measuring chamber. The top of the chamber is formed by the diaphragm with the plunger above. As product flows into the chamber, the diaphragm and plunger are lifted. When the plunger reaches a pre-set position, the valves are reversed and air pressure is applied to the top of the plunger, forcing the product out of the chamber and into the container. The filled container is then conveyed away and replaced by another empty container and the process cycle repeats.



**Figure 24.2** *Diaphragm filler operation.*



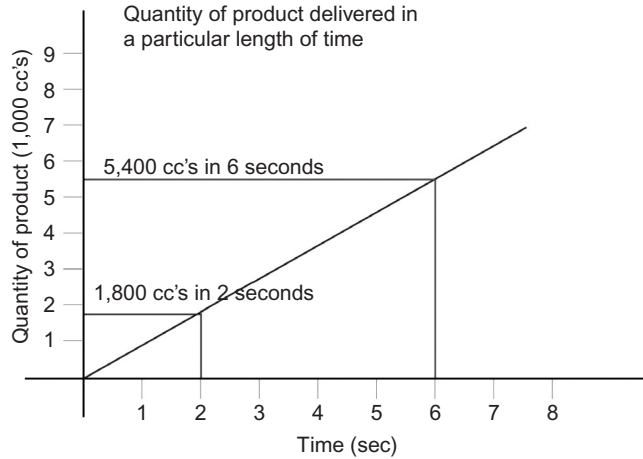


Figure 24.3 *Delivery of product from a timed flow filler.*

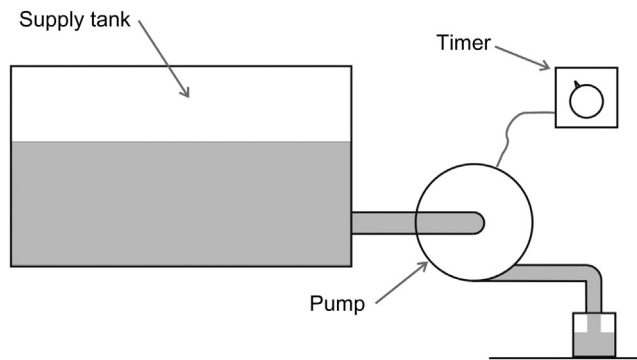
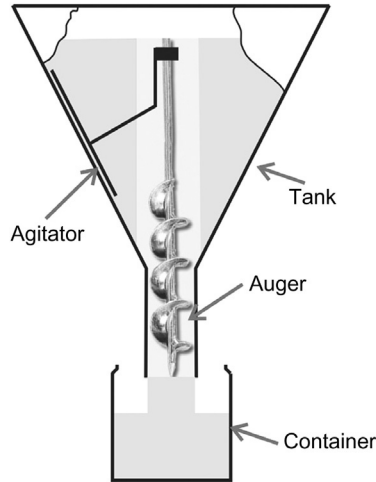


Figure 24.4 *Timed flow equipment arrangement.*

### 3.3 Timed Flow Fillers

If a liquid product flows through a specific size tube at a constant rate, the total quantity of product delivered depends on the length of time that the product flows. For example, if one cup flows through the tube in 1 s, two cups will flow through the tube in 2 s, three cups in 3 s, etc. The accuracy of the metering process depends on smoothness of flow and the precision of the timing mechanism (Figure 24.3). The equipment set includes a supply tank and a pump, along with a timer and various pipes (Figure 24.4). To fill larger containers, the timer setting is increased. To adjust the filling speed, volume/unit of time is increased or decreased.

The fillers that have been discussed so far are mostly intended for use with liquids, such as milk, water, pancake syrup, cooking oil, alcoholic beverages, and other thin liquids. There are equipment variations that enable the machines to be used with thicker products.



**Figure 24.5** Auger filler.

### 3.4 Auger Fillers

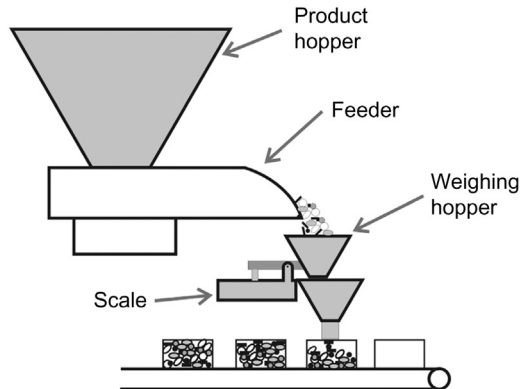
Auger fillers are a widely used type of volumetric filling equipment used for many types of dry products and thick pastes (Figure 24.5). The product is held temporarily in a conical shaped bin and metered and conveyed out through an opening at the bottom by an auger. The auger must be specially designed and manufactured to suit the product. The filler manufacturer or a specialty manufacturer should be contacted to make the augers. The volume of product to be delivered is directly related to the number of degrees that the auger rotates. The control can be based on time, which requires that the speed of rotation be constant, or it can be based on the degrees of rotation. To change the volume of product delivered, the time that the auger rotates can be increased or decreased.

Some powders tend to bridge in the hopper and not flow into the auger. To prevent bridging, manufacturers make various types of agitators that rotate together with the auger. The agitator breaks up the bridged product and keeps the product flowing smoothly to the auger.

If the density of the product is constant, metering a specific volume of product also defines a particular weight of product. Volumetric filling is a good choice for products of this type.

## 4. WEIGHT FILLING

Weight filling is used to meter products that do not have uniform density and for products that require more accurate metering than is possible with volumetric fillers. There are two types of weight filling: gross weight and net weight.



**Figure 24.6** Net weight filler.

### 4.1 Net Weight Fillers

Net weight fillers (Figure 24.6) measure out the desired weight of product and convey the measured product to the container. The metering step is done inside the machine, before the product is introduced into the container. The scale measures only the weight of the product. When the weight of the product in the hopper reaches the pre-set value, the feeder stops and the hopper opens to discharge the product into a funnel which guides the product into the container. After the product has been placed in the container, the filled container is moved away and an empty container is moved in position to be filled.

### 4.2 Gross Weight Fillers

A gross weight filler (Figure 24.8) measures the combined weight of the product and the package. Before the filling operation begins, a sample of packages are weighed individually and the average is calculated. The metering scale is then pre-set with the sum of the desired product weight and the average weight of a container. The product is metered directly into a container until the scale determines that the proper (combined) weight has been reached. At that time, the product flow is terminated, the filled container is moved out and an empty container is moved into position to be filled.

There are several machine arrangements that can be used to improve the accuracy of weight filling equipment. From Figure 24.7, it can be seen that there is some product in the fill tube when the valve closes. This product, of course, still falls into the container after the valve closes. A method of compensating for this product is required or every container will be over-filled. One approach is to set the scale to “under-weight” the container. Another approach is to change the machine design. Simply locating the cutoff valve closer to the container will reduce the amount of product in the fill tube when the valve closes, so the container is filled more accurately.

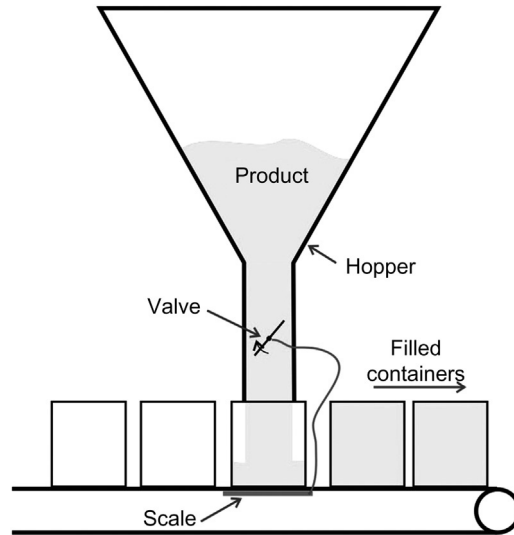


Figure 24.7 *In-line filler.*

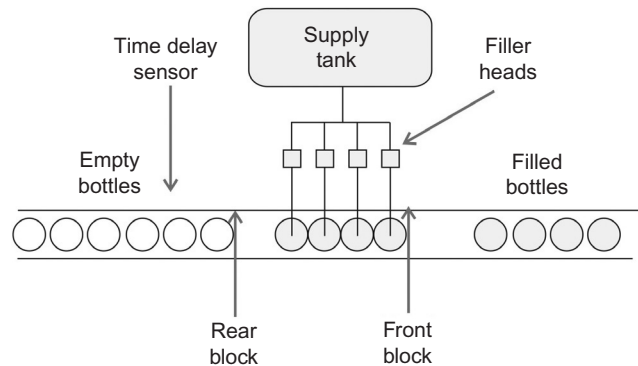


Figure 24.8 *Gross weight filler.*

Gross weight fillers are less complicated and less costly than net weight units. In addition, because the weight of the containers is pre-set into the scale rather than being weighed, as is done by the net weight units, gross weight fillers tend to be less accurate than net weight fillers. Therefore, gross weight equipment tends to be selected for lower value products. In addition, net weight fillers handle the product more times than gross weight fillers. Therefore, gross weight fillers tend to be the more popular choice when brittle or fragile products, such as potato chips, are being packaged.

## 5. IN-LINE OR ROTARY FILLERS

There are two basic arrangements of fillers: in-line and rotary. Each will be described and discussed below.

### 5.1 In-Line Fillers

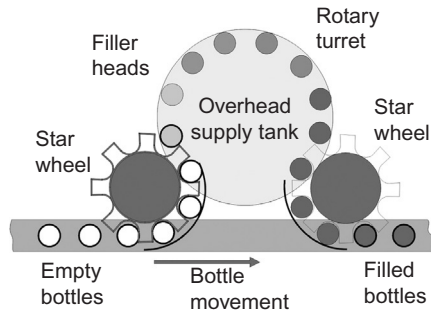
In-line fillers (Figure 24.8) are widely used for filling liquid and paste food products, such as water, beverages, fruit juices, ketchup, mayonnaise, and many other products into metal cans, glass bottles, and other containers. Obviously, an in-line filler must have at least one filling head. Most have six or more heads. An in-line filler, including a short section of conveyor belt, is usually positioned in a packaging line between an in-feed conveyor and an out-feed conveyor. Typically, the conveyors are a little wider than the diameter or width of the containers.

The following description of the operation of an in-line filler refers to the four-head unit shown in Figure 24.8. The filling procedure starts when empty containers are conveyed into the filler in single file by the in-feed conveyor. The containers are held in position by the rear block as shown in Figure 24.8, until the four containers have been filled properly. Then, the filler heads are raised and moved back out of the way, allowing the four newly filled containers to start moving down the line toward the out-feed conveyor. After a time delay (set on the time delay sensor), the rear block is moved back and out of the way, allowing empty containers to start moving into position for filling. After the four filled containers have moved past the front block, the front block is re-positioned to prevent the next set of containers from simply passing through the machine unfilled. After four containers pass the rear block, the rear block is re-positioned, the filler heads move into position and the cycle repeats.

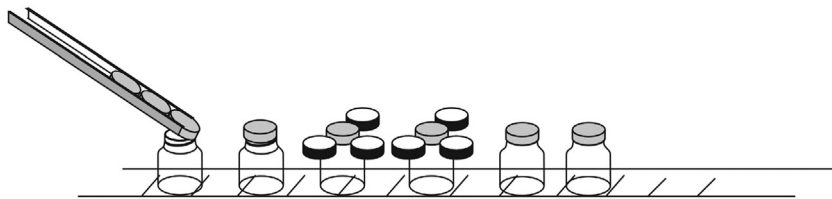
### 5.2 Rotary Fillers

Rotary fillers (Figure 24.9) remove empty containers from the in-feed conveyor and place them on the rotating turret of the filler. As the containers travel around the periphery of the filler, they are filled and then placed onto the out-feed conveyor.

Rotary units range in size from as few as four heads to as large as 140 heads or even more. The large units are used on high speed beverage lines of the type used for filling metal cans with beer or soft drinks. Lines for these products can operate as fast as 2,500 cans per min or 1,600 glass bottles per min. Slower lines are used for milk, pancake syrup, juices, and many other products. The rotational speed of the in-feed star wheel and the rotating turret must be synchronized so that each empty container is placed in the proper position below a filler head on the turret. Similarly, the star wheel on the out-feed side must align with the filled containers as they are taken off the turret and placed back on the conveyor.



**Figure 24.9** *Rotary filler.*



**Figure 24.10** *Cap chute and spinning disk tightener.*

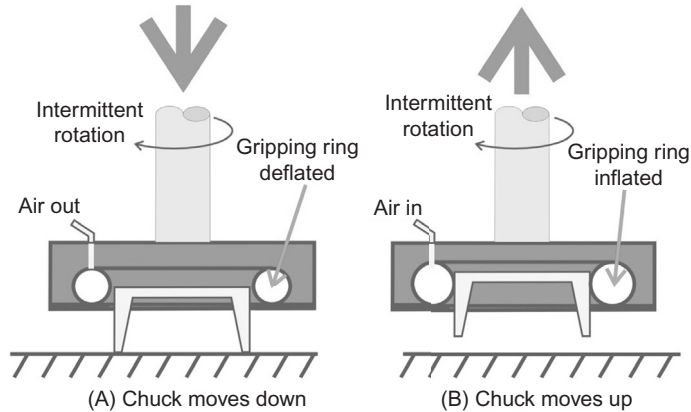
Any of the volumetric or weight filler heads can be used on either in-line or rotary fillers. Filler heads are usually a major portion of the cost of a large rotary filler.

## 6. CAP APPLICATION MACHINES

After a container has been filled, it continues downstream to the next machine which is usually the capper. Like fillers, cappers can be set up in either an in-line or rotary arrangement.

Simultaneously, caps are fed down a chute from a cap orienting machine which puts all caps into the same orientation. Like fillers, cappers can be set up in either an in-line or rotary arrangement. When an in-line capper is being used, the containers pass under the end of the cap chute which is adjusted so that the upper portion of the leading edge of the container catches the lower edge of the cap, pulling it out of the chute and setting it in place on top of the container. Then the container, with the cap, passes through a set of spinning disks which tighten the cap to the desired application torque (Figure 24.10).

The in-line arrangement shown in Figure 24.10 is very popular, but like in-line fillers, there is an upper limit on capping speed. For lines that exceed the capacity of in-line equipment, rotary cappers can be used. The arrangement of capping heads around the periphery of a rotary capper is similar to the arrangement of rotary filler. The filled containers are removed from the line by the entrance star wheel and placed



**Figure 24.11** Operation of pneumatic chuck.

on the capper. As the capper rotates, the caps are applied and tightened. Then, the filled and capped containers are set back onto the line to be moved to the next station. The spinning disk arrangement used on in-line cappers cannot be used on rotary cappers because the filled containers move with the turret and there is no relative motion that would cause the containers to pass between the disks. Instead, a spindle capping setup is used. A spindle (Figure 24.11) is mounted on a vertical shaft that rotates as the spindle travels around the periphery of the machine. The spindle has a “chuck” at the lower end with a torque limiting clutch above.

The operating cycle described below is for a machine applying screw caps. The cycle of steps is essentially the same whether metal or plastic screw caps, metal lug caps, or some other type of cap is being applied.

The operating cycle begins when a cap is delivered to the capping machine. In one system, as the capper rotates, a peg on the outside of the frame of the capper pulls a cap out of the chute in a fashion similar to the way that a container pulls a cap out the end of the chute in an in-line setup. In another system, the empty chuck passes over a swinging arm holding a cap. The chuck is lowered over the cap and picks it up. The arm then moves back to pull another cap from the chute.

When the cap is in the correct position, the spindle moves down and the chuck opens to fit over the cap. Then, the chuck closes to grip the cap and the spindle moves away, carrying the cap with it. While the spindle is picking up the cap, the container is moved into position. Then, the spindle begins to turn and simultaneously moves downward screwing the cap onto the container. When the required (pre-set) application torque is reached, 1. the clutch opens and stops driving the chuck, or 2. the chuck opens and starts to slip around the cap. In either case, the spindle lifts away, releasing the container to be discharged through the exit star wheel and back on to the conveyor to travel to the next machine.

Only one spindle is involved in capping each container. Capping speed can be increased by using a machine with more spindles. Each spindle and container goes through the same sequence of operations. While a peg is picking up a cap at one spindle, another spindle is moving into position, another spindle is applying a cap, another spindle is releasing the container, and a container is leaving the machine through the exit star wheel. Depending on the number of spindles on the capper, the sequence may be divided into even more steps. A rotary capper typically has three to 12 or even more spindles, depending on the filling speed that is required.

## 6.1 Chucks and Clutches

Screw caps can be applied by rotary capping machines that have spindles with pneumatic chucks, mechanical chucks, or roller mechanisms (Figure 24.11). The pneumatic type is illustrated in Figure 24.11. The donut shaped gripping ring is relaxed or deflated when the chuck is lowered to pick up a cap. The ring is made of soft, pliable material that will not scratch or mar the surface of the cap. When the ring is inflated, it grips the cap, enabling it to be picked up. Different sized rings can be installed in the chuck to provide gripping characteristics that are suitable for a particular bottle and cap combination. Also, there are variations on the method for applying the force. One variation has a solid gripping ring with an area above where pressure can be applied, causing the ring to expand in the horizontal direction to grip the cap.

Mechanical chucks operate in a similar fashion except that the jaws are held closed by a spring linkage. The linkage opens when the pre-set application torque is reached while the cap is being applied.

## 6.2 Chuck Type Press-On Cappers

The operation of a chuck type press-on capper is similar to the operation of screw type cappers, except that the twisting motion used to screw the cap down is not required. Instead, the cap is held in the chuck while it is positioned and pressed straight down onto the top of the bottle. The application force can be controlled in several ways. The spring operated capper head application pressure can be regulated by adjusting the collar that sets the spring tension. Similarly, the movement of the capper head can be controlled by air pressure in a pneumatic unit. Chuck type press-on cappers can be designed to suit caps and bottles of almost any size and shape.

## 6.3 Roller Type Press-On Cappers

On roller type press-on cappers (Figure 24.12), the cap is dropped or otherwise placed on the top of the bottle. It is then passed under rollers that press the tap tightly onto the containers. A shallow cap may be pressed on by a single roller. Deeper caps may require two or even three rollers to push them on completely. Roller cappers are



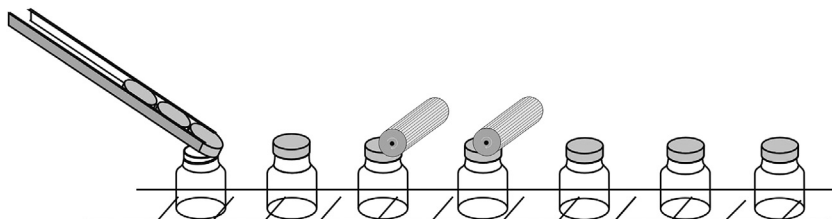


Figure 24.12 *Roller-type press-on capper.*

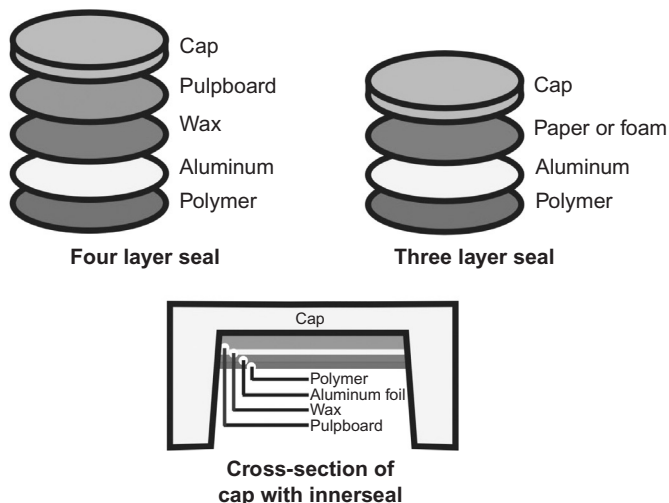


Figure 24.13 *Induction inner seals and cap with seal included.*

generally used to apply caps with flat tops. The first roller levels and seats the cap. The remaining rollers press the cap further on to the bottle. Irregular shapes often cause problems when they pass under the rollers.

## 7. INDUCTION CAP SEALING

Today, increasing numbers of rigid and semi-rigid food packages are fitted with induction welded inner seals. The FDA requires this type of technology for many pharmaceutical products. The rules were instituted following a famous product tampering incident. Inner seals are not required for food products. However, manufacturers are adopting the technology to prevent spills and for product protection. Food products that are packaged with inner seals include peanut butter, edible oils, ketchup, honey, spices, jellies, syrups, etc.

There are two primary types of inner seals (Figure 24.13). The four layer seal shown on the left was originally developed when induction inner seals were first applied to packaging. The three layer inner seal was a later development.

An induction sealing system may consist of a power supply, a sealing coil, a sealing coil mount, a water recirculating system, and necessary electrical cables to connect the power supply and the sealing coil. The power supply converts regular line electrical current into the necessary power and frequency needed to seal bottles. The output energy is transmitted to the sealing coil by the cables. The coil mount supports the coil over a conveyor. An alternating magnetic field is produced around the coil. Several thousand times a second, the field expands and contracts and then expands and contracts in the opposite direction. The water cooling system removes excess heat from the cables and the coil. Modern systems have improved efficiency, so the water cooling system is often not required.

Seals are provided by the cap supplier. Each of the four layers of the seal has a specific function, as described below. A seal is held inside a cap by friction or a small glue spot (Figure 24.13). Caps are applied to bottles and tightened in the usual fashion, as discussed previously. The capped bottles leave the capper and are carried down a conveyor to the induction sealing coil. As the bottles pass under the sealing coil, the lines of magnetic force in the alternating magnetic field cut through the aluminum layer in the inner seal inducing a current to flow the surface of the aluminum layer. The aluminum is not a perfect conductor, so it has some electrical resistance. As a result, heat is produced in the aluminum. The heat causes the wax layer to melt and be adsorbed into the pulp board layer. It also softens the polymer which seals the aluminum to the top of the bottle as it cools. The heating process often loosens the cap. Re-torquing, using a unit similar to an in-line disk type cap lightener is generally used.

## 8. FLEXIBLE PACKAGING

The discussions above have primarily addressed glass and plastic bottles, jugs and similar rigid or semi-rigid containers. However, many food products are packaged in pouches, bags, wraps, and other forms of flexible packaging. Flexible packaging is probably the oldest form of packaging. Ancient hunter gatherers used available natural materials, such as leaves, and animal parts to form flexible containers to wrap food products for protection and for carrying and storing convenience. Of course, all of the packaging was done by hand.

## 9. FORM—FILL—SEAL EQUIPMENT

A form-fill-seal machine (ffs) performs three distinct operations:

1. Form the package.
2. Fill the package.
3. Close and seal the package.

Form—fill—seal equipment is popular because it can be used on a wide variety of products ranging from dry powders, such as cake mixes to liquids, such as salad dressings or pizza sauce. There are three types of ffs equipment:

1. Vertical form—fill—seal machines (vffs).
2. Horizontal form—fill—seal machines (hffs).
3. Thermo—form—fill—seal machines (tffs).

## 9.1 Vertical Form—Fill—Seal Equipment

Vertical form—fill—seal machines are popular and widely used to package a vast array of food products, including dry cereals, granular sugar, cake mixes, flour, and many others. The operation of an ffs machine is easy to understand. As the name indicates, the material being packaged flows vertically down the machine as the various package forming, filling, and sealing operations are performed.

The web of material (usually plastic or a lamination) that will be formed into packages is fed into the machine from a roll (Figure 24.14). The web is usually printed with the manufacturer's logo, product illustrations, nutritional labels, and other information.

The web is threaded through a series of rollers, guides, and tensioning devices. Even movement of the material is critical for smooth machine operation. The web is then fed over a specially shaped former (Figure 24.14). As the web travels over the wings of the former, it is automatically wrapped around the outside of the filler tube

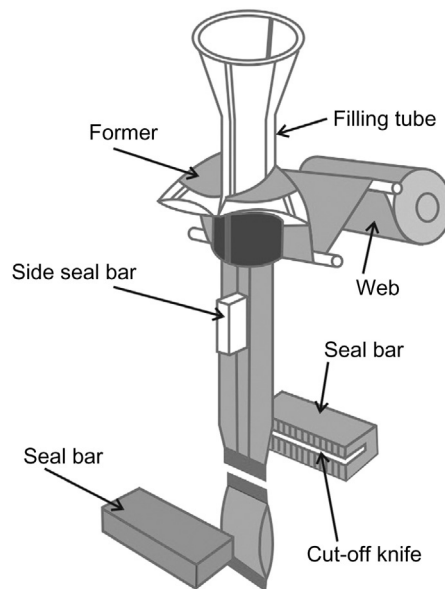


Figure 24.14 Operation of a vffs machine.

and the edges are brought together and positioned for sealing the back seam that will form a tube of the flexible material.

The package material passes down the outside of the filler tube. As it moves, the edges are heat sealed together, forming a tube. At the bottom of the filler tube, a pair of heat seal jaws closes on the tube, flattening it and simultaneously sealing the top of a filled pouch and then forming the bottom of the next pouch. Then a heated knife cuts off the bottom pouch which is conveyed away.

At the same time, the product is loaded into the pouch through the filler tube. As the tube of material continues moving downward, the heat sealing mechanism forms the top of a filled pouch and the bottom of the next pouch.

The sealing jaws are often triggered by an electric eye mechanism which reads a black registration spot printed in the web. In this way, the pre-printed graphics will appear correctly on the completed package. The pouch length can be adjusted easily. However, the filler tube must be replaced to change the diameter of the package.

### 9.1.1 Aseptic Packaging

A specialty form of vffs machinery is used to make aseptic packaging of the type often called “Brick-Pack”: or “drink box”. Aseptic packaging is sterilized in a hydrogen peroxide dip and formed into a package. Then the product which has also been sterilized, is piped into the newly formed box by double wall pipe which has sterile air in the outer layer. Aseptic technology is also used to package products into premade containers. The system is essentially the same, except that the container forming step is skipped.

## 9.2 Horizontal Form–Fill–Seal Equipment

The flow of material in a hffs machine is essentially horizontal. The package forming process starts when a flat web of material, usually plastic film or a laminate with a heat sealable surface is unwound from a roll (Figure 24.15). The web is threaded through a

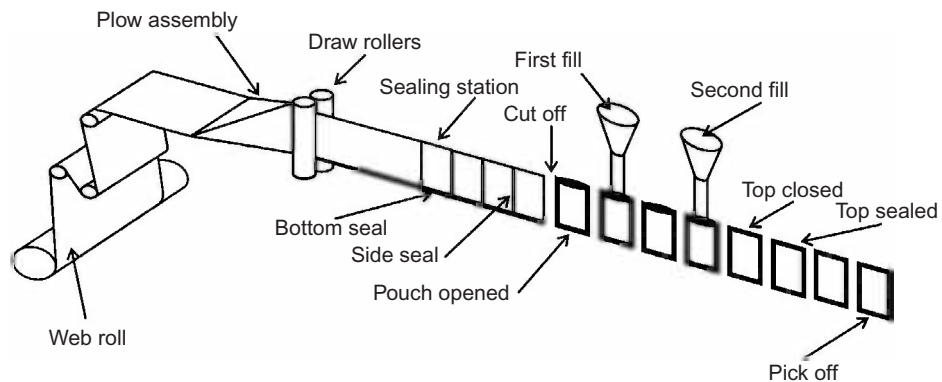


Figure 24.15 Operation of a hffs machine.

series of rollers, guides, and tensioning devices. Uniform tension on the material is critical for smooth machine operation.

Packaging material from a pre-printed supply roll is folded in half. Side and bottom seals are applied. A cutoff device separates the individual pouches which are transferred to clamps on a conveyor chain which, in turn, moves them past the stations for other operations. Just ahead of the filling position, the clamps are moved closer together, causing the pouch tops to open. Filling can be done in one or two steps. A two-step filling setup is illustrated in (Figure 24.15). The first filler head utilizes rapid flow and the second filler “tops off” the filling operation. After filling has been completed, the clamps are pulled apart, causing the top of each pouch to close. The pouches are then heat sealed. In the final step, the pouches are picked off the conveyor chain and placed directly into a shipping container or onto a belt conveyor.

### 9.3 Thermo-Form—Fill—Seal Equipment

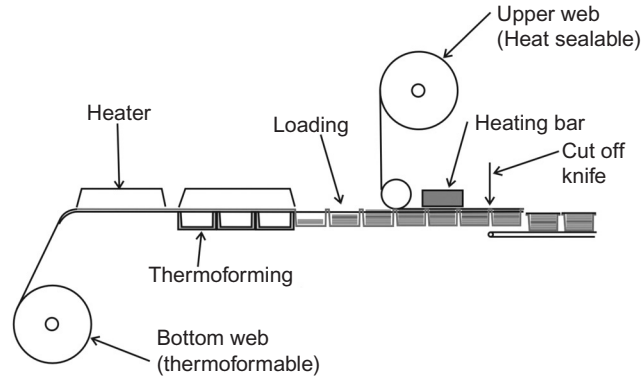
Thermo-form-fill-seal equipment uses two films to make packages. In the most common arrangement, one plastic web is thermoformed into a tray and the other is heat sealed onto the tray to form the cover (Figure 24.16). The bottom material unrolls from the supply roll and passes initially into a section of the tffs machine equipped with heaters to soften the plastic web. As the material moves forward, it passes next into the forming section where a combination of pressure and vacuum pulls the plastic into the shape of a tray to be used as the bottom of the package. The thermoformed plastic then moves into the loading section where the food product is placed into the tray cavities. The loading operation can be done by hand, by robots, or by various metering devices similar to the dry products and liquid products discussed previously. After the trays are loaded, the second plastic web (often transparent) is fed in from the top and heat sealed onto the edges of the trays.

The final operation is to cut the individual trays apart and send them on down the line for any further packaging steps.

Tffs machines are used to package sandwich meat, pasta products, cut meat, medical products, and many other products, even nails, bolts saw blades, and other hardware. The machines are available in a variety of sizes, both in length and width. Machines are used in food plants, and in meat departments of grocery stores. Depending on the kind of product, the filled packages can be shelf-stable, refrigerated, or frozen.

## 10. CANNING MACHINERY

Two types of cans are available: three-piece and two-piece. Cans are made by can manufacturers and delivered to the user's location in pallet load lots. The three-piece cans leave the can company with one can end attached to the sidewall of the can, forming



**Figure 24.16** Operation of a tffs machine.

what is essentially a deep cup. Two-piece cans are formed into a single piece deep cup and leave the can company in that form. Cans are palletized in layers separated by sheets of corrugated board, heavy paperboard, plastic sheeting, or similar material.

At the food or beverage plant, the cans are taken off the pallets by de-palletizing machines. The cans travel down a conveyor to the can washer and onto the filler. Except in very small systems, cans are filled by a rotary filler of the type discussed above. After the cans have been filled, the can end is placed on the top of the can cylinder. The projection of the can end and the flange on the can are then folded tightly together around the periphery, forming a tight seal (Figure 24.17) known as a double seam.

The folding and sealing operation which attaches can ends and closes the cans, is done by a can seamer or can closer. When used at a can manufacturing plant, the machine is known as a double seamer. Can seamers can be used on metal cans, either two-piece or three-piece and on cans made of other materials, particularly plastic. The operation is essentially identical for all of the can types.

A double seam consists of a “first operation” which curls the outside of the can end around the can flange and a “second operation” which forms and irons out a tight hermetic seal between the can and the can end. Hermetic seals are secure against entry of microorganisms and can maintain sterility of the food or beverage that has been packaged in the can.

There are two general types of seamers: head-spin and can-spin. On a head-spin seamer, the can is held while the seaming head, which has first operation and second operation seaming rolls (Figure 24.18), rotates around the can and gradually forms the can end and the can flange into a tight seam. On a can-spin seamer, the can is rotated around its center axis. The seaming rolls, mounted on levers, are moved into position in a sequence to engage the can and form the seam. A variation of the can-spin process uses a seaming rail which has been machined to the desired final shape of the seam. The top of the rotating can is forced against the rail to form the seam.

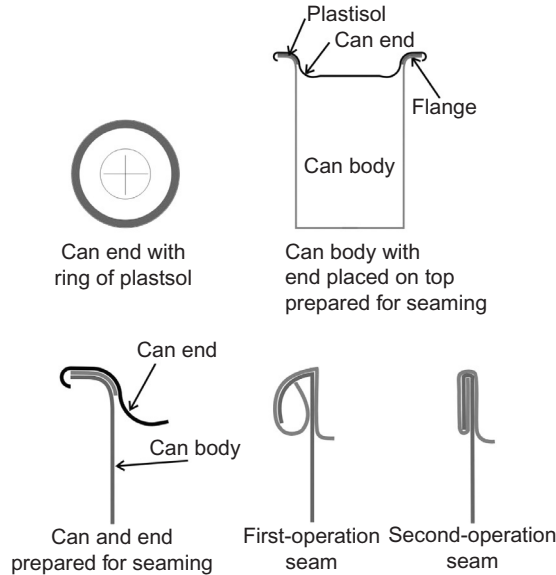


Figure 24.17 Can seaming.

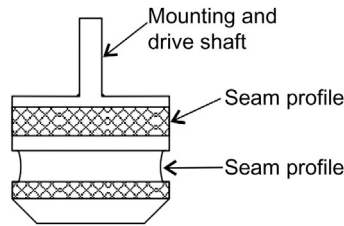


Figure 24.18 Roller for can seamer.

Seamers used in the food industry can be semi-automatic or automatic. Semi-automatic seamers are motor driven single station units used on low speed lines and for making test packages in laboratories. Automatic seamers are single or multiple head machines used to close cans of vegetables, soups, beverages, and other food products, mostly for commercial trade. On food or beverage packaging lines, the can closing speed can range from as low as 100 cans per min to as high as 2,500 cans per min.

Can seamers are designed for a particular can-diameter range, can height range, and speed range. Canning speed is expressed in cans per min or h. A seamer which is in service can be modified to run any can and end within the designated diameter and height range by fitting the proper can and end change parts.

## 11. CARTON FILLING AND CLOSING MACHINERY

Cartons are paperboard containers that are manufactured by converters and then filled and closed in a food packaging plant. Cartons are made in a wide variety of sizes and shapes and numerous designs. Tube and tray type cartons are made from single paperboard blanks that are scored, folded, and glued to form the carton. Cartons are economical. The material is inexpensive when compared to other packaging materials. Cartons can be collapsed to take up minimal space in shipment to the user. A carton provides protection for a product, makes it easier to handle, supplies a surface that can be printed and attractively decorated to add sales appeal to the product, and makes it possible to market several items in a single package. Cartons can be creased and folded into shapes which are semi-rigid or rigid. However, although cartons are used as containers for many products, they are not generally rigid enough to be used as shipping containers.

Cartons are used to package candy, pasta, dry cereal, beans, and other dry products, as well as liquid products, such as milk and orange juice. In addition, several packages of other products can be packed into a carton. An example is a pizza kit in a carton which contains a paper pouch of a dry crust mixture, a second pouch containing powdered cheese, and a metal can of tomato sauce.

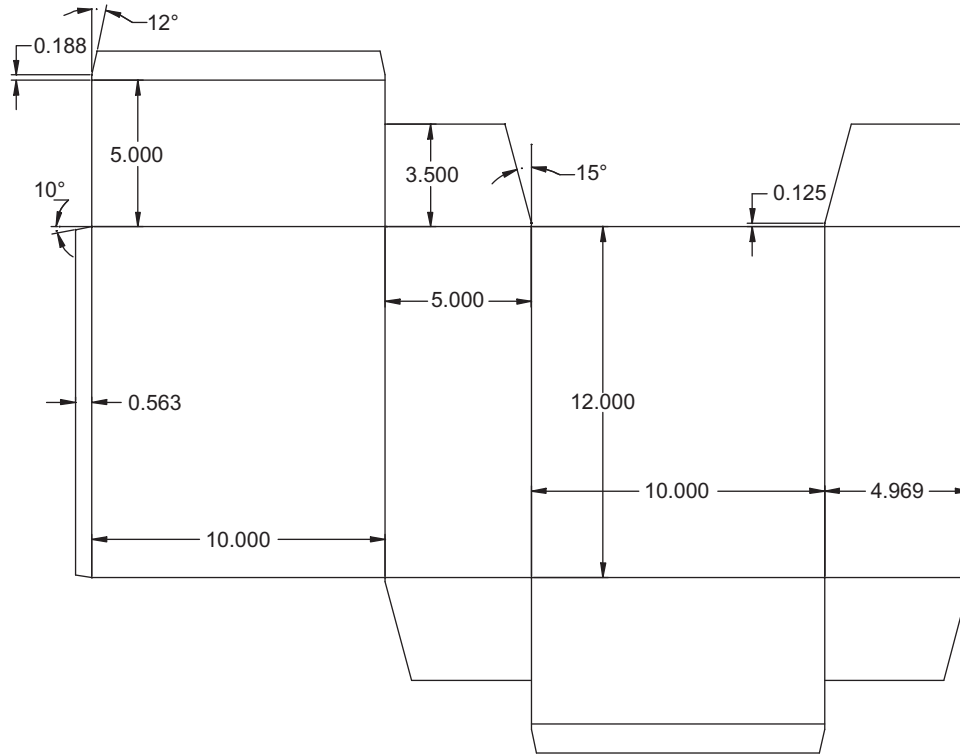
### 11.1 Carton Filling

The following brief description of the operation of a typical cartoner will demonstrate the features and capabilities required by users. There is a great variety of machines for setting up and closing cartons. Some is high speed and automatic and some is semi-automatic and of lower capacity. The most common is the horizontal cartoner for tuck end cartons (Figure 24.19).

The collapsed cartons are taken from the shipping container and loaded into the magazine on the cartoner and held in place by spring pressure or a weight. A single carton is pulled off the front or bottom of the stack by a swinging or rotating arm with vacuum cups attached. The flat carton is then held in place by a pocket on a conveyor chain. At the same time, a pusher bar applies pressure to the trailing edge, forcing it to open and holding it against the front corner of the chain pocket. The combination of vacuum cups pulling and the pressure from the pusher bar holds the carton securely in position as it opens.

As the carton moves along with the chain, the product is pushed into the carton by hand, by pneumatic cylinder, or by a cam-operated mechanism that travels along next to the chain. Then, the carton is closed. The dust flaps on the leading edge are wiped into position by stationary bars as the carton moves along. Trailing flaps are





**Figure 24.19** Reverse tuck carton.

folded forward by mechanical fingers that move faster than the carton travel speed. Then, the tucks are folded in by curved bars that bend the score lines and guide the tuck flaps into the proper slots.

As cartons move rapidly into, through, and out of the cartoner, the carton design must be precise and the manufacturing must be workmanlike. If not, carton jams will occur.

Another factor that will influence the machinability of the cartons is the weather and storage conditions. In the winter, the air is cold and holds less moisture. As a result, the cartons are usually dryer, flatter, and easier to run in the winter. However, as the season progresses and the temperature rises, the air takes up more water. The cartons absorb moisture from the air and often take on a twisted or curved shape because the absorption is not uniform in all areas of the carton blank. The twists and curves make it more difficult for the cartoner to perform the folding and tucking actions involved in closing a carton. As a consequence, jams become more common. One solution is to store the unused cartons in an environmentally controlled space. Or at least give the stored cartons time to equalize moisture before attempting to run them on the machine.

## 12. METAL DETECTORS

Metal is a potential hazard in all types of food products. The hazard can be reduced greatly by using proper equipment and an effective program to manage the, so-called tramp metal. Metal detection is also an issue in pet food systems, but this discussion will focus on human foods and beverages.

Metal in food can cause injury to people, pets, and other animals. It often leads to a loss of goodwill. Incidents of product contamination routinely receive attention from the media, both local and national. A contamination incident can damage a company's reputation. Metal in the food can cause damage to machinery. Finally, the contamination could lead to an expensive product recall.

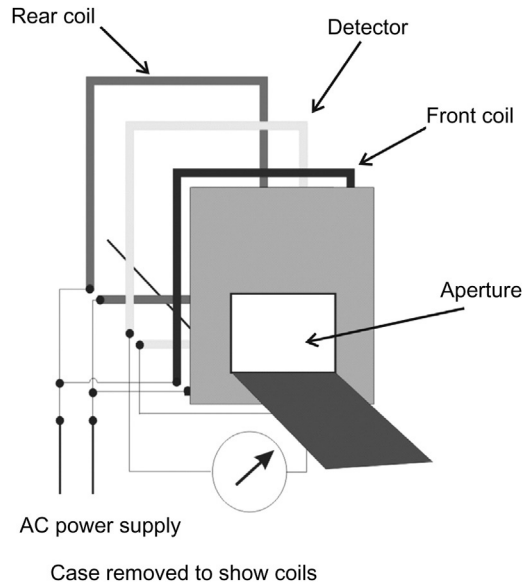
The consequences of metal contamination are serious enough to warrant a carefully planned program to find and remove unwanted metal contamination including the use of metal detection equipment. There are many sources of metal in a typical food plant. Broken machinery is an obvious source. Most food products are processed in metal equipment and packaged by metal equipment. Moving parts wear and eventually small pieces of metal fall off from a machine. Some of the small pieces fall into the food product. Dropped tools are another source of metal as are items which fall from workers' clothes. Some items that could cause contamination in this way include nuts and bolts, screws, nails, pens, rulers, etc. Jewelry worn by workers can fall off and get into the food. Examples include rings, watches, and earrings. And, sometimes, the contamination is not an accident. Systems may be sabotaged by individuals who wish to damage the company or make a legal claim for monetary damages.

The metal detection process that will be discussed is based on the magnetic induction process, the same process that is used to heat the caps in an induction cap sealing system and which makes most electric motors spin.

In simple terms, the metal detector produces an oscillating electromagnetic field. The food products and packages pass through the field. The presence of metal causes a disturbance in the field which can be detected and used to trigger an action to reject the contaminated product, whether or not it is in a package.

### 12.1 Typical Metal Detectors

A common type of metal detector ([Figure 24.20](#)) consists of a heavy metal case and a control unit. The case has an aperture (opening) large enough for a conveyor carrying packages and/or products to pass through. However, there are other arrangements that may be advantageous in certain circumstances. For example, a metal detector can be mounted around the filler tube on a vffs machine. It detects metal in the free-falling stream of product passing through the tube as the pouch is filled. A metal detector has three coils. The front and rear coils are connected to the same AC power supply, but the rear coil is the reverse of the front coil ([Figure 24.20](#)). The center, detector, coil is



**Figure 24.20** *Metal detector.*

connected to the control unit. The front and rear coils produce alternating magnetic fields which are balanced and out of phase with each other. Each of the end coils induces a voltage in the middle coil. When the detector is empty, the voltages cancel each other out so that there is no output signal detector coil. This situation will remain unchanged as packages pass through the unit unless there is metal in the package.

When a piece of metal is moved through the aperture into the detector unit, the metal will interact with the front coil and cause a voltage to be induced in the piece of metal. This voltage, in turn, will cause a current to flow on the piece of metal. That current on the piece of metal causes an unbalanced condition on the middle (detector) coil which can be sensed and used to trigger an automatic rejection device.

Non-conducting objects can pass by the sensor without causing a disturbance of the balance on the sensor coil, but the metal detector will pick up both ferrous and non-ferrous metals as the detection process depends on the electrical conducting properties on the metals.

For this reason, food packaged in aluminum trays, cups with aluminum foil covers, and similar packages cannot be inspected by the metal detector. There is an alternate design, using a static electromagnetic field that can be used on aluminum packages because it will only detect ferrous metals.

A metal detector, by itself, will not provide assurance that all metal will be detected and removed. For best results, the metal detector should be a part of a quality assurance program specifically designed for each product.

# Damage Reduction to Food Products During Transportation and Handling

Jay Singh\* and S. Paul Singh\*\*

\*California Polytechnic State University, CA, USA

\*\*Michigan State University, MI USA

## 1. INTRODUCTION

Packaging plays a key role in protecting a product from contamination by external sources, and reducing damage during its transportation and handling in the supply chain from the producer and manufacturer to the consumer. In the USA alone, estimated annual losses as a result of damaged products exceed \$10 billion. This covers processed foods, perishables, consumer products, and electronic and hardware products sold in retail stores. A major portion of this loss is in the fresh and processed food category. The use of proper packaging materials and methods to minimize food losses and provide safe and wholesome food products has always been a primary focus of food packaging. New packaging technologies are constantly being challenged to provide better quality, wholesome, and safe foods with extended shelf-life, while limiting the environmental pollutions and disposal problems. Packaging is also designed to play a significant marketing role with strong appeal through the use of logos and company brands to display food products in an attractive form. Packaging shapes and forms have been well adopted for brand recognition. This is evident when comparing shaped packages by Coca Cola Company in the beverage sector. The choice of packaging materials and forms is dictated primarily by economic, technical, and legislative factors.

## 2. FUNCTIONS OF PACKAGING

Packaging has been defined as all products made of any materials of any nature to be used for the containment, protection, handling, delivery, and presentation of goods, from raw materials to processed goods, and from the producer to the user or the consumer (Department of Trade and Industry, 2004). The aim is for packaging to protect the goods purchased by the consumer from wastage and damage. Without packaging, handling many products would be messy, inefficient, costly, and in some cases impossible.

The United Kingdom Institute of Packaging provides the following definitions of packaging (Gawith and Robertso, 2000)

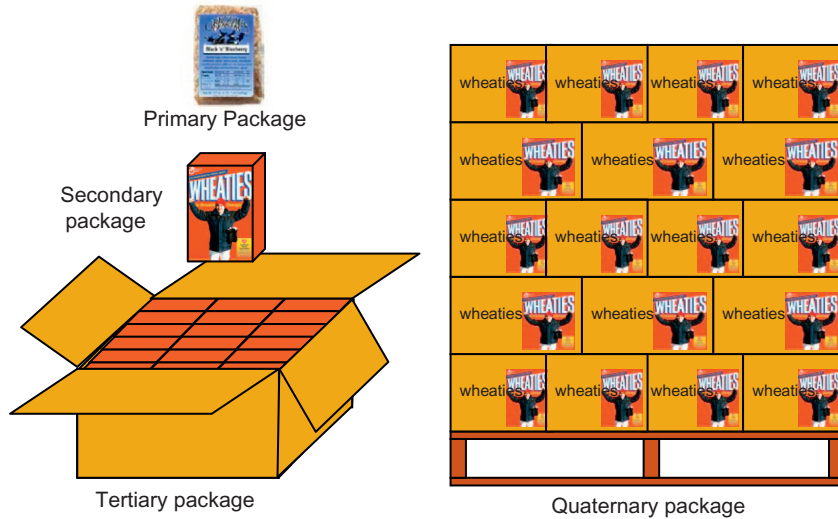
- A coordinated system of preparing goods for transport, storage, retailing, and end-use.
- A means of ensuring safe delivery to the ultimate consumer in a sound condition at minimum cost.
- A techno-economic function aimed at minimizing costs of reusing, recycling, or disposing while maximizing sales (and hence profit).

According to Abbott (1989), the term “packaging” has been defined by the Packaging Institute, USA, and used in both teaching and practice is the enclosure of products in a container to perform one or several of the major functions described below.

## 2.1 Containment

This function attributes to the containment of the product for handling, transportation, and use and is often considered to be the “original” package function required to move products in various forms and shapes. The different product forms, such as solids, liquids, and gases, can make this function a critical factor in the selection process for the type of material and package system. A package must be able to contain a product in order to protect it from various environments. For example, fresh produce (fruits and vegetables) needs to be able to fit well inside of the container with little wasted space (Boyette et al., 1996). Delicate and irregularly shaped produce such as asparagus, berries, or soft fruit may require specially designed containers to accommodate them. From a distribution system approach, packaging may be broken down by layers (Figure 25.1):

- *Primary*: The primary package has direct contact with the product (an example of this is a pouch for cereals). It provides the initial and the major protective barrier from moisture. The materials and printing inks used are regulated by government agencies to ensure that any toxic chemicals do not migrate and transfer to the product.
- *Secondary*: The secondary package contains and/or unitizes primary package(s) (an example of this is the paperboard carton containing the cereal). They contain and protect the primary units placed inside throughout the handling, transportation, and warehousing environments. Sometimes secondary packaging may be specially designed and printed to display primary packages on the sales floor.
- *Tertiary*: Refers to the shipping package (an example of this is a corrugated fiberboard shipping case containing several cereal boxes). This is used predominately for shipment and warehousing purposes.



**Figure 25.1** *Layers of packaging.*

- *Quaternary:* Unitized shipping package (an example of this is a pallet load of stretch wrapped, corrugated fiberboard shipping cases filled with cereal cartons).

## 2.2 Protection

The second function, protection, relates to protecting the contents from deterioration occurring from physical and climatic changes during normal transportation and storage. This could mean protecting the product from shock (drops) and vibration (transportation) by using cushioning. It could also mean using a high-barrier film to prevent oxygen and moisture from entering a package and causing spoilage to a food product. The protection function also relates to protecting the outside environment from contamination by the contents, especially if they are hazardous materials (HazMat). Examples of these protection functions are seals and valves specifically designed to contain contents in HazMat packages.

Sometimes the element of protection also aids in food preservation. For example, produce containers need to be designed to provide an optimum environment for the longest shelf-life possible. These containers may include special materials to deliberate water loss, insulate from heat and cold, or provide a favorable mix of oxygen and carbon dioxide. Aseptically packaged dairy products will only remain shelf-stable for as long as the integrity of the package is not compromised. As a rule, once the integrity of the package is breached, the food product will no longer stay preserved.

Proper packaging is an important component for both food production and related industries. Products must be adequately protected to ensure integrity and safety at all

destinations in the supply chain. Many damaging hazards exist between harvest and the time when products reach consumer hands. A properly designed package can ensure adequate protection from the most adverse of conditions, whether initially caused by human, machine, or environmental issues, or a combination of all three. Products need protection during transport and distribution, from climatic effects such as heat, cold, moisture, drying, hazardous substances, contamination, and infestation.

A majority of groceries are subject to biological spoilage caused by the normal enzyme-induced maturation and by microbiological putrefaction caused by molds, bacteria, and yeasts. Packaging can decrease or retard this spoilage. Synthetic packaging can also contaminate the product, for example, plastic packaging can contaminate some foods with toxic petrochemical-based chemicals, additives, inks, or sealants.

### 2.3 Communication

The third function, communication, is often used to identify the contents, quality, quantity, and manufacturer, etc. There are also various federal and state requirements that may be required as part of this function, depending on the product to be packaged and the choice of packaging materials used. An example of this is the nutrient information label requirement on all food packages. Additional features, such as precautionary labeling, help provide information for safe use, handling, and storage of the container. Flavors, alcohols, preservatives, and cooking wines are examples of food products that may require hazardous materials packaging, depending on quantity and shipping method. Pictorial markings are used to mark and identify a package and are often used both for domestic and international labels to identify the safe handling, storage, and human interaction with the container.

Legal/regulated information on the package label includes net quantity declaration, ingredients listing, nutritional label, health claims, and reduced-calorie statements ([The Clemson University Cooperative Extension Service, 2002](#)). These fall under the Fair Packaging and Labeling Act and the Nutrition Label and Education Act. Emotional/motivational/selling information is intended to gain interest and help sell the product such as purchase incentives, recipes, contests, logos, color, overall design, photographic images, and illustrations ([The Clemson University Cooperative Extension Service, 2002](#)).

### 2.4 Utility

Lastly, utility relates to the ease of use or performance of the package system. This includes the ease of opening and closing (if required), reuse, application, dispensing, and especially a provision for instructions and directions ([Singh and Singh, 2005](#)). One of the main reasons for the dramatic rise in food packaging is convenience. Consumers are demanding convenience and quick food preparation. Packaging that

allows bagged salads, fresh cut vegetables for stirfries, case ready meat, and bag and boil pasta or rice, are all examples of food packaging that allow convenience to the consumer to prepare good-quality and multi-ingredient healthy meals in short times. Additional examples of convenience packaging include easy-open beverage and food cans, frozen food packs, microwavable containers, wine cardboard casks, individually wrapped butter and stock cubes, and controlled dispensing with spouts, squeeze bottles, spray cans, aerosols, etc. for sauces, cooking oils, jellies, pastes, and sauces (Reduce Packaging, n.d.). Figure 25.2 shows examples of various convenience packages for soups. Among notable trends in soup packaging are easy-open tops on metal cans and microwavable primary packaging in the form of plastic single serve cups and stand-up pouches.

Most specialty packaging today often has several features that address the utility function of a package and are often the driving force for the sales of the product. An example would be a tamper evident, child-resistant closure used for a pharmaceutical product that provides an easy to open feature for the elderly. Various research studies are being conducted as the pool of elderly with limiting dexterity pose a greater challenge for easy access to packaged contents for foods and pharmaceuticals.

One or more of these primary functions are essential in characterizing a container or system to be termed as a package. Packaging comes in many forms, such as convenience foods, individually packed serves, microwaveable meals, easy-opening packaging, secure packaging for hazardous chemicals and pharmaceutical drugs, and packaging of fresh food for transport and display (Reduce Packaging, n.d.). The form of the package is determined to some extent by the functions of the packaging to



Figure 25.2 Examples of convenience packaging for soups.





Figure 25.3 Examples of single-serve cereal packaging.

contain, preserve, protect, and communicate information. Figure 25.3 shows trends in breakfast cereal products. Note the single-serve packages.

The growth in the packaging industry has led to greater specialization and sophistication based on health and environmental friendliness of packaging material. So to meet the goal of packaging it is necessary to develop the right type of packaging materials, form, machinery, and process.

### 3. FOOD PRODUCT CATEGORIES

#### 3.1 Meats

Meats pose special problems for the packaging industry because of the highly perishable and biologically active nature of the product (Sacharow, 1980). On average, they have a maximum 2–3 day shelf-life in tray packs. Color changes as a result of oxidation will also reduce consumer acceptance and a potential sale (Sacharow, 1980). Traditional meat packaging methods are not intended to prevent bacterial contamination. Meat is handled so frequently for retail sale that contamination is inevitable (Sacharow, 1980). The principal role of packaging meats is to prevent moisture loss, exclude foreign odors and flavors, and to reduce the effects of oxidation. To ensure these targets are met, the packaging used needs to have good tear and puncture resistance, while upholding a pleasing appearance for the purchaser in a retail store temperature-controlled display environment (Sacharow, 1980). Figure 25.4 shows meat trays using pre-packed case ready meat using Sealed Air<sup>®</sup> modified packaging.

In supermarkets, fresh meat is placed in rigid thermoformed plastic trays and over-wrapped with a transparent or heat-shrink film. The tray is usually expanded



**Figure 25.4** Meat trays using pre-packed case ready meat using sealed air modified packaging.

polystyrene of a contrasting color to promote the freshness and quality look of the meat it contains. Blotters or absorbent pads are placed underneath the meat to absorb excess juices. New retailing methods such as case ready meat for beef, ground beef, pork, chicken, turkey, lamb, and veal strive to reduce handling and contamination (Salvage, 2005). This practice streamlines distribution and reduces time for products to move through the supply chain from manufacturer to customer. Case ready meat is prepared in a central location and shipped to individual supermarkets already packaged and ready for immediate sale. Most products prepared this way are identical in packaging to meat cut and packaged by a butcher in a store (Salvage, 2005). This centralized system is common in Europe, but has recently been introduced into the USA by leading retailer WalMart Stores Inc. and packaging innovation developed by companies such as Sealed Air Corporation and Pactiv Inc. Case ready red meat is still growing, but benefits include extended shelf-life, hermetically sealed and leak-free packs, and better food safety because of less human contact (Salvage, 2005). Stores that have adopted this program now include Albertsons, Kroger, Safeway, Target, and Wal-Mart, among others (Salvage, 2005).

### 3.2 Seafood

Retail fresh seafood sales are growing, up by 13% each year, thanks to innovative methods for commercially raising fish and advancements in packaging materials (Christopher, 2003). These factors help bulk retailer Costco sell approximately 30,000 tons of salmon filets and shrimp per year. New packaging materials are important because they prolong shelf-life while maintaining freshness of the product. This is possible because the packaging prevents damage during transportation and addresses temperature concerns (Barry, 2003). Examples of seafood packaging for imported product are shown in Figures 25.5 and 25.6.



**Figure 25.5** Seafood (shrimp) in display ready from Thailand for Kroger Inc. in vacuum packaging.



**Figure 25.6** Seafood (scallops) in display ready from China for Kroger Inc. in vacuum packaging.

Fresh seafood has an extremely limited shelf-life. This timeframe may be reduced to a few hours if proper packaging methods are not followed to prevent spoilage, such as dehydration, natural juice loss, odor permeation, bacterial growth, and incorrect temperature controls (Sacharow, 1980). Fish must be immediately gutted and cleaned prior to packaging and refrigerated transportation is necessary to prevent enzymatic and bacterial contamination (Sacharow, 1980). Temperature control is extremely critical to maintain a high-quality and unspoiled product. The rate of spoilage doubles for every 5.5° of increase in temperature (Sacharow, 1980).

Once seafood is harvested and packaged, temperatures need to be quickly reduced to prevent microbial growth, and flavor and texture loss. The potential for botulism reproduction is also a reason why the Food and Drug Administration (FDA) maintains strict guidelines for seafood packaging. Seafood must be in contact with a limited oxygen flow to prevent deadly anaerobe microbial growth (Barry, 2003). Also, too

much contact with oxygen and improper temperatures will promote the natural fish oils and fats to rapidly oxidize and go rancid.

Fresh seafood is transported by air to reach markets faster. Lightweight protective containers are necessary for distribution. Bulk containers are usually wax-coated corrugated boxes that help promote insulation and efficiently reduce the amount of required refrigeration.

### 3.3 Vegetables and Fruits

Fruits and vegetables purchased at supermarkets are living plant organs which, when growing, exhibit features such as respiration, transpiration, synthesis, and degradation of chemical constituents. When harvested, the produce is removed from a source of water and mineral and organic nutrients, but remains living. Greening and sprouting of stored onions and root tubers and the sweating of produce in polythene bags as a result of transpiration and water loss, are just a few examples of this retention of living processes. As soon as produce is harvested the processes leading to breakdown begin and cannot be stopped. However, the rate at which breakdown occurs can be slowed and losses minimized by employing the correct handling methods after harvest.

Major retailers, such as Wal-Mart and Sam's Club, have pushed the produce industry to adopt a modular and interlocking common footprint container solution for use in transportation, storage, and floor displays. Common footprints require standardized dimensions and stacking features to ensure compatibility between differing container manufacturers and materials (Major, 2003). These containers are packed in the fields with the desired crop then distributed to stores without repackaging (Fibre Box Association, 2005). Citing improvements in product integrity, reduced shrinkage, better space efficiency, and reduction in labor costs, the supermarket and bulk club industries have found container standardization to be an important development (Paperboard Packaging, 2000, 2002). No longer will boxes and cartons of varying size be transported, warehoused, and produce repackaged. There are two competing systems on the market, returnable plastic containers (RPC) and the corrugated common footprint (CCF).

#### 3.3.1 CCF

Recyclable CCF were introduced in 2000 as a response to the emergence of common footprint RPC. RPC display-ready bins promised to improve efficiency, durability, airflow, and to attack corrugated's 98% dominance of the produce market (Major, 2003). The Corrugated Packaging Alliance responded to this threat by developing the CCF. Corrugated containers offer superior protection because the fluted material provides built-in air cushioning and minimizes damage from abrasion and bruising. In the near future, CCF are expected to have a 5:1 market share over RPC (Fibre Box Association, 2005).

The Fibre Box Association (FBA) and the European Federation of Corrugated Board Manufactures (FEFCO) have outlined standards to ensure compatibility between different manufacturers in the USA and Europe. According to these associations, a full stack of containers will be 597 mm by 398 mm, whereas a half-stack will be 398 mm by 298 mm. Footprint configurations may not overhang any European or American standard pallets, which are 1,200 mm by 1,000 mm or 40 by 48 in., respectively. Also, these containers must be able to stack in mixed loads with other FBA and FEFCO approved containers, regardless of manufacturer, without sacrificing load stability or container integrity (Paperboard Packaging, 2000).

Reasons to choose CCF include savings on shipping costs, and these versatile containers double as point-of-purchase displays. Corrugated weight is much lighter than plastic and 7.5–22% more products can fit per truckload (Fibre Box Association, 2005). Once the displays reach stores, they can be sent directly to the floor. High-quality printing will attract customer attention. Paperboard Packaging (2000) reports that the FBA and FEFCO standards allow significant design flexibility. Containers from different manufactures may vary in style, depths, venting features, graphics, colors, and self-locking mechanisms, while still conforming to the common footprint design (Figure 25.7). This provides flexibility to create a container that offers maximum protection and marketability for specific fruits and vegetables (Fibre Box Association, 2005).

However, CCF are limited to one-time use. This is an environmental waste concern. The corrugated industry is quick to point out that approximately 74% of all box material manufactured today is recycled (Fibre Box Association (2005). Grocery retailers recycle at even higher rates because they earn money when used boxes are recovered (Fibre Box Association, 2005).



Figure 25.7 A corrugated common footprint tray.

### 3.3.2 RPC

RPC share common footprint, tab, and receptacle locations to CCF. A joint study by the Corrugated Packaging Alliance and the Reusable Pallet and Container Coalition (RPCC) indicates that when mixed together on a pallet, both offer similar performance (Harper, 2004). In other words, mixed loads performed as well as loads of either 100% CCF or RPC (Harper, 2004). This allows supermarkets flexibility regarding how fruits and vegetables are shipped on the same pallet.

The California Strawberry Commission financed a study to determine which material provided a faster cool-down rate, an important factor with perishable produce. Initial results indicated that CCF beat RPC. However, revised findings found “no measurable difference in cooling . . .” between corrugated and plastic containers (Zind, 2003).

According to the RPCC, plastic is less detrimental to the environment than the one-time use corrugated system. The study showed that plastic required 39% less total energy, produced 95% less total solid waste, and generated 29% less total greenhouse gases (Figure 25.8) (RPCC, 2005).

## 3.4 Processed versus Non-Processed

Food processing is a \$500 billion industry in the USA (Hormel, 2005). Processors offer an almost limitless supply of foods. These items come packaged in various ways to meet consumer demand for safety, convenience, and nutrition. Widely used methods for food processing include canning, freezing, refrigeration, dehydration, and aseptic processes. Processing technologies are designed to rid foods of harmful organisms and make products shelf-stable (Hormel, 2005). The United States Department of Agriculture (USDA) even has a special Processed Foods Unit. According to the USDA, the idea of this specialized research team is to enhance the marketability and



Figure 25.8 A reusable plastic container.

healthfulness of agricultural commodities and processed products to better benefit consumers.

Non-processed foods are the raw materials and agricultural commodities that are turned into processed foods ready for consumer use.

## 4. FOOD PRODUCT DISTRIBUTION ENVIRONMENT

### 4.1 Harvesting

Harvesting is the initial stage in supply chain distribution (Figure 25.9). This is a critical time for growers, as overall integrity cannot improve after this point (FAO, 1989). Therefore, items will need to be packed and shipped with care to avoid additional and preventable damage. Produce prices are dependent on physical condition (FAO, 1989).

Fruits and vegetables are still considered living organisms after harvest. However, post-harvest longevity is limited. The rate of deterioration depends on how fast water and nutrient reserves are depleted (FAO, 1989). If harvested crops sustain damage, the rate of deterioration increases. Therefore, careful harvesting is the first step for a successful and safe journey to retail outlets.

### 4.2 Packing

Fruits and vegetables are especially sensitive foods. Large produce quantities need proper packaging to minimize losses in the most cost effective way. Each time crops are handled or repackaged, the chance for irreversible damage increases.



Figure 25.9 Harvesting of grapes.

To protect crops during this stage, certain precautions need to be noted. Wooden crates may have rough surfaces, sharp nails, and staples. If containers are over-packed, compression damage will occur when they are stacked. Dropping and/or throwing containers, as well as any additional rough handling, will cause further damage.

Container sizes used should be easy to handle and maneuver. A standardized system such as Returnable Plastic Containers And Corrugated Common Footprints are one example (Figure 25.10). These containers are of a uniform size that reduce excess handling, and provide better stacking and loading qualities (FAO, 1989).

### 4.3 Shipping

Food is transported from producers to packing houses or processing plants and from processors to retail markets. It is important that fresh foods are shipped quickly and efficiently as they are perishable and susceptible to injury. Refrigerated trucks, railroad cars, and cargo ships are all modes of transportation used, sometimes in conjunction with each other on long journeys. Airplane use is typically reserved for highly perishable items, such as fish, or expensive foods, such as live lobsters.

Throughout the shipping stage, food products need to be carefully loaded and protected to prevent damage from a wide assortment of potential hazards. Loads need to be positioned accordingly to fit inside transportation containers efficiently and remain stable. For example, proper stacking is necessary to prevent shifting or collapsing. In other cases, foods need to be protected from vibrations and jolts. This may be prevented by special packaging materials or if being shipped by truck, equipping the trailer with shock absorbers and low-pressure tires (FAO, 1989).



Figure 25.10 Empty CCF trays.



#### 4.4 Storage and Shelf-Life

Storage for most meats, seafood, and produce involves some sort of refrigeration. Their storage and shelf-lives are dependent on biological and environmental conditions (FAO, 1989). Warm temperatures will increase the natural enzymatic breakdown rate in foods. As produce is considered a living organism after harvest, food and water reserves will become depleted causing spoilage. Microbiological organisms may also penetrate natural openings or broken surfaces causing decay. Cool storage temperatures slow down natural biological processes and decay in the foods we eat.

Many fresh seasonal and highly perishable food crops are processed to preserve nutrients and avoid wastage. Processing expands consumer choices and allows for greater flexibility (FAO, 1989).

### 5. MAJOR CAUSES OF FOOD SPOILAGE/DAMAGE IN SUPPLY CHAIN

United Nations statistics indicate half of the third world population does not have access to adequate food supplies. In addition, 25% of food that is successfully produced will be lost after harvest because of mishandling, spoilage, or pest infestation (FAO, 1989). Even food with small amounts of damage may have properties such as taste, visual blemishes, and the rate of deterioration adversely affected (FAO, 1989). Proper packaging helps alleviate some of these issues. Developed countries, such as Europe and North America, have access to better packaging methods and technology. As a result, these countries experience substantially lower rates of spoilage and wastage.

Most packaged food deterioration and spoilage occurs when the container is opened or compromised to the external environment (Robertson, 1993). Knowledge of the various types of spoilages and contaminants allows packing and processing firms to choose the correct materials for their products.

#### 5.1 Microbiological Spoilage

This is a major factor in food spoilage. A host of microorganisms may flourish in foods. They multiply rapidly within the food and produce byproducts that cause chemical changes to affect color, texture, flavor, or nutritional value. These containments may also release toxins, which lead to illness or even death.

#### 5.2 Biochemical

Biochemical refers to enzymatic deterioration. Enzymes are naturally found in plant and animal tissue that control digestion and respiration. Upon harvest, these enzymes begin to destroy the tissue and cause spoilage. Some enzymes come in contact with the food as a product of microbial growth. They have several main functions of which food processors and packaging professionals should be aware. First, enzymes can act as

catalysts and accelerate the rate of chemical reactions that occur. Second, specific enzymes may be modified to produce desired longevity effects. Proper packaging methods and materials can slow enzymatic activity. Containers that maintain low temperatures, protect water activity levels, and maintain appropriate oxygen flow, will help keep foods fresher longer.

### 5.3 Chemical

Oxidation is the major chemical reaction that leads to spoilage. Certain components and characteristics contained in foods, such as fats and vitamins, are susceptible to atmospheric oxygen. It also promotes mold growth. Other sources of chemical changes are caused by light and components in the packaging material. These reactions cause flavor alteration, discoloration, surface damage, and decay (FAO, 1989).

### 5.4 Microbiological Spoilage

Microbiological spoilage is caused by insects, rodents, birds, and pilfering by humans (FAO, 1989). Initial damage incurred by these factors may be minor and could be overlooked. However, even the most minor tissue wounds will make food more susceptible to microbial damage, causing the food to be inedible and lead to sickness or death.

### 5.5 Physical

Physical injuries can be classified as either mechanical or physiological. Mechanical damage leads to spoilage because it may cause bruising or deep punctures that cause water loss and rapid decay in fruits and vegetables or other undesirable effects for other food products. Mechanical effects may result from impact or shock associated with dropping, throwing, or sudden starting and stopping of a vehicle. Vibration damage also may result from various transportation methods including truck, train, airplane, and boats. Compression and crushing are caused by flimsy or oversized containers, overfilled containers, and containers stacked too high and unable to support heavy loads. Physiological deterioration may increase natural deterioration because of high temperatures, low humidity, or other physical injuries.

## 6. PACKAGING MATERIALS

Packaging is essential. It is designed to surround, enhance, and protect. Packaging perishable food products is particularly cumbersome. The supply chain, which starts at the grower, ultimately ends up at the supermarket and the consumer. Bags, crates, hampers, baskets, cartons, bulk bins, and palletized containers are all examples of the

various types of containers that may be used at different parts of the journey. There are approximately 1,500 different types of packages that may be used, sometimes in conjunction with each other (Boyette et al., 1996). According to one study, a significant percentage of produce buyer and consumer complaints may be traced to container failure because of poor design or inappropriate selection and use (Boyette et al., 1996).

A World Health Organization study has indicated that in developed countries with sophisticated storage, packaging, and distribution systems, wastage of food is estimated at only 2–3%. In developing countries without these systems, wastage is estimated at between 30% and 50% (Soroka, 2002).

According to the United Nations (1969), food is packaged for two main reasons, to preserve it and to present it in an attractive form to the buyer. In order to successfully satisfy these requirements, various materials are used. The factors involved in selecting these materials include:

- The composition of the food product and its physical state.
- Nature of deteriorative reactions that may occur.
- Modes of transportation used to bring the product to market.
- Time before consumption.
- Who the target consumer will be.
- Overall budget for the product.

Ideally, all food containers should exhibit the following properties:

- Sanitary.
- Non-toxic.
- Transparent.
- Tamper-proof.
- Easily disposable.
- Protective against light.
- Easily opened or closed.
- Impermeable to gasses or odors.
- Resistant to chemical or mechanical damage.
- Easily printed or labeled.

The following is a brief overview of packaging materials commonly used for packing as standalone or in conjunction with each other.

## 6.1 Paper

Cardboard and pasteboard are both terms for corrugated fiberboard, a material commonly used for boxes. This paper-based product is available in many different styles and weights made to accommodate a wide variety of food products. Demand for corrugate has been growing steadily at an average of 2–3% per year in Europe, where it

dominates with a 63% market share over other packaging material alternatives such as plastics (FEFCO, 2000).

According to the Corrugated Packaging Council, the product is easy to identify. Corrugated, in its most basic design, has two main components, an arched, wavy, layer called “fluting”, which is glued in-between two smooth sheets called “liners” (The Corrugated Packaging Alliance, n.d.). Together they form a double face. The fluted liner can be made in varying sizes, each size denoted by a letter, A to E. Size A has the largest flutes and E the smallest. The grades are assigned according to paper weight and thickness.

The flutes are the essential component in corrugated material. They give containers strength and add protection. When the flutes are anchored to the linerboard with adhesive, they resist bending and pressure from all directions (fibrex.org). When a piece of corrugated is placed on its end, the flutes form rigid columns, capable of supporting weight without compressing. This allows many boxes to be stacked on top of each other. When pressure is applied to the side of the board, the space in between the flutes serves as a cushion to protect the container’s contents, thus providing shock protection. The flutes also provide insulation against sudden temperature changes. The liners placed on the outsides protect the flutes from damage and increase the container’s overall strength.

For produce transportation, double-faced corrugate is commonly used. The materials used on the inner and outer layers are determined by the product it will hold. For example, the inner layer may be coated to resist moisture while the outer layer will usually be printed to identify the contents and for display inside retail outlets (FEFCO, 2000).

Corrugated materials have standards to ensure boxes shipped by rail or truck do not fail during transportation. The first rules established in the USA were in 1906. Corrugated must protect from bursting to withstand forces during rough handling, be able to withstand weight placed on top of the box, and allow for a maximum weight of contents that can be safely placed in the box. These measurements are usually printed on the outside of the container.

## 6.2 Plastic

Plastics are a versatile medium used to protect and prevent damage to a variety of food products. They are available in a variety of thick, thin, rigid, or flexible forms, ranging from bottles to liners, to accommodate almost any food product. Traditionally, this material is only considered for primary or secondary packaging. This is changing as manufacturers and distributors have adopted RPC for tertiary packaging use with fresh produce. Now plastics use may be considered at all levels in the supply chain (APME, 2001). According to the American Plastics Council, each

pound of plastic can reduce up to 1.7 lbs of food from being wasted as a result of spoilage, contamination from foreign substances and organisms, or packaging failure (APC, 2005).

As plastic is light in weight, it also saves costs in transportation and is therefore a cost effective material. Plastic also extends the life of perishable produce to eliminate waste and preservatives. The transparent nature allows people to look at food and touch it without causing bruising or other damage (APME, 2001). The shatterproof material keeps the package intact, and prevents chips or shards from contaminating the food. Polyethylene films are the dominant material for fruit and vegetable packaging in retail stores. Produce remains fresh during transportation and handling because the material is breathable, allowing the correct ratio of oxygen, carbon dioxide, and water vapor to fill the bag. Some produce varieties can be protected by rigid clamshells (Figures 25.11 and 25.12). This inexpensive package encloses high-value items such as fruit, berries, precut salads, and mushrooms and prevents delicate items from crushing (The Clemson University Cooperative Extension Service, 2002).

Polyethylene (PE) is the dominant plastic material in use today, with a 56% market share. Other types of plastic used are polypropylene (PP), polyethylene terephthalate (PET), polystyrene (PS), polyvinyl chloride (PVC), expanded polystyrene (EPS), and high density polyethylene (HDPE).

Material descriptions according to the American Plastics Council (2005):

- *PET*: Clear and tough material. Has good gas and moisture barrier properties. Commonly used for beverage containers, food containers, boil-in food pouches, and processed meat packages.



Figures 25.11 Bunches of grapes being packed in plastic clamshell trays.



**Figure 25.12** Bunches of grapes being packed in plastic clamshell trays.

- *HDPE*: Used for milk, juice, and water bottles, as well as cereal box liners. Translucent material is well suited for products with a short shelf-life. Has good strength, stiffness, toughness, and chemical resistance. Gases are permeable.
- *PVC*: Widely used for construction applications because of stable properties. This rigid plastic is commonly used for clear food packaging such as food wrap, vegetable oil bottles, and blister packaging. It has great strength and toughness and resistance to chemicals, oils, and grease.
- *LDPE*: This plastic is predominating for film applications. It is tough and flexible, while still maintaining transparency. It makes sealing easy and is a good barrier to moisture. Common applications include shrink-wrap, plastic bags, and squeezable food bottles.
- *PP*: This strong material has a high melting point, making it a good candidate for hot-fill liquids. Resistant to other chemicals, grease, oil, and moisture. Commonly used for margarine and yogurt containers, caps for containers, wrapping to replace cellophane, and medicine bottles.
- *PS*: Can come in two different forms, either rigid or foamed. Usually it is clear, hard, brittle, and has a low melting point. Typically used for protective packaging such as egg cartons, containers, lids, fast food trays, disposable plastic cutlery, and cups.

### 6.3 Metal

In the 1790s, Nicolas Appert became the first person to conserve food in a metal container. Today, commercial canning is made possible by materials such as steel, aluminum, tin, and chromium. Each material offers food processors different

properties and preservation methods. Producers choose metal for food and beverages for reasons including mechanical strength, low toxicity, superior barrier properties to gases, moisture and light, and ability to withstand a wide extreme of temperatures. These qualities help ensure the integrity and safety for a wide variety of food products.

The most commonly used metals for packaging are tinplate, tin free steel, and aluminum. Tinplate comprises low carbon steel with a thin layer of tin. The tin layer may be as thin as 0.38  $\mu\text{m}$  (Soroka, 2002). Tinplate is non-toxic and corrosion resistant and is well suited for conversion into packaging because of its excellent ductility and drawability.

Tin free steel comprises low carbon steel and a thin coating of chromium, aluminum, or enamel. Cans made from this material can no longer be soldered and must be welded or cemented.

Tinplate and tin free steel are commonly used to manufacture three-piece cans. These cans can be mechanically seamed, bonded with adhesive, welded, or soldered (Soroka, 2002). Soldered food cans are no longer permitted in North America. Three-piece cans are most popular worldwide because they are cheap to produce, as all pieces are made from flat sheets with no stretching required.

Aluminum is the most abundant metallic constituent used for packaging. Often referred to as the transportation metal, aluminum alloys with magnesium for strength and provides one-third the strength of steel at one-third the weight. Among its notable properties, aluminum is light, weaker than steel, easy to work with, expensive, non-toxic, a good barrier down to 1 ml thickness, non-magnetic, does not rust, has no “taste”, and has an excellent recycle record.

Aluminum cans are often two-piece in construction with a seamless body plus a top cap. They are very popular in the US beverage industry. The machinery used to manufacture these cans is costly compared to three-piece cans because the process stretches metal. The two most commonly used processes in manufacture of two-piece cans are draw and iron, and draw and redraw.

## 6.4 Glass

Glass refers to an inorganic material fused at high temperature and cooled quickly so that it solidifies in a vitreous or non-crystalline state. The main constituent of glass, silica, is an abundantly available element because it exists in the form of sand. Lime and soda are the other two major components of glass. Cullet or recycled glass is often desired as one of the primary constituents because it provides excellent energy and time savings to the manufacturers. Large-scale glass manufacturing for food products was introduced in the late 1800s. Today's glass containers are lighter and stronger than their predecessors. Amber and green glass provides light protection for sensitive foods.

Glass is impermeable to gases, moisture, odors, and microorganisms and is probably the most inert packaging material available today. Glass also provides other benefits such as it can be molded into a variety of shapes and sizes, is ideal for high speed filling lines, is made from abundant raw materials, and is reusable, recyclable, and re-sealable. Among its greatest drawbacks are the facts that glass is brittle and usually breaks under an applied tensile strength and has the least ability to withstand sudden temperature change, unlike other packaging materials.

The manufacture of glass containers involves either blow-and-blow process used in manufacturing narrow mouth containers, press-and-blow process used for wide mouth applications, and the most recent process, narrow-neck-press-and-blow gaining favor for manufacture of narrow mouth containers, because of its ability to distribute the material more evenly thereby requiring less material.

## 7. "SMART" PACKAGING

With modern development and enhancement in packaging technology, today's packaging is providing more than just the basic functions. Smart packaging is a term coming into use more frequently and covers a number of functionalities, depending on the product being packaged, including food, beverage, pharmaceutical, household products, etc. (Butler, 2001). Examples of current and future functional "smartness" include packages that:

- Retain integrity and improve the shelf-life.
- Enhance the product attributes such as its flavor, aroma and taste.
- Assist with product access and indicate seal integrity.
- Respond actively to changes in product or package environment.
- Confirm product authenticity.

### 7.1 Active Packaging

Traditional "passive" packaging techniques that only allow for a short shelf-life are being consistently improved on to play an "active" role by slowing down quality impairing processes within the packaging itself, because of advances in polymer chemistry. Examples of active packaging systems include use of oxygen scavengers, ethylene absorbers, moisture regulators, taint removal systems, ethanol and carbon dioxide emitters, and antimicrobial-releasing systems.

In active packaging, a substance or substances are incorporated into the packaging to fulfill an active role in protecting the foodstuff against contamination, such as aroma components of microorganism growth. Until recently, carbonated beverages in plastic bottles tended to have limited durability compared with conventional glass bottles. With recent developments, the shelf-life of beer in 0.33 l PET bottles has been increased from 6 to 9 months (Beverage Machines Magazine, 2006).



As a majority of food products are light sensitive, ultraviolet light barriers, which preserve the transparency of the bottles or containers, are being incorporated into the substrates of the packages. As related to informative packaging, external or internal indicators that document quality alterations during the storage period, such as temperature changes or interruptions in the cold chain, are rapidly coming into use. Active packaging is also being used as security features in the form of labels that track manipulation or misuse of the product prior to its sale.

## 7.2 Modified Atmosphere Packaging (MAP)

Food preservation technology accounts for two main factors of ever increasing importance, extending product life and reducing the amount of additives used. MAP allows for these demands to be met. MAP involves modifying the atmosphere surrounding the product inside the package. This in turn allows chemical, enzymatic, or microbiological reactions to be controlled and therefore reduces or eliminates the main processes of deterioration in the product. The package usually has a low permeability to gas, so that the initial concentrations of the added gases remain unchanged after the package is sealed.

MAP can be used to extend the shelf-life of many fruit and vegetables. Most fruit and vegetables age less rapidly when the level of oxygen in the atmosphere surrounding them is reduced. This is because the reduced oxygen slows down the respiration and metabolic rate of the products and therefore slows down the natural aging process. Elevating the level of carbon dioxide to levels of 2% or more can also be beneficial. Elevated carbon dioxide levels can reduce the product's sensitivity to ethylene and can also slow the loss of chlorophyll. High carbon dioxide can also slow the growth of many of the post-harvest fungi that cause rot. All these effects can help to extend the storage and shelf-life of fresh produce (Jobling, 2001).

## 7.3 Controlled Atmosphere Packaging (CAP)

The major difference between CAP and MAP is that the concentrations of the gases in a MAP package may change after sealing, as a result of the use of oxygen and the expelling of carbon dioxide by microbes and from the slightly permeable nature of the package. In a CAP package, the gas concentrations do not change during storage. To achieve this, the use of a gas impermeable package, such as metal or glass is preferred, and also provides a way of controlling the atmosphere inside the package.

## 7.4 Intelligent Packaging

The stakes in food cold chains are high and the loss of a trailer of food because of improper handling or transport is measured in hundreds of thousands of dollars. Because of the financial pressure and increasing regulatory demands for better record

keeping resulting from the Bio-terrorism Act, suppliers and logistics service providers are turning to systems that combine radio frequency identification (RFID) with temperature and humidity sensor.

RFID is an age-old technology, which has recently realized its potential in supply chain systems. Traditional supply chain management systems produce information regarding “transactions” (orders, shipments, payments) and “location” (warehousing, traffic, inventory). However, perishable goods also require information regarding their “condition” (time, temperature) as they change in value while in the supply chain. RFID promises to provide real time tracking of goods while in transit, thereby providing a clearer picture of the distribution environment.

With mandated use of this technology by major suppliers to industry giants such as Wal-Mart, Albertsons, and Tesco, this technology is already being adopted in the consumer goods supply chains. With standardization and reduced costs, this non-contact technology is set to be as commonplace as barcodes.

## 8. TRENDS IN PROTECTIVE FOOD PACKAGING OF 2000 AND BEYOND

The following discusses some food packaging trends and damage reduction trends in food packaging (Figures 25.13, 25.14, and 25.15).

### 8.1 Food Packaging Trends

This is a broad overview of major packaging changes that have occurred in recent years and are playing a dominant role in food packaging. Although the general transition to plastics replacing glass and metal as primary packaging materials continues, the



Figure 25.13 A packed CCF tray with four clamshell containers.



**Figure 25.14** *A pallet load of grapes being protected until shipment.*



**Figure 25.15** *Palletized loads of grapes being prepared for shipment.*

more recent and revolutionary introduction of bio-based and bio-degradable plastic materials continues to lead. Innovations are worked on every day, leading the effort in specialty coatings directly on food products to enhance shelf-life and quality aspects such as texture, aroma, and flavor. In addition, the US market continues to develop more cost effective packaging methods for palletized quantities led by club stores such as Costco Inc. and Sam's Club (WalMart Stores Inc.). These concepts significantly

reduce the amount of secondary and tertiary packaging as compared to retailers that display merchandise on store shelves. Some key primary packaging evolutions of recent times are:

1. *Stand-up pouches replacing metal cans:* High barrier foil laminated or metalized flexible packaging continues to replace metal cans. Multilayer plastics in flexible pouches are replacing traditional paperboard juice boxes. Examples include tuna fish introductions by Star Kist and CapriSun fruit juice for young children (Figures 25.16 and 25.17).
2. *Plastic bottles replacing glass bottles:* There is a continuous shift in the beverage industry from glass to plastic bottles. Most blow-molded plastic bottles can be made in-house and reduce dependency on external suppliers and shrink the supply chain. Also using shrink sleeve labels, multiple product lines can be filled in the same blow-molded bottle without major changeovers. Glass bottles are still holding their competition for high value and premium beverage launches. Shaped primary packages are easy to produce with plastic and provide new product launches with shorter lead times and provide market share in a competitive environment. Heinz used this to launch specialty ketchups and sauces for children (Figure 25.18).
3. *Convenience for on-the-go food packages:* The US customer continues to accept launches of packaging that provides convenience while driving, and can be placed in cup holders in automobiles (Figure 25.19). Products range from snack foods, cereal with milk, and salads. An example range is Frito Lays Inc., who offer a range of snack foods in blow-molded plastic bottles with shrink labels that fit automotive cup holders and allow consumption while driving. These replace the traditional bag and pouch.



Figure 25.16 Stand-up pouch and juice box.



Figure 25.17 Flexible pouch and metal can packaging for seafood.



Figure 25.18 Some plastic ketchup bottle forms.

4. *Clear plastics packaging:* The consumer continues to demand more aesthetically pleasing containers for food packaging. Product visibility plays a key role from bagged salads, to fresh produce in thermoformed containers, to spices. However, the gas transmission requirements for these plastics vary from extremely high barrier in the case of spices to low barrier for salads. The customer wants more visibility of the actual product being purchased (Figures 25.20 and 25.21).



Figure 25.19 Convenience driven snack food packaging.

## 8.2 Damage Reduction Trends

The various innovations and trends discussed in the previous section all lead to a reduction of damage in shipment. Protection (physical and chemical) is an underlying function of a package, and generally all package improvement and changes will usually result in reduction of damage as protection is increased. In addition, there are some key changes that clearly can help reduce damage beyond the primary package change.

Use of good quality pallets is the key to reducing damage to both rigid and flexible primary packages. The most widely used pallets to distribute food products, both fresh and processed, are made of wood. Low quality lumber, protruding nails, insufficient deck or base coverage, moisture content, and infestation are all factors that can lead to damage of food products and packages when shipped on wooden pallets. For this reason most retailers use reusable plastic pallets in downstream shipping between distribution centers to stores. An alternative to a single-use wooden pallet is a high quality wooden pallet that can be leased and reused. These are often an economically better choice but also offer additional benefits because of the high quality construction.

Today, most companies leasing wooden pallets to the food industry (CHEP USA Inc.) offer a picture-frame bottom section and a large percentage of the top deck covered with deck-boards to reduce damage from stacked products and packages. Also these are true four-way entry block style pallets that can be easily handled with fork trucks and pallet jacks. Reduced handling results in lower damage compared to products on conventional stringer pallets. In addition to the quality of pallets, the placement of products on pallets is critical. Both under-hang and over-hang can greatly affect the load transfer in stacked loads and thereby result in damage. Use of slip sheets



Figure 25.20 Vine ripe tomatoes in a biodegradable PLA plastic thermoformed container.



Figure 25.21 Bagged salads with brand identity in see-through packaging.

to distribute load among layers and the pallet surface is a common way to address these issues.

The unitization method of loads on a pallet is also critical. Appropriate shrink wrap, stretch wrap, banding, netting, gluing, and strapping are all choices that need to be examined for specific product and packaging needs. Use of corner posts and top caps can reduce damage in case-less palletized loads designed for club store shipments.

Most of these issues and potential solutions should be addressed using lab-based accelerated test evaluations. The use of test methods developed by the American Society of Testing and Materials and the International Safe Transit Association allow users to conduct pre-shipment tests on palletized configurations to simulate different distribution methods from truck load to less than truck load (LTL) to single parcel

shipments. It is important to test a few pallets of the product and identify damage reduction solutions, rather than launch a massive new product in a retail distribution and be subject to a major recall or loss.

## REFERENCES

- Abbott, D.A., 1989. *Packaging Perspectives*. Kendall/Hunt Publishing Co., Dubuque, IA.
- American Plastics Council (APC), 2005. The many uses of plastics. Retrieved May 17, 2005. Available from: <<http://www.americanplasticscouncil.org>>.
- Association of Plastics Manufacturers in Europe (APME), 2001. Insight into consumption and recovery in Western Europe.
- Barry, C., 2003. Seafood packaging nets innovation: a swelling tide of progressive packaging is setting the stage for a seafood revolution. *Food Drug Pack* 67 (9). Retrieved August 28, 2005 from Factiva database.
- Beverage Machines Magazine, 2006. Active and Intelligent Packaging. Retrieved March 6, 2006. Available from: <<http://www.trpackaging.com/packaging/news.nsf/0/ACF6FFB8FC5118BAC1256BBF0050FE1C?OpenDocument>>.
- Boyette, M.D., Sanders, D.C., Rutledge, G.A., 1996. *Packaging Requirements for Fresh Fruits and Vegetables*, Published by the North Carolina Agricultural Extension Service. Retrieved March 2, 2005. Available from: <<http://www.bae.ncsu.edu/programs/extension/publicat/postharv/ag-414-8>>.
- Butler, P., 2001. Smart packaging—intelligent packaging for food, beverages, pharmaceuticals and household products. *Mat. World* 9 (3), 11–13.
- Christopher, B., 2003. Seafood packaging nets innovation: a swelling tide of progressive packaging is setting the stage for a seafood revolution. *Food Drug Pack* 67 (9). Retrieved August 28, 2005. Available from: Factiva database.
- The Clemson University Cooperative Extension Service, Starting a Food Business: Product, Process, and Packaging Analysis and Development, White Paper, March 2002.
- The Corrugated Packaging Alliance (N.D.) Corrugated basics. Retrieved March 22, 2005 <<http://cpc.corrugated.org/Basics>>.
- FEFCO. 2000. White Paper, Fresh foods under the microscope: The transit outer packaging for short shelf-life foods in Europe.
- Fibre Box Association (N.D.). Informational Brochure. Retrieved March 10, 2005. Available from: <[http://www.fibrebox.org/Info/docs/CCF\\_Brochure.pdf](http://www.fibrebox.org/Info/docs/CCF_Brochure.pdf)>.
- Food and Agriculture Organization of the United Nations (FAO), 1989. *Prevention of Post-Harvest Food Losses Fruits, Vegetables and Root Crops: A Training Manual*.
- Gawith, J.A., Robertson, T.R., 2000. Wrapping Up Packaging Technology. *J. Home Econ. Inst. Australia* 7, 6–14 (Telecom Technology Education Conference, Macquarie, ACT).
- Harper, R., 2004. Test proves compatibility of unlike containers. *Supermarket News* Retrieved March 9, 2005, from Factiva database.
- Hormel, N.D., Processed Foods: Safe, Convenient, and Nutritious, Retrieved September 1, 2005. Available from: <<http://www.hormel.com/templates/knowledge/knowledge.asp?catitemid = 4&id = 271>>.
- Jobling, J., 2001. Modified atmosphere packaging: not as simple as it seems. *Good Fruit Veg. Mag.* 11 (5).
- Major M. Supermarket Fresh Food Business: Plastic and Corrugated Find a Fit, *Progressive Grocer*. Retrieved March 9, 2005, from Factiva database, 2003.
- Department of Trade and Industry. Packaging (Essential Requirements) Regulations, Government Guidance Notes (S. I. 2003 No. 1941) February 2004.
- Paperboard Packaging. Sam's Club Adopts Footprint Standard, Retrieved March 9, 2005, from Factiva database, 2002.
- Paperboard Packaging. Europe, U.S. Share Compatible Footprint Standards, Retrieved March 9, 2005, from Factiva database, 2000.
- Reduce Packaging, (n.d.) <<http://www.reducepackaging.com>> (accessed 12.11.05.).



- Reusable Pallet and Container Coalition (RPCC), 2005. Study Shows RPCs Reduce Environmental Burdens, Retrieved March 10, 2005. Available from: <<http://www.rpcc.us/>>.
- Robertson, G.I., 1993. *Food Packaging Principles and Practice*. Marcel Dekker Inc., New York.
- Sacharow, S., 1980. *Principles of Food Packaging*, second ed. the AVI Publishing Company, Inc., Westport, CT.
- Salvage, B., 2005. Case-ready penetration: although not at volume proponents predicted years ago, case-ready red meat continues growth expansion. *Nat. Prov.* 8 (6), 13.
- Singh, S.P., Singh., J., 2005. Pictorial markings and labels for safe transport and handling of packaged goods. *Pack. Tech. Sci.* 18 (3), 133–140(8).
- Soroka, W., 2002. *Fundamentals of Packaging Technology*, third ed. Institute of Packaging Professionals.
- United Nations, 1969. Packaging and packaging materials with special reference to the packaging of food, Food Industry Studies Number 5.
- Zind, T., 2003. RPCs and Corrugated Vie for Favor of Produce Shippers and Supermarkets, Retrieved March 9, 2005, from Factiva database, 2003.

Note: Page numbers followed by “f” and “t” denote figures and tables respectively.

## A

- Absorbance, 383
- 2-acetyl-1-pyrroline (ACPY), 237
  - production, 237–238
- Acrylamide, 60
- Aflatoxins, 20
- Aging of grains, artificial, 233–235
  - steam chambers, 235–237
- Agitated film evaporators, 347
- Agricultural Marketing Service (AMS), 25, 29
- Agricultural waste management, 619, 652–659
  - biological processes, 639–650
    - acidogenesis, 644–645
    - activated sludge processes, 641
    - aerated lagoon, 642
    - aerobic processes, 639–649
    - anaerobic contact reactor, 648–649
    - anaerobic processes, 642–643
    - anaerobic sequencing batch reactor (ASBR), 648
    - composting processes, 649–650
    - continuously stirred tank reactor (CSTR), 649
    - hydrolysis and liquefaction, 644
    - induced blanket reactor (IBR), 646–648
    - methanogenesis, 645
    - reactor designs, 645–646
    - rotating biological reactors, 641–642
    - trickling filters, 641
    - up-flow anaerobic sludge blanket (USAB) reactor, 646
  - bioprocess technology, 652–659
    - bio-energy recovery, 653–656
    - chemical production, 657–658
    - fuel-ethanol production, 657
    - hydrogen recovery, 654–656
    - immobilized cells, 659
    - methane recovery, 654
    - pyrolysis and gasification, 654
    - reuse of effluent as resource, 653
      - single-cell protein and biomass, 659
  - common treatments, 621–623
    - activated sludge processes, 622
    - aerated lagoons, 621–622
    - anaerobic lagoons, 622
    - chemical methods, 622
    - disinfection, 623
    - dissolved air flotation (DAF), 621
    - land application, 621
    - membrane processes, 622
    - rotating biological discs, 623
    - sedimentation, settling and chemical precipitation, 621
    - stabilization ponds, 621
    - trickling filters, 622–623
  - land treatment
    - land application, 650–651
    - landfill bioreactors, 652
    - landfilling, 651–652
  - physical–chemical treatment
    - process, 628–639
      - carbon adsorption, 637–638
      - chemical precipitation, 634
      - chlorination, 635–636
      - coagulation and flocculation, 633–634
      - disinfection, 634–637
      - filtration, 631–632
      - flotation, 630–631
      - ion exchange, 638
      - membrane processes, 638–639
      - ozonation, 636
      - reverse osmosis, 639
      - screening, 628–629
      - sedimentation, 629–630
      - ultrafiltration, 638
      - ultraviolet radiation, 636–637
  - waste characteristics, 623–628
    - brewery and distillery waste, 627–628
    - dairy processing waste, 624–626
    - fruit and vegetable processing waste, 627

- Agricultural waste management (*Continued*)
    - meat, poultry and seafood processing waste, 626
  - Air blast tunnels, 367–368
  - Air cart, 99, 100*f*
  - Air delivery system, 96–97, 96*f*
  - Air flotation, 631
  - Air seeders for conservation tillage crop production
    - commercial options, 101
    - crop residue, managing, 89–93
    - depth control and packing, 97–98
    - energy requirements, 101
    - opener design options, 87–88
    - precision agriculture, 99–100
    - seed/fertilizer placement, row spacing, 94–97
    - soil disturbance and environmental impacts, 93–94
    - varying conditions, 98–99
  - Air separation of grain, 164–165
  - Airlift pumps, 602–604, 605*f*, 606*f*
  - Alcoholic beverages, processing regulations, 30
  - Amino acids in fruit and vegetables, 267
  - Amylopectin, 264
  - Amylose, 264
  - Anaerobic contact reactor, 648–649
  - Anaerobic sequencing batch reactor (ASBR), 648
  - Analog level measurement methods, 520–523
    - capacitance, 522–523
    - differential pressure, 523
    - non-contact ultrasonic, 521
    - RADAR, 521
    - reflective methods, 520–521
    - time domain reflectometry (TDR), 522
    - weight, 523
  - Animal and Plant Health Inspection Service (APHIS), 26
  - Anthocyanins, 266
  - Apparent viscosity, 408
  - Artificial Neural Network (ANN), 467
    - basics, 467–468
      - hidden layers and nodes, 468
      - learning rate and momentum, 468
    - examples, 468–469
    - meatball cooking example, 469–472
      - hidden layers and nodes, 471–472
      - learning rate and momentum, 472
      - network training and testing, 471
      - neural network model, 470
      - performance, 472
  - Ascorbic acid, 267–268
  - Automated guided vehicles (AGV), 457
  - Automatic cluster removers (ACRs), 196–197
- B**
- Barracks, 629
  - Batch dryers, 331
  - Batch pasteurizer for milk, 203–204, 203*f*
  - Belt conveyors, 158–161
    - cross-sectional areas and maximum speeds, 157*t*
  - Belt dryers, 334
  - Belt freezers, 368–369
  - Benzoates, 277
  - Betalains, 266–267
  - Beverages
    - alcoholic, 30
    - bottled water, 31
    - carbonated, 30
    - fruit and vegetable juices, 32
    - milk and milk products, 32–33
    - pasteurization, 33–34
  - Bin flow patterns, 134*f*, 135
  - Bingham plastic fluids, 410
  - Bins, storage. *See under* Grain storage systems
  - Biosensors, 54–55
    - common transducers, 54
  - Biot number, 363
  - Bottled water, processing regulations, 31
  - Bucket elevators, 158–161
  - Bulk density of grain, 124–125
  - Butter manufacturing, 218–219
  - Byproducts of processing, 59–60
    - acrylamide, 60
    - 3-monochloropropanediol, 60
- C**
- Cacao processing, 292–298
  - Canned foods
    - fruit and vegetables, 282–283
    - processing regulations, 34–35
  - Capillary flow, 328–329
  - Carbonated beverages, processing regulations, 30

- Carotenoids, 266
  - Case hardening, 341
  - Cauchy strain, 404–405
  - Cellular automata (CA), 171
  - Cellulose, 269
  - Centrifugal milk separator, 201–202, 201*f*
  - Centrifugal pumps, 600–602, 601*f*
  - Cheese manufacturing, 219–220
  - Chemical interventions
    - other interventions, 49–50
    - ozone, 48–49
  - Chlorine dioxide, 49
  - Chlorogenic acid, 263–264
  - Chlorophyll, 265–266
  - Chromogenic microbiological media, 52
  - Chutes, 163
  - Clear plastics packaging, 716
  - Climacteric fruit, 269–270
  - Coagulation, 633–634
  - Code of Federal Regulations (CFR), 15
  - Coefficient of friction between grain and bin walls, 124–125
  - Commercial options, 101
  - Compression sedimentation, 630
  - Computer controller, 100, 100*f*
  - Computer integrated manufacturing (CIM), 476–478
  - Conduction–convection rotary dryer, 224–226
  - Conical grain bins
    - flat storage, 139–142
      - geometry, 140*f*
      - stresses, 141*f*
  - Conical grain bins, 139
  - Continuous dryers, 333–334
  - Continuous flow grain dryers, 128–129, 128*f*
  - Continuous pasteurizer for milk, 205
  - Continuously stirred tank reactor (CSTR), 649
  - Control valves, 533–534
    - ball control valves, 534
    - linear stem control valves, 533
    - rotary shaft control valves, 534
  - Controlled atmosphere storage, 273–274
  - Controlled-release packaging (CRP), 57
  - Conveyors, belt, 158–161
    - cross-sectional areas and maximum speeds, 157*t*
  - Conveyors, pneumatic, 161–163
  - Conveyors, screw, 154–156
  - Coriolis mass flow meter, 526
  - Corn
    - equilibrium relative humidity, 126–127
    - static coefficient of friction, 142*t*
  - Corn heads, 107–109
  - Corrugated common footprints (CCFs), 699–700
  - Creep tests, 421–422
  - Critical control points (CCPs), 23–24
  - Crop residue, managing, 89–93
  - Cryogenic freezers, 371–372
  - Current Good Manufacturing Practices (cGMP), 18–20
  - Cutterbars, 106
- D**
- Dairy products, 199–200. *See also* Milking systems
    - butter manufacturing, 218–219
    - cheese manufacturing, 219–220
    - clarification, separation and standardization, 200–202
    - drying, 213–216
    - evaporation, 212–213
    - homogenization, 209–211
    - ice cream manufacturing, 216–218
    - membrane processing, 211–212, 212*f*
    - pasteurization, 202–208
      - UHT sterilization, 208–209
  - Deborah number, 406–407
  - Defect action level (DAL), 19–20
  - Defrosting
    - meat and fish, 562–564
  - Degree of milling (DOM), 246–247
  - Dehydration of foods, fruit and vegetables, 283–284
  - Depth control and packing, 97–98
  - Design of equipment and utensils, 19
  - Differential GPS (DGPS), 77
  - Differential pressure, 527–528
  - Diffusion coefficient for gases, 329
  - Disc openers, 87–88, 88*f*, 90, 95*f*
  - Disc separators for cleaning grain, 165
  - Discrete element simulation (DES), 171
  - Discrete level measurements methods, 519–520
    - conductivity/capacitance probes, 519–520
    - contact ultrasonic, 520
    - float switch, 519
    - turning fork, 520
  - Discrete particle sedimentation, 629
  - Dissolved air flotation, 630–631

- DNA probes, 53
- Dry extruders, 433
- Drying of foods, 317, 323–329, 352–353
- dryer types, 329
    - batch dryers, 331
    - belt dryers, 334
    - continuous dryers, 333–334
    - drum dryers, 336
    - fluidized bed dryers, 334, 335*f*
    - freeze dryers, 339–340
    - hot air dryers, 329–330
    - impingement dryers, 334
    - osmotic dryers, 338–339
    - puff dryers, 335
    - rotary dryers, 331–332
    - solar dryers, 330–331
    - spray dryers, 336–338
    - tunnel dryers, 333–334
    - vacuum dryers, 332–333
  - drying curves and drying mechanisms, 325–329
  - evaporation, 342–344
    - agitated film evaporators, 347
    - falling film evaporators, 346
    - multi-effect evaporators, 350–351
    - pan and batch evaporators, 344–345
    - quality changes, 352
    - rising–falling film evaporators, 346–347
    - rising film evaporators, 345
    - short tube evaporators, 345
    - single effect evaporators, 348–350
  - mechanical vapor recompression (MVR), 351–352
  - psychrometrics, 324–325
  - quality changes, 340–342
  - stability and moisture content, 321–323
    - moisture isotherms, 321*f*
- Drying of grains, 223–227
- fluidized bed dryers, 226–227
  - on-farm drying, 223–226
    - conduction–convection rotary dryer, 224–226
  - storage, 126–127
    - classification of dryer types, 127–129
    - equilibrium moisture content, 126–127
    - theory and simulation of drying, 129–132
- Dual media filters, 632
- Duhring charts, 343*f*
- Dynamic accuracy, 504
- E**
- Educational requirements for food engineers, 2–5
- Eggs, 26–27
  - egg products, 27
- Elevators, 116
- Elevators, bucket, 158–161
- Emissance of radiant heat, 383
- Energy requirements, 101
- Enzyme-linked immunosorbent assays (ELISA), 53–54
- Ethylene, 269–271
- Expansins, 271
- Export foods, regulation, 35–36
- F**
- Falling film evaporators, 346
- Fanning mills for cleaning grain, 164–165, 164*f*
- Farm machinery automation, 67–68, 83–84.
  - See also* Grain harvesting machinery; Grain storage systems
- challenges facing autonomous vehicles, 81–83
  - liability, 83
  - safety considerations, 81–83
- guidance methods, 75–81
  - comparison of various techniques, 76*t*
  - crop feelers, 80
  - dead reckoning, 79–80
  - furrow following, 70*f*, 80–81
  - Global Positioning System (GPS), 76–78
  - inertial, 80
  - machine vision, 78–79
- implement guidance systems, 75
- vehicle guidance systems, 68–75
  - guidance strategies, 71–75
- Fats and oils in fruit and vegetables, 268
- FDA sanitation programs, 18–20
- Federal Register, 14–15
- Fermentation of cacao, 293–295
- Ferulic acid, 265
- Fick's First Law, 383
- Fick's Second law, 131–132, 384
- Finite element analysis, 171
- Flat-storage systems, 139–142
  - classification of bins, 145*t*
  - geometry, 140*f*
  - shallow, and deep bins, 144–145
  - stresses, 141*f*
- Flavonoids, 266

- Flavor compounds in fruit and vegetables, 265
- Flexible pouch packaging
  - sterilization, 242
- Flexible pouch packaging, 239–240
- Flocculant sedimentation, 630
- Flocculators, 633–634
- Flow Diversion Device (FDD), 206–207
- Flow properties of grain, testers
  - classification, 166
  - examples, 166–169
- Flow properties of grain, testers, 165–171
- Fluidized bed dryers, 226–227, 334, 335*f*
- Fluidized bed freezers, 369–370
- Flumes, 136
- Food and Drug Administration (FDA), 13–14
  - HACCP requirements, 22–24
- Food engineer, 9–10
  - academic training, 2–5
  - employment opportunities, 5–9
    - example job descriptions, 5–9
  - future prospects, 9–10
  - role, 1–2, 5–9
  - skills required, 1–2
- Food extruders, 427
  - information for extrusion technology, 439
  - role, 429–430
  - types of, 431–439
    - dry extruders, 433
    - interrupted flight extruders, 433–436
    - new generation extruders, 436
    - single, segmented screw extruders, 432
    - twin screw extruders, 436–439
  - typical components of, 430–431
    - delivery systems, 430
    - extruder barrel, 431
    - knife assembly, 431
    - preconditioner, 430–431
- Food safety engineering, 43–44, 61
  - byproducts of processing, 59–60
    - acrylamide, 60
    - 3-monochloropropanediol, 60
  - control/monitoring/identification
    - techniques, 52–57
  - biosensors, 54–55
  - chromogenic microbiological media, 52–54
  - Fourier Transform infrared (FT-IR)
    - spectrometry, 55–57
    - molecular and immunological assay
      - methods, 52–54
  - intervention technologies, 44–51
    - chemical interventions, 48–50
    - hurdle approach, 51
    - novel non-thermal techniques, 44–48
  - packaging applications, 57–58
    - active packaging, 57
    - intelligent or smart packaging, 58
    - tamper evident packaging, 58
- Food Safety Inspection Service (FSIS), 13–14
  - HACCP requirements, 22–24
  - meat processing, 24–26
- Food Safety Modernization Act, 20–22
  - imports, 22
  - inspection and compliance, 21
  - preventive controls, 20–21
  - response, 21
- Food service establishments, regulation, 35
- Fourier Transform infrared (FT-IR) spectrometry, 55–57
  - common frequencies, 56*t*
- Fourier's Law, 381
- Freeze drying, 339–340
- Freezing of foods, 355–356
  - developments
    - dehydrofreezing, 375–376
    - high pressure freezing, 375
  - effects on foods, 372–375
    - constituents, 373–374
    - food physical properties, 372–373
    - thermal properties, 374–375
  - energy conservation, 376
  - equipment, 364–372
    - air blast tunnels, 367–368
    - belt freezers, 368–369
    - cryogenic freezers, 371–372
    - fluidized bed freezers, 369–370
    - immersion freezers, 370–371
    - impingement freezers, 370
    - plate freezers, 365–366
    - scraped surface freezers, 367
    - still air freezers, 367
  - freezing time estimations, 361–364
    - factors, 362–363
    - Plank's equation, 362
    - Plank's equation, modified, 363–364
  - fruit and vegetables, 284

- Freezing of foods (*Continued*)
    - future developments, 376
    - ice cream, 217–218
    - phase change and ice crystal formation, 359
    - process, 356–359
    - product heat load, 360–361
  - Freezing point depression, 356
  - Fructose, 263
  - Fruit and vegetables
    - background considerations
      - location of processing operation, 260
      - processing systems, 260–261
      - suitability for processing, 260
    - biological deterioration and control, 269–272
    - cacao processing, 292–298
    - chemical composition
      - amino acids, 267
      - fats and oils, 268
      - flavor volatiles, 265
      - minerals, 268
      - organic acids, 263–264
      - phenolic components, 264–265
      - pigments, 265–267
      - proteins, 267
      - starch, 264
      - sugars, 263
      - vitamins, 267–268
      - water content, 263
    - equipment specifications, 308–309
    - fruit development, 262–263
    - juice processing, 286–292
      - clarification, 289–290
      - diffusion treatment, 291–292
      - enzyme liquefaction, 290–291
      - mechanical pressing, 287–288
      - pulp enzyming, 290
      - regulations, 32
    - minimal processing, 298–301
    - packaging, 699–701
      - CCFs, 699–700
      - RPCs, 701
    - processing methods
      - canning, 282–283
      - dehydration, 283–284
      - freezing, 284
      - semi-processing, 284–285
      - sugar preservation, 285–286
    - processing units
      - basic services, 305
      - general flow plan, 305
      - installation and operation, 304–305
      - other facilities, 308
      - preliminary studies, 303–304
      - processing room, 307
      - raw material reception, 305–307
      - sanitary facilities, 308
      - storerooms, 307
    - properties, 261–269
    - quality control/assurance, 301–303
      - HACCP, 303
      - laboratory facilities, 307
      - traceability, 303
    - reducing deterioration, chemical
      - methods, 276
      - acidification, 277–280
      - benzoates, 277
      - parabens, 277
      - sorbates, 277
      - sugar concentration, 280
      - sulfur dioxide, 276
    - reducing deterioration, physical methods,
      - 272–274
      - disinfestation treatments, 274–275
      - modified atmospheres, 274
      - storage, 275–276
      - water activity manipulation, 276
    - reducing deterioration, treatments
      - heat, 280–281
      - irradiation, 281–282
    - regulations, 29
    - structural features, 269
  - Fumigation of grain, 229
- G**
- Gamma irradiation, 230
  - Gauge wheels, 97–98, 98f
  - Gelatinization, 235
  - Gelatinization enthalpy of rice, 234
  - Global Positioning System (GPS), 68–78
  - Glucose, 263
  - Glucosinolates, 268
  - Goniometer, 423, 423f
  - Grain cleaning, 163–165
    - cleaning shoe, 114–115
    - separation techniques, 112–114
    - straw walkers, 112–114

- Grain harvesting machinery, 103. *See also* Farm machinery automation; Grain storage systems
- cleaning shoe, 114–115
  - cylinder threshing and concave, 109–111
  - elevators, 116
  - feederhouse, 109
  - field performance, 119–120
  - gathering heads, 106–109
  - grain bin and unloading auger, 116–117, 117*f*
  - grain damage, 120
  - historical perspective, 103–104
  - operator's station and monitoring systems, 118–119
  - other attachments, 118
  - performance factors, 105
  - pre-harvest design criteria, 104–105
  - rotary threshing and concave, 111–112
  - separation techniques, 112–114
- Grain process engineering, 223
- cooking
    - quick cooking brown rice (QCBR), 242–246
    - retort packaging, 239–242
  - drying, 223–227
    - fluidized bed dryers, 226–227
    - on-farm drying, 223–226
  - post-harvest value additions
    - aroma enhancement of milled rice, 237–239
    - artificial aging, 233–235
  - pre-storage grain treatments
    - insect damage, 228
  - quality evaluation
    - image analysis, 246–247
    - texture of cooked rice, 247–251
- Grain quality, 249–250
- Grain storage systems, 123. *See also* Farm machinery automation; Grain harvesting machinery
- chutes, 163
  - cleaning of grain, 163–165
  - codes, 126
  - conical grain bins, 139
    - classification of bins, 145*t*
    - flat storage, 139–142
    - flat storage, shallow, and deep bins, 144–145
    - Janssen's equation, 142–144
    - loads on hoppers, 146–148
    - static coefficients of friction, 142*t*
  - drying
    - classification of dryer types, 127–129
    - equilibrium moisture content, 126–127
    - purpose, 126–127
    - theory and simulation of drying, 129–132
  - flow property testers, 165–171
    - classification, 166
    - examples, 166–169
  - grain handling, 153–165
    - belt conveyors, 158–161
    - bucket elevators, 158–161
    - pneumatic conveyors, 161–163
    - screw conveyors, 154–156
  - management factors, 125–126
  - materials, 124–126
  - physical properties of grains, 124–125
  - seismic loads, 151–153
  - snow and wind loads, 148–151
    - force coefficients for round grain bins, 150*t*
    - pressure coefficients for components and cladding, 150*t*
    - pressure coefficients for conical bin roofs, 151*t*
  - stresses in granular materials, 136–137
  - structural loads, 132–153
    - eccentric discharge of grain, 135
    - flumes, 136
    - loads caused by grain, 134–135
    - temperature cables, 137–138
    - thermal loads and moisture-induced loads, 138
- Grains, physical properties, 124–125
- Granular materials, modeling of, 169–171
- Gray surfaces, 383
- ## H
- Hair pinning, 87–88, 89*f*
- Hazard Analyses and Critical Control Point Program (HACCP), 22–24
  - prerequisite programs, 23–24
- Head rice yield (HRY), 246–247
- Heat transfer, 379–384
  - conduction, 381–382
  - convection, forced, 382
  - convection, free, 382–383
  - drying and frying, 389–392
  - microwave thawing of frozen meat, 393–397
  - theoretical analysis, 394–397, 398*f*



- Heat transfer (*Continued*)  
 radiation, 383  
 thermal sterilization, 384–389  
   simulation of a horizontal can, 388  
   simulation of a pouch, 388–389  
   simulation of a vertical can, 386  
   simulation of bacterial deactivation, 387  
   simulation of vitamin destruction, 387–388
- Hermetic storage, 230–231
- Herschel–Bulkley fluids, 410
- Herschel–Bulkley model, 408, 409*f*
- High hydrostatic pressure (HHP) processing, 44
- High pressure processing (HPP), 44–45  
   applications, 46*t*
- High temperature–short time (HTST)  
   pasteurization, 204–205  
   ice cream, 216–217
- Hindered (or zone) sedimentation, 630
- Hitch guidance technology, 92
- Hoe openers, 87, 88*f*, 89*f*
- Homogenization of milk, 209–211
- Hooke's Law, 405–406
- Hookian solids, 418–420
- Hoppers, loads on, 146–148
- Horticultural crops. *See* Fruit and vegetables
- Hot air dryers, 329–330
- Hurdle approach to food safety, 51
- I**
- Ice cream manufacturing, 216–218
- Image analysis of grains, 246–247
- Immersion freezers, 370–371
- Immunological assay methods, 52–54  
   enzyme-linked immunosorbent assays  
     (ELISA), 53–54
- Impact pressure within chutes, calculating, 163
- Impingement dryers, 334
- Impingement freezers, 370
- Imported foods, regulation, 37–38
- Induced blanket reactor (IBR), 646–648
- Industrial sectors employing engineers, 9
- Insect damage of grain, 228  
   chemical fumigation, 229  
   gamma irradiation, 230  
   heat treatment, 229  
   modified atmospheres, 230–232  
     combined with increased temperature, 232  
     combined with low temperature, 232  
     high carbon dioxide, 231–232  
     low oxygen, 230–231  
     pressurized carbon dioxide, 232–233
- Intelligent packaging, 58
- Interfacial dilatational rheology, 423–424
- Interfacial rheology, 422–425
- Interfacial shear rheology, 424–425
- Internal angle of friction for grain, 124–125
- Interrupted flight extruders, 433–436
- Intervention technologies, 44–51  
   applications, 50*t*  
   chemical intervention  
     other interventions, 49–50  
     ozone, 48–49  
   novel non-thermal techniques, 44–48  
     High Pressure Processing (HPP), 44–45  
     irradiation, 47  
     pulsed electric field (PEF) processing, 45–46  
     ultraviolet disinfection, 47–48
- Irradiation of foods, 47, 281–282
- J**
- Jams, 285
- Janssen's equation, 124–125, 142–144
- Jellies, 285
- Jenike's shear cell, 166–169
- Jet pumps, 602–604, 605*f*, 606*f*
- Johanson indicizer, 165–166
- Juice processing, 286–292  
   clarification, 289–290  
   diffusion treatment, 291–292  
   enzyme liquefaction, 290–291  
   mechanical pressing, 287–288  
   pulp enzyming, 290
- K**
- Knudsen diffusion, 329
- L**
- Legislation applicable to food industry.  
   *See* Regulation of food industry
- Lethality of processes, 461
- LIDAR systems, 82
- Linear viscoelasticity regime (LVR), 417–418
- Liquefaction enzymes, 290
- Loads, structural aspects, 132–153  
   eccentric discharge of grain, 135  
   flumes, 136

loads caused by grain, 134–135  
 Logic wire diagrams, 482  
 Low-Acid Canned Food (LACF) program, 28  
 Lycopene, 266

## M

Magnetic flow meter (“Mag” meter), 524  
 Maillard reaction, 60  
 Malic acid, 263  
 Market demographics, 575  
 Marmalades, 286  
 Mass transfer, 379–384  
   convection, 384  
   diffusion, 383–384  
 Material other than grain (MOG) separation, 103,  
   112–114  
   disposal, 118  
 Maxwell model, 421  
 Mealiness of fruit, 271  
 Meat  
   composition, 547–549  
   microwave thawing of frozen meat, 393–397  
     theoretical analysis, 394–397, 398*f*  
   ohmic pasteurization  
     control of extent, 559–560  
     economics, 557–558  
     electricity supply control, 559  
     meat quality, 553–556  
     microbial inactivation, 552–553  
     packaging, 560  
   packaging, 696–697  
     commercial applications, 560–561  
     processing regulations, 24–26  
     thermal methods of preservation, 543–544  
 Meat emulsion products, 551  
 Mechanical vapor recompression (MVR),  
   351–352  
 Mechanically separated meat (MSM), 25–26  
 Membrane processing of milk, 211–212, 212*f*  
 Metal detectors, 689–690  
 Microbial spore inactivation techniques, 51*t*  
 Mid-row banders, 95, 96*f*  
 Milk  
   composition, 200–201  
   processing regulations, 32–33  
 Milk products, processing regulations, 32–33.  
   *See also* Dairy products  
 Milking systems, 177

components, 178–179  
   pipeline systems, 182–183  
   weigh jar systems, 182–183  
 distribution tanks, 186–187  
 main airline, 186  
 milking machines, 178–189  
   milking unit, 179–182  
   pipe systems, 182–187  
   receiver group and milk transfer line, 189  
   vacuum production and control,  
     187–189  
 milking parlors, 189–197  
   construction, 191  
   environmental control, 192  
   flat type, 195  
   herringbone type, 192–193  
   parallel type, 193  
   rotary (carousel) type, 194  
   side open (tandem) type, 194–195  
 milking parlors, additional features  
   animal identification and recording systems,  
     197  
   automatic cluster removers (ACRs),  
     196–197  
   crowd gates, 197  
   entrance/exit gates, 196  
   hygiene, 197  
 pulsator airlines, 186  
 receiver group, 189  
 test ports, 187  
 vacuum gauges, 188–189  
 vacuum production, 187–189  
 vacuum pump, 187–188  
 vacuum regulation, 188  
 Milklines, 182–186  
 Minced meat, 552  
 Minerals in fruit and vegetables, 268  
 Minimal processing, 298–301  
 Mixed media filters, 632  
 Mixers, 633  
 Moisture content. *See* Drying of foods; Water  
 Molecular alloy phase change materials  
   (MAPCM), 57  
 Molecular assay methods, 52–54  
   DNA probe methods, 53  
   polymerase chain reaction (PCR) assays, 53  
 3-monochloropropanediol (3-MCPD), 60  
 Multi-effect evaporators, 350–351

**N**

National Poultry Improvement Plan (NPIP), 26  
 Natural Resource Conservation Service (NRCS),  
 93–94  
 Near infrared (NIR) spectroscopy, 248–249  
 New generation extruders, 436  
 Newman's solutions to Fick's law, 132  
 Newtonian fluids, 406, 409  
 Newton's Law of cooling, 382  
 Newton's Law of viscosity, 405–406  
 Nisin, 51  
 Non-climacteric fruit, 269–270  
 Non-comminuted meat, 551–552  
 Non-meat ingredients, 549–550  
 and lean fat, 550  
 within meat products, 550  
 Nusselt number, 382  
 Nuts, processing regulations, 29

**O**

Ohmic pasteurization, 541  
 basic principles  
 electric circuits, 544  
 electrical conductivity, 546–552  
 electrical field strength, 546  
 mechanism of ohmic heating, 544–546  
 commercial applications, 560–561  
 control of extent, 559–560  
 economics, 557–558  
 electricity supply control, 559  
 future directions, 564  
 meat quality, 553–556  
 microbial inactivation, 552–553  
 for muscle foods, 562–564  
 packaging, 560  
 Opener design options, 87–88  
 Organic acids in fruit and vegetables, 263–264  
 Osmotic drying, 338–339  
 Osmotic pressure, 338–339  
 Ottawa texture measuring system (OTMS), 248  
 Oxalic acid, 263–264  
 Ozone, 48–49

**P**

Packaging for foods, 691  
 food distribution  
 harvesting, 702  
 packing, 702–703

shipping, 703  
 storage and shelf life, 704  
 food product categories  
 meat, 696–697  
 processed versus non-processed, 701–702  
 seafood, 697–699  
 vegetables and fruits, 699–701  
 functions, 691–696  
 communication, 668, 694  
 containment, 667, 692–693  
 protection, 667, 693–694  
 utility, 668, 669*t*, 694–696  
 future trends, 713–719  
 damage reduction, 717–719  
 major causes of spoilage/damage in supply  
 chain, 704–705  
 biochemical spoilage, 704–705  
 chemical spoilage, 705  
 microbiological spoilage, 705  
 microbiological spoilage, 704  
 physical damage, 705  
 materials, 705–711  
 glass, 710–711  
 metals, 709–710  
 paper, 706–707  
 plastic, 707–709  
 safety aspects, 57  
 active packaging, 57  
 intelligent or smart packaging, 58  
 tamper evident packaging, 58  
 tracking and traceability, 58–59  
 smart packaging, 711–713  
 active packaging, 711–712  
 controlled atmosphere packaging (CAP), 712  
 intelligent packaging, 712–713  
 modified atmosphere packaging (MAP), 712  
 Packaging machinery, 667–668  
 canning equipment, 684–686  
 cap application machines, 677–679  
 chucks and clutches, 679  
 chucks-type press-on cappers, 679  
 induction cap sealing, 680–681  
 roller-type press-on cappers, 679–680  
 carton equipment, 687–688  
 filling, 687–688  
 filling machines, 670  
 flexible packaging, 681  
 form-fill-seal equipment, 681–684

- horizontal, 683–684
- thermo-form–fill–seal, 684
- vertical, 682–683
- in-line (rotary) fillers, 676
- in-line fillers, 676
- metal detectors, 689–690
  - typical features, 689–690
- rotary fillers, 676–677
- volumetric fillers, 670–673
  - auger fillers, 673
  - diaphragm fillers, 671
  - piston fillers, 670–671
  - timed flow fillers, 672
- weight fillers, 673–675
  - gross weight fillers, 674–675
  - net weight fillers, 674
- Packer wheels, 97, 97*f*
- Pan and batch evaporators, 344–345
- Parabens, 276–277
- Parallel linkage, 99, 99*f*
- Parlors for milking, 189–197
  - construction, 191
  - design elements
    - animal identification and recording systems, 197
  - automatic cluster removers (ACRs), 196–197
  - crowd gates, 197
  - entrance/exit gates, 196
  - hygiene, 197
  - indexing stalls, 196
- environmental control, 192
- types, 192–195
  - flat, 195
  - herringbone, 192–193
  - para-bone/swing-over, 193–194
  - parallel, 193
  - rotary (carousel), 194
  - side open (tandem), 194–195
- Pasteurization, 33–34
  - of milk, 202–208
- Pasteurized Milk Ordinance (PMO), 33
- Pectin, 285, 287–288
- Pectinases, 289
- Peschl rotational shear tester, 166–169
- Pesticide residues, 20
- Phenolic components in fruit and vegetables, 264–265
- Phosphine, 229
- Phytosterols, 268
- PID control algorithm, 487–491
  - derivative control action, 490–491
  - integral control action, 489–490
  - proportional control action, 487–489
- Pineapples, 270–271
- Plank number, 363–364
- Plank's equation, 362
  - modified, 363–364
- Plant pigments, 265–267
- Plastic bottles replacing glass bottles, 715
- Plate freezers, 365–366
- Platform augers, 107
- Pneumatic conveyors, 161–163
- Polymerase chain reaction (PCR) assays, 53
- Portable data file (PDF), 58
- Positive displacement pumps, 602, 604*f*
- Power-law fluids, 410
- Prandtl number, 382
- Precision agriculture, 99–100
- Preservation of foods. *See* Sterilization and preservation of foods, thermal processing
- Preservatives, 276
- Pressure, 516–518
  - capacitance, 518
  - fiber optic, 518
  - LVDT, 518
  - resistive, 517–518
  - thin film, 518
- Process Authority, 9
- Process control system design, 475
  - actuators
    - control valves, 533–534
    - motors, 531–540
    - pumps, 532
    - valve actuators, 534–537
    - valve selection and sizing, 537–540
  - automation benefits, 475–476
  - automation components and terminology, 478–480
  - computer integrated manufacturing (CIM), 476–478
  - control system objectives, 480–493
    - block diagrams, 484–485
    - closed loop systems, 485–487
    - continuous control, 484
    - discrete control, 481–484
    - feed-forward control, 493

- Process control system design (*Continued*)
- open loop control systems, 491–492
  - PID control algorithm, 487–491
  - predictive control, 492
- controllers, 493–502
- chassis, 496
  - controller programming, 498–500
  - human–machine interface (HMI), 500–502
  - input/output (I/O) terminals, 496
  - memory, 495
  - power supply, 495–496
  - processors, 494–495
  - programming device, 497
- sensors, 502–531
- accuracy and precision, 503–504
  - analog level measurement methods, 520–523
  - bi-metallic strip, 512
  - discrete level measurement methods, 519–520
  - dynamics, 504–505
  - encoder/programmable limit switch, 510–511
  - flow, 523–528
  - infrared radiation, 516
  - integrated circuits, 515
  - level, 518–519
  - linear variable differential transformer (LVDT), 511
  - linearity, 505–506
  - maintenance, 506
  - photocells, 510
  - position, 508
  - pressure, 516–518
  - proximity switches, 509–510
  - RADAR, 511
  - range and resolution, 503
  - rangeability and turndown, 505
  - resistance temperature device (RTD), 514–515
  - sensitivity/gain, 505
  - specification, 506–507
  - switch inputs, 507–508
  - temperature, 511–512
  - thermistors, 515
  - thermocouples, 512–514
  - toggle switches, 508–509
  - ultrasonic, 511
- transmitters and transducers, 528–531
- sensor transmitters, 528–531
  - smart sensors, 531
  - smart sensors, 531
- Process facility design, 571, 595
- background considerations, 571–572
  - cross-cutting issues, 575–577
  - individual issues, 578–579
  - interacting issues, 577–578
  - key issues, 572–579, 574*t*
  - project phases, 579–595
    - conceptual design, 592
    - construction, 594
    - drawings, 580–585
    - final design, 593–594
    - planning, 585–592
    - preliminary design, 592–593
    - startup, 594–595
- Process flow diagrams (PFDs), 582–583, 582*f*
- Processing plants, example flow chart, 8*f*
- Proteins in fruit and vegetables, 267
- Psychrometrics, 324–325
- Puff dryers, 335
- Pulsation chamber, 179–180
- Pulsed electric field (PEF) processing, 45–46
- ## Q
- Quality evaluation
- fruit and vegetables, 301–303
    - HACCP, 303
    - laboratory facilities, 307
    - traceability, 303
  - grains
    - image analysis, 246–247
    - texture of cooked rice, 247–251
- Quick cooking brown rice (QCBR), 243
- factors
    - cooking, 246
    - preheating, 245
    - soaking, 245
    - process, 242–246
- Quick cooking rice (QCR), 242
- process, 243–245
- Quinic acid, 263–264
- ## R
- RADAR systems, 82
- Radio frequency identification (RFID) systems, 58–59

- Rapid sand filter, 632
- Rayleigh number, 382–383
- Real-Time Kinematic (RTK) GPS, 78
- Refrigeration of dairy products, 200
- Regulation of food industry, 13–14, 38
  - beverages
    - alcoholic, 30
    - bottled water, 31
    - carbonated, 30
    - fruit and vegetable juices, 32
    - milk and milk products, 32–33
    - pasteurization, 33–34
  - canned foods, 34–35
  - Code of Federal Regulations (CFR), 15
  - eggs, 26–27
    - egg products, 27
  - export foods, 35–36
  - FDA sanitation programs, 18–20
  - Federal Register, 14–15
  - Food Safety Modernization Act, 20–22
    - imports, 22
    - inspection and compliance, 21
    - preventive controls, 20–21
    - response, 21
  - food service establishments and restaurants, 35
  - fruit, vegetables and nuts, 29
  - Hazard Analyses and Critical Control Point Program (HACCP), 22–24
    - prerequisite programs, 23–24
  - imported foods, 37–38
  - meat processing, s095
  - sanitation programs, 16–18
    - sanitation performance standards (SPS), 16–17
    - Sanitation Standard Operating Procedures (SSOP), 17–18
  - seafood processing, 27–29
  - state and local regulations, 16
  - United States Code, 15
- Relay ladder logic (RLL), 482, 483*f*
- Restaurants, regulation, 35
- Retort packaging, 239–242
  - boiling, 240–241
  - filling and closing, 241
  - flexible pouches, 239–240
  - retorting, 241–242
  - soaking, 240
  - sterilization, 242
- Returnable plastic containers (RPCs), 701
- Reverse osmosis, 639
- Reynold's number, 382
- Rheology of foods, 403, 425
  - basic concepts
    - constitutive relations, 405–406
    - Deborah number, 407
    - stress and strain, 403–405
  - creep tests, 421–422
  - fluids
    - apparent viscosity and yield stress, 408
    - Bingham plastic fluids, 410
    - correlation with structure, 410
    - Herschel–Bulkley fluids, 410
    - Newtonian fluids, 409
    - power-law fluids, 410
    - shear strain rates in laminar flow, 407–408
  - interfacial dilatational rheology, 423–424
  - interfacial rheology, 422–425
  - interfacial shear rheology, 424–425
  - semi-solid materials, 414–422
    - frequency sweep, 418–420
    - oscillation frequency, 418
    - strain amplitude, 417–418
    - viscoelastic properties, 415–417
  - stress relaxation tests, 421
- Rheometry
  - rotational method, 412–414
    - concentric cylinders, 413
    - cone and plate, 413–414
    - test parameters, 414
  - vane method, 411
- Rice
  - aroma enhancement, 237–239
    - ACPY, 237–238
  - artificial aging, 233–235
    - steam chambers, 235–237
  - equilibrium relative humidity, 127*t*
  - gelatinization enthalpy, 234
  - texture evaluation of cooked rice, 247
    - NIR applications, 249–250
- Ripening of fruit, 269–272
- Rising–falling film evaporators, 346–347
- Rising film evaporators, 345
- Rotary dryers, 331–332
- Row cleaners, 91–92, 93*f*
- Row sensor, 93*f*
- Rupture planes, 145*f*

## S

- Safety engineering. *See* Food safety engineering
- Safety Thermal Limit Recorder (STLR), 206–207
- Sanitary pump
- classification, 600–604
    - centrifugal pumps, 600–602, 601*f*
    - jet and airlift pumps, 602–604, 605*f*, 606*f*
    - positive displacement pumps, 602, 604*f*
  - cleaning and maintenance, 615–616
  - installation, 614–615
  - selection and use, 599
  - standards, 600
  - type selection, 604–613
    - cost, 612–613
    - operational requirements, 610–612
    - process requirements, 606–608
    - product properties, 608–610
    - safety, 613
- Sanitation, 16–18
- programs, 16–18
  - sanitation performance standards (SPS), 16–17
  - Standard Operating Procedures (SSOP), 17–18
- Schulze ring shear tester, 166–169
- Scraped surface freezers, 367
- Screw conveyors, 154–156
- Seafood
- packaging, 697–699
  - processing regulations, 27–29
- Seed/fertilizer placement, row spacing, 94–97
- Seismic loads, 151–153
- Semi-processing of foods for fruit and vegetables, 277
- Sensible heat, 360
- Short tube evaporators, 345
- Sieving (screening) of grain, 164–165
- Single effect evaporators, 348–350
- Single, segmented screw extruders, 432
- Slow sand filter, 632
- Smart packaging, 58
- Snow loads, calculating, 148
- Soil disturbance and environmental impacts, 93–94
- Soil Tillage Intensity Rating (STIR), 93–94
- Solar dryers, 330–331
- Sorbates, 277
- Sorbitol, 263
- Soybeans
- equilibrium relative humidity, 127*t*
  - static coefficient of friction, 142*t*
- Spiral separators for cleaning grain, 165
- Spray-drying, 336–338
- dairy products, 213–214
- Stand-up pouches replacing metal cans, 715
- Starch in fruit and vegetables, 264
- State and local regulations, 16
- Static accuracy, 504
- Stefan diffusion, 329
- Stefan number, 364
- Sterilization and preservation of foods, thermal processing, 441
- aseptic process equipment system, 457–458
  - commercial retort sterilization systems, 441–453
    - batch retorts, 442–444, 444*f*
    - continuous retort systems, 445–453
    - continuous rotary cookers, 446–448
    - crateless retorts, 445–446, 447*f*, 448*f*
    - Flash 18 process, 448–450, 453*f*
    - hydrostatic sterilizers, 448–450, 452*f*, 453*f*
    - Steriflamme system, 453
  - low-acid canned food regulations, 459–466
    - container closure and coding, 465
    - equipment and procedure, 463
    - personnel training, 463
    - plant registration, 460
    - process deviation, 464–465
    - process filing, 461–463
    - process operations, 464
    - product preparation, 463–464
    - recall planning, 465–466
    - records and storage, 465
    - scheduled processes, 464
- Still air freezers, 367
- Stokes' Law, 201–202
- Storage systems. *See* Grain storage systems
- Straw walkers, 112–114
- Stress and strain, 403–405
- shear strain rates in laminar flow, 407–408
- Stress ratio, 136–137
- Stress relaxation tests, 420–421
- Stresses in granular materials, 136–137
- Strip till, 90, 92*f*
- Stripper heads, 107
- Sucrose, 263
- Sugar preservation of foods, fruit and vegetables, 285–286

Sugars in fruit and vegetables, 263

Sulfur dioxide, 276

## T

Tall stubble, 90, 92*f*

Tamper evident packaging, 58

Tannins, 264–265

Temperature cables, 137–138

dimensions and surface materials, 138*t*

Thin layer drying equation, 129–132

Time-temperature integrator (TTI), 58

Total enthalpy, 360

Total equivalent grain height, 139–140, 140*t*

Transducers, 528–531

Transmitters, 528–531

Triangulation Identification for the Genetic

Evaluation of Risks (TIGER), 55

Triaxial tester, 166–169, 168*f*

Tunnel dryers, 333–334

Twin screw extruders, 436–439

## U

Ultra high-pressure processing (UHP), 44

Ultra-high temperature (UHT) sterilization,  
208–209

Ultrasonic flow meters, 526–527

Ultraviolet disinfection, 47–48

United States Code, 15–16

United States Department of Agriculture  
(USDA), 14–15

## V

Vacuum dryers, 332–333

Vacuum flotation, 631

Vacuum production for milking systems, 187–189

gauges, 188–189

regulation, 187–189

Vegetables. *See* Fruit and vegetables

Vehicle guidance systems for farming, 68–75

guidance strategies, 71

fully autonomous guidance, 74–75

manual guidance, 71–72

operator-assisted guidance, 72–73

semi-autonomous guidance, 73–74

summary of benefits and challenges, 72*t*

Vertical frictional load on a temperature cable, 137

Viscoelastic properties, 415–417

Viscosity. *See* Rheology of foods

Vitamins in fruit and vegetables, 267–268

Vortex shedding flow meter, 525

## W

Walker ring shear tester, 166–169

Wastewater characteristics, 619

Water

bottled, processing regulations, 31

food stability and moisture content, 321–323

fraction of frozen water for foods, 358–359

moisture isotherms, 322

role in foods, 317–319

types in foods, 319–321. *See also* Drying of  
foods

Wheat

equilibrium relative humidity, 127*t*

static coefficient of friction, 142*t*

Wheat stubble with corn stalks, 90, 91*f*

Wide Area Augmentation System (WAAS),  
77–78

Winchester Bushel Test, 125

Wind loading, calculating, 148–151

force coefficients for round grain bins, 150*t*

pressure coefficients for components and  
cladding, 150*t*

pressure coefficients for conical bin roofs, 151*t*

## X

Xanthophylls, 266